

Power over Ethernet (PoE) Devices Installation & Operation Manual

H005042_R06 06.2022

Setting the Standard
in Synchronized Time.



american time®

Safety Precautions

All electrical power wiring connected to the Power over Ethernet Clocks and Devices must be installed by qualified persons in conformance with applicable national and local electrical codes. Improper installation of this equipment can result in electrical shock and fire.

The PoE clock/device should be installed in a secure location protected from:

- Physical damage
- Water, including condensation

Operation of this product in a manner inconsistent with the instructions in the manual may result in personal injury and damage to the product and will void the warranty.

American Time

140 3rd Street South, PO Box 707
Dassel, MN 55325-0707

Phone: **800-328-8996**

Fax: **800-789-1882**

american-time.com



Table of Contents

Introduction	4
Specifications	5-7
Analog Clocks	5
Digital Clocks.....	6
Digital Clock Relay	7
Installation	8-12
Standalone Relay	8
Analog Clocks	9
Digital Clocks	10-12
Activation on inCloud	13
Network Clock Connect	14-23
System Requirements	14
Installation	14
Login.....	14
Main Screen	15-16
Configuration.....	17-23
Clock Tab	17
Time Zone Tab	18
DST Tab.....	18
Network Tab	19
Buzzer Tab	20
Manuf Tab	20
Schedule Editor	21-22
Event Editor	22-23
Troubleshooting: DHCP	24-25
Troubleshooting: Clock Time	26
Appendix A: NIST Time Servers	27
Appendix B: Supported Time Zones	27
Appendix C: Buzzer/Relay Scheduling Examples	28-29
Appendix D: Brightness Control Scheduling Example	30-31
Appendix E: Timer Control Station Operation	13



Introduction

Power over Ethernet (PoE) provides an accurate synchronized time source. PoE and Simple Network Time Protocol (SNTP) are used to make installation and setup as simple as possible. All you need to do is connect the clock or device to a PoE enabled Local Area Network (LAN) Ethernet drop.

PoE

Power over Ethernet (PoE) describes a system that passes electrical power, along with data, through Ethernet cabling. Power may come from a power supply within a networking device such as a PoE switch or it may be injected into the Ethernet cable using a midspan injector.

There are several advantages for using PoE. PoE eliminates the need to run AC power cables for certain devices. Instead, the more cost effective category 5 or 6 cable is run for PoE devices. Also, since PoE is symmetrically distributed, the power source may be determined after the cables are ran.

PoE clocks require connection to a PoE enabled LAN. In a typical installation, a PoE switch or a PoE injector would be used to power your PoE clock.

Network

These PoE Devices are plug and play on networks with Dynamic Hosting Configuration Protocol (DHCP). A NIST time server is used for the default time server but may be changed using the Network Clock Connect application or the configuration web page.

The clocks may also be configured using static IP addresses.

inCloud Management Portal

PoE devices are configured for use with American Time's inCloud Management Portal. With the inCloud management portal you can set up, monitor and manage your American Time devices easily and from anywhere. inCloud is a cloud-based management interface, featuring a status dashboard for monitoring your devices, configuration profiles to ensure devices are utilizing the same settings, and network/connectivity information.

The designated site manager for your location should have received a welcome e-mail with a link to inCloud and initial log-in information after placing the order for your devices. Logging in to inCloud will be required to complete setup of the devices; ensure that your site manager is available during the configuration and installation process.

To log in to inCloud, visit incloud.american-time.com and log in using the credentials provided in your American Time welcome e-mail.

NOTE: For non-inCloud customers, clocks can still be configured using the Network Clock Connect application described in this manual.

Certifications (Clocks Only)

- Electromagnetic Emissions

EN 55032:2012/AC:2013 Class B

FCC 15.107:2018 Class B

FCC 15.109:2018 Class B

ICES-003:2016 Class B

- Electromagnetic Immunity

EN 55024:2010

- Safety

CB



Specifications

Network Port Requirements

- 9 - firmware updates
- 53 - DNS for time servers
- 67-69 - firmware updates
- 80 - HTTP for web server
- 123 - NTP for time sync
- 443 - HTTPS for inCloud communication
- 8162-8163 - Network Clock Connect communication

Power over Ethernet Analog Clocks

Available in the following configurations:

PEXXXXXXXXXB – Buzzer version

PEXXXXXXXX – Analog Version

Note: The X's are model dependent

Optional Products:

PoE Injector, single port – TMA200

USB Drive with Network Clock Connect Software – H004167B-POE

Security Bracket for analog clocks (part number varies by size)

Features:

- Time Zone Management
- Supports up to 10 SNTP servers for redundancy
- Supports Daylight Saving Time
- Power over Ethernet (IEEE802.3af)
- DHCP or Static IP addressing
- Network Clock Connect configuration
- Status LED indicator
- Scheduling (Buzzer version) - maximum of 100 scheduled events

Dimensions: Varies by model

Power Consumption: PoE, IEEE802.3af compliant, 1W

Operating Temperature: 32°F to 104°F (0° to 40°C)

Operating Humidity: 95% maximum, non-condensing

Accuracy: ±1 second

Buzzer Option Specifications:

Sound Level: 65dBA at 10 feet



Specifications

Power over Ethernet Digital/Calendar Clocks

Available in the following configurations:

PGEXXXXXE- Base version

PGEXXXXXEB - Base w/Buzzer

PGEXMXXE - Base w/Calendar

PGEXMXXEB - Base w/Calendar & Buzzer

Note: The X's are model dependent

Optional Products:

PoE Injector, single port – **TMA200**

USB Drive with Network Clock Connect Software – **H004167B-POE**

Timer Control Station – **ATSTCS**

Double Dials – (Ceiling or Wall)

Features:

- Time Zone Management
- Supports up to 10 SNTP servers for redundancy
- Supports Daylight Saving Time
- 12/24 Hour Mode with PM indicator
- Power over Ethernet (IEEE802.3af)
- DHCP or Static IP addressing
- Network Clock Connect configuration
- Programmable Brightness Controls (High, Low, Sleep, Off)
- Elapsed Time Indication (ETI) with Code Blue
- Countdown Timer
- Scheduling (Buzzer/Relay) - maximum of 100 scheduled events
- Calendar Clock Display Modes:

MM:DD:YY	DD:MM:YY	YY:MM:DD	M:D:YY	D:M:YY	YY:M:D
----------	----------	----------	--------	--------	--------

- Configurable date/time toggle durations

Specifications:

Dimensions:

Digital Clocks: 2.5" display: 4 & 6 digit - 12.250" x 5.1875" x 2.5"d

4" display: 4 digit - 12.250" x 6.8750" x 2.5"d

4" display: 6 digit - 17.250" x 6.8750" x 2.5"d

ATSTCS: Timer Control Station: 4.63"h X 4.56"w X 1.25"deep

Weight: Digital Clock: Varies by model

ATSTCS Timer Control Station: 0.27 lb.

Power Consumption: PoE, IEEE 802.3af compliant

Size	Digits	Color	Power average	Power Max
2.5"	4	Green	5.0W	6.0W
		Red	5.5W	7.0W
	6	Green	6.0W	7.0W
		Red	6.5W	8.0W

Size	Digits	Color	Power average	Power Max
4"	4	Green	5.0W	6.0W
		Red	5.5W	7.0W
	6	Green	6.0W	7.0W
		Red	6.5W	8.0W



Specifications

Distance of ATSTCS from Digital Clock/Timer: 30-ft maximum with 22 AWG stranded wire with minimum 1/32" thick insulation

Code Blue Circuits: 3.0mA. max. @ 12vac/vdc-30vac/vdc

Operating Temperature: 32°F to 104°F (0° to 40°C)

Operating Humidity: 95% maximum, non-condensing

OPERATION

Modes Available: 12 hour or 24-hour synchronized. Incrementing timer with programmable preset value and start/stop capability. Decrementing timer with programmable preset value and start/stop capability. Code Blue incrementing timer

Accuracy: ±1 second

Indications: ATSTCS Control Station: 2 second audible alarm

Buzzer Option Specifications:

Sound Level: 65dBA at 10 feet

Digital Clock Relay Option Specifications:

Dry contact closure

Wiring for the internal relay closure:

Maximum Voltage: 60vdc, 125vac

Maximum Switched Current: 1A

Maximum Carrying Current: 1A

Relay Connection Diagram

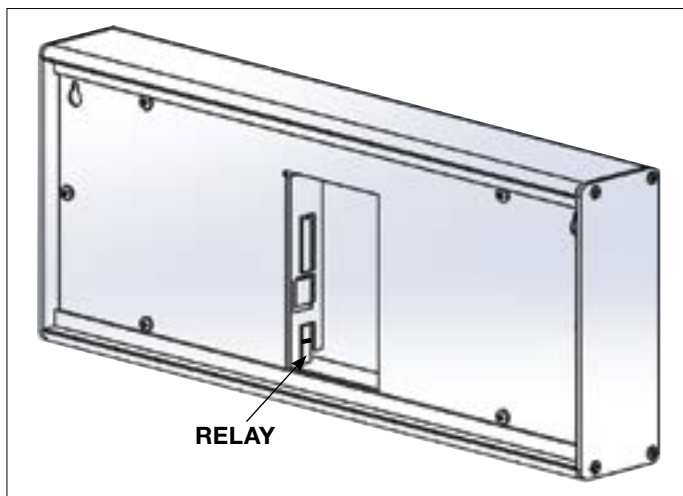
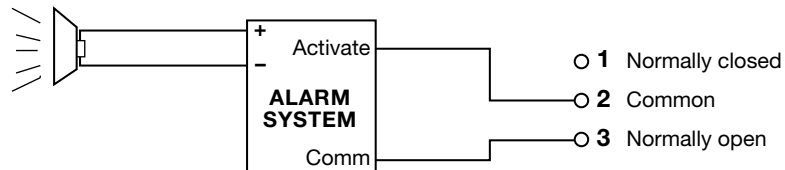

Connector Relay



PoE Standalone Relay Information

The PoE Standalone Relay is a scheduleable relay device which can be used to trigger low-power devices such as bells, strobes, and horns, or as a controller for a higher-powered relay to control larger devices.

The Standalone Relay can be controlled and scheduled using either the inCloud Management Portal or the Network Clock Connect Application.

Before installing, verify the network infrastructure with the Network Administrator. The Power over Ethernet (PoE) power solution and Dynamic Host Configuration Protocol (DHCP) settings should be determined. The PoE device locations and cabling routes should also be determined prior to installation.

1. Mount the relay in the desired location, using the mounting hole flanges on the sides of the relay.
2. inCloud users should activate their devices on the Management Portal at this time. Reference step 6 in the relay quick start guide for instructions on inCloud activation.
3. Apply power to the relay by connecting a CAT 5 or higher Ethernet patch cable from a PoE switch or single injector to the PoE jack on the relay.
 - PoE Switch: Check with the Network Administrator for infrastructure needs. This part is not supplied by American Time.
 - PoE Injector (TMA200): This is an optional power source that may be purchased from American Time.
4. The Status LED will indicate the clocks status as follows:
 - **Flashing Red:** Attempting to acquire an IP address using DHCP
 - **Continuous Red:** IP address successfully acquired
 - **Flashing Orange:** Attempting SNTP sync
 - **Continuous Orange:** SNTP sync failed
 - **Flashing Green:** Communicating with inCloud management portal
 - **Continuous Green:** Successful SNTP sync

To operate the relay, inCloud users should reference the inCloud Scheduler User Guide. Non-inCloud users can schedule relay function using Network Clock Connect; see the Network Clock Connect section in this manual for detailed information.



Analog Clock Installation

Before installing, verify the network infrastructure with the Network Administrator. The Power over Ethernet (PoE) power solution and Dynamic Host Configuration Protocol (DHCP) settings should be determined. The PoE clock locations and cabling routes should also be determined prior to installation.

1. Apply power to the clock by connecting a CAT 5 (A) or higher Ethernet patch cable from a PoE switch (Fig. 1) or single injector (Fig. 2) to the PoE receiver (F).
 - PoE Switch: Check with the Network Administrator for infrastructure needs. This part is not supplied by American Time.
 - PoE Injector (TMA200): This is an optional power source that may be purchased from American Time
2. The Status LED (B) will indicate the clocks status as follows:
 - **Flashing Red:** Attempting to acquire an IP address using DHCP
 - **Continuous Red:** IP address successfully acquired
 - **Flashing Orange:** Attempting SNTP sync
 - **Continuous Orange:** SNTP sync failed
 - **Flashing Green:** Communicating with inCloud management portal
 - **Continuous Green:** Successful SNTP sync

Note: When a DHCP network is not present at initial start-up, the PoE clock will default to a random Static IP in the range of 169.254.1.0 to 169.254.254.255. The IP address may be reset by restoring the clock factory defaults by holding in the Reset Button (D) for 10 seconds and releasing. Both Status and Buzzer LEDs will flash for 5 seconds to confirm the defaults setting. Please reference the DHCP troubleshooting section if you are experiencing DHCP issues.

3. The Buzzer LED (C) designates if the Buzzer is enabled. The Buzzer is an optional feature.
4. Place the clock on the wall using the keyhole hanger (E) on the back of the clock or the optional security bracket.

Note: If hanging your clock over an Ethernet jack, see Figure 3.

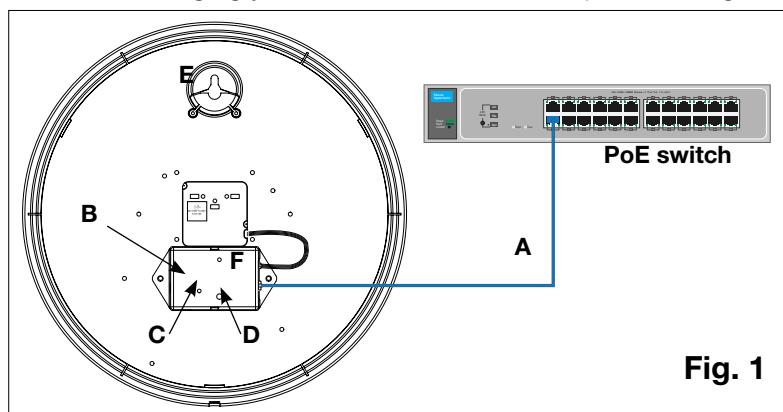

Fig. 1

A=PoE connection (CAT 5 or higher Ethernet patch cable) B=Status LED
C=Buzzer LED D=Reset Button E=Keyhole Hanger F=PoE Receiver

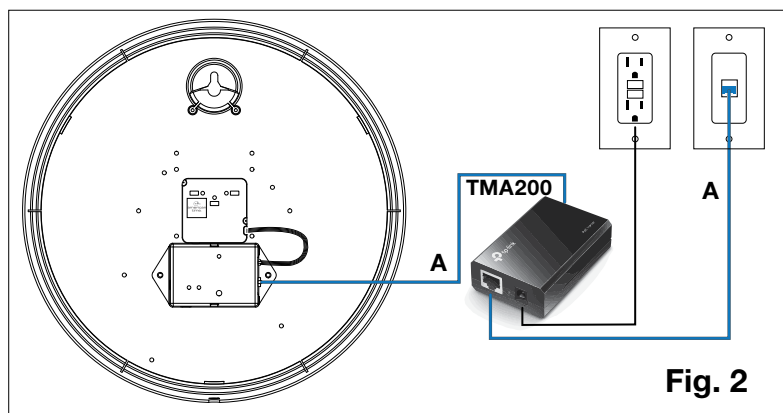

Fig. 2

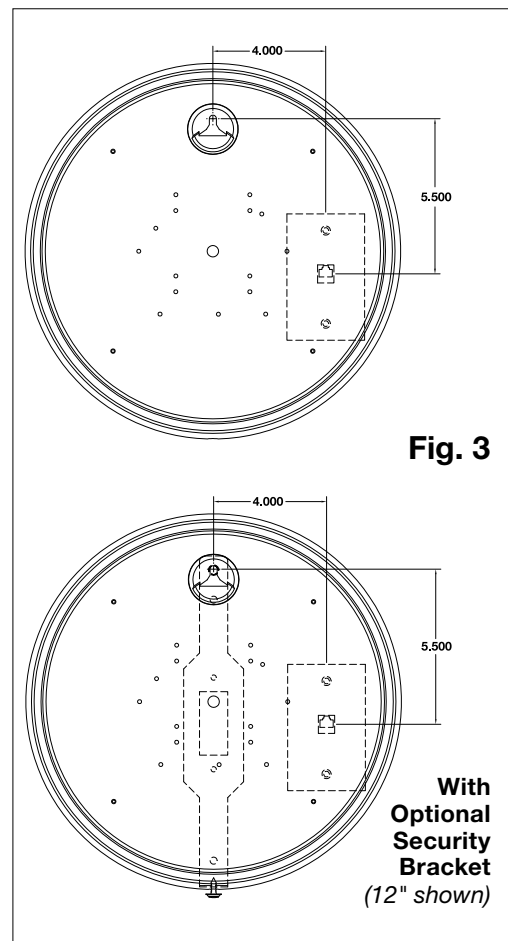

Fig. 3

With
Optional
Security
Bracket
(12" shown)

Digital Clock Installation

Before installing, verify the network infrastructure with the Network Administrator. The Power over Ethernet (PoE) power solution and Dynamic Host Configuration Protocol (DHCP) settings should be determined. The PoE clock locations and cabling routes should also be determined prior to installation.

1. Apply power to the clock by connecting a CAT 5 (A) or higher Ethernet patch cable from a PoE switch (Fig. 1) or single injector (Fig. 2) to the rear panel of the PoE clock. The time should display in less than one minute.
 - PoE Switch: Check with the Network Administrator for infrastructure needs. This part is not supplied by American Time.
 - PoE Injector (TMA200): This is an optional power source that may be purchased from American Time
2. Upon startup the clock will scroll the FW version followed by a brief digit check where all segments are illuminated and then flashing colons and dashes while obtaining an IP address and SNTP time.

Note: When a DHCP network is not present at initial start-up, the PoE clock will default to a random Static IP in the range of: 169.254.1.0 to 169.254.254.255 and display " ".

If there is a network or time server issue on a cold start the Clock will continuously flash colons and dashes.

Note: The IP address set to the clock can be checked by momentarily disconnecting the ethernet cable. Once reconnected, the clock IP address will scroll quickly across the display.
3. Place the clock on the wall using the keyhole hanger (C) on the back of the clock. A mounting template is included with the Quick Start Installation Guide.

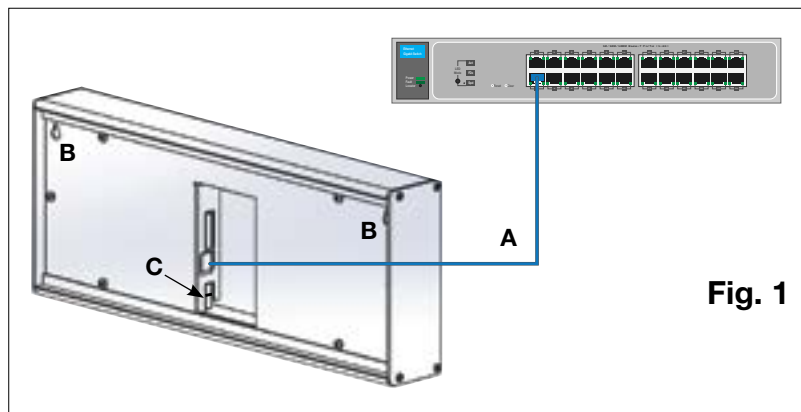

A=PoE connection (CAT 5 or higher Ethernet patch cable)

B=Keyhole hanger C=Relay

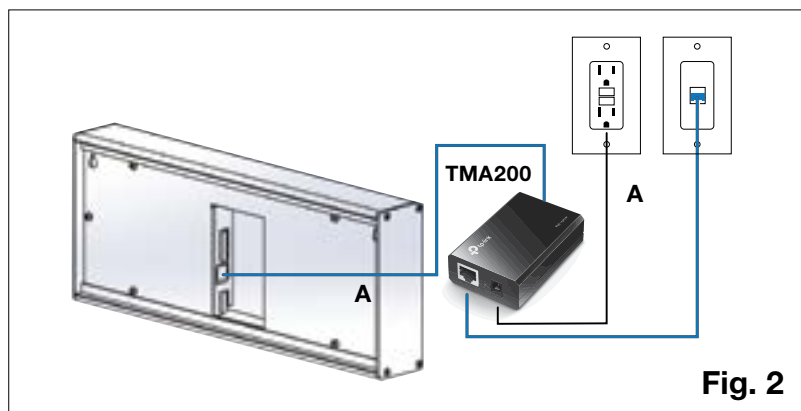

Fig. 2



Digital Clock Installation

Digital Single Display Surface Mounting

CAUTION: RISK OF ELECTRICAL SHOCK - Disconnect and lock out power to the electrical box before installing or servicing the clock.

1. Use mounting template shown at the bottom of the **Quick Start Installation Guide** to place mounting screws in the wall.
2. Run CAT 5 or higher Ethernet patch cable from the PoE switch or PoE injector to the clock enclosure.
3. Connect the patch cable to the clock. Route field wiring away from sharp projections, corners and internal components.
4. Hang clock on mounting screws.
5. Confirm correct operation of the clock.

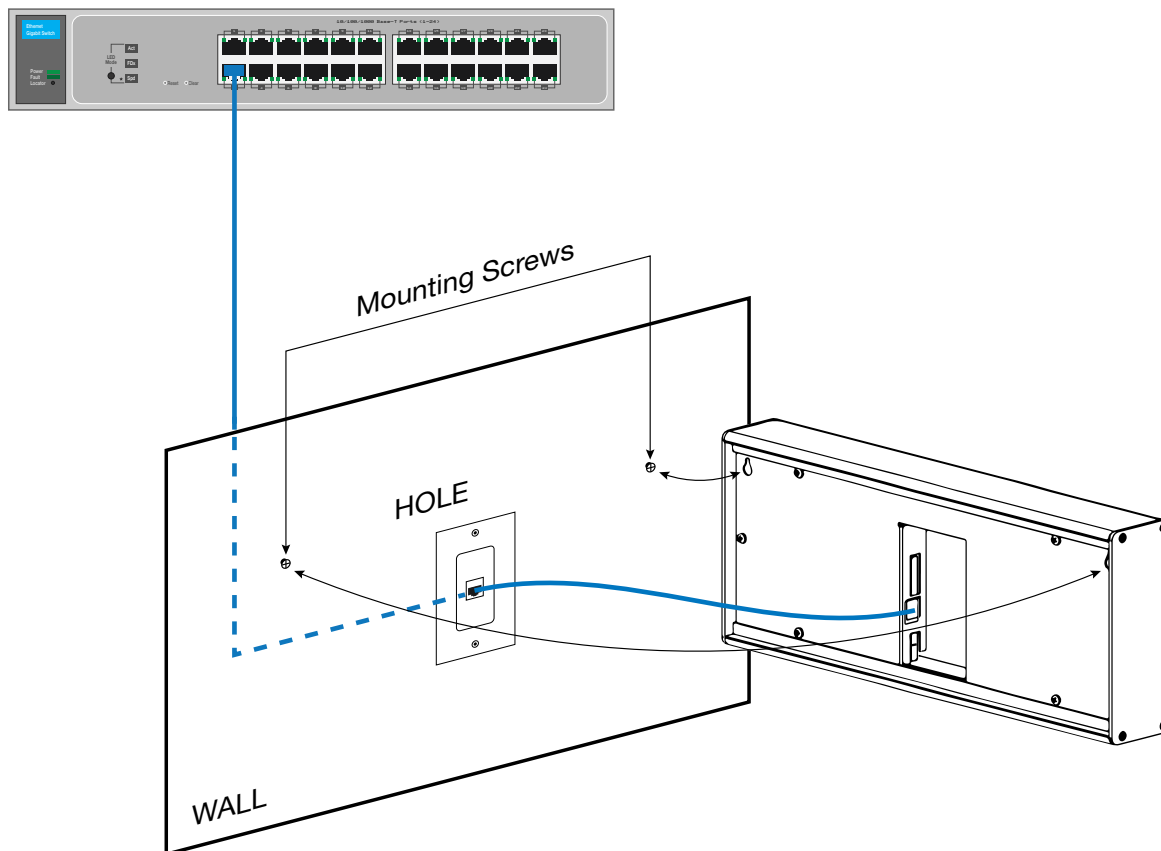

Digital Clock Installation

Digital Double Display Mounting

CAUTION: RISK OF ELECTRICAL SHOCK - Disconnect and lock out power to the electrical box before installing or servicing the clock.

Wall Mount

1. Make patch cable connection to the digital clock.
2. Using #8-32 x 3/4" screws, hang double dial enclosure assembly according to one of the following:
 - 4 square junction box – install lower screw into back box, hang clock by keyhole, install upper screw
 - Single gang box – install lower screw into back box, hang clock by keyhole, install upper screw
 - Double gang box – Install two lower screws into back box, hang clock by keyhole, install upper screws

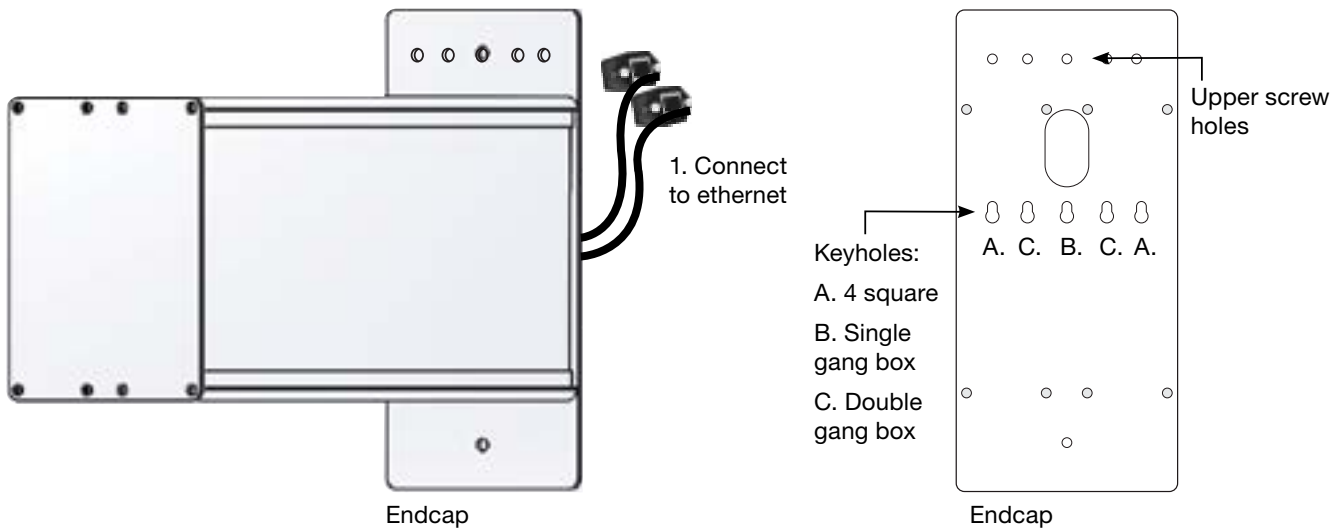

Ceiling Mount

1. Make patch cable connection to the digital clock.
2. Using two #8-32 x 3/4" screws, hang double dial enclosure assembly using holes onto 4" square back box.

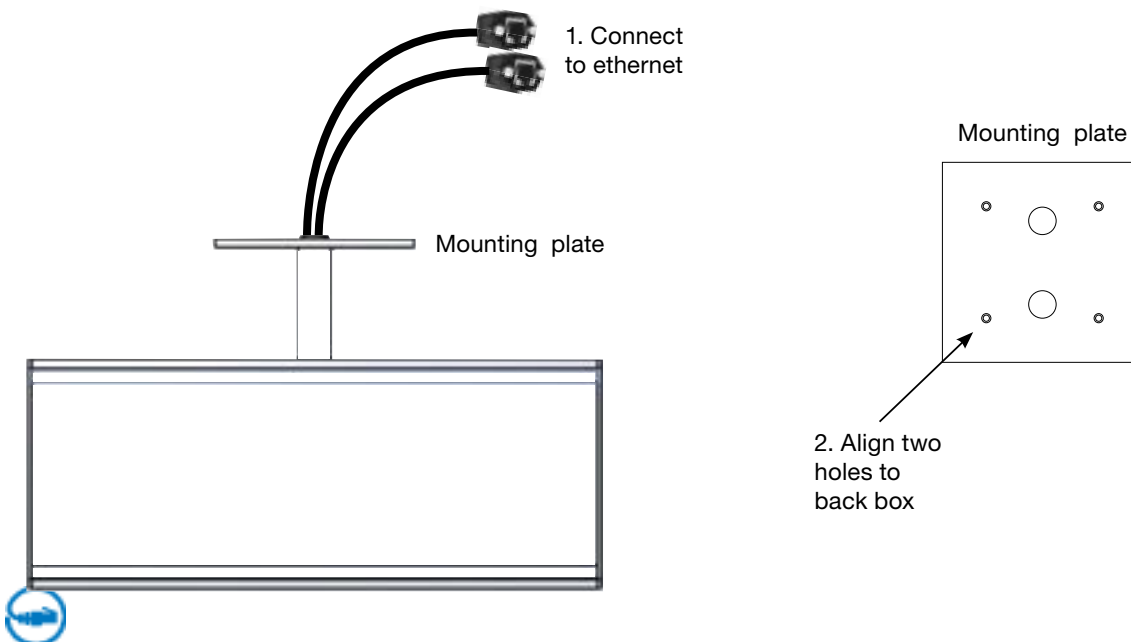

Activation on inCloud

If you are an inCloud subscriber, you can activate your devices on inCloud by logging in, using the credentials provided in your inCloud welcome email.

This can be done in one of two ways:

1. Log in through the Network Clock Setup App (Android) and click on ACTIVATE ON INCLOUD.
2. Activate on inCloud through a web browser.
 - a. Navigate to the inCloud portal: incloud.american-time.com. Use the credentials provided in your inCloud welcome email from American Time.
 - b. Click on the green "Setup New" button in the PoE Devices bar on the Device List page. This will open up the Setup Network Device List, which will list all the devices assigned to your site.



- c. Click on the desired clock's MAC address and provide a name and (if desired) description for the clock. Ideally the name will identify the clock's location or otherwise make the clock easy to identify for management purposes. Repeat this for each clock in the list.
 - The MAC address can be searched using the last five characters of the address including the colon (for example, AA:11) in the search bar.
 - Once a clock is named on inCloud, it will appear as "partially configured" in the inCloud device list. After a clock has been named, it can be mounted and given power.

Repeat these steps until all clocks have been set up.



Network Clock Connect

Network Clock Connect has been developed by American Time for configuring and monitoring your network clocks. This application will allow the user to quickly manage all of the compatible network clocks installed on the network.

NOTE: Network Clock Connect must be used to manage buzzer schedules. inCloud does not support buzzer management.

System Requirements

Personal Computers:

Windows 7 - 32-bit Windows 8

Windows 7 - 64-bit Windows 10

PC with 500Mhz or higher processor clock speed recommended

50MB free storage

256MB or RAM or higher recommended

VGA (800x600) or higher-resolution video adapter and monitor

Keyboard and Mouse

Installation

1. *Network Clock Connect* may be downloaded from, <http://www.american-time.com/support/product-documentation>. Select **FIRMWARE** and click **Search** then click on **Network Clock Connect** from the search results. The software will automatically download. It is also provided through the optional USB drive (H004167B-POE sold separately).

Note: For NEW Global Series PoE digital clocks, make sure Network Clock Connect version is 0.5.0.0 or newer

2. Run the Windows Installer Package, NCCSetup.msi, file by double-clicking the icon:

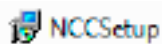

3. Follow the instructions in the Network Clock Connect Setup Wizard.

Login

1. Double-click on the **Network Clock Connect** desktop icon to start the application.



2. Enter **clock4u** in the password prompt and press **OK**.



Network Clock Connect

This screen allows access to all of the network clocks. The use of a broadcast IP is used to find all of the active network clocks. Once the list of network clocks is populated, all the clocks or individual clocks may be selected for configuration.



1. *Broadcast IP* – This is the address used to query all network clocks. The default is set to 255.255.255.255. This may be set to the subnet that the network clock(s) are configured to reduce network traffic.
2. *Refresh List* – This button is used to populate the list of network clocks using the Broadcast IP entered.
3. *Group Checkboxes* – These checkboxes are used to select the group(s) of clocks that should be displayed in the list. Pressing Refresh List, after selecting the desired groups, will display the clocks assigned to the selected groups.
4. *Select Column* – This displays checkboxes to select each clock. CTRL+A will select all clocks. The Edit menu also has a Select All and Deselect All feature.
5. *IP Address Column* – This displays the IP address of each clock.
6. *Clock ID Column* – This is used to assign a clock ID to each clock. The text field allows up to 20 alphanumeric characters.
7. *Group Column*– This is used to define the group of the clock. The network clocks may be grouped for sorting purposes. The groups may be named under Tools à Rename Groups.
8. *MAC Column* – This displays the MAC address of each clock.
9. *Date Column* – This displays the current date of the clock.
10. *Time Column* – This displays the current time of the clock.
11. *Last Sync Success Column* – This displays the last time the clock received a successful SNTP synchronization. The field will turn green to designate a successful sync and red for a failed sync.
12. *Schedule Button Column* – This button will be displayed if the network clock has the optional buzzer/relay. If the clock does not have a buzzer/relay, the field will display N/A. Reference the Schedule Editor section for more details on the buzzer/relay scheduling.
13. *Schedule Timestamp Column* – This displays the last time the schedule was altered and saved. The field will turn green to designate a successful schedule update and red for a failed schedule update.
14. *Selected* – This displays the number of clocks that are selected.
15. *Active* – This displays the number of clocks that are active. An active clock is one that is connected to the network.



Network Clock Connect

16. *Total* – This displays the total number of clocks in the list.
17. *Import List Button* – This button is used to import a list of clocks.
18. *Export List Button* – This button is used to export a list of clocks. This button cannot be pressed if no clocks are selected.
 - This is useful for saving the network clock list for future reference to identify clocks that may become nonresponsive.
19. *SNTP Sync Button* – This button is used to synchronize the selected clocks to the configured SNTP server. The selected clocks Last Sync Success fields will change red when this button is pressed. Once the clocks obtain the SNTP sync, the Last Sync Success field will update to green with the correct date and time.
20. *Configure Button* – This is used to enter the Configuration Menu for the selected clocks. Reference the Configuration section for more details.
21. *Print List Button* – This button is used to print the list of clocks.
22. *Help Menu* – This menu contains a shortcut to the American Time PoE clock support site. Manuals, firmware/software updates, and tutorials are contained on the support site.



Configuration – Network Clock Connect

This is the configuration screen for network clocks. The time zone, daylight saving, and network settings may be configured here.

Note: If multiple clocks are selected, some configuration settings may not be editable.

Note for inCloud users: Settings changes should be performed on inCloud and issued using the "Save and Send" command. Settings changed in Network Clock Connect will not be reflected on inCloud. inCloud will highlight settings where there is a discrepancy between the settings on inCloud and the clock's own settings.

1. Clock Tab

- a. *Firmware Version* – This displays the firmware version of the selected clock. The firmware version will not be displayed if multiple clocks are selected.
- b. *Hardware Version* – This displays the hardware version of the selected clock. The hardware version will not be displayed if multiple clocks are selected.
- c. *Update Button* – This button is used to update the firmware on the clock(s). The latest firmware will be available on the Support Site.
- d. *MAC Address* – This displays the MAC address of the selected clock. The MAC address will not be displayed if multiple clocks are selected.
- e. *Clock Type* – This displays the clock type of the selected clock. The clock type will not be displayed if multiple clocks are selected.
- f. *Clock ID* – This field is used to set the clock ID of the selected clock. This field allows up to 20 alphanumeric characters to be entered. This field will not be editable if multiple clocks are selected.
- g. *Password* – This field is used to set the password of the selected clock(s).
- h. *Group* – This is used to define the group of the clock. The network clocks may be grouped for sorting purposes. If multiple clocks are selected, the group will not be displayed. However, this field can change the group of multiple selected clocks.
- i. *Time Zone* – This displays the time zone of the selected clock. The time zone will not be displayed if multiple clocks are selected.
- j. *Daylight Saving Time* – This displays the Daylight Saving Time setting of the selected clock. The Daylight Saving Time setting will not be displayed if multiple clocks are selected.
- k. *Last Time Receive* – This displays the last time a SNTP request was received by the selected clock. The last time received will not be displayed if multiple clocks are selected.
- l. *Last Login* – This displays the last time a user logged into the selected clock. The last login will not be displayed if multiple clocks are selected.
- m. *Brightness* – This is used to select the brightness setting on the clock display. There are four options for display brightness - High, Low, Sleep and Off. When in the Sleep setting, the segments of the display will be off. Every 10 seconds the time segments will display the time for 1 second in a Low brightness and turn off again. **Note:** The Brightness setting is only present for Digital clocks.
- n. *12/24 Hour Mode* – This is used to select a 12 or 24 hour display for the clock. **Note:** 12/24 Hour Mode is only present for Digital Clocks.
- o. *Date Mode* – This is used to select the date mode of the Digital Calendar Clock.
- p. *Display Duration* – This is used to set the duration of the time/date displays for a Digital Calendar Clock. If both time and date are set to "0", only the time will be displayed. If time is set to "0" and date is set to anything other than "0", only the date will be displayed. If neither time nor date are "0", the time and date will toggle for the duration specified.



Configuration – Network Clock Connect

2. Time Zone Tab

- q. *Time Zone* – This is used to select the time zone. Selecting the CUSTOM time zone will enable the Custom Time Zone fields. Reference Appendix B for a list of all available time zone configurations.
- r. *Custom Time Zone* – This is used to select a custom time zone with a bias of hours and minutes from UTC time. The CUSTOM selection must be made in the Time Zone field for this to be enabled. The bias may be configured in the range of 0:00 – 23:59, positive or negative.
- s. *Facility Time Offset* – This is used to offset the received SNTP time with a positive or negative bias of hours and minutes. The Offset Facility Time checkbox must be checked for this field to be editable. **Note:** This function is typically used by school districts to accommodate bus schedules.
- t. *Offset Facility Time* – This checkbox enables the Facility Time Offset.



3. DST Tab

- u. *Daylight Saving Time* – This is used to set the DST to AUTO, OFF, or CUSTOM. The AUTO selection is the standard DST for the United States.
Note: Not all time zone selections will allow for changing the DST to AUTO or OFF. For example, if USCT – USA, Central is selected for the time zone, the DST cannot be set to OFF. In this example DST=OFF can be done by selecting UTC-6 for the time zone and selecting the DST to OFF. Reference Appendix B for a list of all available DST configurations.
- v. *Custom Daylight Savings* – This is used to select a custom DST date and time. The Daylight Saving Time must be set to CUSTOM for these fields to be editable.

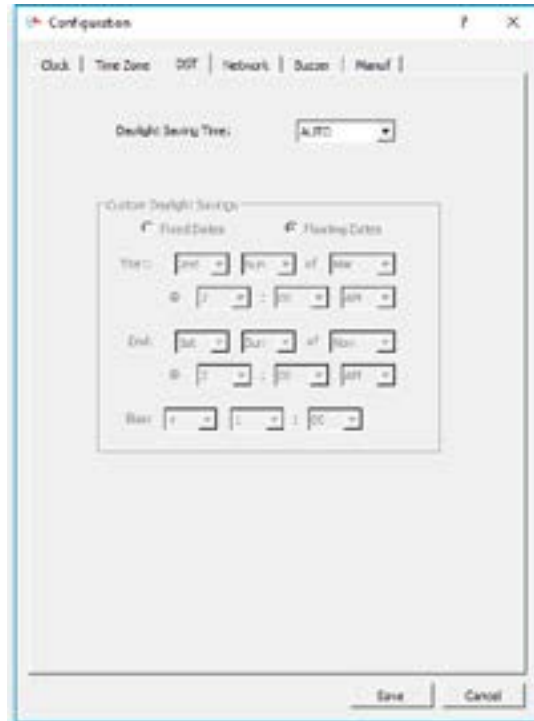

Configuration – Network Clock Connect

4. Network Tab

- w. **DHCP** – This checkbox enables Dynamic Host Configuration Protocol (DHCP) on the selected network clocks.
- x. **IP Address** – The IP address may be set to a static IP address if one clock is selected. The DHCP checkbox must be unchecked for this field to be enabled. The IP address fields cannot be changed if multiple clocks are selected.
- y. **Subnet Mask** – The Subnet mask may be configured if the DHCP checkbox is unchecked.
- z. **Gateway** – The Gateway may be configured if the DHCP checkbox is unchecked.
- aa. **DNS Servers** – The DNS servers may be configured if the DHCP checkbox is unchecked.
- ab. **SNTP Servers** – This is a list of SNTP servers from which the network clock will receive time. The selected server will be attempted first. If the server fails to provide a valid time the list is traversed until a valid time is received. This list may be user defined. A list of verified NIST time servers is available in Appendix A.

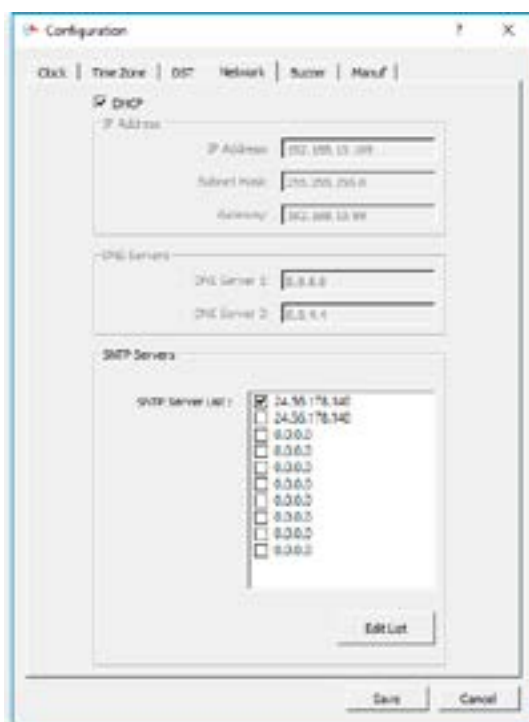

DHCP Option 42 Support for NTP Servers

PoE clocks support DHCP option 42, which provides NTP server support through DHCP servers. If option 42 is enabled on the DHCP server, the clock will automatically receive IP addresses for up to two NTP servers directly from the DHCP server.

The IP addresses received through option 42 support will replace the first two NTP IP addresses in the NTP list in Network Clock Connect. If option 42 is not enabled, the NTP list will display the 10 normal default server IPs. For inCloud users, the option 42 IPs will also populate the Option 42 SNTP fields on the Edit Device screen for each clock, as well as the first two SNTP Server fields in the PoE Config.



Configuration – Network Clock Connect

5. Buzzer Tab

- ac. Activate Buzzer/Relay Button – This button will activate the relay or buzzer on all selected network relays or clocks that have the buzzer/relay option.



6. Manuf Tab

- ad. This tab is used for manufacturing purposes only.

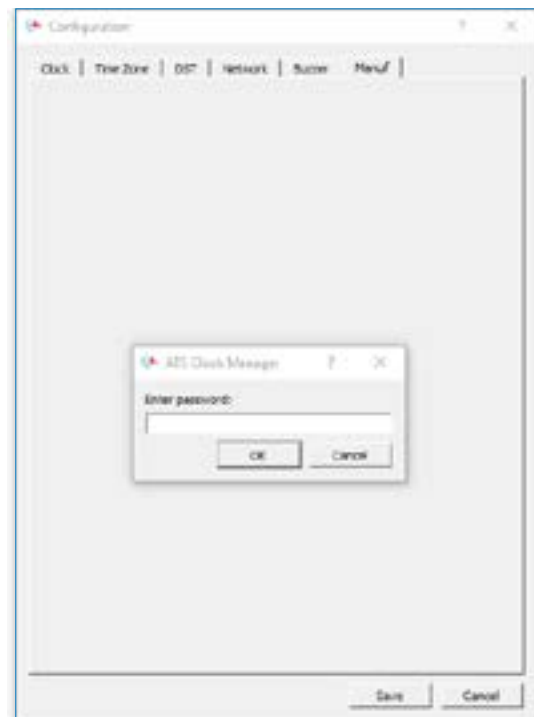

Configuration – Network Clock Connect

Schedule Editor

Note: This feature is only available for analog clocks with the buzzer option, digital clocks or relay. If the option is not enabled the button will display N/A.

The Schedule Editor may be entered by pressing the schedule button from the main Network Clock Connect screen. This is used to add and edit events in a schedule. Multiple devices may be scheduled at once by selecting them in the Select Column in the Network Clock Connect screen. The maximum number of scheduled events is 100. Reference Appendix C for scheduling examples.

Event #	Start Date/Time	End Date/Time	Period	Device	Duration	Countdown	Next Occurrence	Brightness
1	4/27/2017 5:30:00 AM	NONE	Mon Tue Wed Th Fri	NONE	OFF	OFF	5/14/2017 5:30:00 AM	High
2	4/27/2017 5:30:00 PM	NONE	Mon Tue Wed Th Fri	NONE	OFF	OFF	5/14/2017 5:30:00 PM	Low
3	4/27/2017 5:30:00 PM	NONE	Fri	NONE	OFF	OFF	5/15/2017 5:30:00 PM	High

1. *Schedule* – This is the file name of the schedule and the date and time it was last modified. This field is editable so that the schedule may be named appropriately (i.e. 2HourLateStart.ats, PepFest.ats, etc.).
2. *Current Date/Time* – This displays the current date and time of the selected network clock.
3. *Event # Column* – This displays the event number.
4. *Start Date/Time Column* – This displays the start date and time of the event.
5. *End Date/Time Column* – This displays the end date and time of the event. There may not be an end date if the event is a reoccurring event.
6. *Period Column* – This displays the period of the event. The period is how often the event occurs. Therefore a period of one week correlates to an event that happens weekly.
7. *Device Column* – This displays the device(s) that will be triggered during the event. If all outputs are to be triggered for a specified event this field will display: B/R. This correlates to Buzzer/Relay (available on analog clocks only).
8. *Duration Column* – This displays the event duration. The duration may be selected from this field (ON, OFF, 0–59 seconds). The event duration must be less than the period.
9. *Countdown Column* – This displays the duration of the countdown timer.
Note: Countdown column only available for digital clocks.
10. *Next Occurrence Column* – This displays the date and time of the next occurrence of the event.
11. *Brightness Column* – This displays the brightness of the time display on the clock triggered by the event.
12. *Import Button* – This button is used to import an existing schedule.
13. *Export Button* – This button is used to export the current schedule on the network clock.
14. *Add Button* – This button is used to add an event to the schedule. The Event Editor will appear when this button is pressed. Reference the Event Editor section for more details.
15. *Edit Button* – This button is used to edit a selected event with the Event Editor. An event is selected by highlighting the event row by clicking on the event. Double-clicking on the event row will also prompt the Event Editor.
16. *Delete Button* – This button is used to delete a selected event from the schedule. A confirmation dialog will appear prior to deleting the event.
17. *Delete All Button* – This button is used to delete all events from the schedule. A confirmation dialog will appear prior to deleting the events.



Configuration – Network Clock Connect

Schedule Editor (cont.)

18. Print Button – This button is used to print the entire schedule. All events will be printed as they appear in the schedule list.
19. Save Button – This button is used to Save the current schedule. The schedule name and last modified date will be updated. If multiple clocks were selected in the Network Clock Connect screen, the Other Clocks Selected prompt will appear. This allows all of the selected clocks to be updated with the same schedule.



20. Cancel Button – This button is used to cancel any changes made to the schedule.

Event Editor

The Event Editor may be entered by adding a new event or editing an existing event in the Schedule Editor. Here the event is defined with a start date/time, end date/time (optional), period, duration, and device selection. Reference Appendix C for event entry examples. The maximum number of scheduled events is 100.

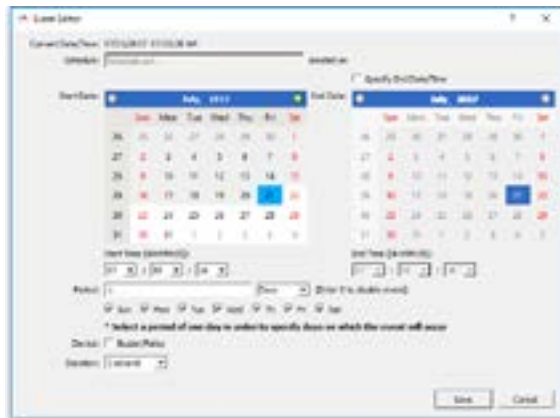

Relay/Analog Clock Buzzer Event Editor

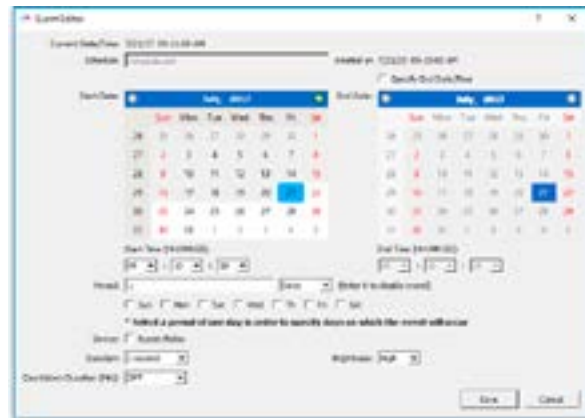

Digital Clock Event Editor

1. Current Date/Time – This displays the current date and time of the selected network clock.
2. Schedule – This displays the filename of the schedule in which the event resides. The last modified date and time is also displayed.
3. Start Date Calendar – This is used to select the start date of the event. A date selection prior to the current date is not possible.
4. Start Time (HH:MM:SS) – This is used to select the start time of the event.
5. Specify End Date/Time – This checkbox is used to define an end date and time for the event. The event will be a reoccurring event if this checkbox is not selected. The End Date Calendar and End Time will not be enabled unless this box is checked.
6. End Date Calendar – This is used to select the end date of the event. An end date cannot be selected unless the Specify End Date/Time checkbox is checked. A date selection prior to the current date is not possible.
7. End Time (HH:MM:SS) – This is used to select the end time of the event. The end time cannot be defined unless the Specify End Date/Time checkbox is checked.



Configuration – Network Clock Connect

Event Editor (cont.)

8. **Period** – This is used to define the period of the event. The period is the interval of time between event occurrences. An entry of 0 will disable the event. A numeric value must be entered into the text field. The pull-down menu consists of seconds, minutes, hours, days, and weeks. Here are the possible entries per period duration:

- <x> seconds (0-59)
- <x> minutes (0-59)
- <x> hours (0-23)
- <x> days (0-365)
- <x> weeks (0-53)

Note: Select a period of one day in order to specify days on which the event will occur.

9. **Device** – This is used to select the devices that will trigger for this event. Buzzer/Relay may be selected.

10. **Duration** – This is used to define the duration of the event (ON, OFF, 0–59 seconds). The event duration must be less than the period.

11. **Brightness** – This is used to schedule a change in brightness on the clock display. (High, Low, Sleep, Off).

Note: Brightness settings only available for digital clocks.

12. **Countdown Duration (Min)** – This is used to define the duration of the Countdown timer (Off, 1 Minute-59 Minutes).

Note: Countdown Duration (Min) settings are only available for digital clocks.

13. **Save Button** – This saves the event entry into the schedule.

14. **Cancel Button** – This cancels the event entry.



Analog Clock Troubleshooting: DHCP

When a DHCP network is not present at initial start-up, the PoE clock will default to a random Static IP in the range of 169.254.1.0 to 169.254.254.255. The status LED will flash red. If unable to obtain an IP address through DHCP, follow these troubleshooting steps:

1. Verify that there is power to the PoE clock. The Status LED of the PoE receiver will be illuminated if there is power to the clock.
2. Verify the Ethernet cable connection to the PoE clock. Make sure the patch cable is securely connected and not damaged. Have the cable tested or connect another Ethernet device to this cable to confirm proper connection.
3. Verify with the Network Administrator to ensure that DHCP is enabled on the network you are connecting the PoE clocks.
4. Verify that DHCP is enabled on the PoE receiver.
 - a. Configure a PC that is on the same local network as the PoE receiver, with the following network configurations:

Tip: Note existing PC settings first. Contact your Network Administrator for assistance or reference the following link: <https://support.microsoft.com/en-us/help/15089/windows-change-tcp-ip-settings>

- IP address: 169.254.0.1
 - Subnet Mask: 255.255.0.0
- b. Using the Network Clock Connect application, press the Refresh List button
 - c. Select the clock that was not receiving DHCP (IP address should be in the range of 169.254.1.0 and 169.254.254.255), and press the Configure button
 - d. Click on the Network tab and verify that the DHCP checkbox is selected

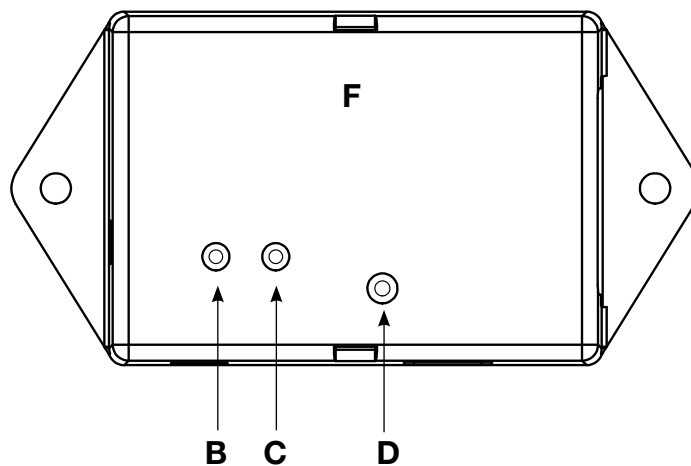

- B – Status LED
- C – Buzzer/Relay LED
- D – Default Button
- F – PoE Receiver/Relay

5. Return PC to the previous settings noted above in Step 4.

If the problem cannot be resolved after following these steps, please call Technical Support at American Time at **800-328-8996**.



Digital Clock Troubleshooting: DHCP

When a DHCP network is not present at initial start-up, the PoE clock will default to a random Static IP in the range of 169.254.1.0 to 169.254.254.255.

Note: If DHCP is enabled and the clock does not receive a DHCP IP or loses the IP, the following symptoms will occur:

- a. On a cold start. The clock will flash colons and dashes for 20 seconds and if no IP is found, will display "noIP".
- b. During normal operation if the clock already has the time and it loses its IP address, the colons will flash with the current time displayed. Note this same behavior will also result with any network issue or all bad time servers. The best way to determine if the IP address was lost from your network is to double-tap the Set switch with a pointed object. If the IP address is not what you expected, continue to next step.

If unable to obtain an IP address through DHCP, follow these troubleshooting steps:

1. Verify that there is power to the PoE clock. The firmware version should scroll across the display when PoE power is first applied.
2. Verify the Ethernet cable connection to the PoE clock. Make sure the patch cable is securely connected and not damaged. Have the cable tested or connect another Ethernet device to this cable to confirm proper connection.
3. Verify with the Network Administrator to ensure that DHCP is enabled on the network you are connecting the PoE clocks.
4. Verify that DHCP is enabled on the PoE receiver.
 - a. Configure a PC that is on the same local network as the PoE receiver, with the following network configurations:

Tip: Note existing PC settings first. Contact your Network Administrator for assistance or reference the following link: <https://support.microsoft.com/en-us/help/15089/windows-change-tcp-ip-settings>

- IP address: 169.254.0.1
 - Subnet Mask: 255.255.0.0
 - b. Using the Network Clock Connect application, press the Refresh List button
 - c. Select the clock that was not receiving DHCP (IP address should be in the range of 169.254.1.0 and 169.254.254.255), and press the Configure button
 - d. Click on the Network tab and verify that the DHCP checkbox is selected
5. Return PC to the previous settings noted above in Step 4.



Troubleshooting Clock Time

When the time displayed in the Network Clock Connect application is incorrect, follow the steps below:

1. Verify that the SNTP servers are working.
2. Verify that the SNTP server addresses are properly entered into the Network Tab.

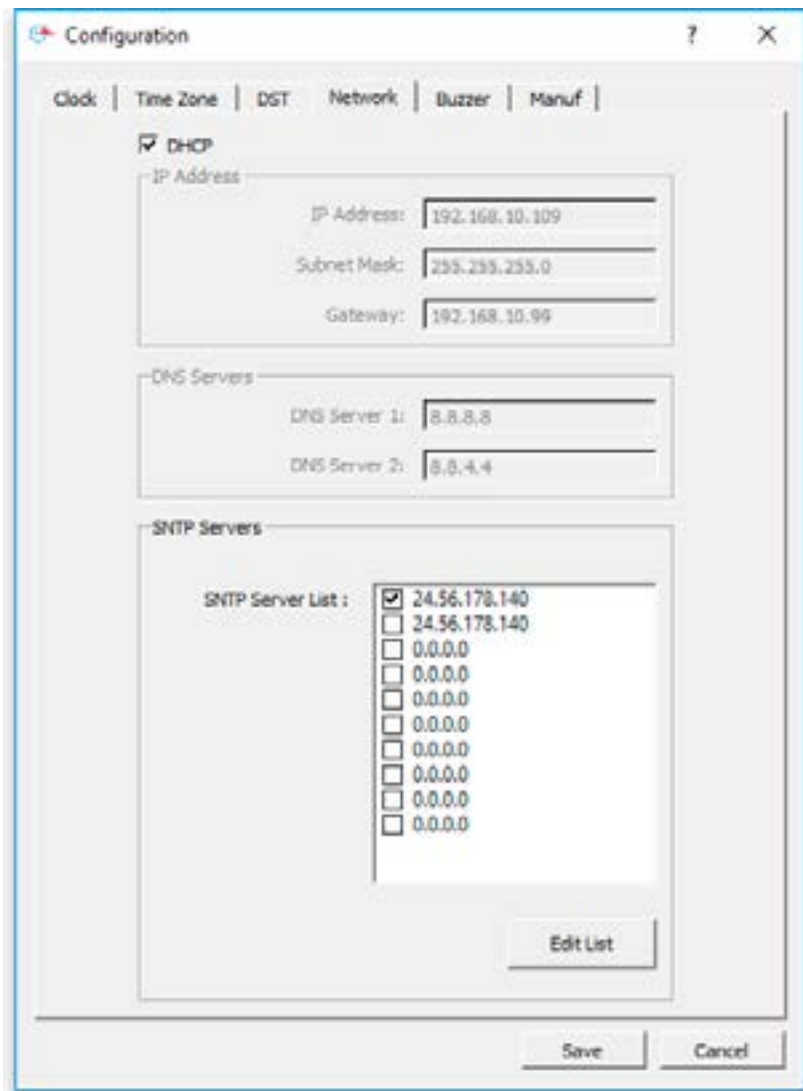

3. Ping the SNTP servers with a PC on the same local network as the network clock(s).
4. Verify with the network administrator that Port 123 is open for SNTP time synchronization.
5. If the SNTP servers do not respond, update the NTP Servers List with new SNTP Servers. When the time displayed on the clock(s) differs from the Network Clock Connect application, follow the steps below:
6. Press the Refresh List button to refresh the time displayed in the application.

For Analog Clocks:

1. Home hands using Instruction Sheet 3133 "Homing PoE Analog Clocks - Serial" for H004640 movement. Find it online: american-time.com Navigate to: [RESOURCES > TECH TIPS](#) Call American Time if you need assistance.

Note: The hands may be off by minutes or seconds if the clock has been jarred. This procedure will reset the hands to 12 o'clock.

If the problem cannot be resolved after following these steps, please call Technical Support at American Time at **800-328-8996**.



Appendix A: NIST Internet Time Servers

Please reference <http://tf.nist.gov/tf-cgi/servers.cgi> for the latest NIST Internet Time servers list, which includes the status of each server.

Appendix B: Supported Time Zones

Time Zone Code	Description	Hours Difference from UTC (Winter)	Hours Difference from UTC (Summer)	Auto DST Adjustment?
00	LMT (Local Mean Time) - based on longitude	CALCULATED	CALCULATED	CONFIG
01	USA Alaska	-9	-8	YES
02	USA Aleutian (HAST/HADT)	-10	-9	YES
03	USA Arizona	-7	-7	NO
04	USA Atlantic / Puerto Rico (AST)	-4	-4	NO
05	USA Central (CST/CDT)	-6	-5	YES
06	USA Chamorro (chST)	+10	+10	NO
07	USA Eastern (EST/EDT)	-5	-4	YES
08	USA Hawaii (HST)	-10	-10	NO
09	USA Indiana East (USIND)	-5	-5	NO
10	USA Mountain (MST/MDT)	-7	-6	YES
11	USA Pacific (PST/PDT)	-8	-7	YES
12	USA Midway Island / Samoa (SST)	-11	-11	NO
13	USA Wake Islands (WAKT)	+11	+11	NO
14	UTC+0	+0	+0	CONFIG
15	UTC+1	+1	+1	CONFIG
16	UTC+2	+2	+2	CONFIG
17	UTC+3	+3	+3	CONFIG
18	UTC+4	+4	+4	CONFIG
19	UTC+5	+5	+5	CONFIG
20	UTC+6	+6	+6	CONFIG
21	UTC+7	+7	+7	CONFIG
22	UTC+8	+8	+8	CONFIG
23	UTC+9	+9	+9	CONFIG
24	UTC+10	+10	+10	CONFIG
25	UTC+11	+11	+11	CONFIG
26	UTC+12	+12	+12	CONFIG
27	UTC+13	+13	+13	CONFIG
28	UTC-1	-1	-1	CONFIG
29	UTC-2	-2	-2	CONFIG
30	UTC-3	-3	-3	CONFIG
31	UTC-4	-4	-4	CONFIG
32	UTC-5	-5	-5	CONFIG
33	UTC-6	-6	-6	CONFIG
34	UTC-7	-7	-7	CONFIG
35	UTC-8	-8	-8	CONFIG
36	UTC-9	-9	-9	CONFIG
37	UTC-10	-10	-10	CONFIG
38	UTC-11	-11	-11	CONFIG
39	UTC-12	-12	-12	CONFIG
99	Custom Time Zone	CONFIG	CONFIG	CONFIG



Appendix C: Buzzer/Relay Scheduling Examples

Example: Scheduling Recurring Events

To schedule a new event that turns on the buzzer for 5 seconds starting at 8:55 AM every weekday Monday – Friday, follow the steps below:

1. Click on Add to prompt the Event Editor
2. Enter the parameters as shown below:

The Event Editor window shows the following configuration:

- Current Date/Time: 07/21/2017 08:13:30 AM
- Schedule: LateStart.sch
- Created on: 07/21/2017 08:14:00 AM
- Start Date: July 2017 (July 20, 2017)
- End Date: July 2017 (July 21, 2017)
- Start Time (HH:MM:SS): 08:55:00
- End Time (HH:MM:SS): (blank)
- Period: 1 Days
- Days: Sun, Mon, Tue, Wed, Thu, Fri, Sat
- Device: Buzzer/Relay
- Duration: 5 seconds

- The Start Date is set to the current date
 - The Start Time is 08:55:00 (Hours dropdown is in military format) which is 8:55 AM
 - The Period is set to 1 Day
 - The Mon, Tue, Wed, Th, Fri checkboxes are selected
 - The Buzzer/Relay checkbox is selected
 - The Duration is set to 5 seconds
 - No End Date/Time is specified for the recurring event
3. Click Save in the Event Editor
 4. Name the schedule in the Schedule Editor to LateStart.sch
 5. Click Save in the Schedule Editor

Note: The maximum number of scheduled events is 100.

The Schedule Editor window shows the following table:

Event #	Start Date/Time	End Date/Time	Period	Device	Duration	Next Occurrence
1	7/21/2017 8:55:00 AM	NONE	Mon Tue Wed Th Fri	Buzzer/Relay	5 seconds	7/23/2017 8:55:00 AM



Appendix C: Buzzer/Relay Scheduling Examples

Example: Scheduling Special Events

To schedule a new special event that turns on the buzzer for 8 seconds starting at 3:45 PM on October 31, 2017, follow the steps below:

1. Click on Add to prompt the Event Editor
2. Enter the parameters as shown below:

The Event Editor window shows the following configuration:

- Current Date/Time: 07/21/2017 08:25:22 AM
- Schedule: SpecialEvent.sch (created on 07/21/2017 08:21:00 AM)
- Start Date: July 2017 (Calendar view shows October 31, 2017 selected)
- End Date: July 2017 (Calendar view shows October 31, 2017 selected)
- Start Time (HH:MM:SS): 15:45:00
- End Time (HH:MM:SS): 15:45:08
- Period: 1 (Min./Sec.)
- Device: Buzzer/Relay
- Duration: 8 seconds

- The Start Date is set to October 31, 2017
 - The Start Time is 15:45:00 (Hours dropdown is in military format) which is 3:45 PM
 - The Period is set to 1 Minute (Period is irrelevant since this is a special event)
 - The Buzzer/Relay checkbox is selected
 - The Duration is set to 8 seconds
 - The End Date/Time is specified as the start time plus the event duration. Therefore, October 31, 2017 at 15:45:08 (3:45:08 PM)
3. Click Save in the Event Editor
 4. Name the schedule in the Schedule Editor to SpecialEvent.sch
 5. Click Save in the Schedule Editor

The Schedule Editor window shows the following table:

Event #	Start Date/Time	End Date/Time	Period	Device	Duration	Next Occurrence
0	7/21/2017 3:45:00 PM	7/21/2017 3:45:08 PM	1 minute	T B/R	8 seconds	7/21/2017 3:45:00 PM



Appendix D: Brightness Control Scheduling Example

Example: Scheduling Display Brightness Events (Digital Clocks)

To schedule a new special event that dims the clocks display over the weekend to save energy, follow the steps below:

In this example, two events will be used. **Event #0** will turn the clocks display to a Low Brightness state every Saturday at 12:00 AM starting on July 22nd. **Event #1** will turn the clocks display back to a High Brightness state every Monday at 12:00 AM, starting on July 23th.

1. Click on Add to prompt the Event Editor
2. Enter the parameters as shown below:

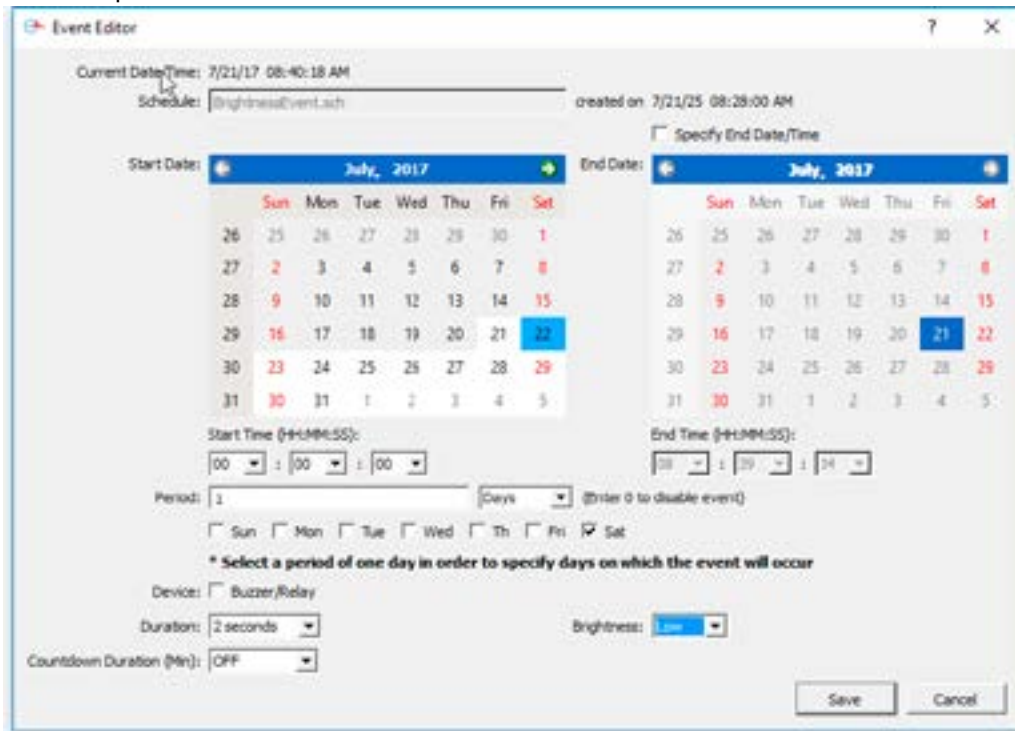

The screenshot shows the 'Event Editor' window with the following settings:

- Current Date/Time: 7/21/17 08:40:18 AM
- Schedule: BrightnessEvent.sch
- created on: 7/21/25 08:28:00 AM
- Start Date: July 22, 2017 (Saturday)
- End Date: July 21, 2017 (Friday)
- Start Time (HH:MM:SS): 00:00:00
- End Time (HH:MM:SS): 23:59:59
- Period: 1 Days
- Days: Sun Mon Tue Wed Th Fri Sat
- Device: Buzzer/Relay
- Duration: 2 seconds
- Brightness: Low
- Countdown Duration (Min): OFF

Event #0

- The Start Date is set to September 10, 2011
 - The Start Time is 00:00:00 (Hours dropdown is in military format) which is 12:00 AM
 - The Period is set to 1 Day
 - The Sat checkbox is selected
 - The Buzzer/Relay checkbox is not selected
 - The Duration is set to 2 seconds (Duration is irrelevant as long as it is not set to ON or OFF for this example)
 - Brightness is set to Low (Sleep Mode could also be used for this example)
 - Countdown Duration is set to Off (available only with clocks with countdown functionality)
 - No End Date/Time is specified for the recurring event
3. Click Save in the Event Editor



Appendix D: Brightness Control Scheduling Example

- Click on Add to prompt the Event Editor
- Enter the parameters as shown below:

Event Editor

Current Date/Time: 7/21/17 09:35:47 AM
 Schedule: BrightnessControl.sch created on 7/21/25 08:41:00 AM

Start Date: July, 2017 End Date: July, 2017

Start Time (HH:MM:SS): 00 : 00 : 00 End Time (HH:MM:SS): 00 : 00 : 00

Period: 1 Days (Enter 0 to double event)

Sun Mon Tue Wed Thu Fri Sat

* Select a period of one day in order to specify days on which the event will occur

Device: Buzzer/Relay

Duration: 2 seconds Brightness: High

Countdown Duration (Min): OFF

Save Cancel

Event #1

- The Start Date is set to July 23, 2017
 - The Start Time is 00:00:00 (Hours dropdown is in military format) which is 12:00 AM
 - The Period is set to 1 Day
 - The Mon checkbox is selected
 - The Buzzer/Relay checkbox is not selected
 - The Duration is set to 2 seconds (Duration is irrelevant as long as it is not set to ON or OFF for this example)
 - Brightness is set to High
 - Countdown Duration is set to Off (available only with clocks with countdown functionality)
 - No End Date/Time is specified for the recurring event
- Name the schedule in the Schedule Editor to BrightnessEvent.sch
 - Click Save in the Schedule Editor

Schedule Editor - BrightnessEvent.sch

Schedule: BrightnessEvent.sch created on 7/21/25 @ 08:41 AM Current Date/Time: 7/23/17 09:36:39 AM

Event #	Start Date/Time	End Date/Time	Period	Device	Duration	Countdown	Next Occurrence	Brightness
0	7/21/2017 12:00:00 AM	NONE	Sat	NONE	2 seconds	OFF	7/21/2017 12:00:00 AM	Low
1	7/23/2017 12:00:00 AM	NONE	Mon	NONE	2 seconds	OFF	7/23/2017 12:00:00 AM	High

Import Export Add Edit Delete Delete All Print Save Cancel



Appendix E: Optional Timer Control Station Installation

The optional **Timer Control Station** can be mounted to a double gang box, 1½ inch deep or deeper. The Control Station can be mounted up to 30 feet away from the Digital Clock/Timer. The recommended minimum interconnecting field wire size is #22.8 AWG stranded wire.

Ensure that installation conforms to the **National Electrical Code** and local wiring codes.

CAUTION: Electric Shock Hazard! Ensure that **NO** electrical power is present on any wire before installation.

1. Pull interconnecting field wires into the double gang box.
2. Connect field wiring interconnecting the Timer Control Station with the Digital Clock/Timer to the appropriate wires of the Control Station. See wiring detail below.
3. Mount the Control Station to the double gang box using the machine screws provided.
4. Terminate

Digital Clock/Timer Code Blue wiring using Control Station

The Control Station is connected as normal.

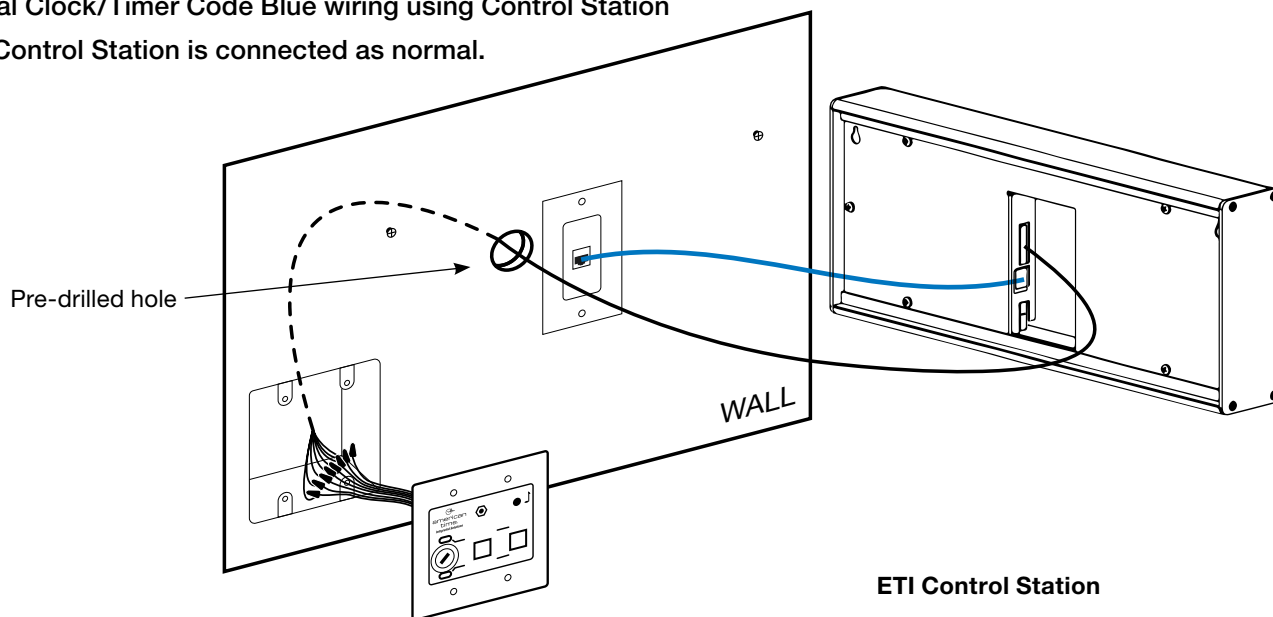

ETI Control Station

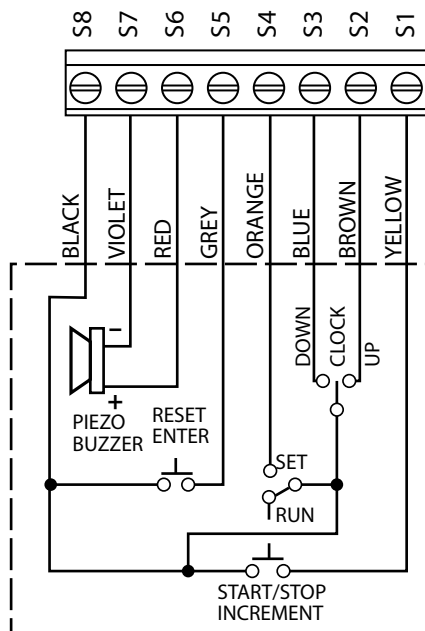

1. START/STOP/INCREMENT – Yellow Wire
2. ETI UP – Brown Wire
3. ETI DOWN – Blue Wire
4. SET/RUN – Orange Wire
5. RESET/ENTER – Grey Wire
6. 12V – Red Wire
7. PIEZO – Violet Wire
8. GND – Black Wire

