



SHEET METAL SECTION GLOSSARY

<i>Front Panels (Car)</i>	108-109
<i>Air Deflectors</i>	108-109
<i>Rear Panels (Car)</i>	110-111
<i>Car Hoods</i>	112
<i>Roof Panels</i>	112
<i>Trunk Lids & Panels</i>	113
<i>Station Wagon Tailgates & Surrounding Pieces</i>	113
<i>Sill & Rocker Panels (Car)</i>	113
<i>Doors & Door Skins (Car)</i>	114-115
<i>Truck Panels</i>	115-116



From Altoona, Alabama, Max Self's Champ Pickup and a few Saturdays worth of Studebaker restoration projects lined up on the premises. When you're ready to tackle that 1957 Packard wagon, Max, we have the tail lights on page 204. Oh and the hood letters are on page 48, the upper tailgate release handle is on page 156... and well... you just give us a call. We'll be here when you're ready!

FRONT FENDERS

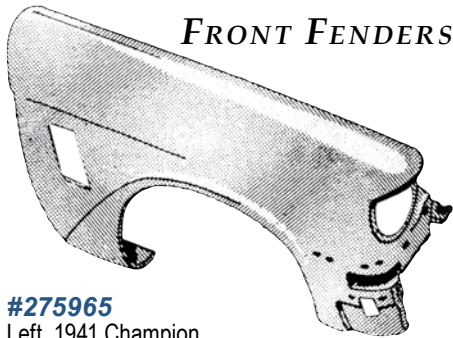

- #275965** Left. 1941 Champion. \$600.00 ea.
- #275966** Right. 1941 Commander. \$700.00 ea.
- #275967** Left. 1941 Commander. \$700.00 ea.
- #282618** Right. 1942 Commander. \$600.00 ea.
- #282619** Left. 1942 Commander. \$600.00 ea.
- #285621** Left. 1947-49 Champion. \$700.00 ea.
- #286180** Right. 1952 car. \$650.00 ea.
- #286181** Left. 1952 car. \$650.00 ea.
- #289830** Right. 1950 Commander. \$700.00 ea.
- #297284** Right. 1955 sedan & station wagon without wraparound windshield. ... \$600.00 ea.
- 308156** Right, includes apron. 1955 sedan & station wagon without wraparound windshield. \$700.00 ea.

- #308613** Left, includes apron. 1955 sedan & station wagon with wraparound windshield. \$600.00 ea.
- #1312156** Right. 1956 sedan & station wagon. \$650.00 ea.
- #1312157** Left. 1956 sedan & station wagon. \$650.00 ea.
- #1320499** Left front less apron. 1957 sedan & station wagon. \$650.00 ea.
- #1323200** Right. 1957 Packard. \$800.00 ea.
- #1323201** Left. 1957 Packard. \$700.00 ea.
- #1323209** Left, includes apron. 1957 Packard. \$800.00 ea.
- 1326408** Right. 1958 J-body hardtop, sedan & station wagon. All except Scotsman. \$450.00 ea.
- 1326409** Left. 1958 J-body hardtop, sedan & station wagon. All except Scotsman. \$450.00 ea.
- 1328248** Right. 1958 Scotsman. \$400.00 ea.
- 1328249** Left. 1958 Scotsman. \$400.00 ea.
- 1358146** Right. 1964-66 Lark. \$225.00 ea.
- 1358147** Left. 1964-66 Lark. \$225.00 ea.

symbol indicates limited availability on a new stocked piece.

() denotes parts book illustration number.

FRONT FENDER APRONS

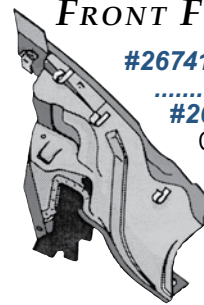

- #267415** Left. 1938 President. \$90.00 ea.
- #267543** Right. 1938 Commander & Coupe Express. ... \$90.00 ea.
- #267544** Left. 1938 Commander & Coupe Express. ... \$90.00 ea.
- #269426** Left. 1939-40 Commander & Coupe Express. \$90.00 ea.
- NEW LISTING - #269465** Right. 1939-40 President. \$90.00 ea.
- NEW LISTING - #269466** Left. 1939-40 President. \$90.00 ea.
- #274850** Right. 1941-42 Commander. \$75.00 ea.
- #274852** Right. 1941-42 President. \$75.00 ea.
- #284385** Left. 1947-49 Champion. Includes battery box. \$120.00 ea.
- #285946** Left. 1947-49 Commander. Includes battery box. Same as 287891 Replacement piece. \$120.00 ea.
- #287524** Right. 1947-49 Champion. \$75.00 ea.
- #287890** Right. 1947-49 Commander. \$75.00 ea.
- #287891** Left. Includes battery box. 1947-49 Commander. Same as 285946. \$120.00 ea.
- #298402** Right. 1953-55 sedan & station wagon. \$75.00 ea.
- #298403** Left. 1953-55 sedan & station wagon. Includes battery box. \$120.00 ea.
- #1323178** Right. 1956-58 All except C & K. \$70.00 ea.
- #1323179** Left. 1956-58 All except C & K. \$120.00 ea.
- #1323188** Right. 1953-62 C & K. \$200.00 ea.
- #1323189** Left. 1953-62 C & K. \$200.00 ea.
- #1331752** Right. 1959-60 Lark. \$95.00 ea.
- 1331753** Left. 1959-60 Lark. \$75.00 ea.
- 1338564** Right. 1961-63 Lark. \$65.00 ea.
- #1338401** Left front. 1961 Lark. \$75.00 ea.
- 1343011** Left. 1961-62 Lark. \$75.00 ea.
- 1343015** Left. 1962 Lark with heavy duty battery. \$75.00 ea.
- 1353855** Left. 1963 Lark with heavy duty battery. \$75.00 ea.
- 1353857** Left. 1963 Lark. \$65.00 ea.
- 1356084** Right. 1964-66 Lark. \$65.00 ea.
- 1356085** Left. 1964-66 Lark. \$75.00 ea.

UPPER RADIATOR AIR DEFLECTORS (0502-84)

284344 1947-48 Champion. \$65.00 ea.

#289415 1947-48 Champion. Can substitute for 284344. \$65.00 ea.

#290488 1949 Champion. \$70.00 ea.

#289575 1950 Champion. \$90.00 ea.

293694 1951 All. \$70.00 ea.

296206 1952 All. \$65.00 ea.

297776 1953-54 All except C & K. \$60.00 ea.

285810 1947-49 Commander. \$60.00 ea.

308093 1955 All except C & K. \$65.00 ea.

308223 1955 C & K. \$90.00 ea.

#1312925 1956 sedan & station wagon. \$70.00 ea.

#1328402 1958 Packard, all except Hawk. \$70.00 ea.

#1320063 All 1957 Studebakers except C & K. All 1957 Packard & 1958 Scotsman. \$60.00 ea.

1326498 1958 sedan & station wagon, all except Scotsman. \$70.00 ea.

1356110 1964 Lark all models & 1965-66 V-8. \$175.00 ea.

1361022 1965-66 6-cylinder. \$65.00 ea.

RADIATOR AIR DEFLECTORS

That fit up under (0502-84)



#288766 1947-48 Champion. (0502-25) Fits under deflector 284344. \$90.00 ea.

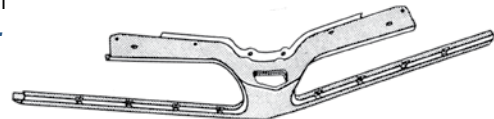

#297820 1953 All except C & K. (0502-23) Fits under deflector 297776. \$70.00 ea.

#306517 1954 All except C & K. (0502-23) Fits under deflector 297776. \$70.00 ea.

FRONT FENDER AIR DEFLECTORS

- #308410** Right. 1955 C & K. **\$90.00 ea.**
#612556 Right. 1955 sedan & station wagon. **\$70.00 ea.**
#612557 Left. 1955 sedan & station wagon. **\$70.00 ea.**
1320036 Right. 1956-57 All except C & K. **\$70.00 ea.**
1320037 Left. 1956-57 All except C & K. **\$70.00 ea.**
1320236P Right. 1958 Scotsman. **\$80.00 ea.**
1320237P Left. 1958 Scotsman. **\$80.00 ea.**
#1326426 Right. 1958 All except Scotsman. **\$80.00 ea.**
#1326427 Left. 1958 All except Scotsman. **\$80.00 ea.**
1331762P Right. 1959-60 Lark All except convertible. **\$90.00 ea.**
1331763P Left. 1959-60 Lark All except convertible. **\$120.00 ea.**
1337306 Right. 1960 Lark convertible. **\$70.00 ea.**
1338420 Right. 1961-63 Lark All except convertible & 1963 station wagon. **\$40.00 ea.**
1338421 Left. 1961-63 Lark All except convertible & 1963 station wagon. **\$40.00 ea.**
1339110 Right. 1961 Lark convertible. **\$70.00 ea.**
1339111 Left. 1961 Lark convertible. **\$70.00 ea.**
#1342706 Right. 1962-63 Lark convertible & 1963 station wagon. **\$75.00 ea.**
1342707 Left. 1962-63 Lark convertible & 1963 station wagon. **\$75.00 ea.**
1353648 Right. 1963-64 Hawk. **\$120.00 ea.**
1358166 Right. 1964-66 Single Headlight Lark station wagon with sliding roof. **\$49.00 ea.**
1358167 Left. 1964-66 Single Headlight Lark station wagon with sliding roof. **\$49.00 ea.**
1358168 Right. 1964-65 Lark convertibles & station wagon with sliding roof. **\$70.00 ea.**
1358169 Left. 1964-65 Lark convertibles & station wagon with sliding roof. **\$70.00 ea.**
1358171 Left. 1964-66 Single Headlight Lark except sliding roof station wagon. **\$49.00 ea.**
1358172 Right. 1964-66 Dual Headlight cars except sliding roof station wagon. **\$40.00 ea.**
1358173 Left. 1964-66 Dual Headlight cars except sliding roof station wagon. **\$75.00 ea.**

FRONT NOSE PANELS

- #289546** 1950 Commander. **\$125.00 ea.**
#293230 1951- Cars, all. **\$250.00 ea.**
1338128 1961 Lark with dual headlights. **\$225.00 ea.**
1339213 1961 Lark with single headlights. **\$175.00 ea.**
1342512 1962-63 Lark. **\$250.00 ea.**
1362209 Grille Panel. 1966 all models. **\$110.00 ea.**

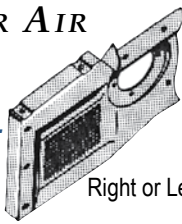

Right or Left

FRONT LOWER PANELS, AIR DEFLECTORS, OR SPLASH GUARDS

- (0502-89) #269687P** Air deflector. 1937-38 All. (0502-89). **\$75.00 ea.**
- (1609-2) #281306** Right front lower. 1942 Commander & President. (1609-1). **\$65.00 ea.**
#281307 Left front lower splash guard. 1942 Commander & President. (1609-2). **\$65.00 ea.**
#281398 Right front lower. 1942-46 Champion. (1609-1). **\$65.00 ea.**
#281399 Left front lower splash guard. 1942-46 Champion. (1609-2). **\$65.00 ea.**
- (1609-1) #286144** Right splash guard. 1947 Commander. (1609-1). **\$65.00 ea.**
#286145 Left front lower splash guard, front fender lower panel to bumper. 1947 Commander. (1609-2). **\$65.00 ea.**
NEW LISTING - #288777 Right front lower splash guard, front fender lower panel to bumper. 1948 Commander. (1609-2). **\$65.00 ea.**
#288778 Left front lower splash guard, front fender lower panel to bumper. 1948 Commander. (1609-2). **\$65.00 ea.**
#290248 Right splash guard, front fender lower panel to bumper. 1949 Commander & Land Cruiser. (1609-1). **\$65.00 ea.**
290249 Left front splash guard, lower panel to bumper. 1949 Commander & Land Cruiser. (1609-2). **\$65.00 ea.**
- (1601-15-2) #290122** Front lower panel, air deflector. 1950 Commander. (0502-31). **\$75.00 ea.**
#290124 Front lower panel, air deflector 1950 Champion. (0502-31). **\$75.00 ea.**
- NEW LISTING - #290126** Right lower grill extension. 1949 Champion. Painted. (0502-13). **\$25.00 ea.**
NEW LISTING - #290127 Left lower grill extension. 1949 Champion. Painted. (0502-14). **\$25.00 ea.**
#293234 Front lower splash guard. 1951 all cars. (1609-3) Used but in solid condition. **\$85.00 ea.**
- (0502-89) #296218P** Center air deflector. 1952 all. **\$125.00 ea.**
- (0502-91) #308147P** Lower scoop. 1955 with wraparound windshield, all except C & K. **\$250.00 ea.**
- (0502-92) 1312840** Right air deflector. 1956 All except C & K. (0502-91). **\$75.00 ea.**
#1312841 Left air deflector. 1956 All except C & K. (0502-92). **\$75.00 ea.**
- 1601-12-3) #1312902** Right air deflector. 1956-58 sedan & station wagon. (1601-12-2). **\$45.00 ea.**
1312903 Left air deflector. 1956-58 sedan & station wagon. (1601-12-3). **\$45.00 ea.**
1312905 Center air deflector. 1956-58 sedan & station wagon. (1601-12-1). **\$65.00 ea.**
1320068 Center lower air intake. 1957-58 sedan. (1601-12-1). **\$65.00 ea.**
 Wiring and lights not included.
- (0502-92) (1601-15-3) 1320056P** Right air deflector. 1957-58, all except C & K (1601-15-2). **\$35.00 ea.**
1320057P Left air deflector. 1957-58 all except C & K (1601-15-3). **\$35.00 ea.**
1326014 Right air deflector. 1958 all except C & K. (0502-91). **\$75.00 ea.**
1326015 Left air deflector. 1958 all except C & K. (0502-92). **\$75.00 ea.**
#1326550 Center air deflector. 1957-58 all except C & K (1601-15-1). **\$65.00 ea.**
#1328096 Right P-Y-J. 1958 Packard. (0502-24). **\$150.00 ea.**
- (0502-24) #1328426** Front lower air deflector extension. 1958 Packard sedan & J-body hardtop. (1601-15-6). **\$90.00 ea.**
- 1356000** Air deflector. 1964-66 Lark. (1601-12). **\$75.00 ea.**

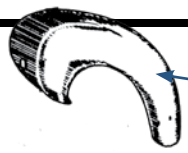

symbol indicates limited availability on a new stocked piece. Please call (317) 462-3124
#270541 Left. 1939-40 Champion. (1604-1)**\$350.00 ea.**

289126 Right. 1 947-49 4-door. (1604-1)**\$300.00 ea.**
#293580 Left. 1951-52 4-door. (1604-1)**\$300.00 ea.**

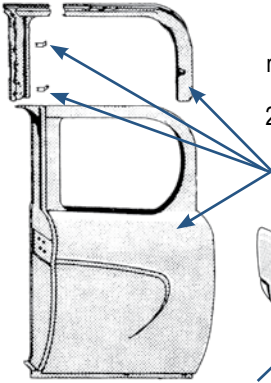
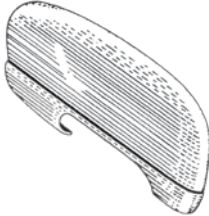

309177 Left front rear quarter, directly behind door. 1955 2-door sedan. Major part of 304659 Kit. (2160-78). **\$200.00 ea.**

#309404 Right. 1953-55 All W-F-Y bodies. (Service) (1604-1).**\$300.00 ea.**

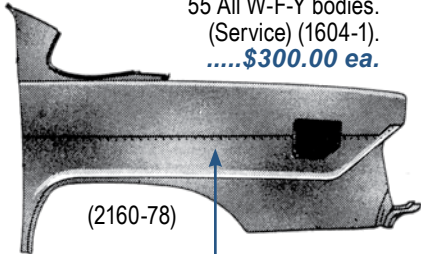

#1316037 Left. 1956 sedan 4-door. (2160-78).**\$300.00 ea.**
#1316047 Left. 1956 sedan 2-door. (2160-78).**\$350.00 ea.**
#1320103 Left. 1957 4-door station wagon. (2160-78).**\$450.00 ea.**
#1323418 Right. 1957 Packard 4-door. (2160-78)**\$300.00 ea.**
#1323419 Left. 1957 Packard 4-door. (2160-78)**\$300.00 ea.**
#1326754 Right. 1958 Packard 4-door. (2160-78)**\$300.00 ea.**
#1326772 Right. 1958 sedan 4-door. (2160-78)**\$150.00 ea.**
1326773 Left. 1958 sedan 4-door. (2160-78)**\$150.00 ea.**
#1328126 Right. 1958 4-door. (See 1326772) (2160-78)**\$150.00 ea.**
#1328129 Left. 1958 2-door. sedan. (Not Illustrated).**\$250.00 ea.**

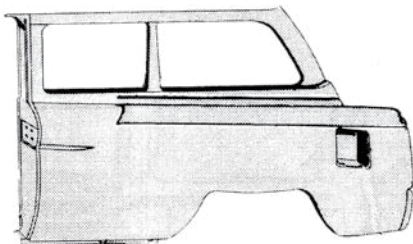

#1320232 Right, rear quarter, outer panel. 1957 2-door station wagon.**\$450.00 ea.**
#1320233 Left, rear quarter, outer panel. 1957 2-door station wagon.**\$450.00 ea.**

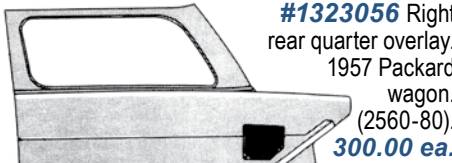

#1323056 Right rear quarter overlay. 1957 Packard wagon. (2560-80). **300.00 ea.**



1323396 Right. 1957 Packard 4-door wagon. Not Illustrated. **\$200.00 ea.**
#1326084 Right. 1958 B & H P4 station wagon. (2160-78).**\$450.00 ea.**

#1326085 Left. 1958 B & H P4 station wagon. (2160-78)**\$450.00 ea.**

1331452 Right. 1959-60 Lark 4-door. 1604-1)**\$150.00 ea.**



1331453 Left. 1959-60 Lark 4-door. (1604-1)**\$150.00 ea.**



1331458 Right. **1331459** Left. 1959-60 Lark 2-door. (1604-1).**\$350.00 ea.**

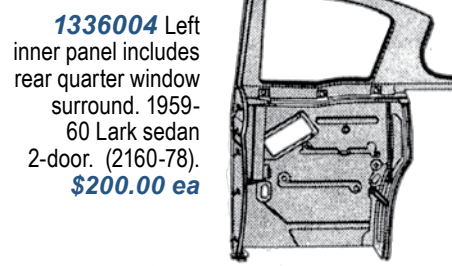

1336004 Left inner panel includes rear quarter window surround. 1959-60 Lark sedan 2-door. (2160-78). **\$200.00 ea**

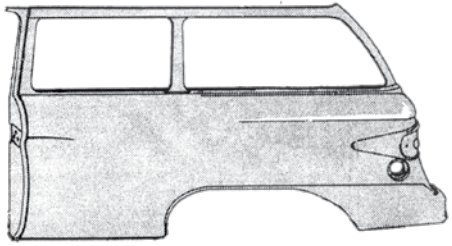

1331782 Right or **#1331783** Left. 1959 2-door station wagon. (2160-78)**\$450.00 ea.**
1331785 Outside repair only, left. 1959 2-door station wagon. (Not Illustrated). ..**\$350.00 ea.**
1336008 Right. 1960 2-door station wagon. (2160-78)**\$450.00 ea.**
1336009 Left. 1960 2-door station wagon. (2160-78)**\$450.00 ea.**
#1338502 Right. 1961 2-door station wagon. (2160-78)**\$450.00 ea.**
#1338503 Left. 1961 2-door station wagon. (2160-78)**\$450.00 ea.**
1338504 Outside repair, right. 1961 2-door station wagon. (Not Illustrated). . **\$350.00 ea.**

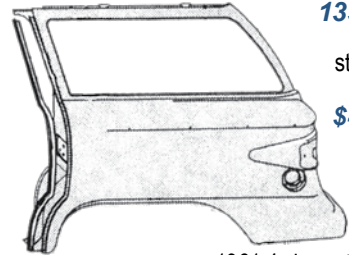

1337002 Right. **1337003** Left. 1960 4-door station wagon. (2160-78). **\$450.00 ea.**
#1339492 Right. **#1339493** Left. 1961 4-door station wagon. (2160-78)**\$250.00 ea.**
#1342542 Right. 1962 4-door station wagon. (2160-78)**\$250.00 ea.**
1342543 Left. 1962 4-door station wagon. (2160-78)**\$250.00 ea.**

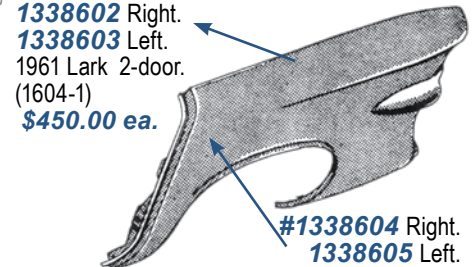

1338602 Right. **1338603** Left. 1961 Lark 2-door. (1604-1)**\$450.00 ea.**

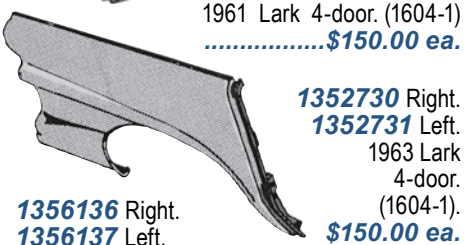

#1338604 Right. **1338605** Left. 1961 Lark 4-door. (1604-1)**\$150.00 ea.**

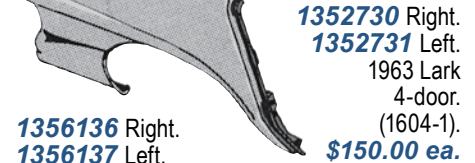

1352730 Right. **1352731** Left. 1963 Lark 4-door. (1604-1).**\$150.00 ea.**
1356136 Right. **1356137** Left. 1964-66 Lark 4-door. (1604-1) ..**\$150.00 ea.**

REAR FENDER FINS



#1312590 Right or **1312591** Left. 1956 station wagon.....**\$200.00 ea**
#1320806P Right. 1957-58 Silver Hawk.....**\$275.00 ea**
#1326250 Right or **#1326251** Left. 1958 Deluxe hardtop. (J-4).**\$250.00 ea.**

NEW Listing - 1326254 Right. 1958 Regal hardtop. (J-6).**\$250.00 ea.**
1326255 Left. 1958 Regal hardtop. (J-6)**\$250.00 ea.**
#1326260 Right. 1958 Deluxe sedan, 4-door.**\$250.00 ea.**
#1326264 Right. 1958 President Classic, 4-door.**\$200.00 ea.**
#1326268 Right. 1958 Packard sedan, 4-door.**\$200.00 ea.**
#1326269 Left. 1958 Packard sedan, 4-door.**\$200.00 ea.**
#1326272 Right. 1958 Packard J-body hardtop.**\$250.00 ea.**
#1327742 Right. 1958 Packard station wagon.**\$200.00 ea.**
#1327743 Left. 1958 Packard station wagon.**\$200.00 ea.**
1327744 Right. 1958 Provincial station wagon.**\$200.00 ea.**
#1339147 Left. 1961 Hawk....**\$275.00 ea.**

REAR SPLASH GUARDS

Bumper to Body (1610-3)



NEW LISTING - #274477 1941 Champion. **\$95.00 ea.**
274974 Rear gravel deflector rubber pad. 1953-54 all models. Takes 5. ... **\$2.50 ea.**

287427 Rear gravel deflector rubber pad. 1955 sedan & 1956-64 C & K car, includes Hawk. Takes 5. **\$2.50 ea.**
#288757 1947 Champion & Commander. Same as 290815. **\$85.00 ea.**
#290815 1947-48 Champion & all 1948 cars. **\$85.00 ea.**
#297463P 1953-54 sedan. **\$85.00 ea.**
#305748 Center section, 1955-56 2-door station wagon. **\$75.00 ea.**
308644 Center section, 1955 sedan, all. **\$75.00 ea.**

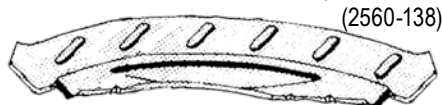

(2560-138)
#1320130 1957-58 Scotsman 2-door station wagon. **\$85.00 ea.**
1320131 1957-58 station wagon all except Scotsman 2-door. **\$75.00 ea.**
1331529 1959-60 station wagon. ... **\$75.00 ea.**
1338574 1961-62 station wagon. ... **\$75.00 ea.**
1353637 1963-66 station wagon. ... **\$65.00 ea.**

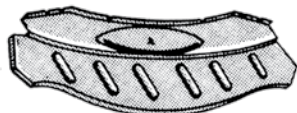

#1323280 Center section, 1957-58 Packard station wagon. (2560-141). **\$85.00 ea.**

REAR GRAVEL DEFLECTORS

(1610-1)



#281637 1942 Commander & President. **\$100.00 ea.**
#520455 1947 cars all models & 1948 Commander. **\$95.00 ea.**
#533578 To frame. 1953 cars. **\$95.00 ea.**
535135 1955 All & 1956-57 Hawks with single exhaust. No Stock
#1544601 1958-64 Hawks with single exhaust. **\$75.00 ea.**
#1548359 Early 1959 station wagon. **\$75.00 ea.**
1549239 1959-60 Lark, all models except station wagon. **\$120.00 ea.**
1549241 Rear deflector, mounts under rear bumper. 1959-62 station wagon. **\$75.00 ea.**
1550734 1961 Lark, all models except station wagon. **\$65.00 ea.**
1557890 Rear deflector, mounts under rear bumper. 1963-65 station wagon. **\$75.00 ea.**
1565904 Rear deflector, mounts under rear bumper. 1966 station wagon. **\$42.00 ea.**

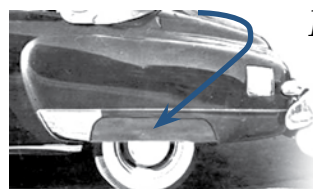

FENDER SKIRTS

801260 Fender skirts. 1947-52 car, all models. **\$145.00 pr.**

REAR WHEELHOUSE AND REAR FENDER INNER GRAVEL DEFLECTOR PANELS



NEW LISTING - #298146 Rear quarter inner deflector panel - fits between left rear tire and gas tank filler pipe, 1953-54 sedan. (1604-10) **\$75.00 ea.**

#609384 Right. 1947-49 2-door. **\$450.00 ea.**

#609386 Right. 1947-49 Starlite Coupe. **\$450.00 ea.**

#609387 Left. 1947-49 Starlite Coupe. **\$450.00 ea.**

#610607 Left. 1950-52 4-door. **\$300.00 ea.**

#1336238 Right outer. 1960 Lark station wagon 2 & 4-door. (2160-100). ... **\$125.00 ea.**

#1336239 Left outer. 1960 Lark station wagon 2 & 4-door. (2160-100). ... **\$125.00 ea.**

#1338522 Right outer. 1961-62 station wagon 2 & 4-door. (2160-100). ... **\$125.00 ea.**

1338523 Left outer. 1961-62 station wagon 2 & 4-door. (2160-100). ... **\$125.00 ea.**

#1338590 Right inner. 1961-62 station wagon 2 & 4-door. (2160-98). **\$125.00 ea.**

#1338591 Left inner. 1961-62 station wagon 2 & 4-door. (2160-98). **\$125.00 ea.**

#1352766 Right inner. 1963-66 station wagon. (2160-98). **\$125.00 ea.**

#1352834 Right outer. 1963-66 station wagon. (2160-100). **\$125.00 ea.**

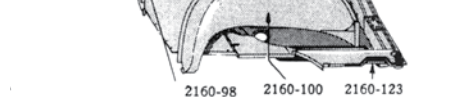

(2160-11)
 (2160-98) (2160-100) (2160-123)

NEW LISTING - #266975

Left rear fender gravel deflector panel, 1938-40 car all except Champion. (1604-10). **\$75.00 ea.**

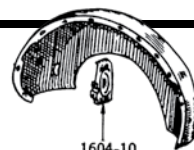

symbol indicates limited availability on a new stocked piece.

() denotes parts book illustration number.

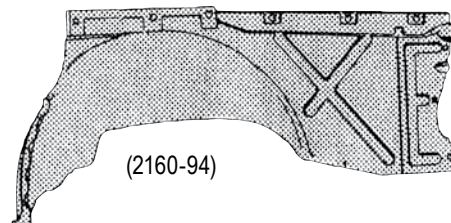

#1316116 Right. 1956-58 sedan. 2 & 4-door. **\$250.00 ea.**

#1327338 Right. 1958 J-body hardtop. **\$350.00 ea.**

#1327339 Left. 1958 J-body hardtop. **\$350.00 ea.**

#1331578 Right. 1959 Lark hardtop. **\$350.00 ea.**

#1336920 Right. 1960 Lark sedan 4-door. **\$250.00 ea.**

1336921 Left. 1960 Lark sedan 4-door. **\$250.00 ea.**

#1336923 Left. 1960 Lark sedan 2-door. **\$350.00 ea.**

#1338342 Right. 1961 Lark sedan 2-door. **\$350.00 ea.**

#1338343 Left. 1961 Lark sedan 2-door. **\$350.00 ea.**

#1338347 Left. 1961 Lark hardtop. **\$350.00 ea.**

1342351 Left. 1962-63 Lark 2-door sedan. **\$350.00 ea.**



BODY SEAM FILLER/WELT

800587X25 1947-52 rear fender to body flexible beading. 25 ft. roll. Easy to paint. **\$38.50 ea.**

1320196-7 1953-55 C & K and 1956-61 Hawk. Metal 'T' shaped strip that fits between rear fender below rear quarter window. 16" long. **\$20.00 ea.**

FENDER CORNER SEALS

Seals between front inner fender and cowl. Takes 2.

1331760 1959-60 Lark. Truck: 1960-64 Champ. **\$9.00 ea.**

1338424 1961-66 Lark **\$9.00 ea.**

1483X1 Clip. All. **\$2.00 ea.**

SPEED-NUT

1331874 Speed-nut, rear fender to body, 1959-66 Lark. **\$3.00 ea.**

INNER FENDER SPLASH APRON

304810 1953-55 All models, left or right side. **\$18.50 ea.**

801930 Steel Staples to adhere splash apron to fender. **\$2.00 set/20**

1331759 1956-66 All models, left or right side. **\$18.50 ea.**

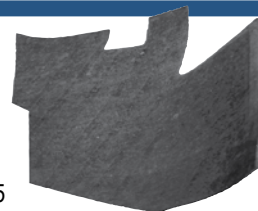

NEW Listing - 1655462 Truck: 1960-64 Champ. **\$28.75 ea.**

REAR QUARTER ROOF REINFORCEMENT PANELS

#1336588 Right rear quarter inner. 1960 convertible (2160-81-1). **\$75.00 ea.**

#1336589 Left rear quarter inner. 1960 convertible. (2160-81-1)..... **\$75.00 ea.**

#1338014 Right rear quarter inner. 1961 convertible (2160-81-1). **\$75.00 ea.**

#1338015 Left rear quarter inner. 1961 convertible (2160-81-1). **\$75.00 ea.**

#1338166 Right rear quarter outer. 1961 hardtop (2160-80). **\$50.00 ea.**

#1338167 Left rear quarter outer. 1961 hardtop (2160-80). **\$50.00 ea.**

#1338168 Right rear quarter inner. 1961 hardtop (2160-81-1). **\$50.00 ea.**

#1338248 Right rear quarter outer. 1961 sedan 4-door, Short wheel base. (2160-80). **\$50.00 ea.**

#1338249 Left rear quarter outer. 1961 sedan 4-door, Short wheel base. (2160-80). **\$50.00 ea.**

#1342320 Right rear quarter outer. 1962 Cruiser (2160-81). **\$50.00 ea.**

#1342321 Left rear quarter outer. 1962 Cruiser (2160-80). **\$50.00 ea.**

#1342324 Right rear quarter outer. 1962 hardtop (2160-81). **\$50.00 ea.**

#1342325 Left rear quarter outer. 1962 hardtop (2160-81). **\$50.00 ea.**

#1342326 Right rear quarter inner. 1962 hardtop (2160-80). **\$55.00 ea.**

#1342327 Left rear quarter inner. 1962 hardtop (2160-80). **\$55.00 ea.**

#1352416 Right rear quarter inner. 1963 hardtop (2160-80). **\$55.00 ea.**

#1352417 Left rear quarter inner. 1963 hardtop (2160-80). **\$55.00 ea.**

FIREWALL (2160-37)

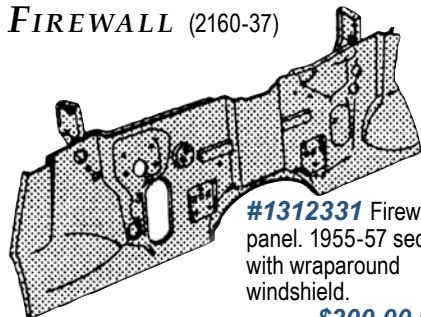

#1312331 Firewall panel. 1955-57 sedan with wraparound windshield. **\$200.00 ea.**

#1331598 Firewall panel for left hand drive car. 1959-60 Lark. **\$200.00 ea.**

#1332422 Firewall panel. 1959-62 Hawk. **\$300.00 ea.**

#1337329 Firewall panel for right hand drive car. 1960 Lark. **\$100.00 ea.**

#1338251 Firewall panel for right hand drive car. 1961-62 Lark. **\$100.00 ea.**

#1338252 Firewall panel for left hand drive car. 1961-62 Lark. **\$200.00 ea.**

ROOF AREA PANELS

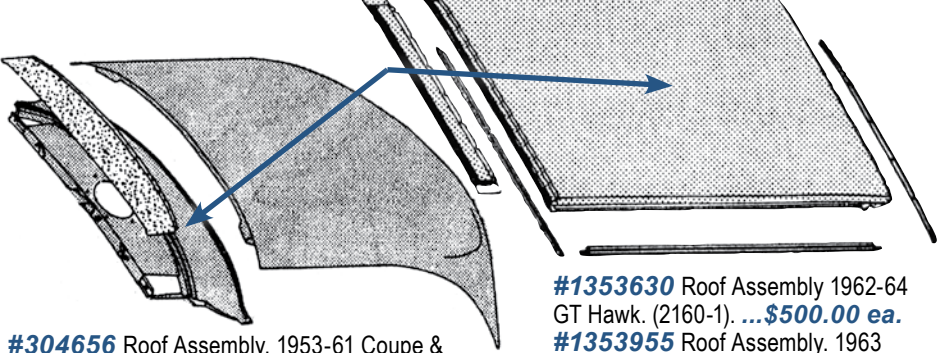

#304656 Roof Assembly. 1953-61 Coupe & hardtop. (2160-1). **\$500.00 ea.**

#1339618 Roof Assembly 1961-62 4-door with sliding roof. (2160-1). **\$500.00 ea.**

#1343573 Rear upper deck opening panel. Includes rear package shelf support. 1962-64 GT Hawk. (2160-106). **\$175.00 ea.**

#1352531 station wagon Sliding roof rear roof section. The part that actually slides. 1963-66 Models (2169-600). **\$325.00 ea.**

#1353630 Roof Assembly 1962-64 GT Hawk. (2160-1). **\$500.00 ea.**

#1353955 Roof Assembly. 1963 sedan 4-door, 1961-63 sedan 2-door, & 1961-62 hardtop with sliding roof. (Sky top) (2160-1). **\$450.00 ea.**

#1355402 station wagon rear roof section. 1963-66 Models with non sliding roof (2160-2). **\$200.00 ea.**

HOOD & SIDE PANELS

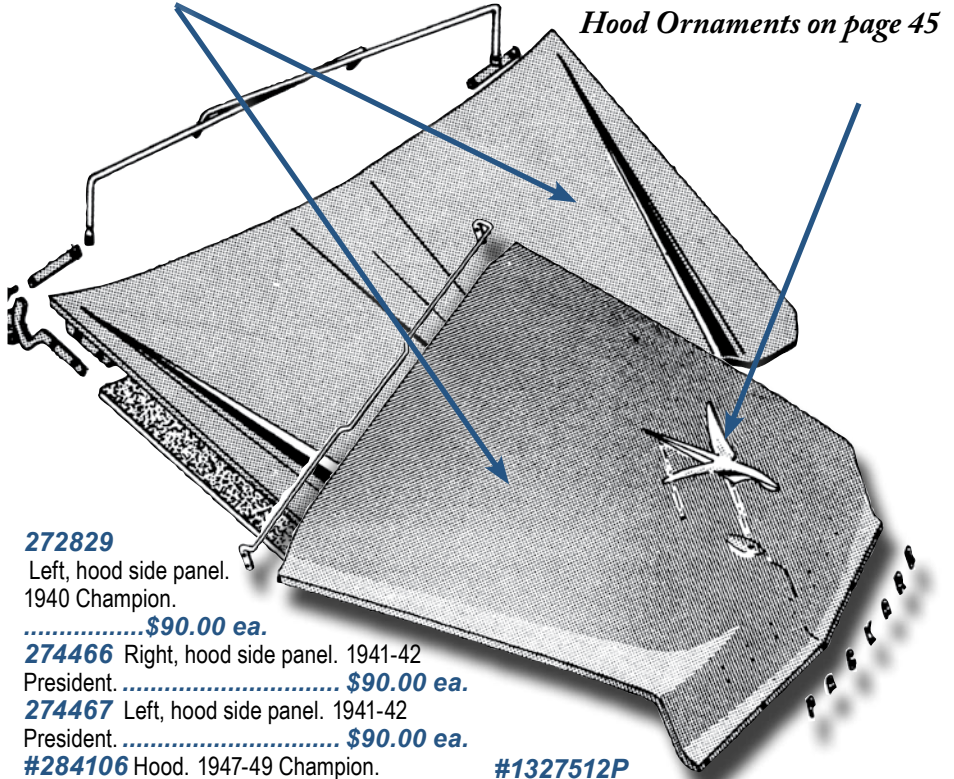

Hood Ornaments on page 45

272829 Left, hood side panel. 1940 Champion. **\$90.00 ea.**

274466 Right, hood side panel. 1941-42 President. **\$90.00 ea.**

274467 Left, hood side panel. 1941-42 President. **\$90.00 ea.**

#284106 Hood. 1947-49 Champion. **\$650.00 ea.**

#285649 Hood. 1947-49 Commander. **\$600.00 ea.**

#289501 Hood. 1950 Commander. **\$800.00 ea.**

#292530 Hood. 1951 All. **\$800.00 ea.**

#308063 Hood. 1955 C & K. (K5). **\$700.00 ea.**

#308084P Hood. 1955 sedan without wraparound windshield (GF). **\$800.00 ea.**

308461 Hood. 1955 car with wrap around windshield. **\$425.00 ea.**

#1312008 Hood. 1956 sedan & station wagon. **\$600.00 ea.**

#1327512P Hood, skin only. 1958 sedan. **\$450.00 ea.**

#1328084 1958 Packard, all except Hawk. **\$300.00 ea.**

NEW LISTING - #1331316 Panel hood top front reinforcement. 1959-60 Lark. **\$75.00 ea.**

#1338051P 1961 Lark. **\$450.00 ea.**

1342505 1962-63 Lark. **\$225.00 ea.**

1356192 Right torsion bar. 1964-66 Lark. **\$65.00 ea.**

1356193 Left torsion bar. 1964-66 Lark. **\$65.00 ea.**

#1358424P Hood. 1964-66 Lark. **\$450.00 ea.**

symbol indicates limited availability on a new stocked piece.

() denotes parts book illustration number.

- #299765 1953 sedan 2 & 4-door. \$400.00 ea.
- #306164 1954-55 C-Coupe. . \$650.00 ea.
- 1316120 1956 sedan 2 & 4-door. \$250.00 ea.
- 1323536 1957-58 2-door Scotsman & 2 & 4-door sedan. \$250.00 ea.
- #1331340 1959-60 Lark all models. \$550.00 ea.
- 1338057 1961 Lark all models except Y-1 4-door. \$250.00 ea.

- #1338058 1961 Lark 4-door Y-1. \$250.00 ea.
- 1342468 1962 Lark 4-door Y-1. \$250.00 ea.
- #1352261 1963 Lark Y-1 4-door. \$250.00 ea.
- #1355225 1963 Lark Y-2 & F-2 sedan. \$250.00 ea.
- 1361140 1962-63 Lark all models except Y-1 4-door. \$250.00 ea.

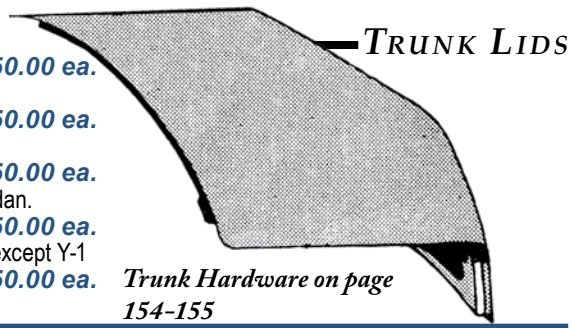

Trunk Hardware on page 154-155

TRUNK OPENING REAR PANELS

- NEW LISTING - #287959** Lower deck opening rear panel. Late 1947-49 car. \$65.00 ea.
- NEW LISTING - #297796** Lower deck opening rear panel. Possibly for early 1947 car. \$65.00 ea. (2160-115)

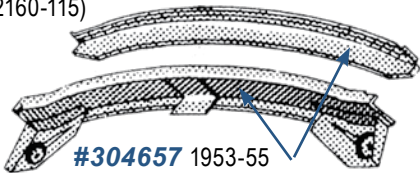
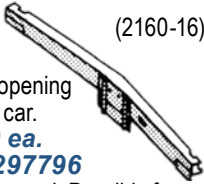

#304657 1953-55 sedan, all models. 2-piece kit. \$150.00 ea.

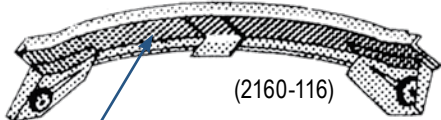

- NEW LISTING - #308128** 1953-64 C & K car. \$295.00 ea.
- 1320418 1956-58 sedan, 2 & 4-door. \$125.00 ea.
- #1323303 1957-58 Packard, 4-door. \$160.00 ea.



- NEW LISTING - 1316003** Lower deck opening rear panel, 1956 sedan. Part of 1312548 panel kit. \$160.00 ea.
- #1323079 Largest piece of 1320519 lower deck kit. 1957-58 Packard sedan. \$200.00 ea.
- #1323474 Largest piece of 1320518 Lower deck kit. 1957-58 sedan. (2160-115). \$200.00 ea.

- 1338100 1961 Lark, all models. \$175.00 ea.
- 1342700 1962 Lark, all models. \$175.00 ea.

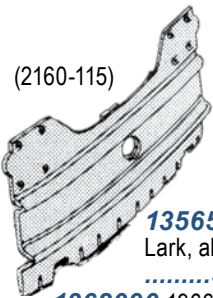

1356575 1964-65 Lark, all models. \$175.00 ea.

1362090 1966 sedan, all models. \$175.00 ea.

MOULDING & ROCKER PANEL CLIPS

- 289138 Moulding clip. Rocker panel, all 1949-52 cars with rocker panel. \$3.95 ea.

- 296514G Clip. Top of door & rear quarter cast moulding. All 1953 & early 1954 cars with snap-type clip on back of moulding. \$2.00 ea.

SILL OR ROCKER PANELS

- #278430 Right. Early 1941 Champion 4-door. \$150.00 ea.
- #278431 Left. Early 1941 Champion 4-door. \$150.00 ea.
- #278432 Right. Early 1941 Champion 2-door. \$150.00 ea.
- #278435 Left. Early 1941 Champion Business Coupe. \$150.00 ea.
- #278437 Left. 1941 Commander & President. \$150.00 ea.
- New Listing - #280862** Right. Late 1941 - 46 Champion 2-door sedan. \$150.00 ea.
- New Listing - #286026** Right. 1947- Early 1948 Land Cruiser. \$120.00 ea.
- New Listing - #286388** Right. 1947- 52 4-door sedan, W-1 & W-3 bodies. \$120.00 ea.
- New Listing - #286389** Left. 1947- 52 4-door sedan, W-1 & W-3 bodies. \$120.00 ea.
- #289140 Right. 1948-52 4-door sedan. \$120.00 ea.
- #289142 Right. 1948-52 4-door, Land Cruiser. \$120.00 ea.
- #297568 Right. 1953-58 Land Cruiser & President Classic. \$120.00 ea.
- #297569 Left. 1953-58 Land Cruiser & President Classic. \$120.00 ea.
- #298609 Left. 1953-58 2-door sedan. \$120.00 ea.
- #1331888 Right. 1959-60 Lark 2-door, all except C & K car. \$120.00 ea.
- #1331889 Left. 1959-60 Lark 2-door, except C & K car. \$120.00 ea.

- 1331894 Right. 1959-60 Lark 4-door sedan. \$150.00 ea.
- 1331895 Left. 1959-60 Lark 4-door sedan. \$120.00 ea.
- #1331896 Right. 1959-60 Lark 4-door, taxi. \$95.00 ea.
- #1331897 Left. 1959-60 Lark 4-door, taxi. \$95.00 ea.
- #1336276 Right. 1960 Lark 4-door station wagon. \$95.00 ea.
- #1336277 Left. 1960 Lark 4-door station wagon. \$95.00 ea.
- #1338279 Left. 1961-62 Lark 2-door station wagon. \$95.00 ea.
- 1338282 Right. 1961 Lark 4-door, all except Cruiser & C & K body. \$95.00 ea.
- #1338283 Left. 1961 Lark 4-door, all except Cruiser & C & K body. \$95.00 ea.
- NEW Listing - #1338285** Right. 1962 4-door sedan. \$95.00 ea.
- 1343776 Right. 1953-64 C & K-body includes Hawk. \$95.00 ea.
- 1343777 Left. 1953-64 C & K-body includes Hawk. \$95.00 ea.
- New Listing - #1353284** Right. 1963-66 station wagon. \$95.00 ea.
- New Listing - #1353285** Left. 1963-66 station wagon. \$95.00 ea.
- New Listing - #1353289** Left. 1963-66 4-door sedan. \$95.00 ea.

NOTE: THE ABOVE ROCKER PANELS ARE ALL THE WELD - TYPE.

STATION WAGON TAILGATES & SURROUNDING PIECES

- (2160-88-6) #1320110 Right Inner tail light mounting panel. 1957 wagon. Pictured. \$75.00 ea.
- #1320111 Left Inner tail light mounting panel. 1957 wagon. \$75.00 ea.

- #1352750 Rear floor panel. Early 1963 wagon. \$700.00 ea.
- #1353991 Rear floor panel. Late 1963-66 wagon. (2160-123) \$700.00 ea.

- #1332738 Tailgate. Lower service. 1954-59 2-door wagon. \$350.00 ea.

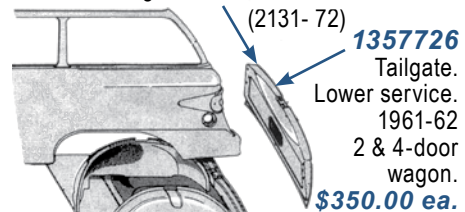

(2131- 72) #1357726 Tailgate. Lower service. 1961-62 2 & 4-door wagon. \$350.00 ea.

- #1331632 Rear floor panel. 1959-60 station wagon 2 & 4-door. \$700.00 ea.
- #1339198 Rear floor panel. 1961-62 2 & 4-door wagon. \$700.00 ea.

4-DOOR FRONT

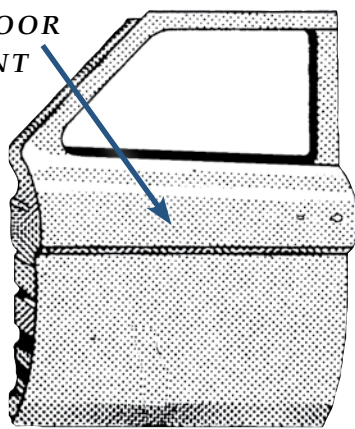

- #292388 Right. 1950-52 \$450.00 ea.
- #292389 Left. 1950-52 \$450.00 ea.
- #298050 Right. 1953-55 sedan. \$450.00 ea.
- #298051 Left. 1953-55 sedan. \$450.00 ea.
- 1314628 Right. 1956 sedan. \$400.00 ea.
- #1314629 Left. 1956 sedan. \$600.00 ea.
- #1323161 Left. 1957-58 sedan. \$450.00 ea.
- #1323370 Right. 1957-58 station wagon. Upper corner is damaged. \$450.00 ea.
- #1323371 Left. 1957-58 station wagon. \$450.00 ea.
- 1336050 Right. 1959-62 station wagon. \$400.00 ea.
- 1336051 Left. 1959-62 station wagon. \$400.00 ea.
- 1352180 Right. 1963-66 sedan & station wagon. \$400.00 ea.

DOOR SKINS

4-door Vehicle (Front)

- 308018 Right. 1961-62 Lark. \$300.00 ea.
- #308019 Left. 1961-62 Lark. \$350.00 ea.
- #1352012 Right. 1963-66 Lark. \$350.00 ea.
- #1352013 Left. 1963-66 Lark. \$350.00 ea.

2-DOOR

- #282340 Right. 1941-46 Champion. \$650.00 ea.
- #282341 Left. 1941-46 Champion. \$650.00 ea.
- #298056 Right. 1953-55 sedan. \$450.00 ea.
- #298057 Left. 1953-55 sedan. \$450.00 ea.
- #1314669 Left. 1956 K-body Hawk. \$800.00 ea.
- #1320564 Right. 1957 station wagon. \$450.00 ea.
- 1320574 Right. 1957-64 K - Hawk. \$650.00 ea.
- 1320600 Right. 1957-58 sedan. \$450.00 ea.
- 1320601 Left. 1957-58 sedan. \$450.00 ea.
- #1320603 Left. 1957-58 station wagon. \$450.00 ea.

CENTER PILLAR POST Rear Door Hinge Pillar

NEW Listing - 284662 Right. 1947-52 all cars with 4-doors. \$150.00 ea.

NEW Listing - 297290 Right. 1953 all cars with 4-doors. \$150.00 ea.

NEW Listing - 308627 Left. 1953-55 car all cars with 4-doors. \$150.00 ea.

FRAME TO BODY PADS

- 311446X2 1/8" 1953-66 all models. \$2.50 ea.
- 311446X4 1/4" 1953-66 all models. \$2.50 ea.
- 311446X6 1/2" 1953-66 all models. \$2.50 ea.

653832-3 Truck body mounts. 1955-64C-Cab & 1960-64 T - Cab truck. \$25.00/set 4

DOOR SKINS 4-door Vehicle (Rear)

- 1331444 Right rear, 1961 Lark Cruiser. \$200.00 ea.
- 1331445 Left rear, 1961 Lark Cruiser. \$200.00 ea.
- #1342302 Right rear, 1962 Lark Cruiser. \$250.00 ea.
- #1352008 Right rear, 1963 Lark sedan. \$200.00 ea.
- 1352009 Left rear, 1963 Lark sedan. \$200.00 ea.
- 1358534 Right rear, 1964-66 Lark sedan. \$200.00 ea.
- #1358535 Left rear, 1964-66 Lark sedan. \$200.00 ea.

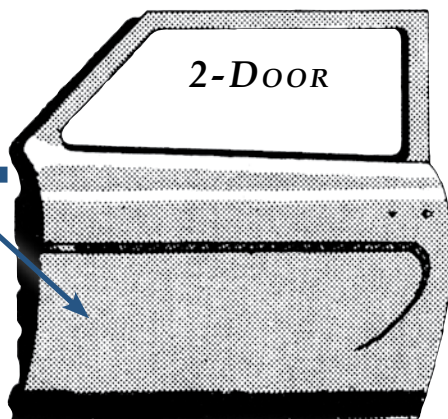

- #1327622 Right. 1958 J-body hardtop. \$450.00 ea.
- 1327623 Left. 1958 J-body hardtop. \$450.00 ea.
- #1331276 Right. 1959-61 C-Coupe. \$650.00 ea.
- 1331277 Left. 1959-61 C-Coupe. \$650.00 ea.
- 1352186 Right. 1963-66 Lark sedan. \$375.00 ea.
- 1352189 Left. 1963-64 hardtop & convertible. \$550.00 ea.

4-DOOR REAR

- #282364 Right. 1941-42 Commander & President. \$300.00 ea.
- #291601 Left. 1947 - early 1950 Land Cruiser. \$300.00 ea.
- #292416 Right. 1951-52 sedan. \$300.00 ea.
- #292417 Left. 1951-52 sedan. \$300.00 ea.
- #292439 Left. 1951-52 Land Cruiser. \$300.00 ea.
- #310266 Right. 1955 sedan. \$300.00 ea.
- #310267 Left. 1955 sedan. \$300.00 ea.
- #310268 Right. 1955 Land Cruiser. \$300.00 ea.
- #1323162 Right. 1957 President Classic & Packard. \$300.00 ea.
- 1323164 Right. 1957-58 sedan. \$300.00 ea.
- 1323165 Left. 1957-58 sedan. \$300.00 ea.
- #1323374 Right. 1957-58 station wagon. \$300.00 ea.
- #1327344 Right. 1958 President Classic. \$300.00 ea.
- #1327345 Left. 1958 President Classic. \$300.00 ea.
- #1327375 Left. 1957-58 station wagon. \$300.00 ea.
- #1336068 Right. 1959 Lark sedan. \$300.00 ea.
- #1336069 Left. 1959 Lark sedan. \$300.00 ea.
- 1336080 Right. 1959-62 station wagon. \$300.00 ea.
- 1336081 Left. 1959-62 station wagon. \$300.00 ea.
- 1336086 Right. 1960-61 Lark, taxi, & Cruiser. \$300.00 ea.
- 1336087 Left. 1960-61 Lark, taxi, & Cruiser. \$300.00 ea.
- 1338334 Right. 1961 Lark sedan. \$300.00 ea.
- 1338335 Left. 1961 Lark sedan. \$300.00 ea.
- 1342292 Right. 1962 Lark sedan. \$300.00 ea.
- 1342293 Left. 1962 Lark sedan. \$300.00 ea.
- 1352190 Right. 1963-66 sedan. \$300.00 ea.
- 1352191 Left. 1963-66 sedan. \$300.00 ea.
- #1358530 Right. 1963-66 station wagon. \$300.00 ea.

- #607980** Right cowl side panel. 1941-42 Commander & President. (2160-5).**\$160.00 ea.**
- #607981** Left cowl side panel. 1941-42 Commander & President. (2160-5).**\$160.00 ea.**
- #609776** Right cowl side panel. 1947-52 convertible. (2360-5).....**\$160.00 ea.**

- #1330186** Left cowl or door hinge panel, 1958 sedan all with shroud vent. (2360-40).**\$160.00 ea.**
- Not in parts book -
- *1338353** Left side. Front hinge pillar lower front half. 1961 Lark all models. (2360-40).**\$40.00 ea.**

*** Denotes Partial piece**

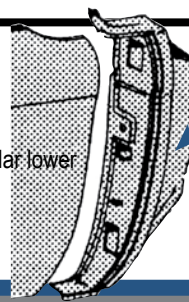

DOOR HINGE POST

- Not in parts book
- *1352299** Left side. hinge pillar inner panel. 66 Lark. (2360-40).**\$50.00 ea.**
- NEW LISTING - 1352294** Right cowl panel. 1963-66 Lark. (2360-40).**\$200.00 ea.**

symbol indicates limited availability on a new stocked piece.
() denotes parts book illustration number.

C- CAB TRUCK

No illustration **#651898** Reinforcement, hinge pillar to windshield side opening. **\$60.00 ea.**

653022 Right front, fender apron. All 1949-64 C-Cab. No illustration.**\$75.00 ea.**

801240 48" Tailgate. 1949-55 truck. (2458-11).**\$415.00 ea.**

801366 51" Tailgate. 1956-59. (2458-11).**\$435.00 ea.**

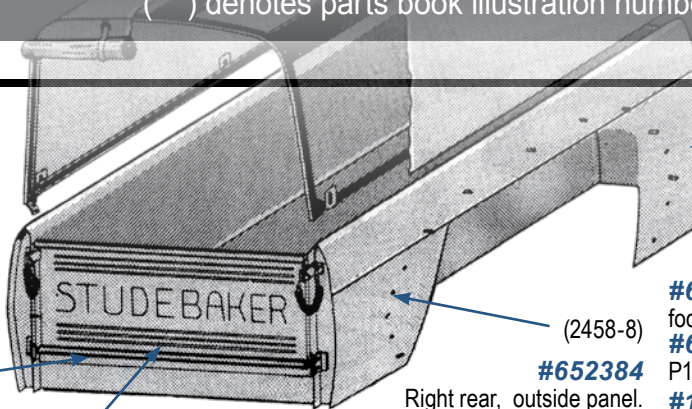

#652378 Right front, outside panel. 6.5 foot bed. Truck: C-Cab 2R-5E.**\$75.00 ea.**

#652379 Left front, outside panel. 6.5 foot. Truck: C-Cab 2R-5E.**\$75.00 ea.**

#652530 Right front, outer bedside panel. 8 foot P1 box. (2458-6).....**\$75.00 ea.**

#652531 Left front, bed outside panel. 8 foot P1 box. (2458-6)**\$75.00 ea.**

#1654009 Left front outer bed side panel. 9 foot. Truck: C-Cab 2E-5E.**\$95.00 ea.**

653495 Cowl top and roof panel. **\$300.00 ea.**

#652384 Right rear, outside panel. 6.5 foot Truck: C-Cab 2R-5E.**\$95.00 ea.**

#652385 Left rear, outside panel. 6.5 foot. Truck: C-Cab 2R-5E. (2458-8)**\$95.00 ea.**

652534 Right rear, outside panel. 8 foot P1 box. Truck: 2R-5E. (2458-8).**\$95.00 ea.**

#652535 Left rear, outside panel. 8 foot P1 box 2-5E (2458-8).**\$95.00 ea.**

#1654013 Left rear outer bed side panel. 9 foot. Truck: C-Cab 2E-5E.**\$95.00 ea.**

1655988-9 Right & Left running boards. 1962-64 C-Cab models 13 thru 45. Part of AC-3267 running board kit. (1506-1). **\$295.00 pr.**

1688124P Splash guard, grill to bumper. C-Cab. 1957-64 except Scotsman. **\$95.00 ea.**

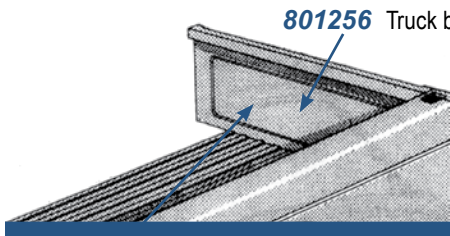
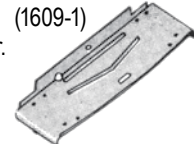

801256 Truck bed header panel. 1949-55 C-cab. **\$225.00 ea.**

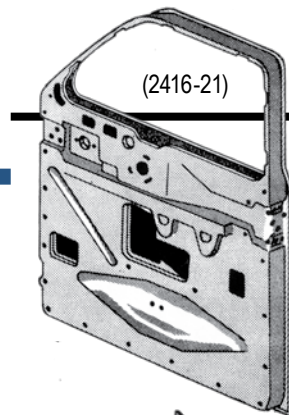

#648626 Right door. M-series truck. Used. (2416-21)**\$250.00 ea.**

#648720 Right hood side panel. 1941-48 Truck: M-5 - 17. (1621-2).**\$75.00 ea.**

#648721 Left hood side panel. 1941-48 Truck: M-5 - 17. (1621-2).**\$75.00 ea.**

M-SERIES TRUCK

801255 Truck bed header panel. 1941-48 M-Series**\$195.00 ea.**

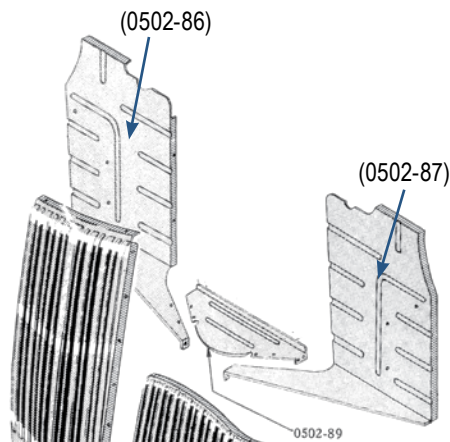

#648710 Right air deflector, radiator side. (0502-86).**\$75.00 ea.**

#648711 Left air deflector, radiator side. (0502-87).**\$75.00 ea.**

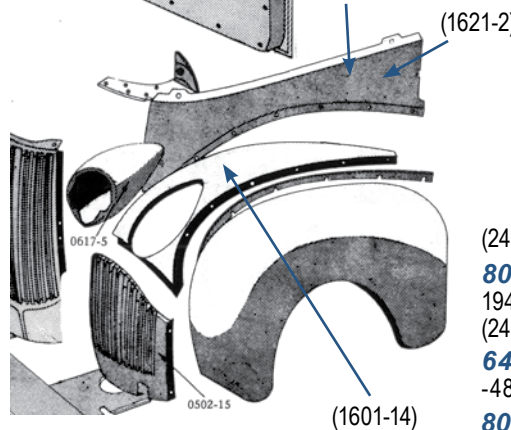

#648723 Left extension, front fender to hood side extension panel. 1941-48 Truck: M5 - M17. Used. (1601-14).**\$75.00 ea.**

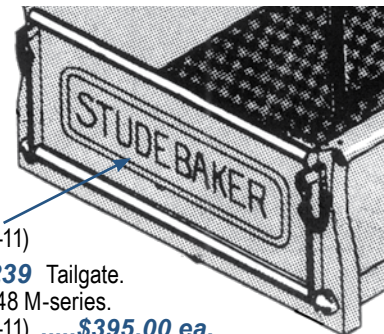

801239 Tailgate. 1941-48 M-series. (2458-11).**\$395.00 ea.**

648805 Tailgate pivot or hinge. All 1941-48 M-series Truck.**\$18.00 ea.**

801388 Rubber chain covers for tailgate chains on all Studebaker Trucks.**\$22.00 pr.**

1656121P Tailgate chain. All Studebaker Trucks. NOS**\$16.00 ea.**

Sheet Metal

Truck Panels -

1657016 Panel, rear & floor step well. (2160-257). **\$60.00 ea.**
1657598 Pocket door panel, step well. (2160-263).....**\$32.00 ea.**

(2160-213)

#1657157 Left, front lower, interior panel. (2160-233).
**\$70.00 ea.**
#1657233 Left, rear corner, interior panel. (2160-213)**\$97.00 ea.**

(2160-240)

#1657223 Left, front, wheel housing. (2160-240).
\$105.00 ea.

#1657260 Grille. (0502-11). Not illustrated.
**\$120.00 ea.**

1657850 Support, gas tank assembly. (1507-33). **\$95.00 ea.**
1657851 Front, step well channel. (1507-27) **\$100.00 ea.**
#1657852 Center, step well channel. (1507-28). **\$40.00 ea.**
#1657853 Rear, step well channel. (1507-29) **\$40.00 ea.**
#1657854 Right rear corner plate and channel assembly. (1507-36)..... **\$40.00 ea.**
#1657855 Left rear corner plate and channel assembly. (1507-37) **\$40.00 ea.**
#1657856 Bracket, rear bumper & step channel. (1507-42) **\$48.00 ea.**

8E POSTAL ZIP VAN

#1657800 lower rear door panel. (2116-94).
**\$75.00 ea.**

(1507-28) (1507-29) (1507-36) (1507-27) (1507-33) (1507-37) (1507-42)

T- CAB TRUCK 1960-64

1331762P Right, front air deflector panel. 1960-64. (1601-2-3). **\$90.00 ea.**
1331763P Left, front air deflector panel. 1960-64. (1601-2-3).**\$120.00 ea.**

(2138-10)

1655301 Shield, pedal protector. Truck: 1960-62. (2138-10).
**\$75.00 ea.**

(1601-2-3)

1655242 Right, rocker panel. Truck: all 1960-64. (2160-126). ..**\$75.00 ea.**
1655243 Left, rocker panel. Truck: all 1960-64. (2160-126). ..**\$75.00 ea.**

(0617-73) (2160-37)

1655217 Roof panel. Truck: all 1960-64. (2160-1). **\$300.00 ea.**

1655749 Dash panel. Truck: all 1961-62. (2160-37).
**\$350.00 ea.**

(2160-1)

1655681 Grille or nose panel. Truck: all 1960-64. (0617-73) **\$400.00 ea**

Light assemblies sold separately on page 121

#1655364 Floor panel. Truck: 1960-62 with 3-speed transmission. In excellent condition..**\$900.00 ea.**

1655460P Right fender apron. Truck: all 1960-64. (1601-2-2). No Stock
 Note: 1331752 featured in the car section is the same piece except for the rubber splash shield.
1655461P Left fender apron. Truck: all 1960-64. (1601-2-2). No Stock
 Note: 1331753 featured in the car section is the same piece except for the rubber splash shield.

(1601-2-2)

#1655673 Left, front fender apron. Truck: 1961-62 Pickup. **\$100.00 ea.**
#1656326 Right, front fender apron. Truck: 1963-64. (1601-2-2). **\$100.00 ea.**
#1656327 Left, front fender apron. Truck: 1963-64. (1601-2-2)..... **\$100.00 ea.**
#1656328 Right, front fender apron. Truck: 1963-64 with right hand drive. (1601-2-2).
 **\$100.00 ea.**
**\$900.00 ea.**

1960-62 P-1 PICKUP BED PARTS T-Cab with outer fenders

(2158-25) (2158-6) (2158-8) (2158-30) (2158-5-3) (2158-3) (2158-5-2) (2158-5) (2158-6)

#652378 Right front, outside panel. 6.5 foot bed. (2158-6)**\$75.00 ea.**
#652379 Left front, outside panel. 6.5 foot bed. (2158-6).....**\$75.00 ea.**
652384 Pickup bed. Right rear outer side panel with 6.5 ft. bed. (2158-8) ... **\$95.00 ea.**
652385 Pickup bed. Left rear outer side panel. with 6.5 ft. bed. (2158-8) .. **\$95.00 ea.**
#652530 Right front, outside panel. 8 foot bed. (2158-8). **\$75.00 ea.**
652534 Right rear, outside panel. 8 foot bed. (2158-8) **\$95.00 ea.**
#652535 Left rear, outside panel. 8 foot bed. (2158-8) **\$95.00 ea.**

#1655025 Left side panel. P2 box. 6.5 foot bed. (2158-3).
 **\$600.00 ea.**
#1656004 Right floor panel. 6.5 foot bed. Located in front of wheel housing. (2158-5-2).
 **\$45.00 ea.**
#1656005 Left front floor panel. 6.5 foot bed. Located in front wheel housing. (2158-5-2).
 **\$45.00 ea.**
#1656011 Left floor panel. 6.5 foot bed. Located behind wheel housing. (2158-5-3).
 **\$65.00 ea.**
#1656012 Right floor panel. 8 foot bed. Located behind wheel housing. (2158-5-3).
 **\$65.00 ea.**

1961-64 P-2 PICKUP BED PARTS Type with smooth sides & no outer fenders

1656019 Rear lower panel. Beneath tailgate. (2158-10). **\$95.00 ea.**
#1656026 Right outside panel. 8 foot bed. (2158-3). **\$650.00 ea.**
#1656027 Left outside panel. 8 foot bed. (2158-3). **\$650.00 ea.**
#1656068 Floor panel. 6.5 feet **\$350.00 ea.**
#1656086 Right rear outer panel. Part with tail light lens hole. (2158-30). **\$140.00 ea.**
#1656087 Left outer corner panel. Part with tail light lens hole. (2158-30). **\$125.00 ea.**
#1656088 Right rear corner reinforcement. (2158-5)..... **\$30.00 ea.**

TAILGATE RELATED PARTS

652476 Tailgate pivot or hinge. All 1949-59 Trucks & 1960-62 with P-1 bed. **\$18.00 ea.**
801388 Rubber chain covers for tailgate chains on all Studebaker Trucks. (2158-25).
 **\$22.00 pr.**
1656121P Tailgate chain. All Studebaker Trucks. (2158-25). NOS. **\$16.00 ea.**