



SHOGUN 7

User Manual

EDITION 1: NOVEMBER 2019



Register your SHOGUN 7 within twelve months of purchase to upgrade to a 3 year warranty*

Registering your product ensures you receive communication on all future updates

Contents

Warranty & Conditions	1
Introduction	2
1. What's included	3
2. What you also need	4
Media (HDD/SSD)	4
HDMI / SDI Cables	4
Standard 1/4" mount	5
3. Mounting disks in the Master Caddy II	6
4. Powering the Shogun 7	7
Choose power source	7
Power ON/Power OFF	8
5. Shogun 7 connections	9
6. AtomX SSDmini, Master Caddy II and Screw Mounts	10
Master Caddy II / SSDmini / Mounting options	10
7. Using the Shogun 7	11
Best Practice	12
- Format Media	13
- Unit Name	13
- File naming	13
- Screen Lock	13
- Firmware updates	14
Main Screen - Information Bar	15
Main Screen - Home	16
Main Screen - Monitoring features	17
Home Screen and Menu Functions	17
Information Bar - overview	18
Input	19
- SDI-Multilink	19
- Trigger	20
Output (external)	21
Record settings	21
File / Meters	22
Audio / Media / Timecode	23
Date and Time	24
Battery	24
Info	24
8. Monitoring & Recording	26
Setting up for recording	26
SmartControl	26
Monitoring Features	27
Waveform Monitoring Tools	28
- Luma Overlay / RGB Parade / Vectorscope	28
Monitor Assist	29
- Focus Peaking / Zebra / False Color	29
- Blue Only / Zoom	30
- Guides	31
- Anamorphic De-squeeze	31
LUTs - loading and using LUTs	32
Monitor	33
- Using Standards – Native / Rec709 / HLG / PQ	34
- Understanding HDR and Log	34
Display	35
File Recovery	35
9. Playback & Payout	36
Playback Mode	36
Playlists	37
Video Format / External	38
Meters / Date / Battery / Info	38
10. Edit	40
Markers & Tagging / Export	41
Export .xml	41
11. HD Pulldown	43
12. Connecting and Editing	44
Connect to Input	44
NLE Support	44
exFAT compatibility	44
Transferring files	44
Importing / Import into Final Cut Pro X	45
13. Technical Specifications	47

Safety Instructions

The Shogun 7 is designed to a high standard but there are some things you should be aware of to prolong the life of the unit and for your own safety.

Using the Shogun 7 safely

Although the Shogun 7 is very lightweight compared to all the devices it replaces, it is still a solid object that could cause injury if misused.

- Always make sure that the Shogun 7 is mounted securely and is unable to fall onto anyone nearby. This is especially important when there are children present who might be tempted to pull on cables.
- Always ensure that cables that run to the Shogun 7 are clearly visible and do not present a trip hazard.
- Do not place on uneven or unstable surfaces.
- Do not insert anything but a Shogun 7 Master Caddy II or AtomX SSDmini in the drive slot on the rear of the Shogun 7.
- Do not touch the Shogun 7 screen with sharp, metallic or abrasive objects.
- Do not expose to strong electrical or magnetic fields.
- Do not expose to liquids, rain or moisture.
- Do not dispose of the Shogun 7 in municipal waste and do not incinerate it, always follow local regulations for safe disposal.

Care of disk drives

Spinning disks and SSDs are very sensitive to damage from static electricity. Please observe all the usual electrostatic discharge (ESD) precautions when handling them.

Please see the section on mechanical shock and vibration later in this manual for information about how to handle and care for your disk drives.

HDMI cables

Please remember that almost all HDMI cables do not use locking connectors and will simply pull out if they are jerked or tripped over.

Please ensure your cables make a secure connection and avoid flexing them excessively to maintain reliability.

Notifications

USA

WARNING: This product contains the chemical lead (Pb) which is known to the State of California to cause cancer. For more information, visit p65warnings.ca.gov

User Manual Conventions

To keep things simple but clear, we've only adopted two conventions in this manual:

 A helpful tip, suggestion or something to note because it's not obvious at first.

 An important note or warning

Warranty & Conditions

International Hardware Limited Warranty

ATOMOS warrants that:

- The main product, not including the IPS screen, or any external accessories, will be free from defects in materials and workmanship for a period of 1 year from the date of purchase; or 3 years upon completion of product registration within 1 year from the date of purchase at www.atomos.com
- The TFT/LCD, HDD/SSD Docking Station, Master Caddy II and Cable will be free from defects in materials and workmanship for a period of 1 year from the date of purchase.

This warranty is exclusively for the benefit of the original purchaser and is not assignable or transferable.

If during the warranty period the product is shown to be defective ATOMOS may at its option:

- a) replace the goods or supply equivalent ones,
- b) repair the goods,
- c) pay the cost of replacing the goods or of acquiring equivalent ones and
- d) paying the cost of having the goods repaired;

The customer must notify ATOMOS of any defect in the goods in writing prior to the expiry of the warranty periods set out above. The customer will be solely responsible for returning the goods to ATOMOS or its authorized distributor. Upon acceptance of a warranty claim by ATOMOS, where ATOMOS repairs or replaces the goods, it will be responsible for reasonable shipping costs incurred in sending the goods to the Customer, provided that customer is located in a country in which ATOMOS has an authorized distributor or repair center or agent.

Warranty Exclusions

This warranty applies only to defects in workmanship and does not cover defects caused by:

- Neglect;
- Improper or negligent acts or omissions;
- Repairs or attempted repairs;
- Tampering with or modification of the goods;
- Connection to incompatible equipment or power sources;
- Exposure to water or weather;
- Exposure to magnetic fields or corrosive liquids or substances;
- Physical damage

Except as stated in this warranty, Atomos, its vendors, agents, resellers and distributors disclaim in their entirety all other warranties, express or implied, including without limitation all warranties of merchantability or fitness for a particular purpose. The remedies outlined in this warranty are the exclusive remedy a customer from defective goods, which are subject to the warranty.

Atomos does not warrant that the goods will operate in a manner that is error free, or uninterrupted. The goods are not intended to be the primary or only data storage device for data – customers are solely responsible for back up and protection of data.

Software License Agreement

IMPORTANT, PLEASE READ CAREFULLY. THIS IS A LICENSE AGREEMENT.

This ATOMOS software, related documentation, any included sample images files (the "Software"), is protected by copyright laws and international copyright treaties, as well as other intellectual property laws and treaties. The Software is licensed, not sold.

This End User License Agreement ("EULA") is a legal agreement between you (either an individual or a single entity) and ATOMOS with regard to the copyrighted Software provided with this EULA. Use of the Software provided to you by ATOMOS in whatever form or media, will constitute your acceptance of these terms, unless separate terms are provided by the

software supplier, in which case certain additional or different terms may apply. If you do not agree with the terms of this EULA, do not download, install copy or use the Software. By installing, copying or otherwise using the Software, you agree to be bound to the terms of this EULA. If you do not agree to the terms of this EULA, ATOMOS is unwilling to license the Software to you.

1. Eligible licensees. This Software is available for license solely to purchasers of the ATOMOS Shogun 7, who have purchased a unit manufactured by ATOMOS Shogun 7 and purchased through an ATOMOS authorized reseller, with no right of duplication or further distribution, licensing or sub-licensing.
2. License Grant. ATOMOS grants you a personal, non-transferable and non-exclusive right to use the copy of the Software provided with this EULA. You agree you will not copy the Software except as necessary to use it with the ATOMOS Shogun 7. You agree that you may not copy the written materials accompanying the Software. Modifying, reverse engineering, translating, renting, copying, transferring or assigning all or part of the Software or any rights granted hereunder, to any other persons or reverse engineering the hardware on which the Software runs, is strictly prohibited. The software is license, not sold. You acknowledge that no title to intellectual property in the Software is transferable to you. You further acknowledge that title and full ownership rights to the Software will remain the exclusive property of ATOMOS and/or its suppliers, and you will not acquire any rights to the Software, except as expressly set forth above. All copies of the software will contain the same proprietary notices as contained in or on the Software. All title and copyrights in and to the Software (including but not limited to any images, animations, video, audio, text incorporated), the accompanying printed materials, and any copies of the Software are owned by ATOMOS or its suppliers.
3. Reverse engineering. You agree that you will not attempt, and if you are a corporation, you will use your best efforts to prevent your employees and contractors from attempting to reverse compile, derive circuits, modify, translate or disassemble the Software and/or the Atomos Shogun 7 in whole or in part. Any failure to comply with the above or any other terms and conditions contained herein will result in the automatic termination of this license and the reversion of the rights granted hereunder by ATOMOS.

ATOMOS reserves the right to terminate this license without prejudice to any additional recourse ATOMOS may have against you if you violate any of its terms and conditions.

Notice

Copyright © 2019 ATOMOS Global Pty Ltd ('referred to as ATOMOS'). All rights reserved. All information in this document is subject to change without notice. No part of the document may be reproduced or transmitted in any form, or by any means, electronic or mechanical, including photocopying or recording, without the express written permission of ATOMOS. A reference to ATOMOS includes its related entities, subsidiaries and parent company.

Trademarks

Shogun 7 and ATOMOS are registered trademarks of ATOMOS. Apple, the Apple logo, AppleShare, AppleTalk, FireWire, iPod, iPod Touch, Mac, and Macintosh are registered trademarks of Apple Inc. Final Cut Pro, QuickTime and the QuickTime Logo are trademarks of Apple Inc. DNxHD, DNxHR and Avid logo are registered trademarks of Avid Technology, Inc. All other trademarks are the property of their respective holders.

REGISTRATION + WARRANTY UPGRADE

Register within 12 months of purchase date to upgrade your standard 1 year warranty to a 3 year warranty.

Visit: www.atomos.com/register

Registered users receive updates of all AtomOS updates upon release.

SHOGUN 7

Atomos Shogun 7 is a precision HDR monitor-recorder-switcher designed for the film and video professional. It can be used as either a stand-alone field monitor, recorder and switcher for event, documentary and live in-the-field storytelling; or as a tool for large-scale on-set episodic TV, film and cinema productions where multiple crew members such as focus pullers, grips and cinematographers require a consistent visual reference across the field monitor ecosystem. Shogun 7's portable size lets you monitor, analyze and tag while on set; and check how your content will look in your audience's home via real-time Dolby Vision output. With Shogun 7 you're not locked into any format, camera manufacturer or pipeline. It is a completely flexible master recording and production station.

This user manual will get you up to speed with all the amazing features packed into the Shogun 7 that will assist you during a shoot and speed up your workflow on set and in post production.

Stay up-to-date with the latest information and software by registering your product today

www.atomos.com/register



ProRes

ProResRAW

Avid DNxHR

AtomHDR

HDMI

HD-SDI

DOLBY VISION™

1. What's included



Your Shogun 7 includes base accessories to get you started, such as a mains power supply and a media Master Caddy. Additionally you will need a 2.5" Solid State Drive (SSD) or AtomX SSDmini, a compatible HDMI cable (Camera out/Shogun 7 in) and compatible batteries. Optional AtomX accessories such as power and accessory kits are also available. Visit the Atomos website for the latest accessory options.

Not all drives are compatible with the Shogun 7. For the most up-to-date information please visit: www.atomos.com/drives

Included:

- **Shogun 7**
- **1 x Master Caddy II + screws**
- **12V-3A AC power supply**
- **Shogun 7 Quick Start Guide**
- **EPP Carry Case**

2. What you also need

Media

Widely available 2.5" SSDs are the basic storage media for Atomos 4K Monitor Recorders. We work closely with leading drive manufacturers to qualify as many options as possible. SSDs are required for 4K recording and for more demanding production environments that may not be suited to spinning hard disks.



We have worked closely with Angelbird and Sony to develop new media designed specifically for the Atomos Ninja V that is 100% compatible with Shogun 7. The new AtomX SSDmini is smaller than a standard SSD, but utilises the same SATA connection as normal HDD/SSD media and is compatible with all Atomos recorders and docking stations.

AtomX SSDmini fits directly into the Shogun 7 disk slot without the need for a Master Caddy II, and can be further enhanced by the addition of AtomX SSDmini handle to make connecting and removing the SSD effortless.



Which drives should you use?

There are so many drives available, and newer models appear all the time. To avoid potential data loss and/or write/read errors, Atomos only recommends the use of approved SSD media only.

We are not able to test all drives but here are some guidelines.

Solid State Drives (SSDs) are recommended for all recording up to 4kUHDp30 and specific drives with sustained high performance write speeds for 4kDCI p60.

Spinning Disk Drives (HDD) are not recommended.

HDDs are not suitable for 4K recording or for use in environments or situations where the units are subjected to vibration and movements.

Here are some things that you should bear in mind when using spinning disks:

- Even though spinning drives can withstand substantial shocks when they are not in use, they are more vulnerable when running. Harsh treatment that may not actually damage the drive may interrupt recordings at a much lower level of severity. We recommend that you experiment with your drives by testing them in the conditions that you normally work in.
- Do not bang or jolt the Shogun 7 while recording.
- Do not use spinning drives (HDD) when recording 4K video
- You will find noticeable differences in the abilities of different drives to withstand shock and to continue recording during vibration and movement.

2. What you also need

■ HDMI cables

Take care to use HDMI cables of the appropriate grade and take care to protect them from damage. Signal issues can often result from damaged HDMI cables, or using cables that are too long.

Atomos makes a range of professional HDMI cables which are ideal for connecting your camera to the Shogun 7. For 4Kp50/60 recordings, the use of Atomos HDMI 2.0 cables would be most optimal.

Not all HDMI cables are created equal and there are a variety of different qualities available. Please make sure you test your cables prior to shooting. This is particularly important when recording 4kp50/60. Many cables will claim to be high speed but will lack the required shielding on both the cable and connector to maintain a high quality signal.



Check your connectivity at both the camera connector and the recorder/monitor connector to make sure you have a firm connection to avoid any signal drop out.



If the HDMI or SDI cable is removed while recording the "Skippy" image will also be displayed. To remove touch Skippy and he will disappear, ready for his next notification.

Refer to page 33, Atomos Anti-shock technology for more information about "Skippy".

■ 4K SDI cables

SDI cables are robust physically and electrically; you should rarely have problems with signal transmission unless your cables are either damaged or too long. Please remember that SDI cables use locking connectors and will not simply pull out if they are jerked or tripped over. They are a significant trip hazard, and also a hazard to your equipment, which may be damaged if the cables are mishandled or of a low grade. Please ensure you test and check your SDI cables for 4K. For longer runs, cables of a Belden 1694A specification are recommended.

■ Standard 1/4" Mount/Arm

The Shogun 7 includes 1/4" -20 screw mounts top and bottom, along with ARRI's anti-rotational pin system for secure mounting to a wide range of arms, mounts and cages. It is compatible with the latest mounting solutions from companies such as Shape, SmallRig and Wooden Camera. Select the mount type that best suits your input device, application and conditions.

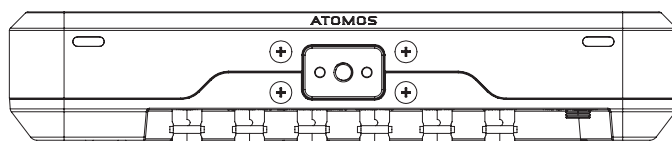
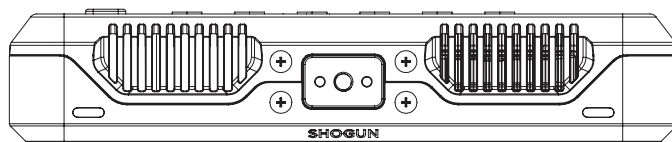

Below are some examples of tripod and hot shoe mounts, available from most camera and video specialists.



A secure mount will greatly enhance usability and security of HDMI, power, remote and audio connections. Related info on page 10.

3. Mounting disks in the Master Caddy II

Mounting drives in the Master Caddy II

If you choose to use your own disks instead of a pre-built AtomX SSDmini, follow this procedure to install it in the provided Master Caddy II.

Insert the disk into the caddy, and secure with four screws. These screws should be tightened so the screw heads are flush with the casing of the caddy. The caddy is light and the disk just needs to be held securely. Don't over-tighten the screws. There are no connections to make because sliding the Master Caddy II into the Shogun 7 or the docking station makes all the connections for you.

The Master Caddy can't be inserted the wrong way round. Always make sure that the disk connector faces the slot in the Shogun 7. Push the Master Caddy II into place, but never force the disk just in case something isn't set up or aligned properly.

There is very little that can cause problems and the most likely thing is that the Master Caddy isn't properly flush with the drive inside. A quick visual check will confirm this.

- ⚠ *SSDs and spinning disks are very sensitive to damage from static electricity. Please observe all the usual precautions when handling them. DO NOT touch the exposed SATA connector as static electricity may be harmful to your disk.*
- ⚠ *Master Caddy II drives are backwards compatible with previous Atomos recorders, however Master Caddy 1 is not forward compatible with the Shogun 7 due to the compact latch design.*

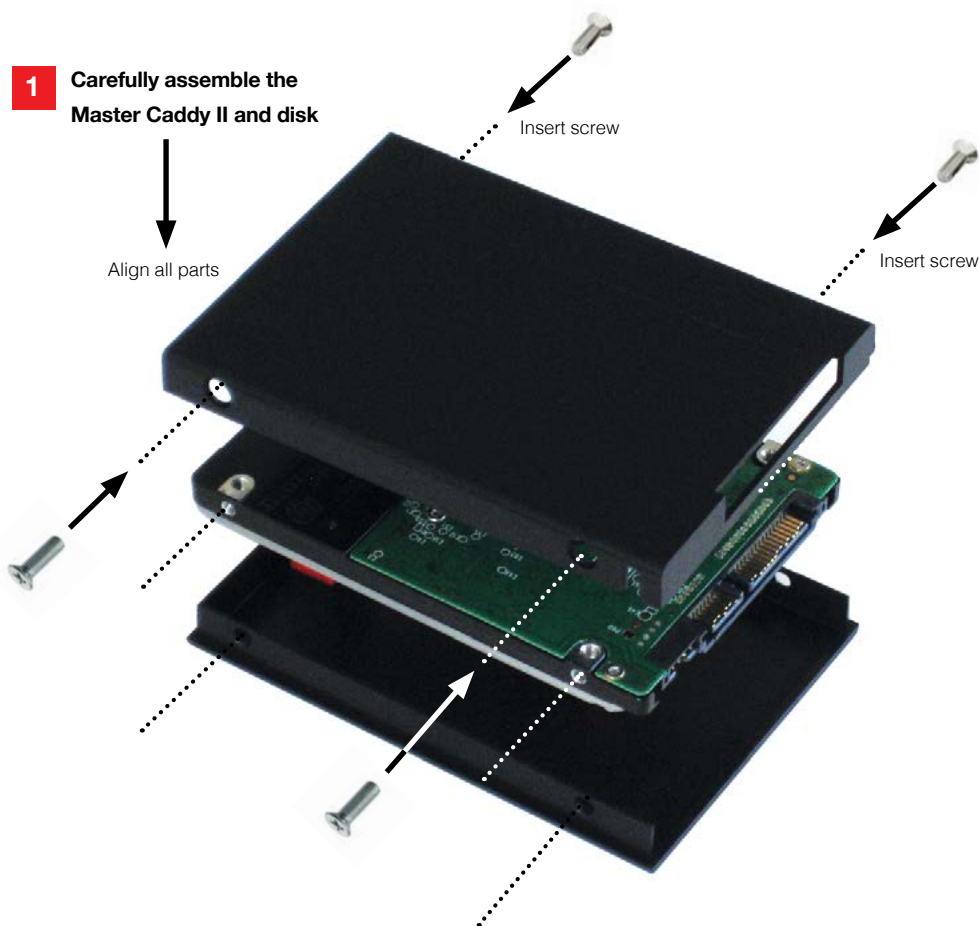

2 Ensure all 3 parts aligned and insert 4 x screws (supplied)

Do not over-tighten screws or alignment can not be guaranteed. We suggest squeezing the corners together near the screw you are tightening for optimal fit.

- ⚠ *If using Master Caddy II with Shogun 7 ensure all screws are tight and not protruding from casing. Loose screws may cause the caddy to become lodged in the disk slot.*

4. Powering the Shogun 7



Choosing your power source

The Shogun 7 can be powered by the included AC-powered adaptor, or by using a compatible DC battery. If you are the owner of other Atomos devices, the batteries you have for these devices (NP-F series) will be compatible with your new Shogun 7.

Batteries

We recommend the use of optional Atomos NP-F type batteries and the Atomos Power Kit with the Shogun 7. The Shogun 7 can also use standard NP-F compatible batteries. Charge new batteries before using them, using a compatible battery charger. To attach the battery, gently slide it down into the slot until it locks into position. To remove a battery, push the latch to release it.

⚠ Before any type of disposal the battery should be discharged completely. Tape the contacts with electrical tape and package so as to prevent contacts accidentally coming together at any time.

Incineration must be performed by an approved and permitted waste treatment facility that handles lithium ion batteries. If you are not sure if your waste facility can handle lithium ion batteries, contact them and verify if they are permitted or not.

Atomos NP-F Battery Charger (optional)

The Atomos NP-F Battery Charger has been designed to rapidly charge the batteries yet be lightweight so that is easy to travel with.

⚠ In the unlikely event of a charge error the first and fast red LEDs flashing quickly.

Fast charging of the battery is possible up to 80% capacity and the remaining 20% will then charge at a slower rate to maintain good battery life.

⚠ Batteries do not charge in a linear way. At first they charge very quickly, and then the rate slows down to a trickle. While charging, one or more red lights will blink. When 90% charge is reached, all the lights will flash. It is perfectly OK to use the batteries at this point and we recommend stopping at this stage for the longest battery life. If you leave the batteries on charge after all four lights are flashing, the charger goes into trickle charging mode for the final 10%. When trickle charging is complete and the batteries are at 100% charge all the lights will go out.

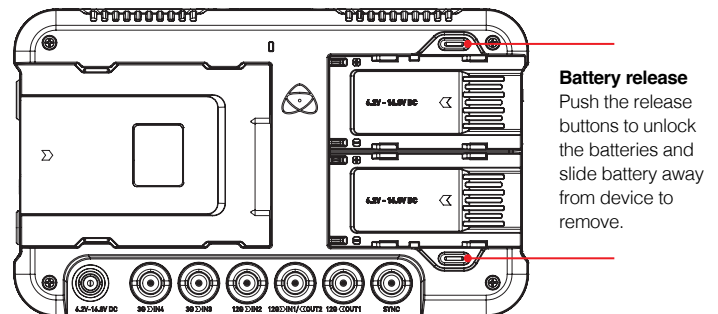
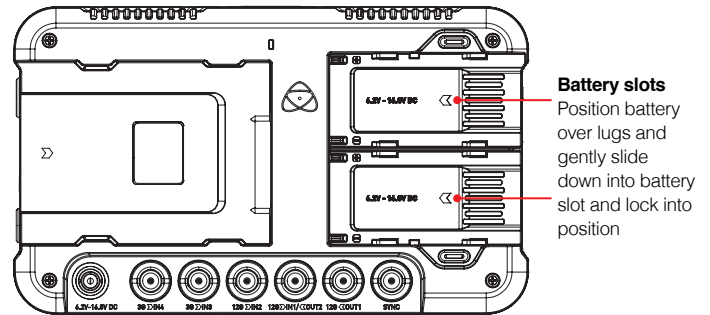

Choosing the right battery for your application

Size	Cells	Battery Life*
5200mAh	4	Up to 1hr 10minutes
7800mAh	6	Up to 1hr 50minutes
D-Tap	-	Source dependent

* Battery life tested during Monitor/Record 4Kp60 operation (AtomOS10.2).

⚠ We recommend using Atomos NP-F series batteries.

DC to D-Tap Coiled Cable

An optional Atomos accessory is a DC to D-Tap Coiled Cable.

This is designed to allow you to power your device from an external battery system. To use this simply connect the D-Tap connector to your power source. Ensure that the output of the power source does not exceed 16.8V DC.

Shogun 7 batteries are held in place tightly because they are on the outside of the device. To ensure that there is no possibility the components are able to come loose, you may have to be quite firm with the battery latches. We suggest that you familiarize yourself with the force required to remove the batteries and accessories so that you can do this quickly in the field.

4. Powering the Shogun 7

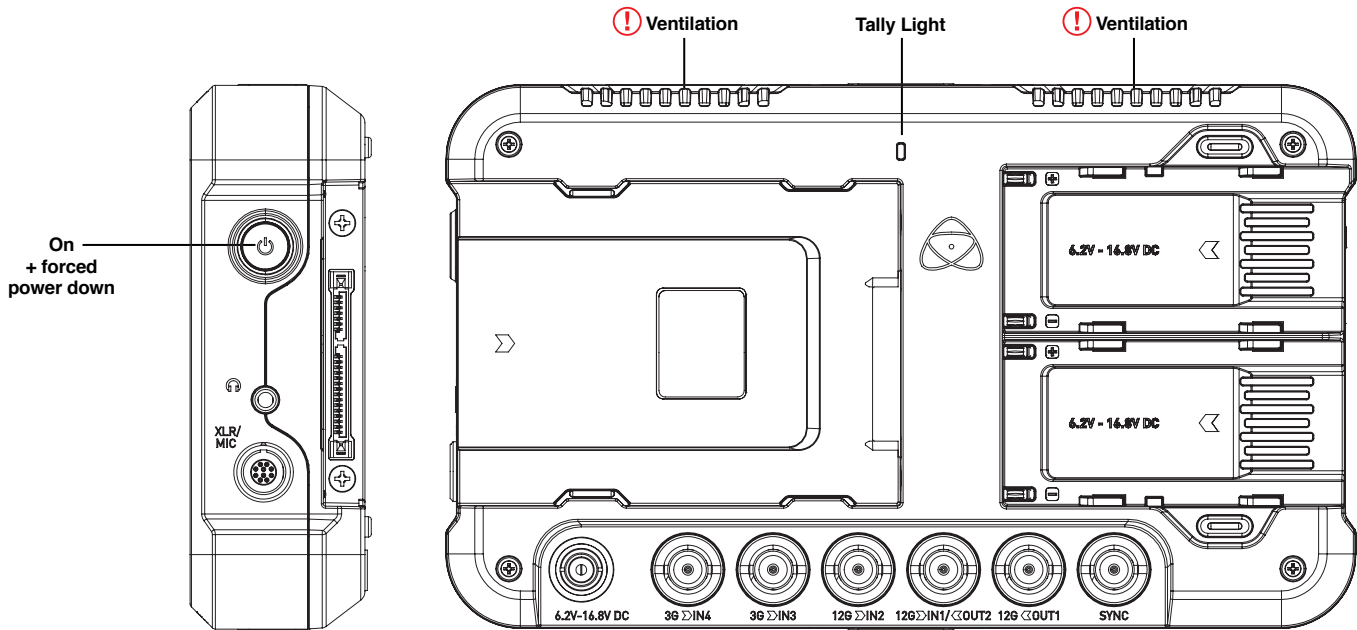

Turning ON power to the Shogun 7

The start button is located on the top right hand side of the unit (as you look at the screen). With a charged battery attached momentarily press the recessed circular button on the top right side of the Shogun 7 as you look at the screen to power up the unit. After a couple of seconds you will see the Shogun 7 Home Screen.

Turning OFF power to the Shogun 7

To turn the unit off, touch the **battery** icon on the top right of the main screen (monitor mode) or bottom right (homescreen mode), and then press the **red Power icon** for 4 seconds. The icon will go red when touched to indicate activation of the button. The unit will then power off. You can also do a forced power down by **pressing the on/off button for four seconds**.

Battery - Menu Screen

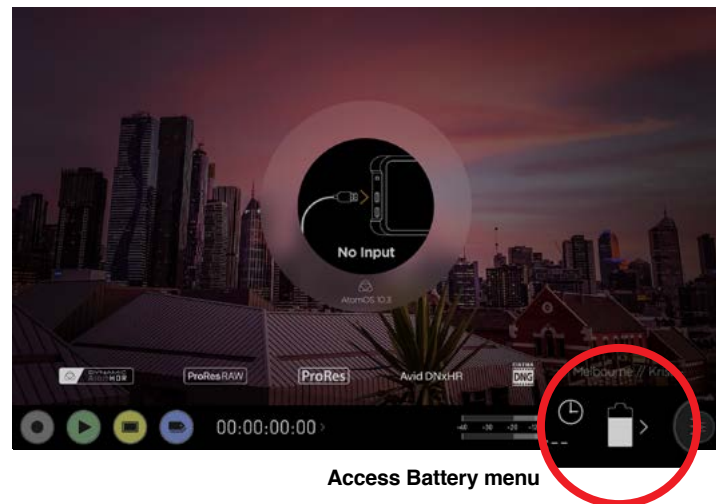

Four seconds can seem like a long time! We've made it this way to make absolutely certain that the Shogun 7 can't be turned off accidentally.

Do not press and hold the power button in on the Shogun 7 while the unit is off. This will place the device in to a Firmware recovery mode. If you accidentally do this, simply turn the device off again or remove the power source.

Take note to respect the air flow and do not to obstruct the cooling vents of the unit.

If a mounting solution obstructs the vents, consider mounting the unit upside down and using the Flip Screen feature to re-orient the display.

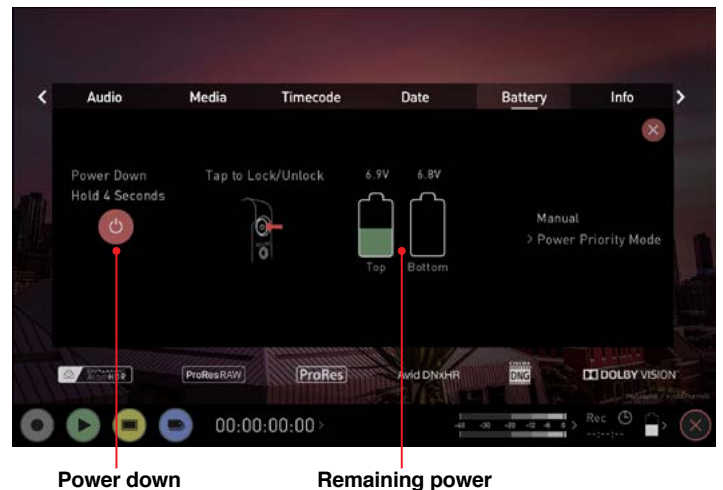

5. Shogun 7 Connections

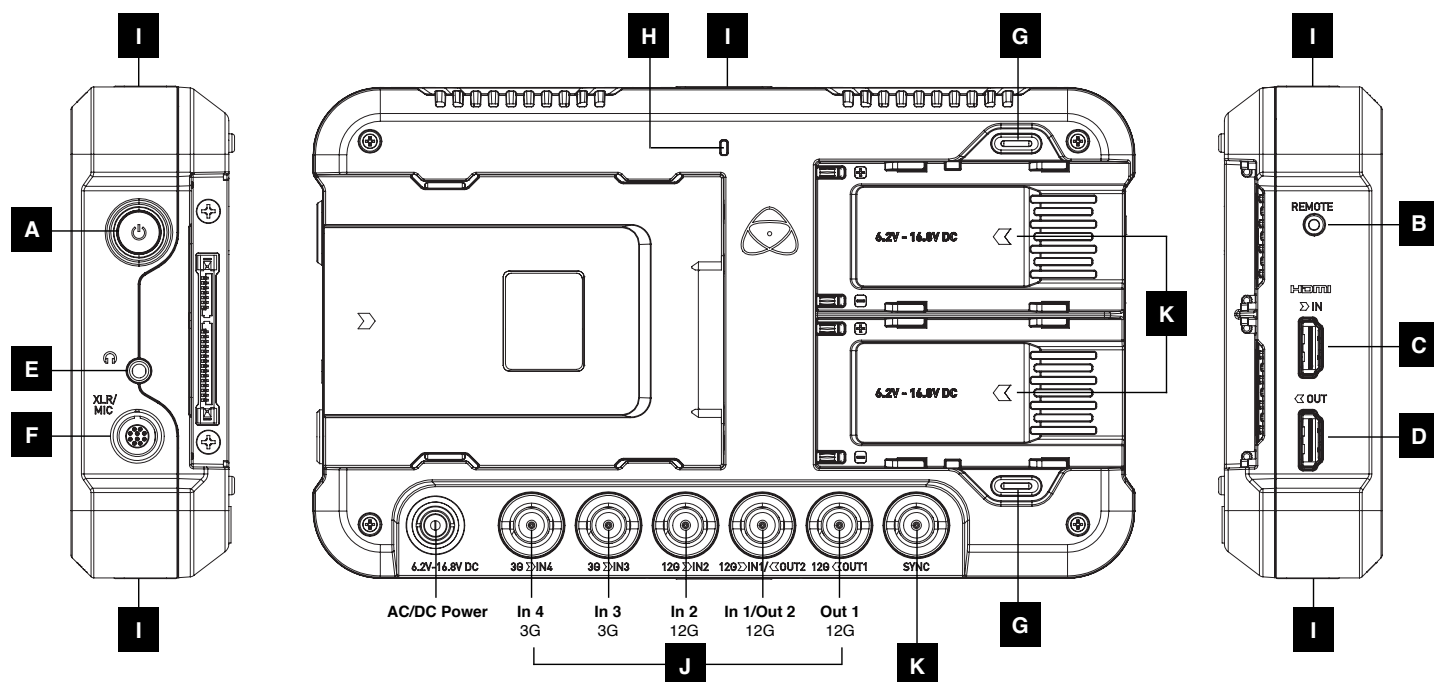

A. On/Off and Screen Lock

To turn on, press the power button on the side of the unit. To shut down, hold the button for at least 4 seconds (until unit turns off). LOCK: Tap to lock screen, tap again to unlock.

B. Remote Control

Optionally control the Shogun 7 using Remote from your camera. Additionally, calibrate using the X-Rite i1Display Pro.

The calibration 2.5mm jack on the left hand side (looking from the front), allows for the connection of supported calibration devices with support now available for the retail version of the X-Rite i1Display Pro as well as legacy Atomos Spyder Calibrator. Both units utilize the optional USB to serial adaptor cable. The latest version of the Atomos Calibration software is available at www.atomos.com/support

C. HDMI In

The video input is a full size HDMI 2.0a connection used to receive the video and when supported by your device embedded audio and Timecode. This is both displayed and recorded to the Atomos recorder/monitor storage media.

D. HDMI Out

This is for connection to an external monitor or other device with an HDMI input. It carries a loop-through of the incoming HDMI or SDI signal in record and standby mode, and the playback signal when the Shogun 7 is in playback mode. This output is 2.0a and can carry either a 4K or HD signal (with the option to down convert the 4K input to HD).

The SDI <-> HDMI conversion is always live allowing for instant conversion without any setup.

E. Headphone Output

A 3.5mm headphone jack is located under the power button. Channel selection and volume for headphone monitoring is via the audio controls section in the lower left hand side of the touchscreen.

F. XLR/Mic (Analogue audio)

On the side of the Shogun 7 unit is a multi-pin connector in to which the XLR break out cable can be connected. A 2 in 2 out XLR cable is available as an optional additional accessory. The inputs can be configured at Line, Mic and Pro level in the Audio menu. The inputs can also provide 48V Phantom power to compatible microphones.

The XLR out puts are available via the optional 2 x 2 XLR cable accessory for monitoring and the audio channel routed to them can be selected via the headphones selection in the Audio menu.

G. Battery Release Button

Press the release buttons and slide battery away from unit to remove.

H. Tally Light

Red tally light on the rear of the unit indicates active recording. Tally light can be turned off in the menu options.

I. Screw holes and ARRI anti-rotational pin system

J. BNC Connectors

The SDI input connections are 12G compliant and backwards compatible meaning that it can be used for 12G, 6G, 3G and 1.5G signals. The SDI inputs support 3G in both level A and B standards. This input is also used to input RAW signals from supported cameras.

K. SYNC: Genlock in / LTC rec.

Located with the SDI inputs and output is an additional BNC marked SYNC. Genlock is short for "Generator Lock" in video systems. The Genlock is an input only and will lock the internal timing system in a video device to an external reference signal during play back.

The Sync BNC can also be used as a LTC Timecode input. This allows for external LTC timecode to be used enabling multiple devices to be sharing the same master timecode signal, which makes it perfect for multi-camera setups. LTC is only available in Record mode and can be accessed via the Time code menu

6. AtomX SSDmini, Master Caddy II and Screw Mounts

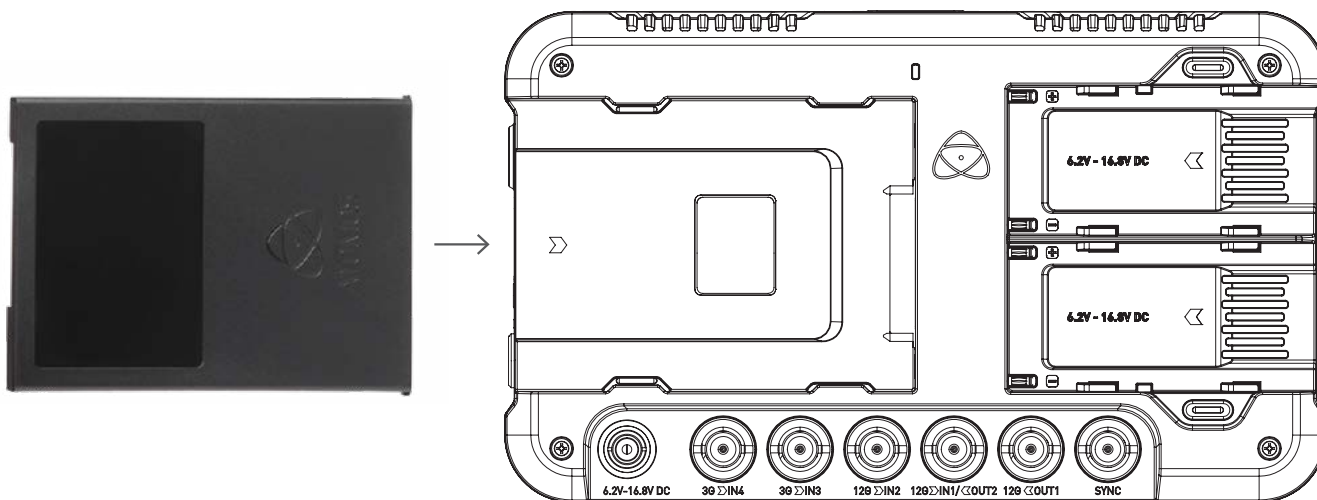

Master Caddy II Slot / AtomX SSDmini

On the rear of the unit is a 2.5" slot designed for Master Caddy II or AtomX SSDmini. To insert your caddy or SSDmini, gently push until it stops at the end of the drive slot.

The SSDmini and Master Caddy II are both hot-swappable, so you can do this at almost any time – even while the unit is turned on. But don't do it while recording or you will get a corrupted file that may be unplayable.

⚠ The Shogun 7 disk slot does NOT have a release latch - it is friction fit. Simply pull the SSDmini / Master Caddy II out using the top and bottom tabs on the caddy itself.

AtomX SSDmini is backwards compatible with previous Atomos recorders. The original Master Caddy 1 is not compatible with Shogun 7 as the keyways are on one side only.

AtomX SSDmini Handle available. Attach to SSDmini for use with existing Atomos Master Caddy II compatible devices, and reduce handling and potential damage to disk casing.



Mounting options

The Shogun 7 includes 1/4" -20 screw mounts top and bottom, along with ARRI's anti-rotational pin system for secure mounting to a wide range of arms, mounts and cages. It is compatible with the latest mounting solutions from companies such as Shape, SmallRig and Wooden Camera. Select the mount type that best suits your input device, application and conditions.

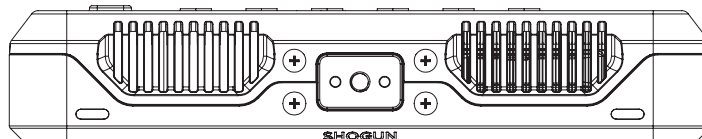

Top view

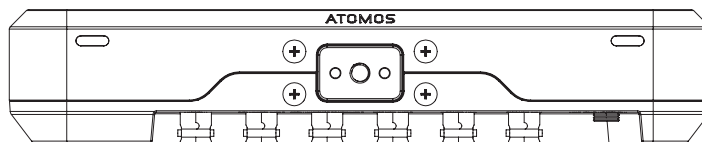

Bottom view

⚠ Ensure you do not over tighten the screw mounts as this may cause damage. Do not insert a 1/4-20 thread longer than 5mm or you will risk causing damage to the aluminium screw mount.

SHOGUN 7

With the introduction of AtomOS10 operating system for Shogun, there have been some significant changes in the way we do things compared to our previous models – especially in the overall look and feel, the placement of buttons, and the way that AtomOS10 works.

With AtomOS10, you get the ultimate touch interface for monitoring and recording. This new version of our operating system has a clear, elegant design. It's easy to understand yet gives you total access to all functions. No complicated sequences of buttons. No endless menus crowded with text. It's optimized for our latest AtomIC hardware platform. And it's extremely responsive with fast boot up times.



7. Using the Shogun 7 - Best Practice

Understanding the basic controls and ‘housekeeping’ functions will save you time in the future. Before you start enjoying your Shogun 7 it will help to set it up with a ‘device name’ and file naming conventions.

- a. Format Media
- b. Unit Name
- c. File Naming
- d. Screen Lock
- e. Firmware Updates

a. Format Media (HDD/SSD)

Make sure your drive is correctly inserted and all data from previous shoots has been securely backed-up. Touching the **Storage Capacity Indicator** on the home screen will take you to the Media Menu.

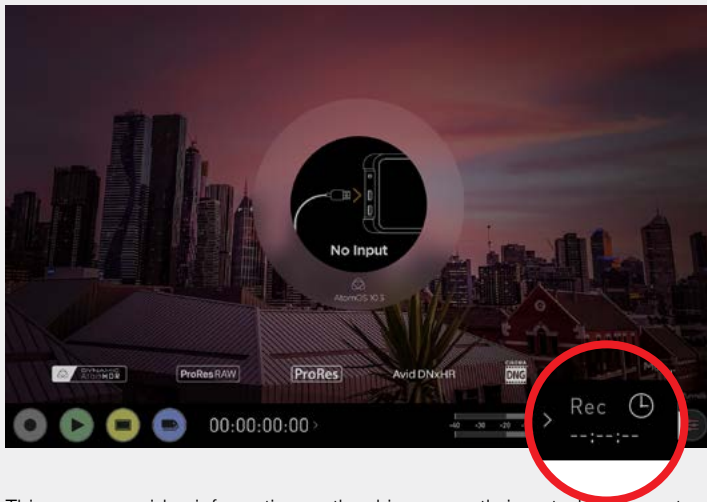

This menu provides information on the drive currently inserted. To format the drive touch the **Format** button (below).

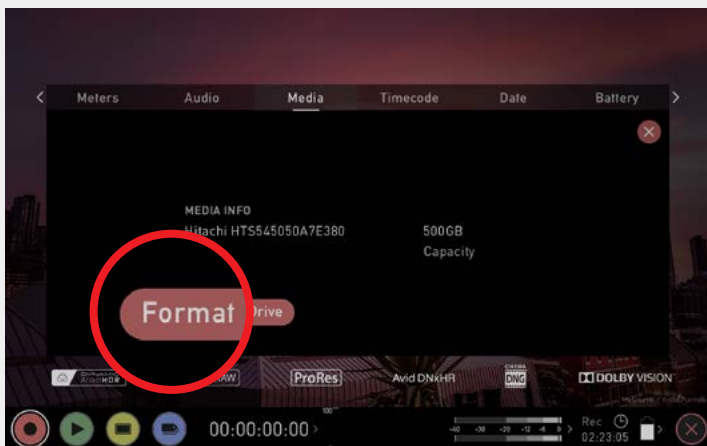

A confirmation screen will give you the choice to continue or cancel the process.

! If you do not see your hard drive information, there may be a problem with the connection or drive. Try removing the drive and reattaching the drive. Ensure correct alignment of Master Caddy II or SSDmini.

! The Shogun 7 uses the exFAT file system for broadest compatibility.

Secure Erase Format

For drives that carry the Atomos Logo such as the G-Technology 4K SSD, Angelbird 4KRAW, AtomX SSDmini by Angelbird and Sony, an option for secure erase is presented. This allows for the entire drive including the drive cache to be formatted. This will erase ALL content on the drive meaning nothing can be recovered. The benefit of this is to optimise performance. It will wipe all data off the drive (which may also be useful as a additional security measure) and reset it back as close as possible to factory conditions.

! When you first insert a drive you may be presented with “Invalid media”. This display means that the drive has not yet been formatted and you simply need to follow the process to format your drive

7. Using the Shogun 7 - Best Practice

b. Unit Name

To access the unit name tap the **input settings** from the home screen Information bar.

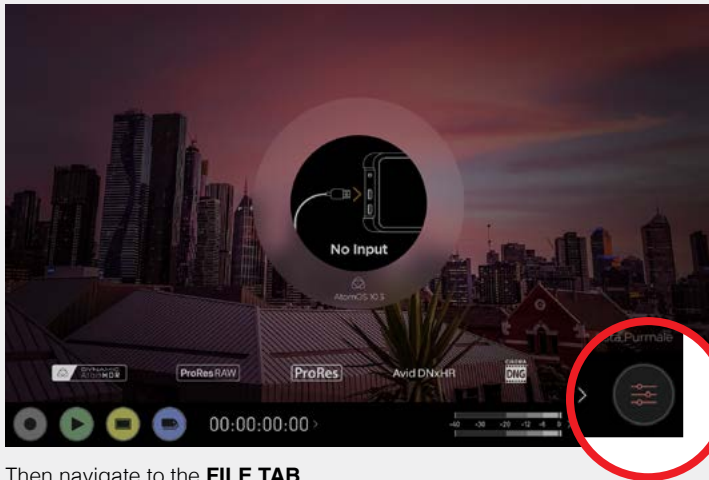

Then navigate to the **FILE TAB**



The unit name serves two main purposes:

- **Drive Naming:** Giving the unit a unique name aids with identification. Once you have given it a name all drives subsequently formatted in the Shogun 7 will bear this name as a prefix.
- **File Naming:** File name is the current unit name as the start of the recorded clip name; *SHGN7_S001_S001_T001*

c. File naming

Create your own unit name by pressing the arrow to change and enter the letters in. Pressing OK will allocate the new unit name and return you to the menu screen.

This process can be very useful when using multiple devices or with multicam shoots. Good file management now will save you valuable time in post production.



- Using the **Select <>** choose the letter to update. The character you are updating will display in the Letter indicator.
- Use the **Letter - +** to change the character. When the correct letter is displayed, use the select control to move to the next character.



- Scene and shot can also be set using the + - controls. Take is automated.

When **changing the drive** please ensure that you take note of the last scene and take number so you can append this as formatting a drive will reset the scene and take counter to 001,001,001.

d. Screen Lock

Lock the Display Screen

You can lock the display of the Shogun 7 by tapping the power button. This will ensure no changes can be made by mistakenly touching the screen. The screen lock function will simultaneously lock or unlock both Channels of the Shogun 7.

Short tap the power button again to unlock the unit.

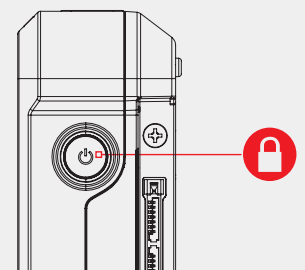
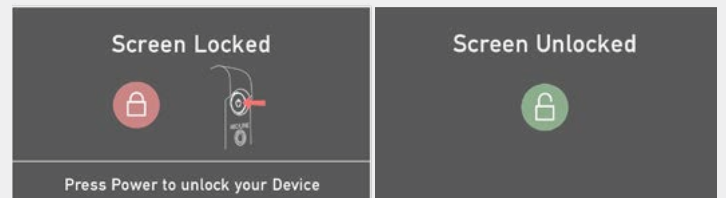

The lock screen can be combined with the display off function so that when lock is engaged the display is turned off. The Tally light on the front of the unit will still display Rec (Red) or idle (green) status. Locking of the display can be found in the Monitor Mode.

7. Using the Shogun 7 - Best Practice

e. Firmware Updates (AtomOS)

From time to time we will issue software updates for your Shogun 7.

To update the firmware (that's the software that runs inside your Shogun 7), there is a simple procedure you have to follow.

• Check your current Firmware version

Navigate to the Info tab by first pressing the settings button or the timecode, battery, media and then navigating through the menu. If at first you do not see the info tab, swipe the tabs bar to the left to reveal more menus and settings.

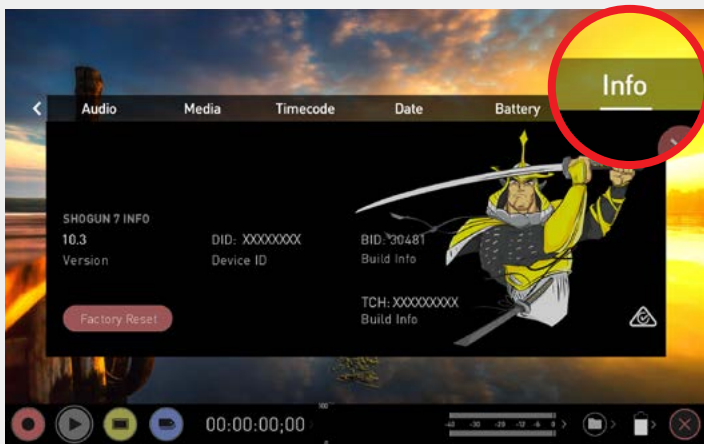

 **Swiping left to reveal more tabs, more icons, and more settings is a new feature of AtomOS10. If you cannot find the menu you are looking for, swipe left or right.**

The info screen contains the firmware version number and other important information about your Shogun 7. To determine if your device is up-to-date or if a firmware update is required, do the following:

- Go to www.atomos.com/support
- Follow links to FIRMWARE/PRODUCT MANUALS
- Select SHOGUN 7 from the dropdown menu.
- Locate and compare the latest version with the version currently running on your Shogun 7. If you do not have the latest version installed, download the firmware upgrade and follow these steps:

1. Extract the file ATOMSG7.FW from the firmware zip file.
2. Copy ATOMSG7.FW onto a AtomX SSDmini, or to a SSD in a Master Caddy.
 - a. Atomos recommends you use a freshly formatted compatible drive.
 - b. Always format your drives in the Shogun 7 first. The Shogun 7 formats the drive for optimal performance for video.
 - c. Ensure that the firmware update file is on the root of the drive, and not in a folder on the drive.
3. Use a freshly charged battery on your Shogun 7 or connect to mains power. It is very important that your Shogun 7 does not lose power during a firmware upgrade.
4. Power down your Shogun 7.
5. Insert the Master Caddy or SSDmini with the ATOMSG7.FW file.



6. Power up your Shogun 7 with a short press of the Power Button.
7. Watch the screen. The Shogun 7 'Updating firmware' message will appear and the firmware upgrade will start.
8. While the firmware upgrade is happening, a progress bar will be displayed.
9. The firmware upgrade may take up to a few minutes.
10. When the firmware upgrade is finished, the Shogun 7 will:
 - a. Automatically delete ATOMSG7.FW file from your drive.
 - b. Power itself down.
11. Turn on your Shogun 7 again with a short press of the Power Button located on the side.
12. When the Shogun 7 has booted, Press the Settings Button and then select the Info tab and check that the version number is the version expected.

⚠ **IMPORTANT: Problems when installing AtomOS**

Very rarely, the firmware update process can go wrong. This might be because of an incomplete or corrupted download.

In the unlikely event of your Shogun 7 becoming unresponsive, there is a built-in recovery mechanism.

All you have to do is press and hold the on/off button for 10 seconds. If you do this your Shogun 7 will revert to its factory condition, and you will be able to retry the firmware update later (taking due precautions to identify and remove possible reasons for the failure of the previous attempt).

 Please ensure your batteries have plenty of charge and that you do not interrupt your Shogun 7 while its firmware is upgrading. You will see a progress bar to the lower half of the screen. When it is finished, the Shogun 7 will restart and you will be able to use the device as normal. This process can take up to 5 minutes.

 Please make sure that the firmware file is not renamed when you computer unpacks the ZIP file. If you have other firmware in the same folder, the file may become renamed to SHGN7.FW when unzipping and the update will not work.

 If you place the .FW file on the drive and insert this in to the Shogun 7 whilst it is turned on, the device will recognise the firmware update and ask if you'd like to apply the update. If you select "ok" the device will shut down and begin the update process.

7. Using the Shogun 7

The Main Screen - Information Bar

At the top of the Shogun 7 screen is the area referred to as the **Information Bar**. Info here relates to the settings of your input device/camera, Shogun 7, media, audio and more. Touching any of these areas will take you to the relevant menu. More info on page 19.

The content of the Information Bar is dependent on what mode you are in, for example Recording and Monitoring will display the Video Input type, but if you are in Play mode, Video Input will show the resolution and frame rate of the video clip currently cued or playing.

Monitor Mode / Info

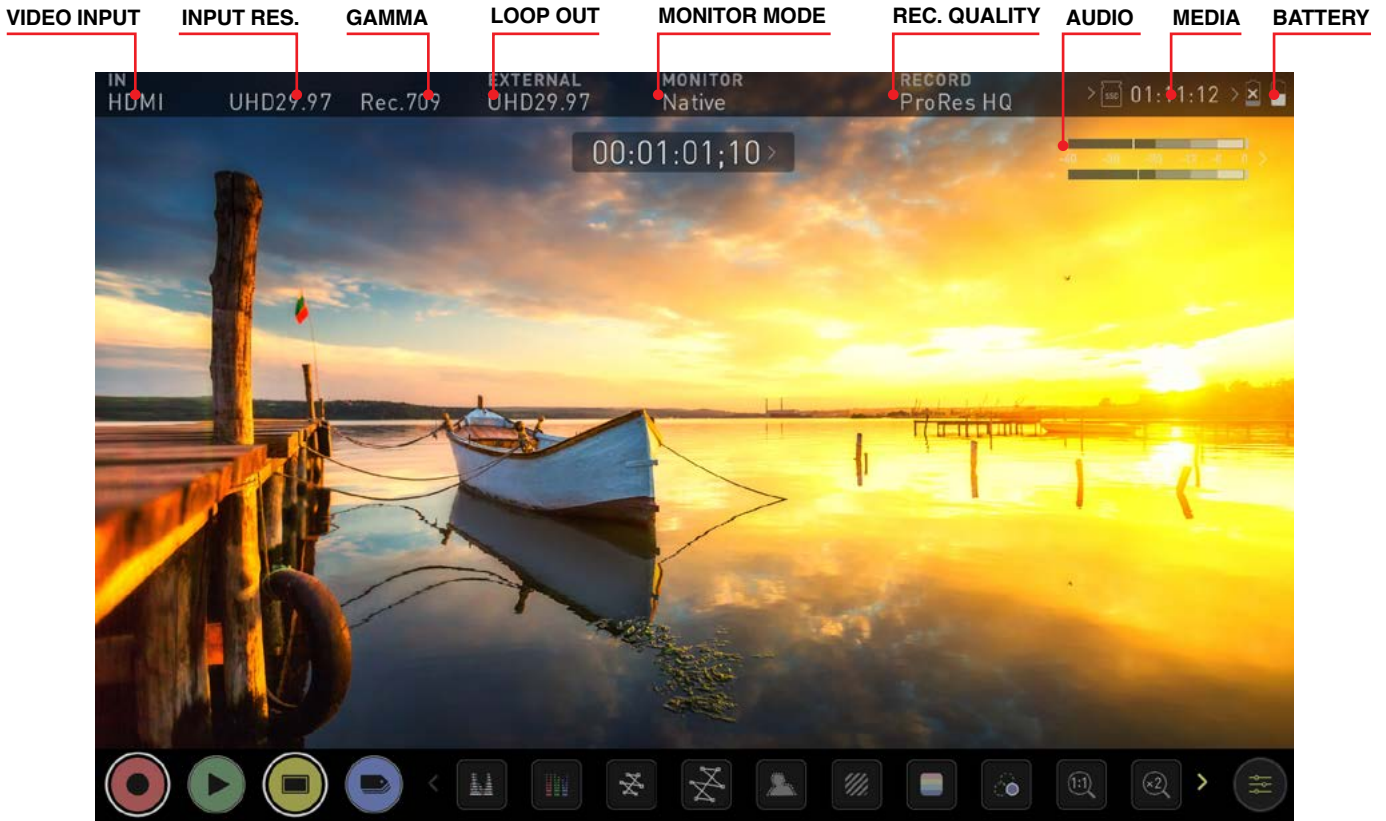

ABOVE: UNIT ENABLED WITH INPUT AND OUTPUT, READY TO RECORD SIGNAL OR PLAY LAST RECORDED FILE FROM DISK









- IN HDMI** **VIDEO INPUT:** (Rec & Mon mode)
Resolution and frame rate from input device
- HDp29.97** **INPUT RESOLUTION:** (Play & Edit mode)
Resolution and frame rate of current playback clip
- Rec.709** **MONITORING GAMMA:**
Shows current gamma input applied to the signal from the source device. Touch this control to ensure it matches the output coming from your camera or other input device. During playback mode this setting will be determined by the recorded content.
- EXTERNAL HD29.97** **VIDEO OUTPUT:**
The active video format being output from HDMI.
- MONITOR Native** **MONITORING GAMMA:**
This shows the gamma which should be set to be the same as the source device. Touch this control to ensure it matches the input coming from your source device. During playback mode this setting will be determined by the recorded content.

- RECORD ProResHQ** **CODEC (RECORDING FORMAT):**
Shows the recording format. Touch to change settings.
- Audio meters** **METERS:**
Audio Meters. Touching the audio meter will open the Meters Menu.
- 09:10:45** **MEDIA / RECORD TIME:**
This shows the remaining recording time based on the chosen codec and remaining capacity of the drive.
- Battery icon** **BATTERY:**
Touch to access Power Menu. Battery Indicator shows power level and flashes red when power is running low.
- Settings icon** **SETTINGS (yellow):**
Touch to access Monitoring Feature settings.
- MON icon**
Touch MON again to return to previous screen. You will find the EDIT button works in a similar fashion, and that it is not possible to have Monitor and Edit active simultaneously.

7. Using the Shogun 7

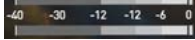
Monitor Mode / Home



-  **REC (Record):**
Press to begin recording. Jump to Record Home Screen.
 -  **PLAY:**
Jump to the most recently recorded clip on the Playback Home Screen.
 -  **MON (Monitor):**
Press once to show **Monitoring Features** and **Information Bar**.
Press again to return to monitor home.
 -  **EDIT:**
Press to show **Editing Features** and **Information Bar**.
Press again to return.
- 00:01:18:37 >**
- TIMECODE:**
Shows the selected time code such as embedded, time of day or rec run.
- 
- LUMA WAVEFORM:**
Luma Waveform is now a constant on your homescreen. Allows for greater control over monitoring without compromising the subject.
- 
- AUDIO:**
Audio Meters. Touching the Audio meter will open the Audio Menu.
-  **TIME REMAINING:**
Time Remaining on Disk (at current record settings). Changing Recording Format will change Time Remaining.
-  **BATTERY:**
Touch to access Power Menu. Battery Indicator shows power level and flashes red when power is running low.
-  **SETTINGS (red):**
Touch to access all Recording settings, including input, output, file, media, gamma, gamut, and more.
-  **REMOVE OVERLAYS:**
It is possible to remove all overlays by touching the center of the screen. Touch again to return.

7. Using the Shogun 7

The Main Screen - Monitoring Features



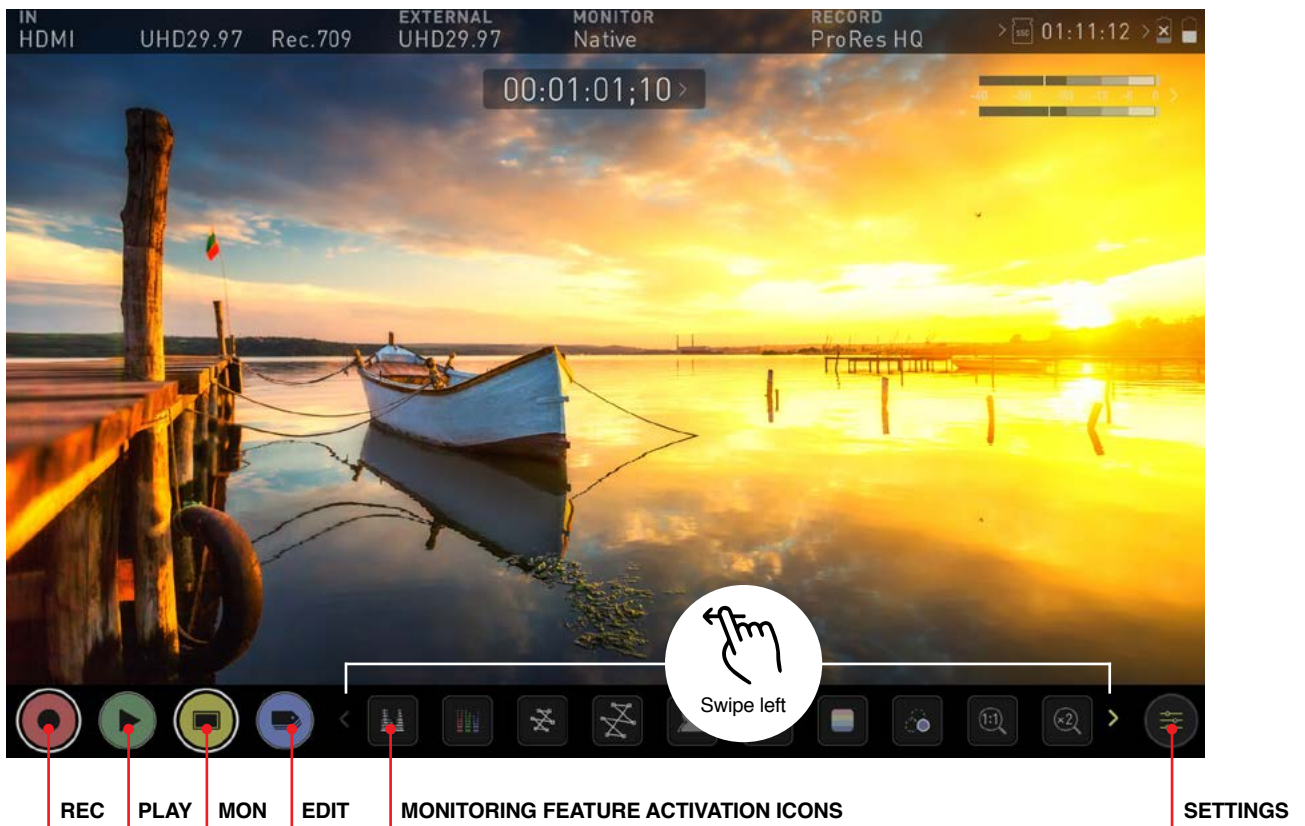

At the bottom of the Monitoring screen are the Monitoring Features, accessible by toggling the MON icon. Monitoring Features do not affect your recorded file and can be turned on and off, or adjusted whilst recording (unless you choose to burn a LUT file into your footage). Not all Monitoring

features are available at first glance – to reveal all Monitoring features, swipe monitoring icons to the left. The icons will behave in a carousel like manner and you can swipe left and right to access any of the features. At the bottom right is the Settings button. Press Settings to adjust behaviours of Monitoring Tools.

Monitor Mode / Info



Main Controls

-  **REC (Record):**
Press to begin recording. Jump to Record Home Screen.
-  **PLAY:**
Jump to the most recently recorded clip / Playback Home Screen.
-  **MON (Monitor):**
At this screen, press once to revert to home screen view.
For Monitor settings press the Settings button. Any Monitoring functions you have enabled will remain active until deactivated.
-  **EDIT:**
Press to show **Editing Features** and **Information Bar**.
Press again to return to home. Any Monitoring functions you have activated will remain active until they are turned off.
-  **SETTINGS (yellow):**
Touch to access Monitoring Feature Settings. Set histogram sizes, adjust transparency, LUTs, Focus Peaking and more.

MONITORING FEATURE ACTIVATION ICONS:

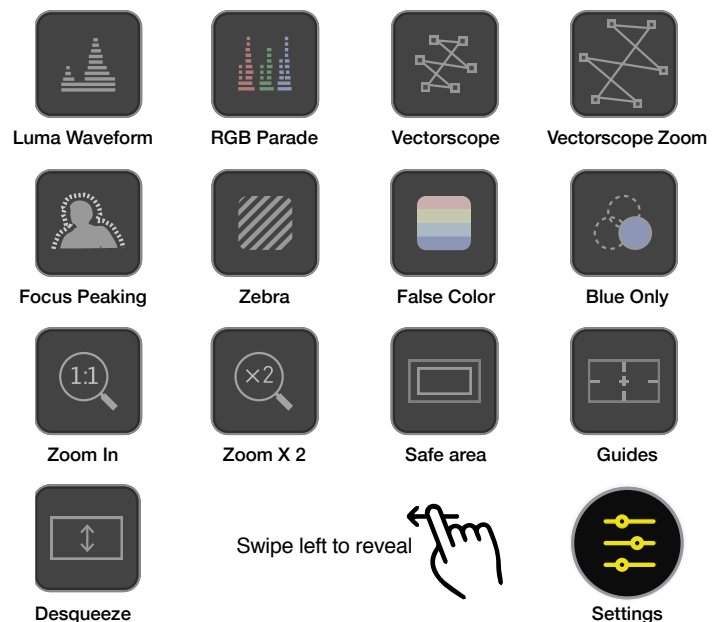

7. Using the Shogun 7

Home screen and menu functions

REC (Record)

This is the icon you touch to begin a recording. Touch it again to stop a recording. While recording the Rec icon changes to a Stop icon and a red frame is present around the screen.

Standby



Recording

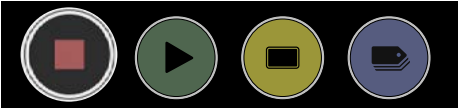

No input / No media



The Rec icon is dimmed and disabled if there is no valid video input OR, the disk is not formatted, or the disk is full. The button is dimmed because you cannot record.

PLAY

Touch this icon to play previously recorded clips. When you press the green Play button the Shogun 7 will switch to playback mode and automatically play the last recorded clip.

Playback mode

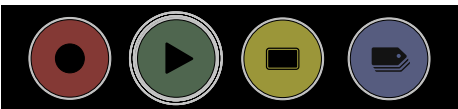

No disk / disc not secure





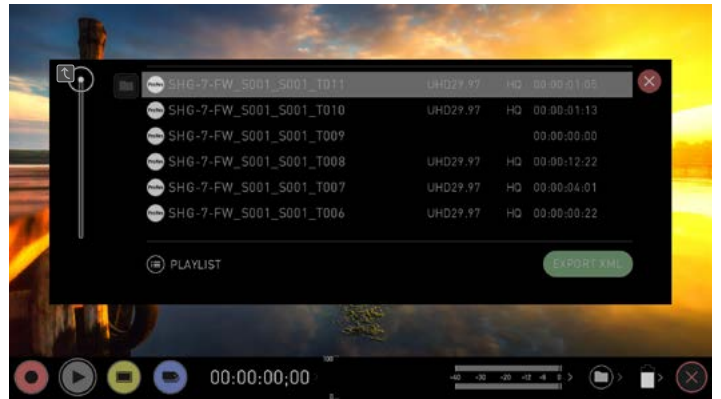

The Play button will be dimmed and disabled if there is no content, no disk, a poor connection or the disk is not correctly formatted. **See page 14 - Format Media**

Playback Home screen

Touching the folder icon will reveal the available playlist. See next image.



Shogun 7 uses a unit name, scene, shot and take convention to name the clips. Select the clip you want to play by touching the file name and this will start to playback. To exit the playlist simply touch close, or any other button. Touching close will take you to the previous window.

-  Close playlist
-  folder level up
-  Playlist options
-  EXPORT XML
- Export .xml file. More info later

MONITOR

Pressing MON reveals Monitor Assist icons as shown on previous page. These features are explained in detail on page 25. Toggle mode by tapping.

Monitor mode



Monitor

Home screen



EDIT

You can use the edit tools during recording and playback. Pressing EDIT takes you into a number of options which will be explained on page 37.

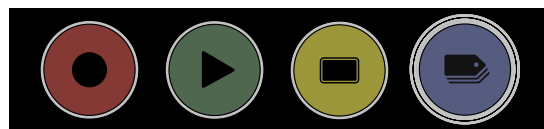

7. Using the Shogun 7

Information Bar - Adjust your settings

The **Information Bar** of your Shogun 7 displays the settings of your input device/camera, current settings of your Shogun 7, media, audio, disk capacity and more. Touching any of these areas will take you to the relevant menu and allow you to make changes to your setup.

Alternatively you can access these settings by tapping the Record Settings icon. Tapping the Settings button will open the Record Settings menu, from where you will be able to navigate to the required tab. Swipe left to see more tabs.

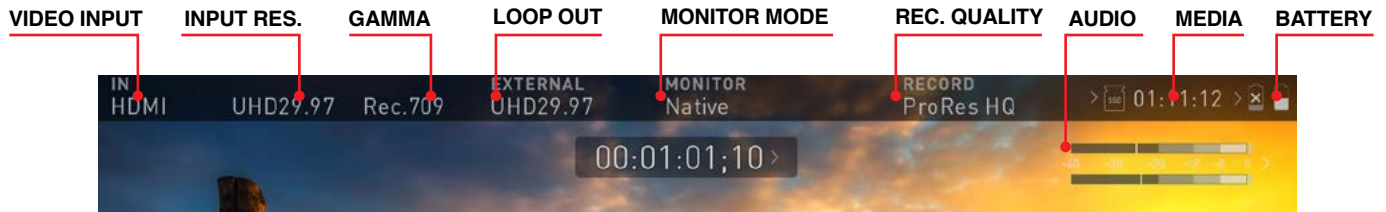

Input

Video Input

Simply tap the source input menu to the top left of the screen to bring up the input control panel. This panel is a command center for all devices connected to the Shogun 7 and will assist you with connectivity by indicating if the signal is active or if attention is required.

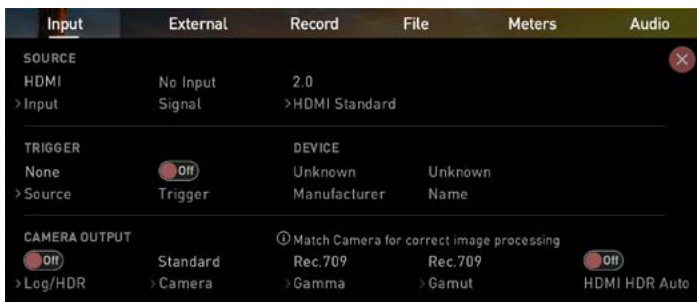

SOURCE Input

To switch between different sources, tap the word "SOURCE". You can switch the input signal between SDI 1, HDMI and SDI 2

SOURCE Signal

Displays the current input signal format, including framerate, resolution and scan mode.

SOURCE Standard (HDMI only)

When the input signal is HDMI, the option to change between HDMI 1.4 or HDMI 2.0 is available by tapping on "HDMI Standard".

SDI MULTILINK

The Shogun 7 supports dual and quad link SDI input. By default, SDI sources will use a single input signal, to switch to Dual or Quad link, tap Mode under SDI MULTILINK. When using Multilink each input must be the same framerate/resolution and synced to a

reference signal. Only channels 1 and 2 of SDI embedded audio, plus analogue audio are recorded in multilink mode. When in Multilink mode you have access to all monitoring, recording and output features available in single channel mode. The SDI signal over IN1 will act as the master reference for Timecode and Trigger in both Quad and Dual link modes.



Single Link

Select channel Source – 1 or 2.



Dual Link

To monitor or a record a dual link SDI signal, connect the SDI inputs to the 12G inputs IN1 and IN2, 3G IN3 and IN4 are unused in Dual Link mode. When a Dual Link signal is detected, the indicators for channel 1 and channel 2 will be green.



Quad Link

When the device set to Quad Link mode, a 4x 3G or HD SDI signal can be received. SDI input signals must be

7. Using the Shogun 7

connected in the correct order to input IN1, IN2, IN3, and IN4 to use Quad Link. When a Quad Link signal is detected, the indicators for channels 1-4 will be green.



TRIGGER

The Shogun 7 can be remotely triggered to record from your camera. Select the correct triggering option for your camera and set Enable Trigger to ON.

DEVICE

HDMI Devices will display an EDID Device name if the information is available from the HDMI device connected. Not all cameras carry an EDID device name. For cameras such as the Panasonic Lumix GH5 this will display as 'Unknown'.

A green tick on Source indicates the Shogun 7 has locked signal on this input, a red cross indicates a signal or lock issue with the attached device, double check your cable and camera output settings.

CAMERA OUTPUT

For the best image processing results it is essential to match the Shogun 7 settings to the camera/input settings. Choose to use Log/HDR, camera type, Gamma, Gamut or enable HDMI HDR auto if required. Your Shogun 7 will recognise most cameras when correctly attached via a compatible HDMI cable.

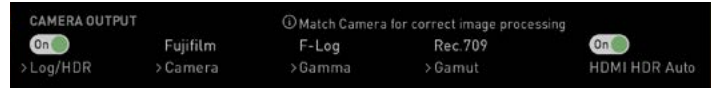

Log/HDR:

Turn on to enable HDR image processing inside the Shogun 7. Bring the control of post into your shoot - record, preview and review using HDR.

Camera:

Tap to scroll through to the manufacturer of the camera providing the input. Sony, Fujifilm, Canon, Panasonic, ARRI, RED and JVC.

Gamma (Log Gamma Format):

For each manufacturer there may be a number of different Log curves available and you can scroll through to the correct selection by tapping the Gamma icon.

Gamut:

Select the Color Gamut of the input. This is not applicable to all cameras but again ensure that this matches the input of the camera to ensure accurate monitoring.

HDMI HDR Auto

HDR is detected when there is a compatible input signal. It is important that this is OFF if the camera is not outputting HLG or PQ. It should not be used for regular Log.

About Log/HDR

A better understanding of Log and HDR will enhance your workflow and ultimately allow you to capture maximum amount of detail during recording, and save you time in post production. To understand more about the importance of this function please see page 33.

7. Using the Shogun 7

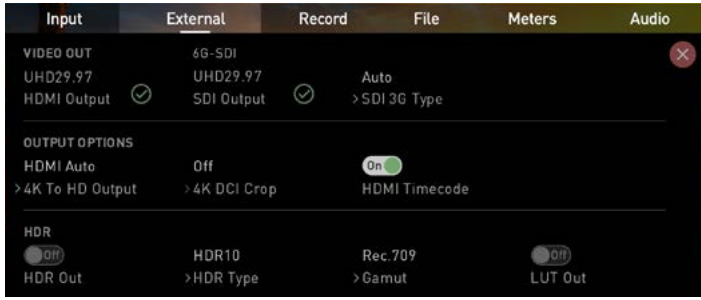

External

External

This menu displays the active video format being output from HDMI. A 4K to HD down conversion can be applied to the output. This enables you to send a 4K input signal to a HD device. When working in HDR a signal will be output with the correct HDR flag to activate a compatible HDR display's settings. This can be useful if you wish to monitor log footage in the studio.

VIDEO OUT

this option will show the resolution of the Input. When processing options are applied below it will be adjusted accordingly.

OUTPUT OPTIONS

4K or UHD inputs can be scaled for output using the first option. This will scale 4K to 2K and UHD will be scaled to HD 1080p. The 4K DCI crop will trim the 17:9 DCI input to 16:9 converting the signal to UHD or with the other option selected down scale to HD.

4K DCI Crop

Crop the output signal from UHD 4K down to DCI 4K

HDMI timecode

Allows for the embedded time code or in unit generated time code to be looped out. The option is present to allow you to turn the time code of as this can disrupt some consumer equipment that is not intended to receive embedded timecode.

Audio Embed

Choose the audio channels to embed for output.

HDR

Here you are able to set a conversion from your LOG input to a HDR display standard such as HLG or PQ. You can also define the output color gamut from your camera's gamut to a display standard for BT2020, DCI-P3 or Rec709.

Record

Record

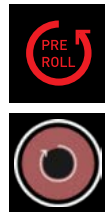

Pre-Roll

With this option turned on you will see a red Pre-Roll icon flash in the top left hand corner and a white circular arrow around the record button. Whilst enabled the input is constantly been recorded with approximately the last 8 seconds in HD and 2-3 seconds in 4K being cached into memory. The frame rate and codec selected will determine the number of seconds being cached for Pre-Roll. Using a lower bit rate codec setting and shooting at lower frame rate will increase the length of Pre-Roll.

When the record button is pressed or trigger is sent, the buffered Pre-Roll data in memory will be written out to the start of the recording. This means if you are few seconds slow hitting the record button when something interesting happens you will still capture the shot.

 *With Pre-Roll mode activated the recorder is constantly caching frames internally to the unit and as such any feature that can not be changed whilst recording is disabled. This includes audio channel select, 3D LUT record, codec, disk options etc.*

CODEC (Recording Format)

To select a codec simply tap on the currently displayed codec to toggle between ProRes, ProRes RAW or Avid DNxHD*. The Quality menu allows you to toggle codec compression.

- **Apple ProRes** HQ, 422 & LT
- **Apple ProRes RAW** RAW, RAW HQ
- **Avid DNx** 220x, 220, 145, 36
- **Avid DNxHR** HQX, HQ, SQ and LB

The expected record time available from each codec selection is automatically calculated from the available space on the media inserted.

 *More information regarding Apple ProRes and ProRes RAW data rates can be obtained online from Apple ProRes whitepaper documents.*

** If Avid DNxHD / DNxHR is required, you must activate it first. This can be done at www.atomos.com/support*

7. Using the Shogun 7



Record

PULLDOWN

The record menu allows you to apply pulldown removal if recording from a source that applies pulldown to the output signal. Note for 3:2 Pulldown removal, movement in the frame may be required to accurately lock signal, simply wave your hand in front of the camera to achieve lock. See **page 44** for more details on pulldown removal.



SPACE REMAINING

Indicates the total recording time remaining on your HDD/SSD media at the current settings. Changing your recording settings may extend or decrease your available recording times.

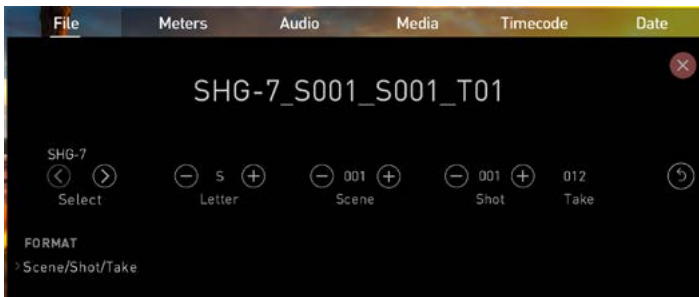

File

File Naming

Allows you to dictate the scene and shot number that will be recorded as well as the ability to change the unit and media name. By default unit will be named SHG-7.

To change the unit name tap the arrow under UNIT/MEDIA NAME, Use the left and right arrows to select a letter, and the up and down arrows to change it's value. Refer page 13 for more info.

To modify the scene and shot number under File Naming, select plus or minus next to scene or shot (up to 999). The number you choose will then be shown in the file name at the top of the screen during recording, the take number is automatically increased with each take.

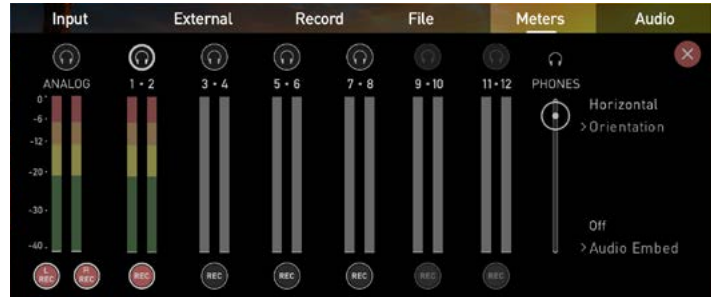

Meters

Meters

The meters and audio settings are easily accessible by touching the audio meters (shown below) on the record, monitor and playback home screens. Touching the meters will take you directly to the Meters menu. From this panel you can manage up to 12 digital channels (via SDI input) and 8 digital channels (via HDMI input) as well as 2 analogue audio channels (via the XLR Mic/ Line in).

For monitoring the audio there are two types of display available. Access this setting on the meters page. Options available are:

Horizontal

Displays the 2 channels you are actively monitoring.

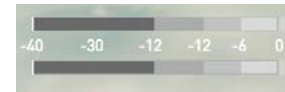

Vertical

Displays 12 channels + 2 analogue channels.

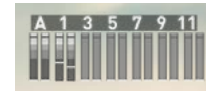

Monitoring Audio

To monitor the audio, tap the headphone icon above the channel you wish to monitor from the headphone output. Only one channel (stereo pair) may be monitored at any time using headphones (you can monitor all visually). It is possible to record multiple channels by checking multiple REC buttons

🚩 *Selecting the Monitor icon does not mean that track is selected to be recorded. You need to select each channel using the **REC** record button. Tracks that are selected to be recorded have colored Audio Meters. See image above.*

🚩 *Please note that if analogue audio is recorded it will be placed as track 1-2 with embedded audio moving to 3-4. Note if analogue channels are turned on but no audio is present, in many video players you will not hear silence as they often just play the first stereo pair. In an NLE you can easily access all the recorded tracks.*

7. Using the Shogun 7

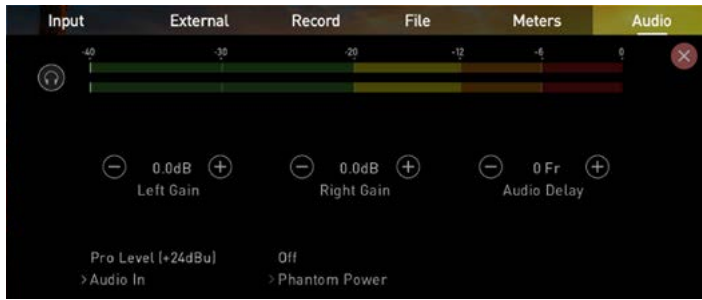

Audio

Audio

Audio Input Options

To adjust the gain on the analogue input you need to bring up the audio options page by pressing in the lower right corner of the audio menu to select the input line Level to match your device.

Options available are:

Line Level (-10 dBu)

Sets the analogue input channel to Line Level via the XLR breakout cable.

Mic Level (-40 dBu)

Sets the analogue input channel to Mic Level via the XLR to XLR connector. With Mic Level selected you also have the option to provide 48V phantom power should your microphone require it. Please only use this when your microphone supports it and if unsure please consult the manual for the mic you are using.

Pro Level (+24 dBu)

Sets the analogue input channel to Pro Level Audio via the XLR breakout cable. Analogue gain can then be tuned by incremental increase or decrease of up to +/- 20dB individually for both left and right channels.

 *It is not possible to vary the gain if the signal input is from the HDMI connection because this is digital and is embedded in the signal. You can usually adjust this from the camera, please see your camera manual for operational details.*

 *Shogun 7 Mic input supports dynamic and powered microphones only. When using these, audio must be set as Mic Level*

Audio Delay

This option allows you to delay the Audio to be in sync with the video by adding in frame delays.

Audio during Playback Mode

When you enter into Playback mode on the Shogun 7 it will only output channels 1/2 on the headphones, please bear this in mind when you select the audio channels for recording.

Phantom Power

You can choose to deliver phantom power over the XLR/MIC input.



Media

Media

Media menu shows current media type and capacity. Format disks from this menu. See Format Media on page 12. Information about compatible drives is available at atomos.com/drives

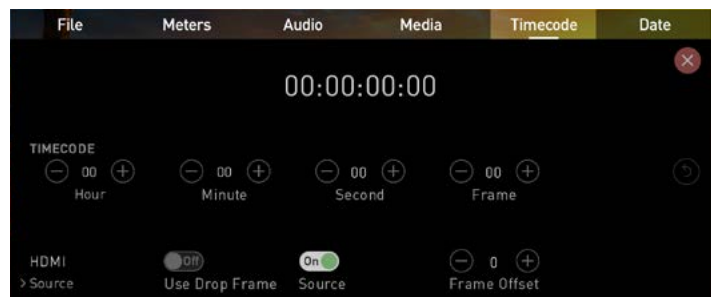

Timecode

Timecode

Using Timecode

The timecode display changes position depending on the screen mode you are using. In monitoring mode it appears in the center top, below the info bar. In home screen mode the timecode display sits on the bottom near the REC PLAY MON EDIT icons.

Touching the Timecode display on the home screen, just below the information bar will take you to the Timecode setup screen.

00:00:15:00

The Timecode modes supported are:

- HDMI (Embedded)
- Record Run
- Time of Day
- Auto Restart
- LTC

Cycle through these modes by touching the Timecode Source Selector.

Timecode modes:

HDMI embedded Timecode

With this setting, the HDMI input will use the Timecode embedded in the input signal. The controls to adjust the Timecode value are disabled in this menu as you will need to adjust these on the camera. Note that not all HDMI sources embed Timecode.

7. Using the Shogun 7

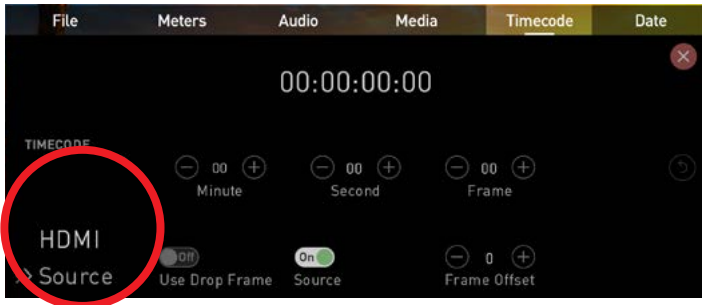

Timecode

Trigger from HDMI Timecode

If HDMI timecode is selected and the camera is in REC RUN mode, the user has the choice to start and stop recording remotely from the source camera timecode.

To enable rolling Timecode Start/Stop functions, simply set the HDMI Timecode switch to on. When enabled, pressing the camera Record Stop/Start button will make the Shogun 7 start and stop record simultaneously as the timecode starts and stops.

- When using the camera in Free Run timecode, the rolling timecode trigger might not work as expected.
- Note that whilst camera triggers are also looped out on HDMI not all wireless systems carry the trigger on to other devices so it's worth testing your system before a shoot if you plan to use it in this way to record proxies.

Time of Day

With this setting, each new clip that is created will contain embedded Timecode starting with the time of day when the recording is started. Please check that Shogun 7 clock has been set correctly.

This can be set in the DATE menu

- If recording is stopped and then restarted while in this mode, there will be a time gap between the last clip and the next one, equal to the length of time the Shogun 7 has been out of record.
- In Time of Day mode, the controls on the Timecode Setup Screen for adjusting the start-point of the Shogun's Timecode are not available, as the Timecode is set by the Shogun's internal clock.

Record Run

With this setting you set the starting Timecode for the first clip. The following clips will start at the frame immediately after the out point of the preceding clip. This will continue for all clips that follow. This is also known as continuous Timecode.

Auto Restart

With this setting, the Timecode will be reset to the Timecode you have defined whenever you press record. All your clips will start with this same Timecode.

- To adjust the Timecode use the "+" and "-" above and below the hour:minute:seconds sections

LTC

With this setting, the Timecode will be reset to the Timecode you have defined whenever you press record. All your clips will start with this same Timecode.

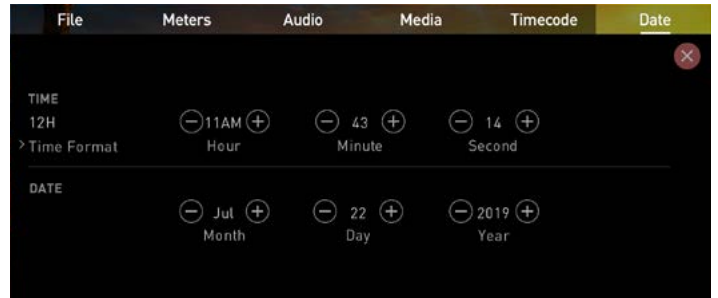

Date

Date & Time

Allows you to adjust the date and time shown by the clock in the Shogun 7. This will also change the time of day Timecode. Touching the Date & Time takes you into the Date and Time Screen.

Date formats (i.e. dd-mm-yyyy or mm-dd-yyyy) are selectable by tapping the blue arrow on "Select Date Format" Menu. Simply keep tapping until the desired format is shown. The Time, Month, Day and Year are selectable and can be modified by clicking the blue plus and minus icons next to the desired fields.



Battery

Battery

The Batteries screen indicator is made up of three icons, two will display the batteries and the other for the DC input. The active battery is shown in green and the level of the battery is shaded in 1/4 increments with a voltage level shown on top.

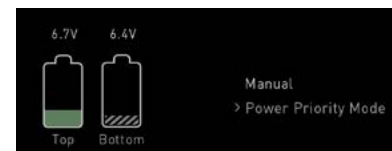

Manual Switching / DC / Battery

The Shogun 7 will automatically switch between connected power sources when the source in use is depleted. ie: DC > Battery auto switches.

- When a battery is running low the battery icon in the upper right corner of the screen will flash and warning menus will appear at 25% and 10%.

7. Using the Shogun 7



Info

Info

Shows the software (firmware) version and unique device ID (DID) of your Shogun 7 device. This will be required to activate the Avid DNxHD / Avid DNxHR codec. You can also check on the Atomos website to ensure you are running the latest firmware: www.atomos.com/support

8. Monitoring & Recording

Setting up for recording

As soon as you connect a supported signal to the Shogun 7 input and have inserted a formatted drive the following will happen;

- The **REC** icon will be illuminated (red)
- The input source & format will be shown in the top left corner of the information bar
- Audio input meters will be responding to source.

Ready to Record (monitor mode/features)



Ready to Record (monitor mode/home)



No Input / No Disk / No Disk Formatted



SmartControl

SmartControl is a versatile set of functions used to control the starting and stopping of recording by automatic or external means. This section outlines the different methods to start and stop recording.

Shogun 7 Start and Stop record control can be triggered by the following methods:

1. Home Page Touch Screen
2. HDMI Rolling Timecode trigger
3. HDMI Camera trigger
4. SDI Camera Trigger
5. Via LANC serial port

Some cameras perform optimally when triggering from the camera and not the recorder.

Start recording

1. Home page Touch Screen

By pressing REC (Record) and STOP to end recording



2. HDMI Rolling Timecode Trigger Record

If the camera is Record Run mode, recording can be stopped or started by a moving Timecode via HDMI. When enabled the camera and the Shogun 7 will start and stop recording simultaneously.

Rolling Timecode trigger is for use in older cameras with TC only and has no trigger. If your camera is set to FREE RUN this trigger will start recording immediately. Please be that aware not all cameras have Start/ Stop flags for triggering record, especially older cameras. In such cases rolling trigger in REC RUN will need to be used to trigger recording automatically at the same time as when the camera starts recording.

Input	External	Record	File	Meters	Audio
SOURCE					
HDMI	No Input	2.0			
> Input	Signal	> HDMI Standard			
TRIGGER					
HDMI	On	DEVICE			
> Source	Trigger	Unknown	Unknown		
		Manufacturer	Name		
CAMERA OUTPUT					
Off	Standard	Match Camera for correct image processing			Off
> Log/HDR	> Camera	> Gamma	> Gamut		HDMI HDR Auto

3. HDMI Camera Trigger Record

The HDMI Camera trigger is available for supported cameras, There is a flag within the digital signal that lets the Shogun 7 know the start/stop record has been pressed on the camera; in turn this will trigger the Shogun 7 to start/stop recording at the same time as the camera.

4. SDI Camera Trigger record

The SDI Camera trigger is manufacturer-specific, you will need to select the appropriate manufacturer for your camera from the input menu. There is a flag within the digital signal that lets the Shogun 7 know the start/stop record has been pressed on the camera; in turn this will trigger the Shogun 7 to start/ stop recording at the same time as the camera.

To enable this set TRIGGER to the camera manufacturer in the INPUT Menu. Ensure your source input is set to 'SDI' to enable options.

8. Monitoring & Recording

Monitoring Features

At the bottom of the Monitoring screen are the Monitoring Features, accessible by toggling the MON icon. Monitoring Features do not affect your recorded file and can be turned on and off, or adjusted whilst recording. Not all Monitoring features are available at first glance.





To reveal all Monitoring features, SWIPE MONITORING FEATURE ICONS TO THE LEFT. The icons will behave in a carousel like manner and you can swipe left and right to access any of the features. At the bottom right is the settings button. Press Settings to adjust behaviours of Monitoring Tools.







Monitor Mode / Features



Monitoring Features Activation Icons

AtomOS 10 features a new and improved layout of Monitoring tools. These can be toggled on and off simply by touching the large yellow MON icon. When Monitoring tools are displayed, swipe left to reveal more icons. Tapping on the icons will enable each features. Many of tools can be used simultaneously to assist with focus, exposure, framing and more. Here is a quick guide to what each icon represents.

- **Luma Waveform**
A great way to visualize the dynamic range of your image.
- **RGB Parade**
Monitor the level of red, green and blue from an input source.
- **Vectorscope**
This is useful for checking if an image is under or over saturated.
- **Vectorscope Zoom**
8x of the center of the vectorscope.

- **Focus Peaking**
Ensure your recordings are always in focus.
- **Zebra Pattern**
Use Zebra to check exposure and set exposure levels.
- **False Color**
A visualization of exposure across the image.
- **Blue Only Exposure**
Observe the noise content of a video image.
- **Zoom 1:1**
Punch in and check critical focus.
- **Zoom 2:1**
Toggle 2:1 to magnify the screen.

8. Monitoring & Recording



Cinema Guides

Cine or TV frame guides.



Safe Areas

Action area and title safe areas displayed.



Anamorphic Desqueeze

Allows you to see a correctly squeezed image when using anamorphic lenses

 The Monitor Features will only be illuminated and available if there is an input signal detected.

Waveform Monitoring tools

Luma Waveform

The Luma or Luminance Waveform is a great way to visualize the dynamic range of your image, allowing you to protect exposure of both your highlights and shadow detail. It's particularly useful when shooting with a low contrast LOG curve and works in perfect partnership with HDR to illustrate the highlight clipping point to allow you to correctly expose your image.



RGB Waveform

RGB Waveform will monitor the level of Red, Green and Blue from an input source. The RGB channels are displayed side by side and each channel color is shown under the corresponding waveform. This can be used to check to the white balance. Just point the camera at something white and the Red, Green and Blue levels should match if white balance is setup correctly on the camera.

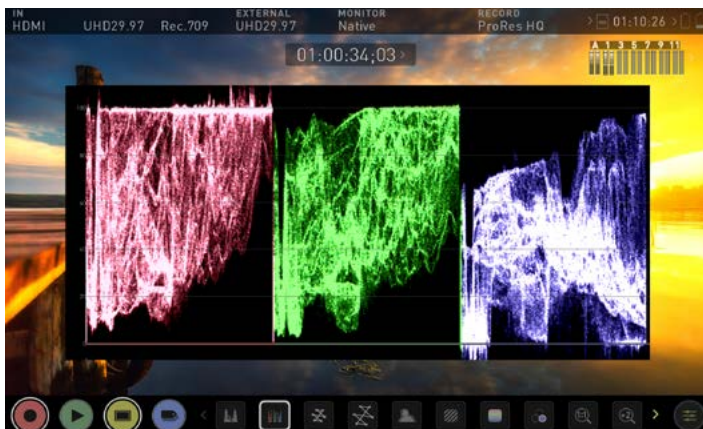

 The Waveform Monitor will remain on screen when hiding the overlays ensuring the focus remains on calibrating your image. If the MON button is pressed the WFM will move in to the bottom icon line up.

Vectorscope

The Vectorscope display shows color information of hue (shown as a phase vector), and saturation (measured by outward distance from the center). This is useful for checking if an image is under or over saturated and for calibrating multiple cameras to ensure greater consistency between shots.



Vectorscope Zoom

The Vectorscope Zoom shows a scaled up view (x8) of the center of the vectorscope.



Full vectorscope zoom view



Alternate 'small' view. See next page for vectorscope size and position.

8. Monitoring & Recording

Waveform

Waveform Monitor Settings

To access Waveform Monitoring settings simply touch on the Settings icon and select the **Waveform tab**.

To change the size of the waveform, press on the 1/4, 1/3 or Full

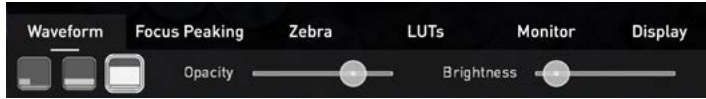

Screen icons and the display will update immediately.

Waveform Size settings



To toggle between Waveform Monitor sizes of 1/4, 1/3 and Full Screen during monitoring, recording and playback, tap in the bottom left corner of the screen. You can also adjust the brightness and opacity of the waveform display whilst recording, monitoring or during playback.

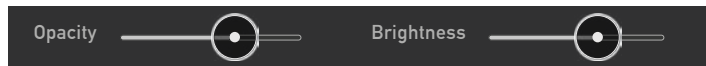

The Brightness slider directly controls the intensity of the waveform while the opacity slider adjusts the transparency values of the waveform display on screen. Experiment with these controls to achieve your desired monitoring setup.

Monitor Assist tools

AtomOS10 features monitoring tools that help with making your shot picture perfect. Easily access Focus Peaking, Zebra, False Color and Blue Only Exposure to check image is in focus, noise free and correctly exposed. Options for safe area/ title area markers along with aspect ratio markers and anamorphic desqueeze functions are also available.

Focus Peaking

Focus peaking allows the user to ensure their recordings are always in focus. The parts of the image in focus are highlighted by the selected color (can be adjusted by dragging the slider). To enable focus peaking tap then specify the mode in Focus Peaking settings.

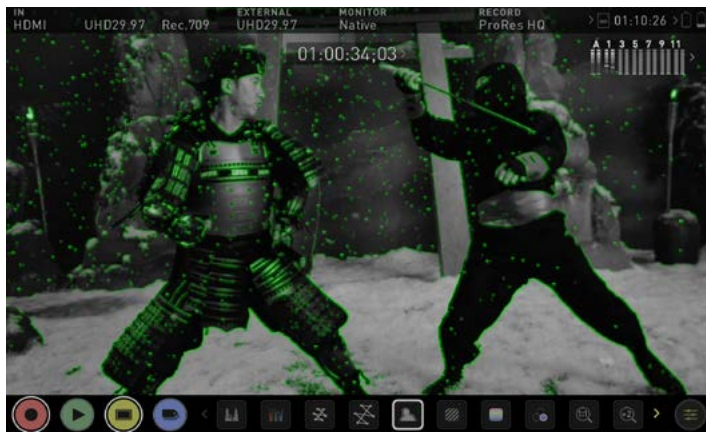

Focus Peaking

There are a number of options for how peaking is displayed, it can be overlaid over the color video image, over a greyscale image or just show the peaking by selecting the corresponding icon.



You can change the focus peaking colors and modes by touching the icons in the focus peaking menu.

Focus Peaking Color

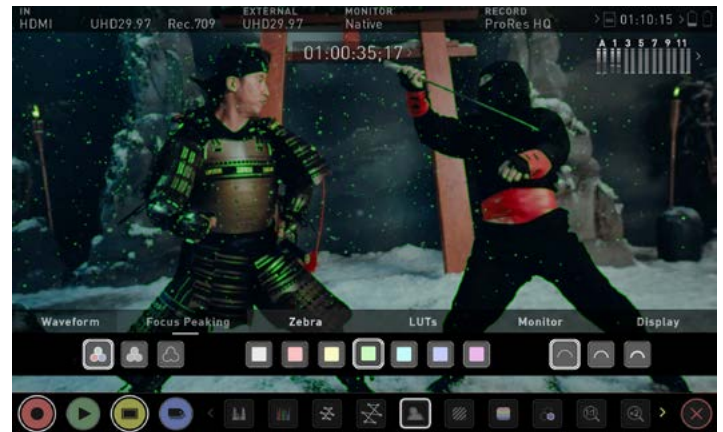

Focus Peaking Mono



Focus Peaking Outline



8. Monitoring & Recording

Zebra Threshold

Zebra pattern show the parts of the image that are exposed +5% of the target level set. The Zebra threshold value can be adjusted by moving the slider left or right.



Zebra

Access the Zebra Menu to change the Zebra threshold. 50% to 100% range available.

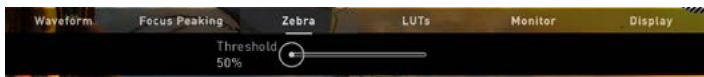

False Color

False Color assigns different colors to areas of different brightness in the image. This gives a visualization of what is going on with exposure across the image. There is a scale on the left hand side, overexposed elements will display as red, and underexposed elements will display as blue

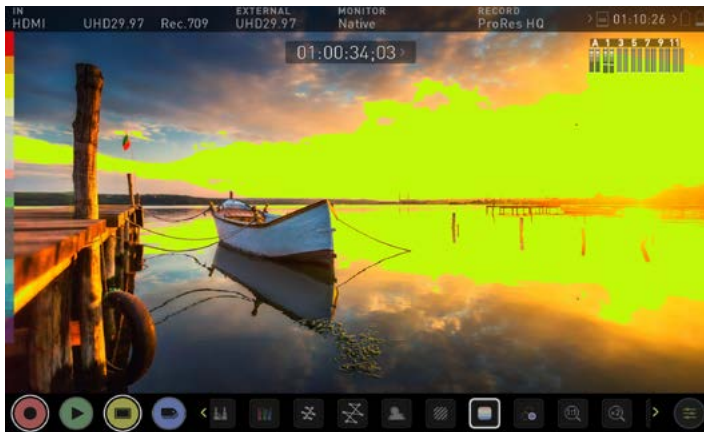

False Color Scale



Blue Only Exposure

Blue only displays a greyscale image based on the blue channel of the input signal. This is useful to observe the noise content of a video image as sensor noise is most visible in this channel.



Zoom

Zoom mode enables you to punch in and check critical focus

Toggle 1:1 to display 1:1 pixel mapping, the indicator box shows the location of the screen you are viewing.

- 4K 1:1 shows 1/4 of the 4K UHD image.

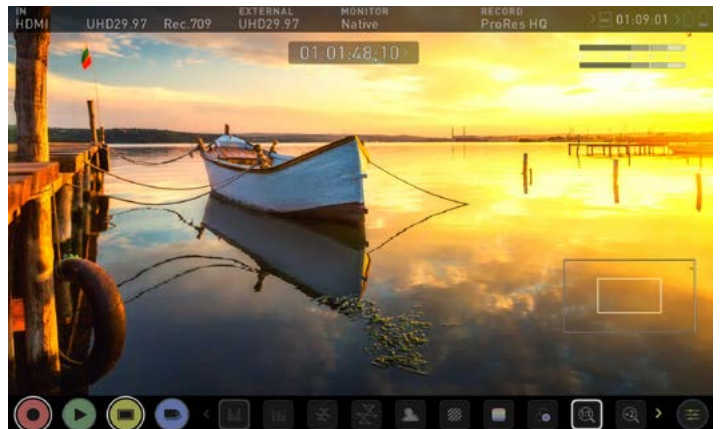

Toggle 2:1 to magnify the screen, the indicator box shows the location of the screen you are viewing, you can move the zoomed location by dragging across the screen or selecting a portion of the indicator box.

- 4K 2:1 shows 1/16 of the 4K UHD image.

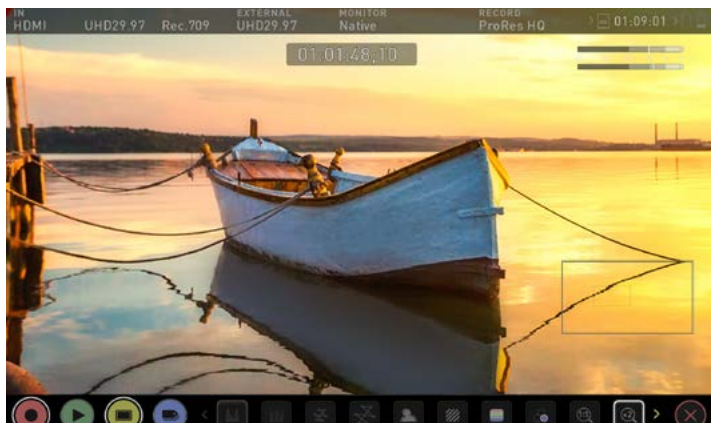

8. Monitoring & Recording

Cinema Guides



AtomOS 10 has advanced frame guides and safe areas. You can cycle through your required cine or TV frame guides by repeatedly pressing the guides icon. Cycle through options 16:9 / 2.41 / 2.35 / 1.9 / 1.85 / 4:3.

Safe Areas



Action safe area and title safe areas can then be turned on and are proportional to the frame guides based on SMPTE standards. To enable the guides press the Cinema guides icon to cycle through your chosen aspect ratio. The aspect ratio markers are very useful with the 2 x Anamorphic De-Squeeze to preview and crops that could be made in post. To turn on the safe area markers tap the Safe area icon once for the Action area and again for the title safe area.



Anamorphic De-Squeeze



Cycle through 2x 4:3 / 2x / 1.5x / 1.33x.

 *The Safe Area/Grid Lines will still be visible when tapping the center of the screen to hide the overlays.*

8. Monitoring & Recording

LUTs

A LUT or **Look Up Table** is a table that transforms the color response and as such adjusts the 'Look' of the input. 3D LUTs have a combination of three inputs defining the combination of R, G, and B values allowing for adjustment of not only color but also gamma and gamut. LUTs can also be used to monitor the input in a specific color space or more creatively to create a specific 'look' such as film stock emulation or to match cameras.



It's worth noting that not all LUTs are equal and the majority of LUTs are designed to work within the boundaries of REC.709. This means that whilst they may apply the color adjustments you are looking for they may also effect the luminance of the image and in which case these LUTs should only be used for delivery of content designed to be viewed in REC.709 or SDR. If you are working with 3D LUTs you can use color correction applications, as well as applications like Davinci Resolve, Photoshop or dedicated applications like LUTCalc to create your own custom Looks that can then be imported to your Atomos device. They can provide a great base or primary grade that allow you to apply an instant look to your footage.

Supported LUT formats

Atomos support 3D LUTs in the industry standard .CUBE format and provides 8 LUT memory slots for you to load your LUTs into. 1D LUTs are not supported and will need to be converted via 3rd party software to be imported.

To import LUTs into your Shogun 7 first copy the .CUBE files onto the SSD/HDD in your Master Caddy II using a computer and compatible dock.

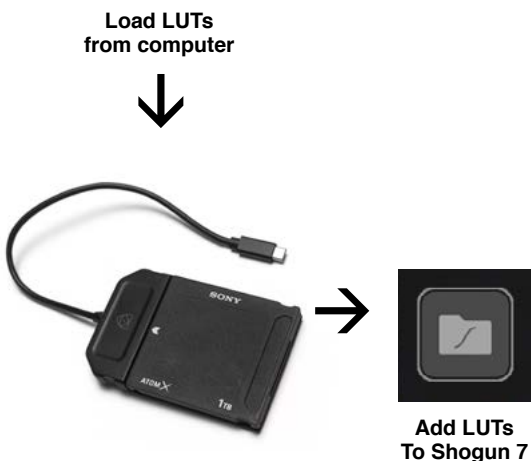

LUTs

Loading LUTs



To load a LUT select the desired slot (curve button) and press on the curve icon and then tap the folder file. Navigate via touching through the disk file system to the LUT file to be uploaded, press on the name to select the LUT and then again to import.

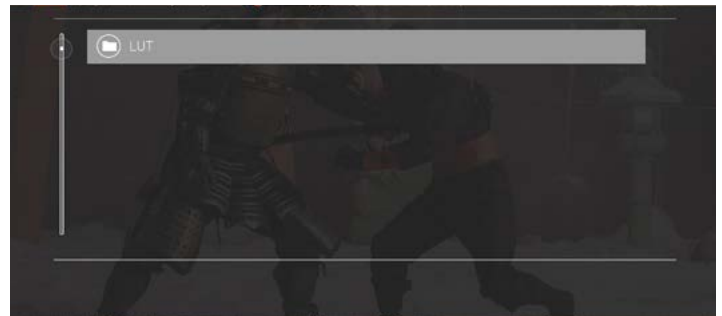

Then wait for the LUT loading progress bar to complete. The name of the currently selected 3D LUT is displayed at the top of the Monitor Mode panel.

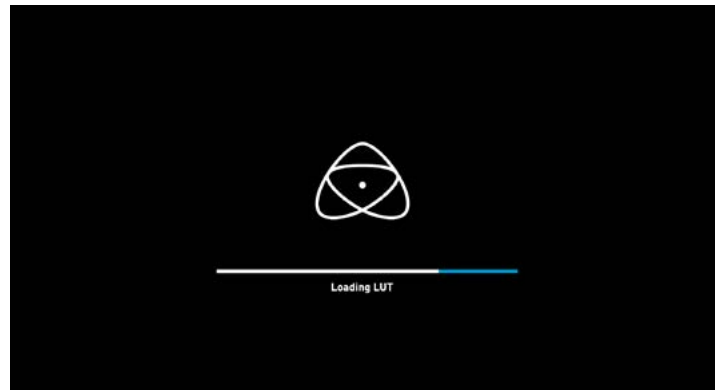

This LUT can then be applied to the display by selecting the correct LUT memory slot. **The LUT needs to be activated in the Monitor Features Menu.** Activating the LUT in the Monitor menu will always use the LUT selected in the LUTs menu. Touching the activated LUT name in the Information bar will give you instant access to LUTs selection.

Inside the LUTs menu touching on the slots will preview the name of the selected LUT (above the Menu bar). The selected LUT filename will also display in the Information bar.

8. Monitoring & Recording

3 options that relate to the processing of the LUT:



During Record

If this option is selected to the recording it will bake the LUT look into the recording and this is a **non-reversible process**. It cannot be undone in Post so we advise you consider your workflow before the use of this option. When enabled, a CUSTOM LOOK icon will flash in the top corner of the monitor and the LUT cannot be activated during recording to avoid any potential issues with the recorded content.

During Output

OUTPUT LOOK – With this option the selected LOOK is also applied to the HDMI loop out of the Shogun 7. This will allow for instant preview on a larger monitor or to be used with a wireless sender. This function can also be combined with the down convert option that can be found in the input menu.

Compare

During color management it's likely that you may want to review a number of LOOKs and even compare them to the Native Video Source. Tapping the Compare option will apply a 50/50 vertical screen split that will show both the Natural Source Video and the selected LOOK of the LUT.



 Please note that activating the 50/50 preview will also be applied to the Loop out and is not available when LUT is set to record.

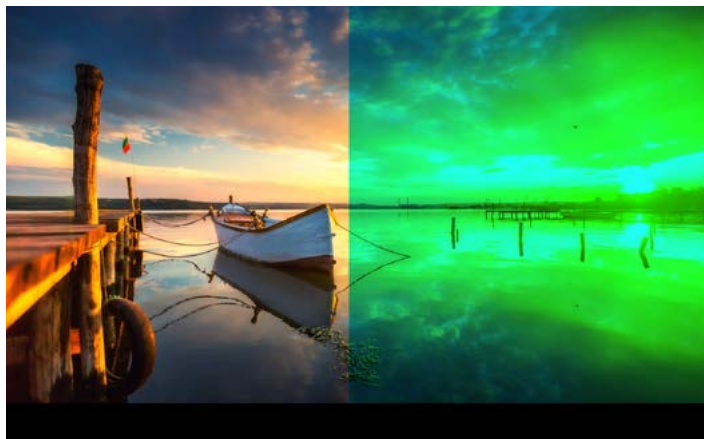

 Remember by simply tapping the center of the screen you can remove all overlays. Tap again to reveal controls.



Monitor

Before entering into the operation of HDR monitoring it is important to understand the background of HDR. We advise that you read the Atomos HDR Guide to familiarize yourself with the key terms and differences between the existing Rec.709 standard dynamic range (SDR) and the future way we will view images in High Dynamic Range (HDR).

Monitor

Using Standards - Native / Rec.709 / HLG / PQ

AtomOS10 uses predefined settings to display your video when viewing in HDR. This is similar to the HDR slider in previous Atomos Operating Systems, except instead of a variable slider control, we have now buttons that correspond with Rec.709 (SDR), HLG and PQ (HDR) levels. Activating these buttons will display your video according to the levels indicated below, allowing you to adjust your exposure accordingly and take the guess work out of exposing correctly for HDR.

Native Video Source

This option will display the video source without any processing and the Shogun 7 will behave as expected for a standard broadcast monitor. When connected to a camera this means the image you are viewing is the untouched camera output eg. a standard Rec.709 image or a Log image etc. A standard Rec.709 image will look correct and a Log image will look flat.

Rec.709

With this mode selected the Shogun 7 will map from the camera gamma/gamut so that 100% linear IRE maps the panel's white (3000nits). Everything above is clipped.

HLG (Hybrid Log Gamma)

With this mode selected the Shogun 7 will map from the camera gamma/gamut so that 1200% linear IRE maps the panel's white (3000nits). Highlights are slightly compressed.

PQ

With PQ mode selected the Shogun 7 will map from the camera gamma/gamut so that 2000% linear IRE maps the panel's white (3000nits). Highlights have more compression and look similar to HLG, but closer inspection will reveal more detail is visible in specular highlights.

8. Monitoring & Recording

Understanding HDR and Log

The first step in HDR is to recognize you have a HDR scene. Look for a good range of contrast across the brightest and darkest parts of your image and also across the color and tonal range as each color also contains its own brightness or luminance information.

Secondly ensure you are sending a Log signal into the Shogun 7 so that you are recording the HDR Log information.

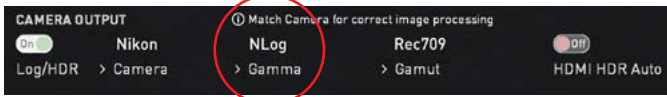

Now you are ready to capture Log and simultaneously use AtomOS10 image processing to preview the final HDR result in the field, rather than dealing with the washed out look of Log for critical exposure decisions.



The main impact of HDR is apparent in the specular highlights and bright areas. The areas that would have previously been 'blown out' will now contain visible detail and information to enhance your content. HDR provides more headroom allowing you to show more detail. Experimentation with increased exposures is encouraged.

AtomOS10 HDR uses an in depth understanding of each Log curve and combines it with the control of the panel processing and backlight in order to apply an increased brightness to the highlight areas of the scene.

Alongside the physical light in the scene, the faster/brighter your lens the greater the level of brightness you'll have to play with. Choosing a Cine style lens or those with a declicked manual aperture can provide increased flexibility over photo lenses that use an electronic control aperture.

The AtomOS10 monitoring mode allows the processing engine of the Shogun 7 to display the High Dynamic Range capabilities of a Log gamma input. HDR monitoring in AtomOS10 is the result of the research and development by Atomos that allows control of all aspects of the monitor through image processing to deliver the unclipped beauty of specular highlights through natural, vibrant colors with a result that allows you to simply shoot what you see. When the scene in front of you and the picture displayed on the Shogun look similar, your exposure should be correct, but always use in conjunction with the waveform monitor to verify.

One of the key elements to understand is that if your camera can shoot in Log, it can already capture the more dynamic range than you can display in SDR. Log preserves the highlight information by applying a Logarithmic curve to compress the additional stops of dynamic range to fit in to the Rec.709 standard. The image appears washed out and desaturated as each pixel contains more brightness information than SDR can display, if it were to do this it would be brighter than 100% Rec709 and therefore be clipped. This is illustrated below:

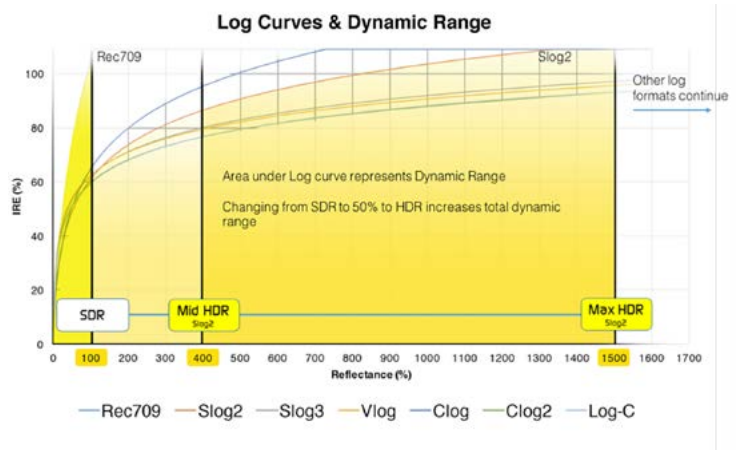

Monitor Controls

In addition to the SDR/HDR adjustments you have the following options:



DISPLAY OFF

Display off function allows for the screen to be turned off with out affecting the operation of the unit. This is combined with the screen lock function and will become active by tapping the power on/off button on the side of the unit.



TALLY LIGHT

The Tally light on the rear of the unit will still display red for record and the idle (green) status will be displayed on the front screen LED.



FLIP SCREEN

The Flip screen option allows you to invert the screen to meet your needs of operation.

Whilst the screen is inverted take note to respect the air flow and not to obstruct the cooling vents of the unit.

8. Monitoring & Recording

Display

With this mode selected you have the option to change the screen brightness by adjusting the slider when in Native mode. At 100% brightness, the image will be using the full 3000nit peak brightness of the display. As with any electronic screen device increasing the brightness will increase the power draw and battery life will be effected accordingly.

Adjustments can also be made to the Lift, Gamma and Gain of the display. You can tap the icon on the left of the menu to scroll through the options and adjustments are again made by moving the slider left and right.



Display

Backlight:



Adjust the strength of the backlight. Disabled during HDR monitoring.

Lift:



Increasing lift will brighten the image and lessen the shadows.

Gamma:



Gamma control allows you to create darker and richer shadows. This may be useful when monitoring in bright daylight conditions.

Gain:



Gain will boost the image brightness and affect the highlights.

Constant Backlight:



Tap this icon to disable zonal backlighting and optimize the display brightness when increased shadow detail is required.

Reset:



Quickly return all values to default.

Dolby Vision play out

Engage this switch if you are feeding HDR footage to the Shogun 7 from a camera or games console that supports HLG or PQ HDR output using the appropriate metadata flags. Ensure that Dobby Vision is supported on the recieving TV/Monitor, select DOLBY HDR Type in the external menu and enable "HDR Out" in the menu.



Dolby Vision external playout of recorded files is officially supported for RAW, ProRes RAW, DNxHR.

If you are feeding Log video to the unit be sure that this setting is off.

File Recovery

The Shogun 7 continuously writes to disk while in recording mode. If the power fails or the drive is removed accidentally all but the last few seconds of the clip can be recovered

In the event of an interrupted recording, when you restart the Shogun 7, or enter playback mode, you will be presented with a menu that gives you the option to recover immediately or to recover it at a later time.

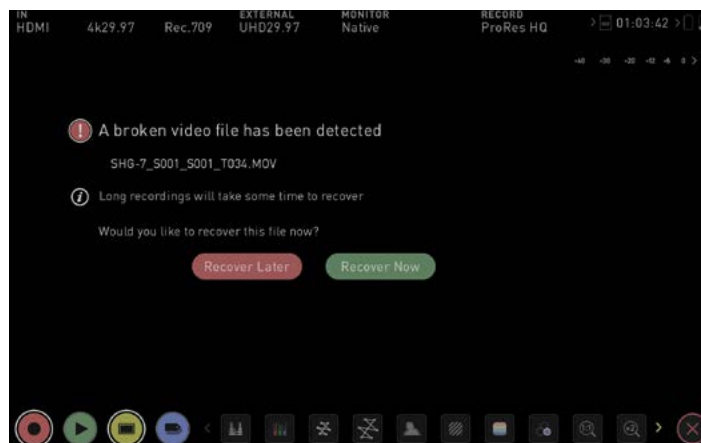

If you select recover later, every time you put the disk in, or start up the Shogun 7, the same menu will appear to prompt you to recover the file that did not close properly.

⚠ If the drive is broken or has become corrupted, you will not be able to recover the file and we recommend that you try third-party hard disk recovery software.

9. Playback & Playout

Playback mode

Pressing the Play button switches the device into playback mode and the last clip recorded on to the drive will instantly begin to playback.

Once within Play mode the complete Monitoring and Edit tool sets are available by tapping the buttons. Switch from Monitor to Edit tools by toggling the MON and EDIT buttons. Playback allows you to instantly analyze the content. This is key for establishing if takes are correctly focused, lighting has changed, or previewing recorded content with LUTs applied.

Clips/Playlist can be selected by tapping the folder icon in the lower right of the screen, or skip to the next or previous clip via the on screen controls.







Additional controls allow you to scrub through clips, set the playback speed and direction, as well as the ability to set the play mode to Loop.

All these functions can also be used in 'Playout' mode, and you footage can be viewed on a larger screen or monitor for review and appraisal. You can even apply Log curves and LUTs to you clips as they are being played back.

Playback Mode / Home



Main Controls

-  **REC (Record):**
Jump to Record Home Screen
-  **PLAY:**
Play and pause the current clip
-  **MON (Monitor):**
Reveal/hide monitoring tools. Toggle on/off
-  **EDIT:**
Reveal/hide Edit tools. Toggle on/off
-  **Settings:**
Touch to access Playback settings and tools.
-  **Recorded Files**
Browse recorded files



Scrub bar | Speed/direction control

Available during playback. Scrub forward and back.

Set playback direction and speed. The percentage slider allows for you to set the playback speed. This is perfect for previewing high frame rate at half or quarter speed such as 60p at 30p in either forward or reverse directions.



2x/4x

Play back at 2 x or 4x speeds both forward and in reverse.



Next/Previous

Jump to next or previous take.



Advance

Whilst a clip is Paused these buttons have the ability to step the clip by 1 second either forward or reverse to give you chance to analyse the clip in more detail.



Loop

Tap to enable loop playback. In and out markers can also be utilized.

9. Playback & Playout

Playback Mode

One of the key elements of the Shogun 7 is the ability to utilize the monitor recorder as a play back and play out device for the content that has been recorded whilst maintaining the same visually lossless high quality images. Shogun 7's Play out capability also allows you to send the live and recorded footage out to a larger HDMI monitor or switcher.

Recorded Files Browse recorded files



Pressing the filename or folder button will bring up a list of clips available on the drive. This will show clip name (with Scene shot Take numbers) as well as resolution, codec and duration Tap to highlight a clip, this will show a preview of the first frame in the background and tapping again or pressing play will play this clip.

 *When the playback content list menu is open playback will automatically stop.*

Playlists

To increase the functionality and flexibility of the playback mode there is also the ability to create a Playlist. To build a Playlist open the Recorded Files folder, then press the Playlist button which will turn green and reveal the options available.



 *It's important to note that all clips in the Playlist must be in the same codec, resolution and frame rate.*

To return to normal playback of all recorded materials, press the Playlist icon again to deactivate the playlist



 The **Order Arrow** allows you to choose order in which clips playback. The clips are stored based on the order they were recorded with the last clip recorded at the top of the list. You can either play down the list (newest to oldest) or up the list (sequential order).

Tags



Press to scroll through the Playlist options.

- **All** will play all clips on the disk.
- **Favorites** will play only the clips that are tagged as favorites.
- **Combined** will play only the clips that are tagged with favorite and the selected clips
- **Selected** will play only those clips selected

 *The duration of each clip is combined together and are shown on the scrub bar in play pack controls. A white vertical line indicates the start and end points and clips will seamlessly playback across those selected to be in the play lost.*

Codec Playlist



You can select which clips are played back by toggling the available codecs. You can only choose from the codecs used in recording. Only one codec can be selected.

Favorites Playlist



The cut tag edit points can be combined with the favorites Playlist allowing the in and out points that have been created within the clip using the favorites flag to be used as subclips with in a Playlist. This means that if in and out points have been marked on a clip only those sections of the clip will play when used in a favorites or combined Playlist. Close attention should be paid to the order icon as this also relates to the sub clips in that with the run down order will play the last sub clip first in the Playlist.

 *Whilst a Playlist is in operation, further metadata tags can not be applied to these clips. Exit playlist mode to add new tags.*

More information about using the In and Out points, tagging and XML Export is available in the next section. See pages 41-42 for information on using marker points.

9. Playback & Playout



Video Format

Video Format

The Video Format menu contains information about the current settings of your Shogun 7.

VIDEO OUT

The Format, compression rates and time remaining on you disk are displayed.



CAMERA OUTPUT

Activating camera output will prompt the Shogun 7 to play the file using the original metadata from the source camera and allow more accurate image processing and display.

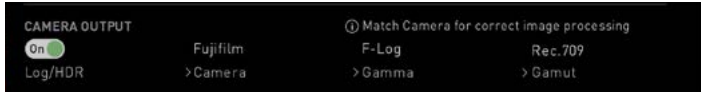

Playback Auto HDR

Engage this switch if you are feeding HDR images to the Shogun 7 from a camera or games console that supports HLG or PQ HDR output directly, using the appropriate metadata flags. If you are feeding Log video to the unit be sure that this setting is off.

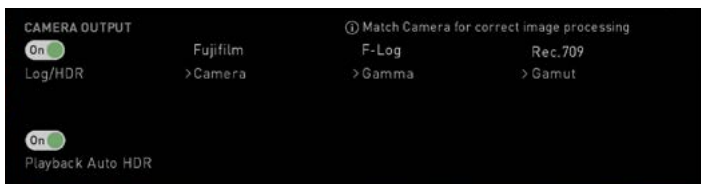

External

External

For information about this menu see page 20

VIDEO OUT

The Format, compression rates and time remaining on you disk are displayed. You may also select your preferred SDI signal type here. When an output device is detected the Shogun 7 will automatically deliver an output signal over either HDMI or SDI. If you wish to embed an external Genlock signal into the output ensure the option is enabled in the Video Out sub-menu.

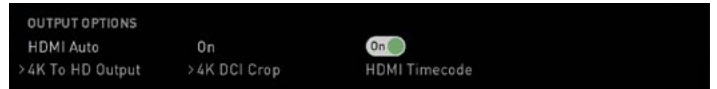

OUTPUT OPTIONS

4K to HD and 4K DCI crop options. Toggle on/off. HDMI Timecode output can also be enabled here for recording from your existing files.

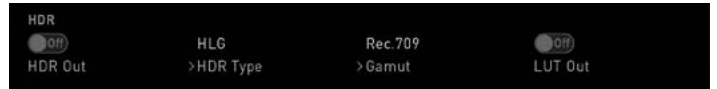

HDR

Engage this switch if you are feeding HDR images to the Shogun 7 from a camera or games console that supports HLG or PQ HDR output directly, using the appropriate metadata flags. If you are feeding Log video to the unit be sure that this setting is off.

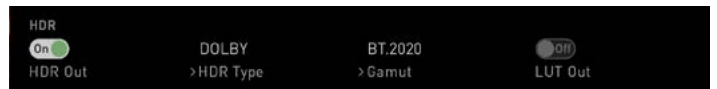

DOLBY VISION PLAYOUT

Engage this switch if you are feeding HDR footage to the Shogun 7 from a camera or games console that supports HLG or PQ HDR output using the appropriate metadata flags. Ensure that Dobby Vision is supported on the recieving TV/Monitor, select DOLBY HDR Type in the external menu and enable "HDR Out" in the menu. Refer to page 35 for additional information.

9. Playback & Playout

Meters

Meters

For information about this menu see page 21

Date

Date

For information about this menu see page 23

Battery

Battery

For information about this menu see page 24

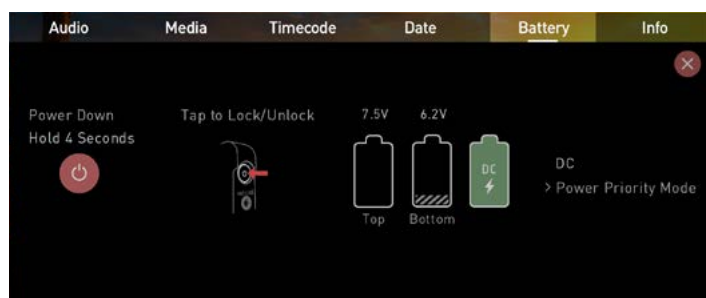

Info

Info

Shows the software (firmware) version and unique device ID (DID) of your Shogun 7 device. This will be required to activate the Avid DNxHD / Avid DNxHR codec. You can also check on the Atomos website to ensure you are running the latest firmware: www.atomos.com/support

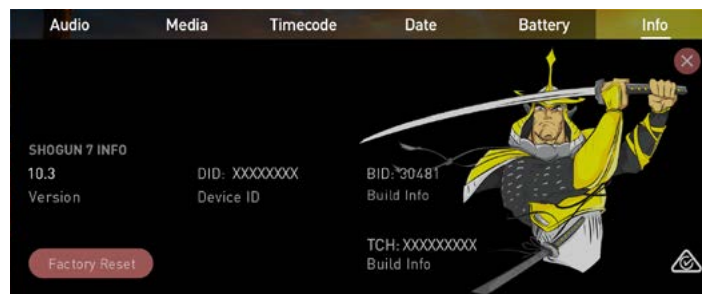

10. Edit

Edit mode

Edit mode allows you to tag your clips during recording and playback, as well as the ability to add in and out-points to recorded clips.

By the pressing the Favorite and Reject icons you can assign a "good clip" or "bad clip". This information can then be imported into a non-linear editing system to speed up the edit process. You can easily see which parts of your recording you have marked to keep or reject.

Favorite clips can easily be built into a Playlist in playback mode and these tagged sub clips can then be played out, back to back.





AtomOS10 has introduced extended tags to allow you to apply more specific tags that can help facilitate the edit.















 SmartLog is compatible with FCPX XML (.fcpxml).

Edit Mode during playback



Main Controls

-  **REC (Record):**
Press record to start recording
-  **PLAY:**
Play and pause the current clip
-  **MON (Monitor):**
Reveal/hide monitoring tools. Toggle on/off
-  **EDIT:**
Reveal/hide Edit tools. Toggle on/off
-  **SETTINGS:**
There are no user accessible settings available for Edit functions in AtomOS 10.2. This may change with future firmware updates.

 IN In-point	 OUT Out-point	 Favorite	 Reject
 Talent 1	 Talent 2	 Overexposed	 Color
 Noise	 Cut Away	 Close up	 Wide Shot
 EXPORT Export	 RESET Reset	Swipe left to reveal 	

10. Edit

Markers and Tagging Icons (SmartLog)

Using Markers and Tags you can quickly start the editing and review process right here on your Shogun 7, avoiding delays incurred when importing inferior and unwanted footage. You can review and tag immediately on-set with your client or director, or work through your takes without having to dump the recorded files to another workstation/NLE.



In-Point

Set the in-point by touching the button at desired point. Simply touch on to indicate in-point. Press a second time to reset in-point



Out-Point

Out-point can be set by simply tapping at desired out-point. To remove, tap again



Favorite

Mark the entire take as a favorite, or you can mark the parts of the take you wish to use. Apply multiple markers within one take if required



Reject

Mark the take/section as a reject



Talent 1

Tag talent or assign another meaning



Talent 2

Tag talent or assign another meaning, event etc.



Over Exposed

Tag clip as over exposed or out of focus



Color Correction

Tag clip as 'color'. Use tag to indicate a problematic image or even use for another purpose



Noise

Tag clip as containing background noise or interference



Cut Away

Tag clip as a cut away scene



Close Up

Tag clip as close up for use in edit and post



Wide Shot

Tag clip as wide shot



EXPORT XML

Once you clips have been tagged you can capture all the information and utilise the XML data to speed you edit and post production time.

 SmartLog is compatible with FCPX XML (.fcpxml).



RESET

Pressing the reset button will remove all tags and XML data from a clip. This can be useful when dealing with multiple takes or if a clip is tagged incorrectly. Reset will not remove or change in-point and out-point settings. To remove markers you will need to reset the in and out-points

Using Edit tools during recording, playback and monitoring

To access edit tools simply tap the Edit icon during record or monitoring.



In / Out points

Set in and out points easily during playback. Use the scrub control to accurately find the correct moment while the footage is paused.



Once markers are set, the footage will be clipped and only the enclosed footage will play. Reset markers to resume normal playback.



10. Edit



Favorite/Reject

Press Play and when you see the section of the footage you would like to mark as good or bad, press Favorite or Reject and then press again to stop marking that section. Multiple tags can be applied to your clips to provide Timecode accurate meta tags that can be exported to Apple FCPX XML.



 A green or red line will appear in the timeline scrubbing bar so you can identify the region that has been selected.

1 Using Extended Tags

Aside from Favorite and Reject tagging options, AtomOS10 includes extended tags that will greatly assist your edit and workflow processes. Careful consideration and use of tags during monitoring and review can be highly beneficial when you are ready to begin post production.



The tags will be available upon import of the XML file and can be used to filter and display different parts of your recordings, depending on how you have used the tags to mark and edit the footage. More information about using tags and XML import can be found on pages 45.



Tags are also useful during playback and allow you to create Playlists featuring only selected recordings from your disk. More information about Playlists can be found on page 37. A full list extended tagging options appears on page 38.



.xml Export

Once your files have been reviewed you are ready to export the .xml file that contains all information from tags, In/Out points, Favorites and Extended Tags. It is essential to export the .xml file information from each clip will be ready for use in Final Cut Pro and other compatible NLEs.

Your final stage is to Export the tags to a FCPX XML file:

- Press the EXPORT button
- You will be shown a please wait screen (the length of time will vary depending on your recording time and amount of flags applied)
- Then it will return you to the previous screen.

A .xml file has been created on your SSD and can be instantly accessed by FCPX when the disc is connected to a computer using a compatible dock. See page 45 for more info.

 Pressing the reset button will removed all tags and XML data from a clip. This can be useful when dealing with multiple takes or if a clip is tagged incorrectly. Reset will not remove or affect in-point and out-point settings. To removed markers you will need to reset the in and out-points

11 . HD Pulldown

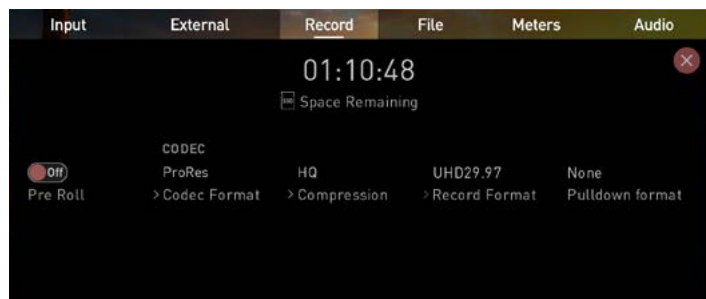

What is Pulldown?

Many professional and consumer cameras available today do not send true 1080p24, 1080p23.98, 1080p25, 1080p29.97 or 1080p30 signals down their HDMI outputs.

Instead they send 1080i59.94 in NTSC regions (eg USA, Japan), and 1080i50 in PAL regions (eg Europe)

In order to convert the signal from the internal recording format to 1080i5994 or 1080i50, they use a process called 3:2 or 2:2 pulldown.

 Pulldown is only applicable to interlaced HD signals, not 4K

Camera Setting	Pulldown	Shogun 7 Receives
1080p23.98	3:2	1080i59.94
1080p24	3:2	1080i60
1080p25	2:2	1080i50
1080p29.97	2:2	1080i59.94
1080p30	2:2	1080i60

You will of course want the Shogun 7 to record the actual frame rate such as 1080p23.98, not the 1080i59.94 to disk. In many cases, it is not possible for the Shogun 7 to detect when pulldown has been applied to the video, so you will have to set the correct mode of removal on the Shogun 7 to match the setup of your camera.

With some cameras, the Shogun 7 can detect and remove the pulldown automatically, in which case the mode you expect (eg 1080p23.98) will display on the Shogun 7 and you will not have to do anything further.

If there is no input detected, then toggle the input by pressing the screen until you see the input you wish to record.

 Atomos is adding auto-detection support for more cameras, please check for firmware updates regularly at www.atomos.com

VID HDp23.98

1080p23.98 or 1080p24

If you have set 1080p23.98 or 1080p24 in your camera and your Shogun 7 displays 1080i59.94 or 1080i60, then you can easily remove the pulldown by following these steps:

- Select the Input Menu from the top Left and toggle the blue arrow underneath Record repeatedly until you see 1080p23.98 (or 1080p24) displayed. You may not get a green tick in this column immediately.
- Your Shogun 7 needs to analyse the video for about 1 second, in order to detect the pulldown sequence and remove it.
- If it is not automatically detected after 1 second, wave your hand from side to side in front of the lens, or wave the camera from side to side for a few seconds. The Shogun 7 will detect the pulldown cadence in the movement, and you will see a green tick along with the video displayed on the screen.

 3:2 pulldown detection is difficult, if not impossible to detect on completely still video. This is why you should wave your hand in front of the lens.

 If you lose the input detection – for example you unplug the HDMI cable or go to Playback mode, you will need to wave your hand or the camera again, when the signal is restored to the Shogun 7.

 Some cameras use a variant of pulldown removal, for example Panasonic Advanced pulldown. The Shogun 7 does NOT support this format, and it will not be detected.

 Standard Panasonic pulldown is supported, ensure in the Panasonic camera settings that pulldown is not set to Advanced.

1080p25, 1080p29.97 or 1080p30

For these modes, access the Record Menu tab and simply press the Record Format options repeatedly until your 1080p desired format is displayed. There is no need to wave your hand or the camera, as 2:2 pulldown removal does not require moving video.

12. Connecting & Editing

Connect

To access and edit your recorded material, connect the Master Caddy Docking Station to a Mac® or Windows® editing workstation via USB 2.0, USB 3.0 or USB-C 3.1.

Eject the Master Caddy or SSD mini from your Shogun 7 and insert it into the Docking Station. After a short wait, the recorded video will be accessible to the target computer via a standard disk (exFAT) file system.

NLE supported

We have chosen the Apple ProRes®, Apple ProRes RAW, Avid DNxHD® and Avid DNxHR+ codecs as they are both not only visually lossless, but also edit-ready formats. All major NLEs support ProRes and DNxHD/DNxHR.

- Final Cut Pro (version 7)
- Final Cut X
- Davinci Resolve 8.0 +
- Adobe CS5 (with 5.51 update or later)
- EDIUS 6
- Vegas 10
- Lightworks
- Avid Media Composer 6 (version 8.3 or later for DNxHR)
- Autodesk Smoke

Avid DNxHD / DNxHR support requires online activation.

ExFAT compatibility

The Shogun 7 formats your disk as exFAT. We have chosen this file system to overcome the 4GB file limitation of FAT32 and keep compatibility on both Windows and MAC OS.

The Operating Systems that support exFAT are:

- Windows 10
- MacOS 10.6.5 or higher

 *The Master Caddy Docking Station is a sophisticated device supporting two different data interfaces: USB 2 and USB 3. When using the Master Caddy Docking Station you may need to connect both USB connectors. This is because when it has to power a disk drive and its interface electronics, the Docking Station may consume more power than is available from a single USB port.*

Transferring files

Now your docking station is connected and your disk is recognized by your operating system, you can edit directly from the drive or copy the files to your own storage.

Windows

Open the disk in My Computer > Select all the files or just the ones you wish to transfer, copy and paste them to your desired location. (ctrl+c copy, ctrl+v paste).

Mac OS

Your Shogun 7 disk will show in Finder. Select the files you wish to transfer, drag the files to your desired location or use the copy and paste commands. (COMMAND + C copy, COMMAND + V paste).



* When using the AtomX USB-C 3.1 Docking Station II with older computers a USB 3.0 Male to Type C Female adaptor is required.

12. Connecting & Editing

Importing

Final Cut Pro (version 7), Final Cut Pro X, Adobe CS5 (with 5.51 update), EDIUS 6, Sony Vegas 10, Davinci Resolve 8.0 +, Lightworks and Avid Media Composer 6 support imported files from your Shogun 7 disk.

Importing Shogun 7 footage into Final Cut Pro X

You can import Shogun 7 footage into Final Cut Pro X (FCPX) in just a few simple steps.

First, connect the Shogun 7 Docking Station to your Apple Mac using the USB 2.0 or USB 3.0 port. Insert the Shogun 7 Master Caddy II containing the disk with your footage into the Docking Station and you will see the drive appear in your Finder window.

Start FCPX and open your project (or start a new one).

The screen will look like this:

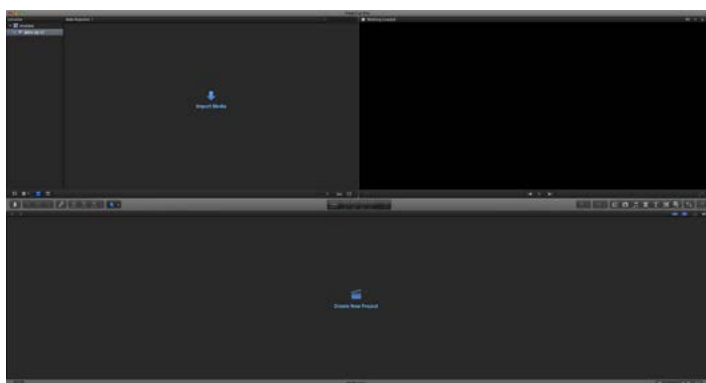

Go to the File menu and select Import > Media

FCPX will show you a “browse” window. Look for the Shogun 7 drive, and click on it.

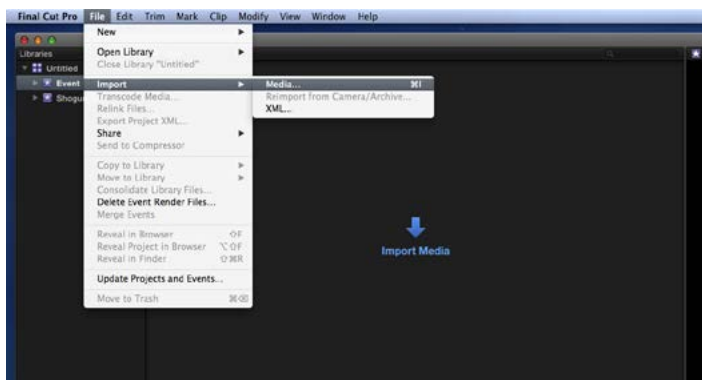

You'll see the folders in the Shogun 7 drive. Select the folder containing the footage you want to import:

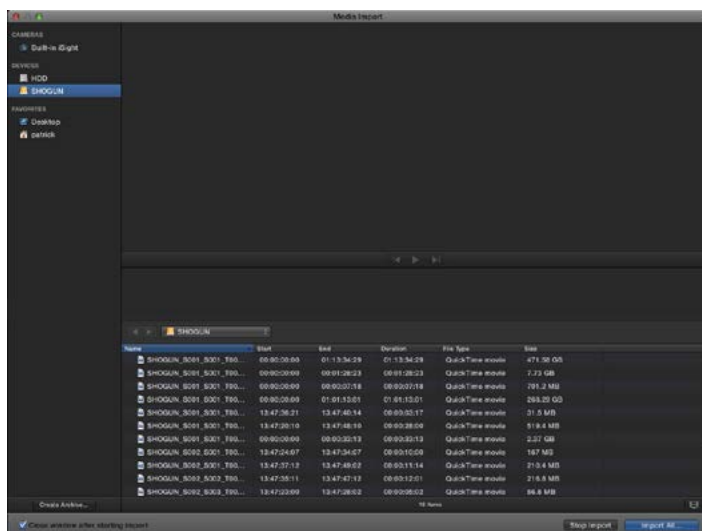

Click on Import All or Import Selected, individual clips can be selected. Choose the Event you wish to import the footage into, or create a new event.

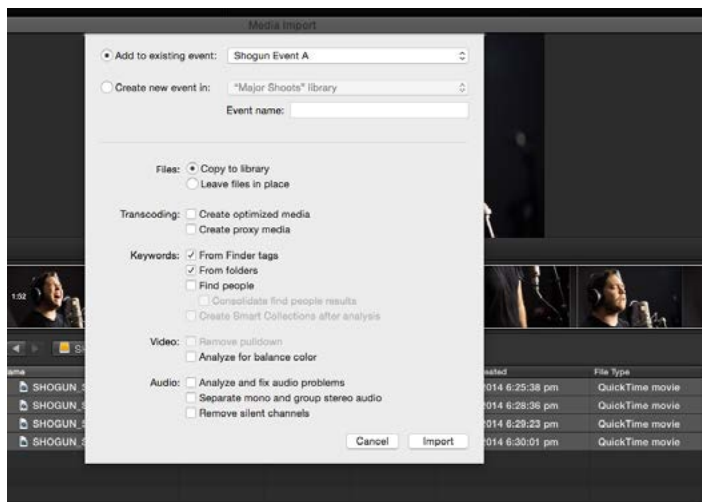

Select Import:



Your Scene, Shot and Take files now appear in the project window, ready for use in your FCPX project.

12. Connecting & Editing

SmartLog with FCP X

Prior to importing the XML files into FCP X, ensure that:

- You have exported XML whilst the drive is in your Shogun 7
- You have connected your Master Caddy Docking Station and inserted your Master Caddy into the Dock
- You are using an operating system that supports ExFAT
- Your QuickTime version is up to date
- FCP X is the latest version

There are 2 ways to import the XML file:

1. Directly from the docked hard drive
2. Manually into FCP X

1. Automatic Import

- Open Finder
- Select the drive (in this example it is EXCVIDEO)
- Double-click the unitname.FCPXML file
- This will open FCP X and import the .xml file

FCP X will make an event of the disk, name and reference all the footage in that event.

You will notice that on the clips you have added Smart Tags too, with Green and Red indicating Favorite and Reject.

You can sort these by using the pull-down menu to show favorites.

This will show all the individual favorites as separate clips in the Event Viewer.

2. Manual

- Open FCP X
- Create a New Project (or you can use an existing project); in this example it is called XML Import
- Select File, Import, XML

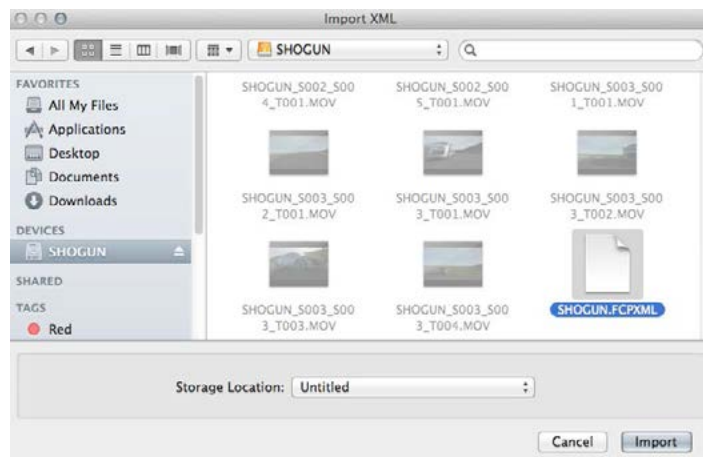

- Select the Shogun 7 drive under Devices (in this example it is called EXCVIDEO)
- Choose the unitname.FCPXML, select Import

The XML will import

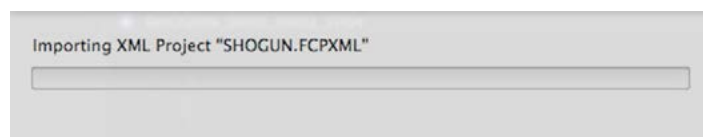

Once imported you can expand the clip and you will see the Favorite, Reject and other various tags. You can also filter the view to only see specific tags eg. favorite, etc.

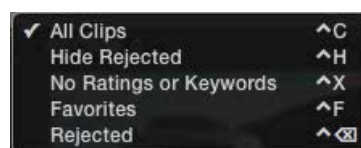
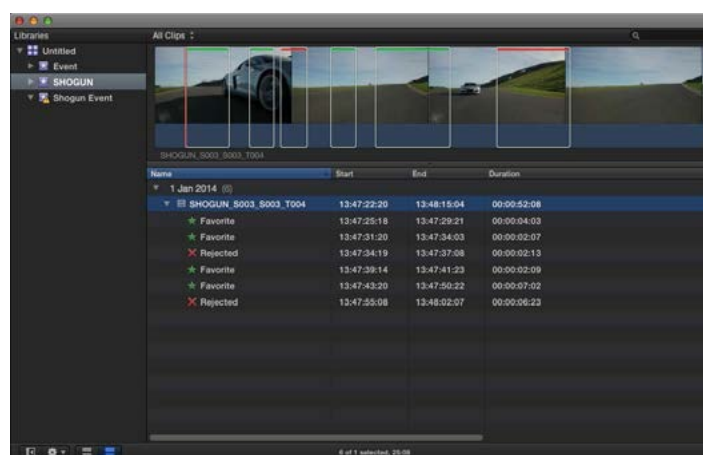

13. Technical Specifications

Weight and Dimensions	
Without batteries	738g / 26oz.
Dimensions (W x H x D mm)	214 x 127 x 45mm
Construction	Glass fiber reinforced polycarbonate
Mounting points	1/4"-20 screw mount. 1x top and 1x bottom
Power	
Operating power	10 - 33W
Compatible batteries	Atomos NP-F series and supporting accessories
Input voltage (battery)	6.2V to 16.8V
Battery time* (based on 7.4V) AtomOS 10.2	5200mAh – up to 1hr 10min (monitor & record 4K 60p) 7800mAh – up to 1hr 50min (monitor & record 4K 60p)
DC In	1 x DC in (6.2 - 16.8V)
Continuous power*	Primary-secondary battery system. Change batteries without losing power. Loop batteries continuously.
Touchscreen	
Screen	Capacitive touch
Size	7.2"
Resolution / PPI	1920 x 1080 / 325ppi
Aspect ratio	16:10 native resolution 1920 x 1200
Contrast ratio	1,000,000:1 (Zone backlight turned on)
Color Gamut	Up to Wide color gamut (105% DCI-P3)
Look up table (LUT) support	3D LUT (.cube format)
Anamorphic de-squeeze	2x, 1.5x, 1.33x
Technology	Dynamic AtomHDR zoned backlight IPS LCD
Dynamic AtomHDR Technology	
Backlight	Direct LED
Zones	360 direct backlight individual LEDs
LEDs	Wide Color Calibrated D65 or D9
Bit depth	10-bit (8+2 FRC)
Color	DCI-P3 105%
Peak Brightness	3000nit (+/- 10%)
Control	On the fly real-time brightness analysis for LED control
HDR Conversion	Log/RAW to HLG or PQ
HDR Monitoring Technology	
Technology	IPS panel (capacitive touch), calibration to Rec.709 with optional calibration unit
AtomHDR	Yes
HDR Monitoring (Gamma)	Sony SLog / SLog2 / SLog3 Canon CLog / CLog2 / CLog3 ARRI Log CEI160 / LogCEI200 / LogCEI250 / LogCEI320 / LogCEI400 / LogCEI500 / LogCEI640 / LogCEI800 / LogCEI1000 / LogCEI1280 / LogCEI1600 Panasonic Vlog JVC JLog1 RED Log3G10 / RED LogFilm FujiFilm F-log Nikon N-Log PQ10k HLG
HDR Monitoring (Gamut)	Sony SGamut / SGamut3 / SGamut3.cine Canon Cinema / DCI P3 / DCI P3+ Panasonic V Gamut Arri Alexa Wide Gamut Rec709 / BT.2020 JVC RED WideGamut / RED DragonColor / DragonColor2 / RED Color2 / RED Color3 / RED Color4
Video Input / Loop out	
HDMI	HDMI 1 x HDMI (2.0)
SDI	Quad Link 4 x 3G/6G SDI*, 4 x 3G-SDI, 2 x 12G Single Link SDI
Signal	Uncompressed true 10-bit or 8-bit 422 (camera dependent)
Genlock	Genlock input signal and output signal
Video Output (Playout)	
HDMI	1 x HDMI (2.0)
SDI	2x 4K-SDI 12G or HD-SDI 3G/6G
HDMI	Uncompressed true 10-bit or 8-bit 4:2:2 (camera dependent)
Onboard Processing	
Pulldown removal	24/25/30pSF > 24/25/30p (2:2 pulldown) 60i > 24p (3:2 pulldown)
4K UHD downscale for HD monitoring	Yes - Loop-out and playback (Not available in RAW)

Supported Codecs & Frame Rates (Record & Playback)	
RAW to:	ProRes RAW ProRes CinemaDNG (CDNG up to 30p only) Avid DNxHD, Avid DNxHR
Sony^^ FS700, FS-5, FS-7, FS-7MkII	4K DCI; 24/25/30/50/60p 4K UHD; not supported in camera 2K; 24/25/30/50/60/100/120/200/240p 1080; not supported in camera
Canon C300MKII/C500 CDNG	4K DCI; 24/25/30p 4K UHD; 24/25/30p 2K; not supported in camera 1080; not supported in camera
Panasonic VaricamLT, EVA1	5.7K DCI; 24/25/30p (EVA1 ProRes RAW only) 4K DCI; 24/25/30/50/60p 4K UHD; 24/25/30/50/60p 2K; 24/25/30/50/60/100/120/200/240p 1080; not supported in camera
Supported base resolution & FPS from cameras	4K DCI: 23.98/29.97/59.94p 4K UHD: 23.98/29.97/59.94p 2K DCI: 23.98/29.97/59.94p 1080p: 23.98/29.97/59.94p
Supported FPS & resolution from gaming consoles and graphic cards	1080p; 24/25/30/50/60/100/120
Audio Out	
HDMI	2 or 8ch 24-bit, camera dependent
SDI	12ch 48kHz 24-bit
Audio	2ch balanced XLR analogue in/out Dynamic range >90dB Max signal level +24dBu Max analogue gain +52dB 48V Phantom Power for Mic
Headphone out	3.5mm 2ch.
Remote Start/Stop	
HDMI	Auto HDMI Trigger Supported Protocols – Dolby Vision, Canon, Sony, Atomos Open Standard
SDI	SDI trigger camera selectable
Other	LANC control - Slave
Playback	
Playlist / Genlock / LTC	Yes / Yes / Yes
CDNG (Recorded content)	No support
ProRes (Recorded content)	All recorded files can playback. Playback in slow motion >= 100fps
ProRes RAW (recorded content)	All recorded files can playback. Playback in slow motion >= 100fps
DNxHR / DNxHD (recorded content)	All recorded files can playback. Playback in slow motion >= 100fps
Recording	
Pre-roll record	Yes (HD 8s, 4K 2s)
Custom time lapse	Yes*
Metadata tagging	Yes (10 tags available)
Supported media	2.5" SSD/HDD compatibility depends on recording format, resolution and frame rate. Visit atomos.com/drives for list of tested and approved drives
Master caddy case	Master Caddy II (included) 75mm x 105mm x 12mm
Master caddy dock	2.5" SATA to USB 2.0/3.0
Supported applications	Final Cut Pro / Media Composer / Premiere Pro / After Effects / EDIUS / Vegas Pro / Lightworks / Autodesk Smoke
What's in the box	
Included	Shogun 7 unit, Master Caddy II x 1, 12V-3A AC power supply, Carry Case, Quick Start Guide
Optional extras	
Accessories	Power Kit: 2 x battery, 1 x charger, 1 x power supply Other: Atomos HDMI cables, Breakout XLR cable, X-Rite i1 DisplayPro calibration. Compatible AtomX accessories: Shogun 7 Sunhood, AtomX USB-C 3.1 Docking Station II, AtomX SSDmini Handle, AtomX SSDmini by Angelbird, AtomX SSDmini by Sony ,
Warranty	
1 Year	Extended to 3 years on product registration

Construction note: Shogun 7 is designed to operate in ambient temperatures up to 40°C/104°F. If you wish to extend the temperature of operation in high temperature conditions, set the TFT brightness to a minimum.

All specifications correct when published, subject to E&OE.

24/30/60 frame rates also means 23.98/29.97/59.94 frame rates for all resolution

*Available in future firmware updates

^^ Optional unit (XDCA-FS7) needed for Raw output.

* Patent pending.

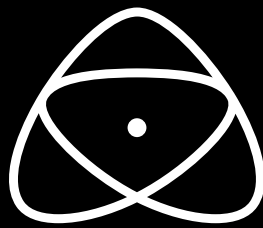

atomos.com

 [/atomos.global](https://www.facebook.com/atomos.global)

 [@atomos.globsl](https://www.instagram.com/atomos.globsl)

 [@Atomos_News](https://twitter.com/Atomos_News)

 [/AtomosVideo](https://www.youtube.com/AtomosVideo)

 [/atomosvideo](https://vimeo.com/atomosvideo)