

SIMATIC

Field PG P4

Manual

Preface, Contents

Important Notes

Getting Familiarized with the
SIMATIC Field PG P4

Configuring And Operating The
SIMATIC Field PG P4

SIMATIC Field PG P4 Expansions

Configuring the SIMATIC
Field PG P4

Error Diagnostics

Hardware Information

Reinstallation of the Software

Appendices

ESD Guidelines

Technical Specifications

Glossary, Index

1

2

3

4

5

6

7

8

A

B

Safety Guidelines

This manual contains notices intended to ensure personal safety, as well as to protect the products and connected equipment against damage. These notices are highlighted by the symbols shown below and graded according to severity by the following texts:



Danger

indicates that death, severe personal injury or substantial property damage will result if proper precautions are not taken.



Warning

indicates that death, severe personal injury or substantial property damage can result if proper precautions are not taken.



Caution

indicates that minor personal injury can result if proper precautions are not taken.

Caution

indicates that property damage can result if proper precautions are not taken.

Notice

draws your attention to particularly important information on the product, handling the product, or to a particular part of the documentation.

Qualified Personnel

Repair, maintenance and servicing of device only to be carried out by qualified personnel. Qualified persons are defined as persons who are authorized to commission, to ground and to tag circuits, equipment, and systems in accordance with established safety practices and standards.

Correct Usage

Note the following:



Warning

This device and its components may only be used for the applications described in the catalog or the technical description, and only in connection with devices or components from other manufacturers which have been approved or recommended by Siemens.

This product can only function correctly and safely if it is transported, stored, set up, and installed correctly, and operated and maintained as recommended.

Trademarks

SIMATIC®, SIMATIC HMI® and SIMATIC NET® are registered trademarks of SIEMENS AG.

Third parties using for their own purposes any other names in this document which refer to trademarks

Copyright © Siemens AG 2004 All rights reserved

The reproduction, transmission or use of this document or its contents is not permitted without express written authority. Offenders will be liable for damages. All rights, including rights created by patent grant or registration of a utility model or design, are reserved.

Siemens AG
Organization Group Automation and Drives
Division Industrial Automation Systems
P.O. Box 4848, D- 90327 Nuernberg

Disclaim of Liability

We have checked the contents of this manual for agreement with the hardware and software described. Since deviations cannot be precluded entirely, we cannot guarantee full agreement. However, the data in this manual are reviewed regularly and any necessary corrections included in subsequent editions. Suggestions for improvement are welcomed.

© Siemens AG 2004
Technical data subject to change.

Preface

Purpose of the Manual

This manual contains all the information you need for commissioning and using the SIMATIC Field PG P4 programming device.

It is intended both for programming and testing/debugging personnel who commission the device itself and connect it with other units (automation systems, further programming devices) as well as for service and maintenance personnel who install expansions or carry out fault/error analyses.

Where is this Manual Valid?

This manual is valid for all supplied variations of the SIMATIC Field PG P4 and describes the state of delivery as of August 2004.

Certifications, Standards and Approvals

Certifications

The device fulfils the following guidelines and certifications:

- EU guideline 73/23/EEC on low voltages
- EU guideline 89/336/EEC on electromagnetic compatibility
- Underwriters Laboratories (UL) to Standard UL 60950, 3rd Edition
- Canadian Standard Association (CSA) to Standard C22.2 No. 60950

Standards and Approvals

The device fulfils the requirements for the CE approval. Approvals for UL and CSA are available.

Further information on the approvals, certificates, and licenses for your device is provided in Chapter 1.

Incorporation into the Communications Environment

This manual forms part of the supplied DVD "Backup PG".

For supplementary instructions on how to handle the software please refer to the corresponding manuals.

Structure of the Manual

Chapters 1 to 5 of the manual contain the most important instructions for commissioning and using the Field PG P4. Chapters 6 to 8 are reference sections required in special situations.

Important Notes

This chapter contains information on security, certificates, guidelines and approbations.

Familiarizing Yourself

Before you initially start using the Field PG P4, you should inform yourself about its components and their functions in Chapter 2.

Configuration and Operation

Before you start to use your programming device, you should read about the components and functions of the SIMATIC Field PG P4 in Chapter 3.

Installation

Chapter 4 describes the basic steps necessary for commissioning the Field PG P4. This chapter also contains instructions for working with submodules and memory cards for programmable logic controllers and additional interfaces.

Expansion

Chapter 4 describes how to expand your SIMATIC Field PG P4 (for example, installation of memory expansions). Please observe the safety instructions in this section.

Configuration

Modifications made to the system hardware may make it necessary for you to adapt the original hardware configuration. This is described in Chapter 5.

Error/fault diagnostics

Chapter 6 explains how to deal with simple faults and problems that you can diagnose and, in some cases, eliminate yourself.

Reference data

Chapter 7 contains information about hardware addresses, interrupt assignments, and connecting cables.

Reinstalling the Software

If it does happen that you need to reinstall the software you can find the procedures in Chapter 8.

ESD guidelines

The guidelines on the handling of electrostatic-sensitive devices are particularly important for service and maintenance technicians who are installing expansion units or carrying out error analysis with the SIMATIC Field PG P4.

Glossary

The glossary defines and explains important terms.

Alphabetical index

The alphabetical index will help you to find passages in the text relating to important terms and keywords quickly and reliably.

Conventions

The abbreviation PG oder device is also used within this manual for the product designation SIMATIC Field PG P4 P4.

Further Support

If you have questions related to the use of the products which are not answered in this manual, please consult your Siemens representative in your local agency. You will also find your representatives for repairs and spare parts at

<http://www.siemens.com/automation/partner>

Trainingscenter

Siemens offers a number of training courses to familiarize you with the SIMATIC S7 automation system. Please contact your regional training center or our central training center in D 90327 Nuremberg, Germany for details.

Telephone: +49 (911) 895-3200.

Internet: <http://www.sitrain.com>

A&D Technical Support

Worldwide, available 24 hours a day:



<p>Worldwide (Nuernberg) Technical Support</p> <p>24 hours a day, 365 days a year Phone: +49 (180) 5050-222 Fax: +49 (180) 5050-223 E-Mail: adsupport@siemens.com GMT: +1:00</p>		
<p>Europe / Africa (Nuernberg) Authorization</p> <p>Local time: Mon.-Fri. 7:00 to 17:00 Phone: +49 (180) 5050-222 Fax: +49 (180) 5050-223 E-Mail: adsupport@siemens.com GMT: +1:00</p>	<p>United States (Johnson City) Technical Support and Authorization</p> <p>Local time: Mon.-Fri. 8:00 to 17:00 Phone: +1 (423) 262 2522 Fax: +1 (423) 262 2289 E-Mail: simatic.hotline@sea.siemens.com GMT: -5:00</p>	<p>Asia / Australia (Beijing) Technical Support and Authorization</p> <p>Local time: Mon.-Fri. 8:00 to 17:00 Phone: +86 10 64 75 75 75 Fax: +86 10 64 74 74 74 E-Mail: adsupport.asia@siemens.com GMT: +8:00</p>
<p>The languages of the SIMATIC Hotlines and the authorization hotline are generally German and English.</p>		

Service & Support on the Internet

In addition to our documentation, we offer our Know-how online on the internet at:

<http://www.siemens.com/automation/service&support>

where you will find the following:

- The newsletter, which constantly provides you with up-to-date information on your products.
- The right documents via our Search function in Service & Support.
- A forum, where users and experts from all over the world exchange their experiences.
- Your local representative for Automation & Drives via our representatives database.
- Information on field service, repairs, spare parts and more under “Services”.

Contents

	Preface	iii
1	Important Notes	1-1
1.1	Safety Instructions	1-1
1.2	Certificates, Directives and Declarations	1-2
1.3	Certification for the USA, Canada and Australia	1-3
1.4	Cleaning and Transporting the Field PG	1-5
2	Getting Familiarized with the SIMATIC Field PG P4	2-1
2.1	Components of the SIMATIC Field PG P4	2-2
2.2	Keyboard	2-9
2.3	Touchpad	2-13
2.4	LED displays	2-14
2.5	On/Off Pushbutton (Power Button)	2-15
2.6	Drives	2-17
2.6.1	Floppy Disk Drive	2-17
2.6.2	Hard Disk Drive	2-17
2.6.3	Optical Drive	2-18
2.7	External Power Unit and Battery	2-20
3	Configuring And Operating The SIMATIC Field PG P4	3-1
3.1	Unpacking and Setting Up the SIMATIC Field PG P4	3-2
3.2	Connecting to the Power Supply	3-4
3.3	Battery Operation	3-5
3.4	Commissioning	3-8
3.4.1	Cold Start of the SIMATIC Field PG P4	3-8
3.4.2	Restart of the SIMATIC Field PG P4	3-10
3.5	Panel "Field PG"	3-11
3.6	Connecting Peripheral Devices	3-12
3.7	Working with SIMATIC S5 Memory Submodules	3-16
3.8	Working with SIMATIC Memory Cards	3-17
3.9	Working with Micro Memory Cards	3-18
3.10	Working with PC Cards	3-19
3.11	Connecting the Field PG P4 to a SIMATIC S5 Network	3-20

3.12	Connecting the Field PG P4 to a SIMATIC S7 Network (MPI/DP)	3-21
3.13	Networking the Field PG P4 with Other Stations on PROFIBUS	3-23
3.14	Ethernet (RJ45 Ethernet Interface)	3-24
4	SIMATIC Field PG P4 Expansions	4-1
4.1	Installing Memory Expansion Submodules	4-2
4.2	Processor Upgrade	4-4
4.3	Replacing Backup Battery	4-4
5	Configuring the SIMATIC Field PG P4	5-1
5.1	Changing the Device Configuration with SETUP	5-2
5.2	The Main Menu	5-5
5.3	The Advanced Menu	5-14
5.4	The Security Menu	5-16
5.5	The Power Menu	5-17
5.6	The Boot Menu	5-19
5.7	The Version Menu	5-21
5.8	The Exit Menu	5-22
6	Error Diagnostics	6-1
7	Hardware Information	7-1
7.1	System Resources	7-2
7.2	Interface Pinout	7-3
7.3	Patch Cords	7-12
8	Reinstallation of the Software	8-1
8.1	Cause / Remedy	8-2
8.2	Restoring the Hard Disk (Data Deleted)	8-3
8.2.1	Restoring the Software to Delivery Condition Using the Restore CD	8-3
8.2.2	Creating Partitions under Windows NT	8-4
8.2.3	Creating Partitions under Windows 2000/XP Professional	8-5
8.3	Installing Drivers and Software	8-6
8.4	Installing the Recovery CD for Microsoft Windows NT	8-6
8.5	Installing the Recovery CD for Microsoft Windows 2000	8-8
8.5.1	Installing Drivers under Windows 2000	8-10
8.6	Installing the Recovery CD for Microsoft Windows XP	8-10
8.7	Installing the SIMATIC Software	8-12

A	Guidelines for Handling Electrostatically-Sensitive Devices (ESD)	A-1
A.1	What is ESD?	A-2
A.2	Electrostatic Charging of Persons	A-3
A.3	General Protective Measures Against Electrostatic Discharge Damage	A-4
B	Technical Specifications	B-1
	Glossary	Glossary-1
	Index	Index-1

Important Notes

1

1.1 Safety Instructions



Caution

The safety instructions given on the backside of the title page of this manual must be observed. Before adding to the Field PG P4's functionality by expanding the hardware configuration (see Chapter 4) observe the relevant safety instructions.

Notes on Inserting and Removing Modules

Modules containing electrostatically sensitive devices (ESDs) can be identified by the following label:

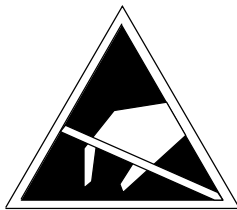

Please observe and carefully follow the guidelines mentioned below when handling modules equipped with electrostatically sensitive devices:

- Always discharge your body's static electricity before handling modules equipped with ESDs (for example by touching a grounded object).
- Devices and tools must be free of static electricity.
- Always pull the power plug and disconnect the battery before connecting or disconnecting modules (containing ESDs).
- Touch modules fitted with ESDs by their edges only.
- Never touch wiring posts or printed conductors on modules (containing ESDs).

1.2 Certificates, Directives and Declarations

Notes on the CE Symbol



The following applies to the SIMATIC product described in this operating instruction:

EMC Directive

This product fulfils the requirements for the EC directive 89/336/EEC on “electromagnetic compatibility” and the following fields of application apply according to this CE symbol:

Field of Application	Requirement for	
	Emitted Interference	Noise Immunity
Residential and commercial areas and small businesses.	EN 61000-6-3: 2001	EN 61000-6-1: 2001
Industry	EN 61000-6-4: 2001	EN 61000-6-2: 2001

The product is also compliant with the Standards EN 61000-3-2:2000 (Harmonic currents) and EN 61000-3-3:1995 (Voltage fluctuation and flicker).

Low Voltage Directive

This product fulfils the requirements for the EC directive 73/23/EEC on “low voltage” and was tested to EN60950.

Declaration of Conformity

The EC declarations of conformity and the documentation relating to this are available to the authorities concerned, according to the above EC directive, from:

Siemens AG
 Bereich Automation and Drives
 A&D AS RD4
 Postfach 1963
 D-92209 Amberg
 Tel.: 09621 80 3283
 Fax: 09621 80 3278

Observing the Setup Guidelines

The setup guidelines and notes on safety given in the manual must be observed on startup and during operation.

Connecting peripheral devices

Noise immunity when connected to industrial standard peripheral devices conforms with the requirements of EN 61000-6-2:2001.

ISO 9001 Certificate

The quality assurance system for the whole product process (development, production, and marketing) fulfills the requirements of ISO 9001 (corresponds to EN29001: 1987).

This has been certified by the German society for the certification of quality management systems (DQS).

EQ-Net certificate no.: 1323-01

Software License Agreement

The PG is shipped with the software already installed. Please observe the relevant license agreements.

1.3 Certification for the USA, Canada and Australia

Security

One of the following markings on a device is indicative of the corresponding approval:



Underwriters Laboratories (UL) to the UL 60950 standard, 3rd Edition.



Canadian Standard Association (CSA) to Standard C22.2. No. 60950

EMC

USA

**Federal Communications Commission
Radio Frequency Interference Statement**

This equipment has been tested and found to comply with the limits for a Class A digital device, pursuant to Part 15 of the FCC Rules. These limits are designed to provide reasonable protection against harmful interference when the equipment is operated in a commercial environment. This equipment generates, uses, and can radiate radio frequency energy and, if not installed and used in accordance with the instruction manual, may cause harmful interference to radio communications. Operation of this equipment in a residential area is likely to cause harmful interference in which case the user will be required to correct the interference at his own expense.

Shielded Cables

Shielded cables must be used with this equipment to maintain compliance with FCC regulations.

Modifications

Changes or modifications not expressly approved by the manufacturer could void the user's authority to operate the equipment.

Conditions of Operations

This device complies with Part 15 of the FCC Rules. Operation is subject to the following two conditions: (1) this device may not cause harmful interference, and (2) this device must accept any interference received, including interference that may cause undesired operation.

Canada

Canadian Notice

This Class B digital apparatus complies with Canadian ICES-003.

Avis Canadien

Cet appareil numérique de la classe B est conforme à la norme NMB-003 du Canada.

Australia



This product meets the requirements of the AS/NZS 3548 Standard.

1.4 Cleaning and Transporting the Field PG

Cleaning

To prolong the lifetime of your Field PG and use it free of trouble, do not expose it without cause to dust nor use aggressive cleaning agents to clean it.

- You can clean the display and the keyboard with customary screen cleaning tissues.
- The other case parts can be cleaned with a common household detergent.

Caution

Never spray cleaning liquids directly onto the device and prevent ingress of liquid.

Transportation

Despite of the rugged structure of the Field PG, its installed components are sensitive against severe vibration and impact. You can contribute to trouble-free operation by taking a few precautions for the transportation.

- Ensure that the computer does not access anymore drives before you prepare it for transportation.
- Remove all floppy disks or CD-ROMs from the respective drive.
- Switch off the PG (refer to Chapter 2.5).
- Disconnect all external devices from your PG.
- Close the display and the interface covers on the rear side of the device.
- Use the handle and for short transports.
- Pack the Field PG and all accessories into the supplied rucksack case if you are going to transport it over greater distances.

You should use the original package for the shipment of the programming device.

Getting Familiarized with the SIMATIC Field PG P4

2

What do you find in this Chapter?

This chapter briefly presents the most important components of the SIMATIC Field PG P4. Get familiarized with these elements before you start to commission the PG.

Chapter Overview



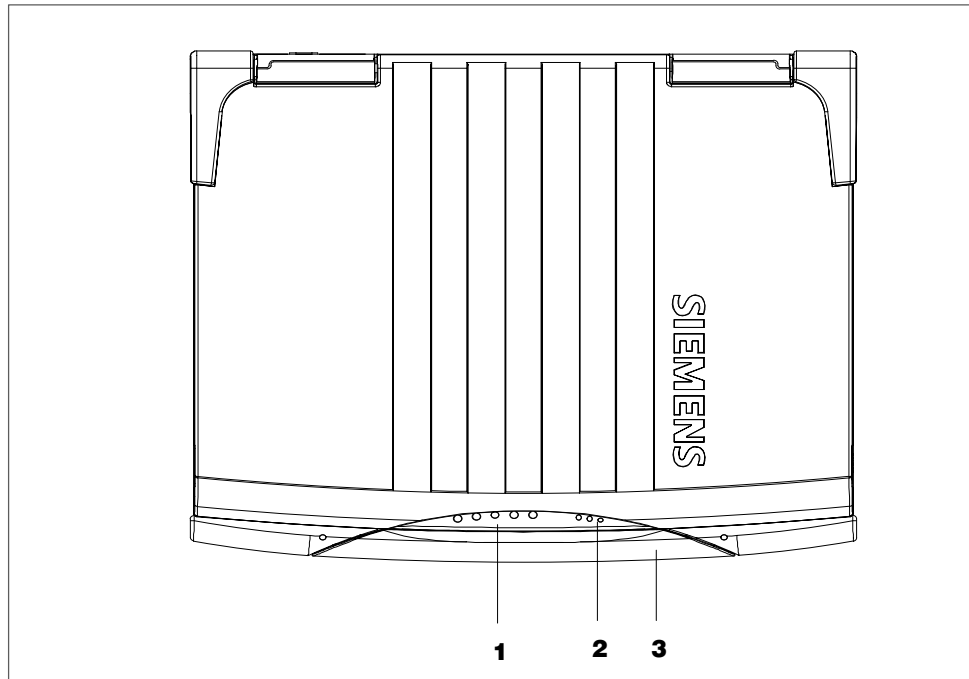

Section	Description	Page
2.1	Components of the SIMATIC Field PG P4	2-2
2.2	Keyboard	2-9
2.3	Touchpad	2-13
2.4	LED displays	2-14
2.5	On/Off Pushbutton (Power Button)	2-15
2.6	Drives	2-17
2.7	External Power Supply and Battery	2-20

2.1 Components of the SIMATIC Field PG P4

View with closed display



1 System-LEDs



The system LEDs (battery status  , device  , drives  , MPI/DP  and Memory Card ) indicate the status of the battery, unit, drives, MPI/DP and Memory Card interface.

These LEDs are also visible when the display is closed. The drive access displays are arranged on the right hand side of the corresponding drives.

For detailed information on these LED displays refer to Chapter 2.4 of the electronic manual.

2 Keyboard-LEDs

The keyboard LEDs display the current status of the shift keys Num Lock  ,

Caps Lock  and Scroll Lock  . When the unit is booting, the displays of these keys flicker briefly. The keyboard is ready for operation.

3 Device Handle

Folding handle for transporting the device.



Caution

Always stand the PG on its base. If you place it down on the interface side there is a risk that it will fall over and that sensitive components of the unit get damaged.

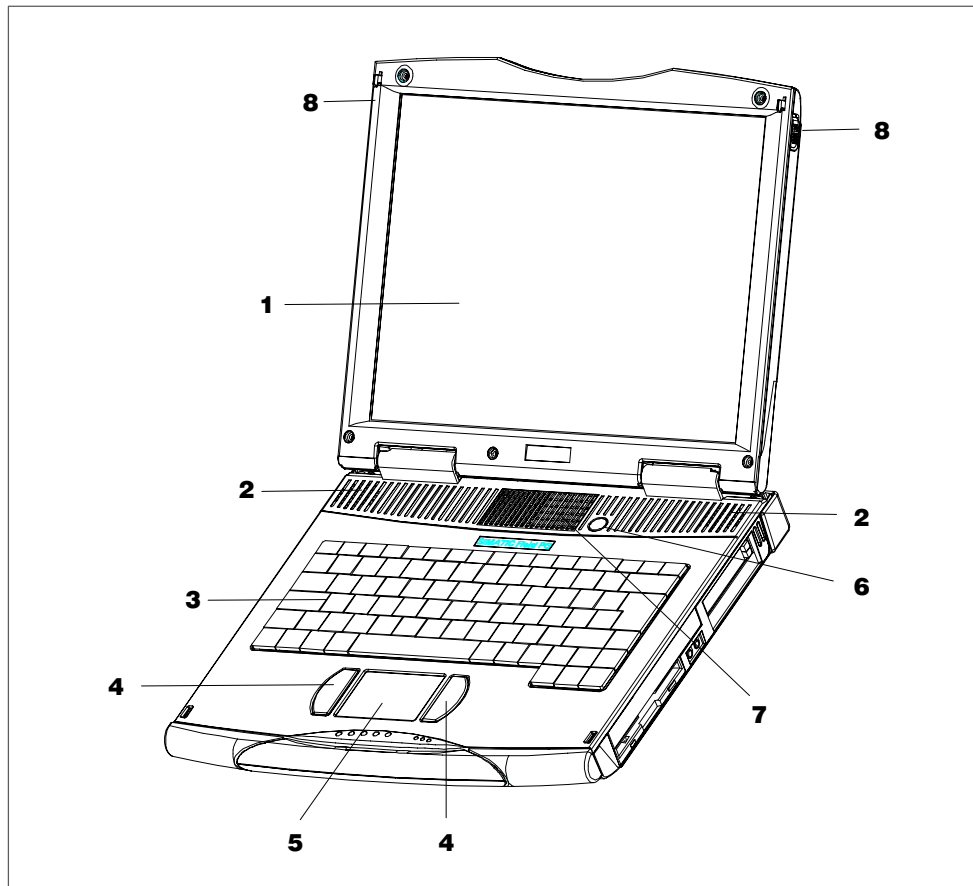
Front view with open display**1 Display**

The Field PG P4'S 14.1" TFT display has a resolution of 1024 x 768 pixels (XGA) or 1400 x 1050 pixels (SXGA+) with up to 256k colors.

2 Stereo Loudspeaker

The speaker outputs audio and system alarm signals generated by the software. The loudness is adjusted via speaker icon in the task bar or in the Windows Start menu via [all Programs > Accessories > Entertainment > Volume Control](#).

3 Keyboard

The keyboard is split into three key areas: the alphanumerical keyboard with special keys, the function keys and the control keys.

4 Mouse buttons

You can use the left or right mouse button to select menu items or process text or graphic objects after having marked the respective object.

5 Touchpad

The Touchpad has a pressure sensitive surface for precise mouse pointer positioning.

6 On/Off-button (Power Button)

Use the On/Off pushbutton to switch on the Field PG P4 (into active state) or to switch it from active to inactive state (Off, Standby or Hibernate). The Power Button can be parameterized in Windows. The Windows NT versions do not support this power management.

7 Air venting slots

Here is the ventiduct.



Caution

The ventiducts for incoming and outgoing air must not be obstructed. Otherwise, there is a risk of overheating. Do not operate your device with the display cover completely closed in order to guarantee optimum cooling.

8 Display interlock

The display unit is connected to the base unit with two locks. The slide interlock is mounted at the side of the display unit.

Rear view

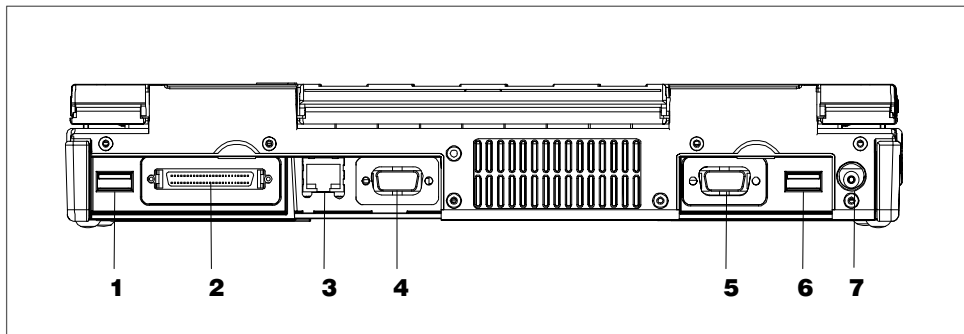

1 USB.

Universal Serial Bus connector. You can use the USB port (2.0) to connect external devices, for example, CD drives, printers, modems as well as a mouse and keyboard. The Windows NT versions only support mouse and keyboard.

2 Interface Cable (I Cable)

You can connect the I Cable supplied in the consignment to this port.

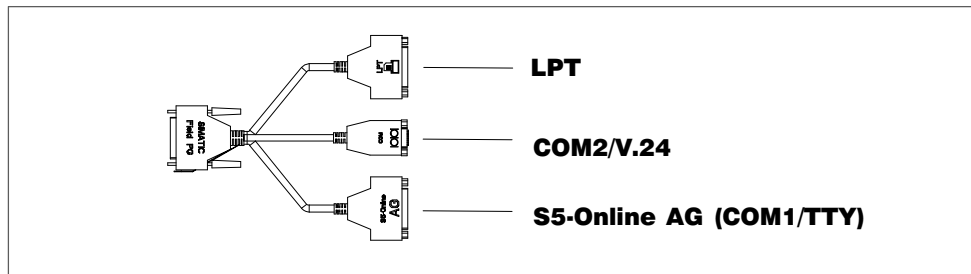

The I Cable enables the connection to S5 automation devices (COM1/TTY), to devices with a serial port (COM2/standard V.24) such as a modem or mouse and to devices with a parallel port (standard LPT) such as a printer or scanner. Please, use the I Cable on a level surface only (e.g. desk) to prevent contact problems.



Caution

Only the I Cable may be connected to this port. If you connect other devices with a 50-pin mini SCSI connectors, your Field PG P4 or the connected device may be damaged as a result.

3 Ethernet

RJ45 Ethernet connector. Ethernet is a local area network with a bus structure for data communication with a data transfer rate of 10/100 Mbit per second (Mbps).

4 MPI/DP Multipoint Interface

The MPI/DP interface is isolated from line potential. You can use it to connect the SIMATIC Field PG P4 to an S7 automation system or to a PROFIBUS network.

5 VGA

Here you can connect an appropriate external monitor.

Caution

Make sure the monitor can handle the resolution and refresh rate settings. Otherwise, it can result in damage.

6 USB

Second USB port 2.0.

7 DC-In 17.5 V

Socket for the DC output plug of the power supply that is included in your consignment.

View of the right side

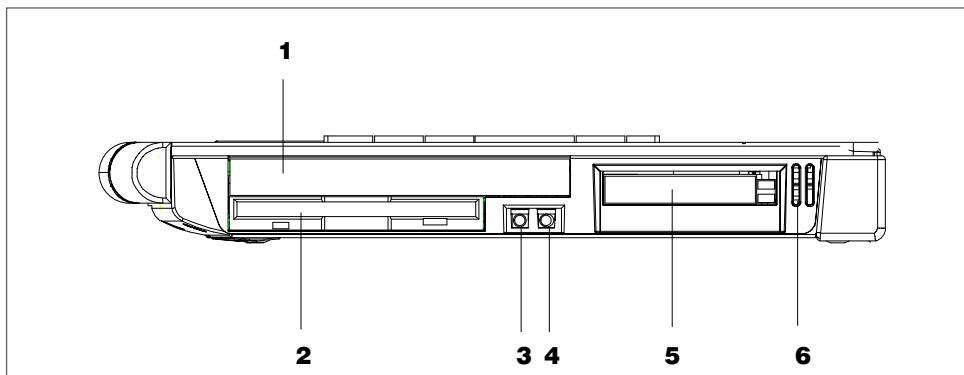

1 Optical drive

Depending on the device configuration, it can come with a DVD-ROM/CD-RW or a DVD±R/±RW drive. For example, you can read the electronic manual of the supplied "Backup PG" DVD with this drive.

2 Floppy disk drive

You can use 3.5 disks (with 1.44 Mbytes or 720 Kbytes of memory).

3 Headphones

You can connect an external stereo headphone or another audio output device to this headphone jack. The internal speaker is automatically disabled when a headphone is connected.

4 Microphone

You can connect an external microphone or another audio output device to this microphone jack.

5 PC Card slot

The PC Card slot accepts Cardbus (32 Bit) and PCMCIA (16 bit) cards. You can plug in credit card-size communication modules for MODEM, FAX-MODEM, ISDN, Token Ring, ETHERNET, memory expansions and SCSI interfaces. CardBus Cards are not supported by Windows NT.

6 Air venting slots

Here is the ventiduct.



Caution

The ventiducts for incoming and outgoing air must not be obstructed. Otherwise, there is a risk of overheating.

View of the left side

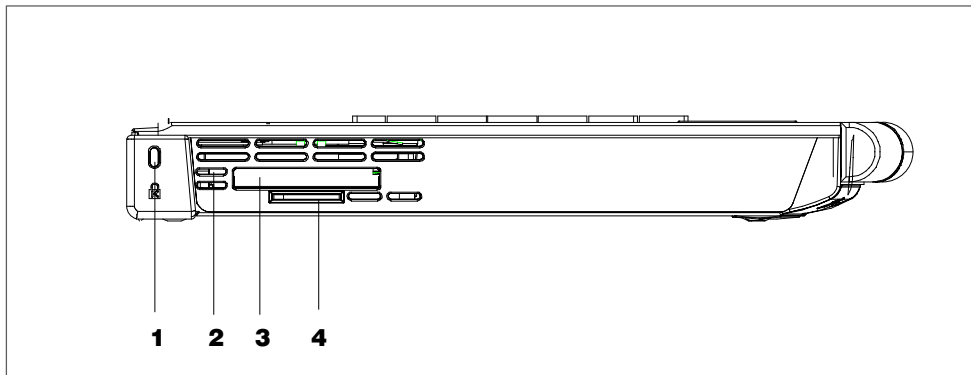
**1 Opening for the Kensington lock** 

Opening for the connection of a security cable. You can protect your PG against theft by locking the cable to a writing desk or any other heavy appliance.

2 Air venting slots

Here is the ventiduct.

**Caution**

The ventiducts for incoming and outgoing air must not be obstructed. Otherwise, there is a risk of overheating.

3 Memory Card interface 

Interface for reading, programming or deleting SIMATIC Memory Cards for SIMATIC S5 and SIMATIC S7. You can also use the supplied S5 adapter to program or read SIMATIC S5 EPROM submodules.

4 Micro Memory Card interface 

This interface can be used to read, program or delete Micro Memory Cards.

Bottom view

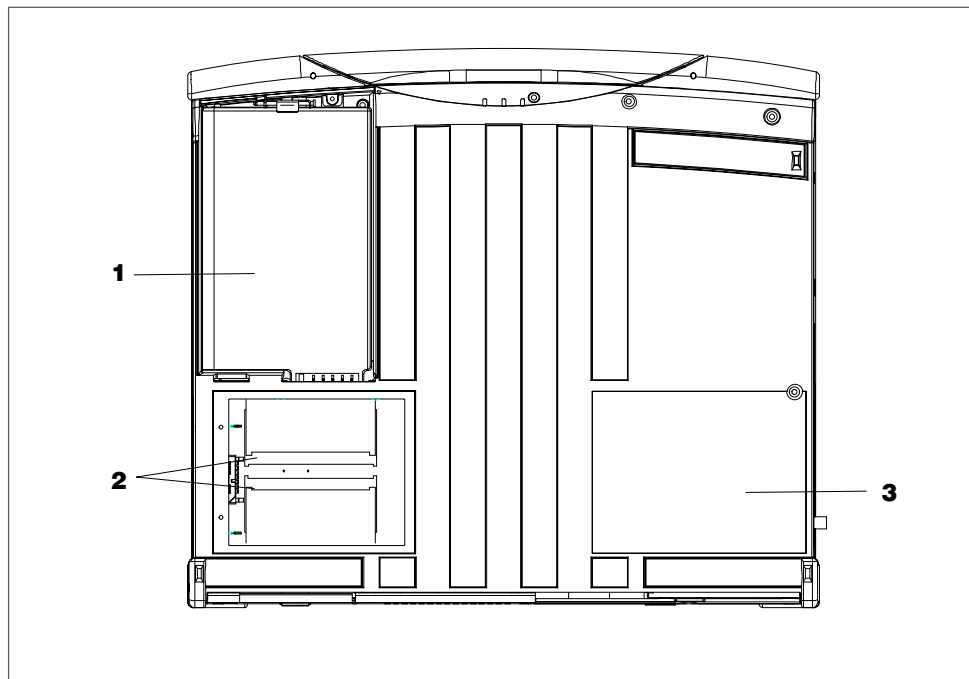

1 Rechargeable battery

The supplied rechargeable battery is installed behind a cover. The rechargeable battery (Lithium-Ion) makes the device portable, independent of an external power supply. The battery pack also prevents data loss in case of power failure. Use the rechargeable battery supplied with the device only. See also section 3.3.

2 Memory expansion

You can install memory submodules in these slots to increase main memory. Maximum memory expansion: 2 x 512 Mbytes. The memory modules can be accessed by removing the lid from the bottom of the device. See also section 4.1.

3 Rating plate and Certificate of Authenticity

The rating plate and “Certificate of Authenticity” with the Microsoft Windows “Product Key”. You need this to install new software.

2.2 Keyboard

Keyboard Layout

The keyboard is split into the following areas:

- Alphanumeric or typewriter keyboard with special keys
- Function keys
- Cursor control keys.

Repeat Function

All the keys on the keyboard are of the autorepeat type. The character is repeated as long as the key is pressed.

Keyboard Caps

The keyboard comes with international and German labeling.

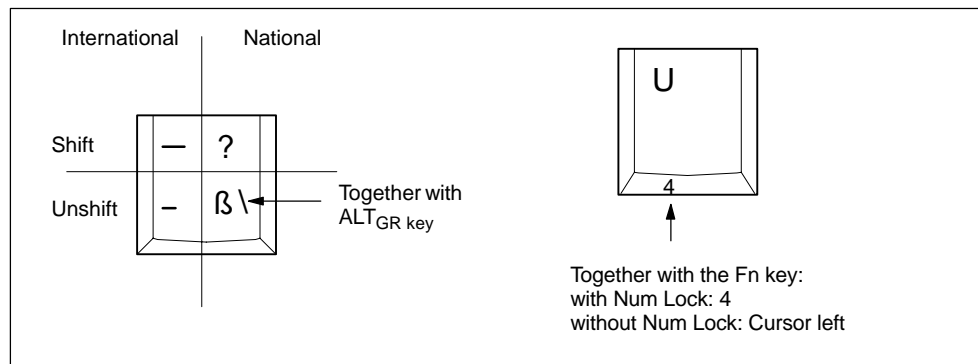

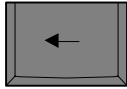
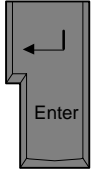
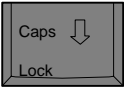

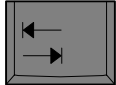

Fig. 2-1 The Keyboard Labeling System





Alphanumeric Keyboard

The largest block of keys on the keyboard is the alphanumeric keyboard with all the keys for the letters of the alphabet, numerals and special characters. The characters are arranged in basically the same way as on a normal typewriter. However, there are a number of special keys which have special functions for the SIMATIC Field PG P4.

Special Keys

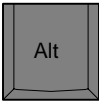
The special keys in the alphanumeric keyboard have the following functions:

Key	Function
	<p>Backspace key</p> <p>This key moves the cursor one space to the left and deletes the character at this position.</p>
	<p>Enter Key</p> <p>(Return, Enter, Line Feed (“New Line”))</p> <p>The return or enter key is used mainly to terminate a command line in the operating system; that is, the command you have entered is executed when you press this key. For other uses of this key, please refer to the user manual of the relevant user program.</p>
	<p>CAPS LOCK Key</p> <p>If you press this key, the middle LED at the top right-hand corner of your keyboard lights up. All letters are output as upper case letters and the numbers as special characters. If you want to type lower case letters in this position, you must first press the shift key.</p> <p>If you are using an international keyboard, you cancel this function by pressing the CAPS LOCK key again. The LED then goes out.</p> <p>If you have a German keyboard, you must press the shift \$ key to cancel this function.</p>
	<p>NUM Key</p> <p>With these keys $F_n + \wedge \text{NUM}$, the emulated numeric block is switched from the alphanumeric keyboard to numeric keys. The LED display lights up. Press this key again to return to cursor control.</p>
	<p>Scroll-Lock-Taste</p> <p>Monitor scrolling is either enabled or disabled with this key.</p>
	<p>Tab Key</p> <p>This moves the cursor depending on the selected tabulator positions.</p>
	<p>“Fn” Special Key (combination key)</p> <p>In conjunction with a second key (key combination), you activate other key codes for special applications with this key. This key is also used to emulate the numeric keypad (Figure 2-3 Numeric Keypad).</p>
	<p>CTRL Key (combination key)</p> <p>This key is only used in combination with other keys. For example, you press CTRL + ALT + Delete to reset and restart the operating system. For other uses of this key, please refer to the user manual of the relevant user program.</p>

Key	Function
	<p>ALT Key (combination key)</p> <p>This key is only used in combination with other keys. For example, you can enter the hexadecimal value of an ASCII character using this key and the numeric keypad for example, F_n + ALT + 132 corresponds to "ä".</p>
	<p>ALT_{Gr} Key (combination key)</p> <p>You can use this key together with the other combination keys to generate other key codes. For example, you can generate the "ü" character on the German keyboard by typing ALT_{Gr} + ß.</p>
	<p>PRINT (combination key)</p> <p>Using the Print key, you can output the current screen display to a printer (depending on the software used).</p>
	<p>PAUSE (combination key)</p> <p>The Pause key interrupts program execution in the majority of applications.</p>

Cursor Keys

The key block shown in the picture below is used for cursor control. Home and End are operated in combination with the Fn key.

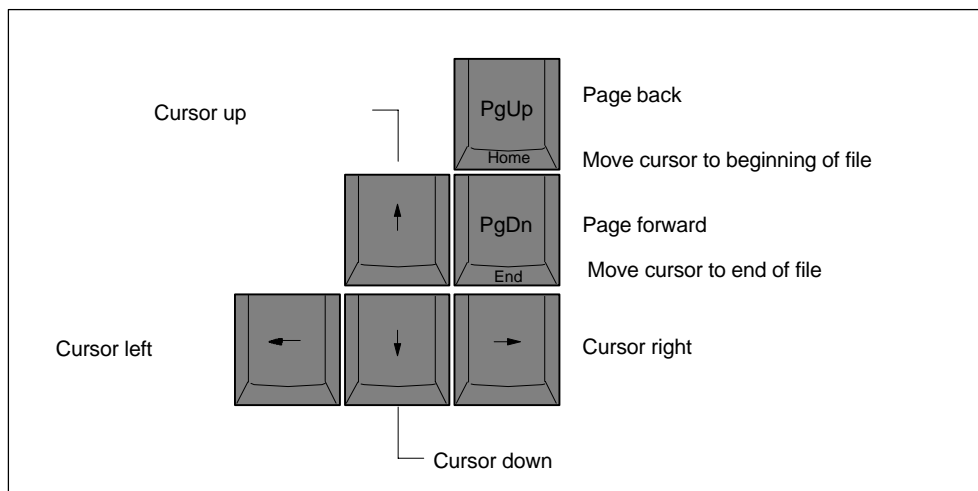

Fig. 2-2 Cursor Keys

Numeric Keypad with Fn Key

By pressing F_n and one of these keys, the numbers and characters can be used provided Num Lock is switched on.

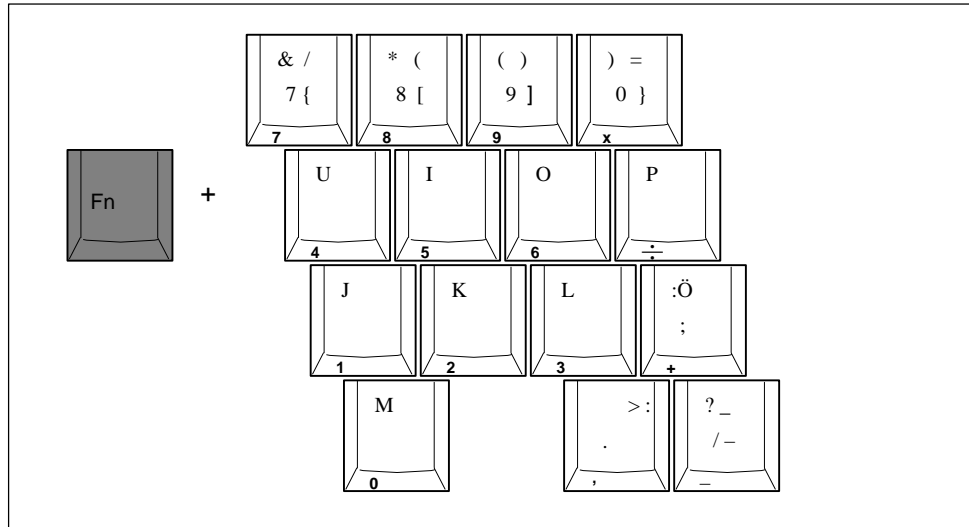

Fig. 2-3 Numeric Keypad

Function Keys

A row with twelve programmable Function Keys is located above the alphanumeric keyboard. The individual function of these keys depends on the software you are working with.

2.3 Touchpad

Definition

The Touchpad is an input device for cursor control and menu operation (with mouse operation) in numerous programs. You can move the cursor to any screen position by touch.

A left button click on sets the mark. The right button assignment varies, depending on the user program. You can select objects, process menus or trigger functions with this Touchpad.

Operation

You can use the Touchpad the very same way as a mouse: the mouse pointer on the screen follows the movement of your finger on the pad.

You can click on icons or text with both mouse buttons. First, move the mouse pointer onto the icon. Then, select the icon with a left click.

As an alternative, in a fully graphical user interface, for example, the Windows GUI, you can mark an icon and then move the mouse pointer on top of it. You can then open the icon with a double tap on the Touchpad.

You do not have to apply any pressure on the pad with your finger. The sensor does not react to finger pressure, but rather to the brief capacitance change on the touch point.



The touch pad function (mouse pointer and buttons) can be toggled on and off with the key combinations Fn + ~.

2.4 LED displays

Keyboard LEDs

LED displays for the Num-Lock, Shift-Lock and Scroll-Lock keys. They indicate the current status of the shift keys.



Meaning of the keyboard LEDs

Symbol	LED	Meaning
	green off	Num-Lock on Num-Lock off
	green off	Shift-Lock on Shift-Lock off
	green off	Scroll-Lock on Scroll-Lock off

System LEDs

The system LEDs (battery, device, drives, MPI/DP and Memory Card) indicate the status of the battery pack, the unit, the drives as well as the MPI/DP and Memory Card interfaces. These LEDs are also visible when the display is closed.

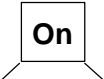
Meaning of the System LEDs

Symbol	LED	Meaning
	green orange red off	Battery is charged Battery is being charged Battery low (only with battery operation) No battery installed
	green orange green flashing orange flashing off	Line operation Battery operation Line operation, system in Standby mode Battery operation, system in Standby mode Unit is switched off
	green	Access to external storage media (hard disk drive, optical drive, floppy disk drive)
MPI/DP	green	MPI interface active
	green	Module programming, Memory Card or Micro Memory Card active

Note

Battery charging is terminated when the battery pack is fully charged or if, for example, the upper temperature limit is exceeded during charging. The current battery status can be queried in Windows 2000 and Windows XP.

2.5 On/Off Pushbutton (Power Button)

Switching the Field PG P4 On

Hold the On/Off button (Power Button) down for approx. 1 second to switch on the device.

Switching the Field PG P4 Off

Either close the display lid, actuate the On-/Off-pushbutton (Power Button) or select the respective Windows Start menu command to toggle the Field PG P4 from normal mode to one of the following modes:

- Standbymode (Save to RAM),
- Hibernate (Save to Disk),
- Off (Windows is shut down).

If operated under a Windows OS the device is switched off automatically when you shut it down. If not operated under Windows you can switch the device off via On-/Off pushbutton.

Notice

The Windows NT versions do not support the standby and hibernate operating modes. After shut down the Field PG always has to be switched off via the Power Button.

Hold down the On-/Off pushbutton for more than 7 seconds to trigger the "Override" function. The device is switched off.

Note

Via **Setup > Control Panel > Power Management** under Windows 2000 and Windows XP you can parameterize the reaction of the On-/Off-pushbutton and of the display lid.

To isolate the unit totally from the power supply system, you must unplug the patch cord and remove the rechargeable battery.

Caution

The Field PG P4 supports different operating modes, according to the settings in the Windows power options. The power options are preset at the factory in such a way that the device always switches to defined operating modes (On, Standby, Hibernate, Off).

When changing these settings or updating the device with additional hardware (for example, USB components) or additional software, the operating modes can be influenced in such a way that the device can no longer switch to the hibernate or standby mode. Although the screen is dark, relevant components remain active and consume power.

Before transporting the Field PG P4 in the carrying case, always shut it down or set it to hibernate mode. You can recognize these modes when all status LEDs are switched off after the power supply has been disconnected. By doing this you can be sure that the device is not switched on during transport and that the battery is not unintentionally discharged.

Energy Options

You can optimize the energy consumption of your PG using the energy options while maintaining the PG in operate state.

In **Standby mode** the screen and the hard disk drive are switched off to relieve the battery pack. After you switch the PG back to normal mode the desktop is restored with your last configuration. Since PG memory information is not written to the hard disk drive, you should save your job before you switch the PG to standby mode. Information stored in memory is lost in case of a power failure.

Note

Select this mode if you briefly interrupt your work (few hours).

In **Hybernate mode** the screen and hard disk drive are switched off. All data in memory is stored to the hard disk drive before the PG is switched off. When you switch on your PG again, all programs and documents that were opened at the time of shut-down are restored to the desktop. Hybernate mode relieves the battery pack even more than Standby mode. However, it requires a longer time to reactivate the PG from this hybernating state.

Note

Select this setting if you want to interrupt your work over an extended period (several hours) or over night.

Briefly push the On/Off button to reactivate the PG from Standby or hybernate mode. In standby mode the system LED flashes, in hybernate mode all displays are switched off.

2.6 Drives

2.6.1 Floppy Disk Drive

You can use 3.5 disks (with 1.44 Mbytes or 720 Kbytes of memory).

Handling Diskettes

Access to the floppy drive is displayed by the drive's status indicator and on the status indicator for external devices at the front of the keyboard.

Caution

Risk of data loss!

Do not remove diskette until the access indicator on the drive has been switched off.

2.6.2 Hard Disk Drive

Hard disk drives with different capacity can be operated with the Field PG P4.

Whenever the hard disk is accessed, the status LED for external storage media at the keyboard front lights up.

Caution

Drives are sensitive to vibrations and shock. Any vibrations occurring during operation can result in loss of data or damage the drive.

2.6.3 Optical Drive

Depending on the device configuration, it can come with a DVD-ROM/CD-RW or a DVD±R/±RW drive. For example, you can read the electronic manual of the supplied Backup PG DVD with this drive.

Opening the Drawer

Switch on the programming device. By briefly pressing the eject button, the drawer springs out slightly. Now pull the drawer out until it clicks into position.

Inserting / Removing the data medium

Now insert the data medium in the drawer with the labeling face up, and press it firmly down into the center of the turntable. To remove the data medium, hold it by the edges and pull upwards.

Closing the Drawer

Push in the drawer until it closes completely. Do **not** press the eject button.

Emergency removal

By pushing a pin into the emergency release opening (for example, a paper clip) while the device is switched off, you can force the drawer to open.

Notice

To ensure that the open drawer of the drive is not exposed to excessive force, **always** support the front of the drawer with one hand while inserting or removing the data medium with the other.

The data medium is tested when you close the drive and the access LED on the drive flashes to indicate that the test is in progress:

- if the LED does not stop flashing the data medium is bad but readable,
 - if the LED flashes several times and then remains on, the data medium is not readable and defective.
-

Caution

Risk of data loss and damage to the drive.

Optical drives are highly sensitive to excessive vibration. Vibration during operation can damage the drive or the data medium.

The burning operation with the DVD-ROM/CD-RW and DVD±R/±RW drive is only permissible in an untroubled environment and under an ambient temperature not exceeding 35°C.

Additional Software

To be attain the full functionality of the DVD-ROM/CD-RW or DVD±R/±RW drive, additional software (DVD player or burner software) is necessary. You can find it on the CD included in the delivery of the device. To install the software place the CD in the drive and follow the instructions on the screen.

Caution

Risk of data error when burning a CD-RW or DVD±RW!

The quality of recordable data media vary considerably, data error can therefore not be completely ruled out when writing a data medium, even when no error message is displayed. Correctly written data can only be guaranteed by an additional comparison with the source data. To ensure an error-free copying process do a data comparison after every burning session.

2.7 External Power Unit and Battery

External Power Unit

External power supply for the SIMATIC Field PG P4 for operation on 120 V or 230 V power supply networks. The voltage range is selected automatically. With line operation the integrated battery is charged at the same time. The connecting cable for the SIMATIC Field PG P4 is installed fixed on the external power supply. The external power supply is connected with a patch cord to the mains.



Warning

The SIMATIC Field PG P4 must only be operated with the correct external power supply and/or battery enclosed with the device.

The external power supply must not be covered up (risk of overheating).

Notice

The power plug must be disconnected to isolate the unit completely from mains.

A CSA or UL-listed cord set must be used for operation in Canada and the USA.

For the United States and Canada:

In the United States and Canada the cord must be UL-listed and CSA Labeled. The male plug is a NEMA 5-15 style.

For operation with 120 V:

Use a UL-listed, CSA Labeled Cord Set, consisting of a min. 18 AWG. Type SVT or SJT three conductor flexible cord, max. 4.5 m (15 feet) in length and a parallel blade grounding type attachment plug, rated 15 A, min 125 V.

For operation with 240 V (within the USA):

Use a UL-listed, CSA Labeled Cord Set, consisting of a min. 18 AWG. Type SVT or SJT three conductor flexible cord, max. 4.5 m (15 feet) in length and a tandem blade grounding type attachment plug, rated 15 A, 250 V.

For operation with 230 V (outside of USA):

Use a cord set consisting of a min 18 AWG cord and grounding type attachment plug rated 15 A, 250 V. The cord set should have the appropriate safety approvals and marks for the country in which the equipment will be installed.

The unit is intended for operation with grounded power supply networks (TN networks, VDE 0100 part 300 or IEC 364-3).

Operation with non-grounded or impedance-grounded networks (IT networks) is not permitted.

The cord set must meet safety requirements in the respective country.

Battery

The supplied rechargeable battery is installed behind a cover. The rechargeable battery (Lithium-Ion) makes the device portable, independent of an external power supply. The battery pack also prevents data loss in case of power failure. Use the rechargeable battery supplied with the device only.

Once the external power supply unit is connected, the battery is charged. The following conditions are important:

- When the device is switched off, charging takes approximately 3 hours (fast charging).
- When the device is switched on, charging takes approximately 3 to 6 hours (depends on the system load).
- Charging stops as soon as the battery is fully charged.
- A fully charged battery that is put on shelf runs down within approximately 2 to 4 months (depending on the temperature and whether it is installed). It must then be recharged.
- Battery charging is terminated when the battery pack is fully charged or if, for example, the upper temperature limit is exceeded during charging. The current battery status can be queried in Windows 2000 and Windows XP. See also Section 3.3 Battery Mode.
- It is advisable to run a teach-in cycle every now and again (see Section 3.3).

When the unit is connected to the power supply, the green battery LED indicates that the battery is fully charged. Battery charging is then stopped.

Notice

When not used over an extended period (> one week), switch off the Field PG P4 and remove the battery (see Section 3.3).

The battery LED lights red to warn of pending total discharge (see Section 3.3)

Please note that you must disconnect the power cord to separate the device totally from mains.

You can check the battery status directly on the battery pack. Press the marked spot on the battery briefly. The status is then displayed by the four LEDs.

The electronics of the battery has to be calibrated at regular intervals (see Section 3.3) to compensate for measurement errors in the electronics and also because the chemical properties of the battery change with time.

The capacity of the Lithium/Ion battery pack used in the Field PG P4 is reduced each time it is charged / discharged, or if it is stored under temperature conditions out of the specified hi and lo limits. This is why the operating time with one battery charge may eventually be reduced considerably.

The rechargeable battery has a typical service life of 300 charging cycles, i.e. under normal conditions of use it can be charged and discharged within six months after you have purchased the PG. Capacity loss beyond this time is technology-related, and warranty is therefore excluded by all manufacturers of similar devices. We recommend you replace the battery pack if the performance deteriorates significantly. Always use the original Siemens battery packs.

Notes on the service life of your battery pack:

- The battery pack should always be fully charged / discharged – same as the calibration of the battery.
- Frequent use: The more often you use the battery pack, the faster it reaches the end of its service life. The Lithium / Ion battery pack has a typical service life of 300 charging cycles.
- If the computer is usually operated by means of the power adapter, you should fully load the battery pack and remove it for separate storage.



Warning

- Do not disassemble or mutilate, may cause burns.
 - Do not incinerate or heat, may cause burns, explosion or release toxic materials.
 - Do not short circuit, may cause burns.
 - Keep away from children.
-

Configuring And Operating The SIMATIC Field PG P4

3

What Does This Chapter Contain?

The chapter below describes all tasks required to successfully set up your workplace. These include:

- initial steps for commissioning your SIMATIC Field PG P4,
- working with battery operation and replacing the battery,
- connecting peripheral devices,
- working with memory submodules for the PLC and
- connecting your PG to other devices.

Chapter Overview

Section	Description	Page
3.1	Unpacking and Setting Up the SIMATIC Field PG P4	3-2
3.2	Connection to the Power Supply	3-4
3.3	Battery Operation	3-5
3.4	Commissioning	3-8
3.5	Panel "Field PG"	3-11
3.6	Connecting Peripheral Devices	3-12
3.7	Working with SIMATIC-S5 memory submodules	3-16
3.8	Working with SIMATIC Memory Cards	3-17
3.9	Working with Micro Memory Cards	3-18
3.10	Working with PC Cards	3-19
3.11	Connecting the Field PG P4 to a SIMATIC S5 Network	3-20
3.12	Connecting the Field PG P4 to a SIMATIC S7 Network (MPI/DP)	3-21
3.13	Networking the Field PG P4 with Other Stations on PROFIBUS	3-23
3.14	Ethernet (RJ45 Ethernet Interface)	3-24



Warning

When connecting long signal lines (especially for plant-wide connections), make sure that the signal lines are connected to the local equipotential grounding system (cable shield connected to protective conductor).

3.1 Unpacking and Setting Up the SIMATIC Field PG P4

Unpacking Your SIMATIC Field PG P4

Unpack your SIMATIC Field PG P4 as follows:

1. Remove the packing.
2. Do not throw the original packing away. Keep it if you need to transport the device at a later time.

Checking the Contents

3. Check the packing list to make sure that no components are missing
4. Check the packing and its contents for any transport damages.
5. Please inform your local dealer of any shipping damages and discrepancies between contents and packing list.

Entering the Serial number (S VP) and the Ethernet address

6. Enter the **serial number** (S VP) and the **Ethernet address** of your programming device in the table of the Getting Started. You can find the serial number on the type label attached to the base of the device. The Ethernet address can be found in the BIOS setup settings in the main menu under the 'Hardware Options' function.

If the device has to be repaired or has been stolen, it can easily be identified by these numbers.

Entering the Microsoft Windows “Product Key” from the “Certificate of Authenticity”

7. Enter the Microsoft Windows “Product Key” from the “Certificate of Authenticity” (COA) in the table of the Getting Started. You will find the “Product Key” on the device. You need the Windows “Product Key” if you want to reinstall the operating system.

Setting up your SIMATIC Field PG P4

Find a comfortable and safe working position for your SIMATIC Field PG P4.

1. Put the SIMATIC Field PG P4 down on its base on an even surface at a comfortable working height and distance.
2. Ensure there is an easily accessible mains outlet near your place of work.
3. Make sufficient desk space available to connect peripheral devices.
4. Open the display, by pulling the slide locks at the side of the display unit towards the front.
5. Fold up the display and adjust it to a comfortable angle of inclination. The display angle is adjustable from 0 ... 180°.

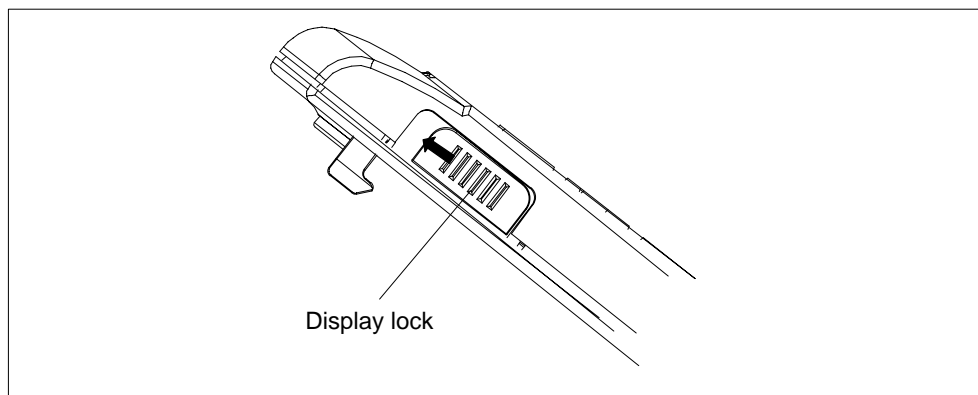

Fig. 3-1 Opening the Display

Caution

Always put the Field PG P4 down on its base. If you put it down on its interface side you risk that it will fall over and damage sensitive internal components.

Moisture ingress can damage the PG.

If you transport the device in cold weather and if it is exposed to extreme temperature fluctuation you have to acclimatize it to room temperature before you start to operate it.

Do not switch on the device until inside condensation has dried off completely. This is the case, for example, with a temperature rise from -20°C to + 20°C and after a waiting period of approx. 12 hours.



Warning

The computer casing is made of magnesium. Contact with an external open fire source bears the risk of fire / spreading fire.

3.2 Connecting to the Power Supply

Connecting to the Power Supply

The SIMATIC Field PG P4 can be operated with the supplied external AC adapter on 120 V/230 V power systems or with the battery. The external power supply automatically selects the voltage. You should install the supplied battery pack before you connect the device to the power supply:

1. Turn the Field PG P4 over and place it down on the table while the display unit is closed.
2. Unlock and open the battery pack cover on the bottom of the device.
3. Insert the battery pack.
4. Close the cover and turn the device over again.
5. Plug the supplied patch cord into the external power supply and plug the low-voltage plug into the unit's connector.
6. Connect the external power supply to a socket outlet with grounded protective conductor.

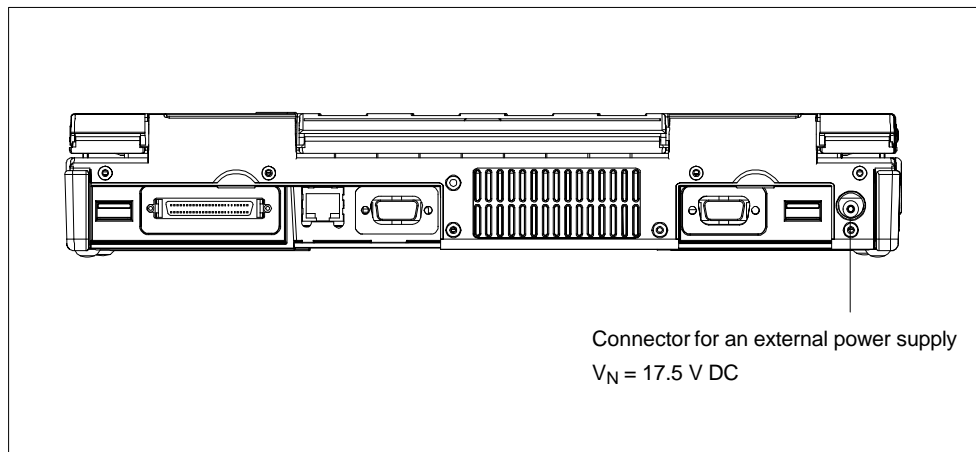

Fig. 3-2 Power supply connection



Warning

The SIMATIC Field PG P4 must only be operated with the provided power supply unit and/or battery pack.

The external power supply must not be covered up (risk of over-heating).

For reasons of safety you must use the patch cord and power supply that is included in the delivery. Operation of the unit is only permitted on grounded 120V/230V power supply networks.

3.3 Battery Operation

Battery Operation

If not connected to an external power supply unit, the SIMATIC Field PG P4 can be operated with the internal battery pack.

1. Switch on the device. Make sure the battery is sufficiently charged before you start work.
2. Work as usual with your SIMATIC Field PG P4.
3. In battery mode, the red signal of the battery LED indicates that the battery is in low condition. Stop your work and save your data. There are only a few minutes of battery operation remaining.

Notice

Do not start a work session in battery mode unless the battery is fully charged. This is the only way of ensuring that the full on-battery operating time is available and that you will be warned in good time when battery power is low. When connected to the external power supply unit, the orange battery LED indicates that the battery is being charged.

When connected to the external power supply unit, the green battery LED indicates that the battery is fully charged and that charging has stopped.

The battery might be partially or totally discharged when you start commissioning (for example, running-down). Connect the device to the power supply unit and the unit to mains to charge the battery.

As soon as the device is connected to mains via the power supply unit, the battery is recharged.

Replacing the Battery

You can replace a run-down or defective battery with a new replacement battery:

1. Turn the Field PG P4 over and place it with closed display unit onto a flat mat.
2. Unlock and open the battery cover on the bottom of the casing.
3. Replace the battery.
4. Close the cover and turn the device over again.



Warning

Do not use a battery type other than that supplied. The battery is available as spare part. Refer to the catalog for ordering data.

Disposal of Used Batteries

Lithium-Ion batteries can be recycled. Their components can be used as raw materials for new batteries or other products. Effective recycling of batteries is only possible when the used batteries are collected according to type.

Notice

Observe the local regulations for disposal of recycling materials.

Charge-Status Indicator

The battery has electronic circuitry for showing the current charge status. The electronics incorporate a metering unit which has to be calibrated at regular intervals so that it can compensate for error. The chemical properties of the battery change in the course of time, so the electronics have to relearn the battery's characteristics at regular intervals. A calibration cycle ensures that the battery's maximum charge capacity is at your disposal.

Notice

There is a danger of the charge-status indicator misinterpreting the actual capacity of the battery if a lengthy period of time is allowed to pass between calibration cycles. This can result in an unexpected shutdown with no prior warning.

Calibration cycle

Run a calibration cycle:

- Approximately every six months,
- if a prolonged period of time has elapsed since the battery was last used,
- if you think that the battery no longer operates at full capacity,
- if the programming device shuts down unexpectedly with no prior warning,
- if operating time on battery becomes shorter.

Performing a Calibration Cycle

Broadly speaking, the procedure for a calibration cycle is as follows:

1. **Before starting battery calibration**, you have to select **SIMATIC battery calibration** under **Control Panel > Power Options**, then deactivate the options **Activate battery alarm when power level reaches** in the tab **Alarms** under **Control Panel > Power Options**.
2. **Battery operation**: Discharge the battery until the battery LED on the device changes from red to green. To do this, remove the power supply from the Field PG P4.
Duration: max. 3 hours.
3. **Power supply operation**: Fully charge the battery (without interruption) until the battery LED on the device changes from orange to green. This will take a maximum of 4 hours if the device is switched off. (Optional: to reduce the recharge time, switch off the device if possible).

You can carry out an automatic calibration cycle with the “Field PG” panel (see section 3.5).

3.4 Commissioning

Switching on the Field PG P4

The operating system and system software supplied with the SIMATIC Field PG P4 are preinstalled on the hard disk. Time consuming installation of the operating system and SIMATIC software programs is not required. Just unpack and power up your unit and you can immediately start your programming tasks without having to take extensive setup actions.

- To power up the device hold down the On/Off switch for on the top side of the keyboard for at least one second. When powering up the device you have to distinguish between the following:
 - **Initial start** to set up the Field PG P4's software and a
 - **Restart** after cold start and software activation.

3.4.1 Cold Start of the SIMATIC Field PG P4

When powering up the SIMATIC Field PG P4 for the **first** time the operating system is set up automatically (depending on the version delivered: Windows NT, Windows 2000 Professional or Windows XP Professional). Please proceed as follows:

1. Switch on the Field PG P4.
2. The PG executes a self-test. During self-test the following message appears on the screen:

```
Press <F2> to enter SETUP or <ESC> to show Bootmenu
```

Wait until the message disappears and follow the instructions displayed on the screen.

3. Enter your product key. The product key can be found on the device in the line "Product Key" of the "Certificate of Authenticity".

Caution

Do not switch off the PG during cold start. Otherwise, full initialization will fail.

Do **not** change the BIOS default values.

Startup under Windows

Once you have entered the requisite information and configured the operating system the PG is rebooted. The **Welcome** screen helps you to get familiar with the Desktop - user interface.

Now the user interface is displayed following system startup every time you power up or reset the PG.

Default country code of the Windows XP menus, dialogs and keyboard layout is English. You can set another language and keyboard via the control panel with the dialog **Start > Control Panel > Date, Time, Language, and Regional Options > Add other languages**.

Authorization/ License Key

To use the STEP 5 or STEP 7 programming software, you require a product-specific authorization or a License Key. Software protected thus may only be used with the corresponding activation. The authorizations and license keys for the SIMATIC software can be found on the License Key Disk supplied with your PG.

To perform the software activation:

- Insert the License Key Disk in drive A:
- Click on the Windows **Start** button and
- select the menu command **Simatic > License Management> Automation License Manager** to open the Automation License Manager. It will guide you through the installation routine of the authorizations or License Keys onto your hard disk.

Notice

The License Key Disk supplied with the PG contains only authorizations or License Keys for the SIMATIC software you ordered only. The SIMATIC software you receive will correspond to your order form.

The License Key Disk of the supplied version "Upgrade Installation" contains only the software for upgrading already existing authorizations or License Key. Software without authorizations or a License Key in the scope of supply cannot be used when installed on the PG.

Keep the License Key Disk in a safe place so that you can save the authorizations or License Keys to diskette.

Additional software

You can now install the the supplied operating software for the DVD-ROM/CD-RW or the DVD±R/±RW drive. Place the CD in the drive and follow the instructions on the screen.

3.4.2 Restart of the SIMATIC Field PG P4

Once the Field PG P4 is configured, the user interface of the corresponding operating system is displayed following system startup every time you switch on or reset the PG.

Starting SIMATIC Software Programs

STEP 5 (not available on all delivered versions)

- Click "Start" on the Windows button and select the desired program choosing **Simatic > STEP 5**.

Please note that you have to install the authorization disk before you start working with STEP 5 (see Section 3.4.1).

Notice

When you use the P Tools (for editing PCP/M files) supplied with STEP 5, remember that these are not fully supported by the Windows 2000 Professional or Windows XP Professional operating systems. If you use the P Tools, we recommend that you use MS-DOS, Windows 3.x or Windows 95.

STEP 7

- Click on the icon "SIMATIC Manager" on the Windows desktop or
- or click on "Start" and select the desired program by choosing **Simatic > STEP 7**.

Note

The transfer of a STEP 7 configuration from on PG to another is supported by the STEP 7 file archiving functions. Open the SIMATIC Manager. select the menu command **File > Archive** or **File > Retrieve**. You can find details on this procedure in the STEP 7 online help, section "Steps to take for Archiving/Retrieving".

STEP 7-Micro/WIN 32

- Click on the On the "STEP7-MicroWIN" icon on the Windows Desktop or
- Click "Start" on the Windows task bar and select the desired program with **Simatic > STEP 7-MicroWIN 32**.

3.5 Panel “Field PG”

Panel “Field PG” helps you to work better with the Field PG P4. It has the following functions:

- Automatic execution of battery calibration.
- Setting the display brightness
- CPU and motherboard temperature display
- Setting the hardware properties of the PC Card and the MPI and Ethernet interface
- Display of firmware versions
- Selecting the display device (display / external monitor)

The Panel is installed on devices with Windows XP and Windows 2000.

- Start the program via **Start > Settings> Control panel> Field PG**.

You can find additional support during operation in the respective Online Help.

3.6 Connecting Peripheral Devices

Connect devices to the I Cable

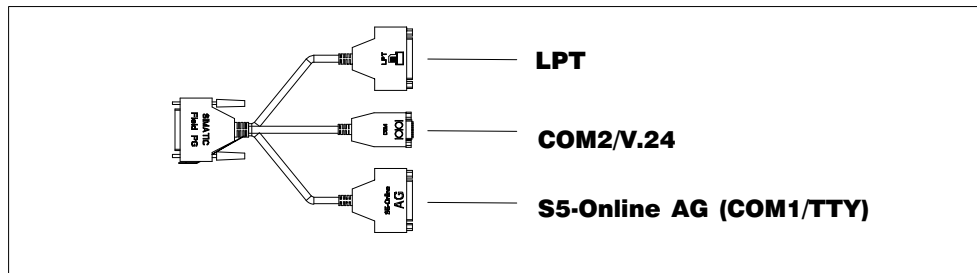

Fig. 3-3 Interface Cable Slots

The I Cable enables the connection to S5 automation devices (COM1/TTY), to devices with a serial port (COM2/standard V.24) such as a modem or mouse and to devices with a parallel port (standard LPT) such as a printer or scanner. Please, use the I Cable on a level surface only (e.g. a desk) to prevent contact problems.

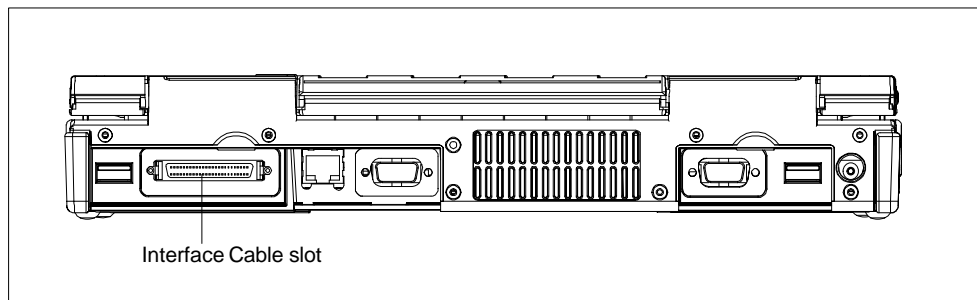

Fig. 3-4 I Cable Slot on the PG

Connecting External Monitors

You must switch the PG off before you connect the monitor cable. You will find further information about the connector pin assignment in Chapter 7.

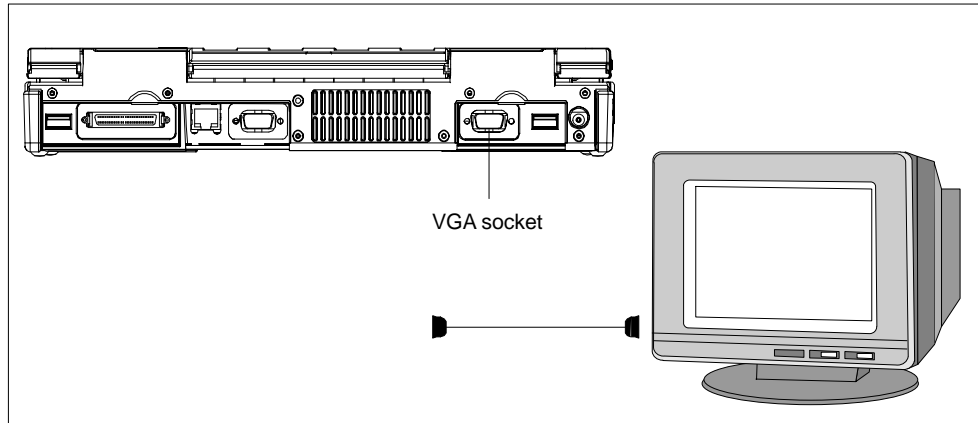

Fig. 3-5 Connecting the Monitor

To connect the monitor, proceed as follows:

1. Switch off the SIMATIC Field PG P4 and the monitor.
2. Open the port cover on the rear of the device.
3. Plug the monitor cable into the VGA socket connector.
4. Secure the connector with the screws.
5. Plug the other end of the monitor cable into the monitor.
6. Switch on the SIMATIC Field PG P4 and the monitor.
7. Make the necessary changes in the SETUP program (Menu **Main > Hardware Options** "CRT/LCD selection: Simultan. Auto").

Note

Default setting is simultaneous operation of the flat screen display and of an external monitor. The display unit is optimized for a format of 1024*768 pixels (XGA) or 1400 x 1050 pixels (SXGA+). Modes with lower resolution and text mode are expanded to this format.

If you connect an external monitor with lower resolution than the display, the resolution of the display is reduced to the resolution of the external monitor in simultaneous operation.

You can optimize the external monitor display via BIOS Setup in the **Main** menu item **Hardware Options** "CRT/LCD selection: CRT only".

You can use the program Panel "Field PG" to easily switch among the active display devices.

Caution

Ensure that the used monitor is suitable for the set resolution and refresh rate.

Connecting Devices to the USB Interface 2.0

You can connect USB devices (mouse, keyboard or printer) to the USB 2.0 interface connector.

1. Open the port cover on the rear of the device.
2. Plug the USB device cable into the USB interface.

The Plug and Play operating system recognizes the device and makes it available.

If you wish to connect more than two USB devices you must use a HUB. Both interfaces are designed for use as high current USB 2.0 (500 mA) devices. They may not be used simultaneously for high current (refer to the Appendix B, Technical Data).

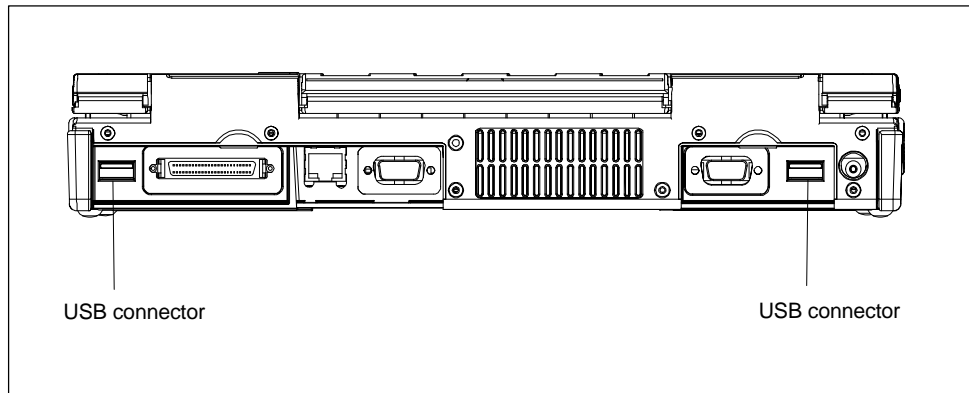

Fig. 3-6 USB connectors

Using a Mouse

You can connect a USB mouse parallel to the Touchpad.

Connecting a Microphone

The 3.5-mm phono jack can be used to connect microphones. Pin assignment:

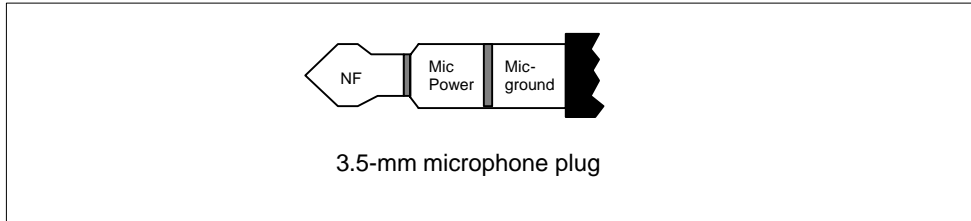

Fig. 3-7 Pin assignment of the microphone plug

For microphone recordings, select **all Programs > Accessories > Entertainment > Sound Recorder** in the Windows Start menu.

Connecting a Headphone

You can connect headphones or active speakers with 3.5-mm stereo phono plugs to this jack.

Loudness is controlled via taskbar button or **all Programs > Accessories > Entertainment > Volume Control** in the Windows Start menu. The internal speakers are switched off when a headphone is connected.

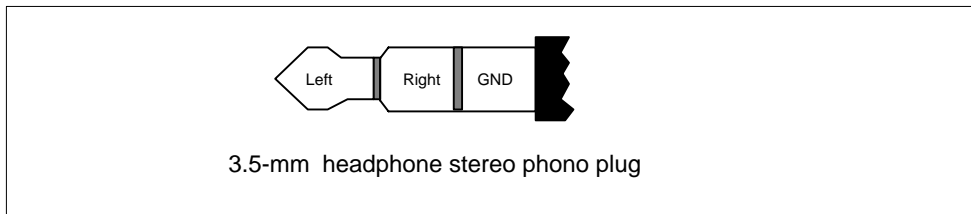

Fig. 3-8 Headphone stereo phono plug

3.7 Working with SIMATIC S5 Memory Submodules

Editing SIMATIC S5 Memory Submodules

You can read and program SIMATIC S5 memory submodules (EPROMs or EEPROMs) via the Memory Card interface. Use the S5 adapter for S5 memory submodules that is included in the scope of delivery for devices with Step 5 software. The S5 adapter consists of a Memory Card plug with an interface for the connection of S5 memory modules. Refer to the STEP 5 manual for information on operating the programming software.

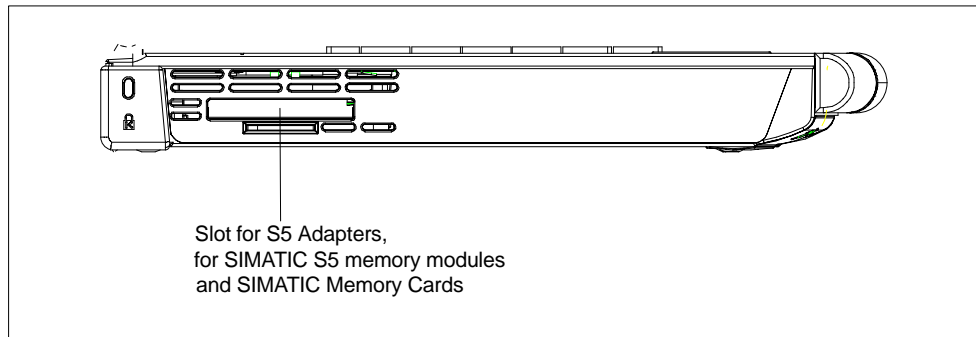

Fig. 3-9 S5 Module Programming Interface

Notice

The S5 adapter and STEP 5 software is not included in all delivered versions.

Proceed as follows when working with S5 memory modules :

1. Switch on your device.
2. In your STEP 5 software, start the function **Administration > Edit EPROM**.
3. With the type label on the top, insert the SIMATIC S5 Memory Card or the S5 adapter into the Memory Card interface and then the S5 memory module.
4. You can read, program or erase (EEPROMs only) your S5 memory module with the EPROM functions of the STEP 5 software.
5. Extract the S5 memory module.
6. Close the EPROM functions of your STEP 5 software.



Caution

You might damage the module if you insert or extract it while editing is in progress. You must not remove the S5 memory module as long as the module programming status display is lit.

Always discharge your body's static electricity by briefly touching a grounded part of the device before you insert an S5 Memory Card.

3.8 Working with SIMATIC Memory Cards

Working with SIMATIC Memory Cards

SIMATIC memory cards can be read, programmed, and erased. SIMATIC memory cards are available for SIMATIC S5 and SIMATIC S7 software.

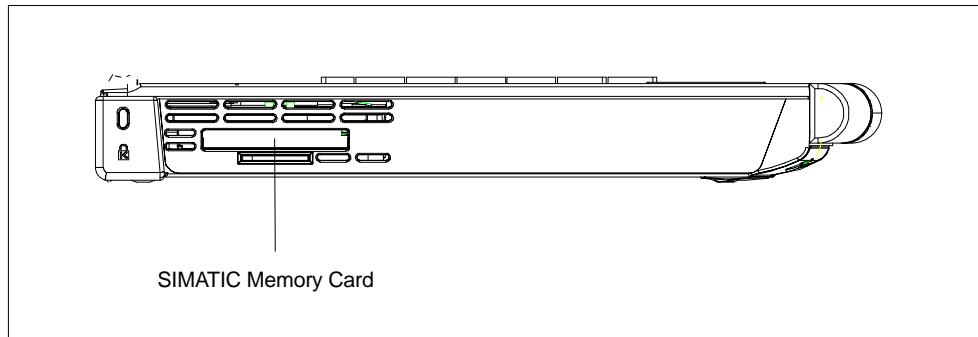

Fig. 3-10 Slot for SIMATIC Memory Cards

Proceed as follows when working with SIMATIC memory cards:

1. Switch on your device.
2. Start your SIMATIC programming function.
3. Plug a SIMATIC Memory Card into the Field PG P4 slot. Correct insertion direction is spot marked on the Field PG P4 and on the Memory Card.
4. You can read, program, or erase the Memory Card with the programming function of your SIMATIC programming software.
5. Close the programming function of your SIMATIC software.
6. Remove the SIMATIC memory card from the programming port for further use in a programmable logic controller.

Caution

You must insert the Memory Card with the type label pointing towards the rear of the unit.

You must not remove the SIMATIC Memory Card while the module programming status LED is lit.

Always discharge your body's static electricity by briefly touching a grounded part of the device before you insert a SIMATIC Memory Card.

3.9 Working with Micro Memory Cards

Working with Micro Memory Cards

Read, program and erase Micro Memory-Cards (MMC) via the Micro Memory Card interface. Operation with Micro Memory Cards is supported by STEP 7 V5.1 or higher.

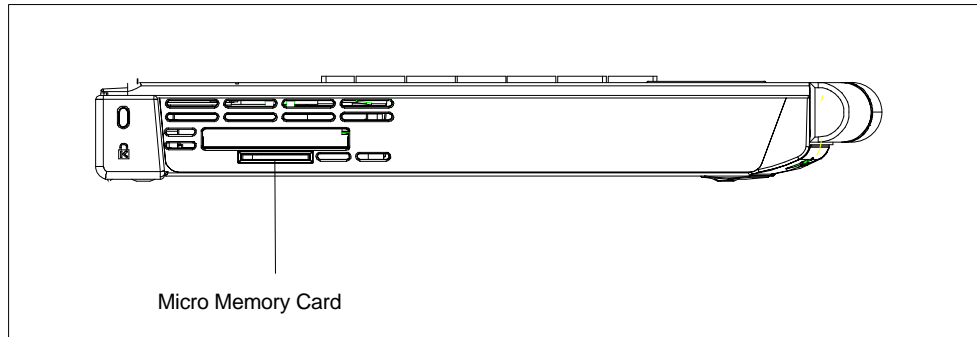

Fig. 3-11 Slot for Micro Memory-Cards

Proceed as follows when working with Micro Memory Cards:

1. Switch on your device.
2. Start your SIMATIC programming function.
3. Insert the Micro Memory-Card into the slot on the side of the device. The card's connector is encoded for insertion in one position only (with inclination to the rear). A symbol on the PG housing indicates the plug-in direction.
4. Read, program, or erase the Micro Memory Card with the programming function of your SIMATIC programming software.
5. Close the programming function of your SIMATIC programming software.
6. Remove the Micro Memory-Card from the interface.

Caution

You must not remove the SIMATIC Micro Memory Card while the module programming status display is lit.

Always discharge your body's static electricity by briefly touching a grounded part of the device before you insert a SIMATIC Micro Memory Card.

Note

Parallel operation of a Micro Memory Card (MMC) and of a Memory Card is **not** possible. The PG is equipped with a priority circuit that switches off the MMC interface when a Memory Card is inserted. The internal MMC is switched off as soon as a Memory Card, an S5 adapter or an MMC adapter is added.

3.10 Working with PC Cards

PC-Cards

The PC card interface supports two type II or one type III Cardbus card (32-bit) or PCMCIA card (16-bit). The SIMATIC Field PG P4 has two PC card ports. You can plug credit-card format communication modules for MODEM, FAX-MODEM, ISDN, Token Ring, ETHERNET, memory expansion and SCSI interface modules into these ports.

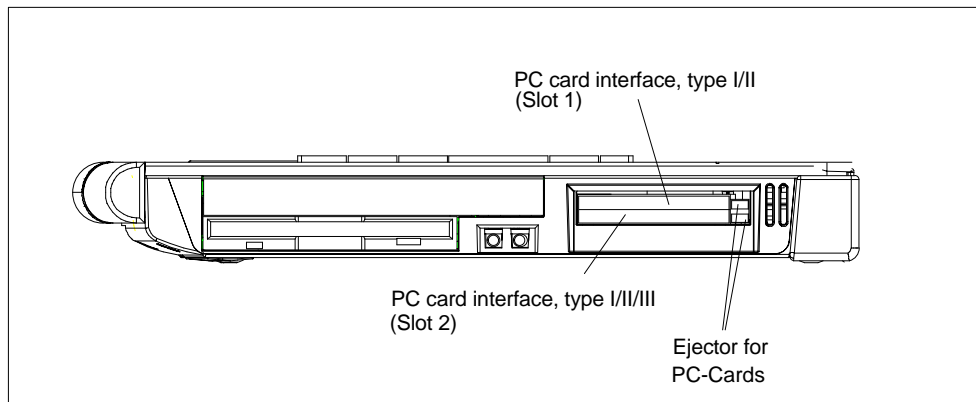

Fig. 3-12 PC Card interface

The PC-Card ejectors have a ballpoint pen mechanism. Before you insert the card ensure that the ejector is engaged. To remove the PC-Card, push the ejector once to unlock it and a second time to eject the card.

Caution

When you plug in the PC-Card, the **Label** must be on top.

Remove the card only after all data traffic has terminated (risk of data loss and system failure).

You might damage the SIMATIC Field PG P4 and the PC-Card if you attempt to insert the card the wrong way round.

Always discharge your body's charge of static electricity by briefly touching a grounded part of the device (e.g. the metal mount of the port) before inserting or removing a card (in accordance with the instructions for handling electrostatically-sensitive components, EGB guidelines). Otherwise, disruptions might occur.

Notice

In order to use a PC card you must enter BIOS-SETUP, open the **Main** menu, select the **Hardware Option** submenu and set "Cardbus/PCMCIA Slot" to "Enabled".

3.11 Connecting the Field PG P4 to a SIMATIC S5 Network

Point-To-Point Connection

In this section, you will learn how to connect your Field PG P4 to a programming device or S5 PLC using a point-to-point connection.

You can establish a point-to-point connection by connecting the Field PG P4 to another programming device using a TTY connection.

Notice

The interface is connected to potential.

The SIMATIC STEP 5 programming software and the patch cord for the connection to the S5 PLC is not supplied with all versions.

Connecting the Field PG P4 to the S5 PLC

You can connect the Field PG P4 to a SIMATIC S5 PLC via TTY port. The patch cord for connecting to SIMATIC S5 CPUs is not included with all delivered versions (Order no.: 6ES5734-2BD20).

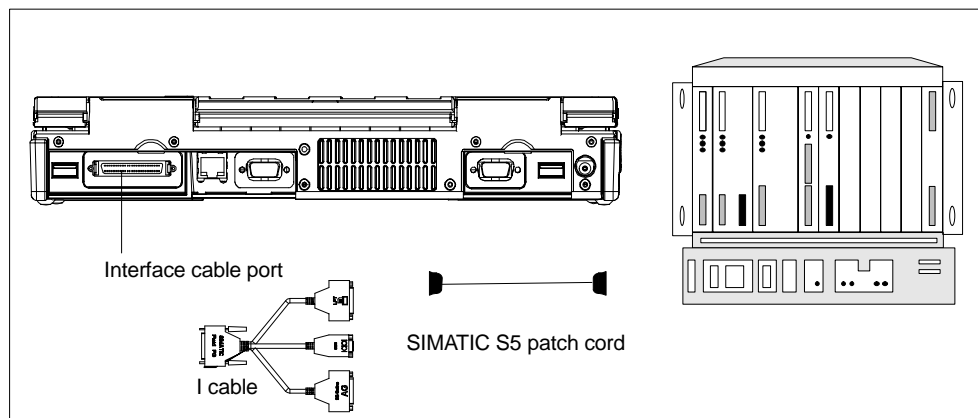

Fig. 3-13 Connecting to an S5 PLC

You connect your Field PG P4 to a SIMATIC S5 PLC as follows:

1. Switch off your device.
2. Open the cover of the ports on the rear of the device.
3. Connect the interface cable to the Field PG P4.
4. Connect the patch cord to the TTY port of the Interface cable (S5-Online AG).
5. Secure the connector with screws.
6. Connect the patch cord to the corresponding port on the CPU of the PLC.

Caution

The interface port may be damaged if you use the wrong patch cord.

3.12 Connecting the Field PG P4 to a SIMATIC S7 Network (MPI/DP)

Connecting an S7 Programmable Controller via an MPI/DP Interface

You can use the potential-separated*) MPI/DP interface to connect the SIMATIC Field PG P4 to a SIMATIC S7 programmable controller or to a PROFIBUS network. The MPI patch cord (5m) for connecting to SIMATIC S7-CPU's (Order no.: 6ES7901-0BF00-0AA0) is included in the consignment. The data transfer rate is limited to 187.5 Kbit/s when using this patch cord. For baud rates > 1.5 Mbit/s you must use a PROFIBUS cable for 12 Mbit/s (Order no. 6ES7901-4BD00-0XA0).

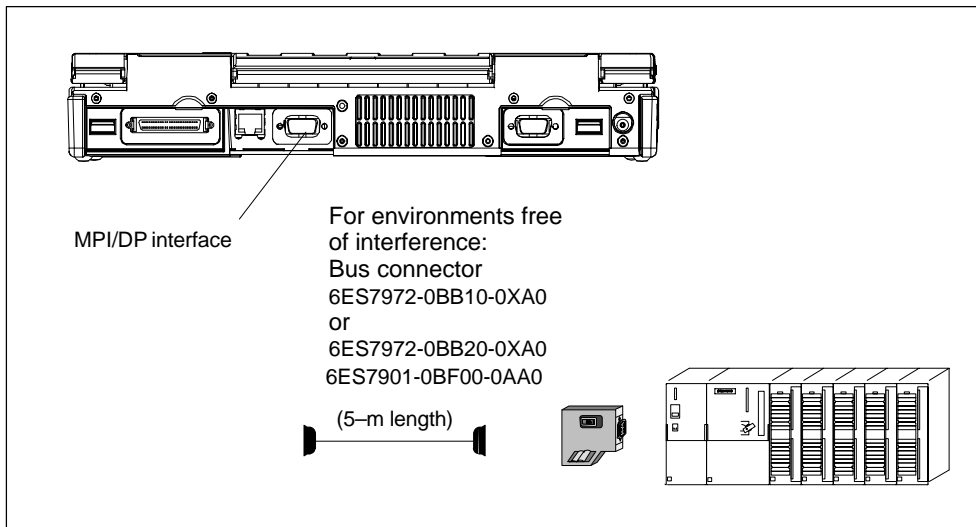

Fig. 3-14 Connection Using the MPI/DP Interface

Proceed as follows when connecting to a SIMATIC S7 programmable logic controller:

1. Switch off your device.
2. Open the interface cover on the left-hand side panel of the device.

3. Connect the cable to the MPI/DP interface.

Caution

Before plugging in the cables, the static charge on your body, the unit, and the cables must be equalized. You can do this by briefly touching the metal mounting plate for the interfaces on the rear panel.

- *) Electrical isolation in the safety extra-low voltage circuit (SELV circuit).

Connecting

Via the MPI/DP interface, you can connect your programming devices to

- MPI networks (S7-200, S7-300, and S7-400) or
- PROFIBUS DP networks (DP components).

MPI/PROFIBUS DP Network

Up to 32 devices (PC, PG, or AS) can be connected to the MPI/DP interface to form a network segment. The physical connection to the MPI/PROFIBUS DP network is via a floating RS485 interface which is a component of the PG basic module.

Several MPI/PROFIBUS DP network segments can be connected via repeaters. The complete MPI/PROFIBUS DP network can comprise up to 127 stations. Data transmission rates from 9.6 Kbps to 12 Mbps are possible in the PROFIBUS-DP MPI network.

3.13 Networking the Field PG P4 with Other Stations on PROFIBUS

Networking the SIMATIC Field PG P4 on PROFIBUS

PROFIBUS is an open and robust bus system for industrial use. It can be used to configure networks with up to 32 stations per segment. PROFIBUS-DP supports data-transfer rates from 9.6 Kbaud to 12 Mbaud.

How the Network Functions

The network operates on the “Master-Slave Principle with Token Passing” (complying with DIN19245, PROFIBUS). It distinguishes between active and passive stations. An active station receives the token and passes it on to the next station within a specified time.

Hardware Requirements

Using the following components, for example, you can connect or network the SIMATIC Field PG P4 with PROFIBUS:

- RS 485 MPI/DP interface adapter, integrated
- Shielded, twisted pair (bus cable or connecting cable to network).

3.14 Ethernet (RJ45 Ethernet Interface)

Networking Field PG P4 via RJ45 Ethernet Interface

The RJ45 Ethernet interface is a Twisted-Pair (TP) Interface for data transfer rates of 10/100 Mbaud. This on-board interface is compatible with Intel pro/100+ PCI Adapters.

The Plug & Play interface is automatically recognized in Windows. Protocols are configured in the Windows system control.

Notice

A Class 5 Ethernet cable is required for operation with 100 Mbaud. Use a suitable cable material depending on the length of the cable.

SIMATIC Field PG P4 Expansions

4

What Does This Chapter Contain?

This chapter shows you how to expand your SIMATIC Field PG P4 with additional expansion memory submodules to increase its performance. Please note the included comments on safety.

Chapter Overview

Section	Description	Page
4.1	Installing Memory Expansion Submodules	4-2
4.2	Processor Upgrade	4-4
4.3	Replacing Backup Battery	4-4

4.1 Installing Memory Expansion Submodules

Standard Memory

The motherboard has 2 slots for SO DIMM memory submodules (DDR 266, PC 2100) . This allows you to expand the memory capacity of your SIMATIC Field PG P4 to a maximum of 1 Gbyte.

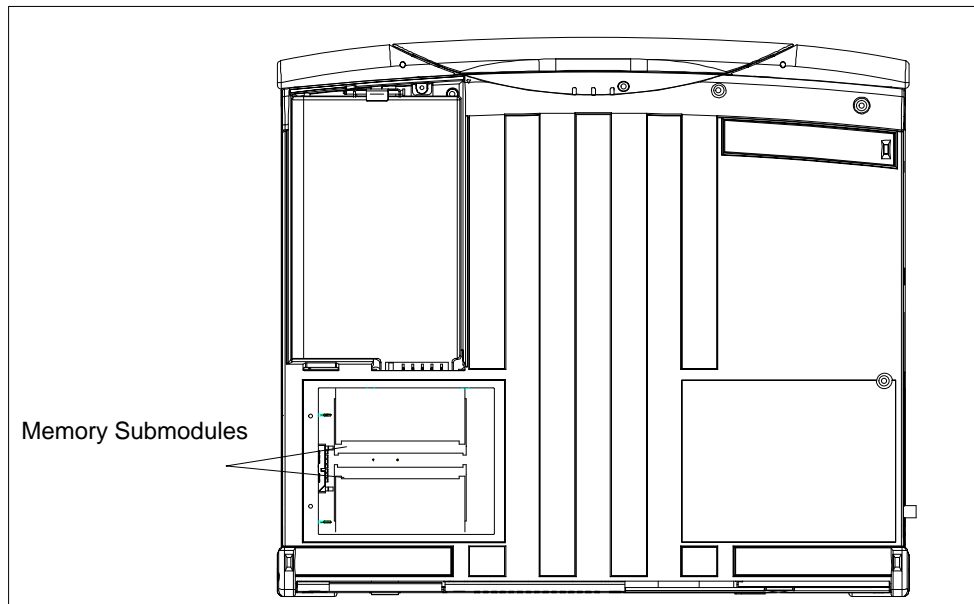

Fig. 4-1 Positions of the SO DIMM Memory Submodules

You can install submodules of different capacity. Only one module must be installed.

Memory	Modules	
	256 Mbytes	512 Mbytes
256 Mbytes	1	–
512 Mbytes	2	–
512 Mbytes	–	1
768 Mbytes	1	1
1024 Mbytes	–	2

Notice

Please only use Siemens memory modules as these are qualified and released for this device. Refer to the catalog for the ordering data.

Caution

The electronic components of the printed circuit boards are highly sensitive to electrostatic discharge. Certain precautionary measures are therefore necessary when handling such components. These measures are explained in the guidelines for handling electrostatically-sensitive devices in Appendix A.

Installing memory submodules

To plug in expansion submodules, proceed as follows:

1. Switch off the device.

Caution

Do not install a memory module while the PG is switched on. You might damage the PG as well as the memory module.

2. Remove all cables connected to the device, including the power adapter.
3. Close the display unit.
4. Place the PG onto a soft mat with the display unit facing down.
5. Remove the battery.
6. Remove the four retaining screws of the cover above the memory expansion slot.
7. Remove the cover.
8. Plug the module into the slot. Note the recess (reversal protection) on the plug side of the SO DIMM module.
9. Push the module down by applying light pressure until it locks into place.
10. Reinsert the battery.
11. Replace the cover and secure it with the four screws.

Caution

Make sure that the modules are seated securely in the slots, otherwise they can drop out and be damaged.

The memory configuration is detected automatically. When you switch on the unit, the distribution of “System and Extended Memory” is displayed on-screen.

4.2 Processor Upgrade

You can boost the performance of your SIMATIC Field PG P4 with a processor upgrade. Consult your local dealer or service partner.

Notice

If an upgrade is implemented, for example to a processor with a different frequency, it may be important to also upgrade the BIOS.

You must only install components approved by Siemens.

4.3 Replacing Backup Battery

The Field PG P4 has a backup battery which powers the hardware clock after the device has been switched off.



Warning

Danger of explosion when replacing the battery improperly. Only replace with the same type.

The backup battery can be ordered from Siemens as a spare part (order number: A5E00047601).

Old lithium batteries should be given back to the manufacturer, recycled or disposed of as hazardous waste.

If you have any questions, please consult your local dealer or service partner.

Configuring the SIMATIC Field PG P4

5

What Does This Chapter Contain?

In this chapter, you will learn how to configure your programming device. You need to do this if you change your system by adding, removing, or exchanging expansion modules and memory expansions, or by replacing a system module.

Chapter Overview

Section	Description	Page
5.1	Changing the Device Configuration with SETUP	5-2
5.2	The Main Menu	5-5
5.3	The Advanced Menu	5-14
5.4	The Security Menu	5-16
5.5	The Power Menu	5-17
5.6	The Boot Menu	5-19
5.7	The Version Menu	5-21
5.8	The Exit Menu	5-22

5.1 Changing the Device Configuration with SETUP

Changing the Device Configuration

Your PG configuration is set for working with the software supplied with the unit. You should only change the preset values if you have modified your Field PG P4 in any way or if a fault occurs when the unit is powered up.

SETUP-Program

The SETUP program is in the ROM-BIOS. Information about the system configuration is stored in the battery-buffered RAM of the SIMATIC Field PG P4.

You can use SETUP to set the hardware configuration (for example, hard disk type) and define the system characteristics. You can also use SETUP to set the time of day and date.

Incorrect SETUP Data

If incorrect SETUP data are detected when you boot the system, the BIOS prompts you to:

- Start SETUP by pressing **F2** or
- Continue booting by pressing **F1**.

Starting SETUP

On completion of the startup test, the BIOS gives you the opportunity of starting the SETUP program by displaying the following screen prompt:

```
PRESS < F2 > to enter SETUP or <ESC> to show Bootmenue
```

To start SETUP, proceed as follows:

1. Reset your PG (warm or cold restart).
2. Press the **F2** key as long as the BIOS prompt appears on the screen.

SETUP Menus

The various menus and submenus are listed on the following pages. You can get all the information you need for the SETUP entry selected from the “**Item Specific Help**” part of the relevant menu.

Screen Display Following Power On

With the standard setting of your PG, the screen displays after power-on, for example:

```
Phoenix NoteBIOS 4.0 Release 6.0 -A5E0001xxxx-ES00x
Copyright 1985-2002 Phoenix Technologies Ltd.
All Rights Reserved
```

```
SIEMENS Field PG P4    Version Vxx.xx.xx
```

```
CPU = Mobile Intel(R) Pentium(R)4 - M    CPU 1.60GHz
640K System RAM Passed
61M Extended RAM Passed
512K Cache SRAM Passed
Fixed Disk 0: FUJITSU MHK2060AT
ATAPI CD-ROM: TOSHIBA CD-ROM XM-1902B
Mouse initialized
```

```
Press <F2> to enter SETUP or <ESC> to show Bootmenue
```

Notice

All information on on-screen displays and menu displays are samples. Deviations to this example are possible.

Press the F2 key while the above display is shown, to select the ROM-based BIOS setup program. In this program, you can set a number of system functions and hardware configurations of your programming device.

The standard settings are effective on delivery. You can change these settings using the BIOS setup. The modified settings become effective when you have saved them and terminated the BIOS setup.

The following screen form appears when you start the BIOS setup:

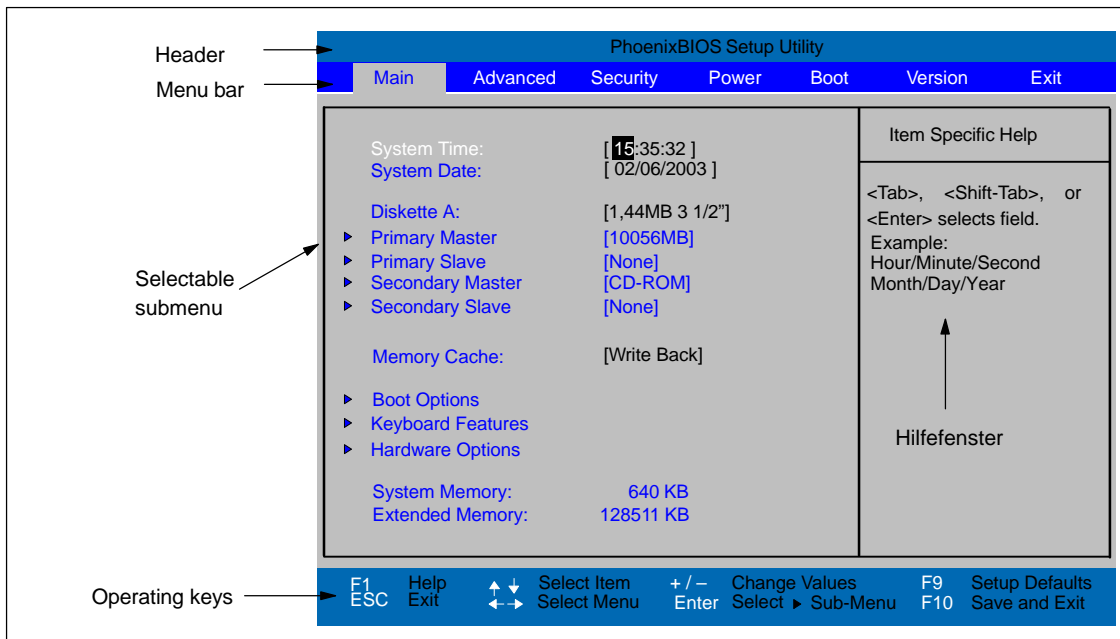

Fig. 5-1 Main SETUP Menu (sample)

Menu Structure

The screen is divided into four sections. In the top section, you can select the menu screens [Main], [Advanced], [Security], [Power], [Boot Sequence], [Version], [Exit]. In the left of the center section you can select various settings or submenus. Brief help texts appear on the right for the currently selected menu entry. The bottom section contains information for operator inputs.

You can move between the menu screens using the cursor keys [←] and [→].

Menu	Meaning
Main	System functions are set here
Advanced	An extended system configuration can be set here
Security	Security functions are set here, for example a password
Power	Power functions can be selected here
Boot	The boot priorities are defined here
Version	Information about the programming device's release status
Exit	Used for terminating and saving

5.2 The Main Menu

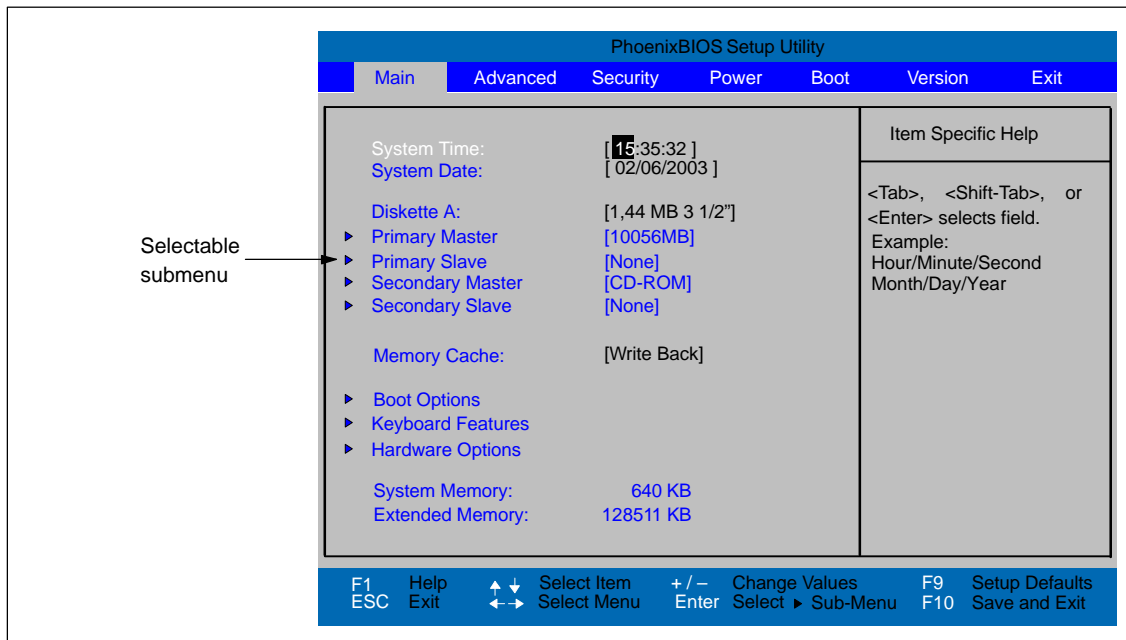

Fig. 5-2 Main SETUP Menu (sample)

Settings in the Main Menu

In the **Main** menu, you can move upwards and downwards using the cursor keys [↑] and [↓] to select the following system parameters:

Field	Meaning
System Time	For viewing and setting the current time
System Date	For viewing and setting the current date
Diskette A	Type of built-in floppy disk drive
Memory Cache	For setting the cache options
By submenus	
Primary Master	Type of built-in drives
Secondary Master	Type of built-in drives
Boot Options	For setting boot options
Keyboard Features	For setting keyboard-interface options (e. g. NUM Lock, Typematic Rate)
Hardware Options	For setting PG hardware options

System Time und System Date

System Time and System Date indicate the current values. Once you have selected the appropriate option, you can use the [+] and [-] keys to modify the time setting

Hour:Minute:Second

and the date

Month/Day/Year.

You can move between the entries in the date and time options (for example, from hour to minute) using the tabulator key.

Diskette A

The type of disk drive built-in to the PG is set here. The following entries are possible:

[Disabled]	If a floppy drive does not exist
[1.44 MB, 3 1/2"]	Setting for an integrated floppy drive A: for 3 1/2 inch/1.44 MB disks

Primary Master Primary Slave Secondary Master / Secondary Slave

When you select such a menu field via Enter key the following submenu is opened:

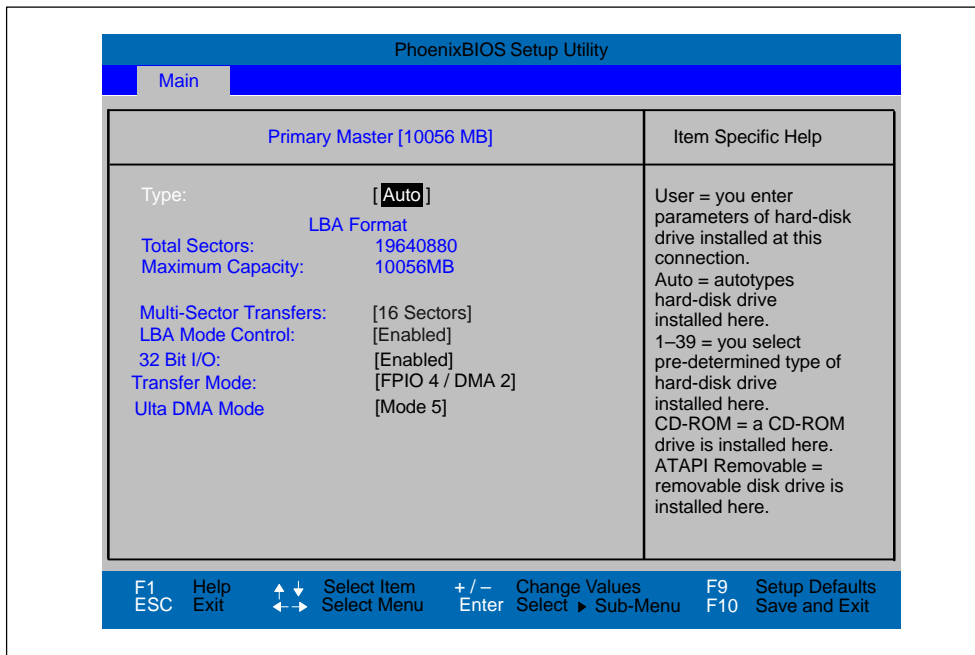

Fig. 5-3 Primary Master

"Type" Field

The parameters you can select here are usually stored on the IDE drive. The 'Auto' setting in the 'Type' field means that these values are automatically read from the drive and written into memory .

If Type is selected for a drive that cannot be detected, a timer times out in approximately 1 minute and the entries remain unchanged. You should always check that the interfaces for which you select 'Auto' are in fact connected to drives.

Select "User" if you want to define the hard-disk type yourself, in which case remember that you also have to set the other fields, including Cylinder, Heads, Sectors/Track and WritePrecomp, to the correct values for the type of hard disk in question.

"Multi-Sector Transfer" Field

The entry in the Multi-Sector Transfer field defines the number of sectors transferred per interrupt. The value depends on the drive and should be set only by setting the *Type* field to *Auto*.

Disabled

2, 4, 8, 16 sectors

"LBA Mode Control" field

If the LBA Mode Control field (enabled, disabled) is set to 'Enabled', the system supports hard disks with capacities greater than 528 Mbytes. The value depends on the drive and should be set only by setting the *Type* field to *Auto*.

"32 Bit I/O" Field

The setting in the 32 Bit I/O field defines the mode of access for the drive

Disabled 16-Bit access

Enabled 32-Bit access (default)

"Transfer Mode" Field / "Ultra DMA Mode" Field

The settings in these fields define the interface's data-transfer rate. The value depends on the drive and should be set only by setting the *Type* field to *Auto*.

Possible settings for *Ultra DMA Mode*: Mode 2, Mode 4 oder Mode 5.

The auto function sets this value automatically.

Hit ESC to exit the submenu.

“Memory Cache” Field

The following pop-up menu appears when you select the option “Memory cache” in the main menu:

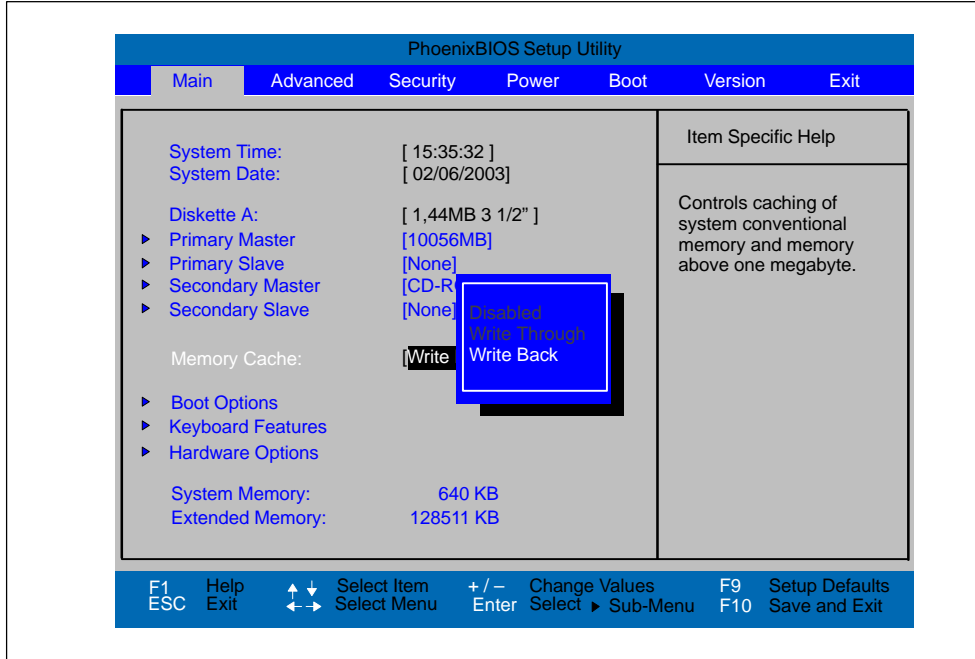

Fig. 5-4 “Memory Cache” Menu

A cache is a fast memory buffer between the CPU and main memory (DRAM). Recurrent memory access operations are executed in the fast cache, instead of main memory, if the function is enabled. In rare instances involving some hardware and software combinations, it may be necessary to disable the cache because the program runtimes or waits are too short on account of the fast cache.

[Disabled]	Cache is disabled
[Write Through]	Write access is not concluded until the entry has been made in main memory
[Write Back]	Write access is concluded immediately, the entry in main memory takes place in the background (default)

Option “Boot Options”

The following submenu appears when you select the option “Boot Options” in the main menu:

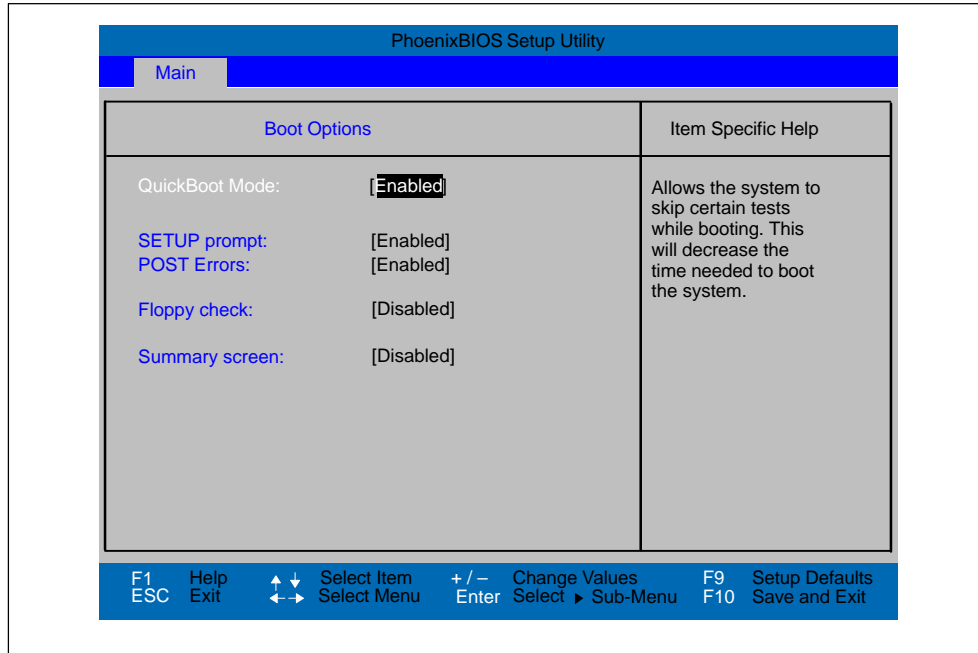

Fig. 5-5 “Boot Options” Submenu

Quick Boot Mode	Some hardware tests are skipped to speed up the boot procedure.
SETUP prompt	The message <i>PRESS <F2> to enter Setup</i> appears at the bottom of the screen during the system run-up phase.
POST Errors	The boot process is stopped if an error is detected; you must press F1 to confirm. Enter “Disabled” to avoid the necessity of acknowledging errors, for example if no keyboard is connected.
Floppy check	The floppy head is stepped inward and then back to its original position during the system run-up phase. This test is useful because it reinitializes the drive.
Summary screen	The most important system parameters are displayed when the system run-up phase completes.

‘Enabled’ means that the feature is active. ‘Disabled’ means that the feature is inactive.

Example of a Summary screen:

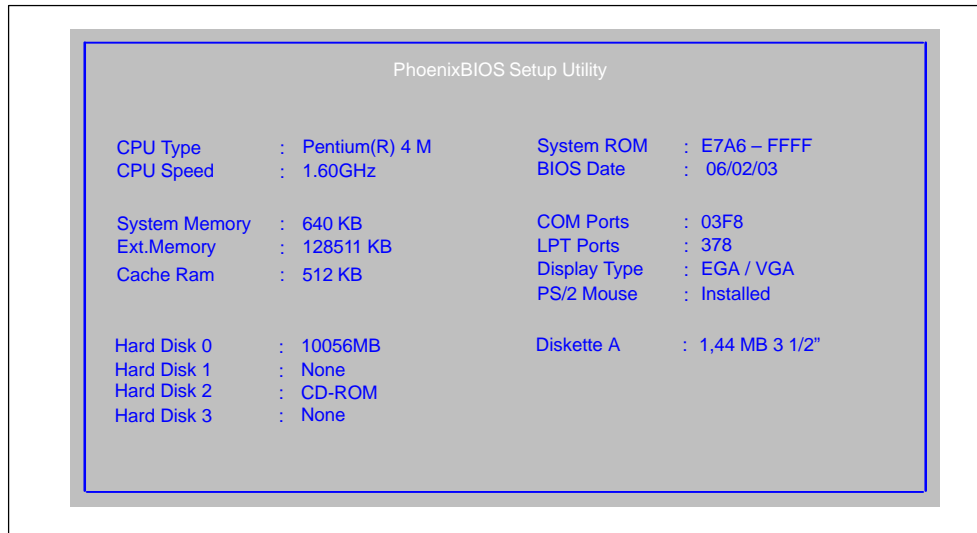

Fig. 5-6 Summary Screen

The Summary screen appears when the system run-up phase completes.

Option “Keyboard Features”

The following submenu appears when you select the “Keyboard Features” field in the main menu:

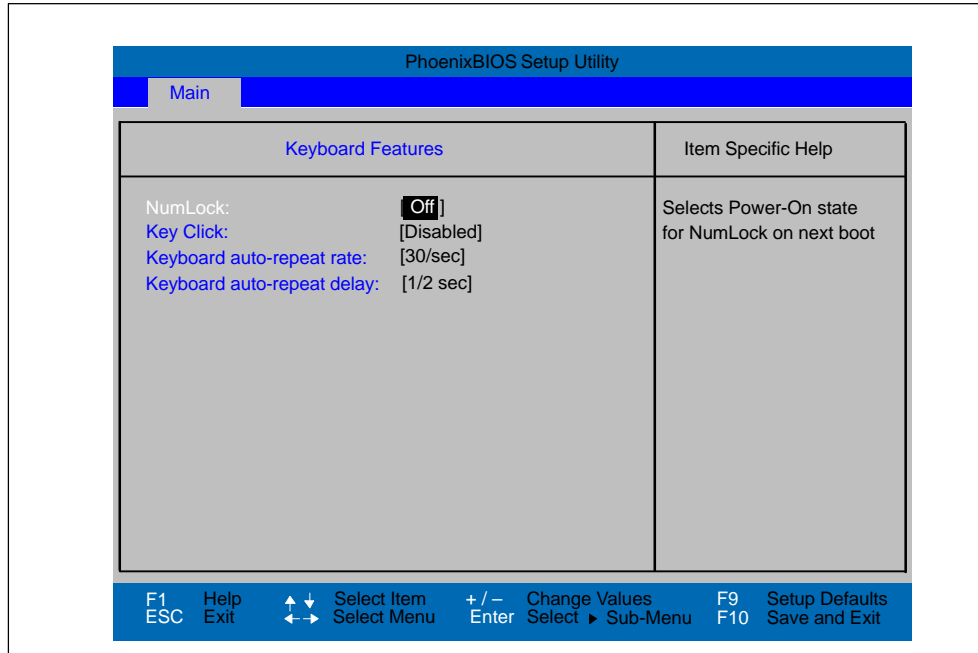

Fig. 5-7 “Keyboard Features” Submenu

Numlock	Switches Numlock on or off following power on
Key Click	A keystroke can be heard
Keyboard auto-repeat rate	Increase of the automatic keyboard rate
Keyboard auto-repeat delay	On-delay of automatic keyboard repeat

“Hardware Options” Field

The following submenu appears when you select the “Hardware Options” field in the main menu:

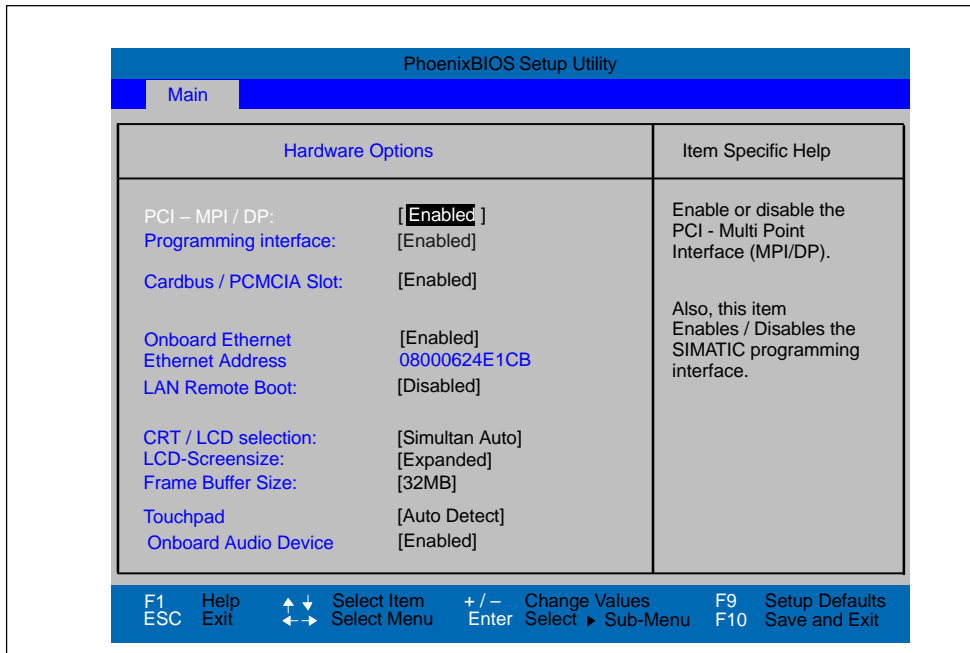

Fig. 5-8 “Hardware Options” Submenu

The parameters of the interfaces present on the basic module are set here.

Entry	Meaning
PCI - MPI / DP	Enables the CP5611 compatible MPI/DP interface.
Programming interface	Displays enable or disable status of the SIMATIC Memory Card Interface. Enable follows the enable of PCI-MPI/DP.
Cardbus / PCMCIA Slot	[Disabled] Enable Cardbus / PCMCIA-interface deactivated. [Enabled] Resources are managed by BIOS PCI Plug & Play mechanisms.

Entry	Meaning
Onboard Ethernet	<p>Enable the on-board Ethernet interface. Resources are managed by the BIOS PCI Plug & Play mechanism.</p> <p>[Disabled] Ethernet inactive. Ethernet interface hardware is switched off. The operating system can not operate the interface</p> <p>[Enabled] Ethernet active. Subsequent plugging of the network cable and its operation possible at any time (Hot-Plug). If no cable is plugged on system start the device checks during the boot sequence, for a time of approx. 30 seconds, and when recovering from suspend mode, for a time of approx. 40 seconds, for an existing Ethernet connection. Noticeable delays do not occur as long as an active network connection does not exist.</p>
LAN Remote Boot	<p>[Enabled] [Disabled]</p> <p>Switch on/off Oprom scan to activate remote boot via the onboard Ethernet.</p>
CRT / LCD selection	<p>[LCD only] All data is output only to the internal LCD, the 15-way VGA port is disabled</p> <p>[CRT only] For maximum resolution the display signals are output only to the 15-way VGA port; the LCD interface of the VGA controller is disabled.</p> <p>[Simultan. Auto] Choose Simultan. Auto if sometimes a CRT is connected, CRT will only be active if connected.</p> <p>[Simultan. Forced CRT] Both display interfaces are enabled and operate simultaneously. Note, however, that the LCD does not support all resolutions.</p>
LCD Screensize	<p>[Normal] The display window in Text and Graphic modes is not expanded to full screen size.</p> <p>[Expanded] The Graphic and Text modes are expanded to full screen size.</p>
Frame Buffer Size	<p>[8Mb] [16Mb] [32Mb]</p> <p>The Frame Buffer Size can be adjusted to the graphics requirement of your application.</p>
Touchpad	<p>[Enabled] The Touchpad is switched on.</p> <p>[Disabled] The Touchpad is switched off</p> <p>[Auto Detect] The Touchpad is automatically detected.</p> <p>Note: All modifications of this interface are not active until a restart of the PG.</p>
Onboard Audio Device	<p>[Enabled] [Disabled]</p> <p>Please switch off to make additional resources available.</p>

5.3 The Advanced Menu

Menu Structure

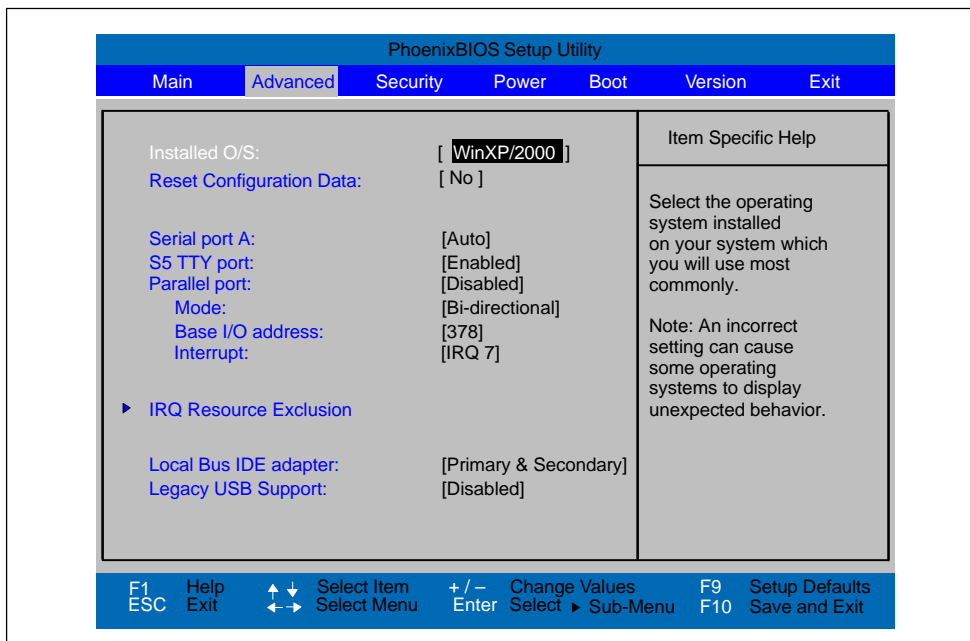

Fig. 5-9 "Advanced" Menu

Settings in the Advanced Menu

Installed O/S	Plug & play means that all modules are automatically detected and installed, providing they support the Plug&Play functionality. [other] BIOS handles the entire Plug&Play capability, default configuration [Win95] The operating system handles a part of the Plug& Play functions [Win98] [WinXP/2000]
Reset Configuration Data	[Yes] All installations under Plug&Play are deleted and reconfiguration is triggered the next time the system boots. The entry is then reset to [No]. System components that do not support Plug&Play have to be entered manually. [No] The Plug&Play system components are initialized after the next system start.
Serial port A	Configure Serial Port A with the options: [Disabled] No configuration [Enabled] User configuration [Auto] BIOS or OS chooses configuration.

S5 TTY port	Configure the TTY port with the options: [Disabled] No configuration [Enabled] User configuration [Auto] BIOS or OS chooses configuration.
Local Bus IDE adapter	[Disabled] No local IDE adapter. [Primary] One IDE adapter for max. two drives. [Secondary] Two IDE adapters for max. four drives. [Primary & Secondary]
Legacy USB Support	[Disabled] Disables the support for Legacy USB [Enabled] Enables support for Legacy USB

The resources used by an interface are released when you disable the interface in question.

Submenu IRQ Resource Exclusion

The I/O addresses and interrupts are default settings and recommended respectively.

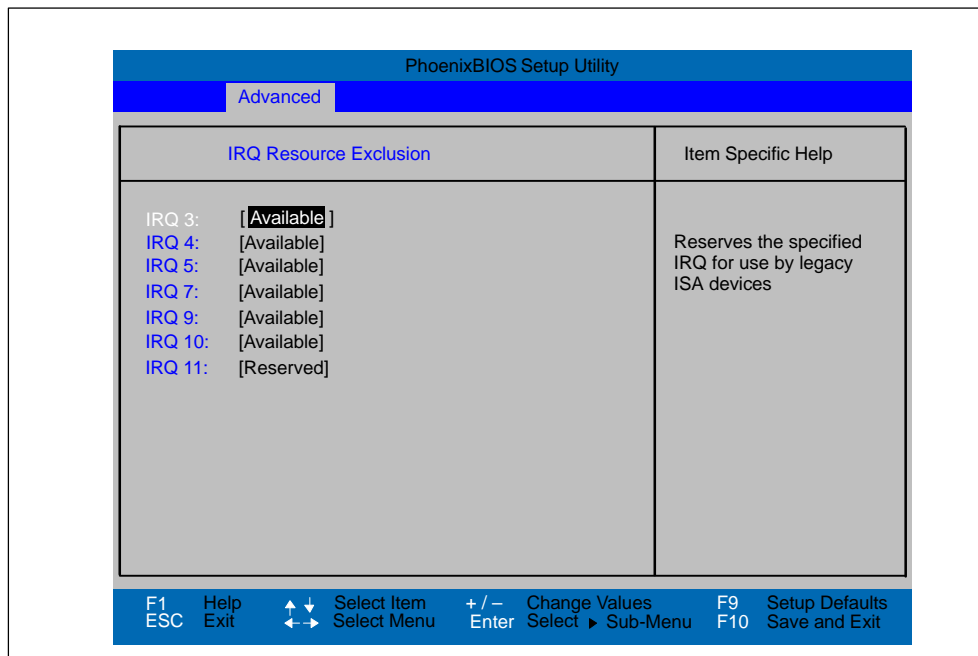

Fig. 5-10 "IRQ Resource Exclusion" Submenu

IRQ	Available	IRQ can be assigned by the BIOS Plug&Play mechanism to Plug and Play modules or to basic board functions.
	Reserved	Must only be set if the respective interrupt is not to be specifically assigned to a Plug & Play PCMCIA module.

5.4 The Security Menu

You can only edit the fields enclosed in square brackets. Two passwords are assigned to protect your programming device from unauthorized use. You can use the supervisor password to prevent use of diskettes for the normal user and to limit use of the hard disk.

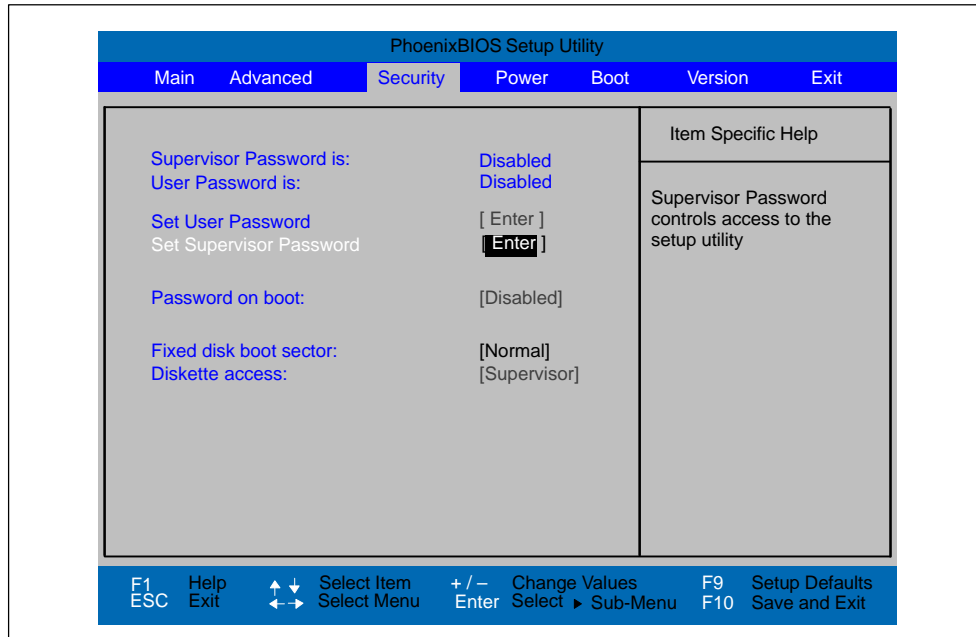

Fig. 5-11 "Security" Menu

Set Supervisor Password	This field opens the dialog box for entering a password. Once it has been entered, the supervisor password can be changed or deleted by pressing "Return" and thus deactivated.	
Set User Password	This field opens the dialog box for entering a password. Once it has been entered correctly, the user password can be changed or deleted by pressing "Return" and thus deactivated.	
Password on boot	[Disabled] [Enabled]	No password required for system boot. Supervisor or user password must be entered for system boot.
Fixed disk boot sector	Normal protected	All types of hard-disk access are permitted. No operating system can be installed. This is a way of protecting against boot viruses.
Diskette access	This mode of protection is not active unless "Password on boot" is set to [enabled]. Supervisor Diskette access is not possible unless the supervisor password was entered during system boot. User Diskette access is not possible unless the user password was entered during system boot.	

5.5 The Power Menu

This menu has the following structure:

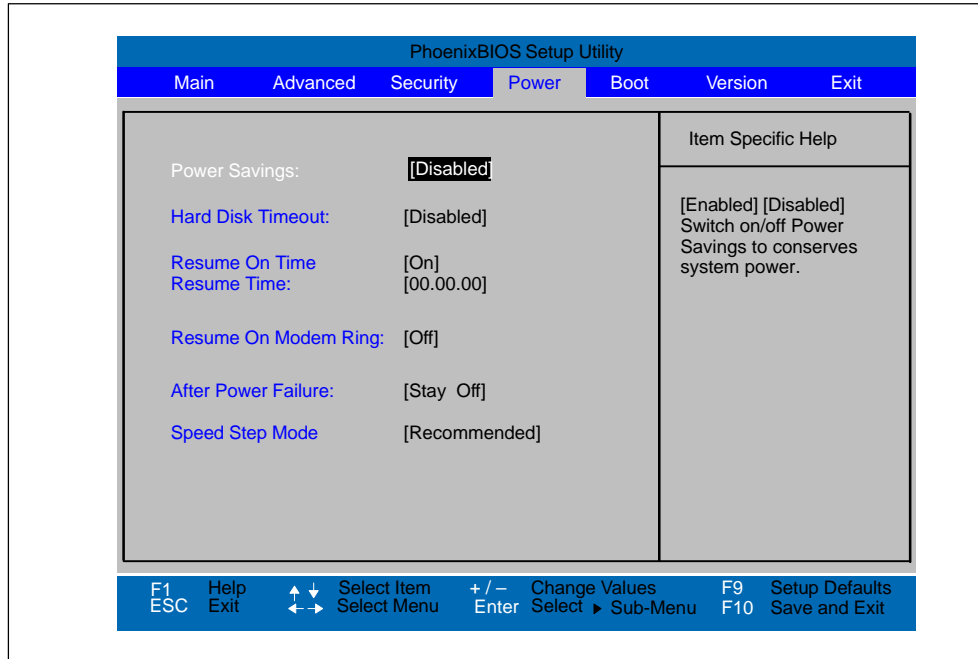

Fig. 5-12 “Power” Menu

The operating system controls the power management of the Field PG P4 via ACPI (Advanced Configuration and Power Interface). The BIOS power management functions can only be used with non-ACPI operating systems.

Power Savings	[Disabled] [Enabled]	Power management is only controlled via ACPI. The power-saving functions are set
Hard Disk Timeout	[Disabled] [10, 15, 30, 45] [1, 2, 4, 6, 8, 10, 15]	The hard disk does not shut down. Seconds or Minutes after the last hard disk access The next time it is accessed, the hard disk starts spinning again after a brief delay.
Resume On Time	[On] [Off]	If this function is enabled the programming device is automatically switched on at the preset time. 'Off' means this function is disabled.
Resume Time		Time for automatic restart
Resume On Modem Ring		Enabled wakes the system up when an incoming call is detected on your modem.

After Power Failure	<p>[Stay Off] After power failure the device is not switched on automatically.</p> <p>[Last State] Provided it was switched on prior to a power failure, the device is switched on again</p> <p>[Power On] Restores the previous power state before loss occurred.</p>
Speed Step Mode	<p>Speed Step Mode is required to save energy consumption. Speed Step switches between two clock rates dependig on the supply voltage (battery or power supply).</p> <p>[Battery Optimized] low performance, and thus less energy consumption and thus longer battery time</p> <p>[Recommended] The function of the system depends on voltage supply Voltage with high performance (power supply) or low with performace (battery).</p>

5.6 The Boot Menu

This menu allows you to set the priority of boot devices.

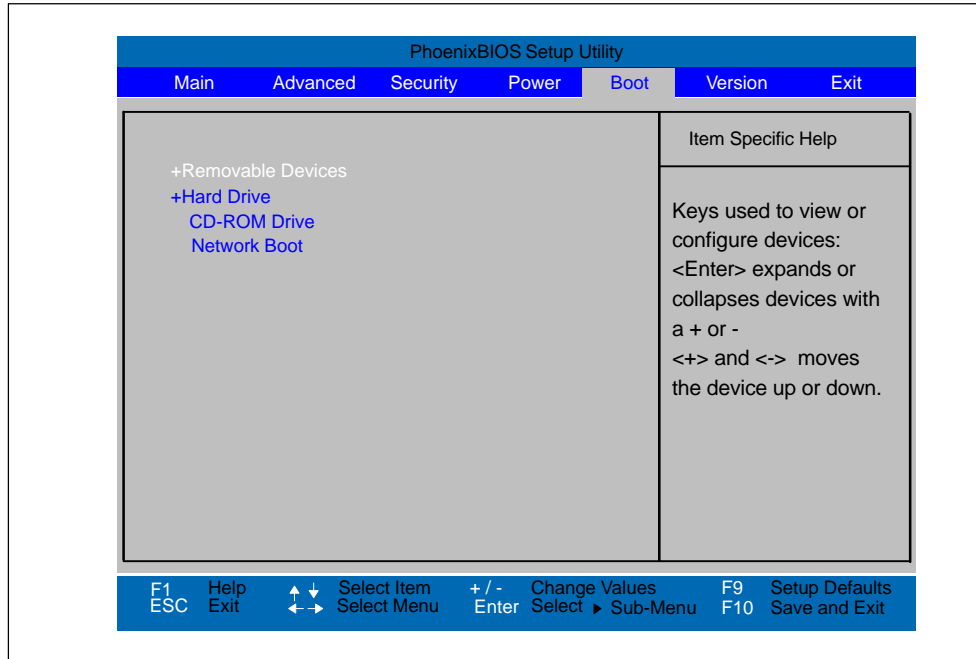

Fig. 5-13 The "Boot" Menu

This menu lists the boot devices in groups. The group with the highest priority is at the top. The procedure for changing the sequence is as follows:

Use the $\uparrow\downarrow$ keys to select a group and the + or - keys to move the group to its new position in the sequence.

Note

During booting the boot drive can be selected with the ESC key. An instructional text on how to do this is output.

Groups marked + can contain more than one device. When you select a group marked in this way, hit Enter to view the list of devices in the group. See the figure below for an illustration:

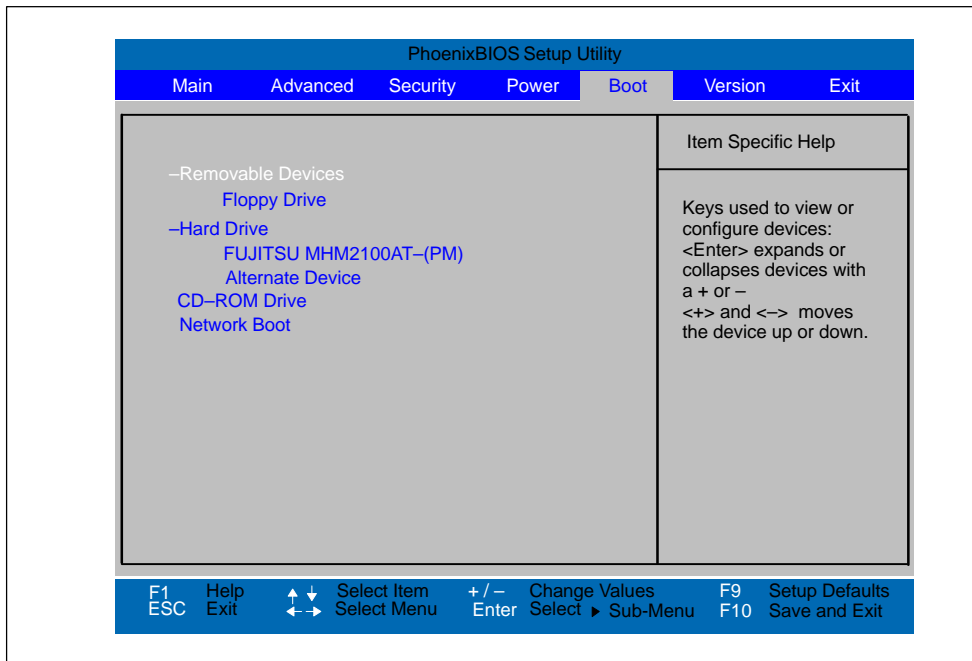

Fig. 5-14 The “Boot” Menu

This screen shows all possible boot devices; within a given group the highest priority device is always listed first. Here again, you can change the sequence as described above.

If a boot device is not available, the next device in the sequence is automatically checked to ascertain whether or not it is bootable.

5.7 The Version Menu

This menu contains the information you will have to quote when you send us technical questions about your system.

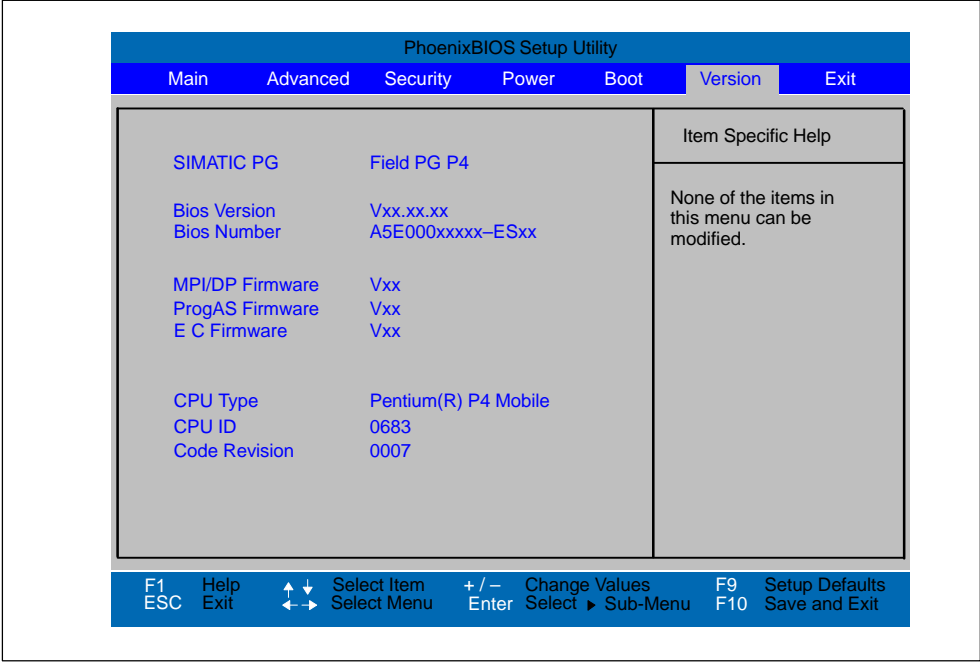

Fig. 5-15 The "Version" Menu

5.8 The Exit Menu

The setup program is always terminated using this menu.

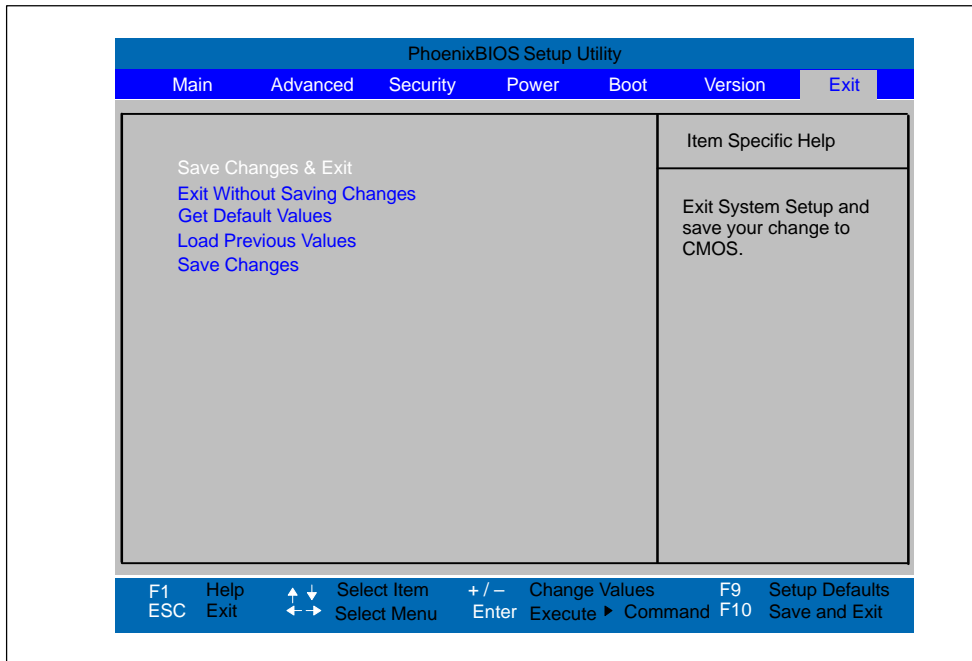

Fig. 5-16 The “Exit” Menu

Save Changes & Exit	All changes are saved; a system restart is carried out with the new parameters.
Discard Changes & Exit	All changes are rejected; a system restart is carried out with the previous parameters.
Get Default Values	All parameters are set to safe values.
Load Previous Values	The last saved values are reloaded.
Save Changes	Save all Setup settings.

6

Error Diagnostics

What Does This Chapter Contain?

This chapter will help you to locate, identify, and in some cases eliminate simple errors and faults.

Error/Fault	Remedy
Device LED does not light up	
<ul style="list-style-type: none"> • PG is switched off • Power supply not properly connected • Battery run down or not installed 	<ul style="list-style-type: none"> • Press the Power Button • Check the power supply, power cable, and power plug • Charge or install the battery
External monitor remains dark	
<ul style="list-style-type: none"> • LCD enabled is entered in SETUP 	<ul style="list-style-type: none"> • Enter CRT enabled or SIMULTANEOUS in SETUP
Message on the Display : "Invalid configuration information... Press the F1 key for continue, F2 to run Setup utility"	
<ul style="list-style-type: none"> • Configuration data not correct 	<ul style="list-style-type: none"> • Hit the "F2" key, check the configuration data in the SETUP program, if necessary adapt the default values, check the error messages in the first SETUP menu
Message on the Display "No boot device available" NTLDR not found, check boot data carrier	
<ul style="list-style-type: none"> • No bootable disk in drive A: • Wrong hard disk type entered in SETUP 	<ul style="list-style-type: none"> • Replace the disk with a boot disk • Use the "Autodetect Fixed Disk" function
Message on the Display : "Keyboard stuck key failure"	
<ul style="list-style-type: none"> • A key became blocked during the self-test of the keyboard 	<ul style="list-style-type: none"> • Check the keyboard. Restart the system if need be.
Every time a key is pressed, a beep is heard and no characters are displayed	
<ul style="list-style-type: none"> • Keyboard buffer overflow 	<ul style="list-style-type: none"> • <CTRL> <PAUSE>
< \ > key does not exist	
<ul style="list-style-type: none"> • Wrong keyboard driver 	<ul style="list-style-type: none"> • German keyboard: <ALTGr> <ß> • International keyboard : < \ > key

Hardware Information

7

Chapter Overview

Section	Description	Page
7.1	System resources	7-2
7.2	Interface pinout	7-3
7.3	Cables	7-12

7.1 System Resources

All system resources (hardware address, memory configuration, IRQ, DMA channel) are assigned dynamically by the Windows OS, depending on the hardware configuration, drivers and connected peripheral devices. You can view the current configuration of system resources or possible conflicts with the following operating systems:

Windows NT 4.0

Start > Programs > Administrative Tools (Common)> Windows NT Diagnostics

Windows 2000/XP

Start > Run enter *msinfo32* in the field **Open** and confirm with **OK**

7.2 Interface Pinout

DC-In

Jack for connecting the AC/DC adapter. Potentials:

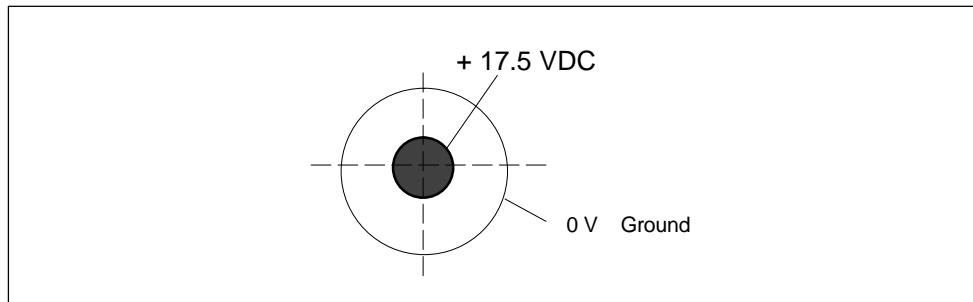

USB

Both interfaces are conceived for high-current USB 2.0 (500mA). However, they cannot be used simultaneously as high-current interface.

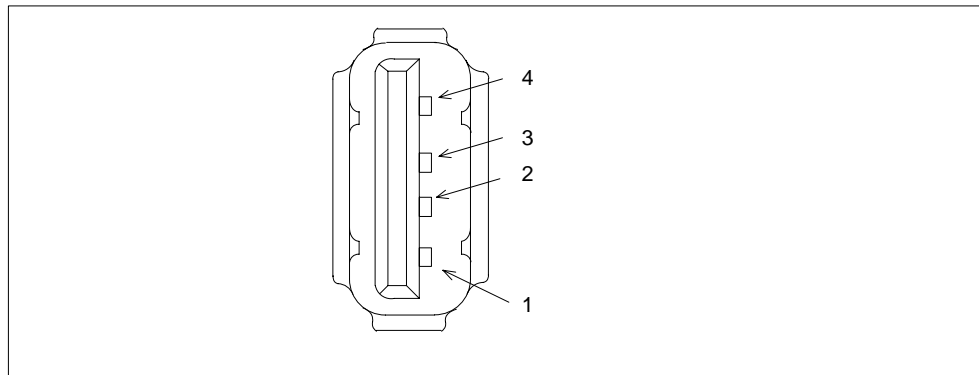

Pin-No.	Designation	Description	Input / Output
1	VCC	+5V (fused)	Output
2	- Data	Data line	Input / Output
3	+ Data	Data line	Input / Output
4	GND	Ground	-

VGA

15-pole socket for an external monitor. Pinout:

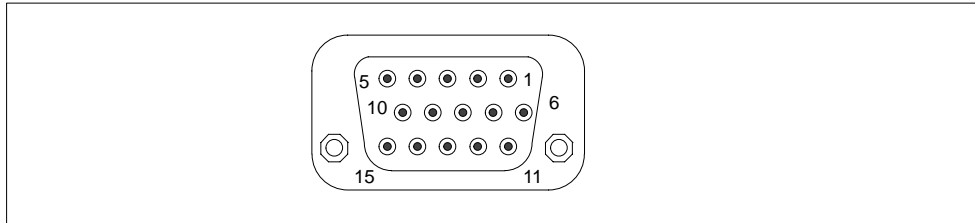

Pin No.	Designation	Description	Input/Output
1	R	Red	Output
2	G	Green	Output
3	B	Blue	Output
4	-	Unassigned	-
5	GND	Ground	-
6	GND	Ground	-
7	GND	Ground	-
8	GND	Ground	-
9	-	Unassigned	-
10	GND	Ground	-
11	-	Unassigned	-
12	DDC_DAT	Display Data Channel Data	Input / Output
13	EXT_H	Horizontal synchronizing pulse	Output
14	EXT_V	Vertical synchronizing pulse	Output
15	DDC_CLK	Display Data Channel Clock	Input / Output

MPI/DP

Pinout of the MPI/DP socket:

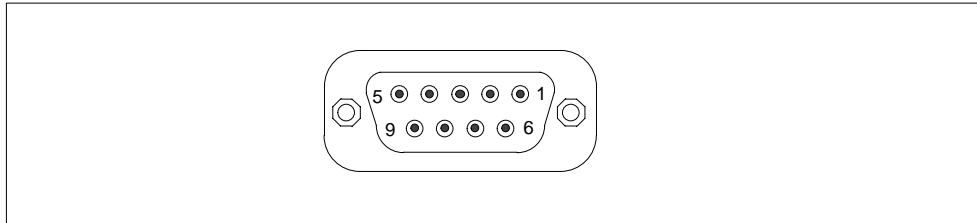

Pin No.	Designation	Description	Input/Output
1	-	Unassigned	-
2	-	Unassigned	-
3	LTG_B	Signal line B of MPI module	Input/output
4	RTS_AS	RTSAS, control signal for received data stream. The signal is "1" active when the directly connected programmable controller is sending.	Input
5	M5EXT	M5EXT return line (GND) of the 5 V power supply. The current load caused by an external user connected between P5EXT and M5EXT must not exceed the maximum of 90 mA.	Output
6	P5 EXT	P5EXT power supply (+5 V) of the 5 V power supply. The current load caused by an external user connected between P5EXT and M5EXT must not exceed the maximum of 90 mA.	Output
7	-	Unassigned	-
8	LTG_A	Signal line A of the MPI module	Input/output
9	RTS_PG	RTS output signal of the MPI module. The control signal is "1" when the programming device is sending.	Output
Screen		on connector casing	

Ethernet

Pinout of the Ethernet interface:

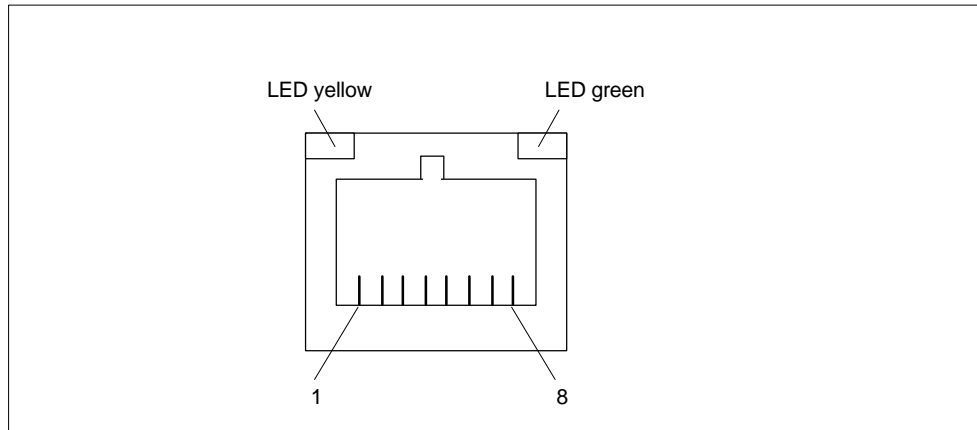

Fig. 7-1 Ethernet port

Pin-No.	Designation	Description	Input / Output
1	TD+	Transmitted data	Output
2	TD-	Transmitted data	Output
3	RD+	Received data	Input
4, 5 *	SYMR	Internal 75 Ω output	-
6		Received data	Input
7, 8 *	SYMT	Internal 75 Ω output	-
S		Shield	-
	LED yellow	Connection	-
	LED green	Activity	-

* is not necessary for data transfer

Micro-In

Plug for external microphone. Pinout:

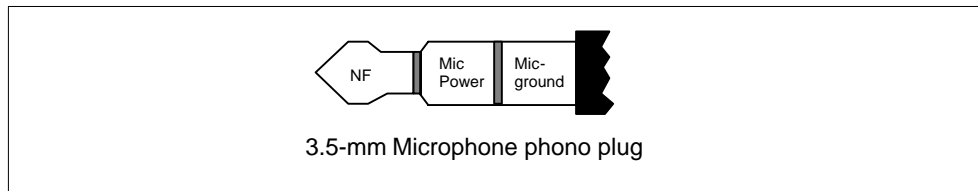

Fig. 7-2 Microphone

Headphone

Plug for external headphones. Pinout:

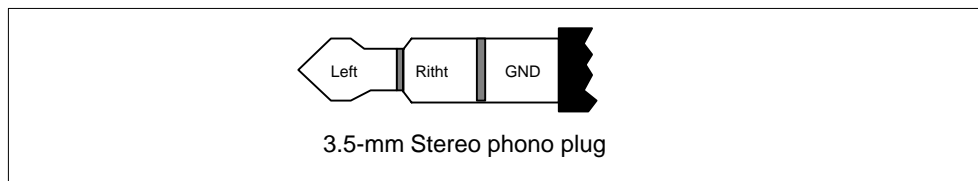
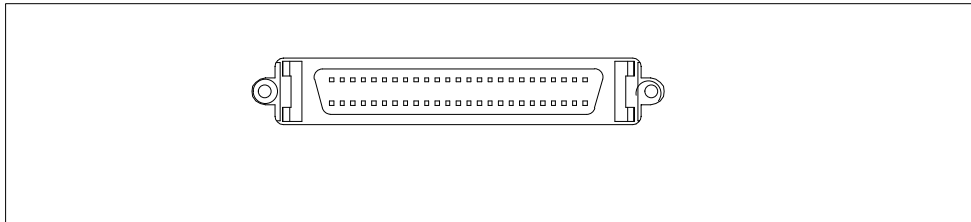

Fig. 7-3 Headphone

Interface Cable (I Cable)

Connector assignment on the Field PG P4



Pin No.	Designation	Description	Input /Output
1	/ AUTO FEED (LPT)	Automatic new line	Output (open Collector)
2	/ ERROR (LPT)	Device error	Input (4,7 kΩ pull up)
3	/ INIT (LPT)	Reset / Initialization	Output (open Collector)
4	/ SELECT IN (LPT)	Printer selection	Output (open Collector)
5	GND1 (LPT)	Ground	-
6	GND2 (LPT)	Ground	-
7	GND3 (LPT)	Ground	-
8	GND4 (LPT)	Ground	-
9	GND5 (LPT)	Ground	-
10	GND6 (LPT)	Ground	-
11	GND7 (LPT)	Ground	-
12	GND8 (LPT)	Ground	-
13-17	-	Unassigned	-
18	GND (S5 AG)	Ground	-
19	-	Unassigned	-
20	+TTY RxD (S5 AG)	TTY receive	Input
21	-TTY RxD (S5 AG)	TTY receive	Input
22	DCD (COM2)	Data carrier detect	Input
23	RxD (COM2)	Receive data	Input
24	TxD (COM2)	Transmit data	Output
25	DTR (COM2)	Data terminal ready	Output
26	/ Strobe CLK (LPT)	Data message	Output (open Collector)
27	Data - Bit 0 (LPT)	Data line 0	Output (TTL levell)
28	Data - Bit 1 (LPT)	Data line 1	Output (TTL levell)
29	Data - Bit 2 (LPT)	Data line 2	Output (TTL levell)
30	Data - Bit 3 (LPT)	Data line 3	Output (TTL levell)
31	Data - Bit 4 (LPT)	Data line 4	Output (TTL levell)
32	Data - Bit 5 (LPT)	Data line 5	Output (TTL levell)
33	Data - Bit 6 (LPT)	Data line 6	Output (TTL levell)
34	Data - Bit 7 (LPT)	Data line 7	Output (TTL levell)
35	/ACK (LPT)	Acknowledge	Input (4,7 kΩ pull up)

Pin No.	Designation	Description	Input /Output
36	12V (S5 AG)		
37	BUSY (LPT)	Not busy	Input (4,7 kΩ pull up)
38	PE (LPT)	Paper end	Input (4,7 kΩ pull up)
39	SELECT (LPT)	Device selection	Input (4,7 kΩ pull up)
40	+TTY TxD (S5 AG)	TTY send	Output
41-42	-	Unassigned	-
43	-TTY TxD (S5 AG)	TTY send	Output
44	-	Unassigned	-
45	GND (COM2)	Ground	-
46	-	Unassigned	-
47	DSR (COM2)	Data set ready	Input
48	RTS (COM2)	Request to send	Output
49	CTS (COM2)	Clear to send	Input
50	RI (COM2)	Incoming call	Input

Connector assignment on the I Cable

The port **S5-Online AG** has the following pinout:

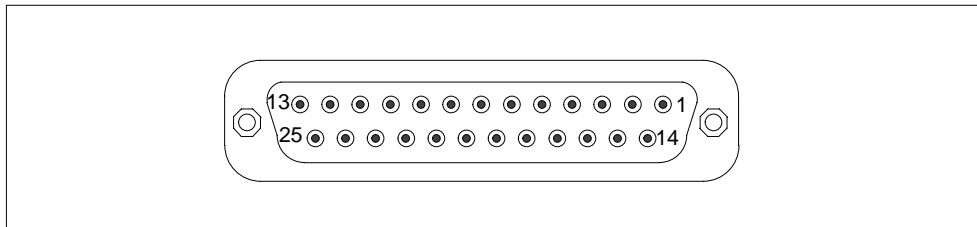

Pin No.	Designation	Description	Input /Output
1 -8	-	Unassigned	-
9	+TTY RxD	TTY receive	Input
10	-	Unassigned	-
11	-TTY RxD	TTY receive	Input
12-17	-	Unassigned	-
18	+TTY TxD	TTY send	Output
19	12V	Current source	-
20	-	Unassigned	-
21	-TTY TxD	TTY send	Output
22-24	-	Unassigned	-
25	GND (COM1)	Functional ground (reference potential)	-

The serial port **COM** has the following pinout:

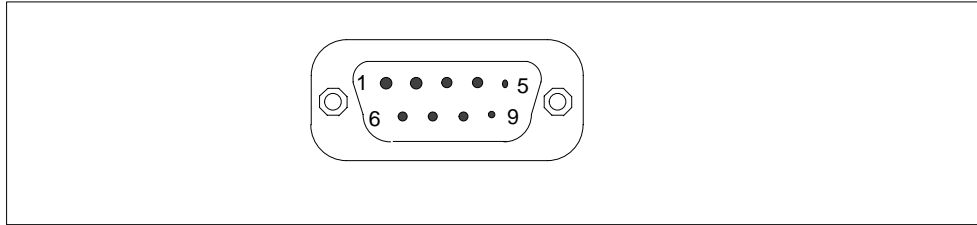

Pin No.	Designation	Description	Input /Output
1	DCD	Data carrier detect	Input
2	RxD	Receive data	Input
3	TxD	Transmit data	Output
4	DTR	Data terminal ready	Output
5	GND	Ground	-
6	DSR	Data set ready	Input
7	RTS	Request to send	Output
8	CTS	Clear to send	Input
9	RI	Incoming call	Input

The parallel port **LPT** has the following pinout:

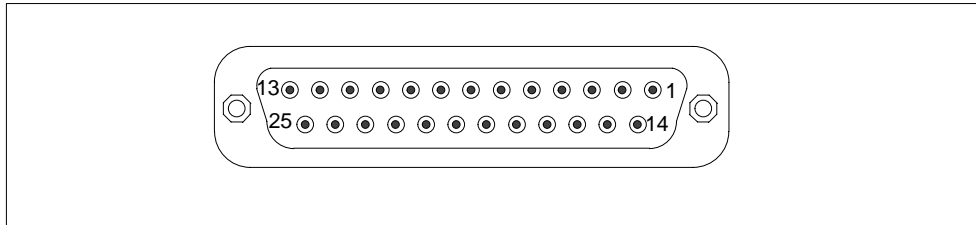

Pin No.	Designation	Description	Input /Output
1	/ Strobe (CLK)	Data message	Output (open collector)
2	Data - Bit 0	Data line 0	Output (TTL level)
3	Data - Bit 1	Data line 1	Output (TTL level)
4	Data - Bit 2	Data line 2	Output (TTL level)
5	Data - Bit 3	Data line 3	Output (TTL level)
6	Data - Bit 4	Data line 4	Output (TTL level)
7	Data - Bit 5	Data line 5	Output (TTL level)
8	Data - Bit 6	Data line 6	Output (TTL level)
9	Data - Bit 7	Data line 7	Output (TTL level)
10	/ACK	Acknowledge	Input (4,7 kΩ pull up)
11	BUSY	Not busy	Input (4,7 kΩ pull up)
12	PE (PAPER END)	Paper end	Input (4,7 kΩ pull up)
13	SELECT	Device selection	Input (4,7 kΩ pull up)
14	/ AUTO FEED	Automatic new line	Output (open collector)
15	/ ERROR	Device error	Input (4,7 kΩ pull up)
16	/ INIT	Reset / Initialization	Output (open collector)
17	/ SELECT IN	Printer selection	Output (open collector)
18 - 25	GND	Ground	-

7.3 Patch Cords

SIMATIC S5 Patch Cord

You can use the SIMATIC S5 cord set (not included in all delivered versions) to connect your SIMATIC Field PG P4 to a SIMATIC S5 PLC. Please not the comments in Chapter 3.

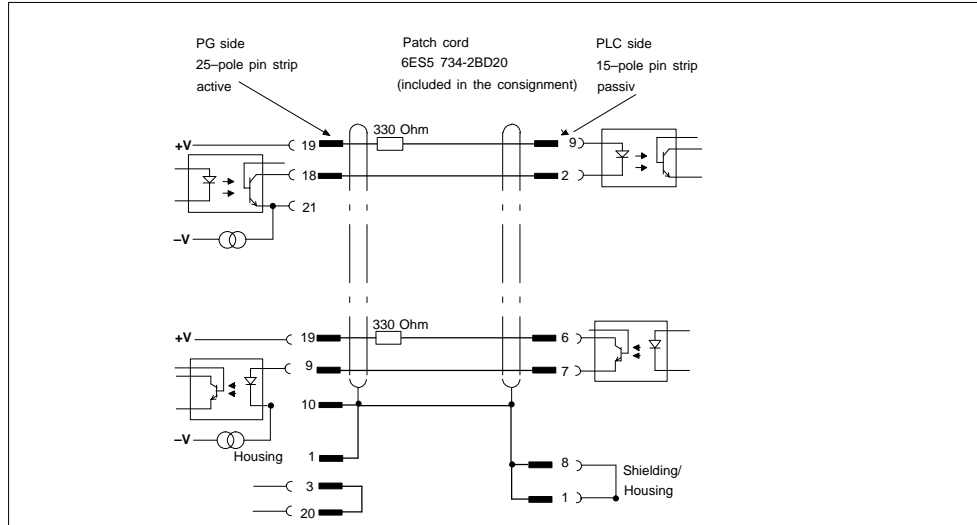

Fig. 7-4 SIMATIC S5 Standard Cord Set

MPI/DP Cord Set for SIMATIC S7

You can use the 6ES7901-0BF00-0AA0 cord set to connect your SIMATIC Field PG to a SIMATIC S7 PLC. Please not the comments in Chapter 3.

8

Reinstallation of the Software

What Does This Chapter Contain?

This chapter explains how to reinstall the software if the pre-installed software contains errors.

Chapter Overview

Section	Description	Page
8.1	Cause / Remedy	8-2
8.2	Restoring the Hard Disk (Data Deleted)	8-3
8.3	Installing Drivers and Software	8-6
8.4	Installing the Recovery CD for Microsoft Windows NT	8-6
8.5	Installing the Recovery CD for Microsoft Windows 2000	8-8
8.6	Installing the Recovery CD for Microsoft Windows XP	8-10
8.7	Installing the SIMATIC-Software	8-12

8.1 Cause / Remedy

In case of software errors reinstall your software using the Recovery CD, the Backup PG DVD and the Restore CD.

Recovery CD: contains the tools for installing the hard disk and the operating systems.

Backup PG DVD: contains the documentation, the SIMATIC Software and the hardware drivers.

Restore CD: contains an hard disk Image file with the original delivery software (Operating system with installed hardware drivers).

You can boot from the Restore CD and Recovery CD by pressing the ESC key when the BIOS message "Press <F2> to enter Setup" is displayed.

To restore all directories and files that were copied to your hard disk at the first set up proceed as follows:

1. Verify whether you can save your authorization or License Key to the hard disk and proceed as described below.
2. If it is not possible to save your authorization or License Key please contact the customer support hotline (see Getting Started). They will provide you with the information necessary for your transferring your authorization or License Key.

Then proceed as described in Section 8.2.

Saving Authorization or License Key on Diskettes

Please proceed as follows:

- Insert the License Key Disk in drive A:
- Click **Start** on the Windows task bar and
- Select **Simatic > License Management > Automation License Manager** to open the **Automation License Manager** which will help you to save all authorizations or License Keys on your License Key Disk.

8.2 Restoring the Hard Disk (Data Deleted)

8.2.1 Restoring the Software to Delivery Condition Using the Restore CD

Using the Restore CD you can restore the software to its original delivery state. The CD contains the necessary images and tools for transferring the the delivery software to the hard disk of the programming device. You can restore the entire hard disk with drive C: (system) and drive D: or just the restoration drive C:. User files on drive D: will be retained.

Caution

The option "Restore system partition only" will delete all the data on drive C: (System). All data, user settings and available authorizations on drive C: will be lost in the process! Drive C: will be deleted completely on the hard disk, reformatted and overwritten with the original version of the software.

With the option "Restore entire hard disk", all data, user settings and available authorizations or License Keys on the entire hard disk will be lost.

To restore the delivery state, proceed as follows:

- Insert the **Restore CD** in the drive, restart the device and press the **ESC** key when the BIOS message `Press <F2> to enter Setup` is displayed. After initialization, a "Boot Menu" is displayed.
- Press Enter to confirm your entries.
- Select the **CD-ROM Drive** using the cursor.
- Now follow the instructions on the screen.

Caution

All the existing **data, programs, user settings** and **authorizations** or **License Keys** on the drives **will be deleted** in the process and will thus be lost.

You will find the description of the functions in the README.TXT file on the Restore CD.

8.2.2 Creating Partitions under Windows NT

After installing a new hard disk it is necessary to create partitions when they partitions have errors or need to be changed.

Caution

By deleting or creating partitions all saved data is lost on the hard disk. All drives on the hard disk will be erased.

The hard disk is delivered with the following installed (only for versions delivered with Windows NT):

- a partition of with the FAT16 file system with 2045 Mbytes,
- a partition of with the NTFS file system.

To restore the partitions to their original condition, please do the following:

Primary Partition

1. Insert the Recovery CD into your CD-ROM drive and start the device.
2. To boot from the Recovery CD, press the ESC key when the BIOS message:
Press <F2> to enter Setup
is displayed. On the completion of initialization, a "Boot Menu" appears.
3. Select the "CD-ROM Drive" with the cursor.
4. When "Microsoft Windows 98 Startup Menu" is displayed, select "2. Boot for FDISK, FORMAT or Windows NT Setup".
5. Start the Microsoft Windows 98 hard disk configuration program with "A:\>FDisk" (A is the CD-ROM drive).
Select the dialog box for enable large disk support for installing a FAT16 partition "activate support (Y/N)...? [N]" for No.
6. Create a primary DOS-Partition of 2045 MB for a FAT 16 file system. Answer the question "Do you wish to use the maximum available size..." for a 2045 MB FAT16 partition with [Y] for Yes.
7. In order to continue with the next step "Create a Save to Disk Partition" the primary partition needs to be formatted.
Use the Recovery CD to boot as described in steps 1 to 3 above and then format drive C: with the program "Format".
Type: "A:\>Format C:".

The creation of NTFS partitions is done under the Windows NT setup program. Starting the Windows NT setup is described in chapter 8.4.

8.2.3 Creating Partitions under Windows 2000/XP Professional

After installing a new hard disk it is necessary to create partitions if the partitions contain errors or need to be changed.

Caution

All stored data is lost when you delete or create partitions. The hard disk partitions will be erased.

The hard disk is partitioned on delivery as follows (only for versions delivered with Windows):

- one partition with the FAT32 file system with at least 6100 Mbytes,
- one partition with the NTFS file system.

To restore the partition to its delivery state, proceed as follows:

Primary Partition, FAT32 File System

1. Insert the Recovery CD into your CD-ROM drive and start the device.
2. To boot from the Recovery CD, press the ESC key when the BIOS message:
Press <F2> to enter Setup
is displayed. On the completion of initialization, a "Boot Menu" appears.
3. Select the "CD-ROM Drive" with the cursor.
4. Select "2. Boot for FDISK, FORMAT or Windows 2000 Setup" or
"2. Boot for FDISK, FORMAT or Windows XP Professional Setup"
in the "Microsoft Windows 98 Startup Menu" screen form.
5. Start the Microsoft Windows hard disk configuration program with "A:\>FDisk".
In the screen form select "Do you wish to enable large disk support (Y/N)...?
[Y]" for Yes to support data media with large memory capacity.
6. Create a primary DOS partition with 4090 MB. Enter [N] for "No" for the
question "Do you want to use the maximum memory size available for the
primary DOS partition and do you want to activate this partition?" and set the
partition size to 10245 MB.
7. To format the partition from the Recovery CD, as described above in steps 1 to
3, reboot and then format drive C: with the "Format" program. Enter:
"A:\>Format C:"
(A: is the CD-ROM drive).

Creating an Extended FAT 32 Partition

In order to create an extended partition you have to boot from the Recovery CD as described above in steps 1 to 4.

Create an extended DOS partition for the rest of the disk space.

Under Windows 2000/XP, the FAT 32 file system can be changed to a NTFS file system with the "Format" function.

8.3 Installing Drivers and Software

Installieren the drivers and software from the supplied DVD "Backup PG". Proceed as follows:

1. Insert the DVD
2. Acrobat Reader must be installed
3. Navigate through the driver list to ../Drivers/FieldPG.pdf
4. Install the desired driver according to the Driver List.

8.4 Installing the Recovery CD for Microsoft Windows NT

This CD contains encoded data which can only be transferred onto a SIEMENS SIMATIC programming device.

Data transfer is carried out with the OEMSETUP.EXE program on the CD-ROM or, after booting, from the CD-ROM with the Recovery function.

After transferring the required data to the hard disk, the operating system can be installed using the Windows NT setup program.

Windows NT Installation Sequence

If a Windows operating system is already installed or if the PC has been started with a user created bootdisk, the transfer of the data takes place using the program OEMSETUP.EXE. To do this, start the program OEMSETUP.EXE on the recovery CD and continue the sequence as of point 5.

If there is no operating system installed, then please do the following:

1. Insert the Recovery CD into your CD-ROM drive and start the device.
2. To boot from the Recovery CD, press the ESC key when the BIOS message:
Press <F2> to enter Setup
is displayed. On the completion of initialization, a "Boot Menu" appears.
3. Select the "CD-ROM Drive" with the cursor.
4. When "Microsoft Windows 98-Startup Menu" is displayed, select "1. Boot for CD-Recovery".

5. You have to acknowledge the "SIEMENS End User License Agreement" with the F8 function key. Pressing ESC allows you to decline the agreement and cancels the installation.
6. In the next screens you can select the components which are to be copied from the CD to the hard disk. Transfer of at least the folder "I386" is necessary for the Windows NT installation or setup.
7. Select the drive for data transfer. You can use the selected drive as the installation drive for Windows. For the Windows setup, you need an available disk space of approximately 300 MB on the installation drive for Windows.

Caution

By default, drive C: is used for the data transfer (Recovery).

Ensure that there is an available disk space of approximately 300 MB left on drive C: after the selected recovery data have been copied.

8. Confirm the end message box.
9. Start the Windows setup program
LW:\I386\WinNT.exe
LW is the drive where the recovery data have been copied.

You can find the information on installation of Windows NT on the Recovery CD in the folder SUPPORT\BOOKS\.

Note

If you want to become an expert user of Microsoft Windows NT Workstation, see the "Windows NT Workstation Resource Kit" Version 4.0 (is not included in the package). It contains specific information for administrators who are responsible for installing, managing, and integrating Windows NT Workstation in a network or multiuser environment.

8.5 Installing the Recovery CD for Microsoft Windows 2000

Do not follow these instructions unless you want to upgrade from another Windows operating system to Windows 2000 or if you want to reinstall.

The new installation or reinstallation of the operating system is accomplished with the Recovery CD.

This CD contains encoded files which can only be transferred to a SIEMENS SIMATIC programming device.

The transfer of information is made with the program OEMSETUP.EXE on the CD-ROM, or after booting from the CD-ROM with the recovery function.

The installation of the operating system via the Windows 2000 setup program is possible after transferring the necessary data to the hard disk. The Windows 2000 setup starts when you enter

```
HD:\>i386\WinNT.exe
```

(HD: drive on which the folder I368 was transferred to).

Setup for Windows 2000 can be carried out on existing Windows installations via the program HD:\i386\WinNT32.exe.

Windows 2000 Installation Sequence

If a Windows operating system is already installed or if the programming device has been started with a bootdisk, the transfer of the data takes place using the program OEMSETUP.EXE. To do this, start the program OEMSETUP.EXE on the recovery CD and continue the sequence as of point 5.

If there is no operating system installed, then please do the following:

1. Insert the Recovery CD into your CD-ROM drive and start the device.
2. To boot from the Recovery CD, press the ESC key when the BIOS message:
Press <F2> to enter Setup
is displayed. On the completion of initialization, a "Boot Menu" appears.
3. Select the "CD-ROM Drive" with the cursor.
4. Select "1. Boot for CD-Recovery" in the screen "Microsoft Windows 98 Startup Menu".
If the hard disk has not been installed, first select "2. Boot for FDISK, FORMAT or Windows-Setup (Section 8.2.3).
5. You have to confirm the "SIEMENS End User License Agreement" with the F8 function key. Pressing ESC allows you to decline the agreement and cancels the installation.
6. In the next screens you can select the components which are to be copied from the CD to the hard disk. At the very least it is necessary to copy the folder "I386" to install or setup Windows 2000.
7. Select the drive for data transfer. The selected drive is not the installation drive for Windows. For the Windows setup, you need an available disk space of approximately 500 MB on the installation drive for Windows.

Notice

By default, drive C: is used for the data transfer (Recovery).

Ensure that there is an available disk space of approximately 500 MB left on drive C: after the selected recovery data have been copied.

8. Confirm the end message box.
9. Start the Windows setup program
LW:\I386\WinNT.exe
LW is the drive where the recovery data have been copied.
10. Now follow the screen instructions.

Choosing the Language for Windows 2000

The **Multilanguage User Interface (MUI)** allows you to set the Windows 2000 menus and dialogs to another language. This function is only available with the english version of Windows 2000.

In order to install the MUI, run the program MUISETUP.EXE in the MUI folder on the Recovery CD and follow the screen dialog to install the desired languages.

The desired language for Windows 2000 menus and dialogs, as well as the keyboard layout can be set via the control panel with the dialog **Start > Settings > Control Panel > Regional Options > tab "General" > box "Menus and dialogs"** and in the tab **"Inputs"**, box **"Keyboard layout"**.

In addition to the language for menus and dialogs, you can also set via **Regional Options** the standard for the region with **Set Default**.

Your device is set to English menus and dialogs and a US keyboard when delivered. You can set another language and keyboard via the control panel with the dialog **Start > Settings > Control Panel > Regional Options > tab "General"**, box **"Menus and dialogs"** > tab **"Input locales"**, box **"Input language"**.

8.5.1 Installing Drivers under Windows 2000

In order to add or change the device driver of any hardware component proceed as follows:

Procedure

- Click “Start” , point to “Settings”, click “Control Panel” , then double-click “System” .
- Click the “Device Manager” tab.
- Click on the plus sign next to the hardware type and then double-click on the selected hardware component.
- Click the “Driver” tab and then click “Update Driver”, then follow the instructions that appear on your screen.
- The “Driver” tab may not be available for some devices. In this case try to change the driver by double-clicking on the desired hardware icon in “Control panel”.

8.6 Installing the Recovery CD for Microsoft Windows XP

Do not follow these instructions unless you want to upgrade from another Windows operating system to Windows XP or if you want to reinstall.

The new installation or reinstallation of the operating system is accomplished with the Recovery CD.

This CD contains encoded files which can only be transferred to a SIEMENS SIMATIC programming device.

Data transfer is made with the OEMSETUP.EXE program on the CD ROM, or after booting from the CD ROM with the recovery function.

After transferring the required data to the hard disk, the operating system can be installed using the Windows XP Professional setup program. The Windows XP setup starts when you enter

```
HD:>i386\WinNT.bat
```

(HD: drive on which the folder I368 was transferred to). Setup for Windows XP can be carried out on existing Windows installations via the program

```
HD:i386\WinNT32.exe.
```

Windows XP Professional Installation Sequence

If a Windows operating system is already installed or if the PC has been started with a user created bootdisk, data transfer takes place using the OEMSETUP.EXE program. To do this, start the OEMSETUP.EXE program on the Recovery CD and continue the sequence as of point 5.

If there is no operating system installed, then please do the following:

1. Insert the Recovery CD into your CD-ROM drive and start the device.
2. To boot from the Recovery CD, press the ESC key when the BIOS message:
Press <F2> to enter Setup
is displayed. On the completion of initialization, a "Boot Menu" appears.
3. Select the "CD-ROM Drive" with the cursor.
4. When "Microsoft Windows 98 Startup Menu" is displayed, select
"1. Boot for CD-Recovery".
If the hard disk has not been installed, first select "2. Boot for FDISK, FORMAT
or Windows-Setup (Section 8.2.3).
5. You have to acknowledge the "SIEMENS End User License Agreement" with
the F8 function key. Pressing ESC allows you to decline the agreement and
cancels the installation.
6. In the next screen you can select the components which are to be copied from
the CD to the hard disk. Transfer of at least the folder "I386" is necessary for
the Windows XP installation or setup.
7. Select the drive for data transfer. The selected drive is not the installation drive
for Windows. For the Windows setup, you need an available disk space of
approximately 1500 MB on the installation drive for Windows.

Notice

By default, drive C: is used for the data transfer (Recovery).

Ensure that there is an available disk space of approximately 1500 MB left on
drive C: after the selected recovery data have been copied.

8. Confirm the end message box.
9. Start the Windows setup program
LW:\I386\WinNT.bat
LW is the drive where the recovery data have been copied.
10. Now follow the screen instructions.

Setting the Language Selection for Windows XP Professional

The **M**ultilanguage **U**ser **I**nterface (MUI) allows you to set the Windows XP
Professional menus and dialogs to another language.

In order to install the MUI, run the program MUISETUP.EXE in the
CD_DRIVE:\MUI folder on the Recovery CD "MUI german" or in the root directory
on the Recovery CD "MUI Windows XP". Please follow the screen dialog to install
the desired languages.

Windows XP MUI with English menus and dialogs and a US keyboard is installed on your device when delivered. You can set another language and keyboard via the control panel with the dialog **Start >Control Panel > Date, Time, Language, and Regional Options > Add other languages** tab "Languages", box "Language used in menus and dialogs".

In addition to the language for menus and dialogs, you also have to set the standard for **non-Unicode programs** for **Date, Time and Regional Options** via **Advanced**.

8.7 Installing the SIMATIC Software

You received the "Backup PG" DVD with the product package that comes with your PG. The Backup CD contains the data base for the STEP 5 Basics package (not included in all delivered versions), STEP 7 and STEP 7-Micro/WIN and for the PG's electronic manuals.

To reinstall these program packages, insert the DVD "Backup PG" in the CD-ROM drive. Run Setup by clicking the "SIMATIC Setup" icon or by clicking "Setup.exe" in the "SIMATIC Software" directory. Setup will guide you through the installation.

The License Key Disk with the authorizations and License Keys necessary for the use of SIMATIC software is only delivered with versions containing the corresponding SIMATIC software.

The installation of the authorizations or the activation of the License Keys is described in Section 3.4.1 "Cold Start of the Field PG P4".

Guidelines for Handling Electrostatically-Sensitive Devices (ESD)

A

Chapter Overview

Section	Description	Page
A.1	What is ESD?	A-2
A.2	Electrostatic Charging of Persons	A-3
A.3	General Protective Measures Against Electrostatic Discharge Damage	A-4

A.1 What is ESD?

Definition

All electronic modules are equipped with large-scale integrated ICs or components. Due to their design, these electronic elements are very sensitive to overvoltages and thus to any electrostatic discharge.

These **Electrostatically-Sensitive Devices** are commonly referred to by the abbreviation **ESD**.

Electrostatically-sensitive devices are labeled with the following symbol:

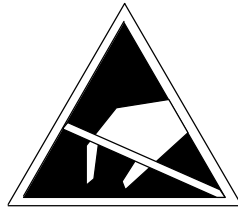

Caution

Electrostatically-sensitive devices are subject to voltages that are far below the voltage values that can still be perceived by human beings. These voltages are present if you touch a component or the electrical connections of a module without previously being electrostatically discharged. In most cases, the damage caused by an overvoltage is not immediately noticeable and results in total damage only after a prolonged period of operation.

A.2 Electrostatic Charging of Persons

Charging

Every person with a non-conductive connection to the electrical potential of its surroundings can be charged electrostatically.

Figure A-1 shows you the maximum values for electrostatic voltages which can build up on a person coming into contact with the materials indicated in the figure. These values are in conformity with the specifications of IEC 801-2.

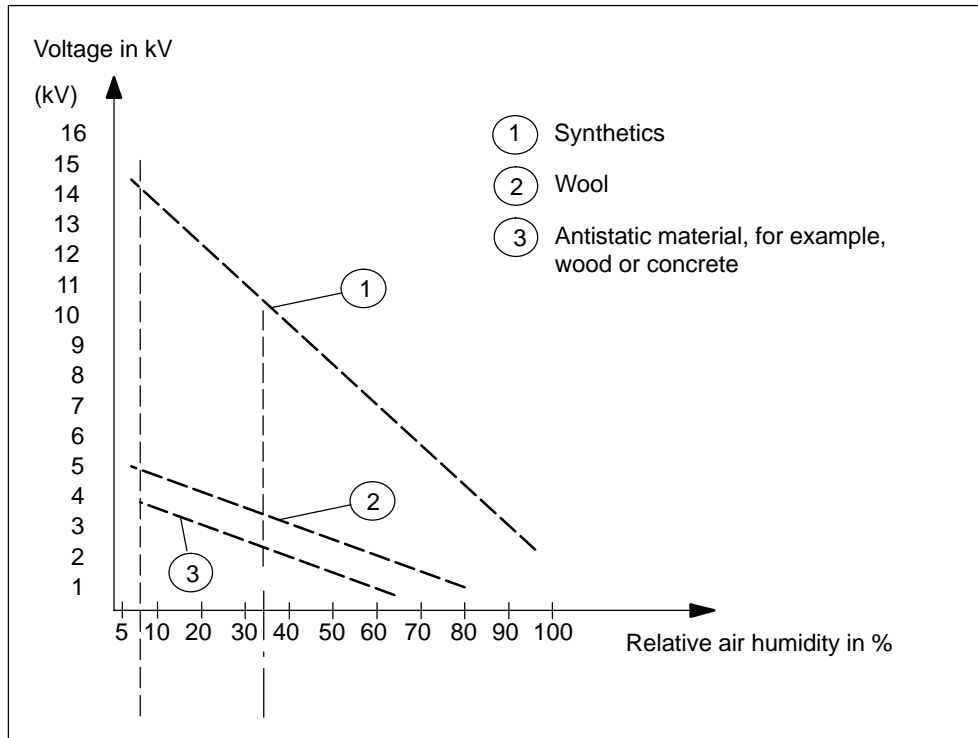

Fig. A-1 Electrostatic Voltages which can Build up on a Person

A.3 General Protective Measures Against Electrostatic Discharge Damage

Ensure Sufficient Grounding

Make sure that the personnel, working surfaces, and packaging are sufficiently grounded when handling electrostatically-sensitive devices. You thus avoid electrostatic charging.

Avoid Direct Contact

You should touch electrostatically-sensitive devices only if it is unavoidable (for example, during maintenance work). Hold modules without touching the pins of components or printed conductors. In this way, the discharged energy cannot affect the sensitive devices.

If you have to carry out measurements on a module, you must discharge your body's electrostatic charge before you start the measurement by touching grounded metallic parts. Use grounded measuring devices only.

Technical Specifications

B

Note

At the start of the PG the BIOS messages (Summary Screen) offer a precise overview of your SIMATIC Field PG P4 configuration

General	
Dimensions (w x h x d)	328 x 294 x 52 mm
Weight	approx. 4 kg
Line voltage external power supply	100 VAC to 240 VAC (+ 10% / – 15%), sinusoidal
Line voltage frequency	50 / 60 Hz (47 to 63 Hz)
Brief voltage interruption acc. to Namur	> 20 ms at 93 V (AC power supply) (max. 10 times per hour; min. recovery time 1 s)
Max. power consumption	90 W
Output DC voltage (external power supply)	18.5 V
Output DC current (external power supply)	max. 4.3 A
Output DC power (external power supply)	max. 80 W
Standby power (battery operation)	typ 1.5 W
Lithium Ion rechargeable battery (9 cells) with charge-status monitoring	approx. 6 Ah, 11.1 V with thermostatic switch and multifuse, recyclable, chargeable up to 40°C (108° F), high number of charge cycles under severe conditions, low self-discharge rate
Degree of protection	IP30 (covers closed)
Quality assurance	ISO 9001
Safety	
Requirements	VDE 0805 \triangleq EN 60950 and IEC 60950 Protection class I to IEC 60536 Protective separation between supply and secondary circuit (via external power supply)
Noise emission	<45 dB(A) to DIN 45635
Electromagnetic compatibility (EMC)	
Emitted interference	limit value class B to EN 55022, EN 6100–3–2,
Line-fed interference on AC supply lines	± 2 kV (IEC 61000-4-4; burst) ± 1 kV (IEC 61000-4-5; μ s pulse/line to line) ± 2 kV (IEC 61000-4-5; μ s pulse/line to ground)
Noise immunity on signal lines	± 2 kV (IEC 61000-4-4; burst; length >3 m) ± 2 kV (IEC 61000-4-5; μ s pulse/line to ground; length > 20 m)
Noise immunity to discharges of static electricity	± 4 kV, Contact discharge (IEC 61000-4-2; ESD) ± 8 kV, Air discharge (IEC 61000-4-2; ESD)
Immunity to RF interference	10 V/m, with 80% amplitude modulation at 1 kHz, 9 kHz - 80 MHz (to IEC 61000-4-6) 10 V/m with 80% amplitude modulation at 1 kHz, 80 kHz - 1GHz (to IEC 61000-4-3) 10 V/m, pulse modulated 50% duty cycle, 900MHz and 1,89 GHz (to IEC 61000-4-3)
Magnetic field	30 A/m, 50Hz (to IEC 61000-4-8)

Ambient conditions	
Temperature operation *) storage/transport	tested to DIN IEC 60068-2-1, DIN IEC 60068-2-2 +5° C to +40° C *(no condensation permitted) – 20° C to +60° C**(no condensation permitted) (*10° C/h, ** 20° C/h)
Relative humidity operation storage/transport	tested to DIN IEC 60068-2-3, 60068–2–30, 60068–2–14 5% to 80% at 25° C (no condensation permitted) 5% to 95% at 25° C (no condensation permitted)
Mechanical specifications	
Vibration operation *) transport	tested to DIN IEC 60068-2-6 10 to 58Hz; amplitude 0.035 mm 58 to 500Hz; acceleration 5 m/s ² 5 to 9Hz; amplitude 3.5 mm 9 to 500Hz; acceleration 9.8 m/s ²
Shock operation *) storage	tested to DIN IEC 60068-2-29 half-sine: 50 m/s ² , 30 ms, 100 shocks half-sine: 250 m/s ² , 6 ms, 1,000 shocks
Motherboard	
Integrated processor	Intel Mobile Pentium P4 / Celeron (see BIOS)
Level 2 cache	first level: 16 Kbytes data, 16 Kbytes program second level: 256/512 Kbytes (processor dependent)
Main memory	256 Mbytes expandable to max. 1024 Mbytes, (DDR266, PC2100, SO-DIMM) (for memory expansion see BIOS)
Drives	
Floppy disk drive	Standard Floppy disk drive (1.44 Mbytes or 720 Kbytes)
Hard disk drive	2.5" (capacity see BIOS)
Hard disk/CD ROM controller	IDE (ATA)-100/IDE (ATA)-33
Optical Drive	DVD-ROM/CD-RW (24x CD-ROM, 8x DVD, 10x CD-RW) DVD±R/±RW (24x CD-ROM, 8x DVD, 10x CD-RW, 2x DVD-R, 1x DVD-RW) (equipment see BIOS)
Graphics	
Controller	S3 Pro Savage DDR (integrated in Chipset)
Graphics memory	Shared Memory Architecture
Resolutions / frequencies / colors	CRT only: up to 1600 x 1200 at 60 Hz / 16 Bit colors CRT only: 1280 x 1024 at 100 Hz / 32 Bit colors

*) The burning operation with the DVD-ROM/CD-RW or DVD±R/±RW drive is only permissible in an untroubled environment and under an ambient temperature not exceeding 35°C.

Ports	
Ethernet	RJ45, 10/100 Mbits, Controller VIA VT 6103
DC-In	DC-voltage input, phono jack
Headphone and microphone connector	for 3.5 mm phone jack respectively
Function displays	
Status LEDs	Caps Lock Scroll Lock Num Lock Battery status Device status Access to FD / HD / CR-ROM S5 Module/Memory Card active MPI/DP token passing

Glossary

What does This Chapter Contain?

This chapter contains a glossary in which you will find a list of the terminology used in conjunction with the Siemens range of programming devices and a brief explanation of each of the terms.

A

AC

Alternating Current. Current that changes its direction at regular intervals.

Access Protection

Access to the programs and data of a programming device can be protected by passwords.

ACPI

Advanced Configuration and Power Interface. Power management specification for controlling computers' energy. ACPI enables the operating system to control the amount of power given to each device connected to the computer.

APM

Advanced Power Management

Application

An application is a program which builds directly on, for example, the MS-DOS/Windows operating system. Applications on your programming device are, for example, the STEP 5 Basic package, STEP 7, etc.

ASCII-Editor

With an ASCII editor you can edit text files which are stored in ASCII code.

B

Backup

Duplicate of a program, storage medium or database. Created to backup or to protect irreplaceable data of working copies as a precaution against corruption or destruction. Some applications automatically create backup copies, while managing both the current version as well as the previous version that is stored on the hard disk drive.

Base Memory

The base memory is a part of the main memory. It is 640 Kbytes for all programming devices. The size is entered in the SETUP menu under the entry "System Memory" and is not changed even if the memory is extended.

BIOS

Acronym for **B**asic **I**nput/**O**utput **S**ystem. On PC-compatible computers, the set of essential software routines that tests hardware at startup, starts the operating system, and supports the transfer of data among hardware devices.

Boot Diskette

Boot disk that contains a boot sector and an initial loader for the operating system.

Boot

Start or restart of the PG. During the boot sequence the operating system is transferred from the system drive into the main memory.

Booting

Loading operation which transfers the operating system to the main memory.

Bps

The speed (in bits per second) with which information is transmitted over a data link.

C**Cache**

The cache memory buffers often used data to increase the speed of access. The computer has two cache levels.

Cardbus interface

This interface is compatible with 32-bit Cardbus Cards with PCI performance compliant with the PC Card standard.

CD ROM

Compact **D**isc **R**ead **O**nly **M**emory. Removable memory for large amounts of data.

Click

Pressing and immediately releasing the left mouse button; selects objects or triggers commands.

COM2 Port

Serial RS-232 interface which can be used to connect a mouse or a printer.

Configuration Files

These are files containing data which define the configuration after booting. Examples of such files are CONFIG.SYS, AUTOEXEC.BAT and the registry.

Configuration Software

The configuration software updates the device configuration when new modules are installed. This is done either by copying the configuration files supplied with the module or by manual configuration using the configuration utility.

Controller

Integrated hardware and software controllers that control the functions of certain internal or peripheral devices (for example, the keyboard controller).

Cursor

Collective term for mouse pointer and text cursor.

Cursor Control

Keypad on the keyboard for controlling the cursor.

D

DC

Direct **C**urrent. Unidirectional electrical current.

DIMM

Dual **I**nline **M**emory **M**odule. Memory RAM chips that are installed on the PCB, similar to the more common SIMM (Single Inline Memory Module) chips. The DIMM with its 64-bit data bus architecture has connections on both sides which are connected to different circuits for processing different instructions. SIMMs, however, have a 32-bit data bus architecture where all lines are connected to the same circuit for processing the same instructions. DIMMs can be installed in the computer as single chip, SIMMs, on the contrary, only in pairs.

Device Configuration

The configuration of a programming device contains information on hardware and device options, such as memory configuration, drive types, monitor, network address, etc. The data are stored in a configuration file and enable the operating system to load the correct device drivers and configure the correct device parameters.

If changes are made to the hardware configuration, the user can change entries in the configuration file using the SETUP program.

Disk Drive

The disk drive (floppy disk drive) is used to store programs and data on diskette (write access) or to load from diskette to the computer (read access).

Diskette

The diskette (floppy disk) is an external data access memory on which all types of files and programs can be stored. The storage medium is a round magnetic disk in a plastic cover to protect it from getting scratched.

Display

Flat screen monitor of the PG.

Double-Click

Pressing and releasing the left mouse button very quickly twice in succession without moving the mouse. This action is normally to open an object or program.

Drives

Devices for operating rotary disk media (diskettes, hard disk, CDs).

Drivers

These are programs which are part of the operating system. They adapt user program data to the specific formats required by I/O devices such as hard disk, printers, and monitors.

Drop-Down Menu

In graphics-supported programs, a menu line is positioned on the top edge of the screen. The menu titles contained in this line can be set either as drop-down or pull-down menus. Drop-down menus "roll" down as soon as the mouse pointer passes over a menu title. Pull-down menus only "roll" down when the menu title is clicked on. Different functions can then be called from these menus by moving the mouse and clicking on an item in a menu.

E**EPROM/EEPROM Submodules**

These are plug-in submodules with EPROM/EEPROM chips. S5 user programs can be stored on them. These programmed submodules are then plugged into specially designed slots in the programmable logic controller.

Ethernet

Local network (bus structure) for text and data communication with a transfer rate of 10 Mbaud.

Extended Memory

Memory extensions can be installed in the programming device to increase the width of the memory.

F

File

A complete, named collection of information, such as a program, a set of data used by a program, or a user-created document. A file is the basic unit of storage that enables a computer to distinguish one set of information from another.

Formatting

Formatting divides the memory area on a magnetic data medium into tracks and sectors. Formatting deletes all the data on a data medium. Every data medium must be formatted before it is used for the first time.

Function Keys

Function keys can be divided into two different types; the normal function keys which are assigned a particular function of the computer (for example, delete key), and programmable function keys (softkeys).

H

Hard Copy

The output of the complete contents of the screen on a printer is called a hard copy.

Hard Disk Drive

Hard disk drives (Winchester drives) are a form of magnetic disk memory where the magnetic disks are permanently built into the drive.

HMI

Human **M**achine Interface

I

Image

This refers to the image of harddisk partitions saved in a file in order to restore them when necessary.

Industrial Ethernet

Bus system based on the Ethernet standard. Components of the SIMATIC S5 and S7 series (programming devices, programmable logic controllers, programmable control systems) can be networked using Industrial Ethernet NICs.

Interface module

Module for the connection of peripheral hardware.

Interrupt

When the processor receives an interrupt, it suspends its current operations, saves the status of its work, and transfers control to a special routine known as an interrupt handler. This routine processes an instruction set to deal with the particular situation that caused the interrupt. Interrupts can be generated by various hardware devices to request service or report problems.

Interface

- An interface is the connection between individual hardware elements such as PLCs, programming devices, printers, or monitors via physical connections (cables).
- An interface is also the connection between different programs, to enable them to work together.

Interface Module

Module which controls and extends the hardware periphery.

IRQ

Acronym for interrupt request. One of a set of possible hardware interrupts, identified by a number. The number of the IRQ determines which interrupt handler will be used. In the AT bus, ISA, and EISA, 15 IRQs are available. Each device's IRQ is hardwired or set by a jumper or DIP switch.

ISA

Industrial **S**tandard **A**rchitecture (bus for expansion modules)

K

Keyboard

A keyboard is the collection of keys which are used to input data, text, characters, letters, numbers, special characters, and control commands in a computer. The keyboard forms the input interface between the user and the computer.

L

LCD

Liquid **C**ystal **D**isplay. Display type on the base of liquid crystals with a thin film polarized molecular structure, enclosed between two transparent electrodes.

LED

Light **E**mitting **D**iode (for example, status display). Semiconductor diode that transforms electrical energy into light.

License Key

The license key is the electronic key for a license. Siemens AG issues license keys for software that is legally protected by license.

LPT1 Port

The LPT1 port (Centronics port) is a parallel interface that can be used to connect a printer.

M

Main Memory

Main memory is a RAM memory in the CPU that is accessed by the CPU during user program processing.

Memory Card

Memory Cards in credit card format. memory for user programs and parameters, for example, for programmable modules and CPs.

Micro Memory Card

New and very compact card for SIMATIC.

Memory Expansion

See Extended Memory

Modem

Communications device that enables a computer to send and receive data over a telephone line. **Modulator** and **demodulator** of a signal transmission facility. It converts the digital pulses from a computer into analog signals (and vice versa).

Module

Modules are boards (printed circuit boards) which can be plugged into a programmable logic controller or programming device. They are available, for instance, as central controller modules, interface modules, or as bulk memory modules.

Monitor

The device on which images generated by the computer's video adapter are displayed.

Mother Board

The mother board is the core of the programming device. From here data are processed and stored, interfaces and device I/Os are controlled and managed.

Mouse

The mouse is a pointing device with which the user inputs coordinates (x,y). By moving the mouse, the mouse pointer can be moved at will around the screen. By pressing the left mouse button, the position is marked. The other mouse keys may have different assignments according to the application. With the mouse, objects can be selected, menus processed, and functions started.

Mouse Pointer

The mouse pointer is moved across the worktop (screen) by means of the mouse. The mouse pointer selects, for example, objects which are to be processed.

MPI/DP

The multipoint interface (MPI) is the programming device interface for SIMATIC S7. It offers simultaneous operation from one central station of several programming devices, text displays, and operator panels. The stations on the MPI can communicate with each other.

MS-DOS

The single **Microsoft-Disk-Operating-System** is one of the standard OS for PCs.

N

Network

Link between programming devices and programmable controllers by means of interface modules, physical cables, and the corresponding software to allow data exchange between the devices.

O

Operating System

Collective term for all functions which, in conjunction with the hardware, control and monitor execution of the user programs, the distribution of resources among the individual user programs, and the maintenance of the operating mode (for example, Windows 98, MS-DOS).

P

Parallel Interface

Information is transmitted byte for byte via a parallel interface (port). This means that the transmission rate is very fast. The programming devices have one parallel interface (LPT1).

Password

Unique sequence of characters that is entered for user identification. See Access Protection.

PC

Personal computer

PC Card

Trademark of the Personal Computer Memory Card International Association (PCMCIA). Designation for auxiliary cards that conform with PCMCIA specifications. The PC Card that has roughly the size of a credit card can be plugged into a PCMCIA slot. Version 1 specifies cards of Type I with a thickness of 3.3 millimeters, which is conceived mainly for use as external memory. Version 2 of the PCMCIA specification also defines a card Type II with thickness of 5 mm and a card of the Type III with a thickness of 10.5 mm. Type II cards can realize devices such as modems, fax and network interface cards. Type III cards are equipped with devices that require more space, for example wireless communication modules or rotary storage media (hard disk drives, for example).

PCI

Peripheral Component Interconnect (high-speed I/O expansion bus)

PCMCIA

(Personal Computer Memory Card International Association). Association of about 450 computer companies with the aim of setting worldwide standards for miniaturizing PC expansion cards and making their use more flexible, offering the market a basis for development. Cooperates with JEIDA.
See Cardbus interface.

PG

Compact programming device especially for industrial applications. The PG is fully equipped for programming SIMATIC PLCs.

PG LINK

Serial interface on a CPU, CP/IP module and coordination module (PG-MUX). Used to connect a programming device. Some CPUs are optionally equipped with two PG links.

Pixel

Pix Element (picture point). The pixel represents the smallest element that can be reproduced on-screen or on a printer.

PLC

SIMATIC S5 programmable logic controller

Plug and Play

Generally, a reference to the ability of a computer to automatically configure the system for communication with peripheral devices (for example monitors, modems or printers). The user can plug in a peripheral and "play" it at once without manually configuring the system. The Plug and Play PC requires both a BIOS that supports Plug and Play and a corresponding expansion card.

PROFIBUS

Bus system based on the PROFIBUS standard. Components of the SIMATIC S5 and S7 series (programming devices, programmable logic controllers, programmable control systems, distributed I/Os) can be networked using PROFIBUS.

Programmable Logic Controller System

The programmable logic controllers (PLC) of the SIMATIC S5 system consist of one or more CPUs and various I/O modules. The PLCs of the SIMATIC S7 system (for example, S7-200, S7-300, S7-400) consist of one or more CPUs and various I/O modules.

Programmable Controller (AS)

This programmable controller (PLC) consists of the central unit, a CPU and of diverse I/O modules.

Pull-Down Menu

See Drop-Down Menu

R

RAM

RAM (**R**andom **A**ccess **M**emory) is a volatile read/write memory in which every memory location can be addressed individually and its contents changed. RAM is used to store data and programs.

Recovery CD

Contains the DOS tools for setting up harddisks and the Windows operating system.

Restart

Warm start of a computer in operate state without switching off the power supply (Ctrl + Alt + Del).

Restore CD

The Restore CD restores your system partition or your entire harddisk to the delivery state in the event of an error. The CD contains the image files required for this procedure and you can boot from the CD. In addition, you can create a Start diskette, which enables you to perform the restoration via networks.

ROM

ROM (**R**ead **O**nly **M**emory) is a non-volatile memory in which every memory location can be addressed individually. They contain factory set programs and data that are not lost in the event of a power failure.

RS-232 Interface

The RS-232 interface is a standardized interface for data transmission. Printers, modems and other hardware modules can be connected to a RS-232 interface.

RTC

Real Time Clock

S**SCSI Interface**

Small **C**omputer **S**ystem Interface. Interface for connecting SCSI devices (hard disk drives, CD-ROM drives).

Serial Interface

Data is transmitted one bit at a time via a serial interface (port); serial interfaces are therefore slower than parallel interfaces.

SETUP

A program in which information about the device configuration (that is, the configuration of the hardware on the programming device) is defined. The device configuration of the programming device is preset with defaults. Changes must therefore be entered in the SETUP if a memory extension, new modules, or a new drive are added to the hardware configuration.

SIMATIC S5 Memory Submodules

Memory submodules for SIMATIC S5 which are programmed with the PG and can be plugged into an S5 programmable logic controller.

SIMATIC Memory Cards

Memory submodules in credit-card format for SIMATIC S5 and SIMATIC S7 which are programmed with the PG and can be plugged into an S5 or S7 programmable logic controller.

Software

The collective term for all programs which are used on a computer. The operating system and the user programs are part of the concept "software".

SOM

Safecard On Motherboard. Consists of a monitoring module on the motherboard, the driver and the SOM program. Provides functions for monitoring various temperatures and the program cycle (Watchdog).

Standby

Power saving status: for example, hard disk drive or display turned off.

STEP 5

This is a software package which represents the basis for all other STEP 5 software packages. With the programming device (PG), this package is used to program programmable logic controllers of the SIMATIC S5 family. The language used is known as STEP 5.

STEP 7

Programming software for the creation of user programs for SIMATIC S7 control.

STN Display

Super Twist Nematic passive display

Suspend to Disk

Transition to power-off status, with prior saving of the system contents to the hard disk drive.

Suspend to RAM

Transition to power-saving status, with prior saving of the system contents to the RAM.

T**Text Cursor**

The cursor shows where text may be entered, for example, in text editors and in dialog windows. In many applications the position of the cursor can be changed by moving and clicking with the mouse pointer.

TFT

Thin-Film-Transistor. Technology for liquid crystal displays (LCD). The display consists of a large grid of LCD cells. Each one of the pixels represents a single cell. The electrical field in the cells is supported by thin film transistors.

Touchpad

The Touchpad is used in many programs (with mouse control) as an input device for cursor control and menu operation. The Touchpad works with touch-sensitive sensors. The cursor can be moved over the screen with the touch of a finger.

U**USB**

Acronym for universal serial bus. A serial bus with a data transfer rate of max. 12 megabits per second (Mbps) for USB 1.1 or 480 Mbps for USB 2.0 for connecting peripherals to a computer. USB can connect up to 127 peripherals, such as external CD-ROM drives, printers, modems, mice, and keyboards, to the system through a single, general-purpose port. This is accomplished by daisy chaining peripherals together.

User Interface

The software-controlled menus and screens on the monitor through which the user communicates with the program.

User program

Contains all instructions, declarations and signal processing data that can be used for system or a process control. It is assigned to a programmable module (for example, CPU, FM) and can be split into smaller blocks (modules).

V**VGA**

Video Graphics Array. Industrial standard graphics adapter for use with any commonly used software.

W

Warm Start

Restart of a computer in operate state without switching off the power supply (Ctrl + Alt + Del).

Working Memory

The memory in which a program is stored which can be processed. Also known as main memory.

Write Protection

Write protection for files or diskettes

- Write protection for files; this type of write protection is stored in the computer and is allocated by the system manager.
- Floppy disk write protection; for 3 1/2 in. diskettes by opening the write protection hole.

Index

A

ACPI, 5-17
Additional Software, 2-19
Air venting slots, 2-4, 2-7
Authorization, 3-9, 8-2

B

Backup PG DVD, 8-2
Battery, replacing, 3-5
Battery, 2-21, 3-5
 disposal, 3-6
Battery operation, 3-5
BIOS Setup
 Boot Menu, 5-19
 date, 5-6
 Exit Menu, 5-22
 Memory Cache, 5-8
 Menu Structure, 5-14
 Power Menu, 5-17
 Security Menu, 5-16
 time, 5-6
 Version menu, 5-21

C

Calibration cycle, 3-6
Cardbus, 3-19
Choosing the Language, for Windows 2000, 8-9
Cold Start, 3-8
COM 1, 7-10
Commissioning, 3-8
Complete restart, 3-10
Connecting
 external monitor, 3-13
 external power supply, 3-4
 headphone, 3-15
 microphone, 3-15
 Mouse, 3-14
 USB Devices, 3-14
Creating Partitions
 under Windows 2000/XP, 8-5
 under Windows NT, 8-4
Cursor key, 2-11

D

Device configuration, 5-1, 5-2

Display, 2-3
Display interlock, 2-4
Drives
 DVD ROM/CD RW, 2-6, 2-18
 DVD+R/+RW, 2-6, 2-18

E

Edit EPROM, 3-16
Energy Options, 2-16
Error Diagnostics, 6-1
Expansion, 4-1
External power supply, 2-20

F

Floppy disk drive, 2-6, 2-17
Function Key, 2-12

H

Hard Disk Drive, 2-17
Hardware Information, 7-1
Headphones, 2-6
Hibernate mode, 2-16

I

Installing, Drivers and Software, 8-6
Installing Drivers, under Windows 2000, 8-10
Installing memory submodules, 4-3
Installing the Recovery CD
 for Microsoft Windows 2000, 8-8
 for Microsoft Windows NT, 8-6
 for Microsoft Windows XP, 8-10
Installing the SIMATIC Software, 8-12
Interface
 Ethernet, 2-5
 Interface Cable, 2-5, 7-8
 Memory Card, 2-7
 Micro Memory Card, 2-7
 MPI/DP, 2-5, 3-21
 PC Card, 2-6
 RJ45 Ethernet, 3-24
 USB, 2-4
 VGA, 2-5
Interface Cable, 2-5, 3-12, 7-8
Interface Pinout, 7-3

K

Keyboard, 2-3, 2-9
Keyboard-LEDs, 2-2

L

LEDs, 2-2, 2-14
License Key, 3-9, 8-2
LPT 1, 7-11

M

Memory expansion, 2-8, 4-2
Micro Memory Cards, 3-18
Mouse buttons, 2-3
MPI/DP Interface, 3-21

O

On/Off Pushbutton, 2-15
Optical Drive, 2-6, 2-18

P

Panel, 3-11
Patch Cords, 7-12
PC interface, 3-19
Pin assignment
 COM1, 7-10
 DC-In, 7-3
 Ethernet, 7-6
 headphone, 7-7
 Micro-In, 7-7
 MPI/DP, 7-5
 S5 Online AG, 7-9
 USB, 7-3
 VGA, 7-4
Point-to-point connection, 3-20
Power Button, 2-4, 2-15
Power Management, 2-15

Power supply, 2-20
Processor Upgrade, 4-4
PROFIBUS, 3-23

R

Rechargeable battery, 2-8
Recovery CD, 8-2
Restart, 3-9, 3-10
Restore CD, 8-2
Restoring
 the Hard Disk, 8-3
 the Software, 8-3
RJ45 Ethernet Interface, 3-24

S

S5 Memory Submodules, 3-16
Setting up, 3-3
SIMATIC memory cards, 3-17
SIMATIC S7 Programmable Controller, 3-21
SIMATIC Software, 3-10
Software activation, 3-8
Special keys, 2-10
Status of the battery, 2-2
Stereo Loudspeaker, 2-3
Switching on, 3-8
system startup, 3-9
System-LEDs, 2-2

T

Touchpad, 2-4, 2-13

U

Universal Serial Bus, Glossary-15
Unpacking, 3-2
USB Interface, 2-4