



Machine Guard & Cover Co.

888.482.7371

[www.machineguard.com](http://www.machineguard.com)



6187 136th Avenue  
Holland, MI 49424



# Machine Guard & Cover Co.

888.482.7371

[www.machineguard.com](http://www.machineguard.com)

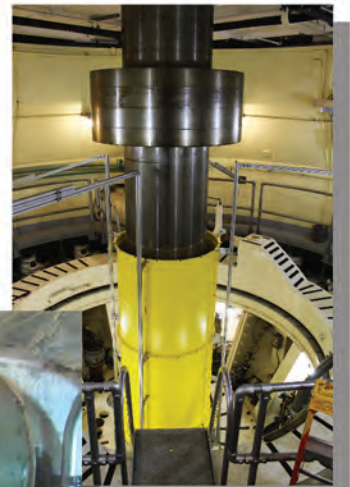
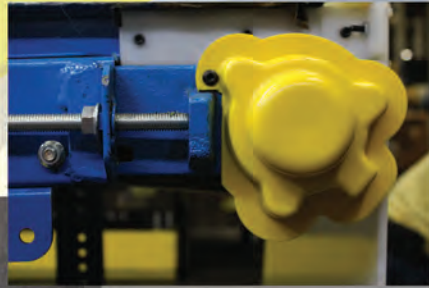

6187 136th Avenue  
Holland, MI 49424



**Machine Guard & Cover Co.**

6187 136<sup>th</sup> Avenue, Holland, MI 49424

888.482.7371 www.machineguard.com

Since 1992, Machine Guard & Cover Co. has manufactured nonmetallic plastic machine guards in ABS, metal detectable ABS, PETG, Kydex, Polycarbonate and other materials to provide off the shelf and custom solutions for point guarding power transmission systems.

We can create guarding solutions for your specific application with custom flanges, unflanged guards, extra cuts, holes, bends, or Safety Captured Fasteners.

---

---

When properly installed, products manufactured by Machine Guard & Cover Co. are intended to meet the ANSI B11.19-2010 standards for guarding power transmission systems.

The full ANSI guarding criteria should be consulted for complete details.

**ANSI B11.19-2010: Performance Criteria for Safeguarding - Standard Requirements: 7.2.6**

The user shall ensure that guards are installed, maintained and operated so as to protect against:

- Unauthorized adjustment or circumvention;
- Hazards between the guard and the moving machine or tooling parts

**Explanatory Information: E7.2.6**

Guards installed in such a manner that tools are necessary for their adjustment or removal may satisfy this requirement.

Examples of some types of fasteners that should not be used are:

- slotted or Phillips head screws;
- wing nuts;
- magnets;
- latches and hasps;
- hooks and eyes.

The devices should be checked frequently for proper operation.

---

---

**Machine Guard & Cover, Co. is a member of the following industry organizations:**



National Safety Council



Power Transmission Distributors Association



Society of Plastic Engineers



Association of State Dam Safety Officials



Michigan West Coast Chamber of Commerce



United States Federal Contractor  
Registration Verified Vendor

All products manufactured by Machine Guard & Cover, Co. are made in the U.S.A.





**Machine Guard & Cover Co.**

6187 136<sup>th</sup> Avenue, Holland, MI 49424

888.482.7371 [www.machineguard.com](http://www.machineguard.com)

## Material Descriptions and Colors

Machine Guard & Cover, Co. forms and fabricates guards from several types of plastics.

ABS is the most common and most cost-effective material. ABS is a strong, tough and durable material that works well in most industrial applications. Black ABS plastic is recommended for outdoor applications due to superior UV resistance.



BL  
Black 3/16"



B8  
Black 1/8"



B4  
Black 1/4"



B3  
Black 3/8"

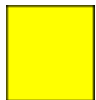

YE  
Yellow 3/16"



Y8  
Yellow 1/8"



Y4  
Yellow 1/4"



Y3  
Yellow 3/8"

Transparent PETG possesses great impact strength and chemical resistance competing with polycarbonate and is an FDA food and medical device contact approved material. PETG is sensitive to UV light and surface scratches easier than ABS.

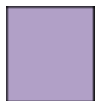

PT  
PETG 3/16"



P8  
PETG 1/8"



P4  
PETG 1/4"

KYDEX-T has a fire resistance rating in accordance with UL Std. 94 V-0, 5V and also has superior chemical resistance. This material is used in special applications where fire or electrical hazards must be addressed.



KX  
Kydex-T Black 3/16"



KX8  
Kydex-T Black 1/8"



KX4  
Kydex-T Black 1/4"



KXY  
Kydex-T Yellow 3/16"



KXY4  
Kydex-T Yellow 1/4"

Metal detectable blue ABS plastic is an option for the lightweight guard families and smaller guards. This material is an excellent alternative in the food and pharmaceutical industries where traditionally an all metal guard would be required. Following the current industry practice of using a highly visual material, guards in this material are available in blue only.





MD8  
Metal Detectable 1/8"

Other materials such as HDPE, Polycarbonate and other colors of ABS are available for special projects. For additional information, contact Machine Guard & Cover, Co. at 888.482.7371 or visit our website at [www.machineguard.com](http://www.machineguard.com).





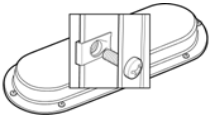

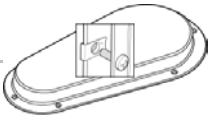
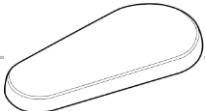

**Standard Guards**

❗ How to Size a Guard		9
Standard Flanged Guards		13
Standard Flanged Guards with Safety Captured Fasteners		16
❗ How to Assemble an Unflanged Guard		19
Standard Unflanged Guards		20

**Tapered Guards**







Tapered Flanged Guards		23
Tapered Flanged Guards with Safety Captured Fasteners		25
Tapered Unflanged Guards		27

**Rectangular Guards**

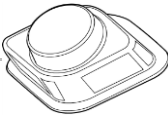

Rectangular Flanged Guards		29
Rectangular Flanged Guards with Safety Captured Fasteners		31
Rectangular Unflanged Guards		33

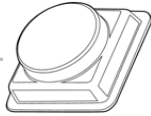
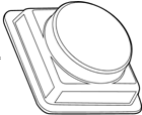

**Flange Bearing Covers**

❶ How to Size a Flange Bearing Cover		35
❶ How to Install a Flange Bearing Cover		37
2-Bolt Flange Bearing Covers - Heavyweight		38
2-Bolt Flange Bearing Covers - Lightweight		40
3-Bolt Flange Bearing Covers - Heavyweight		42
3-Bolt Flange Bearing Covers - Lightweight		43
4-Bolt Flange Bearing Covers - Heavyweight		44
4-Bolt Flange Bearing Covers - Lightweight		45
3-Bolt Flange Bracket Bearing Covers		46
4-Bolt Flange Bracket Bearing Covers		46

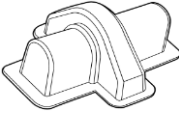
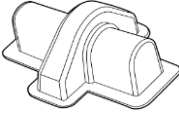
**Pillow Block Bearing Covers**



❶ How to Size a Pillow Block Bearing Cover		47
Pillow Block Bearing Covers - Heavyweight		49
Pillow Block Bearing Covers - Lightweight		50
Plummer Pillow Block Bearing Covers		51
Skabbard™ Pillow Block Bearing Covers		52



Take-Up Bearing Covers

Take-Up Bearing Covers		53
------------------------	---	----

Shaft Covers

① How to Size a Horizontal Shaft Cover		54
① How to Size a Vertical Shaft Cover		55
Bearing Shaft Covers		56
Flanged Shaft Covers - Heavyweight		57
Flanged Shaft Covers - Lightweight		58
Double Flanged Shaft Covers - Heavyweight		59
Double Flanged Shaft Covers - Lightweight		60

Round Flanged Covers



Round Flanged Covers - Heavyweight		61
Round Flanged Covers - Lightweight		63
Split Round Covers		64
Split Round Covers, Clamping		66

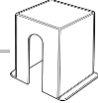

Coupling Covers

① How to Size a Coupling Cover		67
1-Piece Coupling Covers		68
Coupling Cover Fabricated Boxes		69

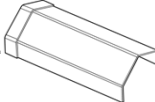
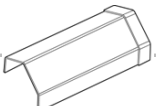
Conveyor Covers

Conveyor Covers, Heavyweight - Straight		70
Conveyor Covers, Lightweight - Straight		71
Conveyor Covers, Heavyweight - Curved		72
Conveyor Covers, Lightweight - Curved		73





**Machine Guard & Cover Co.**

*We've Got You Covered!*

# Belt Guard Request Sheet

Supply information in the 4 circles provided:

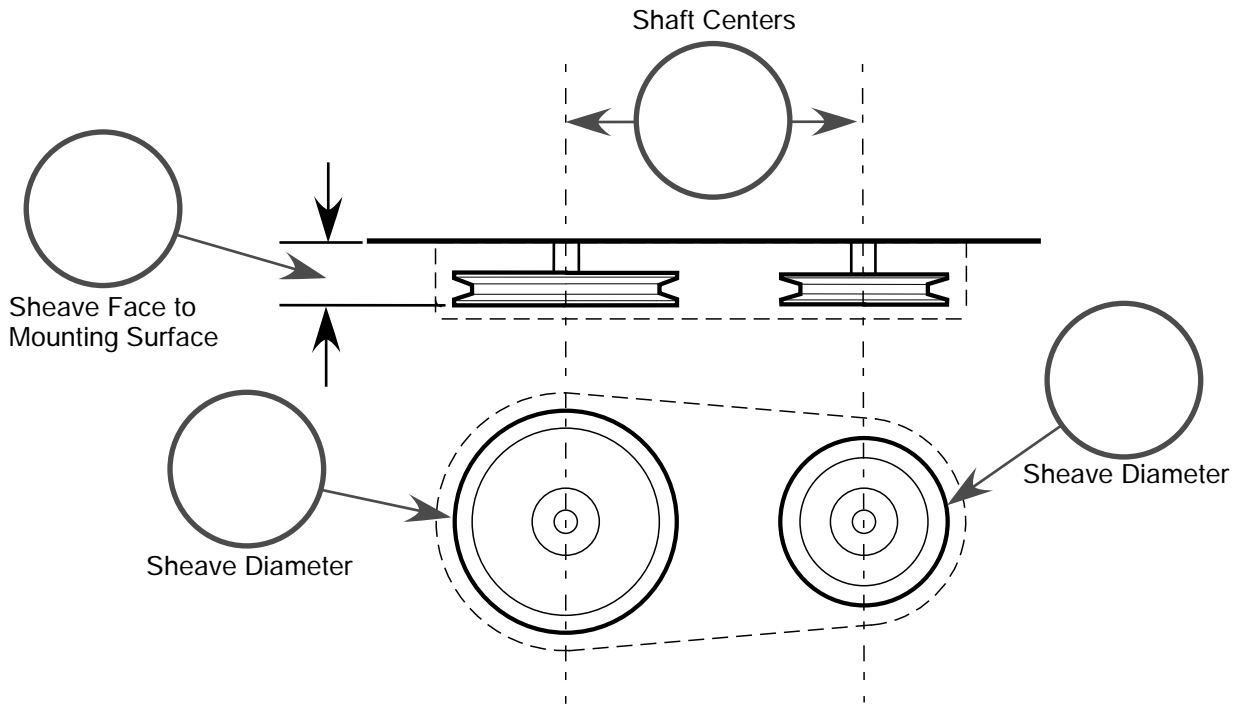

*Use Request Sheet 2 for more shaft detail if needed*

Other Features:

Company: \_\_\_\_\_ Contact e-mail: \_\_\_\_\_

Name: \_\_\_\_\_ Contact phone: \_\_\_\_\_

*e-mail or FAX this sheet to:*

www.machineguard.com  
office@machineguard.com  
Fax: 877-482-7313



**Machine Guard & Cover Co.**

6187 136th Avenue  
Holland, MI 49424  
888 - 482-7371



# Belt Guard Request Sheet 2

Supply information in the 6 circles as required:

Shaft variations: check one

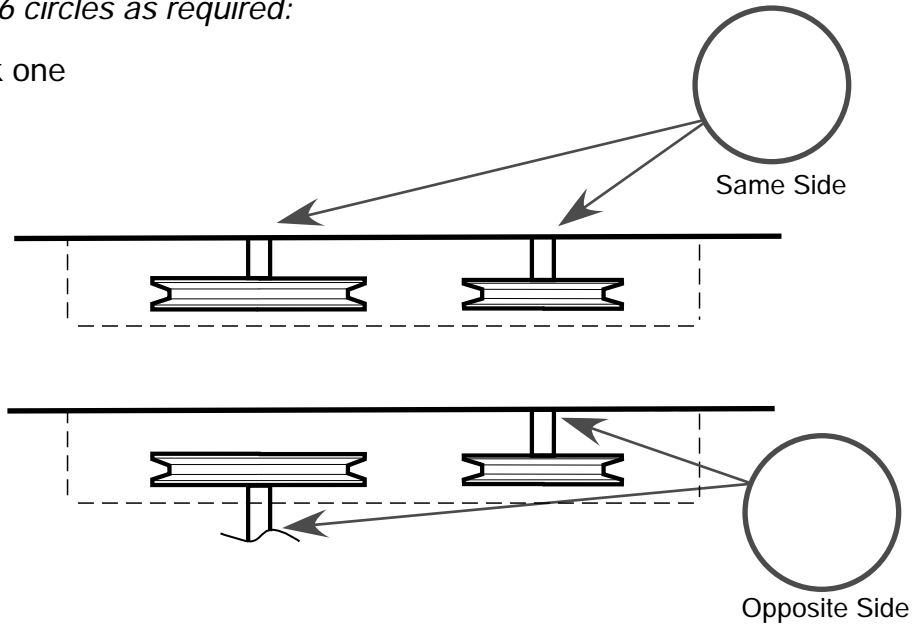

Hub variations:

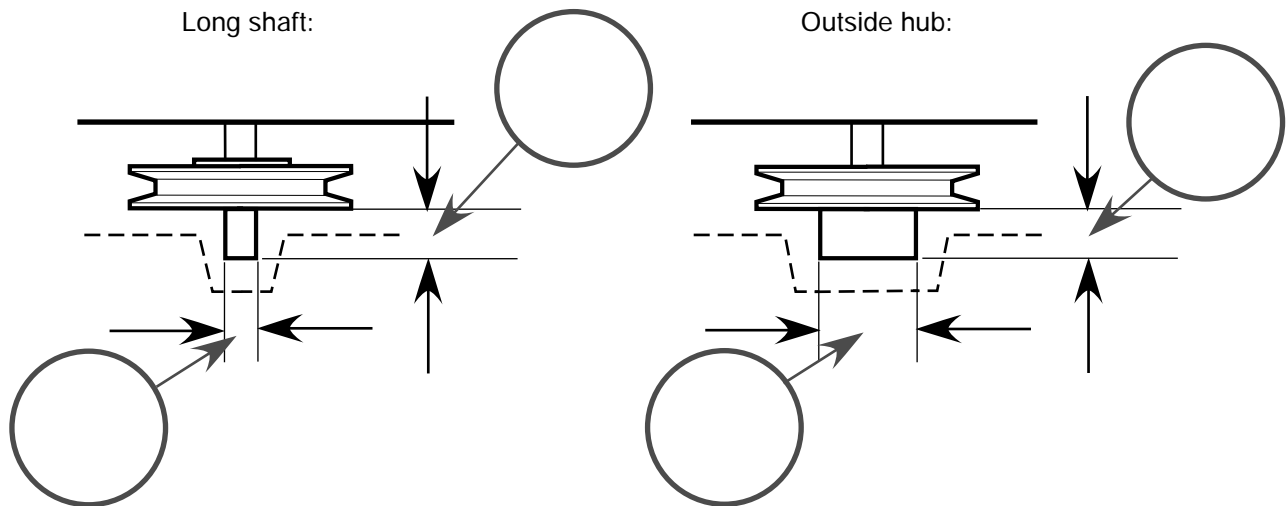



**Machine Guard & Cover Co.**

*We've Got You Covered!*

# Industrial Chain Guard Request Sheet

Supply information in the 5 circles provided:

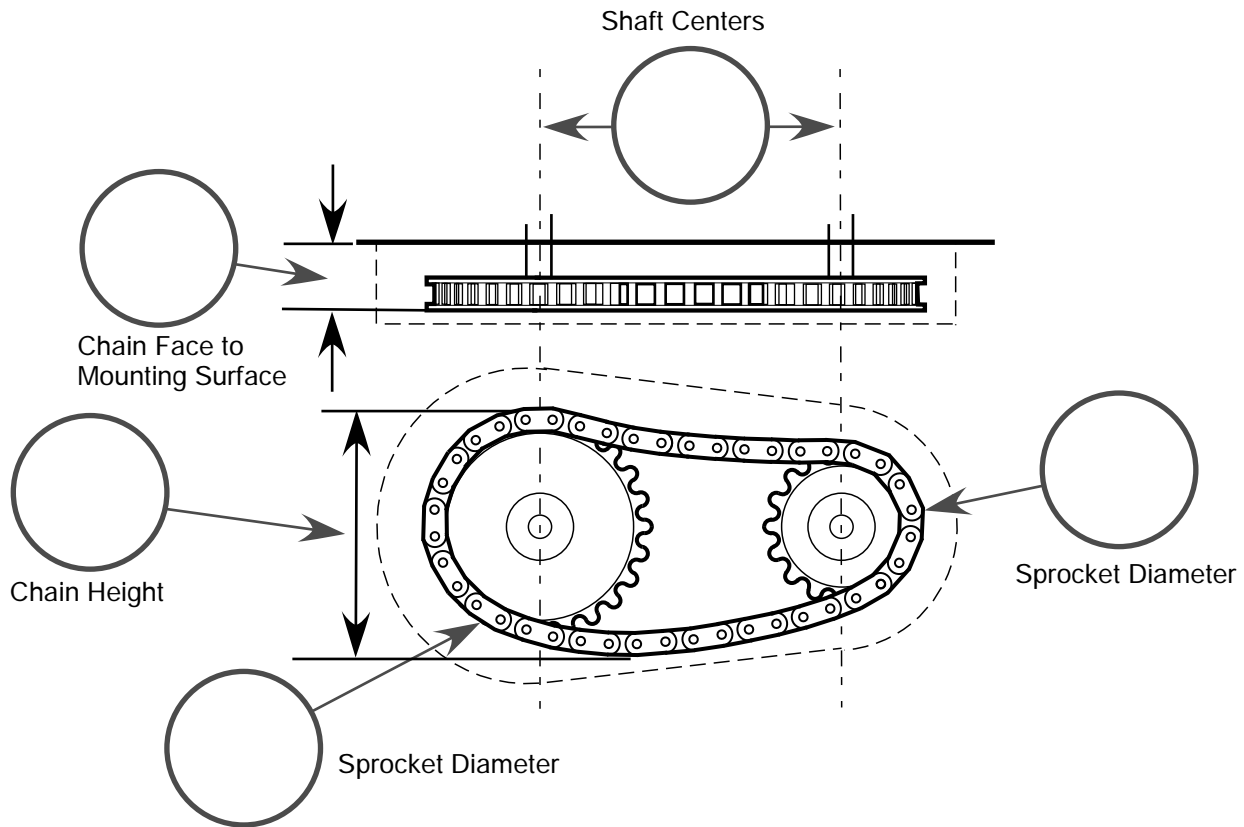

*Use Request Sheet 2 for more shaft detail if needed*

Other Features:

Company: \_\_\_\_\_ Contact e-mail: \_\_\_\_\_

Name: \_\_\_\_\_ Contact phone: \_\_\_\_\_

e-mail or FAX this sheet to:

www.machineguard.com  
office@machineguard.com  
Fax: 877-482-7313



**Machine Guard & Cover Co.**  
6187 136th Avenue  
Holland, MI 49424  
888 - 482-7371



**Machine Guard & Cover Co.**

*We've Got You Covered!*

# Industrial Chain Guard Request Sheet 2

Supply information in the 6 circles as required:

Shaft variations: check one

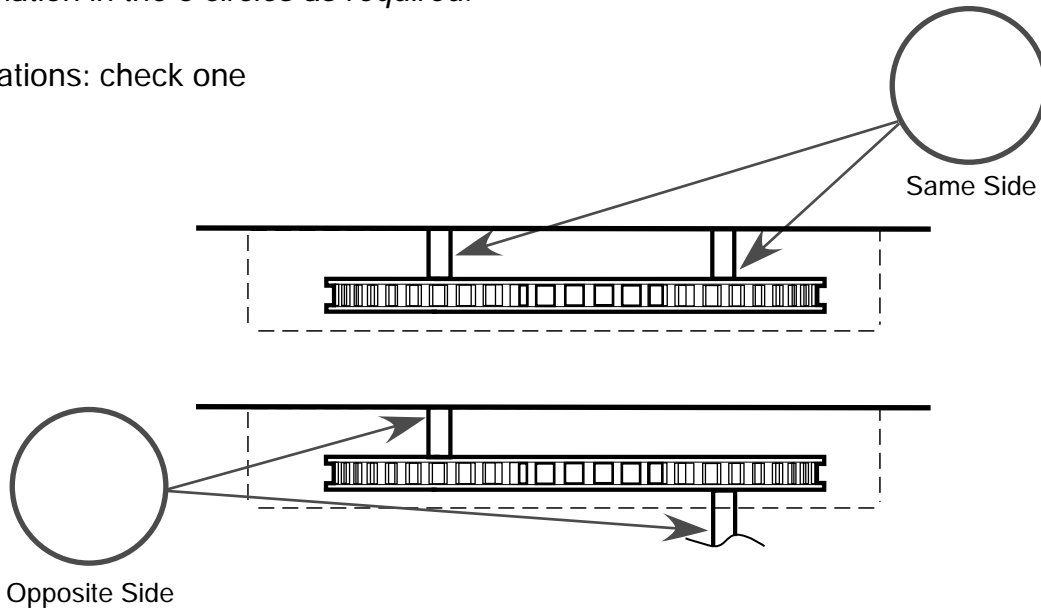

Hub variations: supply dimensions as needed:

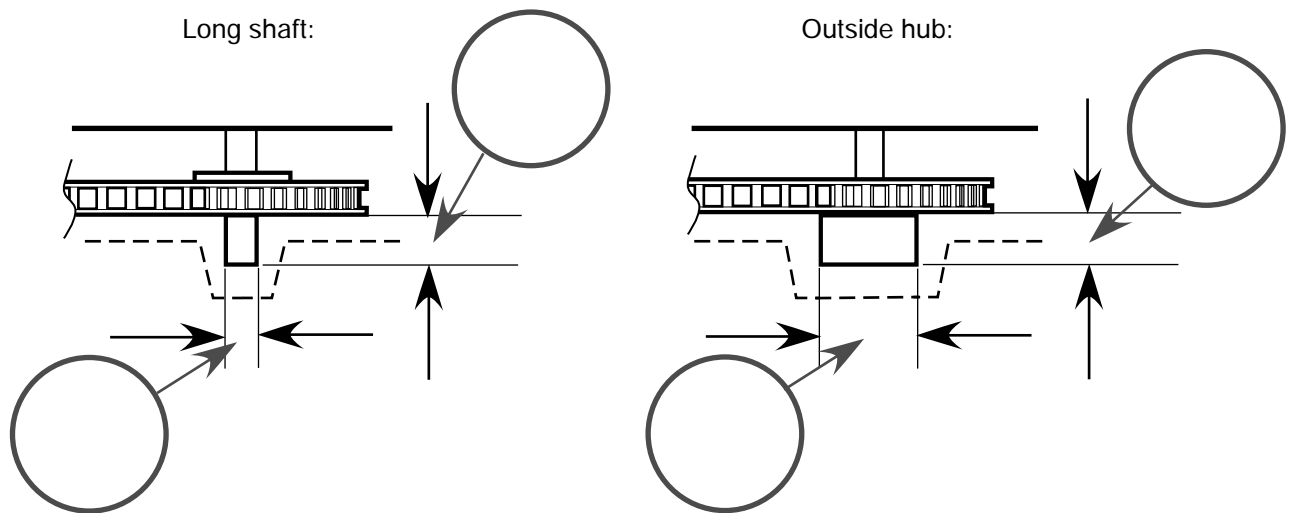

www.machineguard.com  
office@machineguard.com  
Fax: 877-482-7313



**Machine Guard & Cover Co.**

6187 136th Avenue  
Holland, MI 49424  
888 - 482-7371



Standard Flanged Guards

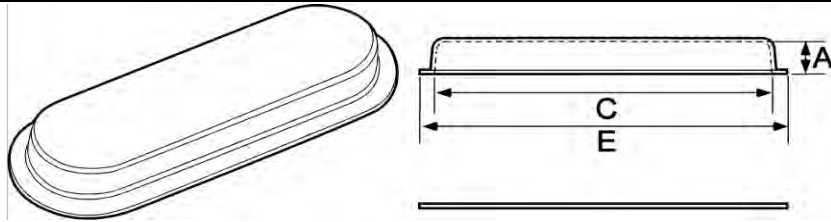

All dimensions measured in inches

Part Number	Height "A"	Width "B"	Length "C"	Center "E"	
G1.52.506	1 1/2	2 1/4	6 3/8	4 1/8	
G1.52.510.5	1 1/2	2 1/4	10 1/4	8	
G1.52.59.5	1 1/2	2 1/4	9 1/2	7 1/4	
G1.53.511	1 9/16	3 7/16	11 3/16	7 3/4	
G1.72.27.5	1 5/8	2 1/4	7 5/8	5 3/8	
G1.72.504	1 3/4	2 3/8	4	1 5/8	
G1.750510	1 3/4	5 1/8	10 1/8	5	
G1.750611	1 3/4	5 7/8	10 7/8	5	
G1.802.58.2	1 3/4	2 1/2	8 1/4	5 3/4	
G20220	2	2 1/4	20 1/8	17 7/8	
G203.506.5	2	3 1/2	6 1/2	3	
G20311	2	3 1/16	10 7/8	7 13/16	
G20414	2	4 1/8	13 5/8	9 1/2	
G20416	2	4 1/4	15 5/8	11 3/8	
G20418	2	4 1/8	17 1/2	13 3/8	
G20420	2	4 1/8	19 5/8	15 1/2	
G20422	2	4 1/8	21 5/8	17 1/2	
G20426	2	3 7/8	25 7/8	22	
G20618	2	5 5/8	17 1/2	11 7/8	
G20620	2	5 3/4	19 3/4	14	
G20622	2	5 3/4	21 3/4	16	
G20624	2	5 7/8	23 3/4	17 7/8	
G20626	2	5 5/8	25 1/2	19 7/8	
G20629	2	5 3/4	28 3/4	23	
G20633	2	5 7/8	33 1/4	27 3/8	
G2.103.110	2 1/8	3 1/8	10	6 7/8	
G2.20508.2	2 1/4	5	8 1/4	3 1/4	
G2.303.215	2 3/8	3 1/8	15 1/8	12	
G2.50417.5	2 1/2	4 3/8	17 1/2	13 1/8	
G2.50509	2 1/2	4 7/8	9	4 1/8	
G2.50516	2 1/2	4 5/8	15 3/4	11 1/8	
G2.50612	2 1/2	5 5/8	11 5/8	6	
G2.50615	2 1/2	5 3/4	14 3/4	9	
G2.50620	2 1/2	5 3/4	19 3/4	14	
G2.50625	2 1/2	5 7/8	25	19 1/8	
G2.50825	2 1/2	7 3/4	25	17 1/4	
G2.53.509	2 1/2	3 1/2	9	5 1/2	
G304.212	3	4 1/4	11 7/8	7 5/8	
G30429	3	4	29	25	
G30510	3	5	10 1/8	5 1/8	
G30517	3	5 3/8	17 5/16	11 15/16	
G30518	3	4 3/4	17 3/4	13	
G30519	3	5 3/8	19 3/8	14	
G30522	3	5 7/16	22 3/8	16 15/16	

Standard Flanged Backplates

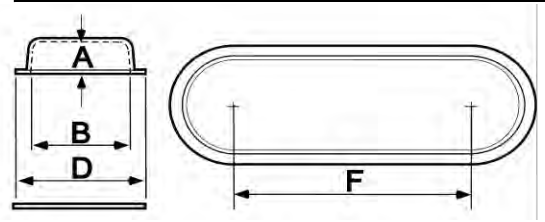

Backplate Part Number	Width "D"	Length "E"	
B3.5x7c	4	8 1/8	
B3.5x11.5c	3 7/8	12	
B3.5x10.5c	4 1/4	11 1/8	
B4.5x12c	5	12 3/4	
B3.2x8.5c	3 3/4	9 1/8	
B3.5x5d	4 1/8	5 5/8	
B6x11d	6 7/8	12	
B7x12d	7 1/2	12 1/2	
B3.5x9.2d	4	10	
B3x21d	4	22	
B4.5x7.5d	5	8	
B4x12d	4 3/4	12 1/2	
B5x15d	5 7/8	15 1/2	
B5x17d	6	17 1/2	
B5x19d	5 7/8	19 1/2	
B5x21d	5 7/8	21 3/8	
B5x23d	7 3/8	23 3/8	
B5x27d	5 1/2	27 5/8	
B7x19d	7 3/8	19 3/8	
B7x21d	7 1/2	21 1/2	
B7x23d	7 1/2	23 5/8	
B7x25d	7 1/2	25 5/8	
B7x27d	7 3/8	27 3/8	
B7x30d	7 1/2	30 5/8	
B7x34d	7 5/8	35 1/8	
B4.1x11d	4 7/8	11 3/4	
B6x9.2d	7	10 1/4	
B4.2x16d	5 1/8	17 1/8	
B5x18.5e	6 5/8	19 7/8	
B6x10e	6 3/4	10 7/8	
B6x17e	6 1/2	17 5/8	
B7x13e	7 1/2	13 1/2	
B7x16e	7 1/2	16 1/2	
B7x21e	7 1/2	21 5/8	
B7x26e	7 3/4	26 1/2	
B9x26e	9 5/8	27	
B4.5x10e	3 3/4	9 1/4	
B5.2x13f	6 1/8	13 3/4	
B5x30f	5 3/4	30 3/4	
B6x11f	7	12	
B6x18f	7 1/8	19	
B6x19f	6 3/4	19 3/4	
B6x20f	7 1/8	21 1/8	
B6x23f	7 1/8	24 1/8	



Standard Flanged Guards

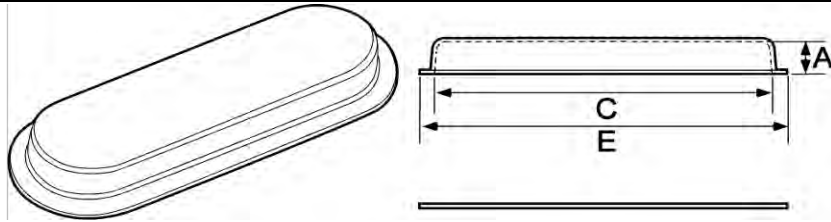

All dimensions measured in inches

Part Number	Height "A"	Width "B"	Length "C"	Center "E"
G30525	3	5 11/16	25 3/16	19 1/2
G30523.5	3	5 1/4	23	17 3/4
G30526	3	5 3/8	26 3/8	21
G30622	3	5 5/8	21 5/8	16
G30625	3	5 5/8	24 3/4	19 1/8
G30717	3	6 3/4	16 3/4	10
G30721	3	7 1/4	20 3/4	13 1/2
G30818	3	8	18	10
G30823	3	8 1/8	23 1/4	15 1/8
G31024	3	9 7/8	24 1/8	14 1/4
G31034	3	9 7/8	34 1/4	24 3/8
G31227	3	11 3/4	27 3/8	15 5/8
G31237	3	11 3/4	37	25 1/4
G3.50419	3 1/2	3 3/4	18 7/8	15 1/8
G3.50618.5	3 1/2	6 1/4	18 1/2	12 1/4
G3.50712	3 1/2	6 7/8	11 7/8	5
G3.50715	3 1/2	6 3/4	14 7/8	8 1/8
G3.50718	3 1/2	6 3/4	18	11 1/4
G3.50721	3 1/2	6 3/4	21	14 1/4
G3.50724	3 1/2	6 3/4	24 1/8	17 3/8
G3.50725	3 1/2	6 3/4	24 3/4	18
G3.50727	3 1/2	6 3/4	27 1/8	20 3/8
G3.50730	3 1/2	6 3/4	30 1/8	23 3/8
G3.50732	3 1/2	6 3/4	32 1/8	25 3/8
G3.50736	3 1/2	6 3/4	36 1/8	29 3/8
G3.50740	3 1/2	7	40 1/8	33 1/8
G3.51027	3 1/2	9 3/4	27 1/8	17 3/8
G40616	4	6	16	10
G40619	4	5 3/8	19	13 5/8
G408.520.5	4	8 1/2	20 1/2	12
G408.528.5	4	8 1/2	28 1/2	20
G408.531	4	8 1/2	31	22 1/2
G40925	4	8 1/2	24 5/8	16 1/8
G40722	4 1/4	7 1/8	22 1/4	15 1/8
G4.50922	4 1/2	9	22	13
G4.50933	4 1/2	9 1/8	33 5/8	24 1/2
G51325	5	13	25	12
G51341	5	13	41	28
G5.51222	5 1/2	12	22	10
G5.51630	5 1/2	15 7/8	29 7/8	14
G61015	6	10	15	5
G61025	6	10	25	15
G61242	6	12	42	30
G61530	6	15	30	15

Standard Flanged Backplates

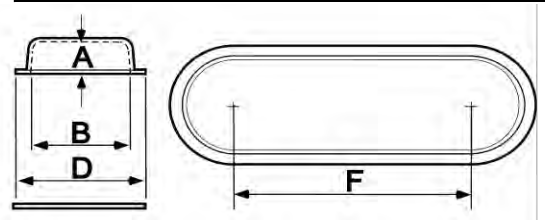

Backplate Part Number	Width "D"	Length "E"
B6x26f	7 7/16	26 15/16
B6x24.5f	7	24 3/4
B6x27f	7 1/8	28 1/8
B7x23f	7 1/2	23 1/2
B7x26f	7 1/2	26 5/8
B8x18f	8 5/8	18 1/2
B8x22f	9	22 1/2
B9x19f	10	20
B9x24f	9 7/8	25
B11x25f	11 3/4	26
B11x35f	11 3/4	36 1/8
*B13x28f	12	27 1/2
*B13x38f	13 5/8	39
B5x20g	5 5/8	20 7/8
B7x19.5g	8 1/4	20 1/2
B8x13g	8 3/4	13 3/4
B8x16g	8 3/4	16 7/8
B8x19g	8 3/4	19 7/8
B8x22g	8 3/4	23
B8x25g	8 3/4	26
B8x26g	8 5/8	26 3/4
B8x28g	8 5/8	29
B8x31g	8 3/4	34 1/8
B8x33g	8 3/4	34 1/8
B8x37g	8 3/4	38 1/4
B8x41g	9	42
B11x28g	11 3/4	29 1/8
B7x17g	8 1/2	18 1/2
B7x20h	7 1/2	21 1/8
B9.5x21.5h	11	22 1/4
B9.5x29.5h	11	30 1/4
B9.5x32h	11	32 1/2
B10x26h	11	27
B8x23h	9 1/8	24 1/4
B10x23i	11	24
B10x34i	11 1/4	35 5/8
*B14x26j	15	27
*B14x42j	15 1/2	43 1/2
*B13x23k	14 1/4	24 1/4
*B17x31k	17 3/4	32 1/8
B11x16l	11	16
B11x26l	11	26
*B13x43l	14 1/4	44 1/4
*B16x31l	18 1/4	33 1/4



**Standard Flanged Guards**

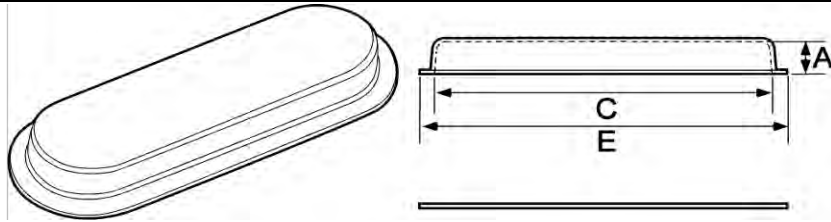

All dimensions measured in inches

Part Number	Height "A"	Width "B"	Length "C"	Center "F"
G61542	6	15	42	27
G61554	6	15	54	39
G61566	6	15	66	51
G61649	6	16	49	33
G61935	6	19 1/8	35 1/4	16 1/8
G61949	6	19	49	30
G62442	6	24	42	18
G6.52263.5	6 1/2	22	63 1/2	41 1/2
G70715	7	7	15	8
G92048	9	20	48	28
G10.51450	10 1/2	14	50	36
G121946	12	19	46	27

**Standard Flanged Backplates**

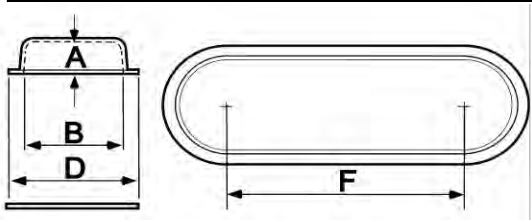

Backplate Part Number	Width "D"	Length "E"
*B16x43l	18 1/4	45 1/4
*B16x55l	18 1/4	57 1/4
*B16x67l	18 1/4	69 1/4
*B17x50l	19	52
*B20x36l	21 3/8	37 3/4
*B20x50l	22	52
*B25x43l	27 1/2	45 1/2
*B23x64.5m	24	65
B8x16n	9 1/2	17 1/2
*B21x49r	21	49
*B15x51u	16 3/4	52 3/4
*B20x47x	22 5/8	49 5/8

Guards are measured from the SMALLEST INTERIOR POINT unless specified.

- Standard Flanged Guards (G) cover belt or chain drives with similar sized sheaves or sprockets.
  - The G backplate covers the back of the guard, which can be attached to guards through holes / brackets made through the flange. *NOTE: MGC normal manufacturing policy DOES NOT include cutting holes for shafts or make brackets for mounting. This can be done on special orders.*
  - If standard sized guards do not fit machinery, several guards may be re-sized to make a longer or shorter guard.
  - Height "A", Width "B" and Length "C" are measured at the smallest point on the inside of the guard.
  - Width "D" and Length "E" refer both to the dimensions of the guard measured at the flange and to the dimensions of the matching backplate.
  - Additional sizes are available, contact us for additional information.
- \*In order to provide additional strength, these backplates are made from 3/16" material. When made of black or yellow ABS, backplates are normally 1/8".
- Many of the guards in this series are available in lightweight material. Contact us for details.

**Available Materials:**

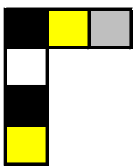

- 3/16" ABS
- 3/16" transparent PETG
- 1/4" ABS
- 1/4" Kydex

**Available Options:**

- Gaskets
- Hinges
- Extruded Aluminum Framework
- Powder Coated Extruded Metal Mesh

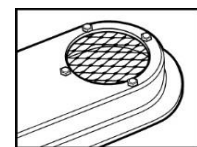



Standard Flanged Guards with Safety Captured Fasteners

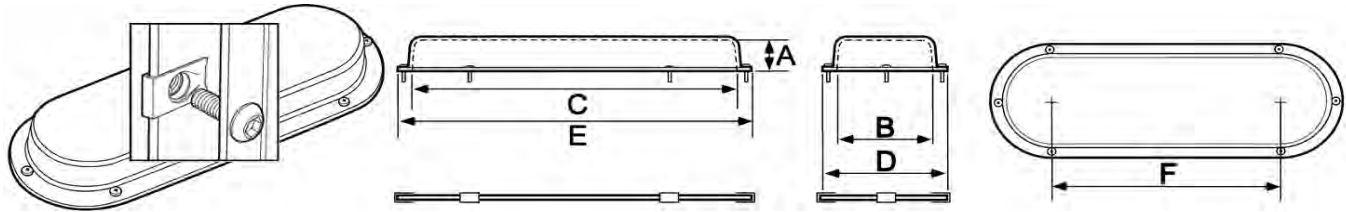

All dimensions measured in inches

Please note: Safety Captured Fastener hardware locations for illustration only.

Part Number	Height "A"	Width "B"	Length "C"	Center "F"	# of SCF
-------------	------------	-----------	------------	------------	----------

Backplate Part Number	Width "D"	Length "E"	
-----------------------	-----------	------------	--

G1.52.506SCF	1 1/2	2 1/4	6 3/8	4 1/8	4
G1.52.510.5SCF	1 1/2	2 1/4	10 1/4	8	4
G1.52.59.5SCF	1 1/2	2 1/4	9 1/2	7 1/4	4
G1.53.511SCF	1 9/16	3 7/16	11 3/16	7 11/16	4
G1.72.27.5SCF	1 5/8	2 1/4	7 5/8	5 3/8	4
G1.72.504SCF	1 3/4	2 3/8	4	1 1/2	4
G1.750510SCF	1 3/4	5 1/8	10 1/8	5 1/8	4
G1.750611SCF	1 3/4	5 7/8	10 7/8	5	4
G1.802.58.2SCF	1 3/4	2 1/2	8 1/4	5 7/8	4
G20220SCF	2	2 1/4	20 1/8	15 5/8	4
G203.506.5SCF	2	3 1/2	6 1/2	3	4
G20311SCF	2	3 1/16	10 7/8	7 13/16	4
G20414SCF	2	4 1/8	13 5/8	9 1/2	4
G20416SCF	2	4 1/4	15 5/8	11 1/4	4
G20418SCF	2	4 1/8	17 1/2	13 1/2	4
G20420SCF	2	4 1/8	19 5/8	15 1/2	4
G20422SCF	2	4 1/8	21 5/8	17 1/2	6
G20426SCF	2	3 7/8	25 7/8	22 1/8	6
G20618SCF	2	5 5/8	17 1/2	12	4
G20620SCF	2	5 3/4	19 3/4	14	4
G20622SCF	2	5 3/4	21 3/4	16 1/8	4
G20624SCF	2	5 7/8	23 3/4	18 1/8	6
G20626SCF	2	5 5/8	25 1/2	20	6
G20629SCF	2	5 3/4	28 3/4	23 1/8	6
G20633SCF	2	5 7/8	33 1/4	27 1/2	8
G2.103.110SCF	2 1/8	3 1/8	10	6 7/8	4
G2.20508.2SCF	2 1/4	5	8 1/4	3 1/4	4
G2.303.215SCF	2 3/8	3 1/8	15 1/8	12	4
G2.50417.5SCF	2 1/2	4 3/8	17 1/2	13 1/8	4
G2.50509SCF	2 1/2	4 7/8	9	4	4
G2.50516SCF	2 1/2	4 5/8	15 3/4	11 1/4	4
G2.50612SCF	2 1/2	5 5/8	11 5/8	6	4
G2.50615SCF	2 1/2	5 3/4	14 3/4	9	4
G2.50620SCF	2 1/2	5 3/4	19 3/4	14	6
G2.50625SCF	2 1/2	5 7/8	25	19 1/4	6
G2.50825SCF	2 1/2	7 3/4	25	17 1/4	6
G2.53.509SCF	2 1/2	3 1/2	9	5 1/2	6
G304.212SCF	3	4 1/4	11 7/8	7 5/8	4
G30429SCF	3	4	29	25	4
G30510SCF	3	5	10 1/8	5	4
G30517SCF	3	5 3/8	17 5/16	11 15/16	4
G30518SCF	3	4 3/4	17 3/4	13	4
G30519SCF	3	5 3/8	19 3/8	14	6
G30522SCF	3	5 7/16	22 3/8	16 15/16	6

B3.5x11.5cSCF	4	8 1/8	
B3.5x10.5cSCF	3 7/8	12	
B4.5x12cSCF	4 1/4	11 1/8	
B3.5x7cSCF	5	12 3/4	
B3.2x8.5cSCF	3 3/4	9 1/8	
B3.5x5dSCF	4 1/8	5 5/8	
B6x11dSCF	6 7/8	12	
B7x12dSCF	7 1/2	12 1/2	
B3.5x9.2dSCF	4	10	
B3x21dSCF	4	22	
B4.5x7.5dSCF	5	8	
B4x12dSCF	4 3/4	12 1/2	
B5x15dSCF	5 7/8	15 1/2	
B5x17dSCF	6	17 1/2	
B5x19dSCF	5 7/8	19 1/2	
B5x21dSCF	5 7/8	21 3/8	
B5x23dSCF	7 3/8	23 3/8	
B5x27dSCF	5 1/2	27 5/8	
B7x19dSCF	7 3/8	19 3/8	
B7x21dSCF	7 1/2	21 1/2	
B7x23dSCF	7 1/2	23 5/8	
B7x25dSCF	7 1/2	25 5/8	
B7x27dSCF	7 3/8	27 3/8	
B7x30dSCF	7 1/2	30 5/8	
B7x34dSCF	7 5/8	35 1/8	
B4.1x11dSCF	4 7/8	11 3/4	
B6x9.2dSCF	7	10 1/4	
B4.2x16dSCF	5 1/8	17 1/8	
B5x18.5eSCF	6 5/8	19 7/8	
B6x10eSCF	6 3/4	10 7/8	
B6x17eSCF	6 1/2	17 5/8	
B7x13eSCF	7 1/2	13 1/2	
B7x16eSCF	7 1/2	16 1/2	
B7x21eSCF	7 1/2	21 5/8	
B7x26eSCF	7 3/4	26 1/2	
B9x26eSCF	9 5/8	27	
B4.5x10eSCF	3 3/4	9 1/4	
B5.2x13fSCF	6 1/8	13 3/4	
B5x30fSCF	5 3/4	30 3/4	
B6x11fSCF	7	12	
B6x18fSCF	7 1/8	19	
B6x19fSCF	6 3/4	19 3/4	
B6x20fSCF	7 1/8	21 1/8	
B6x23fSCF	7 1/8	24 1/8	





Standard Flanged Guards with Safety Captured Fasteners

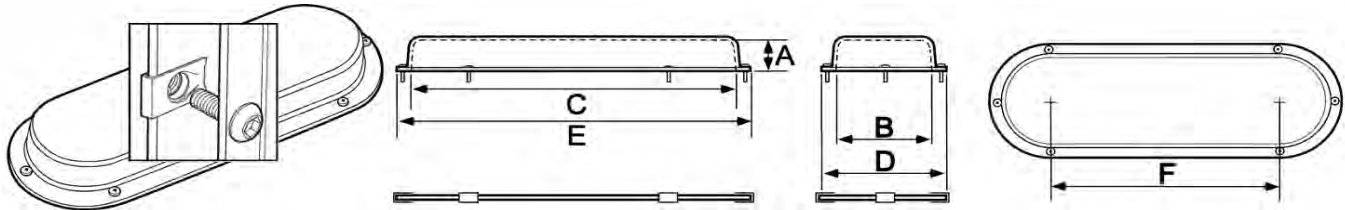

All dimensions measured in inches

Please note: Safety Captured Fastener hardware locations for illustration only.

Part Number	Height "A"	Width "B"	Length "C"	Center "F"	# of SCF
G30525SCF	3	5 11/16	25 3/16	19 1/2	6
G30523.5SCF	3	5 1/4	23	18 1/16	6
G30526SCF	3	5 3/8	26 3/8	21	6
G30622SCF	3	5 5/8	21 5/8	16	6
G30625SCF	3	5 5/8	24 3/4	19 1/8	6
G30717SCF	3	6 3/4	16 3/4	10	4
G30721SCF	3	7 1/4	20 3/4	13 1/2	6
G30818SCF	3	8	18	10	4
G30823SCF	3	8 1/8	23 1/4	15 1/8	6
G31024SCF	3	9 7/8	24 1/8	14 1/4	6
G31034SCF	3	9 7/8	34 1/4	24 1/4	8
G31227SCF	3	11 3/4	27 3/8	15 1/2	6
G31237SCF	3	11 3/4	37	25	8
G3.50419SCF	3 1/2	3 3/4	18 7/8	15 1/4	4
G3.50618.5SCF	3 1/2	6 1/4	18 1/2	12 1/4	6
G3.50712SCF	3 1/2	6 7/8	11 7/8	5	4
G3.50715SCF	3 1/2	6 3/4	14 7/8	8 1/8	4
G3.50718SCF	3 1/2	6 3/4	18	11 1/4	6
G3.50721SCF	3 1/2	6 3/4	21	14 1/4	6
G3.50724SCF	3 1/2	6 3/4	24 1/8	17 3/8	6
G3.50725SCF	3 1/2	6 3/4	24 3/4	18 1/8	6
G3.50727SCF	3 1/2	6 3/4	27 1/8	20 3/8	6
G3.50730SCF	3 1/2	6 3/4	30 1/8	23 1/2	6
G3.50732SCF	3 1/2	6 3/4	32 1/8	25 1/2	8
G3.50736SCF	3 1/2	6 3/4	36 1/8	29 1/2	8
G3.50740SCF	3 1/2	7	40 1/8	33	8
G3.51027SCF	3 1/2	9 3/4	27 1/8	17 3/8	6
G40616SCF	4	6	16	10	4
G40619SCF	4	5 3/8	19	13 5/8	6
G408.520.5SCF	4	8 1/2	20 1/2	12	6
G408.528.5SCF	4	8 1/2	28 1/2	20	6
G408.531SCF	4	8 1/2	31	22 1/2	6
G40925SCF	4	9	25	16	6
G40722SCF	4 1/4	7 1/8	22 1/4	15 1/8	6
G4.50922SCF	4 1/2	9	22	13	6
G4.50933SCF	4 1/2	9 1/8	33 5/8	24 3/8	8
G51325SCF	5	13	25	12	6
G51341SCF	5	13	41	28	8
G5.51222SCF	5 1/2	12	22	10	8
G5.51630SCF	5 1/2	15 7/8	29 7/8	14	8
G61015SCF	6	10	15	5	4
G61025SCF	6	10	25	15	6
G61242SCF	6	12	42	30	8
G61530SCF	6	15	30	15	8

Backplate Part Number	Width "D"	Length "E"	
B6x26fSCF	7 7/16	26 15/16	
B6x24.5fSCF	7	24 3/4	
B6x27fSCF	7 1/8	28 1/8	
B7x23fSCF	7 1/2	23 1/2	
B7x26fSCF	7 1/2	26 5/8	
B8x18fSCF	8 5/8	18 1/2	
B8x22fSCF	9	22 1/2	
B9x19fSCF	10	20	
B9x24fSCF	9 7/8	25	
B11x25fSCF	11 3/4	26	
B11x35fSCF	11 3/4	36 1/8	
B13x28fSCF	12	27 1/2	
*B13x38fSCF	13 5/8	39	
B5x20gSCF	5 5/8	20 7/8	
B7x19.5gSCF	8 1/4	20 1/2	
B8x13gSCF	8 3/4	13 3/4	
B8x16gSCF	8 3/4	16 7/8	
B8x19gSCF	8 3/4	19 7/8	
B8x22gSCF	8 3/4	23	
B8x25gSCF	8 3/4	26	
B8x26gSCF	8 5/8	26 3/4	
B8x28gSCF	8 5/8	29	
B8x31gSCF	8 3/4	34 1/8	
B8x33gSCF	8 3/4	34 1/8	
B8x37gSCF	8 3/4	38 1/4	
B8x41gSCF	9	42	
B11x28gSCF	11 3/4	29 1/8	
B7x17gSCF	8 1/2	18 1/2	
B7x20hSCF	7 1/2	21 1/8	
B9.5x21.5hSCF	11	22 1/4	
B9.5x29.5hSCF	11	30 1/4	
B9.5x32hSCF	11	32 1/2	
B10x26hSCF	11	27	
B8x23hSCF	9 1/8	24 1/4	
B10x23iSCF	11	24	
B10x34iSCF	11 1/4	35 5/8	
*B14x26jSCF	15 3/4	27 3/4	
*B14x42jSCF	16 1/4	44 1/4	
*B13x23kSCF	15	25	
*B17x31kSCF	18 1/2	32 7/8	
B7x26lSCF	11 7/8	16 7/8	
B7x26lSCF	11 7/8	26 7/8	
*B13x43lSCF	15	45	
*B16x31lSCF	19	34	



Standard Flanged Guards with Safety Captured Fasteners

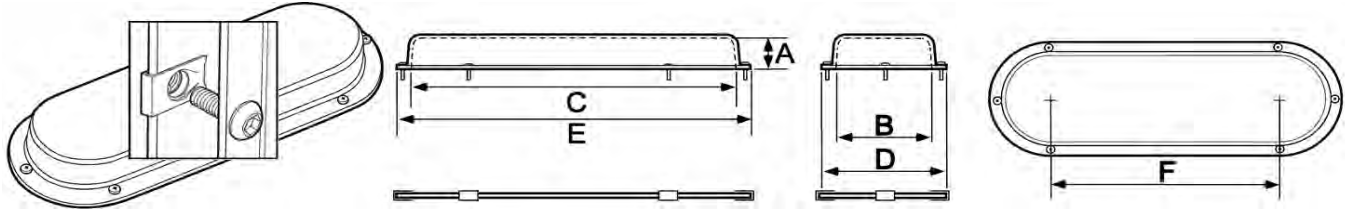

All dimensions measured in inches

Please note: Safety Captured Fastener hardware locations for illustration only.

Part Number	Height "A"	Width "B"	Length "C"	Center "F"	# of SCF
G61542SCF	6	15	42	27	8
G61554SCF	6	15	54	39	12
G61566SCF	6	15	66	51	14
G61649SCF	6	16	49	33	10
G61935SCF	6	19 1/8	35 1/4	16 1/8	10
G61949SCF	6	19	49	30	10
G62442SCF	6	24	42	18	10
G6.52263.5SCF	6 1/2	22	63 1/2	41 1/2	12
G70715SCF	7	7	15	8	4
G90248SCF	9	20	48	26	8
G10.51450SCF	10 1/2	14	50	36	10
G121946SCF	12	19	46	27	8

Backplate Part Number	Width "D"	Length "E"	
*B16x43ISCF	19	46	
*B16x55ISCF	19	58	
*B16x67ISCF	19	70	
*B17x50ISCF	19 3/4	52 3/4	
*B20x36ISCF	22 1/8	38 1/2	
*B20x50ISCF	22 3/4	52 3/4	
*B25x43ISCF	27 1/2	45 1/2	
*B23x64.5mSCF	24 3/4	65 3/4	
*B8x16nSCF	9 1/2	17 1/2	
*B21x49rSCF	21	49	
*B15x51uSCF	17 1/2	52 3/4	
*B20x47xSCF	22 5/8	49 5/8	

Guards are measured from the SMALLEST INTERIOR POINT unless specified.

Our Safety Captured Fastener program has been designed for the maximum convenience of maintenance personnel while at the same time conforming to the most rigid "hand tool needed for removal" interpretation of ANSI regulations (ANSI B11.19-2010 Section 7.2.6 Guards).

This system includes: holes drilled for the fasteners, u-nuts on the backplate, and button head socket cap screws attached to the guard. The button head socket cap screws are matched to the thickness of the guard and backplate for a snug fit, and must be turned with a 5/32" hex driver. They are permanently installed with push retainers so they cannot detach easily.

Standardized Safety Captured Fastener mounting locations for each part number have been established. Should your guard application require custom locations, please contact us to discuss options.

Available Materials:

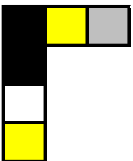

- 3/16" ABS
- 1/4" ABS
- 3/16" transparent PETG
- 1/4" Kydex

Available Options:

- Gaskets
- Hinges
- Extruded Aluminum Framework
- Powder Coated Extruded Metal Mesh

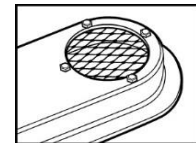



# Unflanged Guard Assembly Guide

1. Locate holes no less than 1/4" away from the edge of the backplate Tab.

Dimension "A" should be 7/16" for a 10-24 u-nut or 3/4" for a 1/4-20 u-nut.

Drill Clearance holes for machine screws.

3/16" for 10-24  
5/16" for 1/4-20

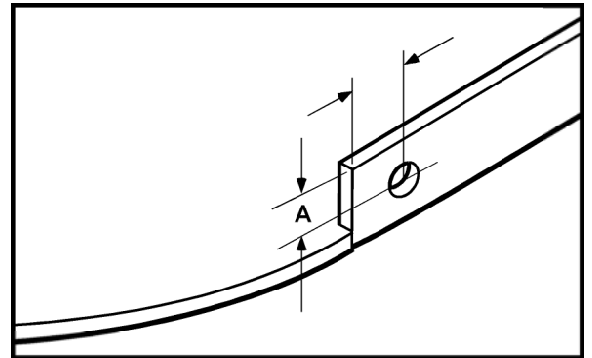

2. Make a reference mark on the edge of the backplate where the tab bends up.

Measure the distance from the back of the backplate to the center of the hole. This is needed to locate the corresponding mounting holes on the guard.

Slide the u-nut over the hole.

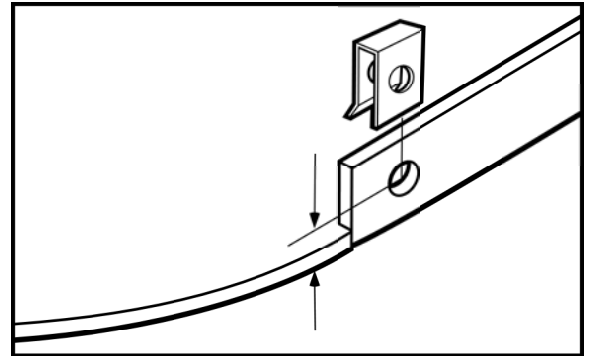

3. Place the backplate in the guard with tabs inward.

Using the marks and measurements from the previous steps, locate the screw holes for the guard.

Remove the backplate and drill the guard mounting holes using the same bit as in step one.

4. Locate and drill holes for shafts as needed.

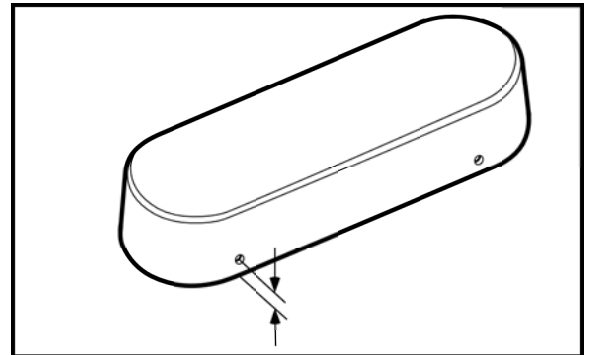



Standard Unflanged Guards

Standard Unflanged Backplates

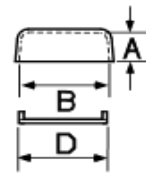
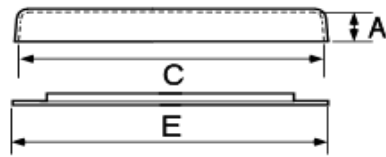
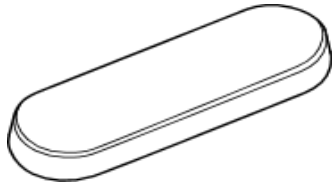

All dimensions measured in inches

Part Number	Height "A"	Width "B"	Length "C"	Center "F"
-------------	------------	-----------	------------	------------

UG102.506	1	2 1/4	6 3/8	4 1/8
UG102.510.5	1	2 1/4	10 1/4	8
UG102.59.5	1	2 1/4	9 1/2	7 1/4
UG1.22.27.5	1 1/8	2 1/4	7 5/8	5 3/8
UG1.22.504	1 1/4	2 3/8	4	1 1/2
UG1.250510	1 1/4	5 1/8	10 1/8	5 1/8
UG1.250611	1 1/4	5 7/8	10 7/8	5
UG1.302.58.2	1 1/4	2 1/2	8 1/4	5 7/8
UG1.50220	1 1/2	2 1/4	20 1/8	15 5/8
UG1.503.506.5	1 1/2	3 1/2	6 1/2	3
UG1.50311	1 1/2	3 1/16	10 7/8	7 13/16
UG1.50414	1 1/2	4 1/8	13 5/8	9 1/2
UG1.50416	1 1/2	4 1/4	15 5/8	11 1/4
UG1.50418	1 1/2	4 1/8	17 1/2	13 1/2
UG1.50420	1 1/2	4 1/8	19 5/8	15 1/2
UG1.50422	1 1/2	4 1/8	21 5/8	17 1/2
UG1.50426	1 1/2	3 7/8	25 7/8	22 1/8
UG1.50618	1 1/2	5 5/8	17 1/2	12
UG1.50620	1 1/2	5 3/4	19 3/4	14
UG1.50622	1 1/2	5 3/4	21 3/4	16 1/8
UG1.50624	1 1/2	5 7/8	23 3/4	18 1/8
UG1.50626	1 1/2	5 5/8	25 1/2	20
UG1.50629	1 1/2	5 3/4	28 3/4	23 1/8
UG1.50633	1 1/2	5 7/8	33 1/4	27 1/2
UG1.603.110	1 5/8	3 1/8	10	6 7/8
UG1.80408.2	1 3/4	5	8 1/4	3 1/4
UG1.903.215	1 7/8	3 1/8	15 1/8	12
UG203.509	2	3 1/2	9	5 1/2
UG20417.5	2	4 3/8	17 1/2	13 1/8
UG20509	2	4 7/8	9	4
UG20516	2	4 5/8	15 3/4	11 1/4
UG20612	2	5 5/8	11 5/8	6
UG20615	2	5 3/4	14 3/4	9
UG20620	2	5 3/4	19 3/4	14
UG20625	2	5 7/8	25	19 1/4
UG20825	2	7 3/4	25	17 1/4
UG2.50429	2 1/2	4	29	25
UG2.50510	2 1/2	5	10 1/8	5
UG2.50517	2 1/2	5 3/8	17 1/4	11 7/8
UG2.50518	2 1/2	4 3/4	17 3/4	13
UG2.50519	2 1/2	5 3/8	19 3/8	14
UG2.50522	2 1/2	5 7/16	22 3/8	17
UG2.50523.5	2 1/2	5 1/4	23	18

Backplate Part Number	Width "D"	Length "E"
-----------------------	-----------	------------

UB2.5x6b	2 3/8	6 1/2
UB2.5x10.5b	2 1/4	10 3/8
UB2.5x9.5b	2 5/8	9 1/2
UB2.2x7.5b	2 1/8	7 1/2
UB2.5x4c	2 1/2	3 7/8
UB5x10c	5 1/4	10 1/4
UB2.5x8.2c	5 7/8	10 7/8
UB3x8c	2 5/8	8 3/8
UB2x20c	4	22
UB3.5x6.5c	3 1/2	6 1/2
UB3x11c	3 1/4	11 1/8
UB4x14c	4 1/4	13 7/8
UB4x16c	4 3/8	15 7/8
UB4x18c	4 1/4	17 7/8
UB4x20c	4 1/4	19 3/4
UB4x22c	4 1/4	21 3/4
UB4x26c	3 7/8	26
UB6x18c	5 3/4	17 3/4
UB6x20c	5 7/8	19 7/8
UB6x22c	5 7/8	22
UB6x24c	5 7/8	24
UB6x26c	5 3/4	25 3/4
UB6x29c	5 7/8	29
UB6x33c	6	33 1/2
UB3.1x10c	3	9 7/8
UB4x8.2d	5	8 1/4
UB3.2x15d	3 1/8	15 1/8
UB3.5x9d	3 3/4	9 1/4
UB4x17.5d	4 1/4	17 3/8
UB5x9d	5 1/8	9 1/4
UB5x16d	4 7/8	16
UB6x12d	5 7/8	11 7/8
UB6x15d	5 7/8	15
UB6x20d	5 7/8	20
UB6x25d	6 1/8	25 3/8
UB8x25d	8	25 1/4
UB4x29e	4 1/8	29 1/8
UB5x10e	5 3/8	10 3/8
UB5x17e	5 3/4	17 3/4
UB5x18e	5	18 1/8
UB5x19e	5 1/2	19 1/2
UB5x22e	5 1/2	23 5/8
UB5x23.5e	5 1/4	23



Standard Unflanged Guards

Standard Unflanged Backplates

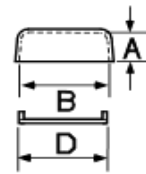
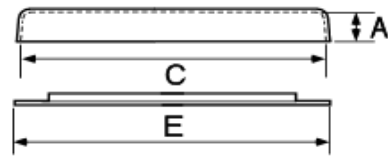
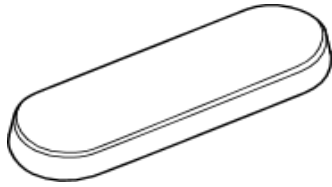

All dimensions measured in inches

Part Number	Height "A"	Width "B"	Length "C"	Center "F"
UG2.50525	2 1/2	5 11/16	25 3/16	19 1/2
UG2.50526	2 1/2	5 3/8	26 3/8	21
UG2.50622	2 1/2	5 5/8	21 5/8	16
UG2.50625	2 1/2	5 5/8	24 3/4	19 1/8
UG2.50717	2 1/2	6 3/4	16 3/4	10
UG2.50721	2 1/2	7 1/4	20 3/4	13 1/2
UG2.50818	2 1/2	8	18	10
UG2.50823	2 1/2	8 1/8	23 1/4	15 1/8
UG2.51024	2 1/2	9 7/8	24 1/8	14 1/4
UG2.51034	2 1/2	9 7/8	34 1/4	24 1/4
UG2.51227	2 1/2	11 3/4	27 3/8	15 1/2
UG2.51237	2 1/2	11 3/4	37	25
UG2.54.212	2 1/2	4 1/4	11 7/8	7 5/8
UG30419	3	3 3/4	18 7/8	15 1/4
UG30618.5	3	6 1/4	18 1/2	12 1/4
UG30712	3	6 7/8	11 7/8	5
UG30715	3	6 3/4	14 7/8	8 1/8
UG30718	3	6 3/4	18	11 1/4
UG30721	3	6 3/4	21	14 1/4
UG30724	3	6 3/4	24 1/8	17 1/8
UG30725	3	6 3/4	24 3/4	18 1/8
UG30727	3	6 3/4	27 1/8	20 3/8
UG30730	3	6 3/4	30 1/8	23 1/2
UG30732	3	6 3/4	32 1/8	25 1/2
UG30736	3	6 3/4	36 1/8	29 1/2
UG30740	3	7	40 1/8	33
UG31027	3	9 3/4	27 1/8	17 3/8
UG3.50616	3 1/2	6	16	10
UG3.50619	3 1/2	5 3/8	19	13 5/8
UG3.50722	3 1/2	7 1/8	22 1/4	15 1/8
UG3.508.531	3 1/2	8 1/2	31	22 1/2
UG3.50925	3 1/2	9	25	19
UG3.58.520.5	3 1/2	8 1/2	20 1/2	12
UG3.58.528.5	3 1/2	8 1/2	28 1/2	20
UG40922	4	9	22	13
UG40933	4	9 1/8	33 5/8	24 3/8
UG4.51325	4 1/2	13	25	12
UG4.51341	4 1/2	13	41	28
UG51222	5	12	22	10
UG51630	5	15 7/8	29 7/8	14
UG5.51015	5 1/2	10	15	5
UG5.51025	5 1/2	10	25	15
UG5.51242	5 1/2	12	42	30
UG5.51530	5 1/2	15	30	15

Backplate Part Number	Width "D"	Length "E"
UB5x25e	5 5/8	25 1/8
UB5x26e	5 1/2	26 1/2
UB6x22e	5 7/8	21 7/8
UB6x25e	5 7/8	25
UB7x17e	7	17
UB7x21e	7 3/8	21
UB8x18e	8	18
UB8x23e	8 1/2	23 1/2
UB10x24e	10 1/8	24 3/8
UB10x34e	10 1/8	34 1/2
*UB12x27e	12	27 1/2
*UB12x37e	12	37 1/2
UB4.2x12e	4 1/2	12 1/8
UB4x19f	4	19 1/4
UB6x18.5f	6 1/2	18 1/2
UB7x12f	7 1/8	12 1/8
UB7x15f	7 1/8	15 1/4
UB7x18f	7	18 1/4
UB7x21f	7 1/8	21 3/8
UB7x24f	7 1/8	24 3/8
UB7x25f	7	25 1/8
UB7x27f	7	27 3/8
UB7x30f	7	30 1/2
UB7x32f	7	32 1/2
UB7x36f	7 1/8	36 5/8
UB7x40f	7 3/8	40 3/8
UB10x27f	10 1/8	27 1/2
UB7x17g	8 1/2	18 1/2
UB6x19g	5 7/8	19 1/2
UB7x22g	7 1/2	22 5/8
UB8.5x31g	8 1/2	31
UB9x25g	9	25
UB8.5x20.5g	8 3/4	20 3/4
UB8.5x28.5g	8 3/4	20 3/4
UB9x22h	9 5/8	22 3/8
UB9x33h	9 5/8	34
*UB13x25i	13	25
*UB13x41i	13	41
*UB12x22j	12 3/4	22 3/4
*UB16x30j	16 1/4	30 1/4
UB10x15k	10	15
UB10x15k	10	25
*UB12x42k	12	42
*UB15x30k	15	30



Standard Unflanged Guards

Standard Unflanged Backplates

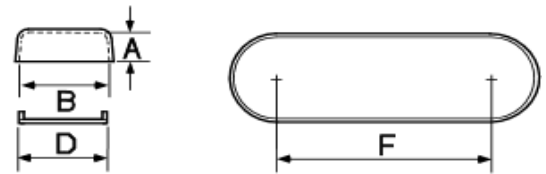
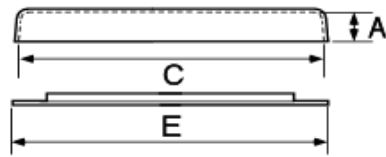
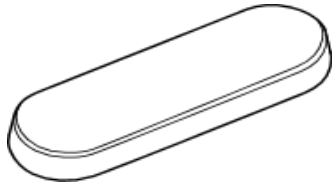

All dimensions measured in inches

Part Number	Height "A"	Width "B"	Length "C"	Center "F"	
UG5.51542	5 1/2	15	42	27	
UG5.51554	5 1/2	15	54	39	
UG5.51566	5 1/2	15	66	51	
UG5.51642	5 1/2	16	42	30	
UG5.51935	5 1/2	19 1/8	35 1/4	16 1/8	
UG5.51949	5 1/2	19	49	33	
UG5.52442	5 1/2	24	42	18	
UG62263.5	6	22	63 1/2	41 1/2	
UG6.50715	6 1/2	7	15	8	
UG8.52048	8 1/2	20	49	26	
UG101450	10	14	50	36	
UG11.51946	11 1/2	19	46	27	

Backplate Part Number	Width "D"	Length "E"	
*UB15x42k	15	42	
*UB15x54k	15	54	
*UB15x66k	15	66	
*UB16x42k	12 3/4	42 3/4	
*UB19x35k	19 7/8	36 1/4	
*UB19x49k	19	52	
*UB24x42k	24	42	
*UB22x63.5k	22	64	
UB7x15m	8	16	
*UB20x48q	20	48	
*UB14x50t	14	50	
*UB19x47k	19	47	

Guards are measured from the SMALLEST INTERIOR POINT unless specified.

- Standard Unflanged Guards (UG) cover belt or chain drives with similar sized sheaves or sprockets.
  - The UG backplate covers the back of the guard, which can be attached to guards through holes / brackets made through the flange. *NOTE: MGC normal manufacturing policy DOES NOT include cutting holes for shafts or make brackets for mounting. This can be done on special orders.*
  - If standard sized guards do not fit machinery, several guards may be re-sized to make a longer or shorter guard.
  - Height "A", Width "B" and Length "C" are measured at the smallest point on the inside of the guard.
  - Width "D" and Length "E" refer both to the dimensions of the guard measured at the widest point and to the dimensions of the matching backplate.
  - Additional sizes are available, contact us for additional information.
- \*In order to provide additional strength, these backplates are made from 3/16" material. When made of black or yellow ABS, backplates are normally 1/8".
- Many of the guards in this series are available in lightweight material. Contact us for details.

Available Materials:

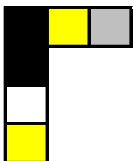

- 3/16" ABS
- 1/4" ABS
- 3/16" transparent PETG
- 1/4" Kydex

Available Options:

- Extruded Aluminum Framework
- Powder Coated Extruded Metal Mesh

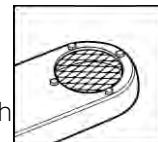



Tapered Flanged Guards

Tapered Flanged Backplates

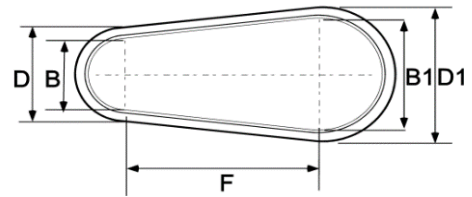
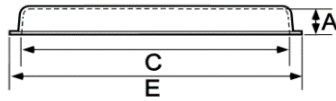
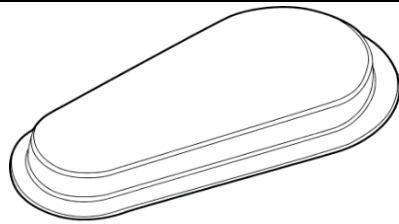

All dimensions measured in inches

Part Number	Height "A"	Small Dia "B"	Large Dia "B1"	Length "C"	Center "F"
-------------	------------	---------------	----------------	------------	------------

Backplate Part Number	Small Dia "D"	Large Dia "D1"	Length "E"
-----------------------	---------------	----------------	------------

TG1.70717.5	1 3/4	4 1/4	7 1/8	17 5/8	12
TG20406	2	1 3/8	3 3/8	5 1/2	3 1/8
TG25.59.5	2	3 3/4	5 1/2	9 1/4	4 5/8
TG2.50513	2 1/2	3 5/8	4 1/2	13	8 3/4
TG2.53.58.5	2 1/2	1 1/2	3 1/4	8 1/4	5 7/8
TG2.81128	2 3/4	8 1/2	11	28 3/4	18 1/2
TG30412	3	3 5/8	4 1/8	11 3/4	7 7/8
TG30512	3	4	5	12 1/4	7 7/8
TG30514	3	2 7/8	4 7/8	14	10 1/8
TG30515	3	3 7/8	4 5/8	15	10 7/8
TG30714	3	3 3/4	6 1/2	13 3/4	8 3/4
TG30715	3	4	7	15	9 1/2
TG30720	3	5	6 3/4	19 1/4	13 3/4
TG30812	3	4	8	12	6
TG31120	3	7	11 1/8	20	11 1/8
TG31126	3	8 3/8	10 7/8	25 1/2	16
TG31428	3	7 1/4	14	28 5/8	18
TG32340	3	7	23	40	25
TG3.20836.5	3 1/4	5 3/4	8	36 1/2	29 1/2
TG3.20514	3 3/8	3	5	14 3/8	10 3/8
TG3.50819	3 1/2	5	8 1/8	19 1/8	12 5/8
TG3.50823	3 1/2	4 5/8	7 7/8	22 1/8	16
TG3.51025	3 1/2	6 1/4	9 3/8	24 1/2	16 7/8
TG3.51424	3 1/2	6	14	24	14
TG3.51642	3 1/2	9	16	41 1/4	29 1/2
TG3.51828	3 1/2	10 3/4	18	27 7/8	13 1/2
TG40829	4	5 3/4	8 1/4	28 7/8	21 3/4
TG41015.7	4	6 1/2	10	15 3/4	7 1/2
TG41326	4	10	13 1/4	26 1/2	14 1/2
TG41430	4	10	13 3/8	28 7/8	17
TG41621	4	6	16 1/4	20 3/8	9 5/8
TG41630	4	8	16	30	18
TG41633	4	8	16	33	21
TG41638	4	8	16	38	26
TG41645.5	4	9	16	45 1/2	33
TG41727	4	9 1/8	16 1/2	26 5/8	13 13/16
TG41733	4	12 1/2	16 1/2	33	17 5/8
TG4.51025	4 1/2	6 1/4	9 3/8	24 1/2	16 7/8
TG4.50854	4 1/2	7 1/8	8	54	45 3/8
TG4.51143	4 1/2	8 1/4	11	42 1/4	32 3/4
TG4.51235	4 1/2	6 1/4	11 1/2	33 1/2	26 5/8
TG4.51642	4 1/2	8 3/4	15 3/4	41 3/4	29
TG4.52855	4 1/2	14	28	55	34
TG51020	5	7	10	20 1/8	11 3/4

TB9x19.5d	6	9	19 3/8
TB6x8d	3 1/8	5 1/4	7 1/4
TB7.5x11.5d	5 1/2	7 1/4	11 1/2
TB7x15e	5 1/2	6 3/8	14 3/4
TB5.5x10.5e	3 7/20	5 1/2	10 1/2
TB13x30f	10 1/2	13	30
TB6x14f	5 1/2	6 1/8	13 3/4
TB7x14f	6	6 7/8	14 1/4
TB7x16f	5 1/2	7 1/3	15 7/8
TB7x17f	5 3/4	6 1/2	17
TB9x16f	5 5/8	8 3/8	15 3/4
TB9x17f	6	9	17
TB9x22f	7	8 3/4	21 1/2
TB10x14f	6	10	14
TB13x22f	8 7/8	13	22
TB13x28f	10 1/4	12 3/4	27 1/2
*TB16x30f	9	15 3/4	30 1/2
*TB25x42f	8 7/8	24 7/8	41 7/8
TB10x38.5g	7 5/8	9 7/8	38 3/8
TB7x16g	4 3/4	6 3/4	16 1/8
TB10x21g	7	10 1/8	21 1/4
TB10x25g	6 1/2	9 3/4	24 1/4
TB12x27g	8 1/8	11 1/4	26 1/2
TB16x26g	8	16	26
*TB18x44g	11	18	44
*TB20x30g	12 1/2	19 3/4	29 5/8
TB10x31h	7 3/4	10 1/4	30 7/8
TB12x18h	8 1/2	12	17 3/4
*TB15x28h	11 3/4	14 3/4	26 5/8
*TB16x32h	12 3/4	15 3/4	30
*TB18x23h	8	18 1/4	23
*TB18x32h	10 1/4	18 1/4	32 1/4
*TB18x35h	10 1/4	18 1/4	35 1/4
*TB18x40h	10 1/4	18 1/4	40 1/4
*TB18x47.5h	11	18	47 1/2
*TB19x29h	9 3/4	18 3/4	34
*TB19x35h	14 3/4	18 3/4	33
TB12x27i	8 1/8	11 1/4	26 1/2
TB10x56i	8 3/4	9 3/4	55 1/2
TB13x45i	9 3/4	12 3/4	42 1/2
*TB14x37i	8 1/2	13 1/2	36 1/4
*TB18x44i	10 7/8	17 7/8	43 7/8
*TB30x57i	16	30	57
TB12x22j	9 1/4	12 1/4	22 1/2



**Tapered Flanged Guards**

**Tapered Flanged Backplates**

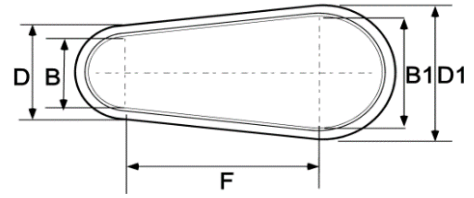
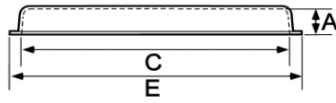
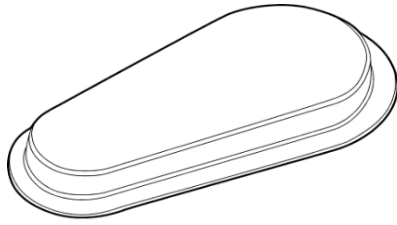

All dimensions measured in inches

Part Number	Height "A"	Small Dia "B"	Large Dia "B1"	Length "C"	Center "F"
TG51225	5	8	12	25	15 1/2
TG51337	5	4 1/2	13	37	28 1/2
TG51442	5	10	14	42	30
TG51525	5	8	15	25	13 1/2
TG51948	5	10	19	48	33 1/2
TG53351	5	10	33	51	29
TG5.21833	5 1/4	10	17 5/8	32 7/8	19 1/2
TG5.51738	5 1/2	13	16 3/4	37 3/8	23
TG5.51949	5 1/2	9 1/2	19	48 3/4	34 1/2
TG5.52144	5 1/2	14 1/4	20 1/4	42 7/8	25 5/8
TG61235	6	8 1/2	12	34 3/4	10 1/4
TG6.22261	6 1/4	14	22	61	43
TG7.21928	7 1/4	6 1/4	19 1/2	27 3/4	15 1/2
TG90244	9	16	20	44	26
10.728.5	Superceded	by part#	TG2.81128	28 1/2	18 3/4
3.31128	Superceded	by part#	TG2.81128		

Backplate Part Number	Small Dia "D"	Large Dia "D1"	Length "E"
*TB14x27j	10 1/4	14 1/4	27 1/4
*TB15x39j	6 5/8	15 1/8	39 3/8
*TB16x44j	12	16	44
*TB17x27j	10 1/4	17 1/4	27 1/4
*TB21x50j	12	21	50
*TB35x53j	12	35	53
*TB20x35j	12	20 1/4	35 3/4
*TB19x40k	15	19	38
*TB21x51k	11 3/4	21 1/4	51
*TB23x46k	17	23	44
*TB14x37l	10 1/2	14	36 3/4
*TB24x63l	16	24	63
*TB21x30n	9 1/8	23 1/2	31 7/8
*TB22x46r	18	22	46

Guards are measured from the SMALLEST INTERIOR POINT unless specified.

- Tapered Flanged Guards (TG) cover belt or chain drives with different sized sheaves or sprockets.
- The TG backplate covers the back of the guard, which can be attached to guards through holes / brackets made through the flange. *NOTE: MGC normal manufacturing policy DOES NOT include cutting holes for shafts or make brackets for mounting. This can be done on special orders.*
- Height "A", Width "B", "B-1", and Length "C" are measured at the smallest point on the inside of the guard.
- Width "D", "D-1", and Length "E" refer both to the dimensions of the guard measured at the flange and to the dimensions of the matching backplate.
- Additional sizes are available, contact us for additional information.

\*In order to provide additional strength, these backplates are made from 3/16" material. When made of black or yellow ABS, backplates are normally 1/8".

**Available Materials:**

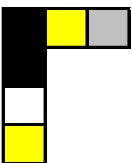

- 3/16" ABS
- 1/4" ABS
- 3/16" transparent PETG
- 1/4" Kydex

**Available Options:**

- Gaskets
- Hinges
- Extruded Aluminum Framework
- Powder Coated Extruded Metal Mesh

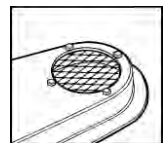





**Tapered Flanged Guards with Safety Captured Fasteners**

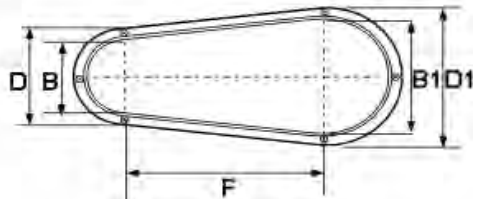
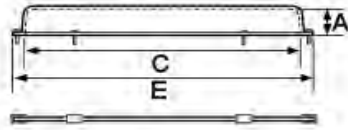
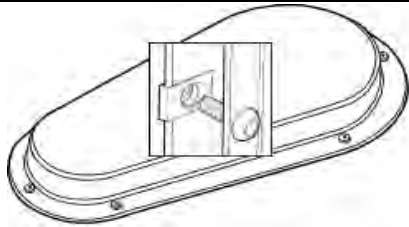

All dimensions measured in inches

Please note: Safety Captured Fastener hardware locations for illustration only.

Part Number	Height "A"	Small Dia "B"	Large Dia "B1"	Length "C"	Center "F"	# of SCF
-------------	------------	---------------	----------------	------------	------------	----------

Backplate Part Number	Small Dia "D"	Large Dia "D1"	Length "E"
-----------------------	---------------	----------------	------------

TG1.70717.5SCF	1 3/4	4 1/4	7 1/8	17 5/8	12	4
TG20406SCF	2	1 3/8	3 3/8	5 1/2	3 1/8	4
TG25.59.5SCF	2	3 3/4	5 1/2	9 1/4	4 5/8	4
TG2.50513SCF	2 1/2	3 5/8	4 1/2	13	8 3/4	4
TG2.53.58.5SCF	2 1/2	1 1/2	3 1/4	8 1/4	5 7/8	6
TG2.81128SCF	2 3/4	8 1/2	11	28 3/4	18 1/2	4
TG30412SCF	3	3 5/8	4 1/8	11 3/4	7 7/8	4
TG30512SCF	3	4	5	12 1/4	7 7/8	4
TG30514SCF	3	2 7/8	4 7/8	14	10 1/8	4
TG30515SCF	3	3 7/8	4 5/8	15	10 7/8	4
TG30714SCF	3	3 3/4	6 1/2	13 3/4	8 3/4	4
TG30715SCF	3	4	7	15	9 1/2	4
TG30720SCF	3	5	6 3/4	19 1/4	13 3/4	6
TG30812SCF	3	4	8	12	6	4
TG31120SCF	3	7	11 1/8	20	11 1/8	6
TG31126SCF	3	8 3/8	10 7/8	25 1/2	16	6
TG31428SCF	3	7 1/4	14	28 5/8	18	6
TG32340SCF	3	7	23	40	25	8
TG3.20836.5SCF	3 1/4	5 3/4	8	36 1/2	29 1/2	4
TG3.20514SCF	3 3/8	3	5	14 3/8	10 3/8	8
TG3.50819SCF	3 1/2	5	8 1/8	19 1/8	12 5/8	6
TG3.50823SCF	3 1/2	4 5/8	7 7/8	22 1/8	16	6
TG3.51025SCF	3 1/2	6 1/4	9 3/8	24 1/2	16 7/8	6
TG3.51424SCF	3 1/2	6	14	24	14	8
TG3.51642SCF	3 1/2	9	16	41 1/4	29 1/2	8
TG3.51828SCF	3 1/2	10 3/4	18	27 7/8	13 1/2	6
TG40829SCF	4	5 3/4	8 1/4	28 7/8	21 3/4	6
TG410153.7SCF	4	6 1/2	10	15 3/4	7 1/2	6
TG41326SCF	4	10	13 1/4	26 1/2	14 1/2	6
TG41430SCF	4	10	13 3/8	28 7/8	17	6
TG41621SCF	4	6	16 1/4	20 3/8	9 5/8	6
TG41630SCF	4	8	16	30	18	6
TG41633SCF	4	8	16	33	21	6
TG41638SCF	4	8	16	38	26	6
TG41645.5SCF	4	9	16	45 1/2	33	8
TG41727SCF	4	9 1/8	16 1/2	26 5/8	13 13/16	6
TG41733SCF	4	12 1/2	16 1/2	33	17 5/8	8
TG4.51025SCF	4 1/2	6 1/4	9 3/8	24 1/2	16 7/8	6
TG4.50854SCF	4 1/2	7 1/8	8	54	45 3/8	10
TG4.51143SCF	4 1/2	8 1/4	11	42 1/4	32 3/4	8
TG4.51235SCF	4 1/2	6 1/4	11 1/2	33 1/2	26 5/8	8
TG4.51642SCF	4 1/2	8 3/4	15 3/4	41 3/4	29	8
TG4.52855SCF	4 1/2	14	28	55	34	10

TB9x19.5dSCF	6	9	19 3/8	
TB6x8dSCF	3 1/8	5 1/4	7 1/4	
TB7.5x11.5dSCF	5 1/2	7 1/4	11 1/2	
TB7x15eSCF	5 1/2	6 3/8	14 3/4	
TB5.5x10.5eSCF	3 7/20	5 1/2	10 1/2	
TB13x30fSCF	10 1/2	13	30	
TB6x14fSCF	5 1/2	6 1/8	13 3/4	
TB7x14fSCF	6	6 7/8	14 1/4	
TB7x16fSCF	5 1/2	7 1/3	15 7/8	
TB7x17fSCF	5 3/4	6 1/2	17	
TB9x16fSCF	5 5/8	8 3/8	15 3/4	
TB9x17fSCF	6	9	17	
TB9x22fSCF	7	8 3/4	21 1/2	
TB10x14fSCF	6	10	14	
TB13x22fSCF	8 7/8	13	22	
TB13x28fSCF	10 1/4	12 3/4	27 1/2	
*TB16x30fSCF	9	15 3/4	30 1/2	
*TB25x42fSCF	8 7/8	24 7/8	41 7/8	
TB10x38.5gSCF	7 5/8	9 7/8	38 3/8	
TB7x16gSCF	4 3/4	6 3/4	16 1/8	
TB10x21gSCF	7	10 1/8	21 1/4	
TB10x25gSCF	6 1/2	9 3/4	24 1/4	
TB12x27gSCF	8 1/8	11 1/4	26 1/2	
TB16x26gSCF	8	16	26	
*TB18x44gSCF	11	18	44	
*TB20x30gSCF	12 1/2	19 3/4	29 5/8	
TB10x31hSCF	7 3/4	10 1/4	30 7/8	
TB12x18hSCF	8 1/2	12	17 3/4	
*TB15x28hSCF	11 3/4	14 3/4	26	
*TB16x32hSCF	12 3/4	15 3/4	30	
*TB18x23hSCF	8	18 1/4	23	
*TB18x32hSCF	10 1/4	18 1/4	32 1/4	
*TB18x35hSCF	10 1/4	18 1/4	35 1/4	
*TB18x40hSCF	10 1/4	18 1/4	40 1/4	
*TB18x47.5hSCF	11	18	47 1/2	
*TB19x29hSCF	9 3/4	18 3/4	34	
*TB19x35hSCF	14 3/4	18 3/4	33	
TB12x27iSCF	8 1/8	11 1/4	26 1/2	
TB10x56iSCF	8 3/4	9 3/4	55 1/2	
TB13x45iSCF	9 3/4	12 3/4	42 1/2	
TB14x37iSCF	8 1/2	13 1/2	36 1/4	
*TB18x44iSCF	10 7/8	17 7/8	43 7/8	
*TB30x57iSCF	16	30	57	



**Tapered Flanged Guards with Safety Captured Fasteners**

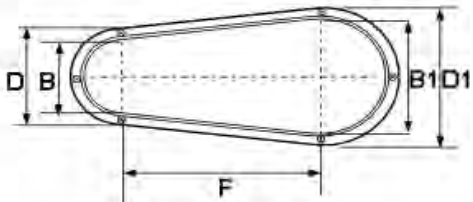
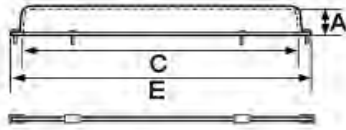
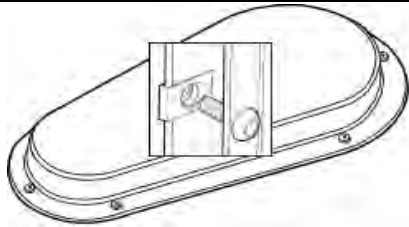

All dimensions measured in inches

Please note: Safety Captured Fastener hardware locations for illustration only.

Part Number	Height "A"	Small Dia "B"	Large Dia "B1"	Length "C"	Center "F"	# of SCF
TG51020SCF	5	7	10	20 1/8	11 3/4	4
TG51225SCF	5	8	12	25	15 1/2	6
TG51337SCF	5	4 1/2	13	37	28 1/2	8
TG51442SCF	5	10	14	42	30	6
TG51525SCF	5	8	15	25	13 1/2	8
TG51948SCF	5	10	19	48	33 1/2	10
TG53346SCF	5	10	33	51	29	10
TG5.21833SCF	5 1/4	10	17 5/8	32 7/8	19 1/2	8
TG5.51738SCF	5 1/2	13	16 3/4	37 3/8	23	8
TG5.51949SCF	5 1/2	9 1/2	19	48 3/4	34 1/2	10
TG5.52144SCF	5 1/2	14 1/4	20 1/4	42 7/8	25 5/8	10
TG61235SCF	6	8 1/2	12	34 3/4	10 1/4	8
TG6.22261SCF	6 1/4	14	22	61	43	12
TG7.21928SCF	7 1/4	6 1/4	19 1/2	27 3/4	15 1/2	10
TG92044SCF	9	16	20	44	26	12

Backplate Part Number	Small Dia "D"	Large Dia "D1"	Length "E"
TB12x22jSCF	9 1/4	12 1/4	22 1/2
TB14x27jSCF	10 1/4	14 1/4	27 1/4
*TB15x39jSCF	6 5/8	15 1/8	39 3/8
*TB16x44jSCF	12	16	44
*TB17x27jSCF	10 1/4	17 1/4	27 1/4
*TB21x50jSCF	12	21	50
*TB35x53jSCF	12	35	53
*TB20x35jSCF	12	20 1/4	35 3/4
*TB19x40kSCF	15	19	38
*TB21x51kSCF	11 3/4	21 1/4	51
*TB23x46kSCF	17	23	44
*TB14x37iSCF	10 1/2	14	36 3/4
*TB24x63iSCF	16	24	63
*TB21x30nSCF	9 1/8	23 1/2	31 7/8
*TG22x46rSCF	18	22	46

Guards are measured from the SMALLEST INTERIOR POINT unless specified.

Our Safety Captured Fastener program has been designed for the maximum convenience of maintenance personnel while **at the same time conforming to the most rigid "hand tool needed for removal" interpretation of ANSI regulations (ANSI B11.19-2010 Section 7.2.6 Guards).**

This system includes: holes drilled for the fasteners, u-nuts on the backplate, and button head socket cap screws attached to the guard. The button head socket cap screws are matched to the thickness of the guard and backplate for a snug fit, and must be turned with a 5/32" hex driver. They are permanently installed with push retainers so they cannot detach easily.

Standardized Safety Captured Fastener mounting locations for each part number have been established. Should your guard application require custom locations, please contact us to discuss options.

**Available Materials:**

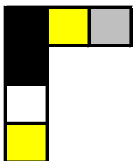

- 3/16" ABS
- 1/4" ABS
- 3/16" transparent PETG
- 1/4" Kydex

**Available Options:**

- Gaskets
- Hinges
- Extruded Aluminum Framework
- Powder Coated Extruded Metal Mesh

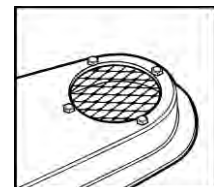



**Tapered Unflanged Guards**

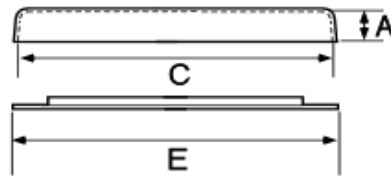
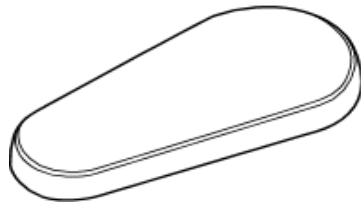

All dimensions measured in inches

Part Number	Height "A"	Small Dia "B"	Large Dia "B1"	Length "C"	Center "F"
-------------	------------	---------------	----------------	------------	------------

UTG1.20717.5	1 1/4	4 1/4	7 1/8	17 5/8	12
UTG1.50406	1 1/2	1 3/8	3 3/8	5 1/2	3 1/8
UTG1.55.59.5	1 1/2	3 3/4	5 1/2	9 1/4	4 5/8
UTG2.03.58.5	2	1 1/2	3 1/4	8 1/4	5 7/8
UTG20513	2	3 5/8	4 1/2	13	8 3/4
UTG2.21128	2 1/4	8 1/2	11	28 3/4	18 1/2
UTG2.50412	2 1/2	3 5/8	4 1/8	11 3/4	7 7/8
UTG2.50512	2 1/2	4	5	12 1/4	7 7/8
UTG2.50514	2 1/2	2 7/8	4 7/8	14	10 1/8
UTG2.50515	2 1/2	3 7/8	4 5/8	15	10 7/8
UTG2.50714	2 1/2	3 3/4	6 1/2	13 3/4	8 3/4
UTG2.50715	2 1/2	4	7	15	9 1/2
UTG2.50720	2 1/2	5	6 3/4	19 1/4	13 3/4
UTG2.50812	2 1/2	4	8	12	6
UTG2.51120	2 1/2	7	11 1/8	20	11 1/8
UTG2.51126	2 1/2	8 3/8	10 7/8	25 1/2	16
UTG2.51428	2 1/2	7 1/4	14	28 5/8	18
UTG2.52340	2 1/2	7	23	40	25
UTG2.70514	2 5/8	3	5	14 3/8	10 3/8
UTG2.70836.5	2 3/4	5 3/4	8	36 1/2	29 1/2
UTG30819	3	5	8 1/8	19 1/8	12 5/8
UTG30823	3	4 5/8	7 7/8	22 1/8	16
UTG31025	3	6 1/4	9 3/8	24 1/2	16 7/8
UTG31424	3	6	14	24	14
UTG31642	3	9	16	41 1/4	29 1/2
UTG31828	3	10 3/4	18	27 7/8	13 1/2
UTG3.41015.7	3 1/2	6 1/2	10	15 3/4	7 3/4
UTG3.50829	3 1/2	5 3/4	8 1/4	28 7/8	21 3/4
UTG3.51326	3 1/2	10	13 1/4	26 1/2	14 1/2
UTG3.51430	3 1/2	10	13 3/8	28 7/8	17
UTG3.51621	3 1/2	6	16 1/4	20 3/8	9 5/8
UTG3.51630	3 1/2	8	16	30	18
UTG3.51633	3 1/2	8	16	33	21
UTG3.51638	3 1/2	8	16	38	26
UTG3.51645.5	3 1/2	9	16	45 1/2	33
UTG3.51727.5	3 1/2	9 1/8	16 1/2	26 5/8	13 13/16
UTG3.51733	3 1/2	12 1/2	16 1/2	33	17 5/8
UTG41025	4	6 1/4	9 3/8	24 1/2	16 7/8
UTG40854	4	7 1/8	8	54	45 3/8
UTG41143	4	8 1/4	11	42 1/4	32 3/4
UTG41235	4	6 1/4	11 1/2	33 1/2	26 5/8
UTG41642	4	8 3/4	15 3/4	41 3/4	29
UTG42855	4	14	28	55	34
UTG4.51020	4 1/2	7	10	20 1/8	11 3/4

**Tapered Unflanged Backplates**

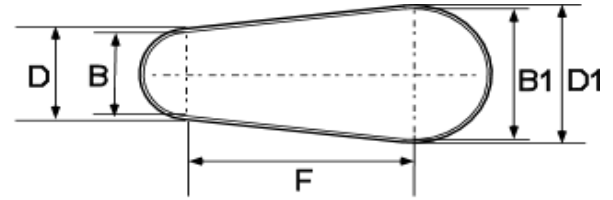

Backplate Part Number	Small Dia "D"	Large Dia "D1"	Length "E"
-----------------------	---------------	----------------	------------

UTB7x17.5c	4 1/2	7 1/2	17 7/8
UTB4x6c	1 1/2	3 5/8	5 3/4
UTB5.5x9.5c	4	5 5/8	9 1/2
UTB3.5x8.5d	1 3/4	3 1/2	8 1/2
UTB5x13d	3 7/8	4 3/4	13 1/4
UTB11x28e	8 1/2	11	28 3/4
UTB4x12e	3 7/8	4 3/8	12 1/4
UTB5x12e	4 3/4	5 1/2	12 3/4
UTB5x14e	2 7/8	4 7/8	14
UTB5x15e	4 1/2	5 1/4	15 1/2
UTB7x14e	4 1/4	7	14 1/4
UTB7x15e	4 1/2	7 1/2	15 1/2
UTB7x20e	5 3/4	7 1/2	20
UTB8x12e	4 3/4	8 3/4	12 3/4
UTB11x20e	7 1/4	11 1/4	20
UTB11x26e	8 5/8	11 1/8	26
*UTB14x28e	7 3/4	14 1/2	29 1/8
*UTB23x40e	7 3/4	23 3/4	25 1/2
UTB5x14f	3	5	14 3/8
UTB8x36.5f	6 1/8	8 3/8	36 7/8
UTB8x19f	5 3/8	8 1/2	19 3/4
UTB8x23f	4 7/8	7 7/8	22 1/2
UTB10x25f	6 1/4	9 3/4	25
UTB16x26f	8	16	26
*UTB16x42f	9 1/2	16 1/2	42 1/2
*UTB18x28f	11 1/4	18 1/2	27 3/8
UTB10x15.7g	6 1/2	10	15 3/4
UTB8x29g	6 1/4	8 3/4	29 3/8
*UTB13x26g	10 1/4	13 3/8	21 1/2
*UTB14x30g	11 5/8	14 5/8	30
*UTB16x21g	5 1/2	16 5/8	21 1/2
*UTB16x30g	10 1/4	18 1/4	32 1/4
*UTB16x33g	10 1/4	18 1/4	35 1/4
*UTB16x38g	10 1/4	18 1/4	40 1/4
*UTB16x45.5g	9 1/2	16 1/2	46
*UTB17x27.5g	9 1/2	17 5/8	34
*UTB17x33g	12 3/8	17 5/8	33
UTB10x25h	6 1/4	9 3/4	25
UTB8x54h	7 5/8	8 5/8	55 1/2
UTB11x43h	8 1/2	11 5/8	42 1/2
*UTB12x35h	7 3/8	12 3/8	34 3/4
*UTB16x42h	9 1/4	16 1/4	42 1/4
*UTB28x55h	14	28	55
UTB10x20i	7 3/4	10 3/4	21



**Tapered Unflanged Guards**

**Tapered Unflanged Backplates**

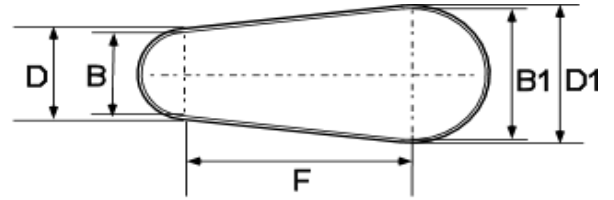
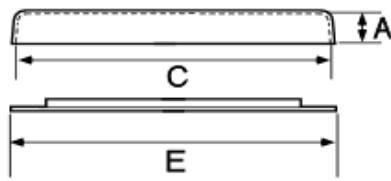
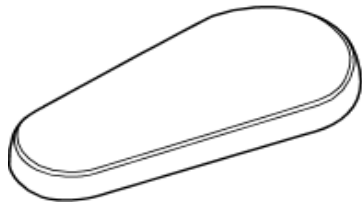

All dimensions measured in inches

Part Number	Height "A"	Small Dia "B"	Large Dia "B1"	Length "C"	Center "F"
UTG4.51225	4 1/2	8	12	25	15 1/2
UTG4.51337	4 1/2	4 1/2	13	37	28 1/2
UTG4.51442	4 1/2	10	14	42	30
UTG4.51525	4 1/2	8	15	25	13 1/2
UTG4.51948	4 1/2	10	19	48	33 1/2
UTG4.53351	4 1/2	10	33	51	29
UTG4.71834	4 3/4	10	17 5/8	32 7/8	19 1/2
UTG51738	5	13	16 3/4	37 3/8	23
UTG51949	5	9 1/2	19	48 3/4	34 1/2
UTG52144	5	14 1/4	20 1/4	42 7/8	25 5/8
UTG5.51235	5 1/2	8 1/2	12	34 3/4	10 1/4
UTG5.72261	5 3/4	14	22	61	43
UTG6.72129	6 3/4	6 1/4	19 1/2	27 3/4	15 1/2
UTG8.52044	8 1/2	16	20	44	26

Backplate Part Number	Small Dia "D"	Large Dia "D1"	Length "E"
*UTB12x25i	8 3/4	12 3/4	26 1/4
*UTB13x37i	5 1/8	13 5/8	38 5/8
*UTB14x42i	10	14	42
*UTB15x25i	8 3/4	14 3/4	26 1/4
*UTB19x48i	10	19	48
*UTB33x51i	10	33	53
*UTB18x34j	11	19 1/4	34 1/4
*UTB17x38j	14	18	38
*UTB19x49j	10 1/8	19 5/8	49 3/8
*UTB21x44j	16	22	44
*UTB12x35k	8 1/2	12	34 3/4
*UTB22x61k	14 3/4	22 3/4	61 3/4
*UTB21x29n	8 3/8	22 7/8	30 3/8
*UTB20x44q	16	20	44

Guards are measured from the SMALLEST INTERIOR POINT unless specified.

- Tapered Unflanged Guards (UTG) cover belt or chain drives with different sized sheaves or sprockets.
- The UTG backplate covers are furnished with fasteners to attach the guard to the backplate, with extruded U nuts on the backplate. This ensures fastening of metal-to-metal. *NOTE: MGC normal manufacturing policy DOES NOT include cutting holes for shafts or make brackets for mounting. This can be done on special orders.*
- Height "A", Width "B", "B-1", and Length "C" are measured at the smallest point on the inside of the guard.
- Width "D", "D-1", and Length "E" refer both to the dimensions of the guard measured at the widest point and to the dimensions of the matching backplate.
- Additional sizes are available, contact us for additional information.

\*In order to provide additional strength, these backplates are made from 3/16" material. When made of black or yellow ABS, backplates are normally 1/8".

**Available Materials:**

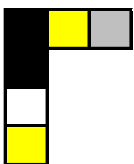

- 3/16" ABS
- 1/4" ABS
- 3/16" transparent PETG
- 1/4" Kydex

**Available Options:**

- Extruded Aluminum Framework
- Powder Coated Extruded Metal Mesh

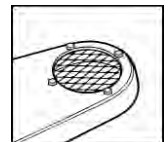



Rectangular Flanged Guards

Rectangular Flanged Backplates

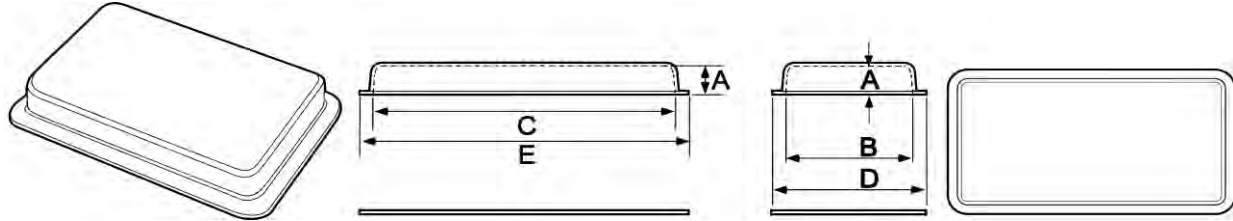

All dimensions measured in inches

Part Number	Height "A"	Width "B"	Length "C"	
-------------	------------	-----------	------------	--

RG0.750408	3/4	4	8	
RG1.509.214	1 1/2	9 1/4	14	
RG1.60406	1 1/2	4	6	
RG205.810.8	2	5 7/8	10 7/8	
RG21117	2	11 1/4	17	
RG2.20406	2 1/4	4	6	
RG21419	2 1/4	14	19 1/4	
RG2.50819	2 1/2	8	19	
RG2.51925	2 1/2	19	25	
RG30818	3 1/8	8 5/8	18 1/4	
RG3.51215.4	3 1/2	12	15 1/4	
RG40416	4	4	16	
RG4056.5	4	5	6 1/2	
RG40608	4	6	8	
RG40707	4	7	7	
RG4.51316	4 1/2	13	16	
RG4.51717	4 5/8	17	17	
RG50609	5	6	8 3/4	
RG5.50619	5 1/2	5 1/2	18 1/2	
RG60522	5 3/4	5 1/4	21 3/4	

Backplate Part Number	Width "D"	Length "E"		
-----------------------	-----------	------------	--	--

RB5x9a	5 3/4	9 3/4		
RB10.2x15c	11	15		
RB5x7c	5 1/2	7 1/2		
RB6.8x11.8d	6 7/8	11 7/8		
RB12x18d	12 3/4	18 1/2		
RB5x7d	5 3/4	7 3/4		
*RB15x20d	15 3/4	21		
RB9x20e	9 3/4	20 3/4		
*RB20x26e	20 3/4	26 3/4		
RB9x19f	10 3/8	20		
*RB13x16.4g	14	17 1/4		
RB5x17h	6	18		
RB6x7.5h	7	8 1/4		
RB7x9h	8	10		
RB8x8h	9	9		
*RB14x17i	14 3/4	17 3/4		
*RB18x18i	19	19		
RB7x10j	8 1/2	11		
RB7x20k	7 1/2	20 1/2		
RB6x23l	7 1/2	24		



**Rectangular Flanged Guards**

**Rectangular Flanged Backplates**

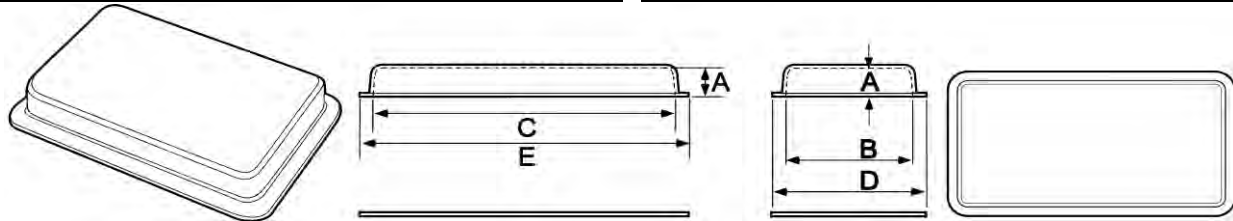

All dimensions measured in inches

Part Number	Height "A"	Width "B"	Length "C"
RG61419	6	14	19
RG6.58.513	6 1/2	8 1/2	13 1/8
RG7.251822	7 1/4	18 1/4	22
RG8.52752	8 1/2	26 3/4	51 3/4
RG101822	10	17 3/4	21 3/4

Backplate Part Number	Width "D"	Length "E"
*RB15x20l	16 1/2	21 1/2
RB9.5x14m	11	15 5/8
*RB20x23o	20 3/4	24 3/4
*RB28x53q	29 1/2	54 1/4
*RB19x23t	20 1/2	24 1/2

Guards are measured from the SMALLEST INTERIOR POINT unless specified.

**• Rectangular Flanged Guards (RG) cover a variety of drives, sheaves, sprockets and other objects.**

• The RG backplate covers the back of the guard, which can be attached to guards through holes / brackets made through the flange. *NOTE: MGC normal manufacturing policy DOES NOT include cutting holes for shafts or make brackets for mounting. This can be done on special orders.*

• Height "A", Width "B" and Length "C" are measured at the smallest point on the inside of the guard.

• Width "D" and Length "E" refer both to the dimensions of the guard measured at the flange and to the dimensions of the matching backplate.

\*In order to provide additional strength, these backplates are made from 3/16" material. When made of black or yellow ABS, backplates are normally 1/8".

• Additional sizes are available, contact us for additional information.

**Available Materials:**

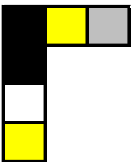

- 3/16" ABS
- 1/4" ABS
- 3/16" transparent PETG
- 1/4" Kydex

**Available Options:**

- Gaskets
- Hinges
- Extruded Aluminum Framework
- Powder Coated Extruded Metal Mesh

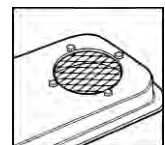



**Rectangular Flanged Guards with Safety Captured Fasteners**

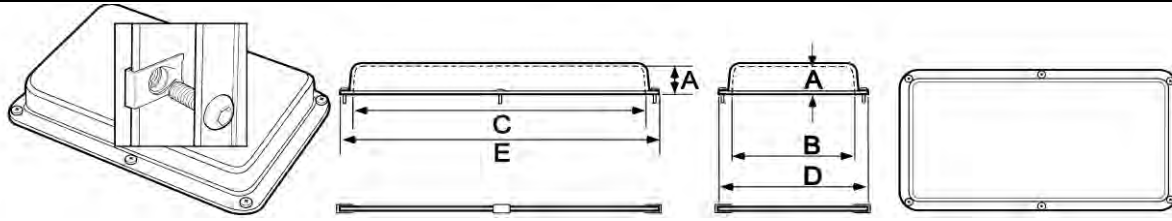

All dimensions measured in inches

Please note: Safety Captured Fastener hardware locations for illustration only.

Part Number	Height "A"	Width "B"	Length "C"	# of SCF
RG0.750408SCF	3/4	4	8	4
RG1.509.214SCF	1 1/2	9 1/4	14	4
RG1.60406SCF	1 1/2	4	6	4
RG205.810.8SCF	2	5 7/8	10 7/8	4
RG21117SCF	2	11 1/4	17	6
RG2.20406SCF	2 1/4	4	6	6
RG21419SCF	2 1/4	14	19 1/4	4
RG2.50819SCF	2 1/2	8	19	6
RG2.51925SCF	2 1/2	19	25	6
RG30818SCF	3 1/8	8 5/8	18 1/4	6
RG3.51215.4SCF	3 1/2	12	15 1/4	4
RG40416SCF	4	4	16	4
RG4056.5SCF	4	5	6 1/2	4
RG40608SCF	4	6	8	4
RG40707SCF	4	7	7	4
RG4.51316SCF	4 1/2	13	16	4
RG4.51717SCF	4 5/8	17	17	4
RG50609SCF	5	6	8 3/4	4
RG5.50619SCF	5 1/2	5 1/2	18 1/2	6
RG60522SCF	5 3/4	5 1/4	21 3/4	6

Backplate Part Number	Width "D"	Length "E"		
RB5x9aSCF	5 3/4	9 3/4		
RB10.2x15cSCF	11	15		
RB5x7cSCF	5 1/2	7 1/2		
RB6.8x11.8DSCF	6 7/8	11 7/8		
RB12x18dSCF	12 3/4	18 1/2		
RB5x7dSCF	5 3/4	7 3/4		
*RB15x20dSCF	15 3/4	21		
RB9x20eSCF	9 3/4	20 3/4		
*RB20x26eSCF	20 3/4	26 3/4		
RB9x19fSCF	10 3/8	20		
*RB13x16.4gSCF	14	17 1/4		
RB5x17hSCF	6	18		
RB6x7.5hSCF	7	8 1/4		
RB7x9hSCF	8	10		
RB8x8hSCF	9	9		
*RB14x17iSCF	14 3/4	17 3/4		
*RB18x18iSCF	19	19		
RB7x10jSCF	8 1/2	11		
RB7x20kSCF	7 1/2	20 1/2		
RB6x23lSCF	7 1/2	24		



**Rectangular Flanged Guards with Safety Captured Fasteners**

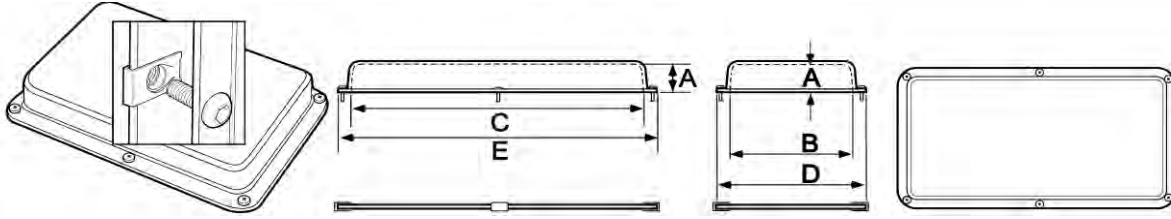

All dimensions measured in inches

Please note: Safety Captured Fastener hardware locations for illustration only.

Part Number	Height "A"	Width "B"	Length "C"	# of SCF
RG61419SCF	6	14	19	6
RG6.58.513SCF	6 1/2	8 1/2	13 1/8	6
RG7.251822SCF	7 1/4	18 1/4	22	6
RG8.52752SCF	8 1/2	26 3/4	51 3/4	12
RG101822SCF	10	17 3/4	21 3/4	6

Backplate Part Number	Width "D"	Length "E"		
*RB15x20ISCF	16 1/2	21 1/2		
RB9.5x14mSCF	11	15 5/8		
*RB20x23oSCF	20 3/4	24 3/4		
*RB28x53qSCF	29 1/2	54 1/4		
*RB19x23tSCF	20 1/2	24 1/2		

Guards are measured from the SMALLEST INTERIOR POINT unless specified.

Our Safety Captured Fastener program has been designed for the maximum convenience of maintenance personnel **while at the same time conforming to the most rigid "hand tool needed for removal" interpretation of ANSI regulations (ANSI B11.19-2010 Section 7.2.6 Guards).**

This system includes: holes drilled for the fasteners, u-nuts on the backplate, and button head socket cap screws attached to the guard. The button head socket cap screws are matched to the thickness of the guard and backplate for a snug fit, and must be turned with a 5/32" hex driver. They are permanently installed with push retainers so they cannot detach easily.

Standardized Safety Captured Fastener mounting locations for each part number have been established. Should your guard application require custom locations, please contact us to discuss options.

**Available Materials:**

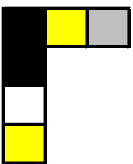

- 3/16" ABS
- 1/4" ABS
- 3/16" transparent PETG
- 1/4" Kydex

**Available Options:**

- Gaskets
- Hinges
- Extruded Aluminum Framework
- Powder Coated Extruded Metal Mesh

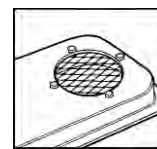





Rectangular Unflanged Guards

Rectangular Unflanged Backplates

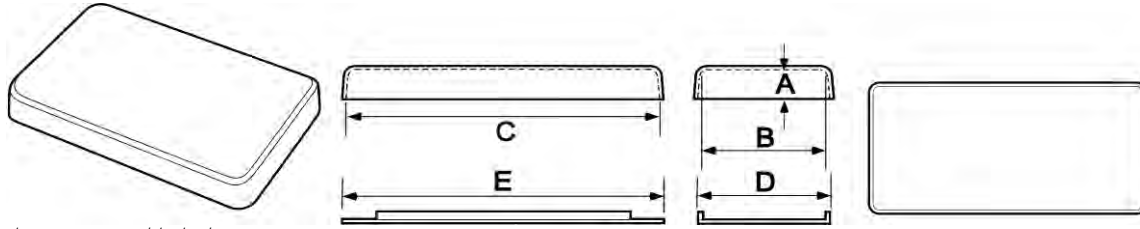

All dimensions measured in inches

Part Number	Height "A"	Width "B"	Length "C"	
URG10406	1	4	6	
URG109.214	1	9 1/4	14	
URG1.505.810.8	1 1/2	4 7/8	10 7/8	
URG20406	1 3/4	4	6	
URG21117	1 3/4	11 1/4	17	
URG21419	1 3/4	14	19 1/4	
URG21925	2	19	25	
URG2.50818	2 1/2	8 5/8	18 1/4	
URG31215.2	3	12	15 1/4	
UG3.50416	3 1/2	4	16	
URG3.5056.5	3 1/2	5	6 1/2	
URG3.50608	3 1/2	6	8	
URG3.50707	3 1/2	7	7	
URG41316	4	13	16	
URG41717	4 1/8	17	17	
URG4.50609	4 1/2	6	8 3/4	
URG4.50619	4 1/2	5 1/2	18 1/2	

Backplate Part Number	Width "D"	Length "E"	
URB4x6b	4 1/4	6 1/4	
URB9.2x14b	9 1/4	14	
URB6.8x11.8d	6 7/8	11 7/8	
URB4x6c	4 1/4	6 1/4	
URB11x17c	11 1/2	17 1/2	
*URB14x19c	14 1/4	19 1/2	
*URB19x25d	19 1/4	25 1/4	
URB8x18e	9	18 1/2	
*URB12x15.2f	12 1/2	16	
URB4x16g	4	16	
URB5x6.5g	5 1/2	7	
URB6x8g	6 1/2	8 1/2	
URB7x7g	7 1/2	7 1/2	
*URB13x16h	13	16 1/4	
*URB17x17i	17	17	
URB6x9i	7	9 1/2	
URB6x19i	6	19	



**Rectangular Unflanged Guards**

**Rectangular Unflanged Backplates**

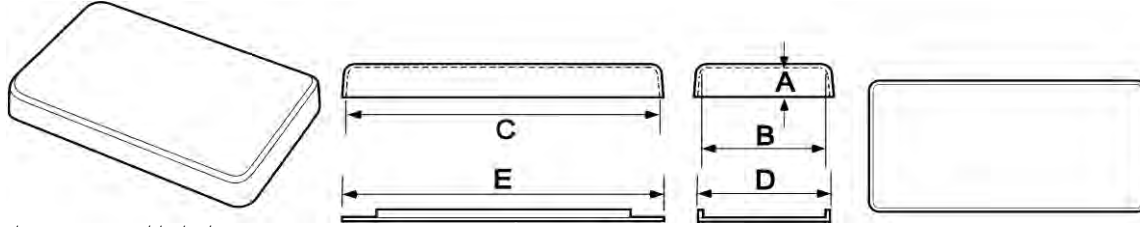

All dimensions measured in inches

Part Number	Height "A"	Width "B"	Length "C"
URG50522	4 3/4	5 1/4	21 3/4
URG5.51419	5 1/2	14	19
URG6.08.513	6	8 1/2	13 1/8
URG6.751822	6 3/4	18 1/4	22
URG82752	8	26 3/4	51 3/4
URG9.51822	9 1/2	17 3/4	21 3/4

Backplate Part Number	Width "D"	Length "E"
URB5x22j	6	22 1/2
*URB14x19k	15	20
URB8.5x13l	9 1/2	14 5/8
*URB18x22n	19 1/4	23 1/4
*URB27x52p	28	52 3/4
*URB18x22s	19	23

Guards are measured from the SMALLEST INTERIOR POINT unless specified.

- Rectangular Unflanged Guards (URG) cover a variety of drives, sheaves, sprockets and other objects.
- The URG backplate covers are furnished with fasteners to attach the guard to the backplate, with extruded U nuts on the backplate. This ensures fastening of metal-to-metal. *NOTE: MGC normal manufacturing policy DOES NOT include cutting holes for shafts or make brackets for mounting. This can be done on special orders.*
- Height "A", Width "B" and Length "C" are measured at the smallest point on the inside of the guard.
- Width "D" and Length "E" refer both to the dimensions of the guard measured at the widest point and to the dimensions of the matching backplate.

\*In order to provide additional strength, these backplates are made from 3/16" material. When made of black or yellow ABS, backplates are normally 1/8".

- Additional sizes are available, contact us for additional information.

**Available Materials:**

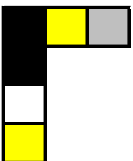

- 3/16" ABS
- 1/4" ABS
- 3/16" transparent PETG
- 1/4" Kydex

**Available Options:**

- Extruded Aluminum Framework
- Powder Coated Extruded Metal Mesh

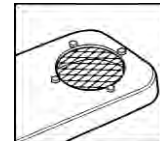



# Flanged Bearing Cover Request Sheet

Select a bearing shape:

Note the position of any grease fittings by marking a box in the bearing drawing.

Example:

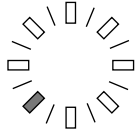

2 Bolt

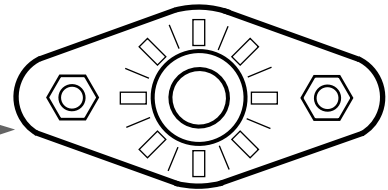

3 Bolt

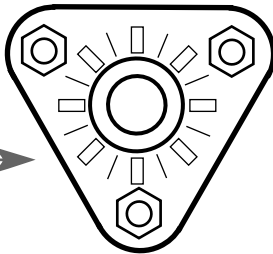

3 Bolt Offset

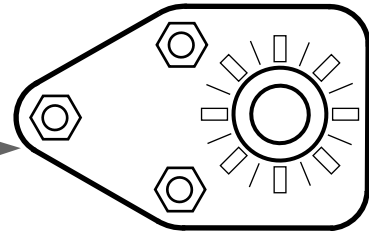

4 Bolt

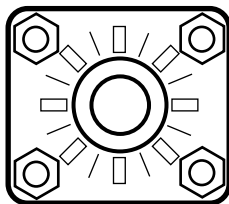

4 Bolt Offset

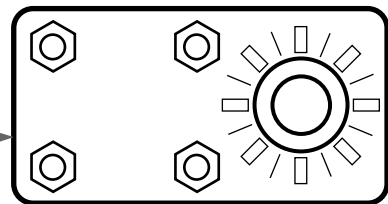

Use the second sheet for dimensions.

## Contact Information

Company:

Name:

Contact email:

Contact phone:

Email or Fax this sheet to:



Machine Guard & Cover Co.

6187 136th Avenue

Holland, MI 49424

Phone: 888-482-7371

Fax: 877-482-7313

office@machineguard.com



### Area To Be Covered:

---

Supply information for your part in the 3 circles:

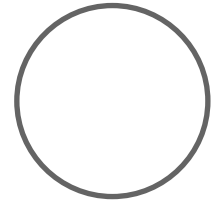
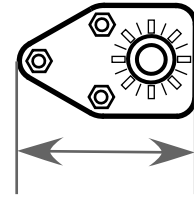
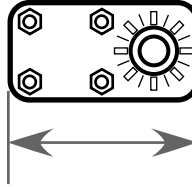
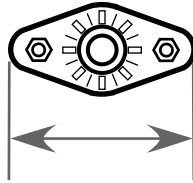
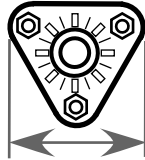
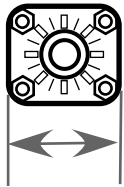

Longest Dimension

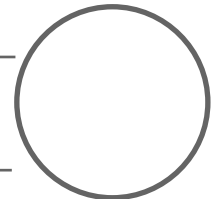
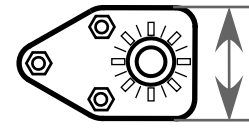
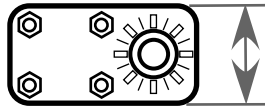
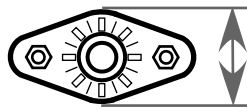
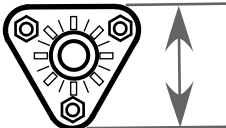
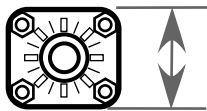

Widest Dimension

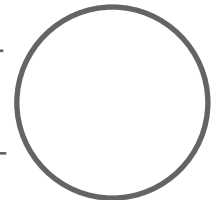

Highest Point

### Other Features:

*Include a manufacturer & part number if available:*

*Add a picture of the installed bearing if possible:*



# Flanged Bearing Cover Installation Guide

*Bearing covers should cover the entire bearing. Attachment methods differ based on the mounting structure available. Machine Guard & Cover cannot be responsible for a bearing cover installed improperly.*

1. Test fit your cover for adequate clearances. The flanges on the cover can be trimmed away as needed to avoid obstructions. If your bearing has a grease fitting you may drill or cut the cover for access. Covers may be installed using either self-tapping screws or machine screws.

2. To install with the optional supplied self-tapping screws, drill a pilot hole through the cover and structure with a 1/8" to 7/32" drill bit. Use the first hole to attach the cover to the structure.

3. To use the optional supplied machine screws, use a drill bit to make a pilot hole in the cover, and a pilot mark in the structure. Expand the cover hole with a 1/4" drill bit. Drill and tap a structure hole for 1/4"-20 threads. Use the first hole to attach the cover to the structure.

4. Drill the second hole following steps 2 or 3 as appropriate. Remove the cover if you need to drill and tap the structure. Re-install the cover to the mounting structure. Fasten all screws.

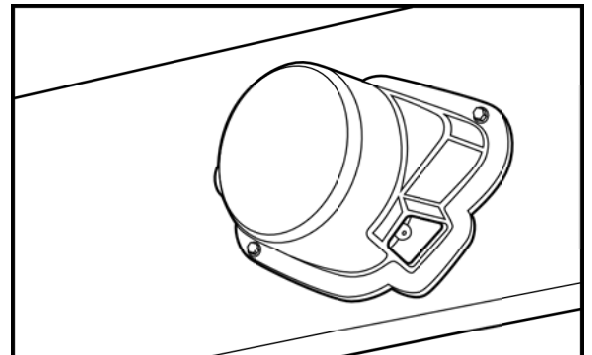
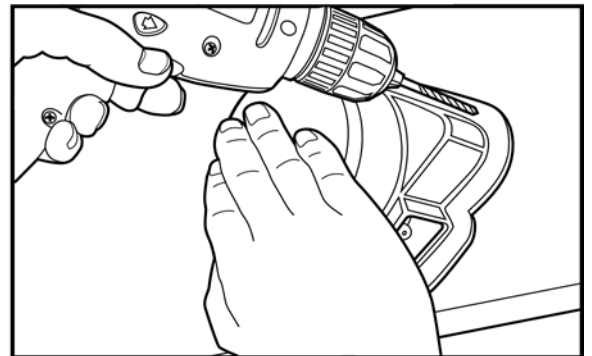
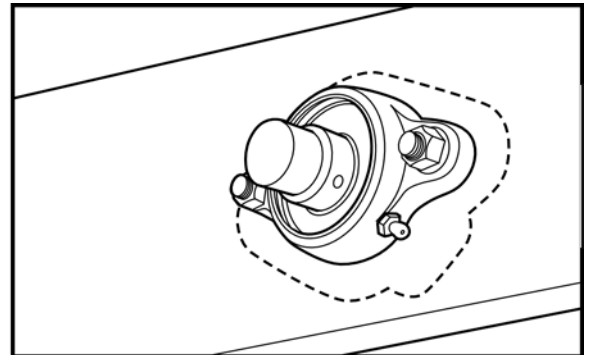



2-Bolt Flange Bearing Cover - Heavyweight

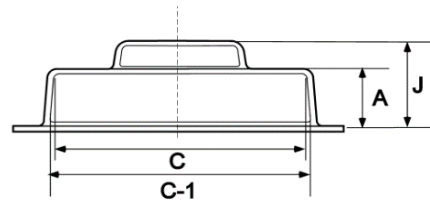
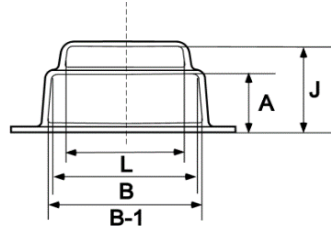
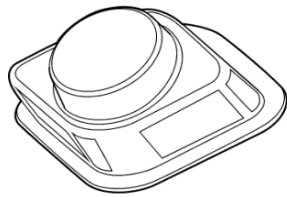

All dimensions measured in inches

Part Number	Length "C"	Length "C1"	Width "B"	Width "B1"	Cover Height "A"	Shaft Height "J"	Inside Diameter "L"	
**2BDSCFLT203H	3 3/4	3 7/8	2 1/8	2 3/16	1	2	1 5/16	
2BDSCFLT204H	3 3/4	3 13/16	2 1/2	2 9/16	1	1 7/16	2 3/16	
2BDSCFLT205H	3 3/4	3 13/16	2 11/16	2 3/4	1	2	2 1/8	
2BDSCFLT203H	3 7/16	3 5/8	2 3/8	2 1/2	1 1/4	1 13/16	1 1/16	
2BDSC203H	4	4 1/8	2 3/16	2 1/4	1	2	2	
**2BSMSFT201H	4 1/8	4 5/16	2 1/2	2 3/4	1 7/16	1 7/8	1 5/16	
2BDPELF205H	4 1/16	4 5/16	3 1/8	3 5/16	1 1/2	2 3/16	2	
**2BPENS203H	4 1/4	4 7/16	2 1/2	2 11/16	1 1/2	2	1 5/16	
**2BIPT203H	4 5/8	4 13/16	2 5/8	2 13/16	1 3/8	1 13/16	1 5/16	
**2BDSC204H	4 5/8	4 7/8	2 5/8	2 13/16	1 1/2	2 1/8	1 1/8	
2BDSCFLT207H	4 3/4	4 7/8	3 5/8	3 1/2	1 1/8	1 3/4	3 5/16	
2BDSCFLT207-Z135H	4 3/4	4 7/8	3 5/8	3 1/2	1 1/8	1 3/4	3 5/16	
**2BPES203H	4 3/4	5	2 3/4	2 7/16	1 1/2	2	2	
2BDSCFLT206H	4 7/16	4 9/16	3 7/16	3 1/2	1	1 11/16	3 7/16	
2BDSC205H	5	5 1/16	2 13/16	3	1 1/2	2	2 5/8	
**2BSHUUCFL202H	5	5 1/8	2 1/2	2 11/16	1 7/16	2 3/16	1 3/8	
*2BDSC205-Z135H	5	5 3/16	2 13/16	3	1 1/2	2	2 5/8	
*2BDSC206-Z135H	5 7/16	5 5/8	3	3 3/16	1 1/2	2 5/8	2 5/8	
2BDSC206H	5 7/16	5 3/4	3	3 1/4	1 1/2	2 9/16	2 5/8	
2BDEZ206H	5 1/2	5 11/16	3 1/8	3 5/16	1 3/8	3	2 9/16	
2BSMV219H	5 5/8	5 13/16	3 3/16	3 3/8	1 1/2	2	2 7/8	
*2BDSC207-Z135H	5 7/8	6 1/16	3 5/8	3 13/16	1 1/4	1 1/2	2 11/16	



2-Bolt Flange Bearing Cover - Heavyweight

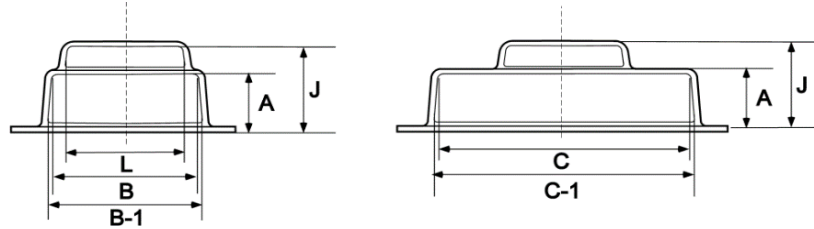
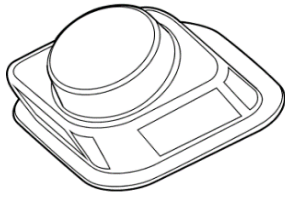

All dimensions measured in inches

Part Number	Length "C"	Length "C1"	Width "B"	Width "B1"	Cover Height "A"	Shaft Height "J"	Inside Diameter "L"	
2BDSC207H	5 13/16	6	3 5/8	3 3/4	1 7/16	2 3/16	2 11/16	
2BFRCJT1-7/16H	5 7/8	6 1/16	3 5/8	3 13/16	1 1/2	2 1/4	2 3/4	
**2BDSC207-Z45-135H	5 7/8	6 1/16	3 9/16	3 3/4	1 7/16	2 3/16	2 11/16	
**2BSHUUCFL206H	6	6 1/4	3 1/2	3 11/16	1 1/2	2 9/16	1 7/8	
2BDSXR207H	6	6 3/16	3 11/16	3 7/8	1 1/2	2 1/4	2 5/8	
**2BPemd5H	6 3/16	6 3/8	3 1/2	3 3/4	1 5/8	2 3/8	1 5/8	
2BSMV231H	6 1/8	6 5/16	3 13/16	4	1 1/2	2	3 5/8	
2BHCRX1-7/16H	6 3/16	6 5/16	3 7/16	3 5/8	1 1/2	2 3/4	3 1/16	
2BDEZ207H	6 5/16	6 1/2	3 3/4	3 15/16	1 5/16	3	2 13/16	
2BDSC208H	6 11/16	6 7/8	4 3/16	4 3/8	1 5/16	3	4	
2BDSC208-Z135H	6 11/16	6 7/8	4 3/16	4 3/8	1 5/16	3	4	
2BDSC209H	7 1/16	7 1/4	3 9/16	4 3/8	1 1/2	3	4 5/16	
**2BSHUUCFL208H	7 1/8	7 11/16	4	4 1/4	1 5/8	2 5/8	2 1/8	
2BDSC210H	7 1/4	7 7/16	3 9/16	4 3/8	1 1/2	3	4 1/4	
2BHCRX1-15/16H	7 5/8	7 7/8	4 1/4	4 1/2	2	3 1/4	4 1/8	
2BDSC211H	8 3/8	8 5/8	5 1/8	5 3/8	1 7/8	2 7/8	3 3/8	
2BHCRX2-3/16H	8 5/8	8 13/16	4 13/16	5	1 1/2	3	4 11/16	
2BDSC212H	9 13/16	10	5 1/4	5 1/2	2	4	5 1/16	

**Guards are measured from the SMALLEST INTERIOR POINT unless specified.**

- For covering 2-bolt flange bearings.
- All 2-bolt bearing covers have clearance for grease fittings.
- For installation instructions, see 'How to Install a Flange Bearing Cover' on Page 37.

\* Bearing covers with a grease fitting on the reverse side.

\*\* Bearing covers with grease fittings on both the regular and reverse side.

- For tall shafts, height can be added just to the round top part of the cover.

Available Materials:

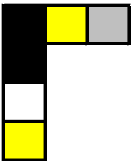

- 3/16" ABS
- 1/4" ABS
- 3/16" transparent PETG
- 1/4" Kydex

Available Options:

- Gaskets



2-Bolt Flange Bearing Cover - Lightweight

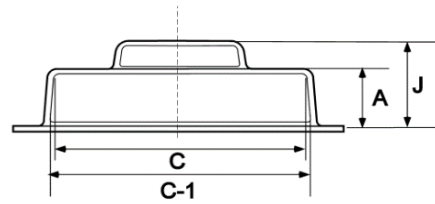
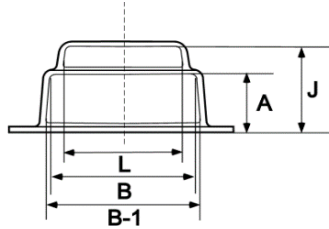
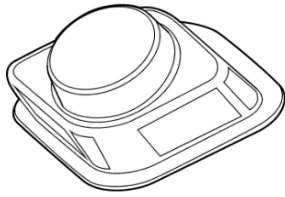

All dimensions measured in inches

Part Number	Length "C"	Length "C1"	Width "B"	Width "B1"	Cover Height "A"	Shaft Height "J"	Inside Diameter "L"	
**2BPRFLT201	3 1/2	3 3/4	2 1/4	2 7/16	1 5/16	1 7/8	1 1/4	
**2BDSCFLT203L	3 3/4	3 7/8	2 1/8	2 1/4	1	2	1 3/8	
2BDSCFLT204L	3 3/4	3 7/8	2 1/2	2 5/8	1	1 7/16	2 3/16	
2BDSCFLT205L	3 3/4	3 7/8	2 11/16	2 3/4	1	2	2 1/8	
**2BPRFLT204	3 15/16	4 1/8	2 5/8	2 3/4	1 7/16	2	1 7/16	
2BDSC203L	4	4 1/8	2 3/16	2 5/16	1	2	2 1/16	
**2BSMSFT201L	4 1/8	4 5/16	2 1/2	2 3/4	1 7/16	1 7/8	1 5/16	
**2BPENS203L	4 1/4	4 7/16	2 1/2	2 11/16	1 1/2	2	1 5/16	
**2BDSC204L	4 3/8	4 1/2	2 5/16	2 7/16	1 1/4	2	2 3/16	
2BDSCFLT206L	4 7/16	4 9/16	3 7/16	3 1/2	1	1 11/16	3 7/16	
**2BIPT203L	4 5/8	4 13/16	2 5/8	2 13/16	1 3/8	1 13/16	1 5/16	
**2BDSC204L	4 5/8	4 7/8	2 5/8	2 13/16	1 1/2	2 1/8	1 1/8	
2BDSCFLT207L	4 3/4	4 7/8	3 5/8	3 1/2	1 1/8	1 3/4	3 5/16	
**2BPES203L	4 3/4	5	2 3/4	2 7/16	1 1/2	2	2	
2BDSC205L	5	5 3/16	2 13/16	3	1 1/2	2	2 5/8	
*2BDSC205-Z135L	5	5 3/16	2 13/16	3	1 1/2	2	2 5/8	
*2BDSC206-Z135L	5 7/16	5 5/8	3	3 3/16	1 1/2	2 5/8	2 5/8	
2BDSC206L	5 7/16	5 5/8	3	3 3/16	1 1/2	2 5/8	2 5/8	
2BDEZ206L	5 1/2	5 5/8	3 1/4	3 3/16	1 3/8	3	2 1/2	





2-Bolt Flange Bearing Cover - Lightweight

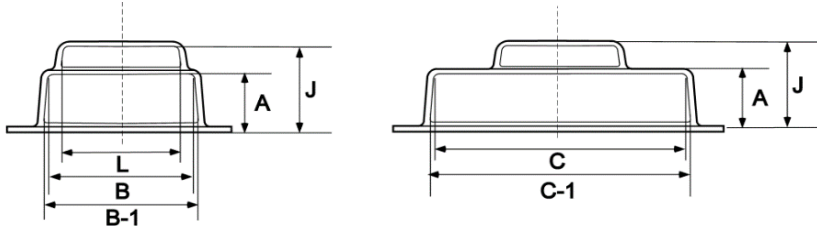
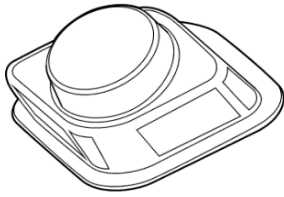



All dimensions measured in inches

Part Number	Length "C"	Length "C1"	Width "B"	Width "B1"	Cover Height "A"	Shaft Height "J"	Inside Diameter "L"	
2BSMV219L	5 5/8	5 13/16	3 3/16	3 3/8	1 1/2	2	2 7/8	
**2BDSC207-Z45-135L	5 7/8	6 1/16	3 9/16	3 3/4	1 7/16	2 3/16	2 11/16	
*2BDSC207-Z135L	5 7/8	6 1/16	3 5/8	3 13/16	1 1/4	1 1/2	2 11/16	
2BDSC207L	5 7/8	6 1/16	3 5/8	3 13/16	1 1/4	1 1/2	2 11/16	
2BFRCJT1-7/16L	5 7/8	6 1/16	3 5/8	3 13/16	1 1/2	2 1/4	2 3/4	
2BDSXR207L	6	6 3/16	3 11/16	3 7/8	1 1/2	2 1/4	2 5/8	
2BSMV231L	6 1/8	6 5/16	3 13/16	4	1 1/2	2	3 5/8	
2BHCRX1-7/16L	6 3/16	6 5/16	3 7/16	3 5/8	1 1/2	2 3/4	3 1/16	
**2BPEMD5L	6 3/16	6 3/8	3 1/2	3 3/4	1 5/8	2 3/8	1 5/8	
2BDEZ207L	6 5/16	6 1/2	3 3/4	3 15/16	1 5/16	3	2 13/16	
2BDSC208L	6 11/16	6 7/8	4 3/16	4 3/8	1 5/16	3	4	
2BDSC208-Z135L	6 11/16	6 7/8	4 3/16	4 3/8	1 5/16	3	4	

**Guards are measured from the SMALLEST INTERIOR POINT unless specified.**

- For covering 2-bolt flange bearings.
- All 2-bolt bearing covers have clearance for grease fittings.
- For installation instructions, see 'How to Install a Flange Bearing Cover' on Page 37.
- \* Bearing covers with a grease fitting on the reverse side.
- \*\* Bearing covers with grease fittings on both the regular and reverse side.
- For tall shafts, height can be added just to the round top part of the cover.
- Lightweight Guards are designed for non-abusive environments.
- Our metal detectable ABS plastic is FDA approved for certain pharmaceutical and food applications. Contact us for specific details.

Available Materials:

-  1/8" ABS
-  1/8" ABS Metal Detectable

Available Options:

- Gaskets



**3-Bolt Flange Bearing Cover - Heavyweight**

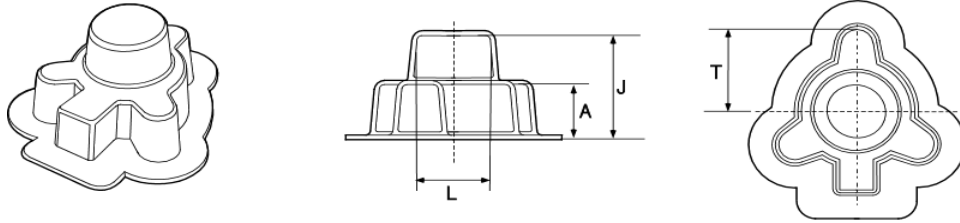

All dimensions measured in inches

Part Number	Overall Diameter	Cover Height "A"	Shaft Height "J"	Center to Corner "T"	Inside Diameter "L"				
3BDSCLF205H	3 7/8	1	2 1/4	1 7/8	1 5/8				
3BDSCLF206H	4 3/8	1 1/4	2 5/8	2 1/8	1 15/16				
3BDSCLF207H	5	1 1/4	2 5/8	2 3/8	2 5/16				
3BBRB33-119M	3 3/8	1 1/4	1 3/4	2 1/2	1 13/16				
3BBRB33-123M	3 3/4	1 1/4	2	2 15/16	1 13/16				

Guards are measured from the SMALLEST INTERIOR POINT unless specified.

- For covering 3-bolt flange bearings.
- For installation instructions, see 'How to Install a Flange Bearing Cover' on Page 37.
- For tall shafts, height can be added just to the round top part of the cover.
- If you do not see what you are looking for, give us a call!

Available Materials:

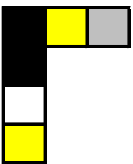

- 3/16" ABS
- 1/4" ABS
- 3/16" transparent PETG
- 1/4" Kydex

Available Options:

- Gaskets



3-Bolt Flange Bearing Cover - Lightweight

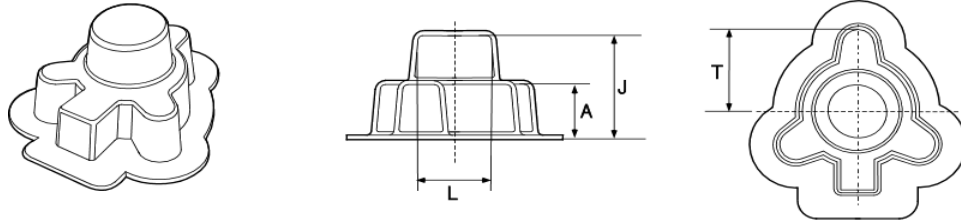

All dimensions measured in inches

Part Number	Overall Diameter	Cover Height "A"	Shaft Height "J"	Center to Corner "T"	Inside Diameter "L"				
3BDSCLF205L	3 7/8	1	2 1/4	1 7/8	1 5/8				
3BDSCLF206L	4 3/8	1 1/4	2 5/8	2 1/8	1 15/16				
3BDSCLF207L	5	1 1/4	2 5/8	2 3/8	2 5/16				

Guards are measured from the SMALLEST INTERIOR POINT unless specified.

- For covering 3-bolt flange bearings.
- For installation instructions, see 'How to Install a Flange Bearing Cover' on Page 37.
- For tall shafts, height can be added just to the round top part of the cover.
- Lightweight Guards are designed for non-abusive environments.
- If you do not see what you are looking for, give us a call!
- Our metal detectable ABS plastic is FDA approved for certain pharmaceutical and food applications. Contact us for specific details.

Available Materials:



- 1/8" ABS
- 1/8" ABS Metal Detectable

Available Options:

- Gaskets



4-Bolt Flange Bearing Cover - Heavyweight

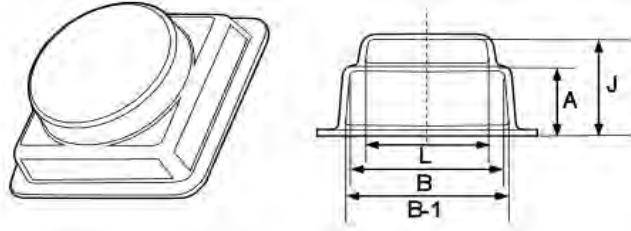

All dimensions measured in inches

Part Number	Width "B"	Width "B1"	Cover Height "A"	Shaft Height "J"	Inside Diameter "L"				
4BDSC204H	3 1/4	3 7/16	1 1/2	2	2				
4BSMSF15	4	3 3/4	2	3	2				
4BDSC205H	4 1/16	4 1/4	1 1/2	2	2				
4BDSC206H	4 3/8	4 5/8	1 3/4	2	2				
4BHCRX 1-7/16H	4 3/8	4 5/8	2	3	3 1/4				
4BDSC207H	4 9/16	4 13/16	1 1/2	3	3 1/2				
4BDSC208H	5	5 1/4	1 3/4	3	3 3/8				
4BDSC209H	5 1/4	5 3/8	2	3 1/2	3 3/8				
4BBVF4S-227H	5 1/4	5 3/8	1 5/16	2 5/16	2 1/2				
4BSMSFB2115H	5 9/16	5 3/4	1 1/2	2 15/16	4 3/4				
4BDE-1-11/16H	5 3/16	5 1/2	2 1/2	4	4				
4BDSC210 ETH	5 3/16	5 1/2	2 1/2	2 15/16	4				
4BNUCF209H	5 3/8	5 5/8	2 1/2	3 1/2	3 11/16				
4BHCRX 1-15/16H	5 7/16	5 11/16	1 3/4	3	5 1/8				
4BDSC211H	6 1/2	6 13/16	2 1/8	4	4 7/16				
4BHCRX 2-3/16H	6 3/8	6 11/16	2	3	4 15/16				
4BDSC212H	6 13/16	7	2 1/4	3	3 3/8				
4BHCRX 2-7/16H	6 5/8	7	3	4	5				
4BSMSF-39H	7 1/8	7 3/8	3	4	6				
4BBVF4S-347H	7 11/16	7 7/8	2 3/16	4	6 9/16				
4BDSC215H	7 11/16	8	2 1/2	5 1/4	5 3/8				
4BDSC218H-Tall	8 1/8	8 1/2	2 15/16	5 1/2	6 7/16				
4BDSC218H-Short	8	8 3/8	2 5/16	2 7/8	6 9/16				
4BDE 2-7/16H	10 7/16	10 15/16	3	6	6				
4BDE 3-7/16H	10 1/8	10 3/4	6	9	7 3/16				

Guards are measured from the SMALLEST INTERIOR POINT unless specified.

- For covering 4-bolt flange bearings.
- For installation instructions, see 'How to Install a Flange Bearing Cover' on Page 37.
- For tall shafts, height can be added just to the round top part of the cover.
- If you do not see what you are looking for, give us a call!

Available Materials:

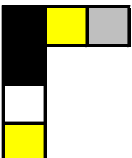

- 3/16" ABS
- 1/4" ABS
- 3/16" transparent PETG
- 1/4" Kydex

Available Options:

- Gaskets



4-Bolt Flange Bearing Cover - Lightweight

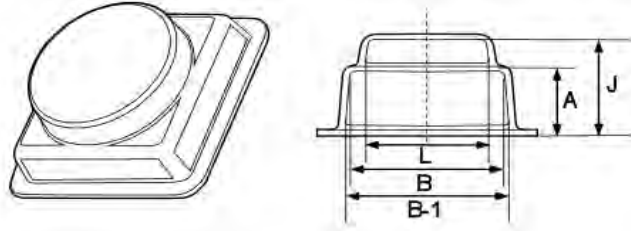

All dimensions measured in inches

Part Number	Width "B"	Width "B1"	Cover Height "A"	Shaft Height "J"	Inside Diameter "L"			
4BDSC204L	3 1/4	3 7/16	1 1/2	2	2			
4BDSC205L	4 1/16	4 1/4	1 1/2	2	2			
4BDSC206L	4	4 1/4	1 1/2	2	2			
4BHCRX 1-7/16L	4 3/8	4 5/8	2	3	3 1/4			
4BDSC207L	4 9/16	4 13/16	1 1/2	3	3 1/2			
4BDSC208L	5	5 1/4	1 3/4	3	3 3/8			
4BDSC209L	5 1/4	5 3/8	2	3 1/2	3 3/8			

Guards are measured from the SMALLEST INTERIOR POINT unless specified.

- For covering 4-bolt flange bearings.
- For installation instructions, see 'How to Install a Flange Bearing Cover' on Page 37.
- For tall shafts, height can be added just to the round top part of the cover.
- Lightweight Guards are designed for non-abusive environments.
- If you do not see what you are looking for, give us a call!
- Our metal detectable ABS plastic is FDA approved for certain pharmaceutical and food applications. Contact us for specific details.

Available Materials:



- 1/8" ABS
- 1/8" ABS Metal Detectable

Available Options:

- Gaskets



**3-Bolt Flange Bracket Bearing Cover**

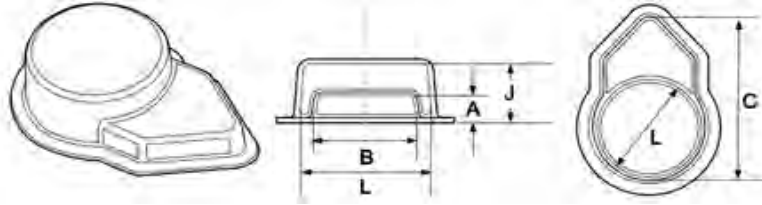

All dimensions measured in inches

Part Number	Length "C"	Width "B"	Cover Height "A"	Shaft Height "J"	Inside Diameter "L"				
3BOSAMIUCFB201	4 1/2	2 1/2	1 1/8	2 1/4	1 3/8				
3BOKLM206	5 3/4	3	1 1/2	2 1/4	3 1/2				
3BOSMF23	6	3 3/4	1 1/2	2 1/2	3 3/4				
3BOSMF31	7 1/2	4	1 1/2	3	4 1/2				

**Guards are measured from the SMALLEST INTERIOR POINT unless specified.**

- For covering 3-bolt flange bracket bearings.
- If you do not see what you are looking for, give us a call!

Available Materials:

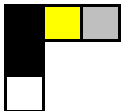

- 3/16" ABS
- 1/4" ABS
- 3/16" transparent PETG

Available Options:

- Gaskets

**4-Bolt Flange Bracket Bearing Cover**

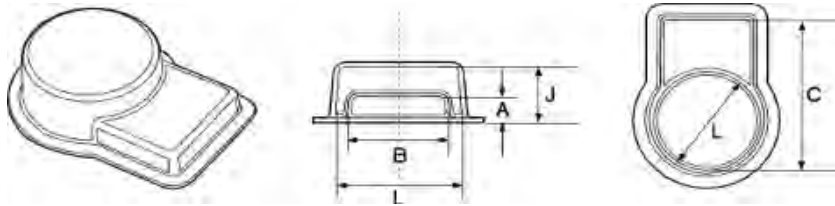

All dimensions measured in inches

Part Number	Length "C"	Width "B"	Cover Height "A"	Shaft Height "J"	Inside Diameter "L"				
4BOSMSBF2207	9 1/4	6	1 1/2	3	5 3/4				

**Guards are measured from the SMALLEST INTERIOR POINT unless specified.**

- For covering 4-bolt flange bracket bearings.
- If you do not see what you are looking for, give us a call!

Available Materials:

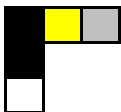

- 3/16" ABS
- 1/4" ABS
- 3/16" transparent PETG

Available Options:

- Gaskets



Machine Guard & Cover Co.

We've Got You Covered!

# Pillow Block Cover Request Sheet

Supply information in the 5 circles provided:

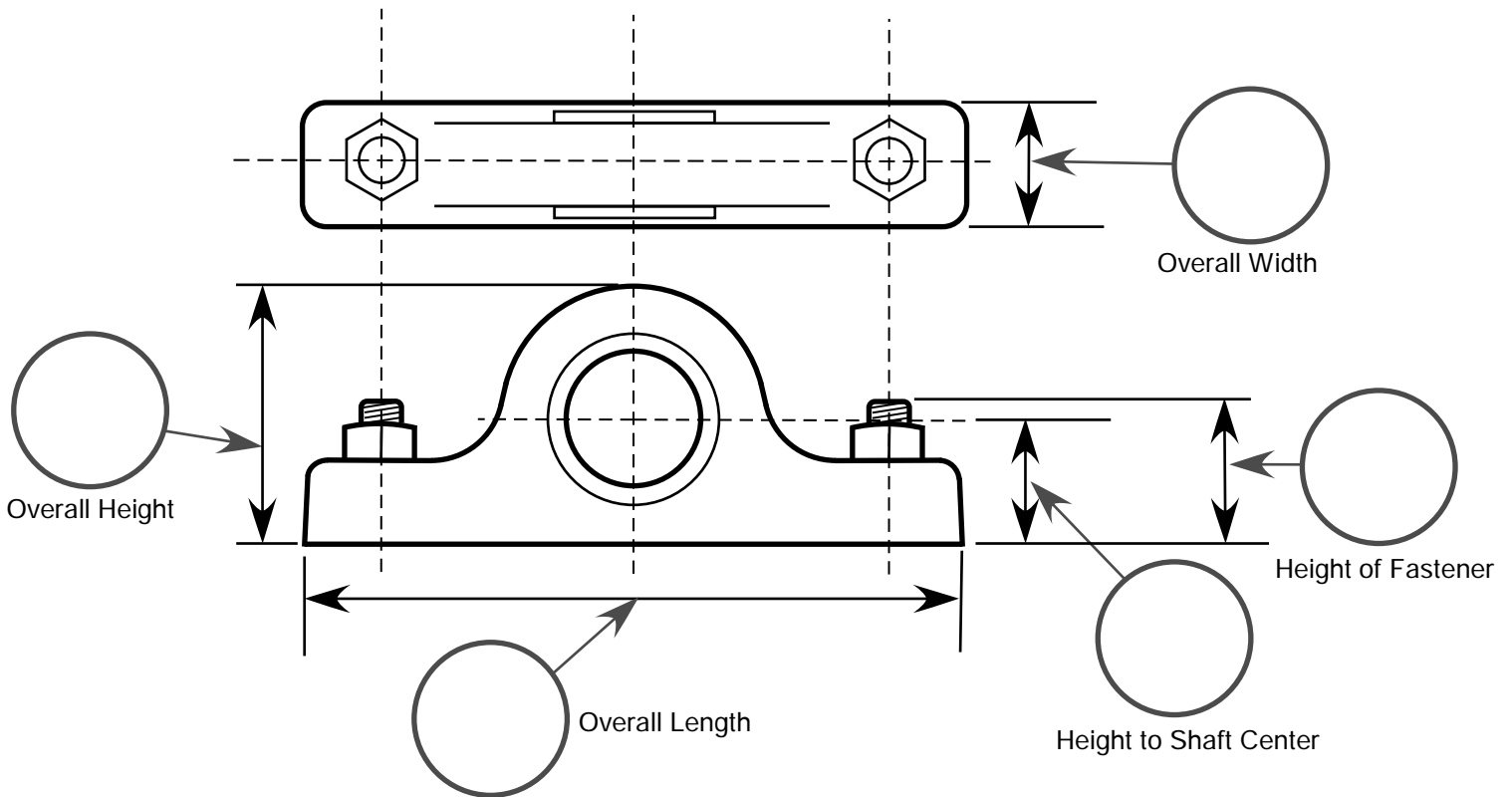

Use the second sheet for more information

Other Features:

Company: \_\_\_\_\_ Contact e-mail: \_\_\_\_\_

Name: \_\_\_\_\_ Contact phone: \_\_\_\_\_

e-mail or FAX this sheet to:

www.machineguard.com  
office@machineguard.com  
Fax: 877-482-7313



**Machine Guard & Cover Co.**

6187 136th Avenue  
Holland, MI 49424  
888 - 482-7371



# Pillow Block Cover Request Sheet 2

Supply information in the 3 circles as required:

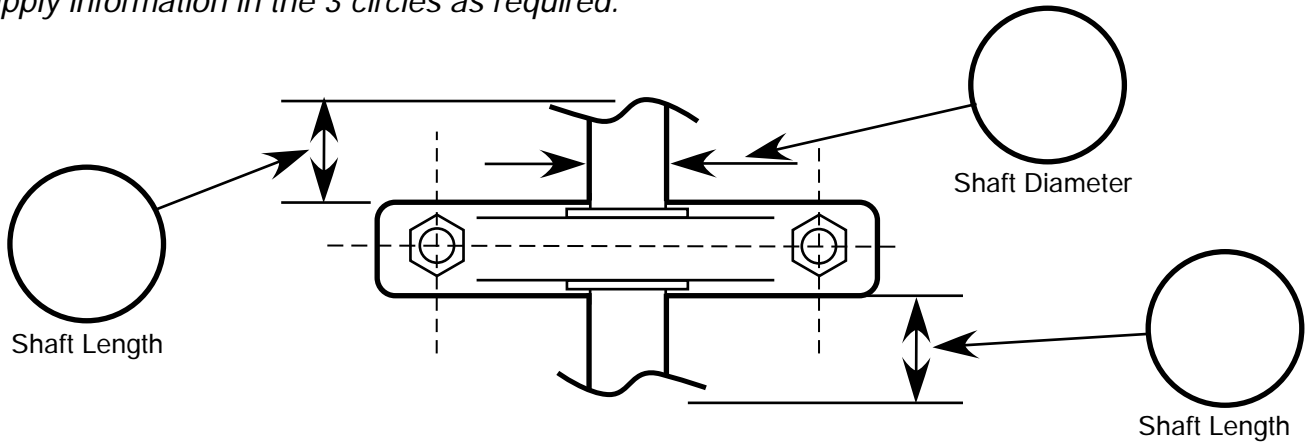

Supply information in the 2 circles if required:

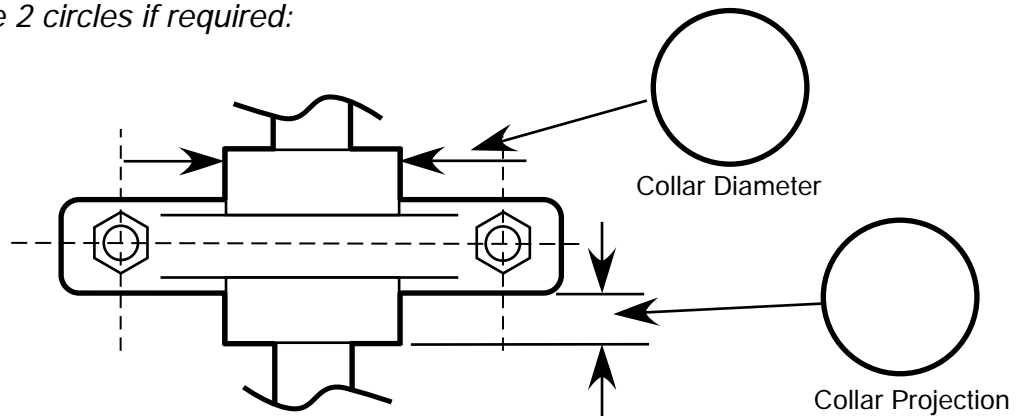

Grease Fitting:

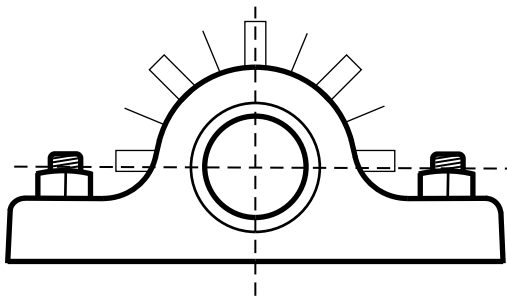

Note the position of any grease fittings by marking a box in the bearing drawing.

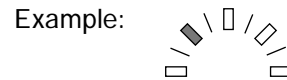





**Pillow Block Bearing Cover - Heavyweight**

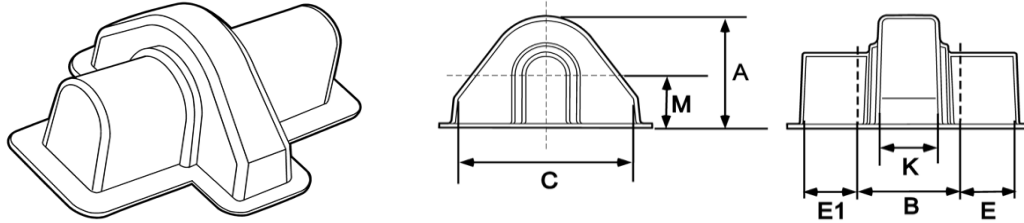

All dimensions measured in inches

Part Number	Height "A"	Overall Width "B"	Center Width "K"	Length "C"	Height to Center "M"	Optional Ext. "E"	Optional Ext. "E1"			
PBDS-203H	2 7/8	2 1/2	1 1/4	5 1/8	1 1/8	Optional	Optional			
PBDSC-204H	3	2 3/4	1 3/8	5 3/8	1 1/4	Optional	Optional			
PBDSC-205H	3 1/4	3 1/8	1 1/2	5 5/8	1 7/16	Optional	Optional			
PBDSC206H	3 3/4	4 1/8	1 5/8	6 3/8	1 3/4	Optional	Optional			
*PBDSC207H	3 3/4	4 1/8	2	6 3/4	1 7/8	Optional	Optional			
PBFT40242H	3 3/4	4 1/8	2	6 3/4	1 7/8	Optional	Optional			
PBPUC208H	4 3/8	3 5/8	2 1/8	7 1/8	2	Optional	Optional			
PBSMMP31H	5	8	2 1/2	9 3/4	2 3/4	Optional	Optional			
PBDP2BSC108H	5 1/4	4 3/4	2 7/8	7 7/8	2 3/8	Optional	Optional			
PBSMMP175H	5 1/8	5	2 7/8	8 7/8	2 3/8	Optional	Optional			
PBDS2-207H	6 1/8	5 3/8	2 7/8	9 3/8	3	Optional	Optional			
PBFT18808H	6 3/4	4 1/4	3 3/8	12 3/8	3 5/16	2, std	0, std			
PBDS2-211H	7	6	3 1/4	10 3/4	3 3/8	Optional	Optional			
PBDSC215H	7 3/4	4 1/4	2 7/8	12 1/4	3 1/2	Optional	Optional			
PBD2218H	8 9/16	5 7/16	5 7/16	13 9/16	3 3/4	4 7/16	4 7/16			
PBD2220H	9	4 1/2	4 1/2	15 3/4	4 1/4	4 3/16	4 3/16			
PBD2222H	10	5 1/4	5 1/4	17	4 3/4	4	4			
PBD2226H	12	6 1/4	6 1/4	19 1/2	7	4	4			
PBD2228H	14	6 3/4	6 3/4	22 1/2	8	4 1/2	4 1/2			
PBD2236H	16	7 3/4	7 3/4	27	10	5 1/2	5 1/2			

Guards are measured from the SMALLEST INTERIOR POINT unless specified.

- For covering pillow block bearings.
  - One or both ends of the guard can be opened for a through shaft.
  - For installation instructions, see 'How to Install a Flange Bearing Cover' on Page 37.
  - All dimensions are measured from the inside at the smallest point.
  - Dimensions E and E1 are optional extensions. Please call for further information.
- \* Guards is available in the Skabbard configuration for integration with shaft covers.
- If you do not see what you are looking for, give us a call!

Available Materials:

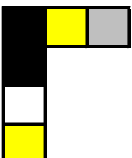

- 3/16" ABS
- 1/4" ABS
- 3/16" transparent PETG
- 1/4" Kydex

Available Options:

- Gaskets



Pillow Block Bearing Cover - Lightweight

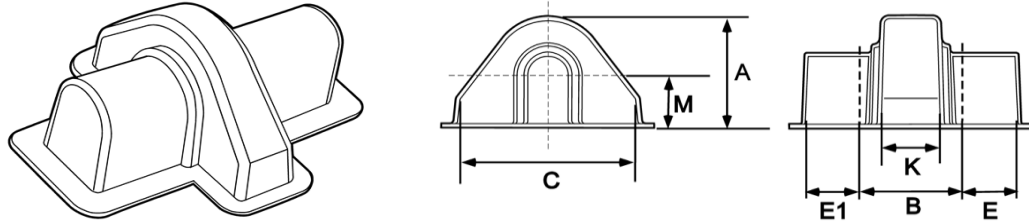

All dimensions measured in inches

Part Number	Height "A"	Overall Width "B"	Center Width "K"	Length "C"	Height to Center "M"					
PBDS-203L	2 7/8	2 1/2	1 1/4	5 1/8	1 1/8					
PBDSC-204L	3	2 3/4	1 3/8	5 3/8	1 1/4					
PBDSC-205L	3 1/4	3 1/8	1 1/2	5 5/8	1 7/16					

Guards are measured from the SMALLEST INTERIOR POINT unless specified.

- For covering pillow block bearings.
- One or both ends of the guard can be opened for a through shaft.
- Pillow Block Bearing Covers may be installed using similar installation methods as shown on Page 35.
- Lightweight Guards are designed for non-abusive environments.
- If you do not see what you are looking for, give us a call!
- Our metal detectable ABS plastic is FDA approved for certain pharmaceutical and food applications. Contact us for specific details.

Available Materials:

-  1/8" ABS
-  1/8" ABS Metal Detectable

Available Options:

Gaskets



Plummer Pillow Block Bearing Cover

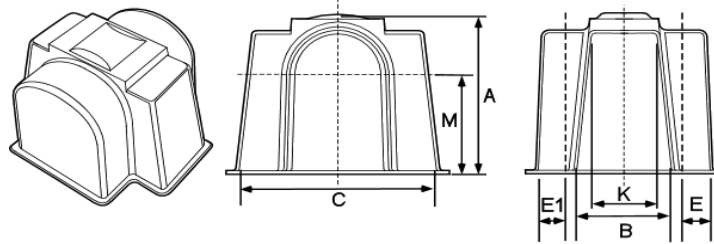

All dimensions measured in inches

Part Number	Height "A"	Overall Width "B"	Center Width "K"	Length "C"	Height to Center "M"	Ext. "E"	Ext. "E1"			
PBSMRPB203	5 1/8	5	3 1/4	10	2 1/2	2 1/8	2 1/8			
PBSKFSNL516-613	7 1/4	5 1/2	4 11/16	12 15/16	3 3/4	2 3/16	2 3/16			
PBSKFSNL522-619	9 11/16	6 1/2	5 3/16	16 9/16	4 15/16	2 5/8	2 5/8			
PBSKFSNL-526	11 5/8	7 1/4	5 11/16	18 3/8	5 15/16	3 1/4	3 1/4			

Guards are measured from the SMALLEST INTERIOR POINT unless specified.

For covering plummer style pillow block bearings.

- For covering plummer style pillow block bearings.
- One or both ends of the guard can be opened for a through shaft.
- Pillow Block Bearing Covers may be installed using similar installation methods as shown on Page 35.
- If you do not see what you are looking for, give us a call!

Available Materials:

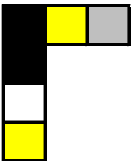

- 3/16" ABS
- 1/4" ABS
- 3/16" transparent PETG
- 1/4" Kydex



**Plummer Pillow Block Bearing Cover, Skabbard™**

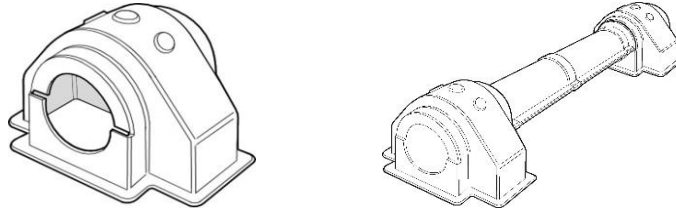

All dimensions measured in inches

Part Number	Height "A"	Overall Width "B"	Center Width "K"	Length "C"	Height to Center "M"	Matching Shaft Dia.				
SPBDSC207	4 1/8	3	2 1/2	6 7/8	1 7/8	2 1/2				
SPBDSC208	4 3/8	3 1/2	2 9/16	7 1/2	2					
SPBSKFSNL516	7 5/8	3 5/8	5 13/16	12 5/8	3 3/4					
SPBDSC210	5	3 1/2	3	8 5/16	2 1/4	3 1/2				

Guards are measured from the SMALLEST INTERIOR POINT unless specified.

- Skabbard™ Pillow Block Covers integrate with the MGC shaft cover line to completely enclose the bearing and shaft.
- One or both ends of the guard can be opened for a through shaft.
- Skabbard™ Pillow Block Bearing Covers may be installed using similar installation methods as shown on Page 35.
- If you do not see what you are looking for, give us a call!

Available Materials:

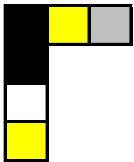

- 3/16" ABS
- 1/4" ABS
- 3/16" transparent PETG
- 1/4" Kydex



Take-Up Bearing Covers

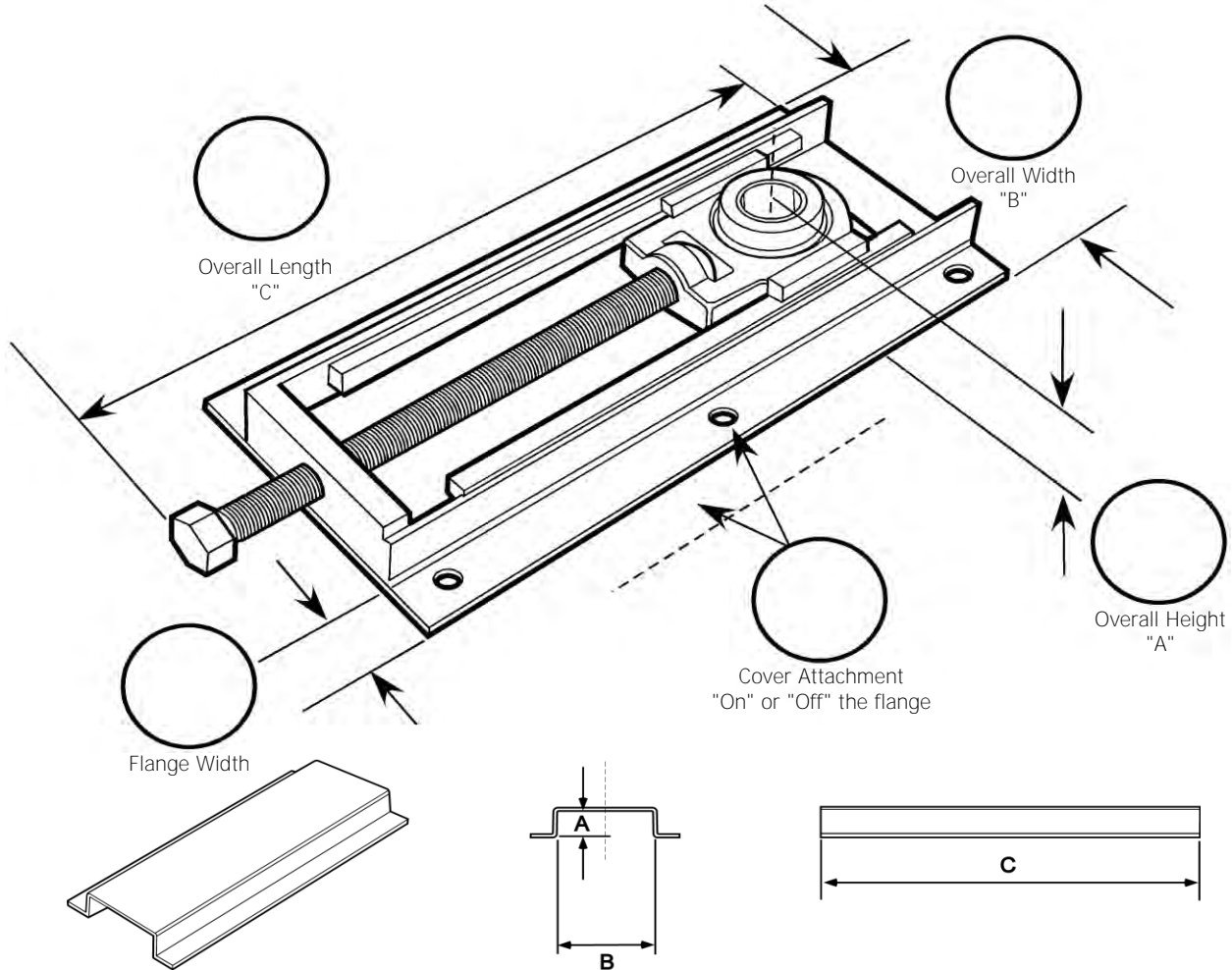

All dimensions measured in inches

Example Part Numbers	Height "A"	Width "B"	Length "C"					
TBC3x4x6	3	4	6					
TBC10x16x48	10	16	48					

Take-Up Bearing Covers

- Covers the bearing and the adjustment mechanism.
- The standard flange for Take-Up Bearing Covers is 1".
- Sizes listed are suggestions, please call for quote.
- The maximum Length for a TBC Guard is 48".  
(Flange(x2) + Height(x2) + Width) cannot be more than 96"
- TBC Guards can have one or both ends closed as an option.

Available Materials:

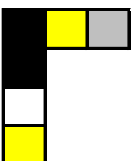

- 3/16" ABS
- 1/4" ABS
- 3/16" transparent PETG
- 1/4" Kydex



Machine Guard & Cover Co.

We've Got You Covered!

# Horizontal Shaft Cover Request Sheet

Add dimensions in the circles provided:

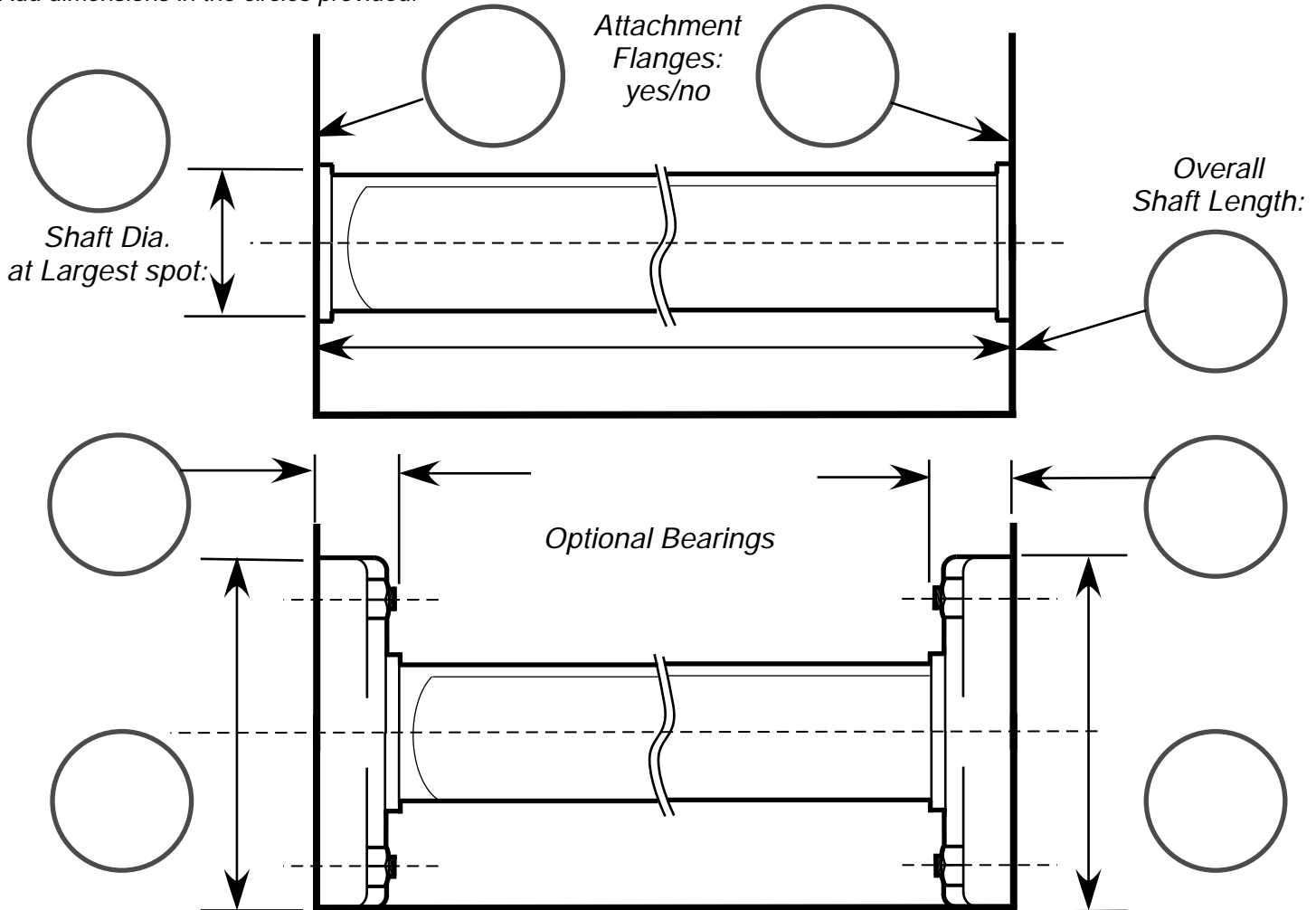

Other Features: Add a picture of the installed shaft if possible:

Company: \_\_\_\_\_ Contact e-mail: \_\_\_\_\_

Name: \_\_\_\_\_ Contact phone: \_\_\_\_\_

e-mail or FAX this sheet to:

www.machineguard.com  
office@machineguard.com  
Fax: 877-482-7313



Machine Guard & Cover Co.

6187 136th Avenue  
Holland, MI 49424  
888 - 482-7371



**Machine Guard & Cover Co.**

*We've Got You Covered!*

# Vertical Shaft Cover Request Sheet

Add dimensions in the circles provided:

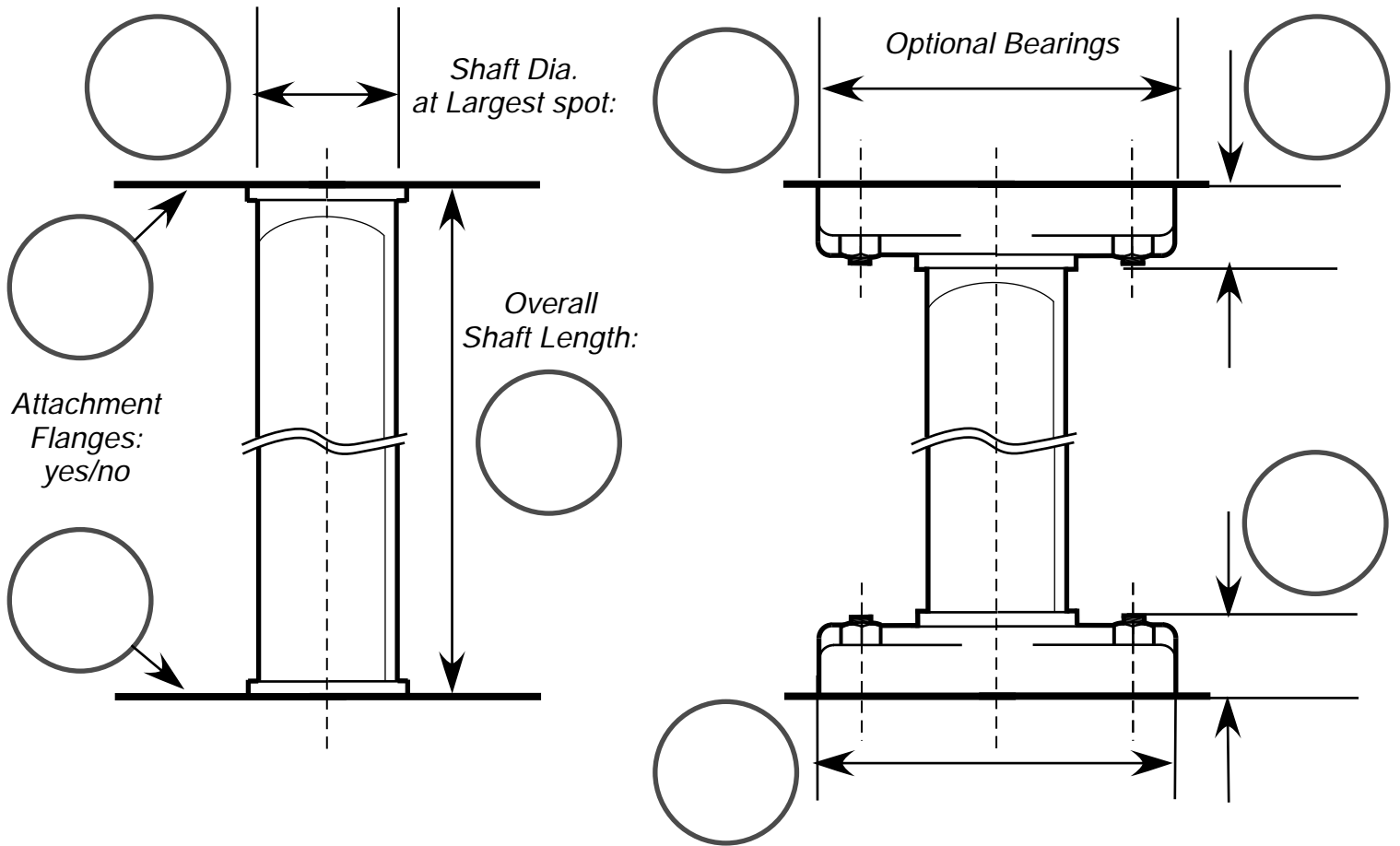

Other Features: Add a picture of the installed shaft if possible:

Company: \_\_\_\_\_ Contact e-mail: \_\_\_\_\_

Name: \_\_\_\_\_ Contact phone: \_\_\_\_\_

e-mail or FAX this sheet to:

www.machineguard.com  
office@machineguard.com  
Fax: 877-482-7313



**Machine Guard & Cover Co.**

6187 136th Avenue  
Holland, MI 49424  
888 - 482-7371



**Bearing Shaft Covers - Heavyweight**

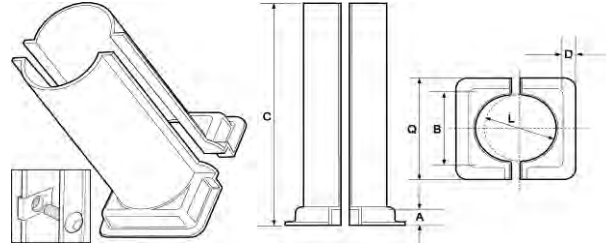

All dimensions measured in inches

Part Number	Height "A"	Width "B"	Maximum Length "C"	Flange "D"	Diameter "L"	Overall Flange Width "Q"	# of SCF
BSC5.618H	1 1/4	5 11/16	18	15/16	5 1/4	7 5/8	4
BSC7.118.5H	1 1/4	7 1/8	18 1/2	13/16	5 1/4	8 13/16	4
BSC8.418.5H	2 15/16	8 7/16	18 1/2	3/4	6 1/2	10	4

Guards are measured from the SMALLEST INTERIOR POINT unless specified.

**Key Features:**

- The BSC family of shaft covers is designed to cover exposed rotating shafts and attached bearing.
- Modeled to fit over a 4-bolt bearing, but can accommodate other flange bearing and shaft assemblies.
- Length "C" can easily be modified for your custom installation.
- Additional sizes are available, contact us for additional information.
- The BSC series of guards includes Safety Captured Fasteners.

**Available Materials:**

	3/16" ABS
	1/4" ABS
	3/16" transparent PETG
	1/4" Kydex





**Flanged Shaft Covers - Heavyweight**

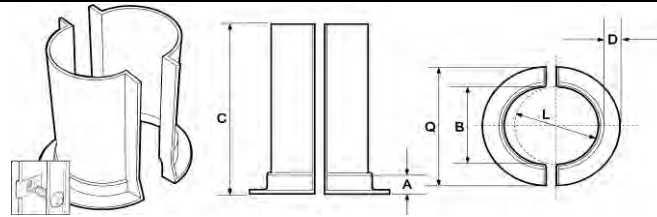

All dimensions measured in inches

Part Number	Height "A"	Width "B"	Maximum Length "C"	Flange "D"	Diameter "L"	Overall Flange Width "Q"	# of SCF
FSC0212H	3/4	2	12	3/4	2	4	4
FSC0223.5H	3/4	2	23 1/2	3/4	2	4	6
FSC0312H	3/4	3	12	3/4	3	5	4
FSC0323.5H	3/4	3	23 1/2	3/4	3	5	6
FSC0412H	3/4	4	12	3/4	3	5	4
FSC0423.5H	3/4	4	23 1/2	3/4	3	5	6
FSC04.509.5H	1 1/4	4 1/2	9 1/2	1 1/2	4 1/2	7	4
FSC0712H	1	7	12	1	7	10	4
FSC0723.5H	1	7	23 1/2	1	7	10	6
FSC0812H	1	8 1/4	12	1	8	10 1/4	4
FSC0823.5H	1	8 1/4	12	1	8	10 1/4	4
FSC1016HH	2	10 1/4	16	1	10	12 1/4	4
FSC1031.5H	2	10 1/4	31 1/2	1	10	12 1/4	8
FSC0924H	0	9 1/4	7 3/16	2 1/4	9 1/4	13 3/4	4
FSC1132H	0	11 1/2	8 1/4	1 1/4	11 1/2	14	4
FSC1416H*	1	14	15 3/4	1	14	17	8
FSC1431.5H*	1	14	31 1/2	1	14	17	16
FSC1616H	2	16 1/4	16	1	16	18 1/4	4
FSC1631.5H	2	16 1/4	31 1/2	1	16	18 1/4	8
FSC1818H	1	18	18	1	18	21	4
FSC1835.5H	1	18	35 1/2	1	18	21	8
FSC2816H*	1 1/4	28	16	1 1/4	28	32	8
FSC2831.5H*	1 1/4	28	31 1/2	1 1/4	28	32	16
FSC3821.5H*	1	38	21 1/2	1	38	41	8
FSC3841.5H*	1	38	41 1/2	1	38	41	20

Guards are measured from the SMALLEST INTERIOR POINT unless specified.

- The FSC family of shaft covers have a mounting flange on one end and are designed to cover exposed rotating shafts.
- Length "C" can easily be modified for your custom installation.
- \*Denotes four pieces are required to create a complete guard.
- Additional sizes are available, contact us for additional information.
- The FSC series of guards includes Safety Captured Fasteners.

Available Materials:

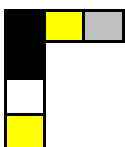

- 3/16" ABS
- 1/4" ABS
- 3/16" transparent PETG
- 1/4" Kydex



**Flanged Shaft Covers - Lightweight**

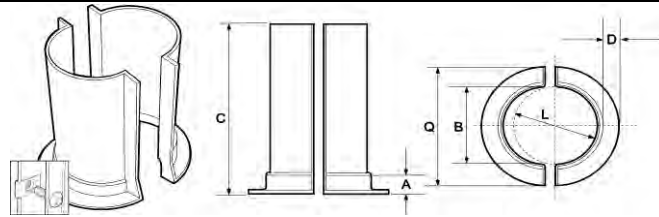

All dimensions measured in inches



Part Number	Height "A"	Width "B"	Maximum Length "C"	Flange "D"	Diameter "L"	Overall Flange Width "Q"	# of SCF
FSC0212L	3/4	2	12	3/4	2	4	4
FSC0223.5L	3/4	2	23 1/2	3/4	2	4	6
FSC0312L	3/4	3	12	3/4	3	5	4
FSC0323.5L	3/4	3	23 1/2	3/4	3	5	6
FSC0412L	3/4	4	12	3/4	3	5	4
FSC0423.5L	3/4	4	23 1/2	3/4	3	5	6
FSC04.509.5L	1 1/4	4 1/2	9 1/2	1 1/2	4 1/2	7	4

Guards are measured from the SMALLEST INTERIOR POINT unless specified.

**Product Features:**

- The FSC family of shaft covers have a mounting flange on one end and are designed to cover exposed rotating shafts.
- Length "C" can easily be modified for your custom installation.
- Additional sizes are available, contact us for additional information.
- The FSC series of guards includes Safety Captured Fasteners.

**Available Materials:**

-  1/8" ABS
-  1/8" ABS Metal Detectable



**Double Flanged Shaft Covers - Heavyweight**

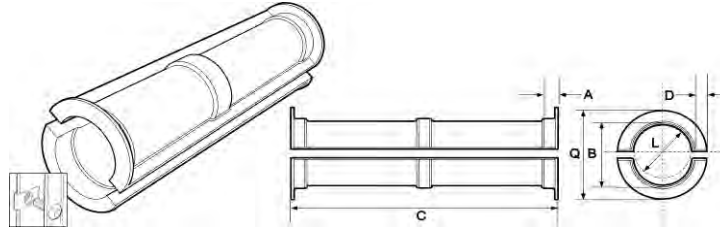

All dimensions measured in inches

Part Number	Height "A"	Width "B"	Maximum Length "C"	Flange "D"	Diameter "L"	Overall Flange Width "Q"	# of SCF
DFSC0224H	3/4	2	24	3/4	2	4	6
DFSC0324H	3/4	3	24	3/4	3	5	6
DFSC0424H	3/4	4	24	3/4	4	6	6
DFSC0724H	1	7	24	1	7	10	6
DFSC0824H	1	8	24	1	8	24	6
DFSC1032H	2	10 1/4	32	1	10	12 1/4	8
DFSC1132H	2	11	32	1	11	13	8
DFSC1432H	1	14	32	1	14	17	16
DFSC1632H	2	16 1/4	32	1	16	18 1/4	8
DFSC1836H	1	18	36	1	18	21	8
DFSC2232H	1	22	32	1	22	25	8
DFSC2832H*	1 1/4	28	32	1 1/4	28	32	16
DFSC3842H*	1	38	42	1	38	41	20

Guards are measured from the SMALLEST INTERIOR POINT unless specified.

- The DFSC family of shaft covers have a mounting flange on both ends and are designed to cover exposed rotating shafts.
- Length "C" can easily be modified for your custom installation by connecting multiple covers.

\*Denotes four pieces are required to create a complete guard.

- Additional sizes are available, contact us for additional information.
- The DFSC series of guards includes Safety Captured Fasteners.

Available Materials:

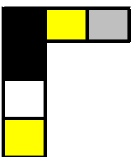

- 3/16" ABS
- 1/4" ABS
- 3/16" transparent PETG
- 1/4" Kydex



**Double Flanged Shaft Covers - Lightweight**

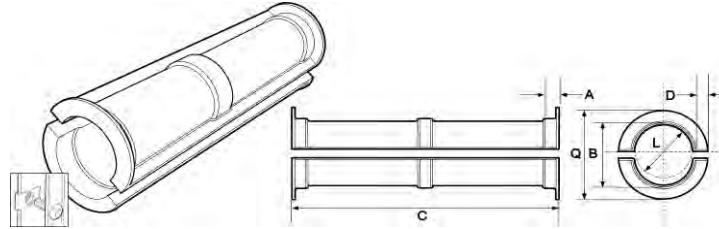

All dimensions measured in inches



Part Number	Height "A"	Width "B"	Maximum Length "C"	Flange "D"	Diameter "L"	Overall Flange Width "Q"	# of SCF
DFSC0224L	3/4	2	24	3/4	2	4	6
DFSC0324L	3/4	3	24	3/4	3	5	6
DFSC0424L	3/4	4	24	3/4	4	6	6

Guards are measured from the SMALLEST INTERIOR POINT unless specified.

**Product Information**

- The DFSC family of shaft covers have a mounting flange on both ends and are designed to cover exposed rotating shafts.
- Length "C" can easily be modified for your custom installation by connecting multiple covers.
- \*Denotes four pieces are required to create a complete guard.
- Additional sizes are available, contact us for additional information.
- The DFSC series of guards includes Safety Captured Fasteners.

**Available Materials:**

-  1/8" ABS
-  1/8" ABS Metal Detectable



Round Flanged Covers (Bearing Caps) - Heavyweight

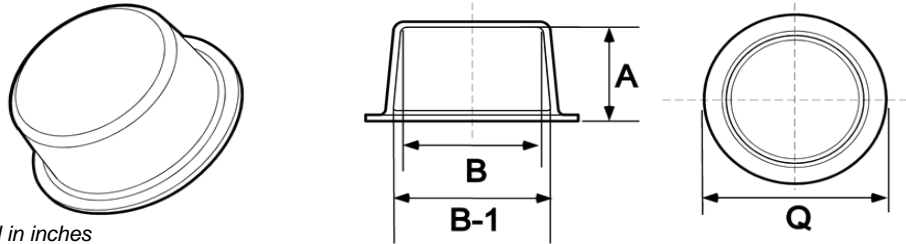

All dimensions measured in inches

Part Number	Height "A"	Diameter at Bottom "B-1"	Diameter at Top "B"	Flange-to-Flange "Q"			
BC0.25x3H	1/4	3	3	4 1/4			
BC0.7x2.4H	11/16	2 1/2	2 3/8	4			
BC0.75x2.6H	3/4	2 11/16	2 9/16	4 3/16			
BC0.75x4H	3/4	4 1/8	4	5 5/8			
BC0.75x4.5H	3/4	5 5/8	4 1/2	7 1/8			
BC0.75x5H	3/4	5 1/8	5 1/16	6 5/8			
BC1.0x1.8H	1	1 7/8	1 3/4	3 3/8			
BC1.0x2.5H	1	2 1/2	2 1/2	4			
BC1.0x2.8H	1	3	2 3/4	4 1/2			
BC1.0x3.7H	1	3 3/4	3 11/16	5 1/4			
BC1.1x4.9H	1 1/8	4 7/8	3 3/4	5 1/4			
BC1.4x8.5H	1 3/8	8 1/2	8 1/2	10			
BC1.5x2.6H	1 1/2	2 3/4	2 1/2	4 1/4			
BC1.75x3.6H	1 11/16	3 11/16	3 9/16	5 3/16			
BC1.7x4.3H	1 11/16	4 3/8	4 1/4	5 7/8			
BC2.0x1.7H	2	1 3/4	1 11/16	3 1/4			
BC2.0x2.8H	2	3 1/16	2 3/4	4 9/16			
BC2.0x3.8H	2	3 15/16	3 13/16	5 7/16			
BC2.0x4H	2	4 1/4	4	5 3/4			
BC2.0x5.9H	2	6 1/16	5 7/8	7 9/16			
BC2.0x6.9H	2	7 1/16	6 7/8	8 9/16			
BC2.5x2.4H	2 1/2	2 5/8	2 3/8	4 3/16			
BC2.5x4.7H	2 1/2	4 3/4	4 11/16	6 1/4			
BC2.5x7.3H	2 1/2	7 9/16	7 1/4	9 1/16			
BC2.6x2.9H	2 9/16	3 1/16	2 7/8	4 9/16			



BC2.6x12.2H	2 9/16	12 1/2	12 3/16	14			
BC2.81x3.1H	2 3/4	3 1/4	3 1/16	4 3/4			
BC3.0x2H	3	2 3/8	2	3 7/8			
BC3.0x3.2H	3	3 9/16	3 3/16	5 1/16			
BC3.0x4.4H	3	4 3/4	4 3/8	6 1/4			
BC3.0x4.7H	3	5	4 11/16	6 1/2			
BC3.0x5.4H	3	5 11/16	5 3/8	7 3/16			
BC3.9x4.2H	3 7/8	5	4 3/16	6 1/2			
BC3.9x4.8H	3 7/8	5 1/2	4 3/4	7			
BC3.94x30H	3 7/8	30 1/2	30	32			
BC3.94x35H	3 7/8	35 1/2	35	37			
BC4.0x3.5H	4	4 1/16	3 1/2	5 9/16			
BC4.0x4.2H	4	4 7/8	4 1/4	6 3/8			
BC4.0x7H	4	7 1/4	7	8 3/4			
BC4x7.8H	4	8 1/4	7 3/4	9 3/4			
BC4.7x6.7H	4 11/16	7 1/2	6 1/4	9			
BC4.7x7.3H	4 11/16	8	7 1/4	9 1/2			
BC5.0x15.1H	5	15 1/2	15 1/16	17			
BC5.1x8.4H	5 1/16	9 1/4	8 3/8	10 3/4			

Guards are measured from the SMALLEST INTERIOR POINT unless specified.

- Round Flanged Covers can be used to cover protruding shafts and gears.
- Round Flanged Covers can be manufactured to gain significant extra height by stacking.
- For installation instructions, see 'How to Install a Flange Bearing Cover' on Page 37.
- Custom size flanges to adjust dimension "Q" are available upon special request.
- If you do not see what you are looking for, give us a call!

Available Materials:

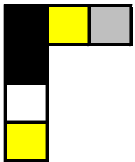

- 3/16" ABS
- 1/4" ABS
- 3/16" transparent PETG
- 1/4" Kydex

Available Options:

- Gaskets



Round Flanged Covers (Bearing Caps) - Lightweight

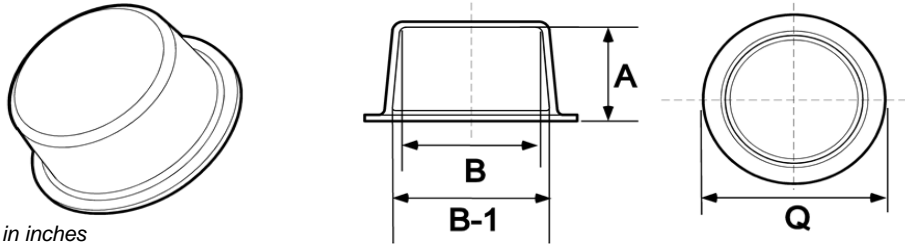



All dimensions measured in inches

Part Number	Height "A"	Diameter at Bottom "B-1"	Diameter at Top "B"	Flange-to-Flange "Q"			
BC0.25x3L	1/4	3	3	4 1/2			
BC0.7x2.4L	11/16	2 1/2	2 3/8	4			
BC0.75x2.6L	3/4	2 11/16	2 9/16	4 3/16			
BC0.75x4L	3/4	4 1/8	4	5 5/8			
BC0.75x4.5L	3/4	5 5/8	4 1/2	7 1/8			
BC0.75x5L	3/4	5 1/8	5 1/16	6 5/8			
BC1.0x1.8L	1	1 7/8	1 3/4	3 3/8			
BC1.0x2.5L	1	2 1/2	2 1/2	4			
BC1.0x2.8L	1	3	2 3/4	4 1/2			
BC1.0x3.7L	1	3 3/4	3 11/16	5 1/4			
BC1.1x4.9L	1 1/8	4 7/8	3 3/4	5 1/4			
BC1.4x8.5L	1 3/8	8 1/2	8 1/2	10			
BC1.5x2.6L	1 1/2	2 3/4	2 1/2	4 1/4			
BC1.75x3.6L	1 11/16	3 11/16	3 9/16	5 3/16			
BC1.7x4.3L	1 11/16	4 3/8	4 1/4	5 7/8			
BC2.0x1.7L	2	1 3/4	1 11/16	3 1/4			
BC2.0x2.8L	2	3 1/16	2 3/4	4 9/16			
BC2.0x3.8L	2	3 15/16	3 13/16	5 7/16			
BC2.0x4L	2	4 1/4	4	5 3/4			
BC2.0x5.9L	2	6 1/16	5 7/8	7 9/16			
BC2.0x6.9L	2	7 1/16	6 7/8	8 9/16			

- Round Flanged Covers can be used to cover protruding shafts and gears.
- Round Flanged Covers can be manufactured to gain significant extra height by stacking.
- For installation instructions, see 'How to Install a Flange Bearing Cover' on Page 37.
- Custom size flanges to adjust dimension "Q" are available upon special request.
- Lightweight Guards are designed for non-abusive environments.
- If you do not see what you are looking for, give us a call!
- Our metal detectable ABS plastic is FDA approved for certain pharmaceutical and food applications. Contact us for specific details.

Available Materials:

-  1/8" ABS
-  1/8" ABS Metal Detectable

Available Options:

- Gaskets



Split Round Flanged Covers

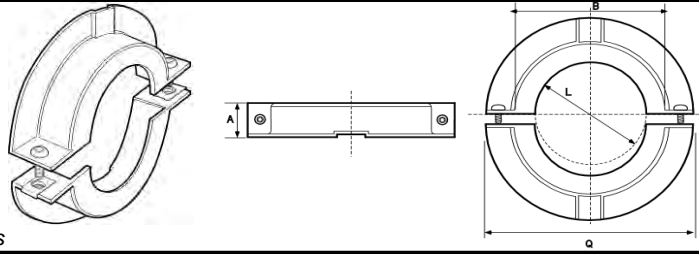

All dimensions measured in inches

Part Number	Height "A"	Diameter "B"	Center Cut Out Max "L"	Flange-to-Flange "Q"	Flange Width "D"		
SPR0.75x6	3/4	6	5	7 3/4	7/8		
SPR0.875x3	7/8	3	2	4 3/4	7/8		
SPR1x6	1	6	5	7 3/4	7/8		
SPR1.25x6	1 1/4	6	5	7 3/4	7/8		
SPR1.25x10	1 1/4	10	9	11 3/4	7/8		
SPR1.5x6	1 1/2	6	5	7 3/4	7/8		
SPR1.5x10	1 1/2	10	9	11 3/4	7/8		
SPR1.75x6	1 3/4	6	5	7 3/4	7/8		
SPR1.75x10	1 3/4	10	9	11 3/4	7/8		





Split Round Flanged Covers

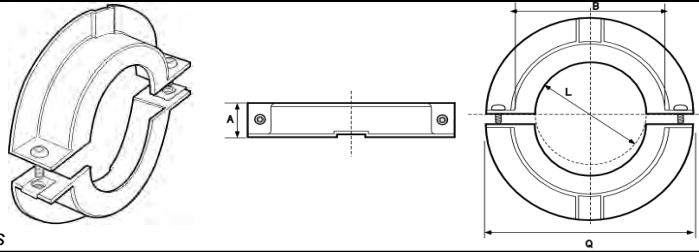

All dimensions measured in inches

Part Number	Height "A"	Diameter "B"	Center Cut Out Max "L"	Flange-to-Flange "Q"	Flange Width "D"		
SPR2x6	2	6	5	7 3/4	7/8		
SPR2x10	2	10	9	11 3/4	7/8		
SPR2.25x6	2 1/4	6	5	7 3/4	7/8		
SPR2.25x10	2 1/4	10	9	11 3/4	7/8		
SPR2.5x6	2 1/2	6	5	7 3/4	7/8		
SPR2.5x10	2 1/2	10	9	11 3/4	7/8		
SPR2.75x6	2 3/4	6	5	7 3/4	7/8		
SPR2.75x10	2 3/4	10	9	11 3/4	7/8		
SPR3x6	3	6	5	7 3/4	7/8		
SPR3x10	3	10	9	11 3/4	7/8		
SPR3.5x6	3 1/2	6	5	7 3/4	7/8		

This family of guards are measured from the LARGEST EXTERIOR POINT unless specified.

- Split Round Flanged Covers are designed cover protruding shafts in tight spaces such as between a motor and housing or a motor and pump.



- For extremely tight locations, installation can be performed using an optional mounting extension bracket.
- The Center Cut Out "L" can be made in in 1/2" increments.

Available Materials:

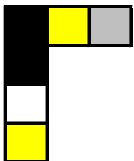

- 3/16" ABS
- 1/4" ABS
- 3/16" transparent PETG
- 1/4" Kydex



Split Round Flanged Clamping Covers

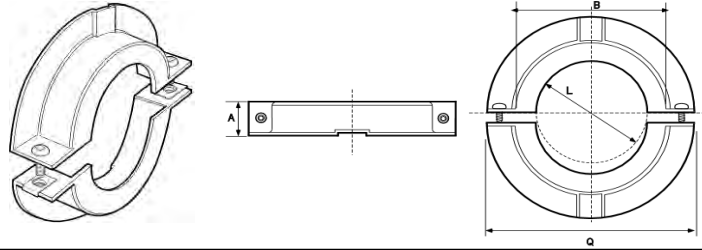

All dimensions measured in inches

Part Number	Height "A"	Diameter "B"	Center Cut Out Max "L"	Flange-to-Flange "Q"	Height to Shoulder "D"			
SPR-C2x6.5	2	6 1/2	5 1/2	9 3/8	1/2			
SPR-C2x7.6	2	7 11/16	6 11/16	10 1/2	1/2			
SPR-C2x5.5	2	5 1/8	4 1/8	8	1/2			

This family of guards are measured from the LARGEST EXTERIOR POINT unless specified.

- Split Round Flanged Covers are designed cover protruding shafts in tight spaces such as between a motor and housing or a motor and pump.



- For extremely tight locations, installation can be performed using an optional mounting extension bracket.
- The Center Cut Out "L" can be made in in 1/2" increments.

Available Materials:

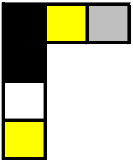

- 3/16" ABS
- 1/4" ABS
- 3/16" transparent PETG
- 1/4" Kydex



Machine Guard & Cover Co.

We've Got You Covered!

# Coupling Cover Request Sheet

Supply information in the 5 circles provided:

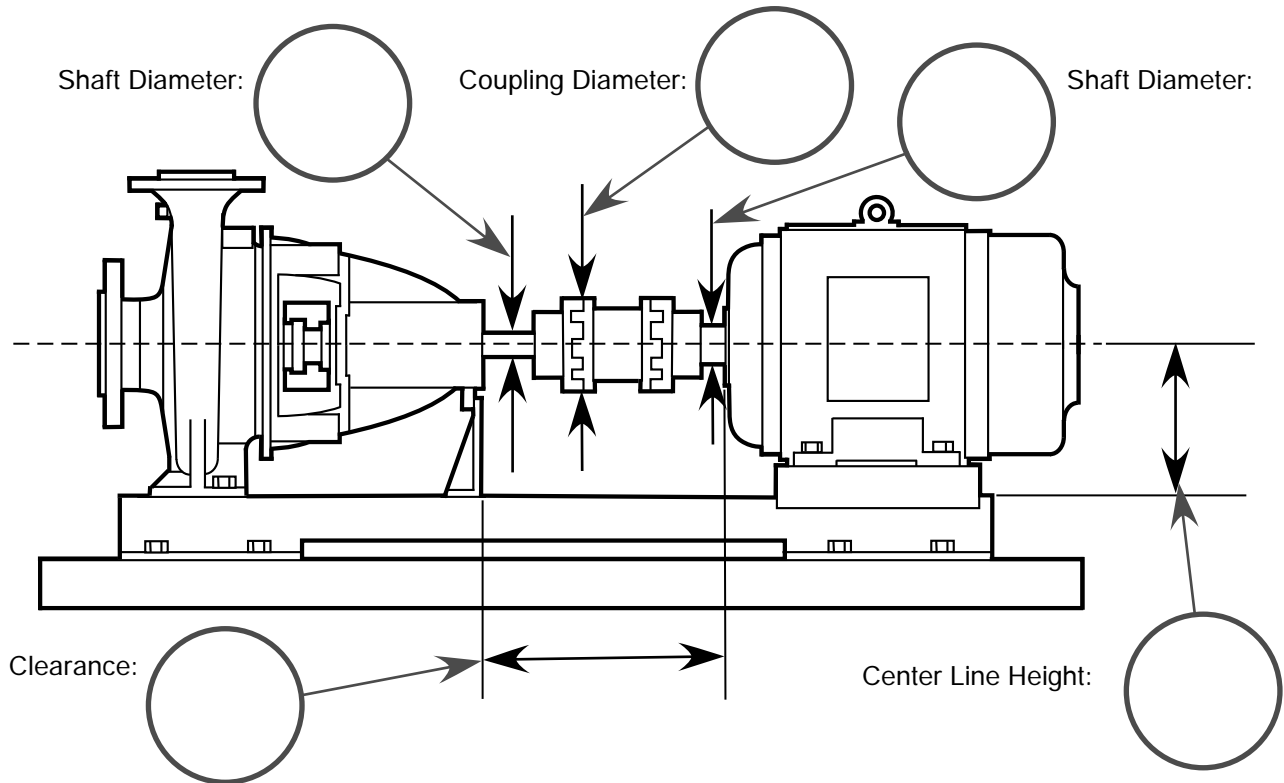

**NOTES:**

- The coupling cover will be 1/2" smaller than the Clearance dimension.
- The cover slot for driveshafts up to 1" Dia. will be 1/2" larger.
- The cover slot for driveshafts from 1+" to 3" Dia. will be 1" larger.
- The cover slot for driveshafts from 3+" to 6" Dia. will be 2" larger.
- For any shaft over 6", we will call you for specific details

Other Features:

Company: \_\_\_\_\_ Contact e-mail: \_\_\_\_\_

Name: \_\_\_\_\_ Contact phone: \_\_\_\_\_

e-mail or FAX this sheet to:

www.machineguard.com  
 office@machineguard.com  
 Fax: 877-482-7313



**Machine Guard & Cover Co.**

6187 136th Avenue  
 Holland, MI 49424  
 888 - 482-7371



**1-Piece Coupling Cover**

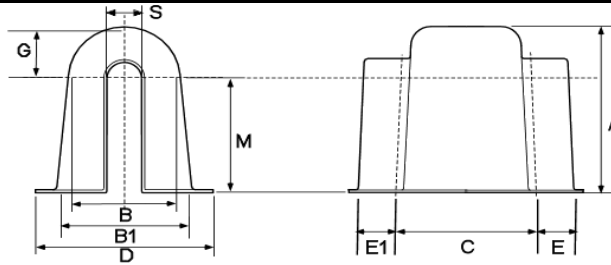
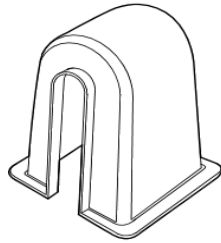

All dimensions measured in inches

Part Number	Height "A"	Diameter "B"	Length "C"	Height to Center "M"	Inside Radius "G"	Extension Dia.	Extension Length		
1CC3.5-3-2.9	5	3	3	3 1/2	1 1/2	0	0		
1CC5.5-5.5-5.5	8	3 1/2	5 1/2	5 1/2	2 1/2	2	1		
1CC4.2-5.5-6	7	6 1/4	6	4 1/4	2 3/4	1	1		
*1CC10.78-8-7.2	10 3/4	8	7 1/2	3 1/4	7 1/2				
*1CC5.5-8-5.7	10 9/16	8 1/16	6	5 1/2	5 1/16				
*1CC5.3-5-5	7 3/4	5	5	2 1/2	5 1/4	0	0		
*2CC5.25-5.7-5	7 3/4	5 7/8	5 1/2	5 1/4	2 1/2	0	0		
*1CC6.5-6-4	5 1/2	6	4	3	2 1/2				
*KL111615	5 1/2	6 1/16	5 7/16	2 1/2	3	3 1/4	1 7/16		
*2CC3.7-5.1-2.7	6 1/16	5 1/16	2 7/16	3 7/16	2 5/8	0	0		
*2CC080603.5	8	6	3 1/4	4 15/16	3 1/16	0	0		
*1CC5.5-6-6	8 1/2	6	6	5 3/4	2 3/4	0	0		
*2CC6.5-6-4	9 3/8	5 3/4	4	4	4 3/8	0	0		
*1CC6.5-7.5-5.5	10 1/8	7 1/2	5 1/4	6 1/2	3 5/8	0	0		
*1CC6.5-8-6	10 1/2	8	5 1/2	6 1/2	1 1/2	2 1/2	1 1/2		
1CC8-8-5-8-7	12 3/8	8 1/2	8 3/4	8	1 1/2				
*2CC8-9-6.6	12 7/16	9	6 5/8	7 15/16	4 1/2	0	0		
*1CC8-9-7	12 1/2	9	7	8	4 1/2				
*2CC10.7-8-7.2	14 7/8	8	7	10 3/4	4 1/8	0	0		
*2CC11.5-11-6.8	17	11	6 3/4	5 1/2	11 1/2	0	0		
*1CC11.7-10.5-8.2	16 15/16	10 1/2	8 3/16	11 1/8	5 13/16	0	0		

Guards are measured from the SMALLEST INTERIOR POINT unless specified.

- In certain applications, these 1-Piece coupling covers may offer the simplest installation solution.
- For larger coupling covers, refer to the Coupling Cover Fabricated Box section.

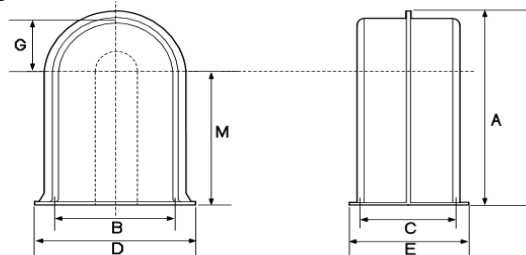
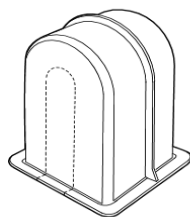

\* Indicates guards with a center rib as shown above

**Available Materials:**

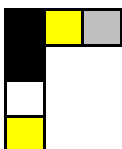

- 3/16" ABS
- 1/4" ABS
- 3/16" transparent PETG
- 1/4" Kydex



Coupling Cover Fabricated Boxes

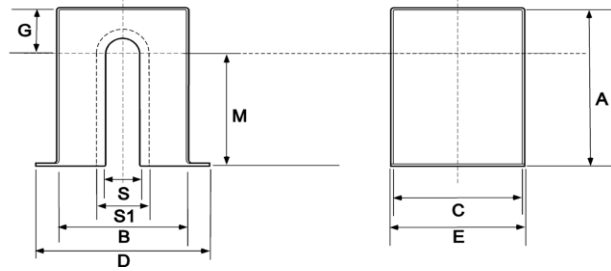
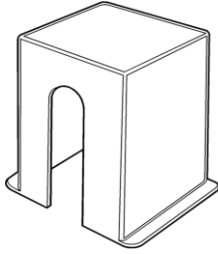

All dimensions measured in inches

Part Number	Height "A"	Width "B"	Inside Length "C"	Maximum Length "E"	Slots "S" and "S1"	Height to Center "M"	Center to Top "G"		
CCFB-16	Up to 16"	Up to 16"	Up to 16"	Up to 16"	Variable	Variable	Variable		
CCFB-24	Up to 24"	Up to 24"	Up to 24"	Up to 24"	Variable	Variable	Variable		
CCFB-32	Up to 32"	Up to 32"	Up to 24"	Up to 24"	Variable	Variable	Variable		
CCFB-36	Up to 36"	Up to 36"	Up to 24"	Up to 24"	Variable	Variable	Variable		

Guards are measured from the SMALLEST INTERIOR POINT unless specified.

- Coupling Cover Fabricated Boxes are manufactured from three pieces using a high strength adhesive.
- The standard flange on all CCFB guards is 2".
- A variety of fabricated parts can be made. Contact us to discuss your specific requirements.

Available Materials:

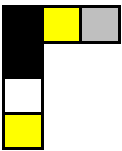

- 3/16" ABS
- 1/4" ABS
- 3/16" transparent PETG
- 1/4" Kydex



**Conveyor Covers (straight) - Heavyweight**

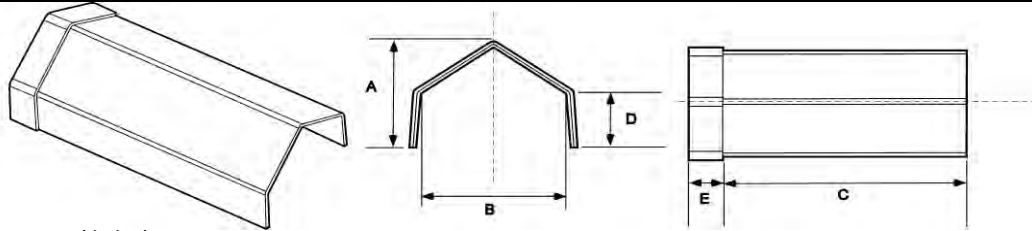

All dimensions measured in inches

Part Number	Height to Top "A"	Height to Shoulder "D"	Width "B"	Length "C"	Extension "E"	Extension "E1"		
*CRS2.50848H	2 1/2	1	7 3/4	48	1 7/8	0		
CRS30960H	3 1/2	1 3/4	9 1/4	60	3	0		
CRS312.560H	3	1	12 1/2	60	2	0		
CRS609.748H	6	3 1/4	9 3/4	48	2 1/4	2 1/4		

**Guards are measured from the SMALLEST INTERIOR POINT unless specified.**

**Conveyor Covers - Straight (CRS) are especially popular for food and pharmaceutical processing applications.**

- Our PETG and metal detectable ABS plastics are FDA approved for certain pharmaceutical and food applications. Contact us for specific details.
- \* Denotes that the extension is an underlap instead of overlap.
- If you do not see what you are looking for, give us a call!

**Available Materials:**

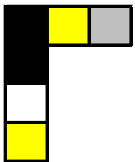

- 3/16" ABS
- 1/4" ABS
- 3/16" transparent PETG
- 1/4" Kydex



Conveyor Covers (straight) - Lightweight

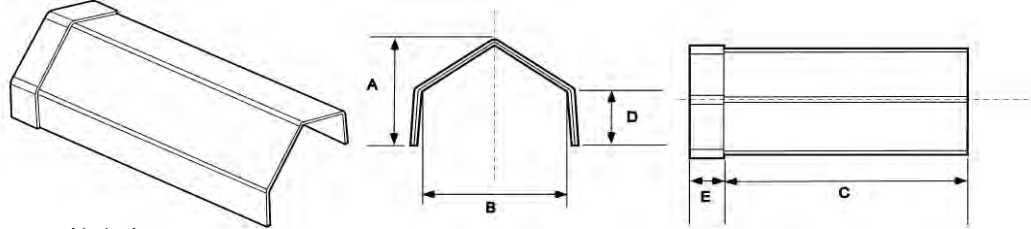



All dimensions measured in inches

Part Number	Height to Top "A"	Height to Shoulder "D"	Width "B"	Length "C"	Extension "E"	Extension "E1"		
*CRS2.50848L	2 1/2	1	7 3/4	48	1 7/8	0		
CRS30960L	3 1/2	1 3/4	9 1/4	60	3	0		
CRS312.560L	3	1	12 1/2	60	2	0		

**Guards are measured from the SMALLEST INTERIOR POINT unless specified.**

- Conveyor Covers - Straight (CRS) are especially popular for food and pharmaceutical processing applications.
- Our PETG and metal detectable ABS plastics are FDA approved for certain pharmaceutical and food applications. Contact us for specific details.
- \* Denotes that the extension is an underlap instead of overlap.
- If you do not see what you are looking for, give us a call!

Available Materials:

-  1/8" ABS
-  1/8" ABS Metal Detectable



**Conveyor Covers (curved) - Heavyweight**

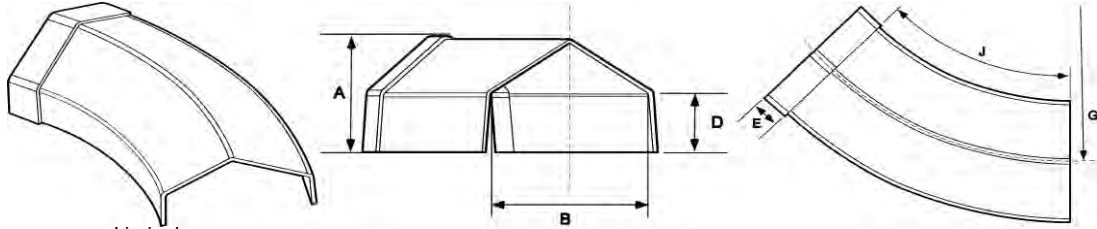

All dimensions measured in inches

Part Number	Height to Top "A"	Height to Shoulder "D"	Width "B"	Extension "E"	Extension "E1"	Radius Centerline "G"	Degree of Turn "J"	
CRR2.5087.2H	2 1/2	1	7 3/4	2	2	7 1/4	180	
CRR2.5088.2H	2 1/2	1	7 3/4	3	3	8 1/4	180	
CRR2.50811H	2 1/2	1	7 3/4	3	3	11	180	
CRR2.50824H	2 1/2	1	7 3/4	2	2	24	90	
CRR30924H	3	1 3/4	9 1/4	0	0	24	90	
CRR609.717H	6	3 1/4	9 3/4	3	0	17	90	
CRR609.724H	6	3 1/4	9 3/4	1	0	24	45	
CRR7x24	7	4	6	0	0	24	90	

**Guards are measured from the SMALLEST INTERIOR POINT unless specified.**

- Conveyor Covers - Curved (CRR) are especially popular for food and pharmaceutical processing
- Our PETG and metal detectable ABS plastics are FDA approved for certain pharmaceutical and food applications. Contact us for specific details.
- If you do not see what you are looking for, give us a call!

**Available Materials:**

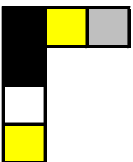

- 3/16" ABS
- 1/4" ABS
- 3/16" transparent PETG
- 1/4" Kydex





Conveyor Covers (curved) - Lightweight

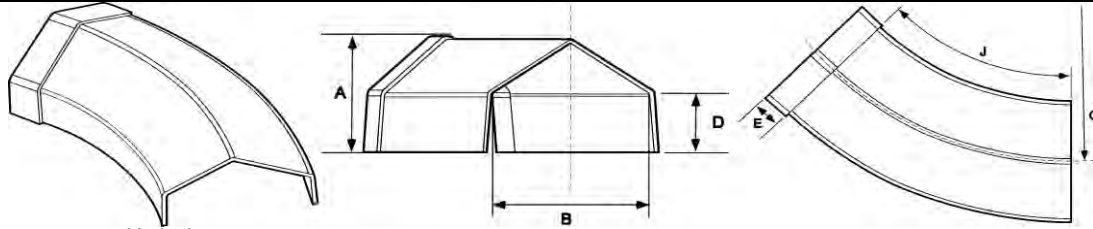



All dimensions measured in inches

Part Number	Height to Top "A"	Height to Shoulder "D"	Width "B"	Extension "E"	Extension "E1"	Radius Centerline "G"	Degree of Turn "J"	
CRR2.5087.2L	2 1/2	1	7 3/4	2	2	7 1/4	180	
CRR2.5088.2L	2 1/2	1	7 3/4	3	3	8 1/4	180	
CRR2.50811L	2 1/2	1	7 3/4	3	3	11	180	
CRR2.50824L	2 1/2	1	7 3/4	2	2	24	90	
CRR30924L	3	1 3/4	9 1/4	0	0	24	90	

**Guards are measured from the SMALLEST INTERIOR POINT unless specified.**

- Conveyor Covers - Curved (CRR) are especially popular for food and pharmaceutical processing
- Our PETG and metal detectable ABS plastics are FDA approved for certain pharmaceutical and food applications. Contact us for specific details.
- If you do not see what you are looking for, give us a call!

Available Materials:

-  1/8" ABS
-  1/8" ABS Metal Detectable





Machine Guard & Cover Co.  
"We've got you covered."

888.482.7371  
www.machineguard.com

Custom lettering available via forming or engraving text or your company's logo directly into your guards.

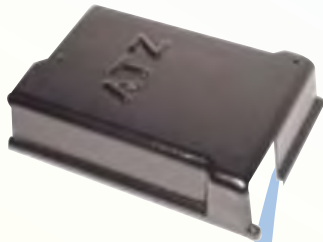

Extra-large guards and square boxes can be fabricated instead of thermoformed. Components can be fixed together using a high-strength adhesive or multiple guards can be attached with hardware to make a larger assembly.



Mounting holes can be added, flange widths changed, or using CNC routing, custom standard parts can be custom trimmed to your specifications.



Low volume custom parts can be produced using prints, sketches, CAD or solid model files. The in-house design team at Machine Guard & Cover Co. will work to create a guard for your specific needs.



Kydex and PETG are resistant to many chemical compounds. ABS can withstand temperatures up to 200°F. PETG can withstand up to 180°F. Kydex has a fire resistance rating of UL Std. 94 V-0, 5V.



Machine Guard & Cover Co.

"We've got you covered."

888.482.7371

[www.machineguard.com](http://www.machineguard.com)

Blue, metal detectable ABS plastic and PETG are FDA approved for certain pharmaceutical and food applications. Contact us for specific details.

Useful in the food and pharmaceutical industries, plastic guards can be sterilized with steam and most detergent solutions.

Thick plastics are lighter, sound dampening and impact and corrosion resistant and when compared to the rising cost of stainless steel fabrication or aluminum casting thermoformed guards offer an average of 50% cost savings.

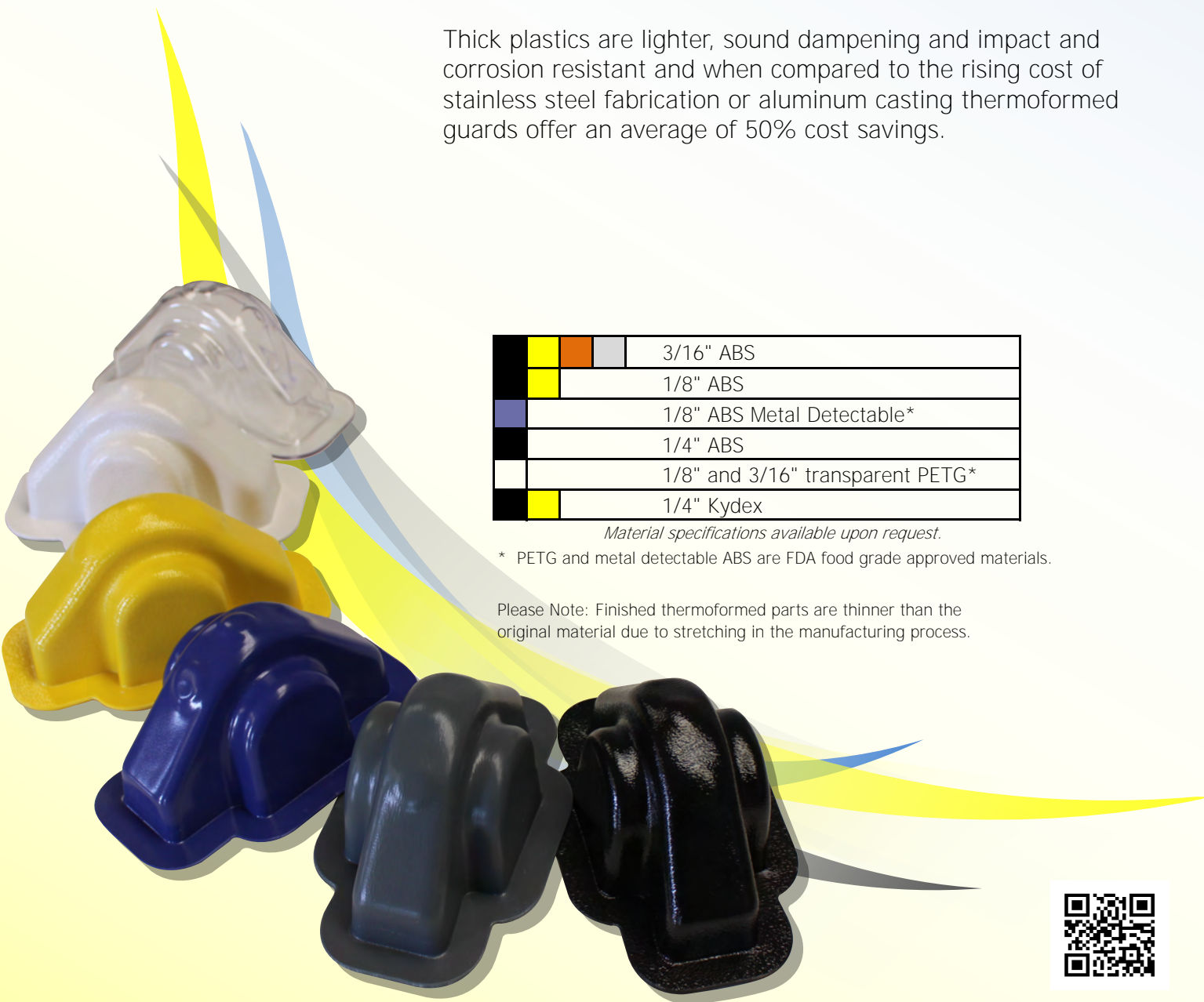

	3/16" ABS
	1/8" ABS
	1/8" ABS Metal Detectable*
	1/4" ABS
	1/8" and 3/16" transparent PETG*
	1/4" Kydex

*Material specifications available upon request.*

\* PETG and metal detectable ABS are FDA food grade approved materials.

Please Note: Finished thermoformed parts are thinner than the original material due to stretching in the manufacturing process.

