



A. Uberti[®] S.p.A.
HISTORY REPEATS ITSELF





SINGLE ACTION REVOLVER AND REVOLVING CARBINE

**INSTRUCTION MANUAL
AND
SAFETY INFORMATION**

TABLE OF CONTENTS

SAFETY INFORMATION

a.  **WARNING** : in this manual, the WARNING sign indicates a potentially hazardous situations which, if not avoided, could result in death or serious injury.

b.  **CAUTION** : in this manual, the CAUTION sign indicates a potentially hazardous situations of unsafe practice which, if not avoided, may result in minor or moderate injury.

 **CAUTION** **READ ALL INSTRUCTIONS AND WARNINGS.** BEFORE USING YOUR UBERTI SINGLE ACTION FIREARM, CAREFULLY READ AND UNDERSTAND ALL OF THE WARNINGS, INSTRUCTIONS AND OTHER INFORMATION IN THIS MANUAL. DO NOT PERMIT OTHERS TO HANDLE THIS FIREARM UNLESS THEY HAVE ALSO READ AND UNDERSTAND THE INFORMATION IN THIS INSTRUCTION MANUAL. FAILURE TO DO SO COULD RESULT IN **SERIOUS INJURY OR DEATH.**

 **WARNING** **ALWAYS KEEP AN EMPTY CHAMBER BELOW THE HAMMER DURING TRANSPORTATION OR STORAGE.**
If you transport or store this single action revolver with a live cartridge in the chamber below the hammer, an accidental discharge could occur from a blow to the hammer or if the firearm is dropped. **SERIOUS INJURY OR DEATH COULD OCCUR. NEVER** keep a live cartridge in the chamber below the hammer.

⚠ CAUTION

FIREARMS ARE NOT ALL ALIKE.

Features and handling characteristics of this single action revolver may be different from other revolvers or firearms with which you are familiar; therefore, it is your responsibility to study this manual carefully and to thoroughly understand all of the operational and safety features of this revolver, how it functions and how to handle it safely. The best way to do this is to sit down with this manual and your unloaded revolver – without any ammunition nearby – and take as much time as is necessary for you to thoroughly understand how it works. **FIREARM SAFETY DEPENDS ON YOU!**

⚠ WARNING

USE ONLY PROPER AMMUNITION

Discharging hand-loaded cartridges, ammunition marked “High Speed” or “High Velocity,” or cartridges of an incorrect caliber, can cause excessively high chamber pressures resulting in severe damage to your firearm and/or **SERIOUS INJURY OR DEATH**. Old cartridges can also deteriorate and damage your firearm. **NEVER use anything other than new cartridges that have been commercially loaded in accordance with SAAMI or C.I.P. standards.** ONLY use cartridges that are the exact caliber as the caliber of your revolver.

⚠ CAUTION

If you are unsure of anything relating to this firearm’s use, or have little experience or are unfamiliar with firearms, contact your local firearm instructor. Firearm safety is your responsibility and your safety and that of your family and others depend on your responsible, safe use.

GENERAL FIREARM SAFETY INSTRUCTIONS

Whether you are an experienced safe shooter and are familiar with these safety instruction procedures, or have some or no familiarity with handling a gun, it is imperative that you read carefully and thoroughly this entire instruction manual and follow the safety instructions to ensure you are familiar with the proper and safe use of this firearm to prevent personal injury, death, or property damage.

WARNING:

• NEVER POINT A FIREARM AT SOMETHING THAT IS NOT SAFE TO SHOOT.

Never let the muzzle of a firearm point at any part of your body or at another person. This is especially important when loading or unloading the firearm. When you are shooting at a target, know what is behind it. Some bullets can travel over a mile. If you miss your target or if the bullet penetrates the target, it is your responsibility to ensure that the shot does not cause unintended injury or damage.



• ALWAYS TREAT A FIREARM AS IF IT WERE LOADED.

Never assume that a firearm is unloaded. **The only certain way to ensure that a firearm has the chamber empty is to open the chamber and visually examine the inside to see if a round is present. Removing a pistol magazine will not guarantee that a firearm is unloaded or cannot fire.** Shotguns and rifles can be checked by cycling or removing all rounds and by then opening and inspecting the chamber and the magazine tube for any remaining rounds.

• KNOW THE SAFETY FEATURES OF THE FIREARM YOU ARE USING, BUT REMEMBER: SAFETY DEVICES ARE NOT A SUBSTITUTE FOR SAFE HANDLING PROCEDURES.

Never rely solely on a safety device to prevent an accident. It is imperative that you know and use the safety features of the particular firearm you are handling, but accidents can best be prevented by following the safe handling procedures described in these safety rules and elsewhere in the product manual. To further familiarize yourself with the proper use of this or other firearms, take a Firearms Safety Course taught by an expert in firearms use and safety procedures.

• NEVER TRANSPORT A LOADED FIREARM.

Unload a firearm before putting it in a vehicle (chamber empty, magazine empty). Hunters and target shooters should load their firearm only at their destination. If you carry a firearm for self-protection, leaving the chamber unloaded can reduce the chance of accidental discharge.



- **AVOID ALCOHOLIC BEVERAGES OR JUDGMENT/ REFLEX IMPAIRING MEDICATION WHEN SHOOTING.**

Do not drink and shoot. If you take medication that can impair motor reactions or judgment, do not handle a firearm while you are under the influence of the medication.



- **ALWAYS WEAR PROTECTIVE GLASSES AND EARPLUGS WHEN SHOOTING.**

The chance that gas, gunpowder or metal fragments will blow back and injure a shooter who is firing a gun is rare, but the injury that can be sustained in such circumstances is severe, including the possible loss of eyesight. A shooter must always wear impact resistant shooting glasses when firing any firearm. Earplugs help reduce the chance of hearing damage from shooting.



- **ALWAYS CHECK THE BARREL BORE, CHAMBER AND ACTION TO ENSURE THEY ARE PERFECTLY CLEAN AND CLEAR OF OBSTRUCTIONS.**

Clean a fouled gun immediately for correct and safe function.

- **DO NOT SMOKE WHILE HANDLING, LOADING OR SHOOTING ANY AMMUNITION, ESPECIALLY BLACK POWDER.**

Keep black powder in a closed container at all times, reclosing the container after each and every use.

- **USE PROPER AMMUNITION.**

- **ONLY USE FACTORY-LOADED, NEW AMMUNITION MANUFACTURED TO INDUSTRY SPECIFICATIONS:**

CIP (Europe and elsewhere), SAAMI® (U.S.A.). Be certain that each round you use is in the proper caliber or gauge and type for the particular firearm. The caliber or gauge of the firearm is clearly marked on the barrels of shotguns and on the slide or barrel of pistols. The use of reloaded or remanufactured ammunition can increase the likelihood of excessive cartridge pressures, casehead ruptures or other defects in the ammunition which can cause damage to your firearm and injury to yourself or others nearby.

Always use an individual charge from a powder measure when loading a muzzleloading gun. Never charging directly from a powder flask.

• NEVER SHOOT AT WATER OR AT A HARD SURFACE.

Shooting at the surface of water or at a rock or other hard surface increases the chance of ricochets or fragmentation of the bullet or shot, which can result in the projectile striking an unintended or peripheral target.



- Never shoot the gun near an animal, as the animal could be startled and create an accident.
- Never engage in “horseplay” while holding your gun.
- When selecting a place to shoot, always be absolutely sure of your target and the area behind it before you touch the trigger, making sure there is an adequate backstop which will stop and contain bullets. A bullet can travel through or past your target up to 1½ miles. If you have any doubt, do not shoot.

• NEVER CLIMB A TREE, FENCE OR OBSTRUCTION WITH A LOADED FIREARM.

Open and empty the chamber of your firearm and engage the manual safety before climbing or descending a tree or before climbing a fence or jumping over a ditch or obstruction. Never pull or push a loaded firearm toward yourself or another person.



- Place the hammer forward only when you are ready to shoot. Never place or permit the hammer to remain in the half-cock notch as this is not a safe carrying position. You might end up accidentally perching the hammer on the lip of the half cock notch, which is extremely dangerous. The hammer in this condition could fall forward and discharge the gun, causing injury, death, or property damage.
- Do not put your finger inside the trigger guard until you have aimed the gun at the intended target and are imminently ready to safely shoot.
- Always be aware of other people around you. Keep spectators or others to your rear. Keep hands and face clear and keep others clear of the ejection port as ejected spent cartridges can cause injury.
- Always use extreme care with a misfire or failure to fire. Keep the gun pointed in a safe direction and wait one full minute. This is because if hangfire or slow ignition has occurred, the round will still fire. If the round fails to fire after waiting, remove the magazine, eject the round and examine the primer. Immediately refer to a competent gunsmith if you notice the firing pin indent on the primer is light, off-center, or does not exist. Dispose of misfired rounds according to the ammunition manufacturer’s instructions.
- Immediately cease shooting if your gun fails to properly function. Never force a jammed action, which can cause a round to explode and cause personal injury, death, or damage to your gun or other property.
- Never leave a gun, especially a loaded gun, unattended as someone, especially a

child, could accidentally shoot it causing injury, death, or property damage.

- Make sure your gun is not loaded before cleaning, storing, traveling, laying it down, or handing it to another person.

• STORE YOUR FIREARM SO THAT CHILDREN CANNOT GAIN ACCESS TO IT.

It is your responsibility to insure that children under the age of 18 or other unauthorized persons do not gain access to your firearm. To reduce the risk of accidents involving children, unload your firearm, lock it and store the ammunition in a separate locked location. Please note that devices intended to prevent accidents - for example, cable locks, chamber plugs, etc. - may not prevent use or misuse of your firearm by a determined person. Steel gun safes may be more appropriate to reduce the likelihood of intentional misuse of a firearm by an unauthorized child or person.

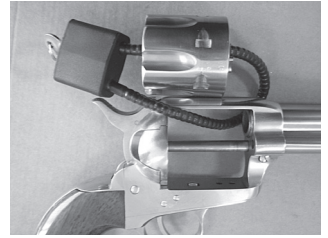

- Black powder and percussion caps must be stored in separate locations, preferably in their original containers.

• LEAD WARNING

Discharging firearms in poorly ventilated areas, cleaning firearms or handling ammunition may result in exposure to lead and other substances known to cause birth defects, reproductive harm, and other serious physical injury. Have adequate ventilation at all times. Wash hands thoroughly after exposure.

• PROPERLY MAINTAIN YOUR FIREARM.

Store and carry your firearm so that dirt or lint does not accumulate in the working parts. Clean and oil your firearm, following the instructions provided in this manual, after each use to prevent corrosion, damage to the barrel or accumulation of impurities which can prevent use of the gun in an emergency. Always check the barrel prior to loading to ensure that it is clean and free from obstructions. **Firing against an obstruction can rupture the barrel and injure yourself or others nearby.**



In case you hear an unusual noise when shooting, stop firing immediately, engage the manual safety and unload the firearm. Make sure the chamber and the barrel are free from any obstruction or possible bullet blocked inside the barrel due to defective or improper ammunition.

This manual should always accompany this firearm and be transferred with it upon change of ownership.

S.A. CATTLEMAN II

NEW MODEL

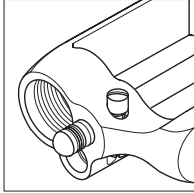

OLD MODEL

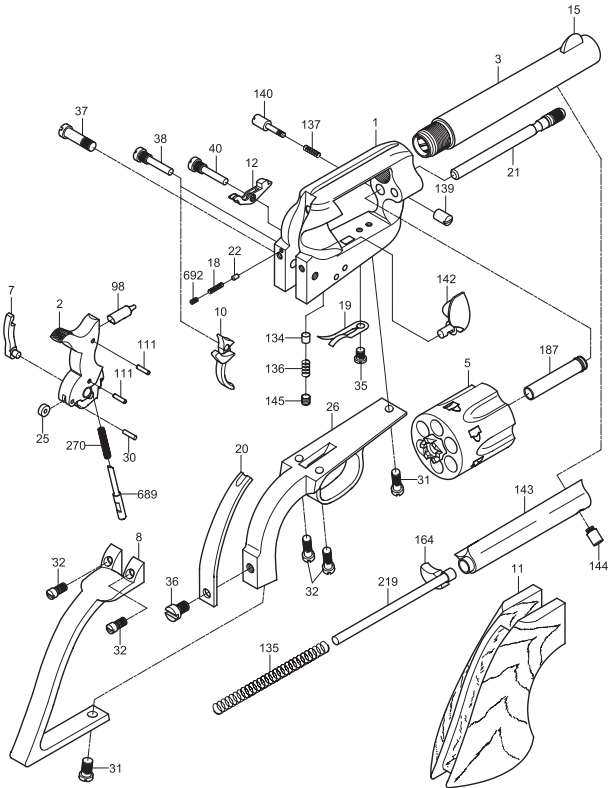
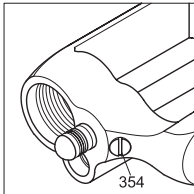

N.	PART.
1	FRAME
2	HAMMER
3	BARREL
5	CYLINDER
7	HAND
8	BACKSTRAP
10	TRIGGER
11	GRIPS
12	BOLT
15	FRONT SIGHT
18	HAND SPRING
19	SEAR AND BOLT SPRING
20	MAIN SPRING
21	BASE PIN
22	HAND SPRING PIN
25	HAMMER ROLL
26	TRIGGERGUARD
30	HAMMER PIN
31	TRIGGERGUARD SCREW
32	TRIGGERG. & BS. SCREW
35	BOLT SPRING SCREW
36	MAIN SPRING SCREW

N.	PART.
37	HAMMER SCREW
38	TRIGGER SCREW
40	BOLT SCREW
98	FIRING PIN
111	HAMMER SAFETY BAR PIN
134	GATE CATCH
135	EJECTOR SPRING
136	GATE SPRING
137	BASE PIN SPRING (New model)
139	BASE PIN NUT (New model)
140	BASE PIN SCREW (New model)
142	GATE
143	EJECTOR ROD TUBE
144	EJECTOR ROD TUBE SCREW
145	GATE CATCH SCREW
164	EJECTOR NUT NEW MODEL
187	BASE PIN BUSHING
219	EJECTOR
270	TRANSFER BAR SPRING
354	BASE PIN SCREW (Old model)
689	TRANSFER BAR
692	HAND PIN SCREW

GENERAL OPERATION AND NOMENCLATURE

Your Uberti single action revolver is an exact replica of an Old West single action revolver. As a “single-action” revolver, the user must manually move the hammer (see Parts Diagram, P/N 2) into the full cock (fire) position each time before a trigger pull will allow the hammer to fall forward and the attached firing pin to strike the primer of a chambered cartridge causing a discharge. In this way, your single action revolver operates differently than modern “double-action” revolvers in which a single pull of the trigger operates to both cock and release the hammer. Each time the hammer of your Uberti single action revolver is moved to the full cock (fire) position, the cylinder rotates clockwise (when viewed from the rear) to position the next chamber under the hammer.

The round cylinder (see Parts Diagram, P/N 5) has been manufactured with six (6) bores or “chambers,” and each chamber will accept a live cartridge of the correct caliber ammunition. Unlike modern revolvers, which provide for the entire cylinder to rotate away from the frame exposing all bores or chambers, this single action revolver has a fixed cylinder which rotates around the cylinder base pin. Only one chamber at a time can be seen through the open loading gate (see Parts Diagram, P/N 142).

This type of single action revolver is capable of holding six (6) cartridges and was therefore known in the Old West as a “six-shooter.” If the hammer is in the fully forward (at rest) position, the firing pin (see Parts Diagram, P/N 98 which is attached to the hammer) rests on the primer of a chambered cartridge. In this position, if the hammer receives a sharp blow, or if the revolver is dropped on the hammer, an accidental discharge could occur. Therefore, as in the Old West, you should load only five (5) of the six (6) chambers, leaving the sixth chamber empty below the hammer.

	ALWAYS KEEP AN EMPTY CHAMBER BELOW THE HAMMER.
<p>NEVER allow the hammer to rest over a live cartridge and NEVER carry the revolver with the hammer over a live cartridge. If the hammer spur receives a sharp blow or if the revolver is dropped, an accidental discharge could occur and SERIOUS INJURY OR DEATH may result. It is only safe to load all six chambers if you are actively shooting the revolver in a controlled environment (e.g., at a shooting range or in a competition).</p>	

IMPORTANT: Please regularly check all external screws for tightness, as firing may cause them to come loose overtime.

SAFETY FEATURES

1. S.A. CATTLEMAN II REVOLVER

RETRACTING FIRING PIN

Patent N°: US 9,273,919 B2

See Page 13

The Uberti Cattleman II with retractable firing pin is a breakthrough for those seeking enhanced safety with regard to original Old West revolvers without sacrificing the visual authenticity of a 1st-generation Colt.

As any cowboy knows, the safest way to carry a single-action is with the hammer resting on an unloaded chamber. This is true even for the Uberti retractable firing pin design. But, in the case of the Uberti design, the risk of accidental discharge is reduced: the firing pin is not locked into the firing position unless the trigger is pulled.

The enhanced safety feature is available without a visible transfer bar safety, which those who insist on visual authenticity might not want. In other words, from the outside this revolver's looks and operation are identical to those of an original.

2. S.A. CATTLEMAN REVOLVER

WITH HAMMER SAFETY BAR

See Page 14

Some models of Uberti single action revolvers are equipped with a hammer safety bar feature. This feature consists of a bar that rests in a slot machined into the front surface of the hammer below the firing pin. (Note: If your model is equipped with this feature, you can see the hammer safety bar resting in its slot when the hammer is in the half cock (loading) position or full cock (fire) position. When the hammer is moved into the quarter cock (safe) position, a tooth on the trigger engages a slot in the bottom surface of the hammer which causes the hammer safety bar to rotate out of its slot and away from the hammer into a position between the hammer and the frame. When engaged, the hammer safety bar provides a mechanical block to the forward movement of the hammer and maintains a safe distance between the tip of the firing pin and the primer of a chambered cartridge

⚠ WARNING

THE HAMMER SAFETY BAR SAFETY IS A MANUAL SAFETY. If your model revolver is equipped with this feature, the hammer safety bar is engaged simply by moving the hammer rearward into the quarter cock (safe) position. However, this feature IS NOT engaged unless and until the hammer is moved into the quarter cock (safe) position; it IS NOT engaged when the hammer is in the fully forward (at rest) position. This revolver does not have an “automatic” safety; therefore, the safety is not always on and must be engaged by the user or **SERIOUS INJURY OR DEATH** could result.

3. S.A. CATTLEMAN REVOLVER **WITH CYLINDER BASE PIN SAFETY** **See Page 15**

The cylinder base pin safety is applied only on the S.A. Cattleman Revolver with hammer safety bar. These revolvers are equipped with an elongated cylinder base pin which acts as a hammer block safety when it is engaged. The cylinder base pin (which runs through the centre of the cylinder) has two positions: “fire” position and “safe” position. With the hammer in the quarter cock (safe) position, and the cylinder base pin inserted as far as it will go in the direction of the hammer, it is in the “safe” position. In this position, the rear tip of the cylinder base pin rests against the front surface of the hammer (in the quarter cock (safe) position) and thereby provides a mechanical block to the forward movement of the hammer/ firing pin. When in the forward “fire” position, the tip of the cylinder base pin recedes into the frame and the tip is no longer close enough to the hammer to prevent its forward movement.

Although the elongated cylinder base pin functions the same way on all models, its movement is accomplished by two different methods depending on the model.

ENGAGING THE CYLINDER BASE PIN SAFETY ON OLD MODEL OR BLACK POWDER FRAME:

To engage the cylinder base pin on this type of single action revolver, follow these steps:

1. Move the hammer into the quarter cock (safe) position. You will hear a click and see the top front edge of the hammer come to rest approx. ¼” from the frame.
2. Loosen the cylinder base pin screw in the frame; this will allow the cylinder base pin to move
3. Push the cylinder base pin into the frame toward the hammer as far as it will go. The stop ring on the cylinder base pin will be against the front of the frame and the rear tip of the cylinder base pin will rest against the front surface of the hammer.
4. Tighten the cylinder base pin screw

ENGAGING THE CYLINDER BASE PIN SAFETY ON NEW MODEL OR PRE-WAR FRAME:

To engage the cylinder base pin on this type of single action revolver, follow these steps:

1. Move the hammer into the quarter cock (safe) position. You will hear a click and see the top front edge of the hammer come to rest approx. ¼” from the frame.
2. Depress the spring-loaded base pin screw into the frame as far as it will go. This will allow the cylinder base pin to move.
3. Push the cylinder base pin into the frame toward the hammer as far as it will go. The stop ring on the cylinder base pin will be against the front of the frame and the rear tip of the cylinder base pin will rest against the front surface of the hammer.
4. Release the spring-loaded base pin screw



WARNING

THE CYLINDER BASE PIN SAFETY IS A MANUAL SAFETY.

The cylinder base pin safety device will only work if the user properly engages it by carefully following these instructions. This revolver does not have an “automatic” safety; therefore, the safety is not always on and must be engaged by the user. By failing to properly engage this safety device, and failing to follow safe loading practices, **SERIOUS INJURY OR DEATH** could result.

4. S.A. CATTLEMAN REVOLVER **WITH TRANSFER BAR** **See Page 16**

With the Transfer Bar mechanism, the firing pin is independent of the hammer. A steel “Bar” transfers the momentum of the hammer to the firing pin (hence “Transfer Bar”). Also, the Transfer Bar will only allow the hammer to come into contact with the firing pin when the trigger is pulled from a cocked hammer.

Hammer positions of the single action revolver are shown on pages 13 ,14 15 and 16.

- A. During transport
- B. Half cock loading / unloading
- C. Full cock: Ready for firing
- D. After firing

1. S.A. CATTLEMAN II REVOLVER
RETRACTING FIRING PIN
Patent N°: US 9,273,919 B2

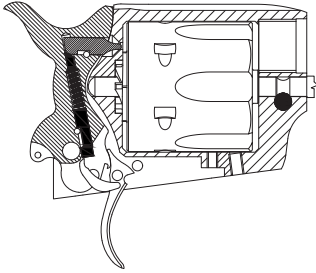

A

- Position of hammer during transport.
- Hammer fully lowered.
- The firing pin floats free in its guide, exerting no pressure towards the chamber.
- Transfer bar disengaged

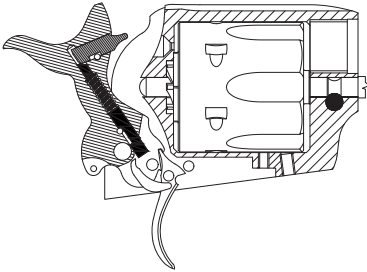

B

- Half cock position for loading and unloading.
- Trigger not released.
- Transfer bar disengaged.

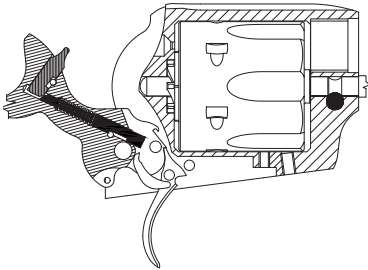

C

- With the hammer at full cock, the hand shifts into position to engage the firing pin once the trigger is pulled.

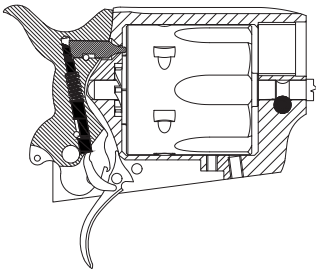

D

- When the trigger is pulled from a fully cocked position, the hand engages the firing pin, locking it in the forward position until the trigger is released.

2. S.A. CATTLEMAN REVOLVER **WITH HAMMER SAFETY BAR**

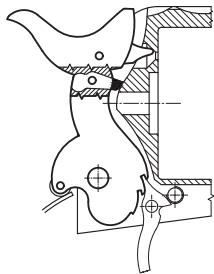

A

- Quarter cock position (safe) during transport.

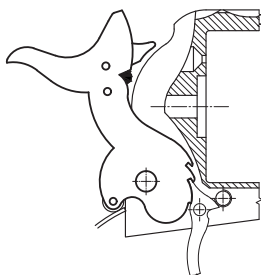

B

- Half cock position for loading and unloading.

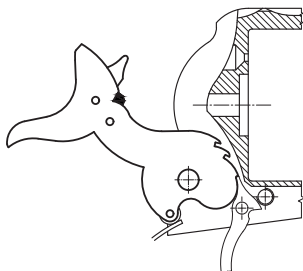

C

- Full cock firing position.

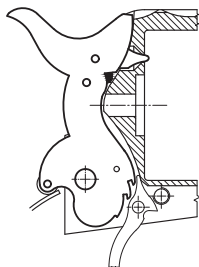

D

- Position after firing.

3. S.A. CATTLEMAN REVOLVER NEW MODEL WITH CYLINDER BASE PIN SAFETY

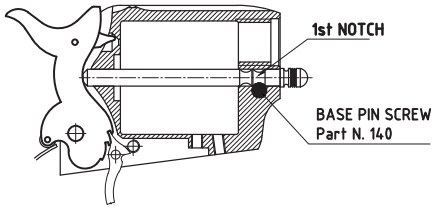

A

- Cylinder base pin position during transport.
- Put the trigger into first cock and the cylinder base pin screw must be positioned in the first notch of the base pin.

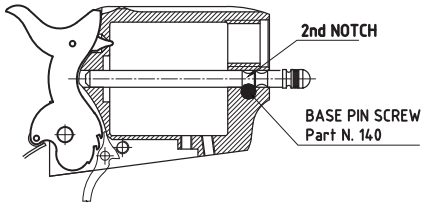

D

- Cylinder base pin in firing position.
- The cylinder pin screw must be positioned in the second notch of the base pin to be able to fire.

3. S.A. CATTLEMAN REVOLVER OLD MODEL WITH CYLINDER BASE PIN SAFETY

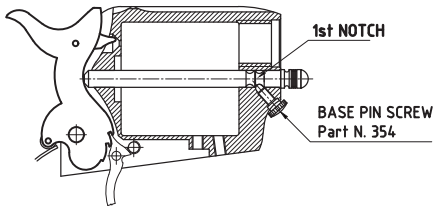

A

- Cylinder base pin position during transport.
- Put the trigger into first cock and the cylinder base pin screw must be positioned in the first notch of the base pin.

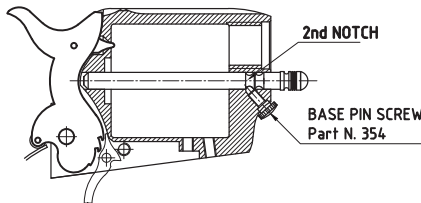

D

- Cylinder base pin in firing position.
- The cylinder pin screw must be positioned in the second notch of the base pin to be able to fire.

4. S.A. CATTLEMAN REVOLVER **WITH TRANSFER BAR**

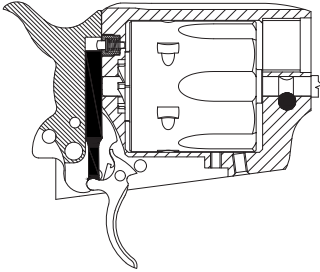

A

- Position of hammer during transport.
- Hammer fully lowered.
- Trigger not released.
- Transfer bar disengaged.

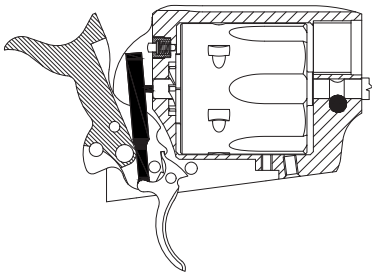

B

- Half cock position for loading and unloading.
- Trigger not released.
- Transfer bar disengaged.

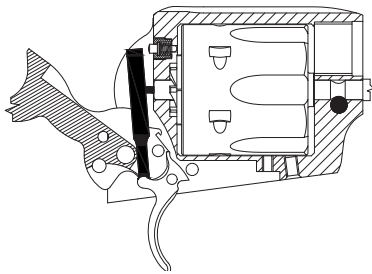

C

- Full cock firing position.
- Trigger not released.
- Transfer bar disengaged.

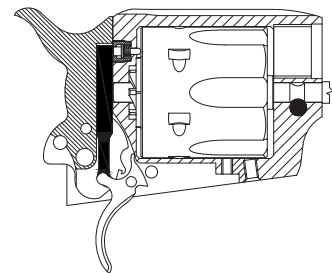

D

- Trigger pulled from a cocked hammer.
- Transfer bar engaged.
- Revolver fires in releasing trigger.
- Revolver returns to position A.

SAFE LOADING

ALWAYS keep your finger out of the trigger guard and off of the trigger while loading and unloading.

ALWAYS perform loading and unloading procedures with the revolver's muzzle pointed in a safe direction.



ALWAYS FOLLOW SAFE LOADING PRACTICES.

Failure to follow these safe loading instructions could result in an accidental discharge or in a live cartridge being loaded in the chamber below the hammer. As with any accidental discharge of a firearm, **SERIOUS INJURY OR DEATH** could result.

First, move the hammer into the half cock (loading) position. In this position, the cylinder will rotate freely in a clockwise direction toward the loading gate. Open the loading gate as far as it will go. This will allow you to see each chamber, one at a time, as you slowly rotate the cylinder. Rotate the cylinder one full revolution to ensure for yourself the firearm is unloaded. **Make certain you are using only new commercially loaded ammunition of the correct caliber. (WARNING: Do NOT use ammunition marked “High Speed” or “High Velocity” and NEVER use reloaded ammunition.)**

LOAD FIVE FOR SAFETY. Old timers used to say the safest way to carry a single action “six shooter” like this one is to only load five chambers and let the hammer rest, in the quarter cock (safe) position, over the empty sixth chamber. “Load one, skip one, load four more” was a common way this safety rule was taught in the Old West. This is still excellent advice because it prevents the hammer from resting over a live cartridge.

How to safely load five (5) cartridges: To load five cartridges and thereby leave an empty chamber under the hammer/firing pin, we strongly recommend you use the “Load 1, Skip 1, Load 4 more” method that was common in the Old West. First, make sure the revolver is fully unloaded: move the hammer into the half cock (loading) position, open the loading gate completely and slowly rotate the cylinder to visually check to see that each of the six chambers is empty. Once you are certain all six chambers are empty, you are ready to use the “Load 1, Skip 1, Load 4 more” loading method. Load the first empty chamber you see through the loading gate. That is the “Load 1” step. Rotate the cylinder until you see the very next empty chamber – but do not load it with a live cartridge – and then rotate the cylinder one more position leaving the second chamber empty. That is the “Skip 1” step. Load the third chamber and then each of the next three chambers so that you have loaded four consecutive chambers. That is the “Load 4 more” step. After loading the fifth live cartridge, close the loading gate, move the hammer to the full cock position and then safely lower the

hammer as described below. By moving the hammer to the full cock position, you will rotate the cylinder one more position so that when you lower the hammer it will now be resting over the one empty chamber. (Note: If you are ever in doubt about the position of the empty chamber in relation to the hammer, do the following: with the hammer in the half cock (loading) position, you can always rotate the cylinder to see the empty chamber and then rotate the cylinder four (4) positions [simulating the “Load 4 more” step]. Then, by fully cocking and then lowering the hammer, you have again moved the empty chamber to a position under the hammer.) Once you have loaded the desired number of cartridges, close the loading gate which then becomes part of the recoil shield.

How to safely lower the hammer: First, make sure the muzzle of the firearm is pointing in a safe direction. Then, pull the hammer back slightly from the half cock or full cock position (**FIG. D**) and, while maintaining firm rearward pressure on the hammer spur with your finger, carefully pull back the trigger and maintain trigger pressure so that the hammer can continue to move slowly more forward past the half cock loading (**FIG.D**) position. Once clear of the half cock (**FIG.D**) position, approximately ½” between the frame and the hammer, carefully release the pressure on the trigger and continue to slowly move the hammer forward until it clicks into the quarter cock (**FIG. A**) position, approximately ¼” between the frame and the hammer. (**NOTE:** You will not hear a “click” as the hammer moves through the half cock (loading or unloading) position.) **WARNING:** Make sure your hand and fingers are dry and such things as gloves or bandages do not prevent you from maintaining a firm grip on the hammer.)

⚠ WARNING

LOWERING THE HAMMER CAN BE DANGEROUS.

Lowering the hammer on a single action firearm can be dangerous if you are not completely familiar with its handling characteristics. If the hammer slips during this process and a live cartridge is positioned under the hammer, an accidental discharge could occur causing **SERIOUS INJURY OR DEATH**. It is therefore critical that you first practice the above loading and unloading steps, including safely lowering the hammer, without any ammunition, or with dummy cartridges only, until you are comfortable and confident you can do so safely. **ALWAYS MAKE SURE THE MUZZLE IS POINTED IN A SAFE DIRECTION WHEN LOWERING THE HAMMER. REMEMBER, FIREARM SAFETY DEPENDS ON YOU!**

⚠ WARNING

SPECIAL NOTICE FOR .22 CALIBER REVOLVERS:

Use of .22 caliber rimfire cartridges present a unique hazard for accidental discharges if cartridges are not fully inserted into each chamber and force is then used to rotate the cylinder or close the loading gate. In such situations, **SERIOUS INJURY OR DEATH** could occur. Therefore, when loading .22 caliber ammunition, take special care to push each cartridge fully into the chamber to avoid interference between the

cartridge rim and either the frame or loading gate. **NEVER DRY FIRE** your .22 caliber single-action revolver; cylinder damage can result and cartridges may not properly enter the chamber.

CAUTION **A LOADED FIREARM** is not a **TOY**. A loaded firearm is capable of causing **SERIOUS INJURY OR DEATH** if not treated with proper care. **DO NOT** engage in horseplay with a loaded firearm and do not leave a loaded firearm unattended.

FIRING YOUR SINGLE ACTION REVOLVER

Once you have loaded the desired number of cartridges, you are ready to fire your revolver. Before firing, make sure the cylinder base pin safety feature has been disengaged so that the hammer can move fully forward. Move the hammer rearward into the full cock (fire) position. With the muzzle pointed in a safe direction, and only when ready to fire, pull the trigger firmly rearward. The hammer will fall forward causing the firing pin to strike the primer of a chambered cartridge resulting in a discharge. If no discharge occurs, wait 30 seconds while the muzzle is pointed in a safe direction, and then unload that cartridge following the instructions below.

REMEMBER, when you move the hammer to the full cock (fire) position, the cylinder rotates clockwise one chamber so that the chamber under the hammer when you began cocking the hammer is now beneath the loading gate. Each time you have fully cocked the firearm but decide not to discharge a chambered cartridge, and then decock the hammer, you may be lowering the hammer over a live cartridge. If you discharged cartridges prior to decocking and then begin firing again, the hammer can easily fall on an empty chamber. You must always be attentive to the number of cartridges you have loaded and discharged.

WARNING **ALWAYS KEEP THE MUZZLE POINTED IN A SAFE DIRECTION. DISCHARGING ANY FIREARM CARRIES RISKS OF EYE AND EAR INJURY WHICH CAN BE MINOR, MODERATE OR SERIOUS.** Unprotected and repeated exposure to gunfire can cause hearing damage. Flying particles and debris can cause eye injury. Therefore, you should ALWAYS wear eye and ear protection when discharging a firearm.

SAFE UNLOADING

Move the hammer rearward to the half cock (loading) position and open the loading gate fully. Using the ejector rod (see Parts Diagram, P/N 219) located under the barrel, depress the rod toward the cylinder to push the live cartridge or empty case out of the chamber and through the open loading gate. Allow the ejection rod to return to its normal position. Rotate the cylinder to see the next chamber and depress the ejection rod again to empty that chamber. Continue this process until all chambers are empty. You must operate the ejector rod its full length in each chamber to ensure complete cartridge ejection. Once each chamber has been unloaded, slowly rotate the cylinder one more complete revolution, take care to ensure each of the six chambers is now completely empty. Then, and only then, should you close the loading gate.

CLEANING AND MAINTENANCE

Before beginning any cleaning or maintenance procedures, **MAKE SURE** the revolver is unloaded.



WARNING FAILURE TO FOLLOW THIS STEP COULD LEAD TO SERIOUS INJURY OR DEATH.)

To do this, move the hammer rearward to the half cock (loading) position and open the loading gate. Then, slowly rotate the cylinder one complete revolution, take care to ensure each of the six chambers is empty. Then, and only then, should you begin cleaning your revolver.

REMOVING THE CYLINDER: To remove the cylinder, follow these steps:

1. Open the loading gate.
2. Move the hammer rearward to the half cock (loading) position.
3. Depending on your model, either loosen the cylinder base pin screw or depress the spring-loaded base pin screw, so that the cylinder base pin can be removed from the frame by pulling it out in the direction of the muzzle.
4. Slide the cylinder base pin all the way out until it is free of the frame.
5. Remove the cylinder toward the loading gate side of the revolver.

NOTE: The cylinder in your revolver is hand-fitted to its frame with precision, so there likely will be a close fit. While the cylinder can be removed and reinstalled easily, care must always be taken to avoid damage. **DO NOT** force the cylinder into the frame from any direction. To reinstall the cylinder, simply reverse the steps used during removal. When you reassemble the cylinder base pin, make sure the base pin catch snaps back into place. You can test to see if it is in the correct position by checking for free movement of the plunger – it should move free when depressed and return under its own spring pressure.

CLEANING

To clean your revolver, use a wood, aluminum or brass cleaning rod (do not use steel), a brass bristle brush, and patches that are correctly sized to the caliber of your revolver. Use a good quality cleaning solution to scrub each cylinder bore and barrel bore. Always brush all the way through the bore; never try to reverse directions while the brush is actually in the barrel or chamber. After scrubbing, run clean patches through the bore and chambers until they come out clean. Thereafter, completely, but lightly, oil the entire revolver. You will find that the oil will nicely color the one piece grip of your revolver over the years and it will develop and retain a soft patina glow. Use a good quality brass polish on the back strap and trigger guard. These high-quality solid brass parts will tarnish, but it is easily removed with any good quality brass polish.

WARRANTY NOTICE!!

CHARCOAL BLUE FINISH: Derives its name from the high-temperature fire blueing process involved in attaining the deep royal blue color. Charcoal Blue is **more delicate than standard blue:** the gun must be constantly oiled and with use will become a desirable smoke gray “patina” finish as on an antique gun.

NICKEL PLATED FINISH: This nickel plated finish is a superficial electrolytic process: these nickel plated firearms, after firing, the muzzle crown of the barrel and the cylinder may begin to show wear on close inspection. This is due to usage and is unavoidable.

WHITE FINISH: White finish is delicate. It is essential you look after your revolver. Acidity from you hand creates rust, therefore the gun must be oiled after handling or simply touching. Remember, your gun is not Stainless Steel.

WOOD: The manufacturer does not warrant the wood (stock, forend and grips) with respect to finish, matching of pieces, dents, scratches, cuts and dings etc.

METAL: The manufacturer does not warrant the metal finish, wood to metal fit etc.

This warranty does not apply to normal wear of any parts, or if an unauthorized repair and/or alteration has been performed.

All are firearms are subject to proof testing at the Italian National Proof House and are proofed at much higher pressures than normal pressures. Furthermore, the chamber dimensions and head space are tested according to the SAAMI or C.I.P. regulations.

NOTICE - DISCLAIMER OF LIABILITY

A. Uberti S.p.A. shall not be responsible for product malfunction or for physical injury, death, or property damage from the gun's intentional or accidental discharge.

A. UBERTI S.P.A. ASSUMES NO RESPONSIBILITY FOR IMPROPER OR CARELESS HANDLING, UNAUTHORIZED MODIFICATIONS, USE OF DEFECTIVE, IMPROPER, HAND-LOADED, RELOADED OR REMANUFACTURED AMMUNITION, CUSTOMER ABUSE OR NEGLIGENCE OF THE PRODUCT. A. Uberti S.p.A. will not honor claims made by the second or subsequent owners of the firearm.

While this firearm was tested, carefully inspected, and packaged before it left the factory, A. Uberti S.p.A. cannot thereafter control product handling. Please be sure to examine this firearm carefully when purchased to ensure it is unloaded and undamaged. Your gun dealer will assist you in making this examination and answer any further questions in this regard.

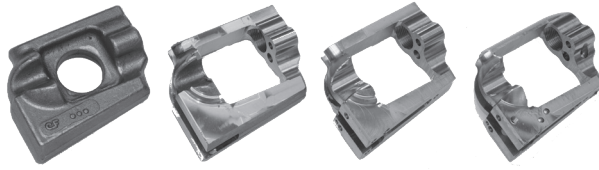

FORGINGS



1873 CATTLEMAN N. M.



1873 CATTLEMAN O. M.



**1873 CATTLEMAN N. M.
STAINLESS STEEL**



1873 CATTLEMAN THUNDERER



1873 CATTLEMAN BIRDHEAD



**1873 CATTLEMAN COWBOY
MOUNTED SHOOTER**



**1873 CATTLEMAN N. M.
TARGET**



BISLEY



**1873 STALLION 10 SHOTS
ONLY CAL. 22**



1873 STALLION LIGHTING



1875 ARMY OUTLAW



1890 ARMY POLICE



1873 REVOLVER CARBINE



A. Uberti[®] S.p.A.
HISTORY REPEATS ITSELF

A. Uberti S.p.A.
Via Artigiani, 1 - 25063 Gardone Val Trompia (Brescia) Italy
Phone +39 030 8341 800 - Fax +39 030 8341 801
E-mail: info@ubertireplicas.it

www.ubertireplicas.com