

Contents

Single Phase - General Purpose	6
Single Phase - Low Voltage.....	11
Single Phase - General Purpose Ventilated	12
Single Phase - Connection Diagrams	15
Series ES-11 CE Marked Single Phase Transformers	17
Series 33 - Control Transformers	20
Series 36 - Signaling.....	21
Series HL - Hazardous Location.....	22
Series 21 HG - Hospital Isolation Transformers.....	23
Single Phase Outline Drawings	24



Single Phase - General Purpose

Single Phase Ventilated:

Series 35: .050 kVA - .750 kVA – Series 80: 1.0 kVA - 5.0 kVA

Features



- **Copper windings** and copper lead wire terminations used throughout.
- **Series 35 has a UL Class 105°C insulation system** with 55°C temperature rise at a maximum ambient of 40°C. This insures a long life and cool operating temperatures.
- **Series 80 has a UL Class 180°C insulation system** with 115°C temperature rise at a maximum ambient of 40°C.
- **NEMA Type 3R**, wall mount enclosure suitable for indoor or outdoor use. May be used in banks of 2 or 3 units for standard three phase voltages and nonstandard, open delta auto-

transformer applications. (Note: .050 kVA - .100 kVA are in a NEMA Type 1 enclosure)

- **Multiple knockouts** provide convenient conduit entry and exit locations through the front access wiring compartment.
- **Ground studs** provided for bonding compatibility with both metallic and nonmetallic conduit.
- **Nonstandard designs** are available by consulting the factory or your Dongan® representative.
- Double wound, isolation type transformers.



Single Phase Encapsulated:

Series 85 ISO-Shield: .250 kVA - 25 kVA

Features



- **Electrostatic shield** between primary and secondary windings provides cleaner output voltage and helps to reduce spikes and transients.
- **Epoxy-silica encapsulated** core and coil provides a transformer particularly well suited for harsh commercial and industrial applications.

- **Copper windings** and copper lead wire terminations used throughout.
- **UL Class 180°C insulation system** with 115°C temperature rise at a maximum ambient of 40°C.
- **NEMA Type 3R**, wall mount enclosure suitable for indoor or outdoor use. May be used in banks of 2 or 3 units for standard three phase voltages and nonstandard, open delta auto-transformer applications.
- **Multiple knockouts** provide convenient conduit entry and exit locations through the front and bottom access wiring compartment covers.
- **Ground studs** provided for bonding compatibility with both metallic and nonmetallic conduit.
- **Nonstandard designs** are available by consulting the factory or your Dongan® representative.
- Double wound, isolation type transformers.



Single Phase - General Purpose

Single Phase Ventilated Cabinet Style:

Series 61 ISO-Shield: 7.5 kVA - 100 kVA

Features



- **Electrostatic shield** between primary and secondary windings provides cleaner output voltage and helps to reduce spikes and transients.
- **Aluminum windings** connect to bus bar style terminations equipped with NEMA standard holes for compression style or ring terminals.
- **UL Class 220°C insulation system** with a 150°C temperature rise at full load and a maximum ambient of 40°C.
- **NEMA Type 3R**, ventilated, cabinet style, floor mount enclosure suitable for indoor or outdoor use.
- **No extra rainshields required for outdoor use.** May also be used in banks of

2 or 3 units for three phase isolation or autotransformer applications.

- **Vibration dampening pads** provide quiet operation.
- **Wall Mounting brackets** are available in sizes up to 50 kVA
- **Ground studs** provided for bonding compatibility with both metallic and nonmetallic conduit.
- **Core and coil and nonstandard designs** are available by consulting the factory or your Dongan® representative.
- Double wound, isolation type transformers.



SINGLE PHASE: 7.5 kVA - 50 kVA

61 Series Optional Wall Mounting Brackets

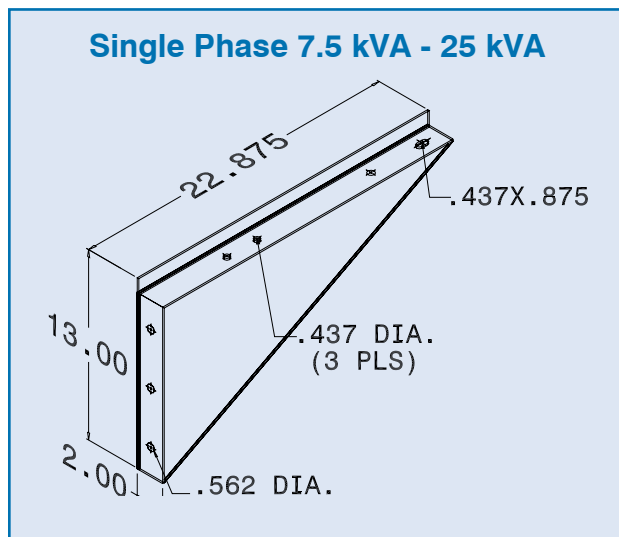

Catalog No. BR - 890

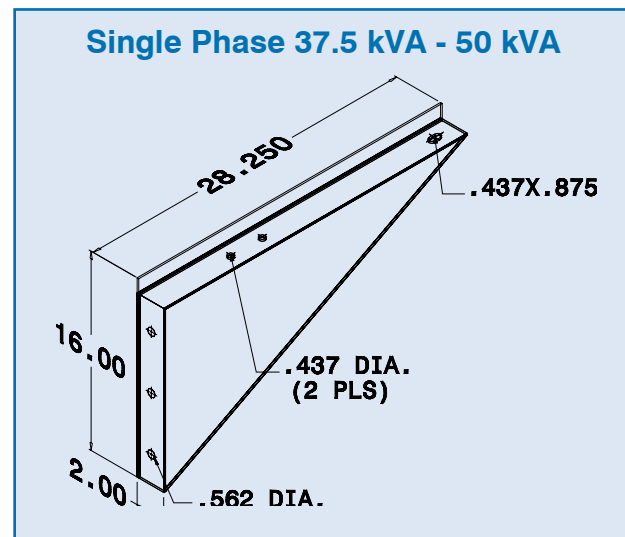

Catalog No. BR - 892

Single Phase - General Purpose

Primary Volts 240 X 480, Secondary Volts 120 / 240

General Information				Winding Specifications				Dimensions			
kVA Cap.	Catalog Number	Hz.	Wgt. Lbs	Taps	Maximum Amps		Conn Dia. Pg. 15	Height A	Width B	Depth C	Outline Dwg.
					Pri.	Sec.					
.050	35-1005	50/60	3.3	0	.2 / .1	.4 / .2	1	6.37	3.75	3.37	1
.100	35-1010	50/60	5	0	.4 / .2	.8 / .4	1	6.37	3.75	3.37	1
.150	35-1015	50/60	7	0	.6 / .3	1.2 / .6	1	7.00	4.00	3.63	2
.250	85-1020SH	50/60	14	0	1.0 / .52	2.0 / 1.0	4	12.00	4.87	5.25	3
.500	85-1025SH	50/60	18	0	2.0 / 1.0	4.1 / 2.0	4	12.00	4.87	5.25	3
.750	85-1030SH	50/60	22	0	3.1 / 1.6	6.2 / 3.1	4	12.00	4.87	5.25	3
1.0	85-1035SH	60	29	0	4.1 / 2.0	8.3 / 4.1	4	15.25	5.75	5.87	3
1.5	85-1040SH	60	37	0	6.2 / 3.1	12.5 / 6.2	4	15.25	5.75	5.87	3
2.0	85-1045SH	60	42	0	8.3 / 4.1	16.6 / 8.3	4	15.25	5.75	5.87	3
3.0	85-1050SH	60	62	0	12.5 / 6.2	25.0 / 12.5	4	15.25	8.25	7.87	3
3.0	85-1450SH	60	62	4	12.5 / 6.2	25.0 / 12.5	2	15.25	8.25	7.8	3
5.0	85-1055SH	60	102	0	20.8 / 10.4	41.6 / 20.8	4	15.25	8.25	7.87	3
5.0	85-1455SH	60	102	4	20.8 / 10.4	41.6 / 20.8	2	15.25	8.25	7.87	3
7.5	85-1060SH	60	131	0	31 / 15.6	62 / 31	4	15.75	14.25	8.75	4
7.5	85-1460SH	60	131	4	31 / 15.6	62 / 31	2	15.75	14.25	8.75	4
10	85-1065SH	60	152	0	41 / 20	83 / 41	4	15.75	14.25	8.75	4
10	85-1465SH	60	152	4	41 / 20	83 / 41	2	15.75	14.25	8.75	4
15	85-1070SH	60	270	0	62 / 31	125 / 62	4	19.38	17.56	11.50	4
15	85-1470SH	60	270	4	62 / 31	125 / 62	2	19.38	17.56	11.50	4
25	85-1075SH	60	300	0	104 / 52	208 / 104	4	19.38	17.56	11.50	4
25	85-1475SH	60	300	4	104 / 52	208 / 104	2	19.38	17.56	11.50	4

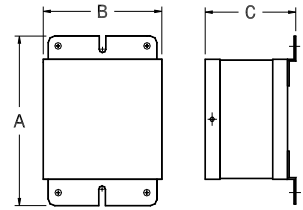

Outline Drawing 1
Wall Mount - Ventilated - NEMA Type 1

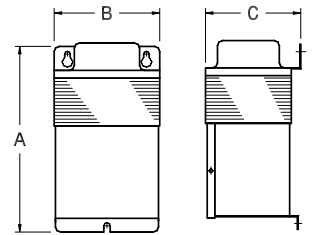

Outline Drawing 2
Wall Mount - Ventilated - NEMA Type 3R

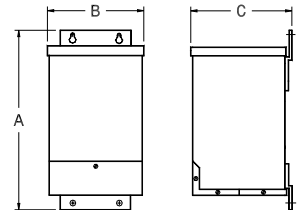

Outline Drawing 3
Wall Mount - Encapsulated -
NEMA Type 3R
Note: 3 kVA & 5kVA 85 Series are
also available in Outline Drawing 4
Configuration

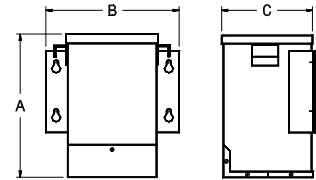

Outline Drawing 4
Wall Mount - Encapsulated - NEMA Type 3R

Floor Mount, Cabinet Style Enclosure

7.5	61-1460SH	60	125	4	31 / 15.6	62 / 31	2	22.00	16.00	16.50	5
10	61-1465SH	60	133	4	41 / 20	83 / 41	2	22.00	16.00	16.50	5
15	41-1470SH*	60	185	4	62 / 31	125 / 62	2	23.50	18.63	18.50	5
25	41-1475SH*	60	281	4	104 / 52	208 / 104	2	30.13	21.63	19.50	5
37.5	41-1680SH*	60	384	6	156 / 78	312 / 156	3	32.00	27.00	26.25	5
50	41-1685SH*	60	445	6	208 / 104	416 / 208	3	32.00	27.00	26.25	5
75	41-1690SH*	60	663	6	312 / 156	625 / 312	3	41.00	34.00	26.75	5
100	41-1695SH*	60	732	6	416 / 208	833 / 416	3	41.00	34.00	26.75	5

* Meets DOE TP-1 requirements

Primary Volts 240 X 480, Secondary Volts 120 - Fused

General Information				Winding Specifications				Dimensions			
kVA Cap.	Catalog Number	Hz.	Wgt. Lbs	Taps	Maximum Amps		Conn Dia. Pg. 16	Height A	Width B	Depth C	Outline Dwg. Pg. 24
					Pri.	Sec.					
.100	35-2010	50/60	5	0	.4 / .2	.8	11	6.37	3.75	3.38	6
.150	35-2015	50/60	7	0	.6 / .3	1.2	11	7.00	4.00	3.63	7
.250	35-2020	50/60	11	0	1.0 / .52	2.0	11	7.50	4.50	4.00	7
.500	35-2025	50/60	20	0	2.0 / 1.0	4.1	11	9.16	5.38	4.56	7
.750	35-2030	50/60	29	0	3.1 / 1.6	6.2	11	10.75	5.50	4.75	7
1.0	80-2035	50/60	29	0	4.1 / 2.0	8.3	11	10.88	5.50	4.75	7
1.5	80-2040	50/60	37	0	6.2 / 3.1	12.5	11	10.19	6.50	5.66	7

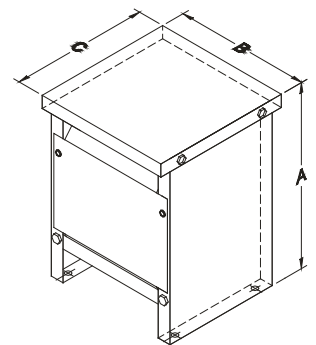

Outline Drawing 5
Floor Mount - Ventilated - NEMA Type 3R

Single Phase - General Purpose

Primary Volts 208, Secondary Volts 120 / 240

General Information				Winding Specifications				Dimensions			
kVA Cap	Catalog Number	Hz	Wgt. Lbs	Taps	Maximum Amp		Conn Dia. Pg. 15	Height A	Width B	Depth C	Outline Dwg.
					Pri	Sec.					
.100	35-3010	50/60	5	0	.4	.8 / .4	5	6.37	3.75	3.37	1
.150	35-3015	50/60	7	0	.7	1.2 / .6	5	7.00	4.00	3.63	2
.250	85-3020SH	50/60	15	0	1.2	2.0 / 1.0	6	12.00	4.87	5.25	3
.500	85-3025SH	50/60	18	0	2.4	4.1 / 2.0	6	12.00	4.87	5.25	3
.750	85-3030SH	50/60	22	0	3.6	6.2 / 3.1	6	12.00	4.87	5.25	3
1.0	85-3035SH	60	29	0	4.8	8.3 / 4.1	6	15.25	5.75	5.87	3
1.5	85-3040SH	60	37	0	7.2	12.5 / 6.2	6	15.25	5.75	5.87	3
2.0	85-3045SH	60	44	0	9.6	16.6 / 8.3	6	15.25	5.75	5.87	3
3.0	85-3050SH	60	62	0	14.4	25.0 / 12.5	6	15.25	8.25	7.87	3
5.0	85-3055SH	60	89	0	24.0	41.6 / 20.8	6	15.25	8.25	7.87	3
7.5	85-3060SH	60	150	0	36	62 / 31	6	15.75	14.25	8.75	4
10	85-3065SH	60	165	0	48	83 / 41	6	15.75	14.25	8.75	4
15	85-3070SH	60	270	0	72	125 / 62	6	19.38	17.56	11.50	4
15	41-3470SH*	60	150	4	72	125 / 62	7	23.50	18.63	18.50	5
25	85-3075SH	60	300	0	120	208 / 104	6	19.38	17.56	11.50	4
25	41-3475SH*	60	232	4	120	208 / 104	7	30.13	21.63	19.50	5

* Meets DOE TP-1 requirements

Primary Volts 277, Secondary Volts 120 / 240

General Information				Winding Specifications				Dimensions			
kVA Cap	Catalog Number	Hz	Wgt. Lbs	Taps	Maximum Amps		Conn Dia. Pg. 16	Height A	Width B	Depth C	Outline Dwg.
					Pri	Sec					
.100	35-4010	50/60	5	0	.3	.8 / .4	8	6.37	3.75	3.37	1
.150	35-4015	50/60	7	0	.5	1.2 / .6	8	7.00	4.00	3.63	2
.250	85-4020SH	50/60	15	0	.9	2.0 / 1.0	9	12.00	4.87	5.25	3
.500	85-4025SH	50/60	18	0	1.8	4.1 / 2.0	9	12.00	4.87	5.25	3
.750	85-4030SH	50/60	22	0	2.7	6.2 / 3.1	9	12.00	4.87	5.25	3
1.0	85-4035SH	60	29	0	3.6	8.3 / 4.1	9	15.25	5.75	5.87	3
1.5	85-4040SH	60	37	0	5.4	12.5 / 6.2	9	15.25	5.75	5.87	3
2.0	85-4045SH	60	44	0	7.2	16.6 / 8.3	9	15.25	5.75	5.87	3
3.0	85-4050SH	60	62	0	10.8	25.0 / 12.5	9	15.25	8.25	7.87	3
5.0	85-4055SH	60	89	0	18	41.6 / 20.8	9	15.25	8.25	7.87	3
7.5	85-4060SH	60	150	0	27	62 / 31	9	15.75	14.25	8.75	4
10	85-4065SH	60	165	0	36	83 / 41	9	15.75	14.25	8.75	4
15	85-4070SH	60	270	0	54	125 / 62	9	19.38	17.56	11.50	4
15	41-4470SH*	60	150	4	54	125 / 62	10	23.50	18.63	18.50	5
25	85-4075SH	60	300	0	90	208 / 104	9	19.38	17.56	11.50	4
25	41-4475SH*	60	232	4	90	208 / 104	10	30.13	21.63	19.50	5

* Meets DOE TP-1 requirements

Connection diagrams may be found on Pgs.15 - 16.

Tap Configurations:

- 1
- 0 = No Taps
- 2 = 1 - 5% FCAN, 1 - 5% FCBN
- 4 = 2 - 2½% FCAN, 2 - 2½% FCBN
- 6 = 2 - 2½% FCAN, 4 - 2½% FCBN

Dimensions & weights may change. Consult factory for certified drawings.

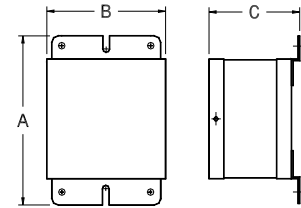

Outline Drawing 1
Wall Mount - Ventilated - NEMA Type 1

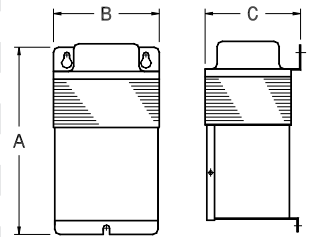

Outline Drawing 2
Wall Mount - Ventilated - NEMA Type 3R

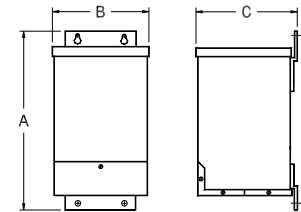

Outline Drawing 3
Wall Mount - Encapsulated - NEMA Type 3R Note: 3 kVA & 5kVA 85 Series are also available in Outline Drawing 4 Configuration

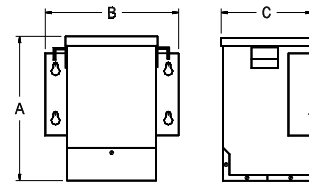

Outline Drawing 4
Wall Mount - Encapsulated - NEMA Type 3R

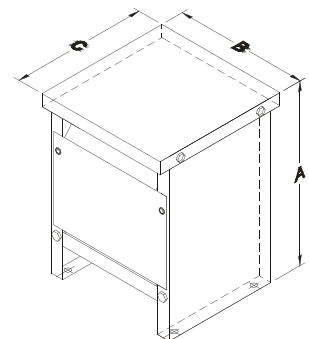

Outline Drawing 5
Floor Mount - Ventilated - NEMA Type 3R

Single Phase - General Purpose

**Primary Volts 600,
Secondary Volts 120 / 240**

General Information				Winding Specifications				Dimensions			
kVA Cap.	Catalog Number	Hz.	Wgt. Lbs	Taps	Maximum Amps		Conn Dia. Pg. 16	Height A	Width B	Depth C	Outline Dwg.
					Pri.	Sec.					
.100	35-5010	50/60	5	0	.1	.8 / .4	12	6.37	3.75	3.37	1
.150	35-5015	50/60	7	0	.2	1.2 / .6	12	7.00	4.00	3.63	2
.250	85-5020SH	50/60	15	0	.4	2.0 / 1.0	13	12	4.87	5.25	3
.500	85-5025SH	50/60	18	0	.8	4.1 / 2.0	13	12	4.87	5.25	3
.750	85-5030SH	50/60	22	0	1.2	6.2 / 3.1	13	12	4.87	5.25	3
1.0	85-5035SH	60	29	0	1.6	8.3 / 4.1	13	15.25	5.75	5.87	3
1.5	85-5040SH	60	37	0	2.5	12.5 / 6.2	13	15.25	5.75	5.87	3
2.0	85-5045SH	60	44	0	3.3	16.6 / 8.3	13	15.25	5.75	5.87	3
3.0	85-5050SH	60	62	0	5.0	25.0 / 12.5	13	15.25	8.25	7.87	3
5.0	85-5055SH	60	89	0	8.3	41.6 / 20.8	13	15.25	8.25	7.87	3
7.5	85-5060SH	60	150	0	12	62 / 31	13	15.75	14.25	8.75	4
10	85-5065SH	60	165	0	16	83 / 41	13	15.75	14.25	8.75	4
15	85-5470SH	60	150	4	25	125 / 62	14	19.38	17.56	11.50	4
25	85-5475SH	60	232	4	41.6	208 / 104	14	19.38	17.56	11.50	4
Cabinet Style Meets DOE TP-1											
15	41-5470SH*	60	150	4	25	125 / 62	14	23.50	18.63	18.50	5
25	41-5475SH*	60	232	4	41.6	208 / 104	14	30.13	21.63	19.50	5
37.5	41-5480SH*	60	330	4	62	312 / 156	14	32.00	27.00	26.25	5
50	41-5485SH*	60	359	4	83	416 / 208	14	32.00	27.00	26.25	5
75	41-5490SH*	60	524	4	125	625 / 312	14	41.00	34.00	26.75	5
100	41-5495SH*	60	648	4	166	833 / 416	14	41.00	34.00	26.75	5

* Meets DOE TP-1 requirements

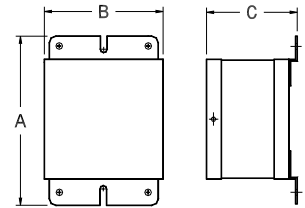

Outline Drawing 1
Wall Mount - Ventilated - NEMA Type 1

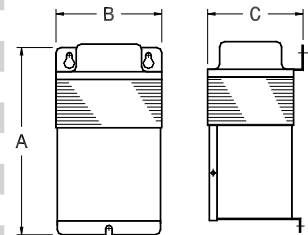

Outline Drawing 2
Wall Mount - Ventilated - NEMA Type 3R

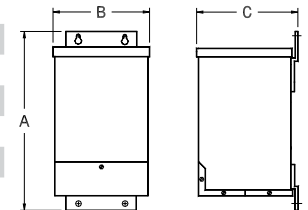

Outline Drawing 3
Wall Mount - Encapsulated - NEMA Type 3R Note: 3 kVA & 5kVA 85 Series are also available in Outline Drawing 4 Configuration

**Primary Volts 120 / 240,
Secondary Volts 120 / 240**

General Information				Winding Specifications				Dimensions			
kVA Cap.	Catalog Number	Hz.	Wgt. Lbs	Taps	Maximum Amps		Conn Dia. Pg. 17	Height A	Width B	Depth C	Outline Dwg.
					Pri.	Sec.					
.100	35-6010	50/60	5	0	.8 / .4	.8 / .4	15	6.37	3.75	3.37	1
.150	35-6015	50/60	7	0	1.2 / .6	1.2 / .6	15	7.00	4.00	3.63	2
.250	85-6020SH	50/60	15	0	2.0 / 1.0	2.0 / 1.0	16	12	4.87	5.25	3
.500	85-6025SH	50/60	18	0	4.1 / 2.0	4.1 / 2.0	16	12	4.87	5.25	3
.750	85-6030SH	50/60	22	0	6.2 / 3.1	6.2 / 3.1	16	12	4.87	5.25	3
1.0	85-6035SH	60	29	0	8.3 / 4.1	8.3 / 4.1	16	15.25	5.75	5.87	3
1.5	85-6040SH	60	37	0	12.5 / 6.2	12.5 / 6.2	16	15.25	5.75	5.87	3
2.0	85-6045SH	60	44	0	16.6 / 8.3	16.6 / 8.3	16	15.25	5.75	5.87	3
3.0	85-6050SH	60	62	0	25.0 / 12.5	25.0 / 12.5	16	15.25	8.25	7.87	3
5.0	85-6055SH	60	89	0	41.6 / 20.8	41.6 / 20.8	16	15.25	8.25	7.87	3
7.5	85-6060SH	60	150	0	62 / 31	62 / 31	16	15.75	14.25	8.75	4
10	85-6065SH	60	165	0	83 / 41	83 / 41	16	15.75	14.25	8.75	4
15	41-6470SH*	60	150	4	125 / 62	125 / 62	17	23.50	18.63	18.50	5
25	41-6475SH*	60	232	4	208 / 104	208 / 104	17	30.13	21.63	19.50	5

* Meets DOE TP-1 requirements

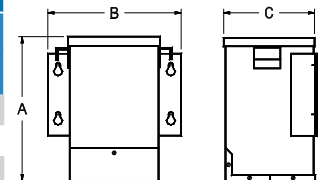

Outline Drawing 4
Wall Mount - Encapsulated - NEMA Type 3R

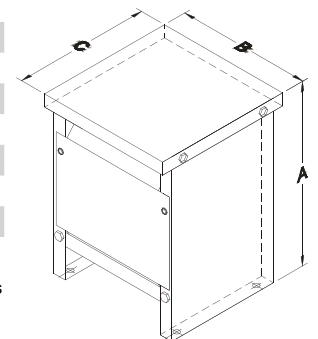

Outline Drawing 5
Floor Mount - Ventilated - NEMA Type 3R

Connection Diagrams may be found on
Pgs. 16 - 17

Single Phase - Low Voltage

Primary Volts 120 X 240, Secondary Volts 12 / 24

General Information				Winding Specifications			Dimensions				
kVA Cap.	Catalog Number	Hz.	Wgt. Lbs	Taps	Maximum Amps		Conn Dia. Pg. 17	Height A	Width B	Depth C	Outline Dwg.
					Pri.	Sec.					
.050	35-M005	50/60	4	0	.4 / .2	4.1 / 2.0	18	6.37	3.75	3.37	1
.100	35-M010	50/60	5	0	.8 / .4	8.3 / 4.1	18	6.37	3.75	3.37	1
.150	35-M015	50/60	7	0	1.2 / .6	12.5 / 6.2	18	7.00	4.00	3.63	2
.250	85-M020	50/60	15	0	2.0 / 1.0	20.8 / 10.4	18	12.00	4.87	5.25	3
.500	85-M025	50/60	19	0	4.1 / 2.0	41.6 / 20.8	18	12.00	4.87	5.25	3
.750	85-M030	50/60	23	0	6.2 / 3.1	62.5 / 31.2	18	12.00	4.87	5.25	3
1.0	85-M035	60	28	0	8 / 4	83 / 41	18	15.25	5.75	5.87	3
1.5	85-M040	60	39	0	12 / 6	125 / 62	18	15.25	5.75	5.87	3
2.0	85-M045	60	43	0	16 / 8	166 / 83	18	15.25	5.75	5.87	3
3.0	85-M050	60	69	0	25 / 12	250 / 125	18	15.25	8.25	7.87	3
5.0	85-M055	60	89	0	41 / 20	416 / 208	18	15.25	8.25	7.87	3

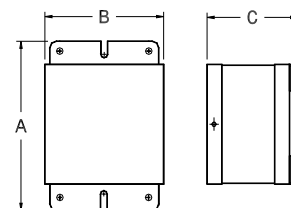

Outline Drawing 1
Wall Mount - Ventilated - NEMA Type 1

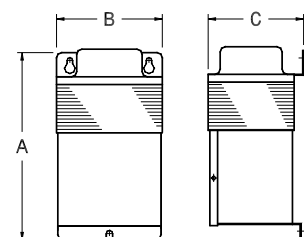

Outline Drawing 2
Wall Mount - Ventilated - NEMA Type 3R

Primary Volts 120 X 240, Secondary Volts 16 / 32

General Information				Winding Specifications			Dimensions				
kVA Cap.	Catalog Number	Hz.	Wgt. Lbs	Taps	Maximum Amps		Conn Dia. Pg. 17	Height A	Width B	Depth C	Outline Dwg.
					Pri.	Sec.					
.050	35-Y005	50/60	4	0	.4 / .2	3.1 / 1.5	19	6.37	3.75	3.37	1
.100	35-Y010	50/60	5	0	.8 / .4	6.2 / 3.1	19	6.37	3.75	3.37	1
.150	35-Y015	50/60	7	0	1.2 / .6	9.3 / 4.6	19	7.00	4.00	3.63	2
.250	85-Y020	50/60	15	0	2.0 / 1.0	15.6 / 7.8	19	12.00	4.87	5.25	3
.500	85-Y025	50/60	19	0	4.1 / 2.0	31.2 / 15.6	19	12.00	4.87	5.25	3
.750	85-Y030	50/60	23	0	6.2 / 3.1	46.8 / 23.4	19	12.00	4.87	5.25	3
1.0	85-Y035	60	28	0	8 / 4	62 / 31	19	15.25	5.75	5.87	3
1.5	85-Y040	60	39	0	12 / 6	93 / 46	19	15.25	5.75	5.87	3
2.0	85-Y045	60	43	0	16 / 8	125 / 62	19	15.25	5.75	5.87	3
3.0	85-Y050	60	69	0	25 / 12	187 / 93	19	15.25	8.25	7.87	3
5.0	85-Y055	60	89	0	41 / 20	312 / 156	19	15.25	8.25	7.87	3

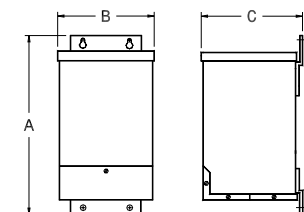

Outline Drawing 3
Wall Mount - Encapsulated - NEMA Type 3R Note: 3 kVA & 5kVA 85 Series are also available in Outline Drawing 4 Configuration

Primary Volts 240 X 480, Secondary Volts 24 / 48

General Information				Winding Specifications			Dimensions				
kVA Cap.	Catalog Number	Hz.	Wgt. Lbs	Taps	Maximum Amps		Conn Dia. Pg. 17	Height A	Width B	Depth C	Outline Dwg.
					Pri.	Sec.					
.100	35-LM010	50/60	5	0	.4 / .2	4.1 / 2.0	20	6.37	3.75	3.37	1
.150	35-LM015	50/60	7	0	.6 / .3	6.2 / 3.1	20	7.00	4.00	3.63	2
.250	85-LM020	50/60	15	0	1.0 / .52	10.4 / 5.2	20	12.00	4.87	5.25	3
.500	85-LM025	50/60	19	0	2.0 / 1.0	20.8 / 10.4	20	12.00	4.87	5.25	3
.750	85-LM030	50/60	23	0	3.1 / 1.6	31.2 / 15.6	20	12.00	4.87	5.25	3
1.0	85-LM035	60	28	0	4 / 2	41 / 20	20	15.25	5.75	5.87	3
1.5	85-LM040	60	39	0	6 / 3	62 / 31	20	15.25	5.75	5.87	3
2.0	85-LM045	60	43	0	8 / 4	83 / 41	20	15.25	5.75	5.87	3
3.0	85-LM050	60	69	0	12 / 6	125 / 62	20	15.25	8.25	7.87	3
5.0	85-LM055	60	89	0	20 / 10	208 / 104	20	15.25	8.25	7.87	3

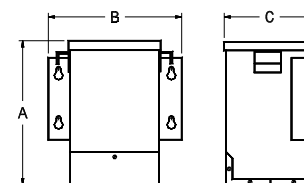

Outline Drawing 4
Wall Mount - Encapsulated - NEMA Type 3R

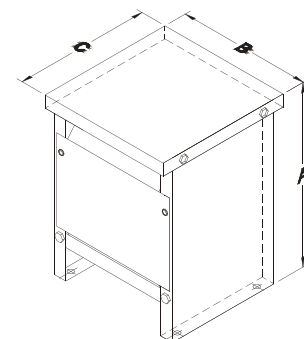

Outline Drawing 5
Floor Mount - Ventilated - NEMA Type 3R

Single Phase - General Purpose Ventilated

Primary Volts 240 X 480, Secondary Volts 120 / 240

General Information				Winding Specifications				Dimensions			
kVA Cap.	Catalog Number	Hz.	Wgt. Lbs	Taps	Maximum Amps		Conn Dia. Pg. 15	Height A	Width B	Depth C	Outline Dwg.
					Pri.	Sec.					
.050	35-1005	50/60	3.3	0	.2 / .1	.4 / .2	1	6.37	3.75	3.37	1
.100	35-1010	50/60	5	0	.4 / .2	.8 / .4	1	6.37	3.75	3.37	1
.150	35-1015	50/60	7	0	.6 / .3	1.2 / .6	1	7.00	4.00	3.63	2
.250	35-1020	50/60	11	0	1.0 / .52	2.0 / 1.0	1	7.50	4.63	4.00	2
.500	35-1025	50/60	20	0	2.0 / 1.0	4.1 / 2.0	1	9.25	5.50	4.75	2
.750	35-1030	50/60	28	0	3.1 / 1.6	6.2 / 3.1	1	10.88	5.50	4.75	2
1.0	80-1035	50/60	29	0	4.1 / 2.0	8.3 / 4.1	1	10.88	5.50	4.75	2
1.5	80-1040	50/60	37	0	6.2 / 3.1	12.5 / 6.2	1	10.63	6.63	5.88	2
2.0	80-1045	60	41	0	8.3 / 4.1	16.6 / 8.3	1	11.00	6.63	5.88	2
3.0	80-1050	60	53	0	12.5 / 6.2	25.0 / 12.5	1	10.88	7.69	6.88	2
5.0	80-1055	60	77	0	20.8 / 10.4	41.6 / 20.8	1	13.69	7.69	6.88	2

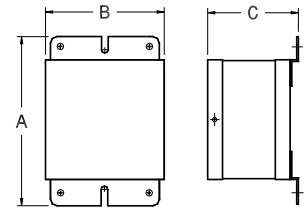

Outline Drawing 1
Wall Mount - Ventilated - NEMA Type 1

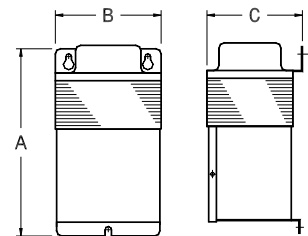

Outline Drawing 2
Wall Mount - Ventilated - NEMA Type 3R

Primary Volts 208, Secondary Volts 120 / 240

General Information				Winding Specifications				Dimensions			
kVA Cap.	Catalog Number	Hz.	Wgt. Lbs	Taps	Maximum Amps		Conn Dia. Pg. 15	Height A	Width B	Depth C	Outline Dwg.
					Pri.	Sec.					
.100	35-3010	50/60	5	0	.4	.8 / .4	5	6.37	3.75	3.37	1
.150	35-3015	50/60	7	0	.7	1.2 / .6	5	7.00	4.00	3.63	2
.250	35-3020	50/60	11	0	1.2	2.0 / 1.0	5	7.50	4.63	4.00	2
.500	35-3025	50/60	20	0	2.4	4.1 / 2.0	5	9.25	5.50	4.75	2
.750	35-3030	50/60	28	0	3.6	6.2 / 3.1	5	10.88	5.50	4.75	2
1.0	80-3035	50/60	29	0	4.8	8.3 / 4.1	5	10.88	5.50	4.75	2
1.5	80-3040	50/60	37	0	7.2	12.5 / 6.2	5	10.63	6.63	5.88	2

Connection Diagrams may be found on Pgs. 15 - 16

Tap Configurations:

- 0 = No Taps
- 2 = 1 - 5% FCAN, 1 - 5% FCBN
- 4 = 2 - 2½% FCAN, 2 - 2½% FCBN
- 6 = 2 - 2½% FCAN, 4 - 2½% FCBN

Dimensions & weights may change. Consult factory for certified drawings.

Primary Volts 277, Secondary Volts 120 / 240

General Information				Winding Specifications				Dimensions			
kVA Cap.	Catalog Number	Hz.	Wgt. Lbs	Taps	Maximum Amps		Conn Dia. Pg. 16	Height A	Width B	Depth C	Outline Dwg.
					Pri.	Sec.					
.100	35-4010	50/60	5	0	.3	.8 / .4	8	6.37	3.75	3.37	1
.150	35-4015	50/60	7	0	.5	1.2 / .6	8	7.00	4.00	3.63	2
.250	35-4020	50/60	11	0	.9	2.0 / 1.0	8	7.50	4.63	4.00	2
.500	35-4025	50/60	20	0	1.8	4.1 / 2.0	8	9.25	5.50	4.75	2
.750	35-4030	50/60	28	0	2.7	6.2 / 3.1	8	10.88	5.50	4.75	2
1.0	80-4035	50/60	29	0	3.6	8.3 / 4.1	8	10.88	5.50	4.75	2
1.5	80-4040	50/60	37	0	5.4	12.5 / 6.2	8	10.63	6.63	5.88	2

Single Phase - General Purpose Ventilated

Primary Volts 600, Secondary Volts 120 / 240

General Information				Winding Specifications				Dimensions			
kVA Cap.	Catalog Number	Hz.	Wgt. Lbs	Taps	Maximum Amps		Conn Dia. Pg. 16	Height A	Width B	Depth C	Outline Dwg.
					Pri.	Sec.					
.100	35-5010	50/60	5	0	.1	.8 / 4	12	6.37	3.75	3.37	1
.150	35-5015	50/60	7	0	.2	1.2 / 6	12	7.00	4.00	3.63	2
.250	35-5020	50/60	11	0	.4	2.0 / 1.0	12	7.50	4.63	4.00	2
.500	35-5025	50/60	20	0	.8	4.1 / 2.0	12	9.25	5.50	4.75	2
.750	35-5030	50/60	28	0	1.2	6.2 / 3.1	12	10.88	5.50	4.75	2
1.0	80-5035	50/60	29	0	1.6	8.3 / 4.1	12	10.88	5.50	4.75	2
1.5	80-5040	50/60	37	0	2.5	12.5 / 6.2	12	10.63	6.63	5.88	2

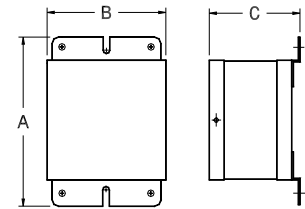

Outline Drawing 1
Wall Mount - Ventilated - NEMA Type 1

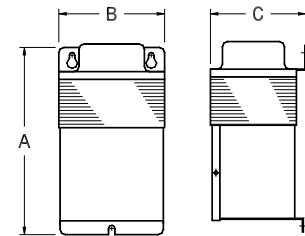

Outline Drawing 2
Wall Mount - Ventilated - NEMA Type 3R

Primary Volts 120 / 240, Secondary Volts 120 / 240

General Information				Winding Specifications				Dimensions			
kVA Cap.	Catalog Number	Hz.	Wgt. Lbs	Taps	Maximum Amps		Conn Dia. Pg. 17	Height A	Width B	Depth C	Outline Dwg.
					Pri.	Sec.					
.100	35-6010	50/60	5	0	.8 / 4	.8 / 4	15	6.37	3.75	3.37	1
.150	35-6015	50/60	7	0	1.2 / 6	1.2 / 6	15	7.00	4.00	3.63	2
.250	35-6020	50/60	11	0	2.0 / 1.0	2.0 / 1.0	15	7.50	4.63	4.00	2
.500	35-6025	50/60	20	0	4.1 / 2.0	4.1 / 2.0	15	9.25	5.50	4.75	2
.750	35-6030	50/60	28	0	6.2 / 3.1	6.2 / 3.1	15	10.88	5.50	4.75	2
1.0	80-6035	50/60	29	0	8.3 / 4.1	8.3 / 4.1	15	10.88	5.50	4.75	2
1.5	80-6040	50/60	37	0	12.5 / 6.2	12.5 / 6.2	15	10.63	6.63	5.88	2

Primary Volts 480, Secondary Volts 120 / 240, With 2 - 5% FCBN Taps

General Information				Winding Specifications				Dimensions			
kVA Cap.	Catalog Number	Hz.	Wgt. Lbs	Tap Code	Maximum Amps		Conn Dia.	Height A	Width B	Depth C	Outline Dwg.
					Pri.	Sec.					
1.0	80-7235	50/60	29	*	2.0	8.3 / 4.1	See Wind. Dia. at Right	10.88	5.50	4.75	2
1.5	80-7240	50/60	37	*	3.1	12.5 / 6.2		10.63	6.63	5.88	2
2.0	80-7245	60	41	*	4.1	16.6 / 8.3		11.00	6.63	5.88	2
3.0	80-7250	60	53	*	6.2	25.0 / 12.5		10.88	7.69	6.88	2
5.0	80-7255	60	77	*	10.4	41.6 / 20.8		13.69	7.69	6.88	2

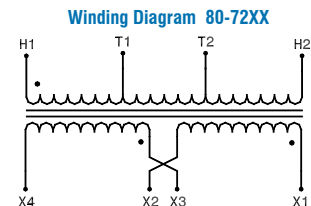

* Tap Configuration for this series is: 2 - 5% FCBN

Single Phase - General Purpose Ventilated

Primary Volts 120 X 240, Secondary Volts 12 / 24

General Information				Winding Specifications				Dimensions			
kVA Cap.	Catalog Number	Hz.	Wgt. Lbs.	Taps	Maximum Amps		Conn Dia. Pg. 17	Height A	Width B	Depth C	Outline Dwg.
					Pri.	Sec.					
.050	35-M005	50/60	5	0	.4 / .2	4.1 / 2.0	18	6.37	3.75	3.37	1
.100	35-M010	50/60	8	0	.8 / .4	8.3 / 4.1	18	6.37	3.75	3.37	1
.150	35-M015	50/60	8	0	1.2 / .6	12.5 / 6.2	18	7.00	4.00	3.63	2
.250	35-M020	50/60	11	0	2.0 / 1.0	20.8 / 10.4	18	7.50	4.63	4.00	2
.500	35-M025	50/60	20	0	4.1 / 2.0	41.6 / 20.8	18	9.25	5.50	4.75	2
.750	35-M030	50/60	28	0	6.2 / 3.1	62.5 / 31.2	18	10.88	5.50	4.75	2
1.0	80-M035	50/60	29	0	8 / 4	83 / 41	18	10.88	5.50	4.75	2
1.5	80-M040	50/60	37	0	12 / 6	125 / 62	18	10.63	6.63	5.88	2
2.0	80-M045	60	42	0	16 / 8	166 / 83	18	11.00	6.63	5.88	2
3.0	80-M050	60	58	0	25 / 12	250 / 125	18	16.38	7.69	6.88	2
5.0	80-M055	60	82	0	41 / 20	416 / 208	18	18.50	7.69	6.88	2

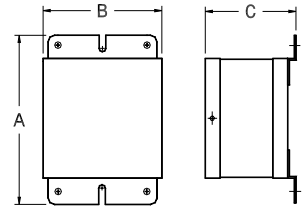

Outline Drawing 1
Wall Mount - Ventilated - NEMA Type 1

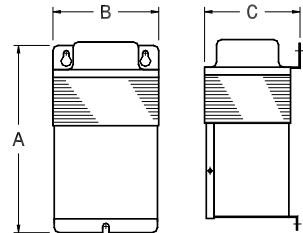

Outline Drawing 2
Wall Mount - Ventilated - NEMA Type 3R

Primary Volts 120 X 240, Secondary Volts 16 / 32

General Information				Winding Specifications				Dimensions			
kVA Cap.	Catalog Number	Hz.	Wgt. Lbs.	Taps	Maximum Amps		Conn Dia. Pg. 17	Height A	Width B	Depth C	Outline Dwg.
					Pri.	Sec.					
.050	35-Y005	50/60	5	0	.4 / .2	3.1 / 1.5	19	6.37	3.75	3.37	1
.100	35-Y010	50/60	8	0	.8 / .4	6.2 / 3.1	19	6.37	3.75	3.37	1
.150	35-Y015	50/60	8	0	1.2 / .6	9.3 / 4.6	19	7.00	4.00	3.63	2
.250	35-Y020	50/60	11	0	2.0 / 1.0	15.6 / 7.8	19	7.50	4.63	4.00	2
.500	35-Y025	50/60	20	0	4.1 / 2.0	31.2 / 15.6	19	9.25	5.50	4.75	2
.750	35-Y030	50/60	28	0	6.2 / 3.1	46.8 / 23.4	19	10.88	5.50	4.75	2
1.0	35-Y035	50/60	29	0	8 / 4	62 / 31	19	10.88	5.50	4.75	2
1.5	35-Y040	50/60	37	0	12 / 6	93 / 46	19	10.63	6.63	5.88	2
2.0	35-Y045	60	42	0	16 / 8	125 / 62	19	11.00	6.63	5.88	2
3.0	35-Y050	60	58	0	25 / 12	187 / 93	19	16.38	7.69	6.88	2
5.0	35-Y055	60	82	0	41 / 20	312 / 156	19	18.50	7.69	6.88	2

Connection Diagrams may be found on Pgs. 17

Tap Configurations:

- 0 = No Taps
- 2 = 1 - 5% FCAN, 1 - 5% FCBN
- 4 = 2 - 2½% FCAN, 2 - 2½% FCBN
- 6 = 2 - 2½% FCAN, 4 - 2½% FCBN

Dimensions & weights may change. Consult factory for certified drawings.

Primary Volts 240 X 480, Secondary Volts 24 / 48

General Information				Windings Specifications				Dimensions			
kVA Cap.	Catalog Number	Hz.	Wgt. Lbs.	Taps	Maximum Amps		Conn Dia. Pg. 17	Height A	Width B	Depth C	Outline Dwg.
					Pri.	Sec.					
.100	35-LM010	50/60	8	0	.4 / .2	4.1 / 2.0	20	6.37	3.75	3.37	1
.150	35-LM015	50/60	8	0	.6 / .3	6.2 / 3.1	20	7.00	4.00	3.63	2
.250	35-LM020	50/60	11	0	1.0 / .52	10.4 / 5.2	20	7.50	4.63	4.00	2
.500	35-LM025	50/60	20	0	2.0 / 1.0	20.8 / 10.4	20	9.25	5.50	4.75	2
.750	35-LM030	50/60	28	0	3.1 / 1.6	31.2 / 15.6	20	10.88	5.50	4.75	2
1.0	80-LM035	50/60	29	0	4 / 2	41 / 20	20	10.88	5.50	4.75	2
1.5	80-LM040	50/60	37	0	6 / 3	62 / 31	20	10.63	6.63	5.88	2
2.0	80-LM045	60	42	0	8 / 4	83 / 41	20	11.00	6.63	5.88	2
3.0	80-LM050	60	58	0	12 / 6	125 / 62	20	16.38	7.69	6.88	2
5.0	80-LM055	60	82	0	20 / 10	208 / 104	20	18.50	7.69	6.88	2

Single Phase Connection Diagrams

Dia. 1		Catalog Series 35-10XX & 80-10XX	
Tap Arrangement		None	
% High Voltage	High Voltage 240 X 480	Inter-Connect	Connect High Voltage Lines To
100	240	H1 To H3 H2 To H4	H1H3 & H2H4
100	480	H2 To H3	H1 & H4
% Low Voltage	Low Voltage 120 / 240	Inter-Connect	Connect Low Voltage Lines To
100	120	X1 To X3 X2 To X4	X1X3 & X2X4
100	120 / 240	X2 To X3	X1 & X2X3 & X4
100	240	X2 To X3	X1 & X4

Dia. 4		Catalog Series 85-10XXSH	
Tap Arrangement		None	
% High Voltage	High Voltage 240 X 480	Inter-Connect	Connect High Voltage Lines To
100	240	H1 To H3 H2 To H4	H1H3 & H2H4
100	480	H2 To H3	H1 & H4
% Low Voltage	Low Voltage 120 / 240	Inter-Connect	Connect Low Voltage Lines To
100	120	X1 To X3 X2 To X4	X1X3 & X2X4
100	120 / 240	X2 To X3	X1 & X2X3 & X4
100	240	X2 To X3	X1 & X4

Dia. 7		Catalog Series 61-34XXSH	
Tap Arrangement		2-2½ % FCAN (Full Capacity Above Normal) 2-2½ % FCBN (Full Capacity Below Normal)	
% High Voltage	High Voltage 208	Inter-Connect	Connect High Voltage Lines To
105	218	1 To 2	H1 & H2
102.5	213	2 To 3	
100	208	3 To 4	
97.5	203	4 To 5	
95	198	5 To 6	
% Low Voltage	Low Voltage 120 / 240	Inter-Connect	Connect Low Voltage Lines To
100	120	X1 To X3 X2 To X4	X1X3 & X2X4
100	120 / 240	X2 To X3	X1 & X2X3 & X4
100	240	X2 To X3	X1 & X4

Dia. 2		Catalog Series 85-14XXSH & 61-14XXSH		
Tap Arrangement		2 - 2½ FCAN (Full Capacity Above Normal) 2 - 2½ FCBN (Full Capacity Below Normal)		
% High Voltage	High Voltage 240 X 480	Inter-Connect	Connect High Voltage Lines To	
105	252	H1 To 2 H2 To 1	H1 & H2	
100	240	H1 To 4 H2 To 3		
95	228	H1 To 6 H2 To 5		
105	504	1 To 2		
102.5	492	2 To 3		
100	480	3 To 4		
97.5	468	4 To 5		
95	456	5 To 6		
% Low Voltage	Low Voltage 120 / 240	Inter-Connect		Connect Low Voltage Lines To
100	120	X1 To X3 X2 To X4		X1X3 & X2X4
100	120 / 240	X2 To X3	X1 & X2X3 & X4	
100	240	X2 To X3	X1 & X4	

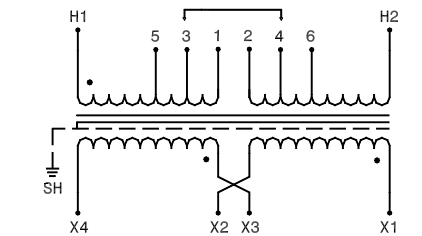

Dia. 5		Catalog Series 35-30XX & 80-30XX	
Tap Arrangement		None	
% High Voltage	High Voltage 208	Inter-Connect	Connect High Voltage Lines To
100	208	--	H1 & H2
% Low Voltage	Low Voltage 120 / 240	Inter-Connect	Connect Low Voltage Lines To
100	120	X1 To X3 X2 To X4	X1X3 & X2X4
100	120 / 240	X2 To X3	X1 & X2X3 & X4
100	240	X2 To X3	X1 & X4

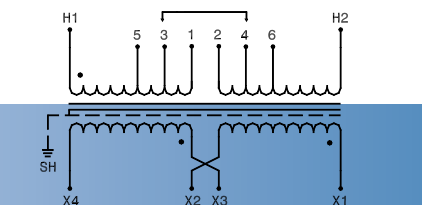
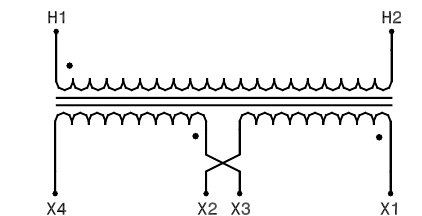

Dia. 3		Catalog Series 61-16XXSH	
Tap Arrangement		2 - 2½ FCAN (Full Capacity Above Normal) 4 - 2½ FCBN (Full Capacity Below Normal)	
% High Voltage	High Voltage 240 X 480	Inter-Connect	Connect High Voltage Lines To
105	252	H1 To 2 H2 To 1	H1 & H2
100	240	H1 To 4 H2 To 3	
95	228	H1 To 6 H2 To 5	
90	216	H1 To 8 H2 To 7	
105	504	1 To 2	
102.5	492	2 To 3	
100	480	3 To 4	
97.5	468	4 To 5	
95	456	5 To 6	
92.5	444	6 To 7	
90	432	7 To 8	
% Low Voltage	Low Voltage 120 / 240	Inter-Connect	Connect Low Voltage Lines To
100	120	X1 To X3 X2 To X4	X1X3 & X2X4
100	120 / 240	X2 To X3	X1 & X2X3 & X4
100	240	X2 To X3	X1 & X4

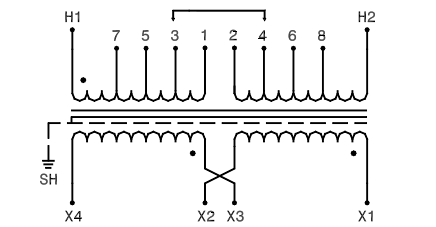

Dia. 6		Catalog Series 85-30XXSH	
Tap Arrangement		None	
% High Voltage	High Voltage 208	Inter-Connect	Connect High Voltage Lines To
100	208	--	H1 & H2
% Low Voltage	Low Voltage 120 / 240	Inter-Connect	Connect Low Voltage Lines To
100	120	X1 To X3 X2 To X4	X1X3 & X2X4
100	120 / 240	X2 To X3	X1 & X2X3 & X4
100	240	X2 To X3	X1 & X4

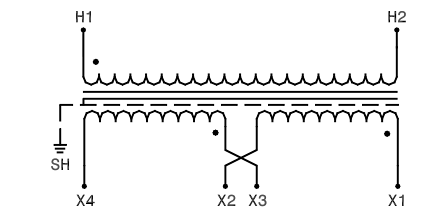

Single Phase Connection Diagrams

Catalog Series 35-40XX & 80-40XX			
Dia. 8			
Tap Arrangement	None		
% High Voltage	High Voltage	Inter-Connect	Connect High Voltage Lines To
100	277	--	H1 & H2
% Low Voltage	Low Voltage	Inter-Connect	Connect Low Voltage Lines To
100	120	X1 To X3 X2 To X4	X1X3 & X2X4
100	120 / 240	X2 To X3	X1 & X2X3 & X4
100	240	X2 To X3	X1 & X4

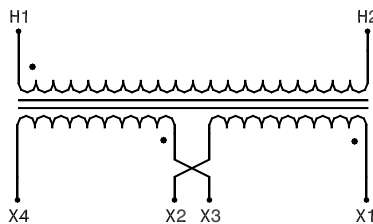

Catalog Series 85-40XXSH			
Dia. 9			
Tap Arrangement	None		
% High Voltage	High Voltage	Inter-Connect	Connect High Voltage Lines To
100	277	--	H1 & H2
% Low Voltage	Low Voltage	Inter-Connect	Connect Low Voltage Lines To
100	120	X1 To X3 X2 To X4	X1X3 & X2X4
100	120 / 240	X2 To X3	X1 & X2X3 & X4
100	240	X2 To X3	X1 & X4

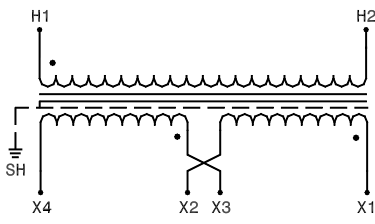

Catalog Series 61-44XXSH			
Dia. 10			
Tap Arrangement	None		
% High Voltage	High Voltage	Inter-Connect	Connect High Voltage Lines To
105	291	1 To 2	H1 & H2
102.5	284	2 To 3	
100	277	3 To 4	
97.5	270	4 To 5	
95	263	5 To 6	
% Low Voltage	Low Voltage	Inter-Connect	Connect Low Voltage Lines To
100	120	X1 To X3 X2 To X4	X1X3 & X2X4
100	120 / 240	X2 To X3	X1 & X2X3 & X4
100	240	X2 To X3	X1 & X4

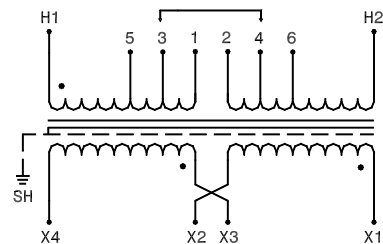

Catalog Series 35-20XX & 80-20XX			
Dia. 11			
Tap Arrangement	None		
% High Voltage	High Voltage	Inter-Connect	Connect High Voltage Lines To
100	240	H1 To H3 H2 To H4	H1H3 & H2H4
100	480	H2 To H3	H1 & H4
% Low Voltage	Low Voltage	Inter-Connect	Connect Low Voltage Lines To
100	120	-	X1 & X2

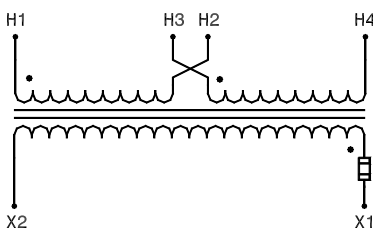

Catalog Series 35-50XX & 80-50XX			
Dia. 12			
Tap Arrangement	None		
% High Voltage	High Voltage	Inter-Connect	Connect High Voltage Lines To
100	600	--	H1 & H2
% Low Voltage	Low Voltage	Inter-Connect	Connect Low Voltage Lines To
100	120	X1 To X3 X2 To X4	X1X3 & X2X4
100	120 / 240	X2 To X3	X1 & X2X3 & X4
100	240	X2 To X3	X1 & X4

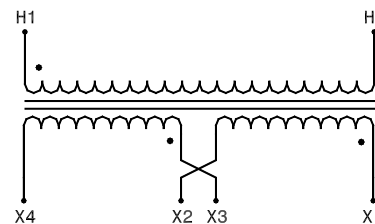

Catalog Series 85-50XXSH			
Dia. 13			
Tap Arrangement	None		
% High Voltage	High Voltage	Inter-Connect	Connect High Voltage Lines To
100	600	--	H1 & H2
% Low Voltage	Low Voltage	Inter-Connect	Connect Low Voltage Lines To
100	120	X1 To X3 X2 To X4	X1X3 & X2X4
100	120 / 240	X2 To X3	X1 & X2X3 & X4
100	240	X2 To X3	X1 & X4

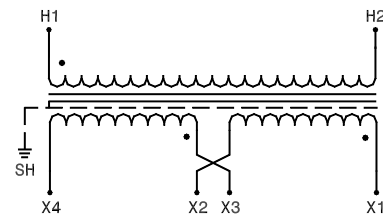

Catalog Series 61-54XXSH			
Dia. 14			
Tap Arrangement	None		
% High Voltage	High Voltage	Inter-Connect	Connect High Voltage Lines To
105	630	1 To 2	H1 & H2
102.5	615	2 To 3	
100	600	3 To 4	
97.5	585	4 To 5	
95	570	5 To 6	
% Low Voltage	Low Voltage	Inter-Connect	Connect Low Voltage Lines To
100	120	X1 To X3 X2 To X4	X1X3 & X2X4
100	120 / 240	X2 To X3	X1 & X2X3 & X4
100	240	X2 To X3	X1 & X4

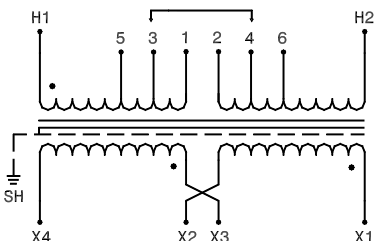

Single Phase Connection Diagrams

Dia. 15		Catalog Series 35-60XX & 80-60XX			
Tap Arrangement		None			
% High Voltage	High Voltage 120 X 240	Inter-Connect	Connect High Voltage Lines To		
100	120	H1 To H3 H2 To H4	H1H3 & H2H4		
100	240	H2 To H3	H1 & H4		
% Low Voltage	Low Voltage 120 / 240	Inter-Connect	Connect Low Voltage Lines To		
100	120	X1 To X3 X2 To X4	X1X3 & X2X4		
100	120 / 240	X2 To X3	X1 & X2X3 & X4		
100	240	X2 To X3	X1 & X4		

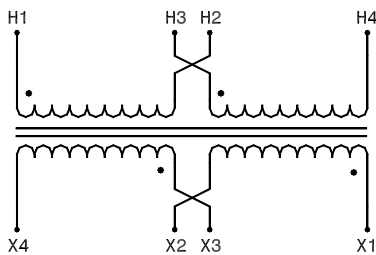

Dia. 16		Catalog Series 85-60XXSH			
Tap Arrangement		None			
% High Voltage	High Voltage 120 X 240	Inter-Connect	Connect High Voltage Lines To		
100	120	H1 To H3 H2 To H4	H1H3 & H2H4		
100	240	H2 To H3	H1 & H4		
% Low Voltage	Low Voltage 120 / 240	Inter-Connect	Connect Low Voltage Lines To		
100	120	X1 To X3 X2 To X4	X1X3 & X2X4		
100	120 / 240	X2 To X3	X1 & X2X3 & X4		
100	240	X2 To X3	X1 & X4		

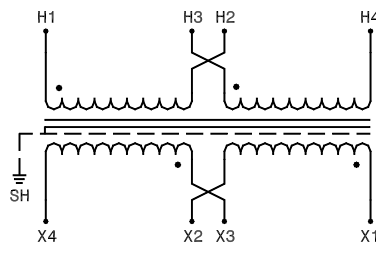

Dia. 17		Catalog Series 61-64XXSH			
Tap Arrangement		2 - 2½ FCAN (Full Capacity Above Normal) 2 - 2½ FCBN (Full Capacity Below Normal)			
% High Voltage	High Voltage 120 X 240	Inter-Connect	Connect High Voltage Lines To		
105	126	H1 To 2 H2 To 1	H1 & H2		
100	120	H1 To 4 H2 To 3			
95	114	H1 To 6 H2 To 5			
105	252	1 To 2			
102.5	246	2 To 3			
100	240	3 To 4			
97.5	234	4 To 5			
95	228	5 To 6			

% Low Voltage	Low Voltage 120 / 240	Inter-Connect	Connect Low Voltage Lines To	
100	120	X1 To X3 X2 To X4	X1X3 & X2X4	
100	120 / 240	X2 To X3	X1 & X2X3 & X4	
100	240	X2 To X3	X1 & X4	

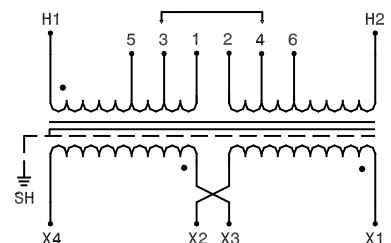

Dia. 18		Catalog Series 35-M0XX & 80-M0XX 85-M0XX			
Tap Arrangement		No Taps			
% High Voltage	High Voltage 120 X 240	Inter-Connect	Connect High Voltage Lines To		
100	120	H1 To H3 H2 To H4	H1H3 & H2H4		
100	240	H2 To H3	H1 & H4		
% Low Voltage	Low Voltage 12 / 24	Inter-Connect	Connect Low Voltage Lines To		
100	12	X1 To X3 X2 To X4	X1X3 & X2X4		
100	12 / 24	X2 To X3	X1 & X2X3 & X4		
100	24	X2 To X3	X1 & X4		

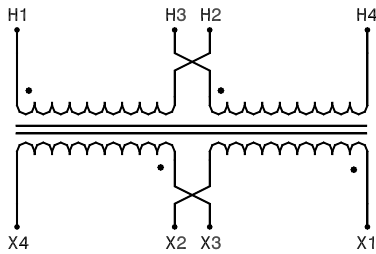

Dia. 19		Catalog Series 35-Y0XX & 80-Y0XX 85-Y0XX			
Tap Arrangement		No Taps			
% High Voltage	High Voltage 120 X 240	Inter-Connect	Connect High Voltage Lines To		
100	120	H1 To H3 H2 To H4	H1H3 & H2H4		
100	240	H2 To H3	H1 & H4		
% Low Voltage	Low Voltage 16 / 32	Inter-Connect	Connect Low Voltage Lines To		
100	16	X1 To X3 X2 To X4	X1X3 & X2X4		
100	16 / 32	X2 To X3	X1 & X2X3 & X4		
100	32	X2 To X3	X1 & X4		

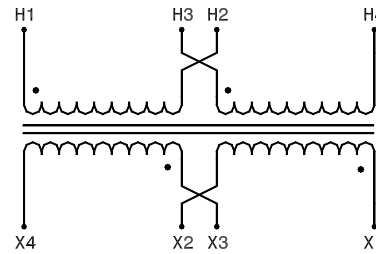

Dia. 20		Catalog Series 35-LM0XX & 80-LM0XX 85-LM0XX			
Tap Arrangement		No Taps			
% High Voltage	High Voltage 240 X 480	Inter-Connect	Connect High Voltage Lines To		
100	240	H1 To H3 H2 To H4	H1H3 & H2H4		
100	480	H2 To H3	H1 & H4		
% Low Voltage	Low Voltage 24 / 48	Inter-Connect	Connect Low Voltage Lines To		
100	24	X1 To X3 X2 To X4	X1X3 & X2X4		
100	24 / 48	X2 To X3	X1 & X2X3 & X4		
100	48	X2 To X3	X1 & X4		

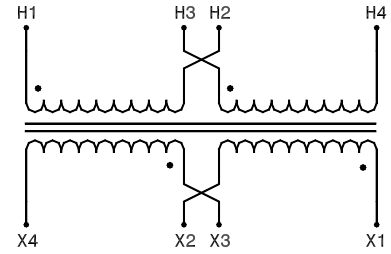

Series ES-11 CE Marked Single Phase Transformers

Series ES Single Phase Encapsulated Transformers are designed to comply with Domestic, North American, and European Union electrical and testing standards. Series ES are UL and Canadian UL Listed by Underwriters Labs. In addition, Series ES are CE Marked, and licensed by the German testing agency TÜV Rheinland under.

Series ES transformers are the answer to your export needs. With the voltage combinations listed below, and built in approvals, the ES Series provide no-nonsense solutions for equipment destined for the European Community of nations.

Under EC guidelines, connecting transformers to line and load require finger safe connections. While other manufacturers provide leads, Dongan® provides finger safe terminals on all ES-11 transformers. This feature eliminates the necessity of a difficult, labor intensive installation of terminals in the wiring compartment by the end user.

The voltage combinations offered represent some of the most universally used. However, any combination of primary and secondary incorporating voltages of 600 volts and below is available on a short lead time, special order basis. In addition, capacities up to 25 kVA and special temperature rise configurations can be furnished.

Please consult your distributor, Dongan® Representative, or the factory for special ES Series transformer requirements.

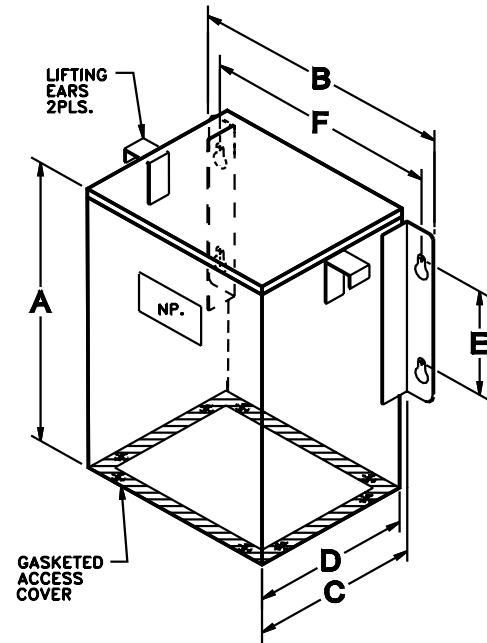

Series ES-11
Wall Mount - Encapsulated - NEMA Type 12 - IP54

General Information									
Pri. Volts	380/400/416/440 460/480/575	220/380/400/416	Dimensions (inches)						Weight (lbs)
Sec. Volts	110/115/120	120/240	A	B	C	Mounting			
kVA Cap.	Catalog Number	Catalog Number	A	B	C	D	E	F	Weight (lbs)
.250	ES-11130.326	ES-11130.359	10.50	10.00	6.62	6.12	4.00	8.50	35
.500	ES-11170.326	ES-11170.359	10.50	10.00	6.62	6.12	4.00	8.50	45
.750	ES-11190.326	ES-11190.359	10.50	10.00	6.62	6.12	4.00	8.50	55
1.0	ES-11200.326	ES-11200.359	12.00	10.81	7.19	6.69	6.00	9.13	75
1.5	ES-11210.326	ES-11210.359	14.00	14.00	9.25	8.75	8.00	12.00	90
2.0	ES-11230.326	ES-11230.359	14.00	14.00	9.25	8.75	8.00	12.00	110
3.0	ES-11250.326	ES-11250.359	14.00	14.00	9.25	8.75	8.00	12.00	120
5.0	ES-11300.326	ES-11300.359	14.00	14.38	10.00	9.50	8.00	12.38	150
7.5	ES-11330.326	ES-11330.359	15.00	18.00	12.50	12.00	8.00	16.00	165
10.0	ES-11360.326	ES-11360.359	15.00	18.00	12.50	12.00	8.00	16.00	190
15.0	ES-11380.326	ES-11380.359	15.00	18.00	12.50	12.00	8.00	16.00	270
25.0	ES-11410.326	ES-11410.359	18.00	21.00	15.00	14.50	8.00	19.00	350

Series ES-11 CE Marked Single Phase Transformers

Features

Agency Compliance



- NEMA Type 12, IP54 enclosure.
- All copper windings.
- IEC type finger safe terminals.
- 200°C (H) Insulation System.
- 50/60 Hertz.
- Class 1, general use, isolating transformer.
- All Series ES are provided with an electro-static shield.
- All Series ES are provided with a color coded protective earth (PE) terminal.
- Consult factory for desired voltage combinations and kVA sizes not listed.



Series ES Three Phase and Industrial Control Transformers

Please see Series ES CE Marked Three Phase on pages 36 - 37 and Industrial Control transformers on pages 82 - 83 of this catalog. A Declaration of Conformity is available by contacting your Dongan® Representative or the factory Customer Service Department.

Dimensions & weights may change. Consult factory for certified drawings.

Suffix .326				
Primary Connections		Secondary Connections		
Pri. Voltage	Connect Incoming Lines To:	Sec. Voltage	Connect Load Lines To:	
380	H1 & H3	110	X1 & X3	
400	H1 & H3	115	X1 & X3	
416	H1 & H4	115	X1 & X4	
440	H1 & H4	120	X1 & X4	
460	H1 & H4	115	X1 & X3	
480	H1 & H4	120	X1 & X3	
575	H1 & H5	120	X1 & X4	

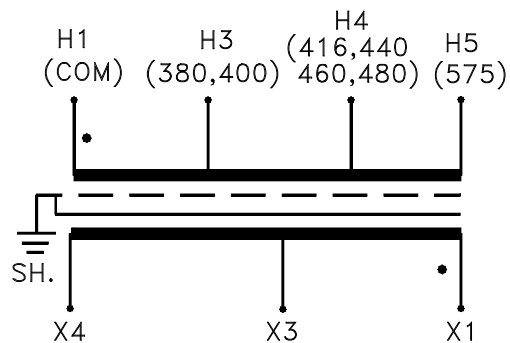

Suffix .359				
Primary Connections		Secondary Connections		
Pri. Voltage	Connect Incoming Lines To:	Sec. Voltage	Interconnect	Connect Load Lines To:
220	H1 & H3	120	X1 to X3 X2 to X4	X1 & X4
380	H1 & H4	240	X2 to X3	X1 & X4
400	H1 & H5	120/240	X2 to X3	X1 & X2X3 & X4
416	H1 & H6			

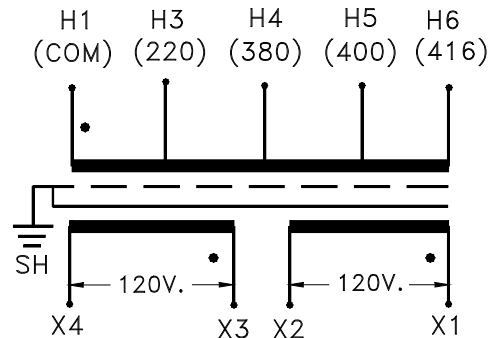

Series 33 - Control Transformers

Series 33 Control Transformers are designed with a NEMA Type 1, indoor type enclosure and are fitted with 8" leads exiting through a 1/2" chase nipple. Dual mounting provisions are provided for both foot mount or direct knockout mount in point of use applications. This unique mounting feature conveniently locates all leads within enclosures or handy boxes.

The 33 Series Transformers are normal reactance, isolation type designs. Typical applications include voltage reduction for solenoids, magnetic switches, control valves, as well as many other HVAC applications.

Features



- NEMA Type 1, indoor enclosure.
- Available primary voltages include 480, 277, 240, 208, 120, 50 / 60 Hertz.
- Special order voltages include 600, 380, 115, 12, and 6 volts.
- Available with manually resettable circuit breakers.
- Consult factory for desired voltage combinations and VA sizes not listed.
- Dual mounting capability.

General Information			Capacity		Dimensions					
kVA Cap.	Catalog Number	Wgt. Lbs	Maximum Amps		Height A	Width B	Depth C	Mounting		Slot Size F
			Pri.	Sec.				D	E	
Primary 240 Volts, Secondary Volts 120, 50 / 60 Hz										
.050	33-050-H	2.7	.20	.41	3.19	3.00	2.50	1.69	2.50	.188 x .344
.100	33-100-H	4	.41	.83	3.63	3.38	2.81	2.13	2.50	.188 x .375
Primary Volts, 240 x 480, Secondary Volts 24, 50 / 60 Hz										
.050	33-050-HLK	2.7	.20/.10	2.08	3.19	3.00	2.50	1.69	2.50	.188 x .344
.100	33-100-HLK	4	.41/.21	4.16	3.63	3.38	2.81	2.13	2.50	.188 x .375
Primary Volts 120, Secondary 24, 50 / 60 Hz										
.050	33-050-K	2.7	.41	2.08	3.19	3.00	2.50	1.69	2.50	.188 x .344
.100	33-100-K	4	.83	4.16	3.63	3.38	2.81	2.13	2.50	.188 x .375
Primary Volts 240 x 480, Secondary Volts 120, 50 / 60 Hz										
.050	33-050-PM	2.7	.20/.10	.41	3.19	3.00	2.50	1.69	2.50	.188 x .344
.100	33-100-PM	4	.41/.21	.83	3.63	3.38	2.81	2.13	2.50	.188 x .375
.150	33-150-PM	6	.62/.31	1.25	4.00	3.75	3.13	2.38	3.25	.219 x .375
.250	33-250-PM	9	1.0/.52	2.08	4.25	3.75	4.500	3.125	3.250	.219 x .438
Primary Volts 208, Secondary Volts 120, 50 / 60 Hz										
.050	33-050-17	2.7	.24	.41	3.19	3.00	2.50	1.69	2.50	.188 x .344
.100	33-100-17	4	.48	.83	3.63	3.38	2.81	2.13	2.50	.188 x .375
Primary Volts 208, Secondary Volts 24, 50 / 60 Hz										
.050	33-050-18	2.7	.24	2.08	3.19	3.00	2.50	1.69	2.50	.188 x .344
.100	33-100-18	4	.48	4.16	3.63	3.38	2.81	2.13	2.50	.188 x .375
Primary Volts 277, Secondary Volts 24, 50 / 60 Hz										
.050	33-050-26	2.7	.18	2.08	3.19	3.00	2.50	1.69	2.50	.188 x .344
.100	33-100-26	4	.36	4.16	3.63	3.38	2.81	2.13	2.50	.188 x .375
Primary Volts 277, Secondary Volts 120, 50 / 60 Hz										
.050	33-050-82	2.7	.18	.41	3.19	3.00	2.50	1.69	2.50	.188 x .344
.100	33-100-82	4	.36	.83	3.63	3.38	2.81	2.13	2.50	.188 x .375

Dimensions & weights may change. Consult factory for certified drawings.

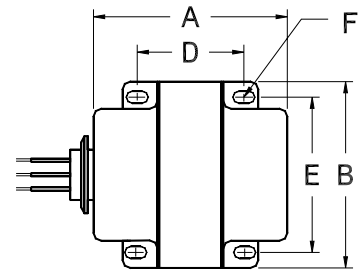

SINGLE PRIMARY

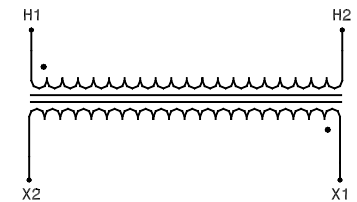

DUAL PRIMARY

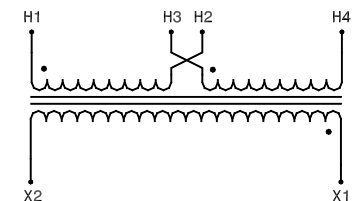

Series 36 - Signaling

Series 36 Signaling Transformers are designed to operate a wide variety of low voltage devices including complete signaling systems, AC horns and bells, and low voltage relays and controls. All 36 Series are supplied with a spacious wiring compartment and double knockouts for ease of installation.

Other low voltage transformers may be found in the 33 Series and in the General Purpose Type M, Type Y and Type LM Series.

Features



- NEMA Type 1 indoor enclosure.
- VA Capacity range from 50 VA to 1000 VA.
- Available primary voltages include 120, 240, and 480.
- 60 Hertz.
- Multiple secondary voltages of 4-8-12-16-20-24.
- Primary and secondary leads are partitioned in separate wiring compartments.
- Consult factory for desired voltage combinations and VA sizes not listed.

General Information			Capacity		Dimensions (inches)				
kVA Cap.*	Catalog Number	Wgt. Lbs	Maximum Amps		Height A	Width B	Depth C	Mounting	
			Pri.	Sec.				D	E
Primary Volts 120, Secondary Volts 4-8-12-16-20-24, 60 Hz									
.050	36-05-A	4	.41	2.08	6.31	3.63	3.37	5.56	2.50
.100	36-10-A	6	.83	4.16	7.12	4.06	3.50	6.44	2.50
.250	36-25-A	9	2.08	10.4	8.00	5.00	4.13	7.25	2.50
.500	36-50-A	16	4.16	20.8	11.50	5.88	4.88	10.50	3.81
.750	36-75-A	21	6.25	31.2	12.38	5.88	4.88	11.25	3.81
1.0	36-100-A	29	8.33	41.6	13.63	5.88	4.88	12.50	3.81
Primary Volts 240, Secondary Volts 4-8-12-16-20-24, 60 Hz									
.050	36-05-C	4	.20	2.08	6.31	3.63	3.37	5.56	2.50
.100	36-10-C	6	.41	4.16	7.12	4.06	3.50	6.44	2.50
.250	36-25-C	9	1.0	10.4	8.00	5.00	4.13	7.25	2.50
.500	36-50-C	16	2.08	20.8	11.50	5.88	4.88	10.50	3.81
.750	36-75-C	21	3.13	31.2	12.38	5.88	4.88	11.25	3.81
1.0	36-100-C	29	4.16	41.6	13.63	5.88	4.88	12.50	3.81
Primary Volts 480, Secondary Volts 4-8-12-16-20-24, 60 Hz									
.050	36-05-N	4	.10	2.08	6.31	3.63	3.37	5.56	2.50
.100	36-10-N	6	.20	4.16	7.12	4.06	3.50	6.44	2.50

*VA capacity at 24 volt secondary tap only. To determine VA capacity at other secondary taps, multiply voltage of tap being used by maximum secondary current. Example: Using 8 volt tap on 36-10-A, VA capacity would be 8 (volts) x 4.16 (amps) = 33.6 VA.

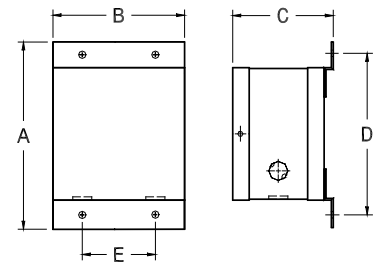

50 VA - 250 VA Wall Mount

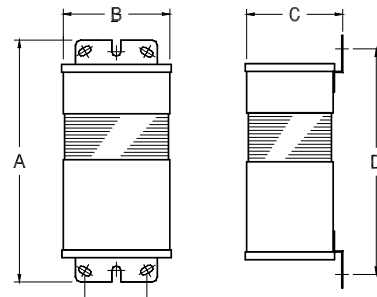

500 VA - 1000 VA Wall Mount

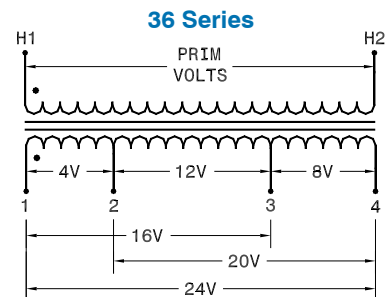

Shaded catalog numbers on this page indicate transformers not carried in factory stock. Consult factory or your Dongan® Representative for price and delivery.

Dimensions & weights may change. Consult factory for certified drawings.

Series HL - Hazardous Location

Series HL - Hazardous Location Transformers are designed for applications where the possibility of a fire or explosion may result from sparks in environments containing high concentrations of dust, gases or other volatile substances.

Series HL transformer's wiring compartments are completely filled with electrical grade silica and resin, leaving no access to the core and coil or other internal components. This feature also minimizes air spaces where combustible particulates and gases may accumulate. The transformer's lead length is sufficient to allow connection to customer provided explosion-proof boxes.

Note: all unused leads must be insulated in accordance with all applicable codes and standards.

Features

- **UL Recognized Component E100887**
- NEMA Type 12 indoor/outdoor enclosure.
- Capacity range from .500 kVA to 25 kVA.
- Primary and secondary leads are approximately 18 inches long.
- Available primary voltages include 120, 208, 240, 277, 480, 600, 60 Hertz.
- Consult factory for desired voltage combinations and VA sizes not listed.
- Stainless steel enclosures are also available.
- Electrostatic shield provided on all units.

General Information											
Pri. Volts	240 x 480	120 x 240	208	277	600	Dimensions (inches)					Weight (lbs)
Sec. Volts	120 / 240	120 / 240	120 / 240	120 / 240	120 / 240						
	60 Hz	60 Hz	60 Hz	60 Hz	60 Hz						
kVA Cap.	Catalog Number	Catalog Number	Catalog Number	Catalog Number	Catalog Number	Height A	Width B	Depth C	Mounting		Weight (lbs)
									D	E	
.500	HL12-1025SH	HL12-6025SH	HL12-3025SH	HL12-4025SH	HL12-5025SH	10.50	10.00	6.62	6.12	4.00	40
.750	HL12-1030SH	HL12-6030SH	HL12-3030SH	HL12-4030SH	HL12-5030SH	10.50	10.00	6.62	6.12	4.00	42
1.0	HL12-1035SH	HL12-6035SH	HL12-3035SH	HL12-4035SH	HL12-5035SH	10.50	10.00	6.62	6.12	4.00	45
1.5	HL12-1040SH	HL12-6040SH	HL12-3040SH	HL12-4040SH	HL12-5040SH	10.50	10.00	6.62	6.12	4.00	50
2.0	HL12-1045SH	HL12-6045SH	HL12-3045SH	HL12-4045SH	HL12-5045SH	12.00	10.81	7.19	6.69	6.00	75
3.0	HL12-1050SH	HL12-6050SH	HL12-3050SH	HL12-4050SH	HL12-5050SH	12.00	10.81	7.19	6.69	6.00	80
5.0	HL12-1055SH	HL12-6055SH	HL12-3055SH	HL12-4055SH	HL12-5055SH	14.00	14.00	9.25	8.75	8.00	140
7.5	HL12-1060SH	HL12-6060SH	HL12-3060SH	HL12-4060SH	HL12-5060SH	14.00	14.38	10.25	9.75	8.00	205
10	HL12-1065SH	HL12-6065SH	HL12-3065SH	HL12-4065SH	HL12-5065SH	14.00	14.38	10.25	9.75	8.00	230
15	HL12-1070SH	HL12-6070SH	HL12-3070SH	HL12-4070SH	HL12-5070SH	15.00	18.00	12.50	12.00	8.00	260
25	HL12-1075SH	HL12-6075SH	HL12-3075SH	HL12-4075SH	HL12-5075SH	15.00	18.00	12.50	12.00	8.00	320

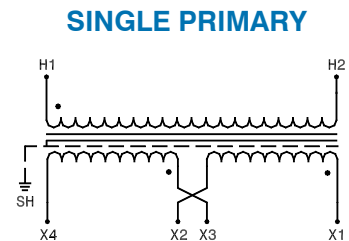
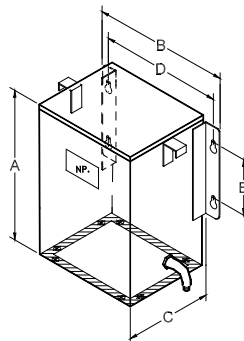
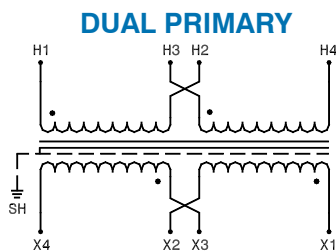

Series HL

Wall Mount - Encapsulated - NEMA 12 - IP54

Dimensions & weights may change. Consult factory for certified drawings.

Series 21HG - Hospital Isolation Transformers

Series 21HG - Medical Isolation Transformers are designed for installations requiring the use of an isolated, single phase power supply in nonhazardous areas of health care facilities. They feature low leakage current values of 20 to 50 microamperes demanded in hospital line isolation applications.

The low profile series feature "pancake" designs to fit shallow wire ways and enclosures for operating rooms and other demanding hospital environments. All Series 21HG feature electrostatic shields and convenient wire lead termination. Other terminations are available by consulting the factory or your Dongan® Representative.

Series 21HG are UL Recognized under Standards UL1047 and UL 506, File E155483.

Features

- **UL Recognized, File E155483.**
- **Complies with UL Standards 506 & 1047.**
- **Core and Coil designs, 60 Hertz.**
- UL Recognized 200°C insulation system File E100887.
- Single Phase designs in sizes:
3 kVA to 15 kVA - Low Profile Style.
15 kVA to 37.5 kVA - Upright Style.
- Ground terminal and electrostatic shield provided on all units.
- All Copper windings.
- Leakage current values range from 20 to 50 microamperes depending on kVA size and secondary voltage.
- Consult factory for desired voltage combinations and kVA sizes not listed.

General Information												
Pri. Volts	120	208	240	277	277	480	Dimensions (inches)					Weight (lbs)
Sec. Volts	120	120	120	120	208	120						
	60 Hz	60 Hz	60 Hz	60 Hz	60 Hz	60 Hz	A	B	C	Mounting		
kVA Cap.	Catalog Number	Catalog Number	Catalog Number	Catalog Number	Catalog Number	Catalog Number				D	E	
Low Profile Series, Prefix 21HG												
Choose Suffix below for proper voltage / kVA combination												
3	-0313	-0301	-0305	-0302	-0308	-0304	12.50	15.00	5.00	11.25	12.75	55
5	-0513	-0501	-0505	-0502	-0508	-0504	12.50	15.00	5.00	11.25	12.75	90
7.5	-0713	-0701	-0705	-0702	-0708	-0704	14.50	17.00	5.50	13.25	15.25	100
10	-1013	-1001	-1005	-1002	-1008	-1004	14.50	17.00	7.00	13.25	15.25	135
15	-1513	-1501	-1505	-1502	-1508	-1504	14.50	17.00	7.00	13.25	15.25	145
Upright Series, Prefix 21HG												
Choose Suffix below for proper voltage / kVA combination												
15	-1513FM	-1501FM	-1505FM	-1502FM	-1508FM	-1504FM	18.00	13.00	7.50	10.00	6.25	145
25	-2513FM	-2501FM	-2505FM	-2502FM	-2508FM	-2504FM	18.00	13.00	8.75	10.00	6.88	190
37.5	-3713FM	-3701FM	-3705FM	-3702FM	-3708FM	-3704FM	18.00	13.00	10.50	10.00	8.50	290

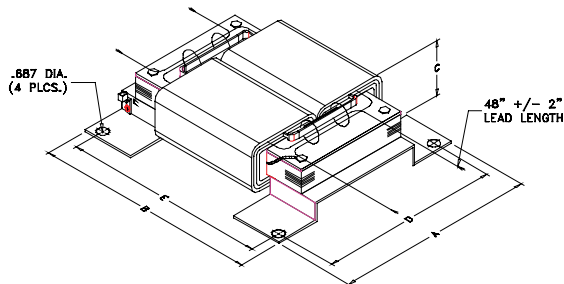

Low Profile Series - Wall Mount

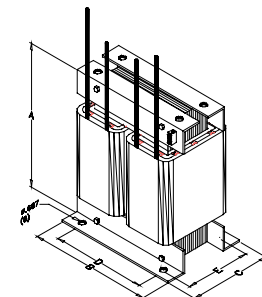
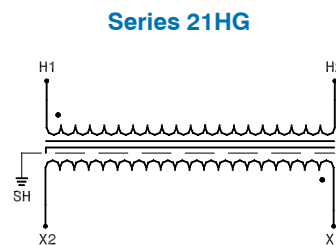

Upright Series - Floor Mount

Dimensions & weights may change. Consult factory for certified drawings.

Single Phase Outline Drawings

Outline Drawings

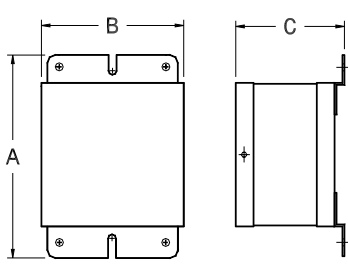

Outline Drawing 1 - Wall Mount

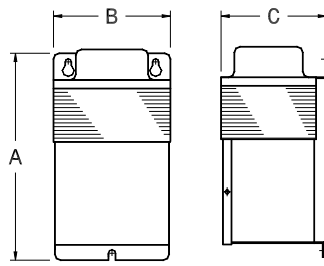

Outline Drawing 2 - Wall Mount

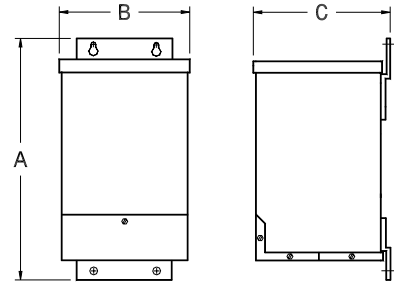

Outline Drawing 3 - Wall Mount

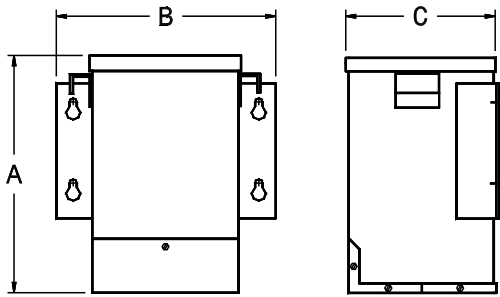

Outline Drawing 4 - Wall Mount

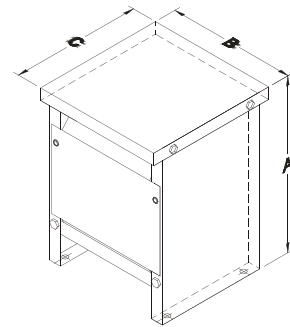

Outline Drawing 5 - Floor Mount

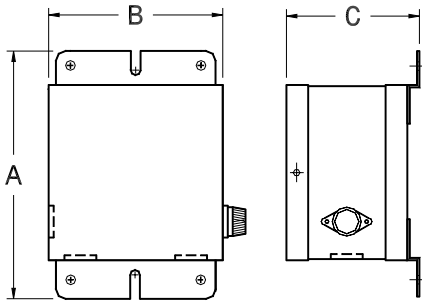

Outline Drawing 6 - Wall Mount

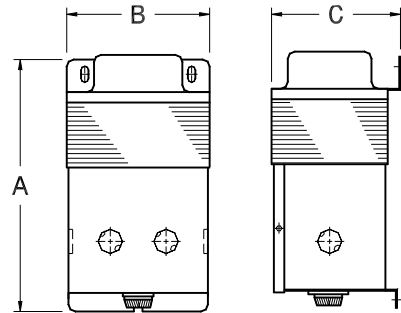

Outline Drawing 7 - Wall Mount

Wall Mounting Brackets - Single Phase 7.5 kVA - 50 kVA

Single Phase
7.5 - 25 kVA
Catalog No.
BR - 890

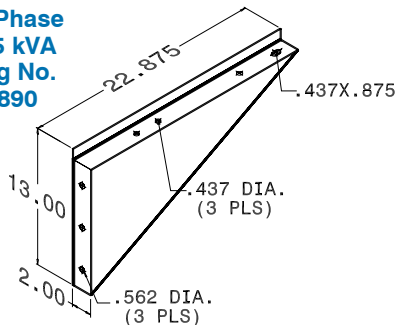

Single Phase
37.5 - 50 kVA
Catalog No.
BR - 892

