

# SITECH GULF

Increase Productivity With The Latest  
Positioning Technology

## PRODUCT CATALOG



YOUR CONSTRUCTION TECHNOLOGY PROVIDER

[SITECHGULF.COM](http://SITECHGULF.COM)





## Dear Construction Professional,

SITECH Gulf™ was formed in 2012 as a part of the Mohamed Abdulrahman Al-Bahar group of companies to assist its valued customers in implementing the productivity gains of machine control in the U.A.E., Oman, Qatar, Bahrain and Kuwait. As a member of a distribution network for the most reliable and rugged construction technology systems available to the heavy and highway contractor today.

The experienced construction professionals at SITECH Gulf™ provide local customer service, personalized training and technical support. We will guide you on how to leverage Trimble and Caterpillar machine control systems for your entire fleet of heavy equipment along with Trimble’s complete portfolio of Connected Site Solutions: Site Positioning Systems, Construction Asset Management Services, Construction Software, Crane Safety and Lifting Solutions, and powerful wireless and internet-based infrastructures.

Learn how easy it is to utilize technology that makes significant improvements in project workflow, dramatically increases your production, improves your accuracy and lowers your operating costs. And the proof that it works: documented increases on your bottom-line. With the addition of Trimble site-wide solutions to your heavy and highway projects, you’re in a more powerful competitive position in the marketplace, whether you choose to start small or go all in, the expanded capability will enable you to earn the bid and be profitable, project after project. Grow your business with the assistance of the SITECH Gulf™ team.

## ANY CONSTRUCTION PROJECT

Topo & Stakeout



Site Positioning Systems

Design & Take Off



Software Solutions

Rough Grading



2D/3D Machine Control

## RESURFACING ROADS AND AIRPORTS

Milling



2D/3D Machine Control

Paving



2D/3D Solutions

Asphalt Compaction



Temperature & Passcount Mapping

# MACHINE CONTROL SYSTEMS

CONSTRUCTION TECHNOLOGY FOR HEAVY & HIGHWAY CONTRACTORS

## BENEFITS OF MACHINE CONTROL

Machine control is quickly becoming adopted worldwide due to the performance gains that can be obtained using this technology. Production studies by machine manufacturer's, universities and here in the Gulf by SITECH® have shown amazing results.

**INCREASED JOB SAFETY**

**43% SAVINGS IN DIESEL FUEL**

**98% ON GRADE ACCURACY**

**100% INCREASE IN PRODUCTIVITY**

Fine Grading



2D/3D Machine Control

Soil Compaction



Compaction Value & Passcount Mapping

Paving



2D/3D Solutions

Profiling



3D Machine Control

Pipelines



2D/3D Machine Control

Underwater Profiles



3D Submersible Machine Control



## MACHINE CONTROL TECHNOLOGY

Trimble® and Caterpillar® have co-developed the most robust portfolio of machine control and guidance systems in the industry. These systems leverage our shared expertise in machine control and guidance technologies, Trimble's expertise in data management, software, positioning and jobsite infrastructure and Caterpillar's expertise in heavy equipment in the construction industry.

## TRIMBLE® MACHINE CONTROL TECHNOLOGY

For non-Caterpillar machines SITECH Gulf™ can install Trimble® GCS900 machine control on all major manufactures equipment. Many machines from these manufacturers will require additional hydraulic controls but many of the newer models will be Trimble ready for easy installation.

Trimble® GCS machine control technology works seamlessly with these other manufacturers products providing a consistent system for your mixed fleet.

## CAT ACCUGRADE™

Caterpillar® was the first heavy equipment manufacturer with a machine control and guidance solution that is integrated throughout the product line. The Cat AccuGrade™ system has been designed in conjunction with the Cat machines' electro-hydraulic systems for maximum performance and response on a Cat machine. Many Cat machines such as the "M" series graders are Grade Control Ready, which simplifies system installation and optimizes reliability. Al Bahar has established SITECH Gulf™ as Trimble's SITECH® dealership to provide site wide construction technology and support for a breadth of jobsite needs, both in the office and in the field. Only SITECH Gulf™ can provide the level of support available from a partnership of Trimble® and Caterpillar®.



## 2D MACHINE CONTROL SYSTEMS

2D Machine Control Systems provide accurate elevation control suitable for many projects from initial site prep through to the finished grading and paving. Trimble® machine control systems can be configured for just about any machine including dozers, graders and excavators. All components are easy to use, quick to set up and extremely durable to ensure the highest uptime and longest life possible in jobsite conditions. Additionally these systems can be operated in manual or auto mode; in auto mode the blade is automatically moved to the correct position.



## 3D MACHINE CONTROL SYSTEMS

Trimble® machine control systems are the most versatile grading technologies available and can be used on a wide range of machine types including excavators, dozers, motor graders, compactors, milling machines, trimmers, pavers and more. 3D Machine Control Systems significantly reduce material overages and dramatically improving productivity, accuracy and profitability. The 3D systems can be operated in manual or auto mode depending on the application, in automatic mode the design controls the blade for optimum accuracy and productivity.

# MACHINE CONTROL SYSTEMS

## CONSTRUCTION TECHNOLOGY FOR HEAVY & HIGHWAY CONTRACTORS

### FULLY SCALABLE

Only our machine control is flexible enough to let you equip your entire fleet—excavators, dozers, scrapers, graders, trimmers, milling machines, compactors, pavers and more—with fully upgradeable technology. Start where you need to start and add as you need to add. Sonic, angle sensors, laser, GNSS, total station ... select the best option for the machine and application.

	CONFIGURATION	TARGET MACHINES	DESCRIPTION	KEY COMPONENTS
2D MACHINE CONTROL SYSTEMS	<b>SINGLE ELEVATION</b>	dozers graders	Single control system that uses a laser receiver to control the lift of the machine blade for flat work and finished grading	Laser Laser receiver Control box
	<b>DUAL ELEVATION, OR ELEVATION AND BLADE SLOPE CONTROL</b>	dozers graders	Dual control system that controls both the lift and tilt of the machine blade for flat and slopework and finished grading	Laser 2 Laser receiver -or- Laser receiver Slope sensor Control box
	<b>CROSS-SLOPE CONTROL</b>	graders	Cross-slope control system to be used on motor graders for fine grading work for road maintenance, ditches and slope work	2 angle sensors Rotation sensor Control box
	<b>CROSS-SLOPE AND ELEVATION CONTROL</b>	graders	Highly flexible cross-slope and elevation control system for fine grading work with tight tolerances for road maintenance and construction, embankments, flat and slope work	2 angle sensors Rotation sensor Laser receiver -or- Sonic tracer Control box
	<b>DEPTH, SLOPE, AND ELEVATION</b>	excavators	Highly flexible system for excavation, trenching, grading and profile work	Angle sensors Laser catcher Control box
	<b>GRADE AND SLOPE CONTROL</b>	asphalt pavers	Grade and slope control system for paving of base material and asphalt	Sonic tracer Sonic averaging beam Contact sensor Slope sensor Control box
3D MACHINE CONTROL SYSTEMS	<b>SINGLE GNSS</b>	dozers graders scrapers excavators	Cost effective, full 3D control system that measures the position and slope of the blade and compares that to design data for rough grading and mass excavation on complex design surfaces	Angle and rotation sensors Single Smart GNSS Antenna Control box Rugged on-machine radio
	<b>DUAL GNSS</b>	dozers graders scrapers excavators	Full 3D control system that measures the exact position, cross slope and heading of the blade, bucket, drum for rough grading and mass excavation on steep slopes and complex design surfaces	Dual Smart GNSS Antennas Control box Rugged on-machine radio
	<b>SINGLE OR DUAL GNSS</b>	soil compactors	Continuous compaction control and documentation for Soil Compaction with real-time material compaction mapping and detection	Single or dual Smart GNSS Antenna(s) Compaction sensor Control box Rugged on-machine radio
	<b>SINGLE OR DUAL GNSS WITH LASER AUGMENTATION</b>	dozers graders	Single and dual GNSS systems enhanced with laser augmentation to improve vertical accuracy for high accuracy guidance to complex design surfaces such as super-elevation grading for rough through finished grade work	Single or dual Smart GNSS Antenna(s) Laser receiver Control box Rugged on-machine radio
	<b>UNIVERSAL TOTAL STATION</b>	dozers graders excavators soil compactors	Total station based system for applications requiring extreme accuracy for lift and layer control, material monitoring, or for jobs where GNSS is not the ideal solution because of overhead obstructions	Single on-machine active target Control box Rugged on-machine radio Universal Total Station
	<b>UNIVERSAL TOTAL STATION</b>	asphalt pavers milling machines trimmers	Total station based systems for high accuracy paving, milling and trimming without stringlines	Single on-machine active target Control box Rugged on-machine radio Universal Total Station

# 2D GRADE CONTROL SYSTEMS

## FOR SIMPLE EXCAVATION

**SITECH Gulf™** has affordable 2D systems that can help you achieve excellent results for many projects not requiring 3D positioning like parking areas, runways, building sites and simple excavation. A Trimble® GL series automatic grade laser and laser receiver will accurately measure depth and slope for any excavation. To measure the slope of the blade, add another laser receiver or a slope sensor. An in-cab Trimble® CB450 or CB460 Control Box provides elevation and slope guidance, so you can more accurately and quickly get to grade. Trimble® 2D Grade Control can be upgraded to a 3D Grade Control System.



### TRIMBLE LR410 LASER RECEIVER

The Trimble® LR410 is mounted to a mast on the blade and connected to the machine hydraulics to control lift to a sub cm accuracy.

### TRIMBLE ST400 SONIC TRACER

The Trimble® ST400 is mounted to the blade and uses a physical reference such as curb, gutter and stringline.

### TRIMBLE GCSFLEX

The Trimble® GCSFlex™ 2D Solution offers contractors a reliable, flexible and affordable option to leverage machine control technology. With several configuration options available, it can be used for a variety of excavation projects including digging for basements and footers, and trenching for conduit and utilities.



# 2D GRADE CONTROL SYSTEMS

## FOR COMPACT MACHINES

### SPECTRA PRECISION CB30 DUAL CONTROL BOX FOR AUTOMATED 2D MACHINE CONTROL

The advanced, yet affordable Spectra Precision® CB30 Dual Control Box simultaneously controls lift and tilt of a skid-steer loader attachment, drag box, small dozer or grader blade.

The CB30 is an automatic machine control product that is ideal for contractors who need affordable, automatic, accurate grade control for leveling projects. The CB30 delivers reduced costs, greater jobsite efficiency, and fast return on investment.

#### Features

- Advanced, yet affordable lift and tilt in one control box
- Simultaneous, automatic control of lift and tilt of blade or attachment
- Designed-in flexibility performs simple elevation display to more complex grading jobs requiring automatic elevation and slope blade control
- Used with Spectra Precision® Laser LR50 Grade Display Receiver and Spectra Precision® Laser LR60 Grade Display Receiver.

#### Applications

- Building pads
- Sports fields
- House pads



### SPECTRA PRECISION LR50 RUGGED 360-DEGREE LASER DISPLAY RECEIVER

The Spectra Precision® Laser LR50 Laser Display Receiver is designed to be used as a stand-alone display receiver or in conjunction with the CB30 on grading and excavating equipment including: dozers, excavators, backhoes, scrapers, and box blades. The easy-to-use LR50 features versatile 360-degree laser reception with built-in blade tilt and excavator boom plumb indicator.

The LR50 works with many types of rotating lasers on all types of machinery for fast, no-hassle setup. Rugged and waterproof, the LR50 receiver withstands all weather environments. Internal isolating shock mounts protect the electronics.



#### Features

- Built-in blade tilt indicator helps the operators keep the blade level for increased accuracy and productivity.
- Center On-grade provides an equal amount of grade information above and below on-grade. Use on dozers, graders, scrapers and box blades.
- Offset on-grade for productive excavation provides additional above grade information for less undercuts.
- Built-in plumb indicator for fast, accurate grade checking for excavators and backhoe's.
- Up to six channels of grade information plus directional out-of-laser beam indicators.
- Three selectable accuracies meet job tolerances from rough grading to final finishing for maximum flexibility.
- Adjustable, ultra-bright LED with green on-grade display provides user selectable, easy-to-see display to match ambient lighting conditions.



# GRADE CONTROL SYSTEMS

## FOR GRADERS



### TRIMBLE GCS900 3D GRADE CONTROL SYSTEM FOR GRADERS

The Trimble® GCS900 or Cat® Accugrade™ Grade Control System for graders with dual GPS can be installed on motor graders for a wide range of earthmoving applications helping contractors to significantly improve their productivity and profitability. The 3D Machine Control System on a motor grader is a full 3D control system that puts the site plan – design surfaces, grades and alignments – inside the cab.

The Trimble patented dual GPS antenna configuration is preferred for GPS-based Grade Control Systems. Using GPS, the exact position, very accurate cross slope, and heading of the blade is measured. This is especially advantageous for complex design surfaces such as super-elevation grading tasks.

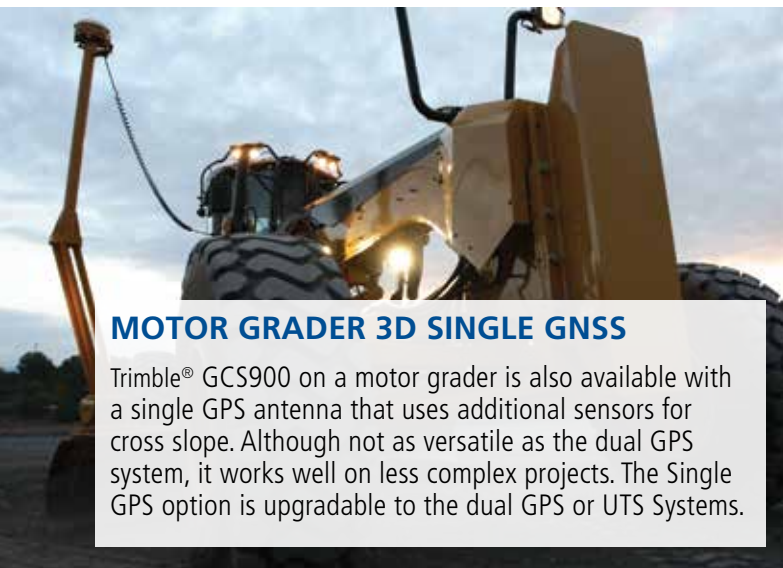

### MOTOR GRADER 3D SINGLE GNSS

Trimble® GCS900 on a motor grader is also available with a single GPS antenna that uses additional sensors for cross slope. Although not as versatile as the dual GPS system, it works well on less complex projects. The Single GPS option is upgradable to the dual GPS or UTS Systems.

The on-board computer uses this position information, and compares it to the design elevation to compute cut or fill to grade. This information displays on the Control Box screen in plan, profile, cross-section view, or text. The cut/fill data is also used to drive the valves for automatic blade control. Additionally, the cut/fill data is passed to the control box lightbars, providing additional visual guidance to the operator for up/down to grade and right/left to a defined alignment. The GCS900 on a motor grader can be operated in either indicate or automatic mode.

The Trimble® SR300 laser augmentation mast can be used to improve the vertical accuracy to sub cm precision.





# UNIVERSAL TOTAL STATION SYSTEMS FOR GRADERS



## TRIMBLE SPS730/SPS930 UNIVERSAL TOTAL STATIONS

### Grader Blade Control Sub 1cm

When the tightest of tolerances must be met or surrounding site obstructions may block out GNSS signals, the SITECH® UTS System will get the job done. Using the robotic Trimble Universal Total Stations, the exact position, accurate cross slope and heading of the blade is measured.

A SITECH® UTS system on a motor grader with the Trimble® Universal Total Station is ideal for contractors who need the flexibility to move from site to site frequently, work in confined spaces, or require high-precision grading. For jobs where GNSS is not a viable technology, such as in urban canyons, mountainous areas, or on job sites with numerous overhead obstructions such as overpasses, the total station offers a 3D grading solution.



## TRIMBLE UNIVERSAL TOTAL STATION

The Trimble® SPS Universal Total Stations can control graders as well as dozers, excavators, pavers, milling machines and small machines.



## TRIMBLE MT900 MACHINE TARGET

Patented Trimble® Active Tracking Technology guarantees total station lock to the on-machine target and millimeter control of the machine.



# 3D GRADE CONTROL SYSTEMS

## FOR EXCAVATORS



### TRIMBLE GCS900 3D GRADE CONTROL SYSTEM

The Trimble® GCS900 Grade Control System with dual GPS can be installed on all excavators including those with tilt buckets and extended booms for mass excavation projects. The system uses two GPS receivers and solid state angle sensors to measure the precise 3D position of the tip of the bucket.



#### FEATURES & BENEFITS:

- Significant cost savings
- Less time to completion
- Less rework
- No waiting for stakes to be set
- More accurate, more consistent excavations
- Perform more complex excavation

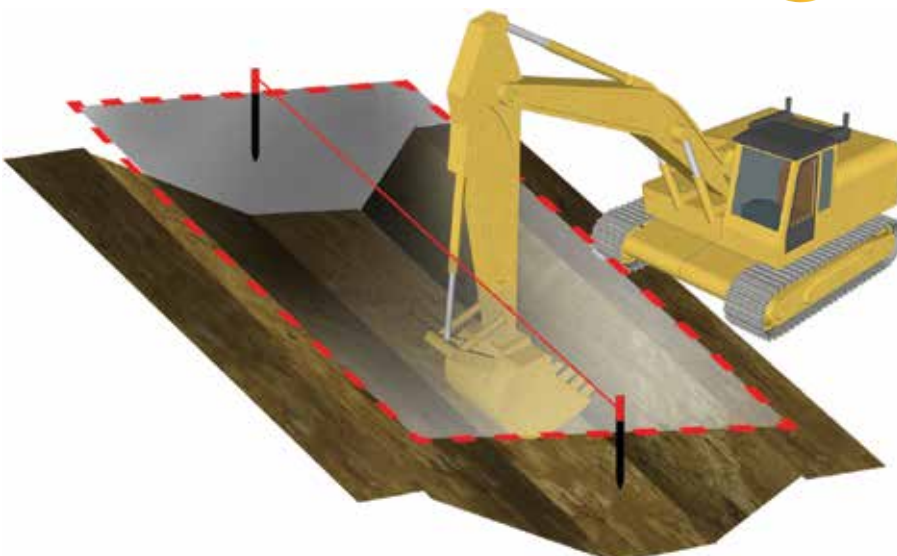

#### APPLICATIONS:

- Roads and highways - rough grading
- Large earthmoving projects - dams, reclamation, etc.
- Landfills and waste deposits
- Commercial site prep- complex design
- Pipelines
- Underground utilities

# EARTHWORKS GRADE CONTROL SYSTEM FOR EXCAVATORS



## TRIMBLE EARTHWORKS GRADE CONTROL SYSTEM

The new Trimble® Earthworks Grade Control Platform is designed to help you do more in less time. Reengineered from the ground up, our innovative, next generation grade control platform features intuitive, easy-to-learn software that runs on an Android operating system. And state-of-the-art software and hardware give operators of all skill levels the ability to work faster and more productively than ever before.



## INTUITIVE SOFTWARE, RUGGED HARDWARE

The Trimble® Earthworks grade control application runs on the new 10-inch (25.7 centimeter) Trimble® TD520 touch-screen Android display or third-party Android tablets. The software was created in collaboration with construction equipment operators around the world, so the interface is optimized for ease-of-use and productivity.

Colorful graphics, natural interactions and gestures, and self-discovery features make Earthworks intuitive and easy to learn. Each operator can personalize the interface to match their workflow and a variety of configurable views make it easier to see the right perspective for maximum productivity. Earthworks allows data files to be transferred to or from the office wirelessly and automatically so you've always got the latest design.



# 3D GRADE CONTROL SYSTEMS

## FOR DOZERS

### Dual Antenna or Single

Dozers have the option to be fitted with one or two GPS receivers depending on the application, your SITECH Gulf™ representative can guide you on the system that maximizes your productivity depending on your application. Single GPS systems with "indicate" are often all that is required on bulk earthmoving applications, upgrading to fully automatic and dual GPS configurations the closer to finish grade and more complex the design the dozer is used for.



## TRIMBLE GCS900 3D GRADE CONTROL SYSTEM FOR DOZERS

Helps you achieve accurate finished grade with fewer passes. Design information and live cut/fill indications are displayed in the cab, allowing the job to be done safer, much faster and without the need for survey stakes. The dozer blade control can be completely automatic or the operator can use the in cab display and control the operation himself.

The system provides real-time information for monitoring avoidance zones and simultaneously collects as-built data as the machine cuts to grade. With VisionLink this information can even be monitored remotely from your office.

All SITECH Gulf's dozer systems include Trimble's GradeMax™ technology, which doubles the update rate for GNSS data controlling blade movement. Faster data means smoother, more consistent control and rapid recovery of the dozer blade so operators can now grade higher quality surfaces at faster speeds, on simple or complex designs, and in any material type.



### TRIMBLE GNSS MS995 SMART ANTENNA

The Trimble® MS995 is an integrated GPS+GNSS receiver, antenna, and isolation system all in a single, extremely rugged housing. It uses the advanced Trimble® RTK engine for faster initialization times when satellite lock is lost and enhanced performance near obstructions.



### TRIMBLE SR300 LASER RECEIVER MAST

The Trimble® SR300 is mounted on the machine blade and used with a GL series Grade Laser for excellent vertical control.

It can also be added to a Trimble® GNSS Smart Antenna for enhanced vertical accuracy (sub 1cm).

# EARTHWORKS GRADE CONTROL SYSTEM FOR DOZERS

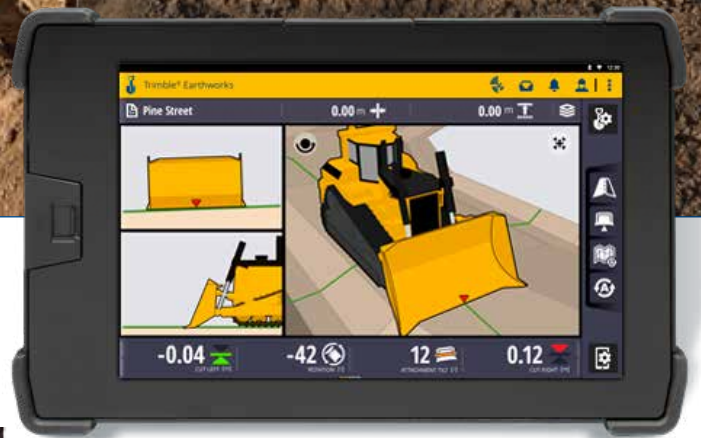

## TRIMBLE EARTHWORKS GRADE CONTROL FOR DOZERS

The new Trimble Earthworks for Dozers transforms machine control with integrated 3D intuitive capability. The new dozer configuration moves the receivers from the blade to the roof of the cab.

### Mastless Dozer Configuration

Trimble Earthworks for Dozers mounts dual GNSS receivers on top of the cab to eliminate masts and cables traditionally located on the blade. The dual GNSS receivers are ideal for steep slope work and complex designs with tight tolerances. The new configuration keeps valuable receivers safer and can also save contractors time by reducing the time needed to remove and reinstall them each day.



## INTUITIVE SOFTWARE, RUGGED HARDWARE

The Trimble® Earthworks grade control application runs same Trimble® TD520 touch-screen Android display or third-party Android tablets. The new dozer configuration software

was created in collaboration with construction equipment operators around the world, so the interface is optimized for ease-of-use and productivity.

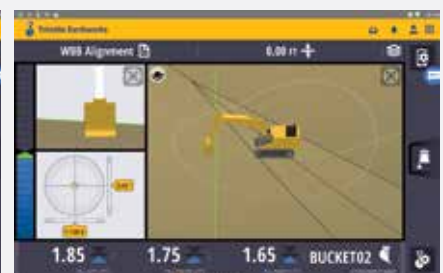

# GRADE CONTROL SYSTEMS

## FOR MARINE APPLICATIONS



### TRIMBLE MARINE POSITIONING SYSTEMS

You face any number of challenges in marine construction. Tidal height variations, currents, distance from land and a work area that you can't always see. Your ability to position a structure, vessel or dredge head can be compromised by everything from water depth to working at night or in foggy conditions. Trimble® Marine Positioning Systems can help you overcome these obstacles.

#### TRIMBLE ANTENNA

The Trimble® GA830 Antenna is a general purpose GNSS antenna designed for the marine environment. It can be used for both position and heading applications, and has excellent RTK and Mobile Satellite Services (MSS) performance.



#### TRIMBLE RECEIVERS

The Trimble® SPS361 and SPS461 GPS Heading and Positioning Receivers are modular dual antenna systems for marine construction providing you with head positioning, vessel positioning, vessel heading, pitch or roll.



#### TRIMBLE AS456 SENSOR

The Trimble® AS456 features an extremely rugged, sealed stainless steel enclosure with 1.8 centimeter walls for protection in salt water conditions up to a depth of 20m.



#### Breakwater Construction

Fully submersible excavators controlled either by GPS or Total Stations allows you to receive accurate 3D positioning of the bucket. The system guides the operator to quickly complete projects with far less assistance from divers and surveyors.



#### Dredging

With Trimble® Marine Positioning Systems you will know exactly how much earth you are moving even under water.



#### Barge

Positioning of pontoons and barges is challenging. With Trimble® RTK receivers you can monitor the positioning, heading, roll and pitch motions of the barge down to centimeter accuracy.



#### Cranes

The Trimble® solutions for 3D machine control for wire cranes is a solutions which allows the operator to see the location of the grab or hook with cm accuracy.



# MARINE CONSTRUCTION SOFTWARE



## TRIMBLE MARINE CONSTRUCTION SOFTWARE SOLUTIONS

Trimble® Marine Construction Software (TMC) is a software package for hydrographic survey and dredging operations. It offers modules that cover the entire operation from acquisition to an end product, the software runs on standard PC's with the Windows operating system.

Construction applications for Trimble® Marine Construction Software include dredging, cable lay applications, monopile placements, building breakwaters, windmill parks, pipe lay monitoring, rock dumping, excavating, barge management and more. Trimble's leading machine positioning technologies combined with Teledyne's leadership in subsurface sensing and marine software provide an innovative and ideal solution for marine construction contractors.

TMC Software extends SITECH's solutions to include real-time 3D visualization of the dredge head or bucket with support for scanning sonars to provide the actual as-built surface for more efficient operations.

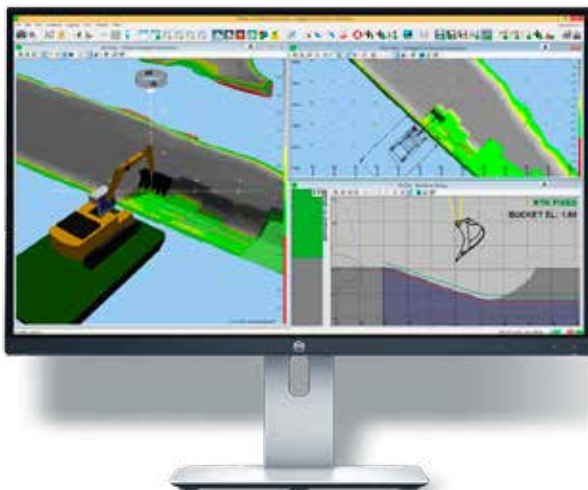
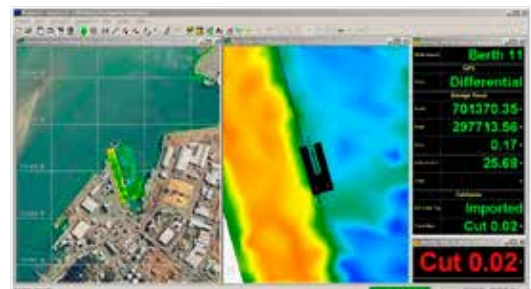

### Modules of Trimble Marine Construction Software include:

- TMC Excavator User
- TMC MotionScan
- TMC Excavator Installation
- TMC Guidance Editor
- TMC Cutter Dredge
- TMC Multibeam Calibration
- TMC Bucket Dredging
- TMC Multibeam and Profiler
- TMC Teledyne-BlueView Forward-Looking Sonar
- TMC Tide
- TMC Block Placement
- TMC Rope Excavator User
- TMC Vessel Editor

# 2D/3D GRADE CONTROL SYSTEMS

## FOR TERRAIN LEVELERS, TRENCHING



### TRIMBLE GCS900 GRADE CONTROL FOR TERRAIN LEVELERS AND TRENCHERS

The Trimble® GCS900 for terrain levelers and trenchers is available in 2D and 3D configurations. 3D configurations use either a Single MS995 with Cross Slope Sensors or Dual MS995 GPS Smart Antenna's to accurately control the machine. 2D systems use an LR410 Laser Receiver, cross slope sensors and Spectra Precision® rotating laser to control the elevation only. Most new Vermeer machines are standard Trimble Ready for quick installations.



#### 2D LASER SYSTEM

2D Systems use a Trimble® LR410 laser receiver, cross slope sensors and rotating laser to control the elevation only.



#### SINGLE GPS SYSTEM

A Single GPS system uses one Trimble® MS995 GNSS receiver and cross slope sensors to accurately control the cutting head depth & pitch.



#### DUAL GPS SYSTEM

A Dual GPS Systems uses two Trimble® MS995 GNSS receivers to accurately control the cutting head depth and pitch.



# 2D/3D PAVING CONTROL SYSTEMS

## FOR PAVERS AND MILLING OPERATIONS



### TRIMBLE PCS400 FOR 2D PAVING

The Trimble® PCS400 Averaging Beam uses three evenly spaced Trimble® ST200 Sonic Tracers to average out uneven reference surfaces. The Trimble® ST200 Sonic Tracers mounted on the averaging beam ignore irregularities such as grates, and stones that could otherwise decrease accuracy. The beam measures a 10.9m (extended up to 13.9m) in length as required by some governmental agencies and swings back behind the paver to reference both the adjoining surface and freshly laid mat.



### 3D PAVING AND MILLING WITH TRIMBLE PCS900

The Trimble® PCS900 Paving/Milling Control System adds the accuracy and flexibility of 3D technology to your paving and milling operations, giving you the flexibility of operating in either 2D or 3D mode, depending on project needs.

The Trimble® PCS900 uses highly accurate robotic total stations to precisely Pave or Mill with variable depth and slope based on the 3D design.

The Trimble® PCS900 3D paving system regularly achieves asphalt mat accuracies of 3-6 millimeters, making it ideal for projects such as airports, large commercial surfaces and highways.



# COMPACTION CONTROL SYSTEMS

## FOR ASPHALT AND SOIL



### TRIMBLE CCS900 ASPHALT COMPACTION CONTROL SYSTEM

The asphalt compactor is the last machine to pass over your paving project, and mistakes during this phase can be very costly to fix. The Trimble® CCS900 will calculate the exact position of the machine and display a color map indicating the current number of passes and possible overlaps. With two (2) Infrared sensors you can also measure the surface temperature insuring the asphalt is at the correct temperature for compaction.



### TRIMBLE CCS900 SOIL COMPACTION CONTROL SYSTEM

Successful soil compaction requires each layer to have proper thickness, density and moisture. If one layer is not strong enough either through under or over compaction the road could possibly fail. With the Trimble® CCS900 Compaction Control System you can easily measure and record accurate pass counts and soil stiffness, insuring operators perform properly and giving clients confidence in your work.



### TRIMBLE IS310 INFRARED TEMPERATURE SENSORS

The Trimble® IS310 Infrared Temperature Sensors are installed on the front and rear drum to measure surface temperature of the mat in the direction of operation.



### TRIMBLE CM310 COMPACTION SENSOR

The compaction sensor measures compaction value, vibration frequency and vibration amplitude for vibration rollers.



# CONTROL BOXES

## FOR SPECIFIC APPLICATIONS

### TRIMBLE TD520 INTUITIVE SOFTWARE, RUGGED HARDWARE

The Trimble® Earthworks grade control app runs on the new 25.7 centimeter Trimble® TD520 touch-screen Android display.

- Colorful graphics, natural interactions and gestures, and self-discovery features make Earthworks intuitive and easy to learn
- Personalized interface with configurable views for each operator make it easier to see the right perspective for maximum productivity
- Uses Android operating system



### TRIMBLE CB460 CONTROL BOX

- Large screen size: 178mm, 800(w) x 480(h) pixel, 256k true color, TFT active matrix, 1000 (typ) cd/m2. LCD brightness is adjustable over a suitable range to accommodate different working conditions
- Windows CE 5.0 Operating System
- Both serial and Ethernet connections for increased sync speed
- 4GB Memory
- USB Host Port on Front Face protected with self closing Protective Cover
- 4 x Integrated Lightbars. Each Lightbar has 1 central Green LED with 3 Amber LED's each side of the central LED
- Ambient light sensor for Automatic brightness control
- 17 Logically placed backlit keys which provide crisp tactile feedback when activated
- 39-pin sealed military rated quick release tool-less connector
- Field upgradeable software via USB 2.0 port
- In-built buzzer (with adjustable levels) for Operator feedback and warning



The Trimble® CB450/CB460 Can Be Configured For Your Specific Application:

2D Indicate, 3D Indicate, 3D Automatics

### TRIMBLE CB450 CONTROL BOX

- 109mm, 480(w) x 272(h) pixel, 256k true colour, TFT active matrix, 450 (typ) cd/m2. LCD brightness is adjustable over a suitable range to accommodate different working conditions
- USB Host Port on Front Face protected with Silicon Cover
- 500Mb Memory
- 4 x Integrated Lightbars. Each Lightbar has 1 central Green LED with 3 Amber LED's each side of the central LED
- Ambient light sensor for Automatic brightness control
- 7 Logically placed backlit keys provide tactile feedback when activated, allowing operators to focus on the job and not the controls.
- 39-pin sealed military rated quick release tool-less connector
- Field upgradeable software via USB port
- In-built buzzer (4 Volume settings) for operator feedback and warning



#### DOZER CONTROL



Shown on Trimble® CB460

#### COMPACTOR CONTROL

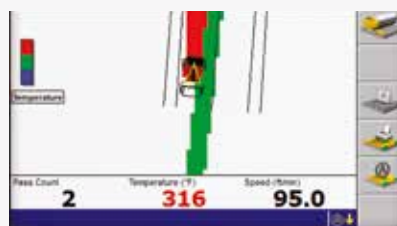

Shown on Trimble® CB450

#### GRADER CONTROL



Shown on Trimble® CB460

# SITE POSITIONING SYSTEMS FOR THE CONSTRUCTION SURVEYOR



## TRIMBLE SPS985 SMART ANTENNA

The ultra-rugged Trimble® SPS985 GNSS Smart Antenna is a valuable solution for contractors who need a precise GPS/GNSS Rover for their surveying and engineering departments. Ideal for use on small and large job sites, the Trimble® SPS985 can serve as a GNSS rover system or as a WI-FI capable base station for other GNSS operations including machine control.

- GPS and all other available constellations
- Fastest RTK engine
- Geodetic antenna with Multi-path rejection.
- Internal Radio
- Remote support and configuration
- Connects through Bluetooth
- High precision, 440 channels



CAR Mount

## TRIMBLE SPS985L SMART ANTENNA

- GPS + GLONASS + QZSS
- Rugged Design
- Cost-effective solution with limited options
- Internal Radio
- Bluetooth
- Remote Support Available
- High precision, 440 channels
- Geodetic antenna with Multi-path rejection

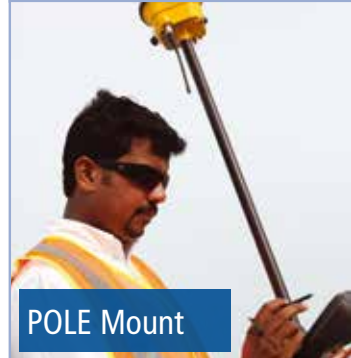

POLE Mount

## TRIMBLE SPS855 GNSS MODULAR RECEIVER BASE STATION

The Trimble® SPS855 GNSS Modular Receiver is simply the most advanced construction modular receiver on the market. Its position-only or position and heading capability set it apart from the competition. Its ease of configuration and as a base or rover, and its choice of antennas make it truly universal – capable of any operation.



tdl 450 radio

# TOTAL STATIONS

## FOR SURVEYING AND MACHINE CONTROL

### TRIMBLE TS662/TS635 TOTAL STATIONS

- Long-range reflectorless measurements up to 300m
- Single prism range: 3000m (TS662) , 5000m (TS635)
- Precision measuring accuracy: 2"/0.5 mgon (TS662), 5"/1.5 mgon (TS635)
- Rugged, IP66 rating to withstand construction conditions
- Absolute encoded, dual axis compensated
- Alpha-numeric keyboard with dedicated keys for menus and modes
- Illuminated graphic display for easy operation in the field
- Intuitive on-board software
- Dual lithium-ion batteries for a full day of continuous use up to 19 hours
- Can be used with the Trimble TSC3 data collector



### TRIMBLE SPS730/930 UNIVERSAL TOTAL STATIONS

- One man operation and machine control compatible
- Robotic range of 500 meters
- Up to 1300m reflectorless range
- Up to 5500m with 1 prism in long range mode
- Trimble® MultiTrack™ technology - Locks on and tracks passive prisms for monitoring or control measurements, and active prism targets for dynamic measurements required for grade control applications
- Trimble® SurePoint™ technology - Automatically corrects the horizontal and vertical angles and instrument pointing for mislevelment of the instrument
- Patented high speed Trimble® MagDrive™ technology - turns the instrument up to 115° per second
- 3Hz DR scanning - Super fast scanning capability for vertical / sloping profile measurements and stockpile scans
- The Trimble® SPS930 Universal Total Station is accurate to one arc second in the vertical and horizontal angle
- The Trimble® SPS730 Universal Total Station provides three arc second accuracy in the horizontal plane and two arc second accuracy in the vertical



### TRIMBLE SPS720 AND SPS620 ROBOTIC TOTAL STATIONS

- One man operation
- Robotic range of 500 meters
- Up to 800m reflectorless range
- Up to 5000m with 3 prisms
- Trimble® Active Target Tracking Technology
- Patented high speed Trimble® MagDrive™ technology turns the instrument up to 86° per second
- The Trimble® SPS620 provides 5 arc second accuracy for the vertical and horizontal angle measurements.
- The Trimble® SPS720 provides 3 arc second accuracy in the horizontal angle and 2 arc second accuracy in the vertical
- The Trimble® SPS620 and SPS720 Robotic Total Stations offer a high performance, but cost-effective solution for job sites that do not need a total station for machine control



# CONTROLLERS

## FOR SURVEYING AND MACHINE CONTROL



### TRIMBLE TSC3 CONTROLLER

The Trimble® TSC3 controller is a rugged and flexible handheld data collector that comes standard with Trimble® SCS900 Site Controller Software for site measurement, stakeout, and grade checking operations. Using this combination of rugged hardware and targeted software gives supervisors, foremen, grade checkers and site engineers total control of site operations.

The Trimble® TSC3 is water and dust resistant to withstand the toughest weather and jobsite conditions. Operates in temperatures ranging from -30 C to +60 C.

- TSC3 can be used as a controller for any Trimble GPS or Total Station product
- Built in GPS for stand alone operation
- Rugged, durable design
- Large 4.2" high resolution touch screen
- Built in 3G modem
- Bluetooth for cable free use
- Remote Assistant Available
- 802.11 WiFi
- Optional 2.4ghz radio for total stations
- 5mp camera
- Comes with SCS900 Software



### TRIMBLE SITE TABLET 10

An advanced data collector and jobsite computer, which provide real time data to construction professionals for visualizing cut/fill levels, calculating material volumes and communicating work orders. By incorporating a cellular modem, laptop, GPS and controller, Trimble has drastically advanced in-field computing and eliminating the gap between office design and field implementation.

- Microsoft® Windows® 10 Professional operating system
- 10.1 inch, sunlight readable Gorilla® glass touchscreen display
- 4G LTE WWAN data compatible with GSM networks
- 2-4 meter GPS integrated receiver and antenna
- Optional 2.4ghz radio for total stations
- 8 MP rear camera
- External battery for up to 10 hours



### TRIMBLE SITE MOBILE CONTROLLER

The Trimble® Site Mobile can be used as a controller for any Trimble® GPS product.

- Built in GPS for stand alone operation, 2-4 meter accuracy
- Large 4.3" high resolution touch screen
- Corning Gorilla Glass panel display for toughness
- Built in 3.75G GSM modem for data, voice and text
- Rugged, durable design
- Bluetooth for cable free use
- 802.11 WiFi
- 8mp camera



### ACCESSORIES



Pole Mount



Extended Batteries



Vehicle Charger



Vehicle Window Mount

# SOFTWARE SOLUTIONS FOR CONSTRUCTION MANAGEMENT



## TRIMBLE VISIONLINK

The VisionLink solution from Trimble and SITECH Gulf™ integrates site productivity, material quantities, and materials movement with asset and fleet management to give you a detailed view of your site so you can make the right decision at the right time.

- Know when and where your equipment is working
- Monitor asset utilization and minimize idle times to reduce equipment depreciation and eliminate unnecessary and costly fuel burn.
- Manage and make informed decisions about production efficiency.
- See continuously updated surface models based on machine activity.

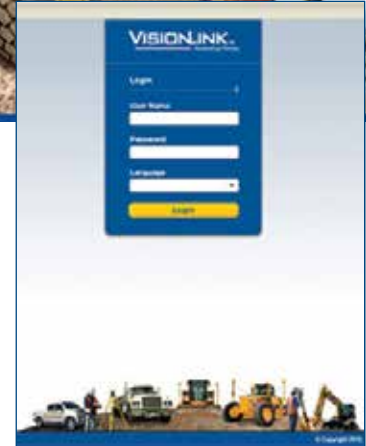

## ASSET MANAGEMENT

### Monitoring Your Entire Fleet

- Equipment location
- Machine hours
- Idle time
- Fuel usage (limited equipment only)
- Operator abuse (limited equipment only)



## 2D PROJECT MONITORING

### Automatic Monitoring of Earth Moving Cycle Times for Maximum Efficiency

- Load counts
- Cycle Times
- Load location
- Dump location
- Daily Quantities Moved
- Material flow from zone to zone

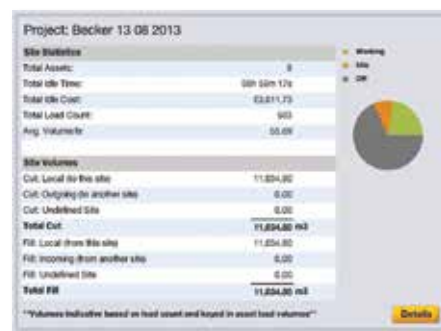

## 3D PROJECT MONITORING

### Automatic Monitoring of Grading and Finishing Operations

- 3D surface maps
- Cut and fill maps
- Pass count reports for compaction
- Temperature maps for asphalt compactors



# SOFTWARE SOLUTIONS BUSINESS CENTER



## BUSINESS CENTER - HCE

The easy-to-use, graphical Business Center – HCE is ideal for the preparation and management of data for heavy and highway construction projects.

- Field data management with Trimble grade control, paving control and site positioning field systems
- Data preparation for machine control and site positioning systems
- Quantities takeoff and cost estimating
- Construction planning using site and corridor mass haul
- 3D visualization using multiple surfaces, corridors, textures and images
- Adobe® PDF importing and onscreen digitization
- Integration with Connected Community facilitates file sharing and data visualization
- Easy volume calculations
- Network Adjustment
- Site Takeoff
- Road Takeoff

## TRIMBLE CONNECTED COMMUNITY

### 2-Way Data

USB sticks and cables are a thing of the past. With Wireless Data Sync you can just download and upload files by using the transfer button on your field device, or even set up an automatic sync so the field device files are uploaded to Connected Community automatically. Now the field and machine crews can send the office team work files effortlessly with no drive time. So everyone is on the same page, in real-time

## REMOTE ASSISTANT

When a member of your field crew calls the support line, technical support logs into Connected Community, and selects the operators Control Box or Controller to see what the operator sees. Now everyday issues such as design file versioning and machine configuration for grade control can be addressed without ever leaving the office or taking the machine out of production.

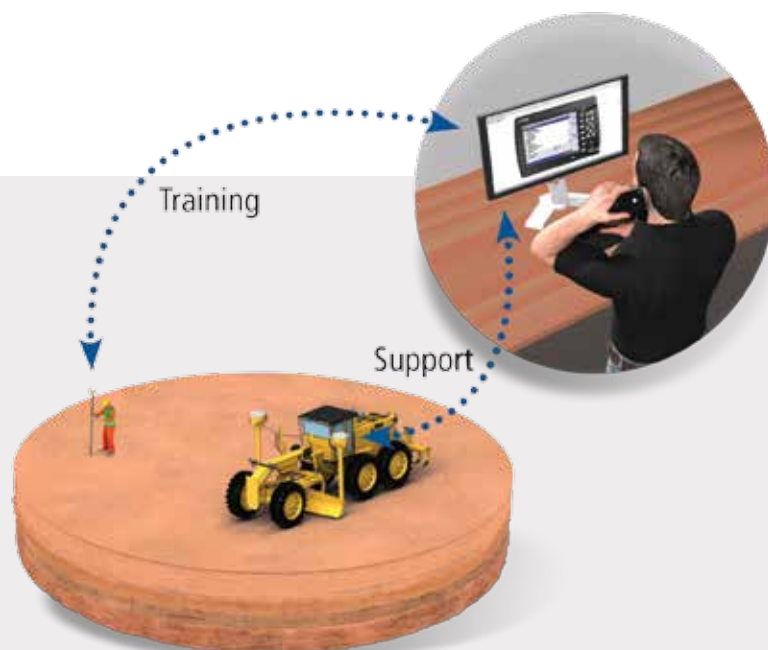



# OPERATIONS MANAGEMENT

## FIELD SERVICES

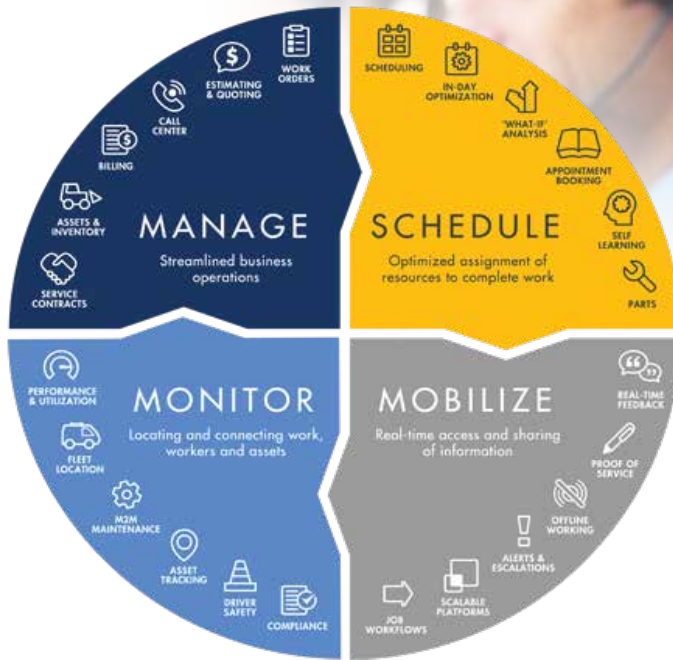

## TRIMBLE PULSE

Customer satisfaction studies show that customers are satisfied, when a service job is completed within their service agreement and fixing the issue on the first visit, is the biggest expectation. Connecting your field service organization will not only improve your service team efficiency, but also customer satisfaction.

Trimble® Pulse provides a suite of end-to-end service management solutions to help you achieve field service excellence. Customers can choose from the portfolio of capabilities to help **manage**, **schedule**, **mobilize** and **monitor** their workforce.

### MANAGE

Trimble® Pulse provides extensive support for the back office operations of a field service organization, allowing for streamlined business processes that are repeatable and predictable. The capabilities allow businesses to manage their customers, calls, service contracts, estimates and work orders along with assets, inventory and billing, all from one place.



### SCHEDULE

Trimble® Pulse allows dispatchers to automatically build and dispatch the most efficient schedule and stay on top of work as changes happen throughout the day. Its extensive range of scheduling, dispatch and optimization tools transform the utilization of a mobile workforce, allowing them to complete more jobs per day and in the most efficient way. Field service businesses can choose the level of automation they require to manage potential schedule changes.



### MOBILIZE

Trimble® Pulse drives improved visibility and information sharing in the field, via out-of-the-box, configurable and customizable mobile applications. The mobile application helps speed up time to invoice, tracks work progress throughout the day and enhances workflow compliance and standardization throughout the organization.



### MONITOR

Customers are able to manage their fleet of vehicles and assets, perform usage and utilisation analysis as well as monitor performance, safety and compliance. Connecting and having access to all these elements on one platform allows productivity and efficiency to be maximized through the organization.



# LOAD WEIGHING SYSTEMS

FOR WHEEL LOADERS, EXCAVATORS, AND HAUL TRUCKS



Optimize Loadout,  
Track Productivity and  
Prevent Overloading

## TRIMBLE L3180 LOADRITE LOADER WEIGHING SYSTEM

The new Trimble® L3180 LOADRITE™ SmartScale offers greater loading accuracy with precise weighing artificial intelligence that adjusts for rough terrain, technique, and movement so new and skilled operator can load accurately with confidence and speed.

- Large 14.5cm display screen
- Weighing artificial intelligence
- Connected Quarry connectivity including built-in WiFi and GPS
- Multi-axis Inertial Measurement Unit (IMU)
- Smart Data Sync



## LOADRITE LP930/LP950 PRINTER

Time stamped and dated hard copies of payload information printed either in the cab or in the offices. Wireless reporting options are also available.



## EXCAVATORS

Designed and engineered specifically for bucket excavators, Trimble® LOADRITE™ X-series excavator scales use proprietary Multi-Dimensional Compensation weighing technology to achieve accurate weighing performance.



## HAUL TRUCKS

The Trimble® H2250 provides near real-time reporting of haul truck production and process monitoring including automatic haul truck load counting, payload measurement to within +/- 3% accuracy, cycle time analysis and truck speed monitoring.

# LOAD WEIGHING SYSTEMS FOR CONVEYOR BELTS & MOBILE CRUSHERS

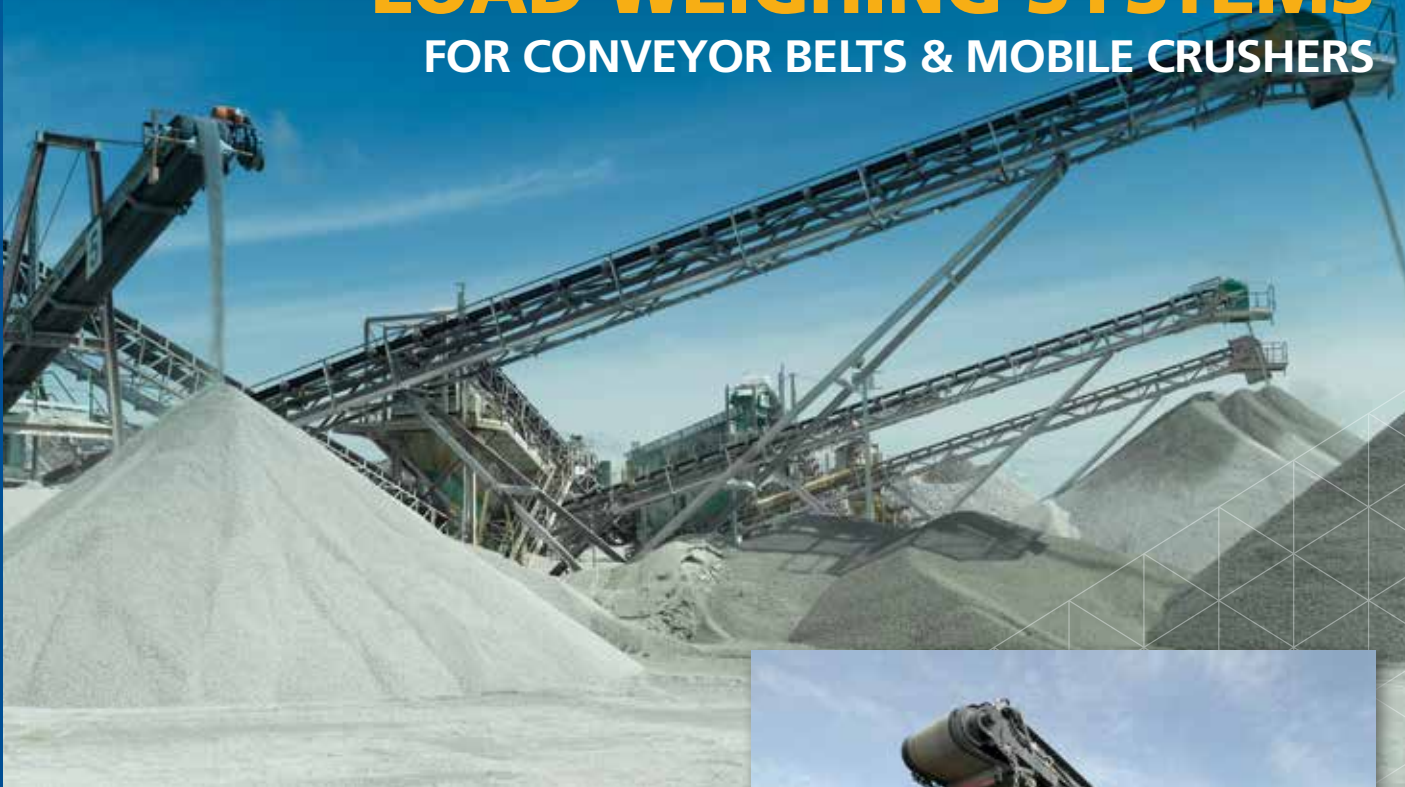

## TRIMBLE C2880 LOADRITE CONVEYOR SYSTEM

### FOR FIXED CONVEYOR SYSTEM

The Trimble® LOADRITE™ C2880 is an advanced conveyor belt weighing system for the demanding requirements of a modern quarry. It couples high accurate weighing with state-of-the-art data communication capabilities and superior information management solutions.

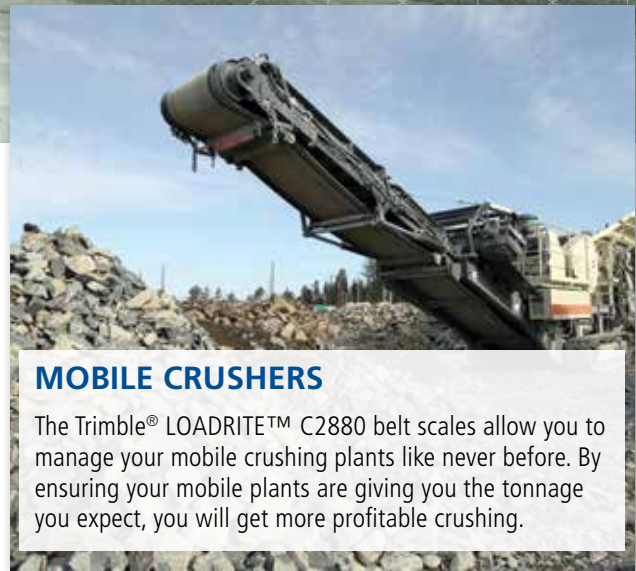

### MOBILE CRUSHERS

The Trimble® LOADRITE™ C2880 belt scales allow you to manage your mobile crushing plants like never before. By ensuring your mobile plants are giving you the tonnage you expect, you will get more profitable crushing.



## TRIMBLE INSIGHTHQ

Trimble® InsightHQ™ is a quarry management portal for your web browser or mobile device. It shows near real time productivity, availability and performance dashboards and reports for extraction, processing and load-out.

### Key Features

- Track tonnes per hour from your mobile equipment and fixed plant
- Precisely track inventory
- Identify bottle necks and pinch points in your process
- Monitor machine stress to schedule preventative maintenance
- Maximize utilization by identifying equipment with unused capacity
- Track loadout operations

### Trimble LOADRITE Communication Options

Trimble® LOADRITE™ offers several data communications solutions to send data from your LOADRITE™ weighing system to an office PC in a secure, paperless manner.

LOADRITE™ enables you to transfer data via the following technologies:

- LOADRITE™ Data Module
- 900 Mhz Radio Link
- 2,4 GHz Radio Link
- GSM / GPRS Cellular Modem
- WIFI 802.11 a/b/g network
- Ethernet network
- Serial Connection

# LIFTING SOLUTIONS

## FOR WIND SPEED MONITORING

Increase efficiency and improve safety in crane and lifting applications

### TRIMBLE GS026 WIRELESS WIND SPEED SENSOR

The Trimble® GS026 Wind Speed Sensor offers a user-focused and cost-effective design to a wide variety of applications. Whether the application is residential, commercial, marine or heavy industrial, the Trimble® GS026 offers the best value for the money based on features, functionality and radio performance.

- Low-cost wind speed monitoring solution for a diverse range of applications and industries
- Communication range of 1,300 meters
- Compatible with the Trimble® GS820, GS550, GS320, the GS553 battery powered displays, MBR Series displays and with the gateway router
- Measurement range of 0 to 241.4 km/h

### TRIMBLE GS020 WIND SPEED SENSOR (ANEMOMETER)

The Trimble® GS020 anemometer is a flexible and rugged wind speed sensor designed for a diverse range of applications.

- Display shows current wind speed value and wind speed limit setting
- User settable wind speed limit, with standard wind gust alarm
- CCompatible with the Trimble® GS820, GS550, GS320, the GS553 battery powered displays, MBR Series displays and with the gateway router
- Transmission range: 1,300 meters

### TRIMBLE GS320 DISPLAY/RECEIVER

The Trimble® GS320 Wireless Wind Speed Display offers maximum benefit for crane applications where wind speed monitoring is critical.

- Displays the current wind value on a large, brightly lit LED display
- Users can set a wind speed alarm level
- Direct Sequence-Spread Spectrum-Two Way Communication
- Line of sight communication range: 1,300 meters



# LIFTING SOLUTIONS

## FOR WIND SPEED AND LOAD MONITORING

### TRIMBLE GS SERIES LOAD CELLS

The Trimble® Lifting Solutions Load Cells are available in standard sizes ranging from 2.5 tons (US) to 50 tons (US). All Trimble® GS Series Load Cells ship pre-calibrated, eliminating the need for test calibration weights. Our load Cells are made standard from 17-4 stainless steel.

- Direct Sequence-Spread Spectrum-Two Way Communication
- Transmission Range: 1,300 meters
- Each load cell is temperature compensated for increased accuracy
- For crane applications- mounted above a ball, odd parted on the block or even parted at the boom tip

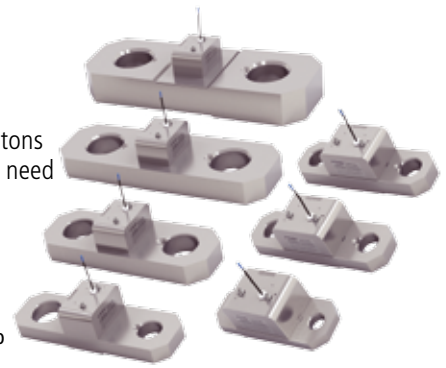

### TRIMBLE GS820 DISPLAY/RECEIVER

View up to 20 fields of data at a glance from the 15cm sunlight-readable gray scale LCD display. The Trimble® GS820 offers a choice between graphical and text display of the data on the screen.



### TRIMBLE GS550 WIRELESS DISPLAY/RECEIVER

The Trimble® GS550 offers a fully flexible design, able to simultaneously view multiple sensors. An economical choice that comes in portable or cab mounted versions on a large, sunlight-readable LCD display.

### TRIMBLE MBR100 MULTI-SENSOR DISPLAY

Lightweight, low-cost and portable, this pocket size display allows free mobility on the jobsite. (Cab-mounted version also available).



- Lockout function available with MBR105 cab-mounted version
- Open/close for safe storage and screen protection
- Monitor the load value for underhook load systems
- Monitor a sensor using Listening Mode without modifying the current RF network
- Backlight for night visibility

### TRIMBLE GS112 CABLE REEL *For cranes with a maximum boom extension of 42.67m*

With a simple and fast installation, the Trimble® GS112 Cable Reel eliminates cabling between the reel and display. A wireless transmitter sends angle and length data wirelessly to the display, reducing cable breakage and supports costs.



### TRIMBLE WIRELESS TENSIONMETER *Wireless Rope speed/ Payout/ Direction Option*

Our Trimble® Stainless Steel Wireless Tensionmeters are ideal for cranes and lifting equipment in applications where a dead end to place a load cell isn't available. The Stainless Steel design allows for maximum durability in marine/offshore applications.

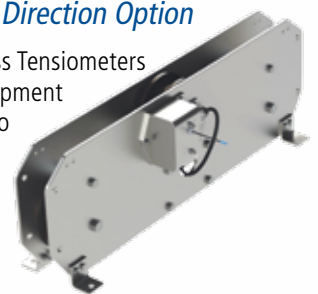

# SITECH GULF

## SERVICE CENTER



## SERVICE CENTER

SITECH Gulf™ is the Trimble® Authorized Service Provider for the five (5) countries we serve in the Gulf. Reliable instruments and systems and quality technical support are essential ingredients to get maximum productivity out of your instruments and systems.

We offer a wide range of technical services, all conducted by highly qualified technicians utilizing professional tools and highly

precise equipment. Unforeseen Repair and Service costs and downtime can be significantly reduced through periodic calibration and preventative maintenance, and you benefit from equipment that is always in top condition. The broad service offering includes certification services, repairs and product upgrades.

### GPS/GNSS Receivers, Collectors, and Controllers



Authorized Trimble® Service Center for all GPS/GNSS, data collectors

### Total Stations and Theodolites



Calibration & certification of any brand total station/theodolites and repair of Trimble®/Nikon® Total Station

### Laser & Receiver Calibration and Service



Calibration and Certification of all types of laser

### Auto Levels Calibration and Service



Calibration and certification of all types of optical instruments

### Base Station Radio Repair



Repair and configuration of any brand of radio

### Cables and Connectors



Repair and manufacturing of customized cables for all needs



**SITECH Gulf™** has the complete Trimble® Civil Engineering and Construction portfolio of products including 2D and 3D Machine Control, Marine Systems, Site Positioning Systems, Asset Management Systems, Loadrite Weighing Systems, Lifting Solutions, and Software Solutions.



**AllTerra Gulf™** distributes the Trimble® Geospatial portfolio. Our product's include Land Surveying Optical and Geospatial Instruments: GPS/GNSS, 3D Scanners & Mobile Mapping Systems, Indoor Mobile Mapping with Geoslam™, Total Stations and Optical Instruments, including Trimble®, Spectra Precision® and Nikon® brands. Allterra Gulf also distributes Geoslam™ mapping portfolio.



**Gulf Positioning Services™** provides 3D Scanning and Mobile Mapping Services using the latest in Trimble® technology and software including the MX2 and TX8 LIDAR scanners with imaging hubs and the UX5 drone.



**QUALITY YOU CAN TRUST - SERVICE YOU CAN RELY ON**



## SITECH GULF - UAE

Dubai Industrial City  
PO Box 1170  
+971 4 887 6836 Office Nr.

### SITECH GULF-QATAR

Industrial Area, Doha  
PO Box 2171  
+974 4 0159 555 Office Nr.

### SITECH GULF-KUWAIT

Shuwalk Port Area  
PO Box 148  
+965 248 10855 Office Nr.

### SITECH GULF-OMAN

Al Ma' Street, Muscat  
PO Box 114  
+968 2450 9000 Office Nr.

### SITECH GULF-BAHRAIN

Al-Nuwaidrat, Manama  
PO Box 5357  
+973 1 7705 177 Office Nr.



**SITECH GULF**

INFO@SITECHGULF.COM  
SITECHGULF.COM

