



million
in one

sitrans
LU10

SIEMENS

Safety Guidelines: Warning notices must be observed to ensure personal safety as well as that of others, and to protect the product and the connected equipment. These warning notices are accompanied by a clarification of the level of caution to be observed.

Qualified Personnel: This device/system may only be set up and operated in conjunction with this manual. Qualified personnel are only authorized to install and operate this equipment in accordance with established safety practices and standards.

Unit Repair and Excluded Liability:

- The user is responsible for all changes and repairs made to the device by the user or the user's agent.
- All new components are to be provided by Siemens Milltronics Process Instruments Inc.
- Restrict repair to faulty components only.
- Do not reuse faulty components.

Warning: This product can only function properly and safely if it is correctly transported, stored, installed, set up, operated, and maintained.

This product is intended for use in industrial areas. Operation of this equipment in a residential area may cause interference to several frequency based communications.

Note: Always use product in accordance with specifications.

Copyright Siemens Milltronics Process Instruments Inc. 2008. All Rights Reserved	Disclaimer of Liability
This document is available in bound version and in electronic version. We encourage users to purchase authorized bound manuals, or to view electronic versions as designed and authored by Siemens Milltronics Process Instruments Inc. Siemens Milltronics Process Instruments Inc. will not be responsible for the contents of partial or whole reproductions of either bound or electronic versions.	While we have verified the contents of this manual for agreement with the instrumentation described, variations remain possible. Thus we cannot guarantee full agreement. The contents of this manual are regularly reviewed and corrections are included in subsequent editions. We welcome all suggestions for improvement. Technical data subject to change.

MILLTRONICS® is a registered trademark of Siemens Milltronics Process Instruments Inc.

Contact SMPI Technical Publications at the following address:

Technical Publications
Siemens Milltronics Process Instruments Inc.
1954 Technology Drive, P.O. Box 4225
Peterborough, Ontario, Canada, K9J 7B1
Email: techpubs.smpi@siemens.com

European Authorized Representative

Siemens AG
Industry Sector
76181 Karlsruhe
Deutschland

- For a selection of Siemens Milltronics level measurement manuals, go to: www.siemens.com/processautomation. Under Process Instrumentation, select *Level Measurement* and then go to the manual archive listed under the product family.
- For a selection of Siemens Milltronics weighing manuals, go to: www.siemens.com/processautomation. Under Weighing Technology, select *Continuous Weighing Systems* and then go to the manual archive listed under the product family.

Table of Contents

Introduction	1
About This Manual	1
About the SITRANS LU10	2
Important SITRANS LU10 Features	4
Installation	7
SITRANS LU10	7
Optional Cards	9
Interconnection	10
Programming	15
Display	15
Keypad	16
Program Mode Entry	17
Parameter Value Alteration	17
Programming Security	18
Quick Start Parameters	19
Operation	23
Display	23
Keypad	24
System Performance Evaluation	25
Performance Test Results	26
Application Parameters	27
Volume Parameters (P050 to P055)	27
Reading Parameters (P060 to P062)	29
Failsafe Parameters (P070 to P072)	30
Relay Parameters (P100 to P104, P110 to P113, P129)	33
mA Output Parameters (P200 to P203, P210 to P215, P219)	39
Enhancement Parameters	43
Data Logging Parameters (P300 and P302)	43
Profile Records (P330 to P337)	44
Installation Records (P340 to P342)	47
Range Calibration Parameters (P650 to P654)	48
Temperature Compensation Parameters (P660 to P664)	51
Rate Parameters (P700 to P707)	53
Measurement Verification Parameters (P710 to P713)	55
Scanning Parameters (P720, P725 to P729)	57
Display Parameters (P730 to P734, P740)	59
SmartLinx Parameters	61
Echo Processing Parameters (P800 to P807)	62
Advanced Echo Processing (P810, P816-P825, P830-P835, P840-P845, P850-P852)	65
Test Parameters (P900 to P913)	72

Measurement Parameters (P920 to P923)	74
Master Reset (P999)	77
Technical Reference	79
Transmit Pulse	79
Echo Processing	79
Distance Calculation	80
Sound Velocity	80
Scanning	81
Volume Calculation	81
Measurement Response	82
Application Examples	83
BIC-II Support	93
Maintenance	96
Troubleshooting Guide	97
Measurement Difficulties	98
Specifications	103
Programming Chart	105
Programming Chart	106
Programming Chart	107
Programming Chart	108

Introduction

About This Manual

This instruction manual provides information specific to the SITRANS LU10 (Ten Point Level) monitor.

When references are made to other Siemens Milltronics products associated with a SITRANS LU10 based level measurement system, refer to the associated product instruction manuals, if necessary.

After reading this introduction and completing the physical installation, first time system installers may wish to use the SITRANS LU10 Quick Start Guide for step-by-step start up instructions.

Introduction	introduces installers and operators to the SITRANS LU10, with brief descriptions of key features.
Installation	provides a step-by-step procedure to install and interconnect a SITRANS LU10 based level measurement system.
Programming	defines PROGRAM mode display and keypad functions, and general programming information.
Quick Start Parameters	details the minimum recommended programming required to prepare the SITRANS LU10 for RUN mode operation.
Operations	defines RUN mode display and keypad functions, including the RUN mode entry procedure and performance evaluation recommendations.
Application Parameters	details the programmable features that may be used to alter SITRANS LU10 display, failsafe, LU SAM relay, and LU AO mA output operation.
Enhancement Parameters	defines the programmable features used to enhance RUN mode operation. (Typically used as directed by the Troubleshooting Guide).
Technical Reference	provides detailed information for complex features and details 4 specific application examples.
Troubleshooting Guide	provides a quick reference to installation modification and programming remedies to overcome challenging operating conditions.
Specifications	lists the environmental, physical, and operational characteristics associated with the SITRANS LU10.
Programming Charts	provides a convenient space to record all programming for future reference. (May also be used as a complete parameter index.)

Note: Programming is not complete until the Programming Charts are completed.

About the SITRANS LU10

Notes:

- The SITRANS LU10 is to be used only in the manner outlined in this instruction manual.
- This product is intended for use in industrial areas. Operation of this equipment in a residential area may cause interference to several frequency based communications.

The SITRANS LU10 is a microprocessor based level monitor designed specifically for bulk solids and liquid level measurement applications. A SITRANS LU10 level monitor, utilizing a single Siemens Milltronics ultrasonic transducer, accurately monitors vessel material level without material contact. By using an additional transducer for each vessel, the SITRANS LU10 can monitor the material level in up to 10 vessels.

The SITRANS LU10 transmits electronic pulses to each scanned ultrasonic transducer. The transducer converts the electronic pulses to ultrasonic pulses which are emitted from the transducer face in a narrow beam. The SITRANS LU10 measures the time from the pulse emission, to receiving the reflection (echo) from the material. Using the time measured, the SITRANS LU10 calculates the distance from the transducer face to the material.

The distance calculation is dependent upon the sound velocity within the vessel. When Siemens Milltronics ultrasonic/temperature transducers are used, variable air temperatures are independently compensated for each vessel. For superior air temperature compensation, a TIB-9 card may be used with individual Siemens Milltronics TS-3 temperature sensors for each vessel. A simple calibration feature compensates for homogeneous (consistent composition) atmospheres other than air.

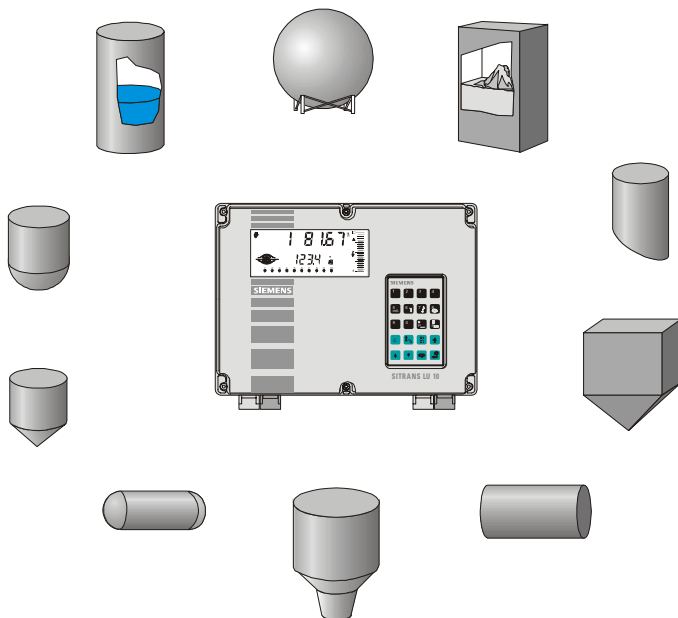

The SITRANS LU10 is capable of monitoring wheat in 60 m (200 ft) high silos, acetone in 45 gallon barrels, or almost anything in between, in any combination. (Ensure the transducer selected for each vessel suits the material and measurement range required).

This material and measurement range versatility is accomplished by utilizing Siemens Milltronics patented Sonic Intelligence®. Sonic Intelligence provides high measurement reliability, regardless of changing conditions within the vessel monitored.

By utilizing ultrasonic echo ranging principles with Sonic Intelligence and velocity compensation, the SITRANS LU10 provides outstanding measurement accuracy, usually within 0.25% of range.

The distance calculation may be converted to space, material level, material volume, or remaining vessel capacity Readings. The Reading chosen (and operating data) for each vessel is displayed on the Liquid Crystal Display (LCD).

Up to three Siemens Milltronics Peripherals may be connected to the SITRANS LU10. The LU AO, LU SAM and/or BIC-II, respectively provide analog output, relays, and RS-232 or RS-422 communication interface, as programmed by the SITRANS LU10.

With the addition of a Siemens Milltronics SmartLinx protocol specific 'plug in' communications module, the SITRANS LU10 is compatible with popular industrial control system standards.

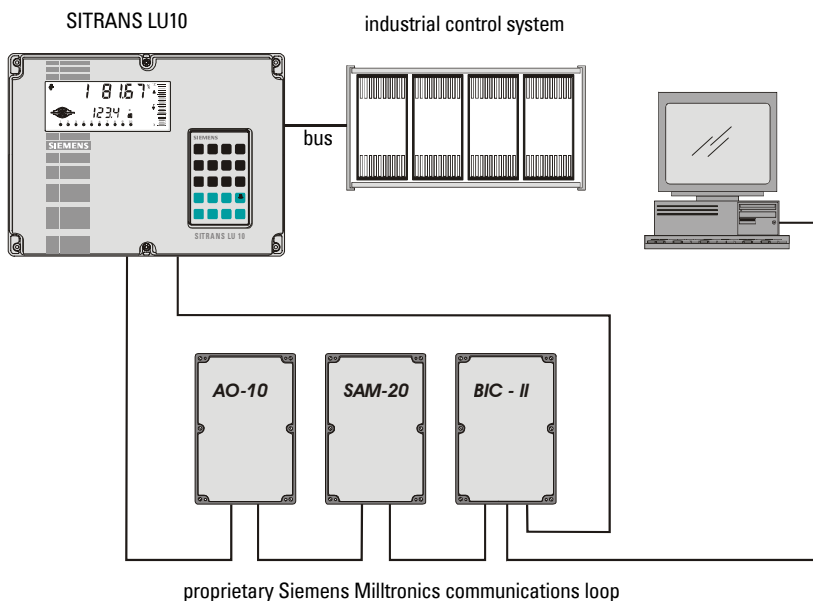

Operator programming, via a Siemens Milltronics infrared programmer, is stored in non-volatile memory, unaffected by power interruption. The infrared interface permits one programmer to be used for any number of SITRANS LU10 level monitors. Upon programming completion, the removable programmer may be locked away, thereby securing all programming.

While the SITRANS LU10 is typically used to monitor material level in open or closed vessels, any process which requires a distance measurement (within the system range) is a candidate for SITRANS LU10 application.

Refer to *Technical Reference* Application Examples for detailed descriptions of a small sample of process measurement requirements to which the SITRANS LU10 may be applied.

Throughout this manual (unless stated otherwise) references to material level also apply to any material or object surface to be monitored by the SITRANS LU10.

Important SITRANS LU10 Features

Fixed Features

Enclosure	Chemical resistant, light weight, dust tight, liquid tight, easy to work with.
LCD	Large digits for Reading and programming value displays. Graphic Symbols for continuous indication of operating conditions.
Programmer	20 tactile feedback keys or Dolphin (SITRANS LU10/RS-232C interface) each with magnetic mounting and infrared interface (ordered separately).
Scanning	Substantially reduces equipment costs for additional vessels (present or future).

Communications

Siemens Milltronics Peripherals

Proprietary bipolar communications with LU A0, LU SAM and BIC-2 peripheral devices, for respective analog mA output, alarm control relays and RS-232 or RS-422 interface.

and /or

SmartLinx Compatible

Communications ready when equipped with an appropriate Siemens Milltronics SmartLinx module.

Speed	Fast 16/32 bit microprocessor at 16.7 MHz clock speed. 1 vessel (point) per second scanning speed capability.
--------------	--

Reliability	Surface Mount Technology (SMT) also provides for full features in a compact design. Sonic Intelligence [®] ensures all measurements are accurate and reliable. Immune to power interruptions, all programming is stored indefinitely. Dynamic operating data is retained for one hour and updated immediately on power resumption.
--------------------	---

Programmable Features

Typically, a very small percentage of the programmable features require operator alteration. However, for demanding measurement requirements any operator programmable feature may be adjusted as desired.

Following is a list of some of the features that make the SITRANS LU10 easy to program, yet versatile enough to handle complex level measurement requirements.

GENERAL FEATURES

Direct Access	Any operator programmable feature may be accessed directly.
Scroll Access	Single button "scroll forward", single button "scroll back", to key features.
Operation	Select "level", "space", or "distance" operation.
Material	Liquid or Solid; automatically adjusts echo processing with one entry.
Response	Slow, medium, fast, surge, or turbo response to material level changes, one entry.
Units	Display Readings in m, cm, mm, ft, in, %, or any other units desired.

ADDITIONAL FEATURES (use as desired)

Volume	Eight pre-programmed tank shape options. Two universal tank shape programming methods.
Failsafe	Numerous failsafe options for process control equipment activation.
Relays (LU SAM required)	7 alarm functions including level, rate of change, temperature and more. Fixed or independent on/off setpoints.
mA Outputs (LU AO required)	Based on level, space, distance, or volume. 4 range selections, 0-20, 4-20, 20-0, or 20-4 mA. Adjustable range and over-range limits.

Installation

Installation shall only be performed by qualified personnel, and in accordance with local governing regulations.

The following procedure applies to all SITRANS LU10 level monitor installations. See *Technical Reference* Application Examples for additional installation requirements. Also, refer to the instruction manuals of all other equipment connected to the SITRANS LU10 for additional installation instructions.

SITRANS LU10

Installation should only be performed by qualified personnel, and in accordance with all governing regulations.

Location

Inspect all potential mounting locations. Choose a location suited to the SITRANS LU10 polycarbonate enclosure and the following location recommendations.

The ideal SITRANS LU10 mounting location is where the

1. Ambient temperature is always within -20 to 50 °C (-5 to 122 °F).
2. SITRANS LU10 front cover has sufficient room to swing open.
3. Operator and electronics are not exposed to the weather.
4. Cable length requirements are minimal.
5. Mounting surface is free from vibration.

Avoid mounting locations where the SITRANS LU10 is

1. Exposed to direct sunlight. (Otherwise, provide a sun shield.)
2. Close to high voltage or current runs, contactors, or SCR control drives.

Cable / Conduit Entry Requirements

Determine the number of enclosure cable / conduit entries required for

- Transducers
- TS-3 temperature sensors (if used)
- BIC-II (if used)
- LU SAM (if used)
- LU AO (if used)
- Synchronization (see Interconnection-Level System Synchronization)
- Power

Note: Transducer cables must be run in a grounded metal conduit, separate from other wiring, (except TS-3 temperature sensor wiring, if applicable).

Mounting

This product is susceptible to electrostatic shock. Follow proper grounding procedures.

Inspect all cartons and packaging for possible damage during shipment, before removing the SITRANS LU10 and associated equipment.

1. Loosen the six enclosure lid (captivated) screws and swing the lid open.
2. Remove the four board B mounting screws (outer corners) and remove the circuit board assembly.
3. Drill sufficient holes in the enclosure bottom to meet enclosure cable / conduit entry requirements.
4. Attach the enclosure to the selected mounting surface. (four predrilled screw holes provided.)
5. Attach the conduit / cable hubs to the enclosure. (Do not apply undue force.)
6. Reinstall the circuit board assembly.

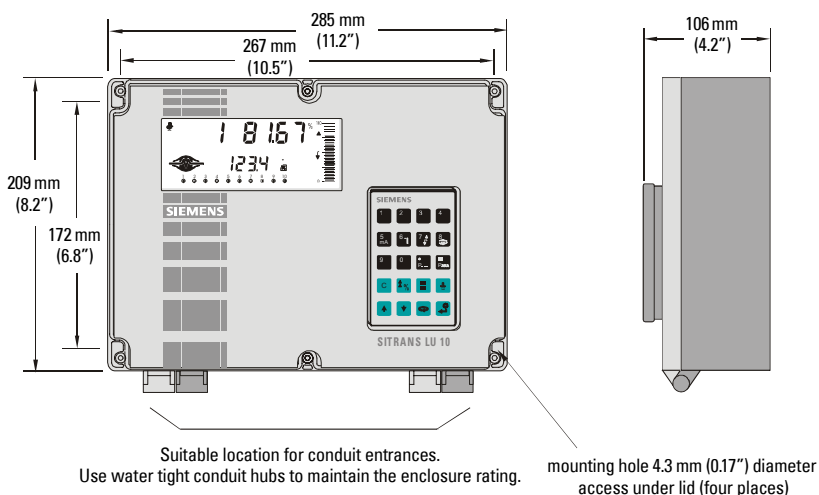

Note: Non-metallic enclosure does not provide grounding between conduit connections. Use grounding type bushings and jumpers.

Transducer Mounting

Objects near the transducer face cannot be reliably detected. Mount the transducer above the highest material level (away from the nearest monitored object) by the following Nearest Distance.

Nearest Distance

0.5 m (1.65 ft)¹

0.66 m (2.17 ft)¹

0.99 m (3.25 ft)

1.32 m (4.33 ft)

Transducer Types

ST-H, ST-25, XCT-8, XPS-10, XCT-12, XPS-15, ST-50

XPS-30, XPS-40

ST-100, LR-21, XLT-30, XLS-30

LR-13, XLT-60, XLS-60

¹ This is the recommended minimum distance. However, it can be reduced under certain circumstances. Please check the appropriate transducer manual for details.

Optional Cards

Communications Module

The SITRANS LU10 is software / hardware ready to accept an optional Siemens Milltronics SmartLinX communications module that provides an interface to one of several popular industrial communications systems.

Your SITRANS LU10 may be shipped to you without a SmartLinX module, for installation at later date.

If you are ready to install your SmartLinX module, or want to change it, please follow the procedure as outlined.

TIB-9 Card

The standard SITRANS LU10 supports one Siemens Milltronics TS-3 temperature sensor. When equipped with a TIB-9 card, the SITRANS LU10 supports up to ten TS-3s.

Your SITRANS LU10 may be shipped to you without a TIB-9 card, for installation at a later date.

If you are ready to install your TIB-9 card, please follow the procedure as outlined.

Installation Procedure

With power off and the SITRANS LU10 lid opened:

1. Remove the four LCD card screws and the card itself.
2. If there is no TIB-9 card being installed, proceed to step 6, otherwise proceed with step 3.
3. Remove the five board A screws, and lift off the board (though still attached by ribbon connectors).
4. Mount the TIB-9 card by mating the connectors and secure the card in place using the three screws provided.
5. Replace board A and secure in place using the screws removed in step 3.
6. If installing an optional SmartLinX module, mount the card by mating the connectors and secure the card in place using the two screws provided.

Refer to the SmartLinX module documentation for any required hardware settings prior to replacing the LCD card or closing the SITRANS LU10 lid.

7. Replace the LCD card and secure in place using the screws removed in step 1.

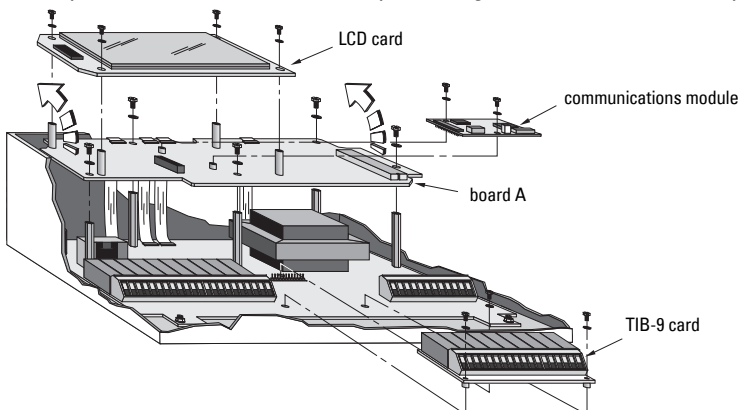

Interconnection

Before interconnecting system components to the SITRANS LU10 terminals, verify all components have been installed in accordance with the associated product instruction manuals.

Connect all associated equipment cable shields to the SITRANS LU10 shield connections. To avoid differential ground potentials, do not connect cable shields to ground (earth) elsewhere. Insulate (tape) cable shields at all shield junctions to prevent ground loops.

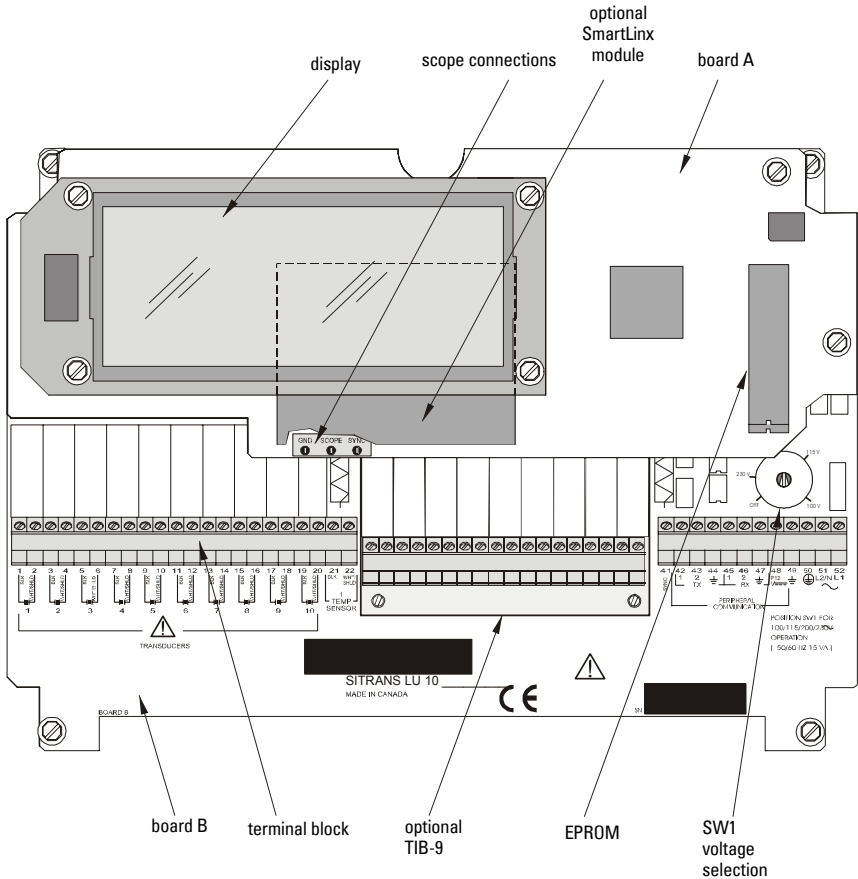

All field wiring must have insulation suitable for at least 250 V.



Hazardous voltage is present on transducer terminals during operation.

System Diagram

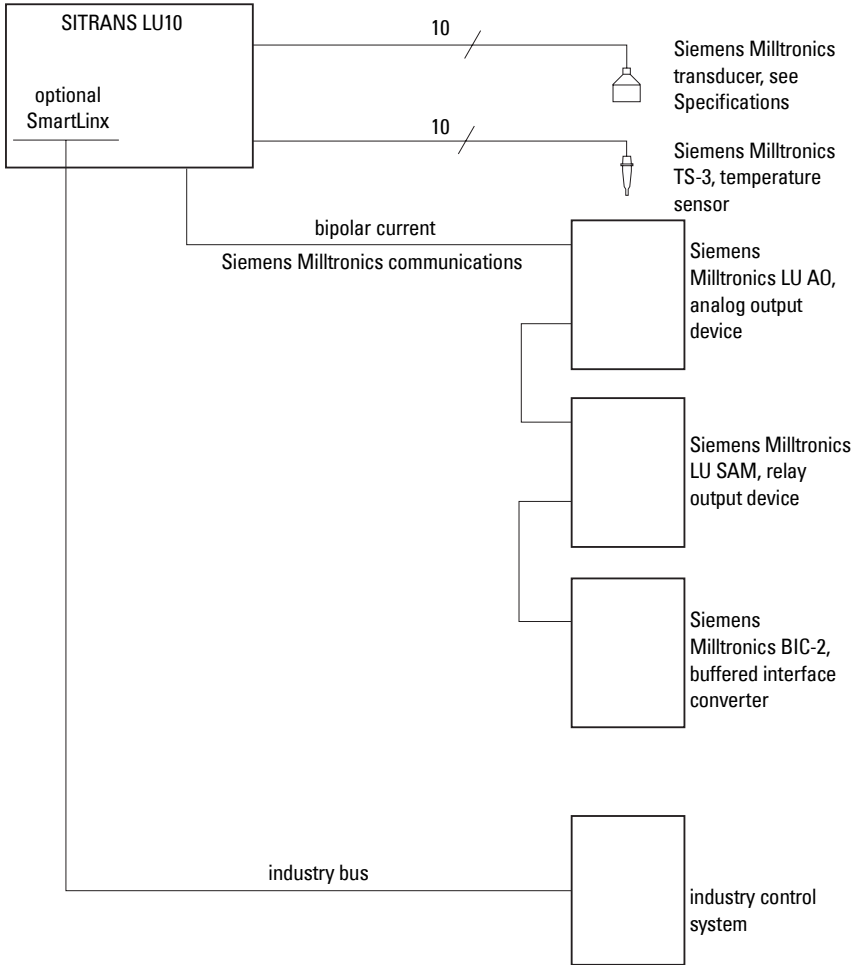

Installation

Maximum system capability. Not all components or their maximum quantity may be required.

Transducer

Transducers

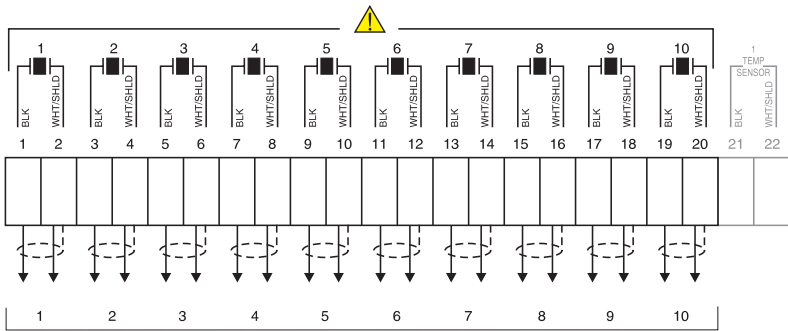

To Transducers (10 max), RG62 A / U Coax, 365 m (1200 ft) / Transducer max.

Transducer cables must be run in a grounded metal conduit separate from other wiring (except TS-3 temperature sensor wiring, if applicable).



Hazardous voltage is present on transducer terminals during operation.

Temperature Sensor

single Temp Sensor

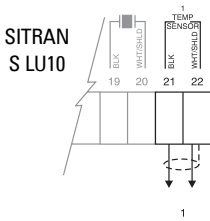

to Temp Sensor #1

TIB-9 card for multiple Temp Sensors (optional)

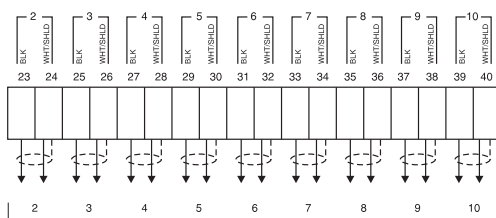

to additional Temp Sensors

Use Belden 8760 (or equivalent) 18 AWG, 2 wire shielded / twisted, 365 m (1200 ft) per TS-3 max.

Use TS-3 temperature sensors only. Don't jumper the terminals if TS-3's are not used.

Peripherals

The SITRANS LU10 is compatible with the following Siemens Milltronics peripherals (3 max.):

- LU SAM: 20 relay satellite alarm module (2 max.)
- LU AO: 10 output analog output module (1 only)
- BIC-II: buffered SITRANS LU10 to RS-232C / RS-422 interface (1 only)

Connect the peripherals used, in a serial loop as follows:

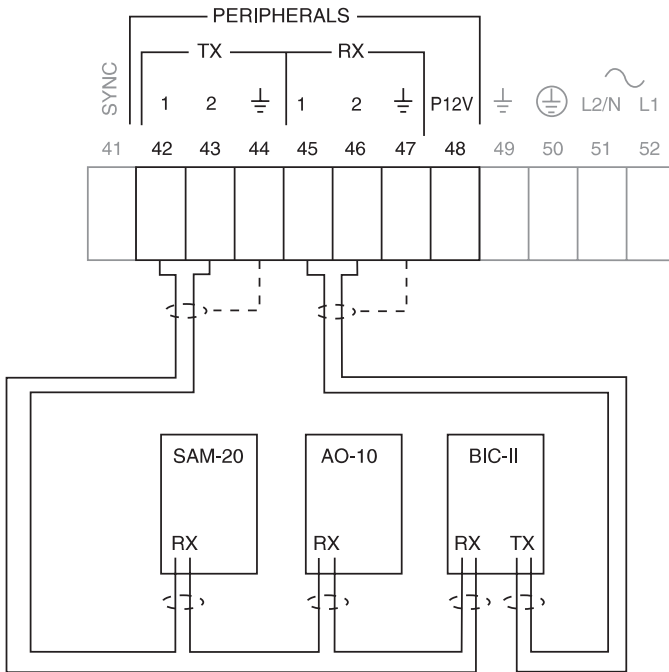

Use Belden 8760 (or equivalent) 18 AWG, 2 wire shielded / twisted, 3000 m (10,000 ft) total loop length.

Level System Synchronization

Avoid mounting the SITRANS LU10 near another ultrasonic level monitor. Likewise, when more than one monitor is installed within a single plant / facility, ensure the transducer cables of each system are run in separate grounded metal conduits. If this system separation is impractical, or despite separation efforts measurement difficulties are encountered, system synchronization may be required.

To synchronize the SITRANS LU10 with a SITRANS LU 02 or another SITRANS LU10 perform the following steps.

1. Mount the level monitors together in one cabinet.
2. Ensure the level monitors share a common power (mains) supply, and ground (earth).
3. Interconnect the SYNC terminals of the level monitors to be synchronized.

To synchronize the SITRANS LU10 with other Siemens Milltronics ultrasonic level monitors (not listed) contact Siemens Milltronics or your local distributor.

Power

Before making the power connection, ensure proper voltage selection.

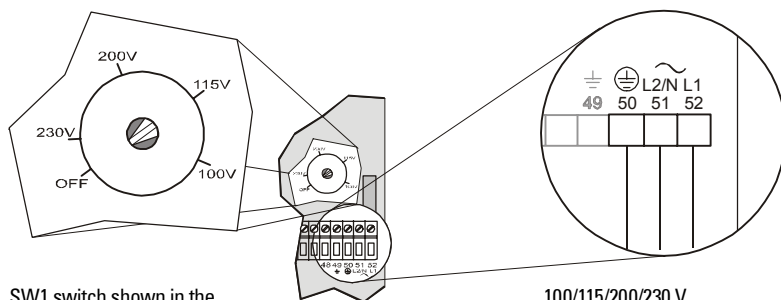

SW1 switch shown in the 'OFF' position. Select appropriate voltage.

100/115/200/230 V
50/60 Hz
select voltage via SW1.

Never operate the SITRANS LU10 with the enclosure lid open, or with the ground (earth) wire disconnected.

Ensure that any connected alarm or control equipment is disabled until satisfactory system operation and performance is verified.

The equipment must be protected by a 15 A fuse or circuit breaker in the building installation.

A circuit breaker or switch in the building installation, marked as the disconnect switch, shall be in close proximity to the equipment and within easy reach of the operator.

Programming

Operator programmable features are identified by a Point Number and Parameter Number. The Point Number refers to the Transducer (vessel) Number, Relay Number, mA Output Number, or TS-3 Number as identified by the Point Type indicators. Parameter Numbers have a preset Parameter Value for each Point Number.

Programming is accomplished by altering the preset Parameter Values as required to obtain the RUN mode operation desired. All operator programmable features are defined in the Quick Start Parameters, Application Parameters, and Enhancement Parameters sections of this instruction manual.

Display

In the PROGRAM mode, the Point Type, Point Number, Parameter Number, and Parameter Value (as well as a variety of other programming information) may be viewed.

Note that many indicators are specific to certain programming conditions and therefore, **all indicators are not displayed at any given time.**

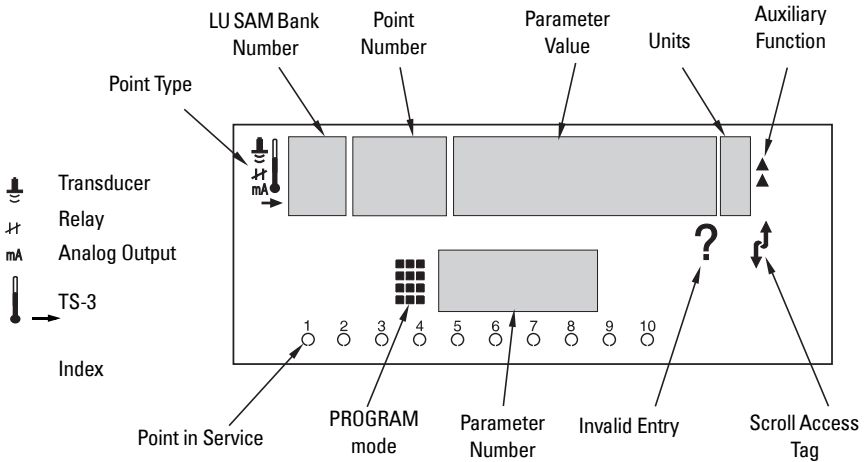







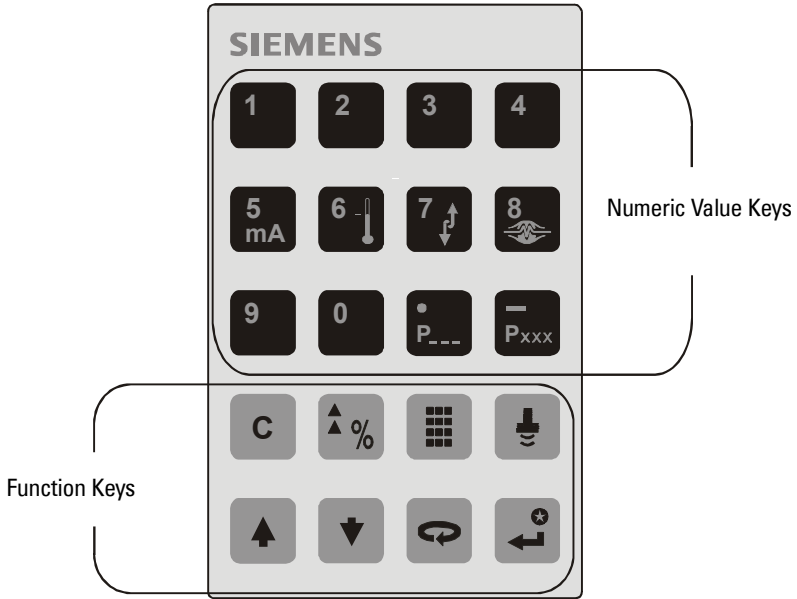





- Parameter Number the programmable feature the Parameter Value pertains to.
- Point Type the Point Number refers to a Transducer, Relay, mA Output, TS-3, or Breakpoint.
- LU SAM Bank Number identifies the LU SAM the Relay Number displayed pertains to.
- Point Number the Transducer, Relay, mA Output or TS-3 # the Parameter Value pertains to.
- Parameter Value the current value of the Parameter Number for the Point Number displayed.
- Units indicates the Parameter Value is displayed in: m, cm, mm, ft, in, or %.
- Invalid Entry indicates the value entered is questionable.
- Auxiliary Function indicates Auxiliary Function access (applies to only some Parameter Numbers).
- Scroll Access Tag indicates the Parameter Value may be scroll accessed.
- PROGRAM mode indicates the PROGRAM mode is accessed.
- Point in Service indicates the Point Numbers which will be scanned in the RUN mode.

Keypad



In the PROGRAM mode, use the SITRANS LU10 programmer keys to perform the identified functions.



-  shift access to the Point Number, Parameter Number, or Parameter Value display.
-  –  input a numeric value into the accessed display.
-  input a Parameter Value decimal point (moves Profile and TVT Pointers left).
-  input a negative Parameter Value (moves Profile and TVT Pointers right).
-  delete the current Parameter Value display (initiate a parameter reset).
-  store the current Parameter Value in memory (complete a parameter reset).
-  switch the Parameter Value to % or Units (access Auxiliary Parameter Function).
-  increase the accessed display value.
-  decrease the accessed display value.
-  take an ultrasonic measurement.
-  enter the RUN mode.

Program Mode Entry



Upon initial power application, the SITRANS LU10 displays "OFF". To enter the PROGRAM mode:

1. Ensure the enclosure lid is secured by the six captivated screws.
2. Place the infrared programmer in the enclosure lid recess (no wiring or fastening required).
3. Press   %.



When the PROGRAM mode is entered after RUN mode operation, all operating data is retained in memory. Relay status and mA output values are held at last known values (unless affected by a parameter alteration or  is pressed) until the RUN mode is re-entered. The RUN mode is automatically re-entered if the SITRANS LU10 is left unattended in the PROGRAM mode for an extended period.

Parameter Value Alteration

In the PROGRAM mode:

1. Press  as required to underline the Parameter Number display field and
 - a) key in the desired Parameter Number, (direct access) or
 - b) press  or  as required (scroll access).

(As preset, Quick Start Parameters and any previously altered parameter may be scroll accessed.)

2. Press  as required to underline the Point Number display field and
 - a) key in the desired Point Number, (direct access) or
 - b) press  or  as required, (scroll access).

To alter the Parameter Value for all Point Numbers at once, direct access Point Number 00.

3. With the desired Parameter Number and Point Number displayed, key in the desired Parameter Value and press 

If Parameter Value alteration is not permitted, access the Lock parameter (P000) and enter the security code (See Programming Security).

Parameter Reset Features

On initial power up, all parameters are at "original" values. In many cases, when a Parameter Value is altered, associated Parameter Values are automatically altered accordingly. When a Parameter Number is accessed, if the preset Parameter Value displayed is acceptable, no entry is required.

To return an operator adjusted Parameter Value to the preset value, with the appropriate Point Number and Parameter Number displayed:

Press  

To reset numerous parameters to preset values, refer to Master Reset (P999).

Perform a Master Reset (P999) if the SITRANS LU10 was "bench tested" using arbitrary Parameter Values before system installation, following an EPROM replacement, or whenever complete reprogramming is required.

Special Parameters

Some Parameter Values are for display purposes only and cannot be operator altered. These are referred to as view only parameters. In the parameters sections of this instruction manual, view only parameters are identified by a "(V)" beside the Parameter Number.

Some Parameter Values must be common for all Point Numbers. These are referred to as global parameters. When a global parameter is accessed, the Point Number display automatically switches to Point Number 00, and returns to the Point Number previously selected when a non-global parameter is accessed. In the parameters sections of this manual, global parameters are identified by a "(G)" beside the Parameter Number.

Programming Security

All operator programming is retained in non-volatile memory, immune to power interruptions. When programming is complete, the programmer may be removed and locked away to prevent inadvertent programming alteration. The Lock (P000) parameter may also be used.



Security Parameter

P000 (G) LOCK

Use this feature (if desired) to secure all programming from inadvertent alteration.

Direct access (cannot be scroll accessed) this parameter after all programming is complete and enter any value (other than 1954) to activate the programming Lock.

When Lock is activated, the SITRANS LU10 may be switched from the RUN mode to PROGRAM mode and the value of any parameter may be viewed but not altered. To unLock, direct access this parameter and enter the value "1954".

This parameter cannot be reset by pressing  

values: 1954 = off (Parameter Value alteration permitted)
 other = activated (programming secured)

Quick Start Parameters

Alter the Quick Start Parameters as required to suit installation requirements.

If the Quick Start Guide was used, proceed to Application Parameters.

Refer to *Technical Reference* Application Examples for assistance, if required.

P001 OPERATION

Enter the type of RUN mode operation desired.

Select: "level", to display how full the vessel is (from Empty P006) .
"space", to display how empty the vessel is (from Span P007).
"distance", to display material surface distance from the transducer face.

When "out-of-service" is selected, the transducer is removed from the RUN mode scan sequence and all Peripherals hold "last known" values/operating status for the Point Number displayed.

values: 0 = out-of-service
1 = level
2 = space
3 = distance (preset)

P002 MATERIAL

Enter the type of material to be monitored.

If the material presents a flat surface perpendicular to the transducer beam, select liquid.

values: 1 = liquid or flat surface (preset)
2 = solid

P003 MEASUREMENT RESPONSE

Enter how quickly the SITRANS LU10 is to respond to changing measurements.

Slower Measurement Response improves stability and reliability.

- values: 1 = slow (0.1 m/min)
- 2 = medium (1 m/min)
- 3 = fast (10 m/min)
- 4 = surge (1.7 m/sec)
- 5 = turbo (17 m/sec)



"Surge" and "turbo" are intended for equipment position monitoring. Use with caution for level measurement. See Technical Reference Measurement Response

P004 TRANSDUCER

Enter the type of transducer connected to the SITRANS LU10 for the Point Number displayed.

- | | ULTRASONIC | ULTRASONIC / TEMPERATURE | |
|---------|-----------------|--------------------------|--------------|
| values: | 0 = not entered | 100 = ST-H | 106 = XPS-40 |
| | 1 = ST-25 | 101 = XCT-8 | 107 = XLT-30 |
| | 2 = ST-50 | 102 = XPS-10 | 108 = XLT-60 |
| | 3 = ST-100 | 103 = XCT-12 | 109 = XLS-30 |
| | 4 = LR-21 | 104 = XPS-15 | 110 = XLS-60 |
| | 5 = LR-13 | 105 = XPS-30 | 111 = XKS-6 |
| | | | 112 = XRS-5 |

P005 (G) UNITS

Enter the units of measure desired for programming Empty (P006) and Span (P007).

- values: 1 = meters (m) (preset)
- 2 = centimeters (cm)
- 3 = millimeters (mm)
- 4 = feet (ft)
- 5 = inches (in)

P006 EMPTY

Enter the *maximum distance* (transducer face to vessel bottom) to be measured, in Units.

This value is preset to 8.000 m (or equivalent Units programmed).

The value entered automatically sets Span (P007) to the maximum recommended value.

values: 0.000 to 9999

P007 SPAN

Enter the maximum surface distance from Empty (P006).

Span is automatically preset to 1.1 x the blanking value (P800) less than the Empty value (P006), unless it is altered manually.

For "distance" Operation (P001 = 3), Span is preset to the Empty value (P006).

Enter a lower value if desired. If the automatic setting is not high enough, see Installation. Always prevent the monitored surface from entering the blanking zone.

values: 0.000 to 9999

With the Quick Start Parameters altered as required, proceed to Operation to identify / verify basic system performance.

Operation

With Quick Start parameter alteration complete, the SITRANS LU10 may be put into operation. (If application or enhancement parameters are altered, operation is altered accordingly from that indicated.)

Display

In the RUN mode, the following values and indicators may be observed.

Note that many indicators are specific to certain operating conditions and therefore, **all indicators are not displayed at any given time.**

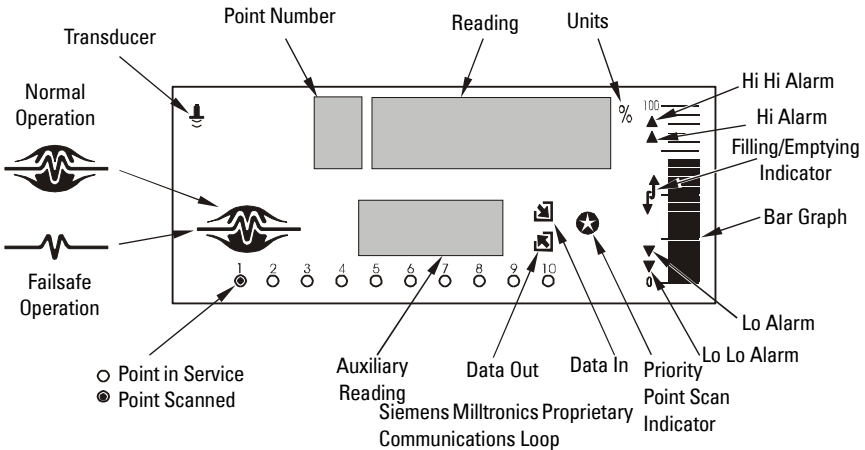







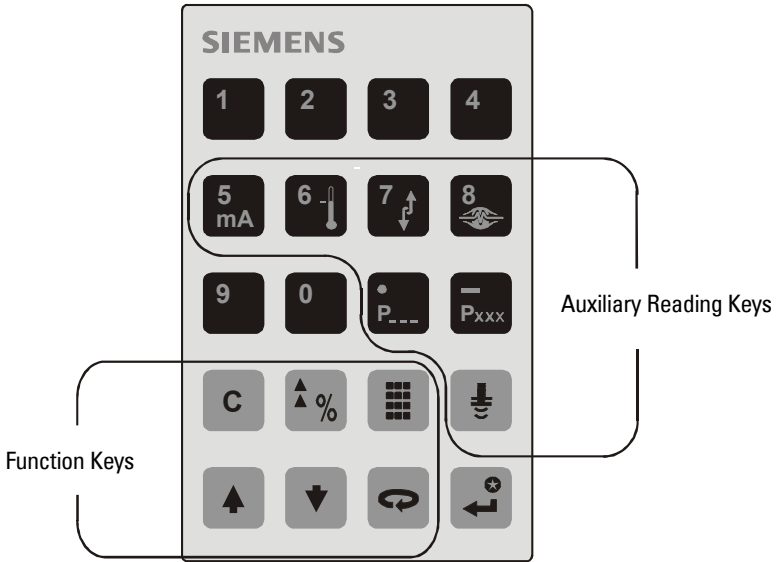







Transducer	the current display pertains to a transducer measurement.
Point Number	the Point Number (1 to 10) the current display pertains to.
Reading	displays the level, space, or distance (flashes error messages, if any).
Units	the Reading is in m, cm, mm, ft, in, or %.
Hi Alarm	indicates level has risen above 80% (and not yet fallen below 75%).
Lo Alarm	indicates level has fallen below 20% (and not yet risen above 25%).
Hi Hi Alarm	indicates level has risen above 90% (and not yet fallen below 85%).
Lo Lo Alarm	indicates level has fallen below 10% (and not yet risen above 15%).
Filling Indicator	indicates the vessel is filling.
Emptying Indicator	indicates the vessel is emptying.
Bar Graph	indicates the material level from 0 to 100%.
Data In	indicates the SITRANS LU10 is receiving data from the BIC-II (if used).
Data Out	indicates the SITRANS LU10 is transmitting data to the Peripheral Communications terminals.
Auxiliary Reading	as selected by the keypad (terminal numbers if transducer or TS-3 is wired wrong).
Point in Service	indicates the Point Numbers included in the scan sequence.
Point Scanned	indicates the Point scanned (independent from the Point Number display).
Normal Operation	indicates operating conditions are good and the Reading is reliable.
Failsafe Operation	indicates operating conditions are poor and the Reading may be incorrect.

Keypad

In the RUN mode, the following programmer keys perform the identified functions.



-  selects the Auxiliary Reading "mA output value for the Point Number displayed".
-  selects the Auxiliary Reading "vessel atmosphere temperature".
-  selects the Auxiliary Reading "rate of material level change".
-  selects the Auxiliary Reading "failsafe time left" (in percent).
-  selects the Auxiliary Reading "parameter value" (Key in any Parameter Number).
-  selects the Auxiliary Reading "material level" (may be operator altered via P731).
-  selects the Auxiliary Reading "distance" (material level to transducer face).
-  initiates PROGRAM mode access (see ).
-  switches the Reading between "Units / percent of Span" (completes PROGRAM mode access).
-  stops / starts the Point Number auto display scroll.
-  selects the next Point Number (and stops the auto display scroll).
-  selects the previous Point Number (and stops the auto display scroll).
-  places a Point Number on priority (See P720).

System Performance Evaluation

For initial RUN mode entry (or after any programming alteration), do not use the SITRANS LU10 to operate process control equipment until satisfactory system programming and performance is verified.

- Press  to enter the RUN mode.
"----" may be displayed briefly while the SITRANS LU10 takes measurements and calculates the Reading.

When a Transducer (P004) value is entered for Point # 1 only, the Reading and other data is displayed continuously. When Transducer values are entered for more than one Point Number, Readings and other data scroll display for each Point Number.

If an alarm symbol is displayed, the corresponding relay is de-energized.

POINT #	ALARM INDICATOR	LU SAM#	RELAY #
1-10	Hi Alarm	1	1-10
1-10	Lo Alarm	1	11-20
1-10	Hi Hi Alarm	2	1-10
1-10	Lo Lo Alarm	2	11-20

- Press  to display Readings in % (percent of Span, P007) based upon Operation (P001).

OPERATION	LEVEL	SPACE or DISTANCE*
Empty to Full =	0 to 100%	100 to 0%
* Objects close to the transducer face (0%) are not detectable.		

- Press  to observe the mA output value for the Point Number displayed (Auxiliary Reading).

OPERATION	LEVEL	SPACE or DISTANCE*
Empty to Full =	4–20 mA	20–4 mA
* Objects close to the transducer face (4 mA) are not detectable.		

- Press  to observe the *Failsafe Time Left* (time left in percent before failsafe activation).

Each time a valid measurement is made for the Point Number displayed, this value (Auxiliary Reading) is reset to 100 and begins to fall toward 0 until the next valid measurement is made.

If the Failsafe Time Left reaches 0, the SITRANS LU10 flashes "LOE" in the Reading display.

Note: All associated data is supplied to the Peripheral Communications terminals (42 and 43). If a BIC-II is connected, refer to *Technical Reference* BIC-II Support for message format and protocol information.

Performance Test Results

Monitor system performance carefully, under all anticipated operating conditions.

- A. When the SITRANS LU10 performs exactly as required, programming is complete.
- B. If the SITRANS LU10 measurements are accurate and reliable but alternate Reading, units, failsafe, LU SAM relay, or LU AO mA output operation is desired, proceed to Application Parameters.
- C. Should system performance not meet installation requirements, (or the "LOE" display persists after start up), proceed to the *Troubleshooting Guide*.

If all operating conditions cannot be observed during the System Performance Evaluation, refer to *Enhancement Parameters* Reading Measurement (P920). Perform a Reading Measurement simulation to verify programming.

Conduct a System Performance Evaluation following any installation modification or Quick Start, Application, or Enhancement Parameter alteration.

With programming complete, copy all parameter alterations to the Programming Charts. In the PROGRAM mode, all altered parameters may be quickly scroll accessed (skipping by parameters left at preset values).

Connect (or enable) process control / alarm equipment to the SITRANS LU10 only after satisfactory performance is verified for all possible operating conditions.

For normal operation, return to the RUN mode. The SITRANS LU10 will perform reliably, with little or no maintenance.

Application Parameters

Application Parameters are used to alter the SITRANS LU10 display, failsafe, relay, and / or mA output operation.

Volume Parameters (P050 to P055)

If Readings proportional to volume are desired, adjust the following parameters.

If Volume Conversion is not required, proceed to Reading Parameters.

P050 TANK SHAPE

Enter the Tank Shape option that matches the vessel monitored.

If the Tank Shape option selected requires additional vessel dimension entry, the **associated parameters** (as indicated below) may be scroll accessed.

When Operation is "level" (P001 = 1), material volume is calculated. Alternatively, when Operation is "space" (P001 = 2), remaining vessel capacity is calculated.

In the RUN mode, Readings are displayed in percent of (and mA outputs are proportional to) maximum volume. To convert Readings to volumetric units, see Max Volume (P051).

When monitoring solids, volume calculation accuracy may vary.

values: 0 = volume calculation not required (preset)

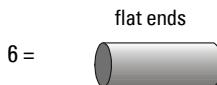
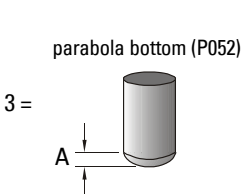
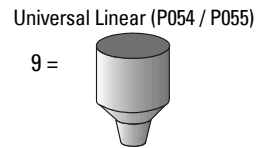
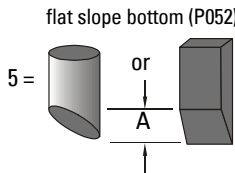
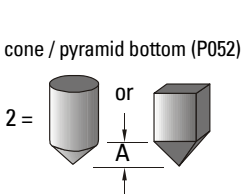
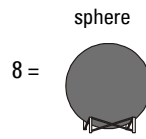
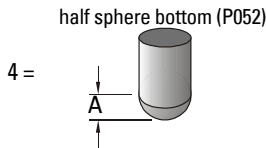
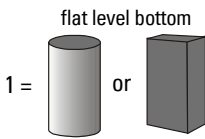

10 = Universal Curved (P054 / P055)

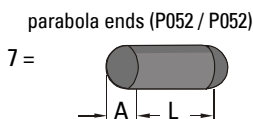

P051 MAX VOLUME

Use this feature to display the Reading in volumetric units rather than percent.

Enter the vessel volume between Empty (P006) and Span (P007).

e.g. 1 If the volume = 3650 m^3 , enter 3650.

e.g. 2 If the volume = 267,500 U.S. gallons, enter 267.5 (1000's of gallons).

values: 0.000 to 9999

P052 TANK DIMENSION A

Enter the height of the tank bottom if P050 = 2,3,4, or 5, or the length of one end section of the tank if P050 = 7, in Units (P005).

values: 0.000 to 9999

P053 TANK DIMENSION L

Enter the length of the tank (excluding both end sections) if P050 = 7, in Units (P005).

values: 0.000 to 9999

P054 LEVEL BREAKPOINTS (Universal Volume Calculation)

Enter level breakpoints* (where volume is known) if P050 = 9 or 10





values: 0.000 to 9999

P055 BREAKPOINT VOLUMES (Universal Volume Calculation)

Enter the volume* corresponding to each Level Breakpoint entered.

values: 0.000 to 9999

* Steps to enter a Level Breakpoint or Breakpoint Volume:

1. Press  %  to display the index symbol, \rightarrow .
2. Scroll ( or ) or direct access the desired Breakpoint.
3. Key in the desired level or volume value.
4. Press .

Refer to *Technical Reference Volume Calculation* for breakpoint value selection.

Reading Parameters (P060 to P062)

If Reading alteration is required, alter the following parameters to:

- alter the number of decimal places displayed.
- convert to units other than Units (P005), % of Span (P007), or Max Volume (P051).
- reference measurements to some point other than Empty (P006) or Span (P007).

If alteration is not required, proceed to Failsafe Parameters.

P060 DECIMAL POSITION

Enter the maximum number of decimal places to be displayed in the Reading.

In the RUN mode, the number of decimal places displayed is automatically adjusted (if necessary) to prevent the number of Reading digits from exceeding display capabilities.

This value is automatically altered when Max Volume (P051) is altered.

values: 0 = no digits after the decimal point
1 = 1 digit after the decimal point
2 = 2 digits after the decimal point
3 = 3 digits after the decimal point

P061 CONVERT READING

Enter the value to multiply the Reading by (before display).

This feature is preset to 1.000 (no conversion).

e.g. If the Reading is currently displayed in feet, to display in yards, enter 3.

Avoid entering a value that, when multiplied by the maximum current reading, could exceed 5 digits before the Decimal Position

values: -999 to 9999

P062 OFFSET READING

Enter the value to be added to the Reading, (before display).

This feature is preset to 0.000, (no offset).

e.g. To reference a material level to sea level, enter the distance in Units (P005), between Empty (P006) and sea level. (Enter a negative value if Empty is below sea level.)

This feature affects the SITRANS LU10 (and BIC-II, if used) Reading only. (Relays and mA outputs are not affected).

values: -999 to 9999

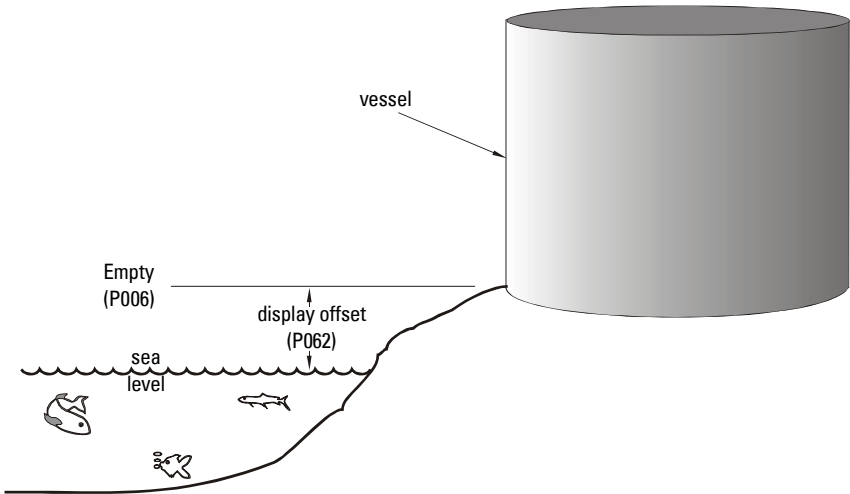

Failsafe Parameters (P070 to P072)

As preset, in the event of a measurement or technical difficulty, the SITRANS LU10 holds the Reading, Bar Graph, LU SAM relays (if used) and LU AO mA outputs (if used), at their last known values.

To operate process control equipment under these conditions, alter the following parameters as required.

If alternate Failsafe Operation is not required, proceed to RELAY PARAMETERS.

P070 FAILSAFE TIMER

Enter the time to elapse (in minutes), upon a difficulty, before failsafe operation is activated.

In the RUN mode, when a difficulty first occurs, the Reading, Bar Graph, relay status, and mA outputs are held at "last known" values and the Failsafe Timer is activated.

When a valid measurement is made before the timer expires, the SITRANS LU10 advances to the "new" material level (if changed) as normal (per Measurement Response, P003) and the timer resets.

If the timer expires (before a valid measurement is made), the SITRANS LU10 advances to the Failsafe Material Level (P071) as restricted by Failsafe Advance (P072).

When a valid measurement is made after the timer expires, the SITRANS LU10 advances to the "new" material level (if changed), as restricted by Failsafe Advance (P072) and the timer resets.

If the timer expires due to a measurement difficulty, "LOE" flashes in the Reading display.

Technical difficulty messages flash in the Reading display before the timer expires. The offending terminal connections are displayed in the Auxiliary Reading display

DISPLAY	CAUSE
"LOE"	weak echo (see <i>Troubleshooting Guide</i> Measurement Difficulties)
"Short"	short circuited transducer cable, or defective transducer
"OPEN"	open circuited transducer cable, or Point Number is scanned but a transducer is not connected, or defective transducer
"Error"	reversed Ultrasonic/Temperature transducer terminal connections or wrong Transducer (P004) entered.

While a short duration Failsafe Timer value may be required (when process control equipment is used) avoid entering a value so short as to cause nuisance activation.

This feature is automatically altered when Measurement Response (P003) is altered.

values: 0.000 to 9999

P071 FAILSAFE MATERIAL LEVEL

Select the material level to be reported when the Failsafe Timer expires.

If "HOLD" (preset) is selected, in the RUN mode, the last known material level is held.

If "HI" or "LO" are selected, the SITRANS LU10 advances to the Span (P007) level or Empty (P006) level as restricted by Failsafe Level Advance.



Select the Failsafe Material Level based upon the relay and/or mA output operation required during failsafe operation.

e.g. 1 To de-energize a high alarm relay (perhaps to stop material infeed), select "HI".

e.g. 2 To force an "empty vessel" mA output (perhaps to have pumps stopped), select "LO".

To select HI, LO, or HOLD:

Press  % to display the Auxiliary Function symbol.

Press  or  as required to scroll access the desired option.

Press .

Alternatively, a specific Failsafe Material Level within -50 to 150% of Span (P007) may be entered directly in Units (P005), or % of Span (P007).

values: -999 to 9999

P072 FAILSAFE LEVEL ADVANCE

Select the restriction applied to the SITRANS LU10 advance to (and from) the Failsafe Material Level.

When "restricted" (preset), the SITRANS LU10 advances to the Failsafe Material Level (and to the "new" material level when a valid measurement is made) as determined by the Measurement Response (P003) or the Max Fill / Empty Rate (P700 / P701) values entered.

Alternatively, when "immediate" is selected, the Failsafe Material Level (or "new" material level) is assumed immediately.

Otherwise, when "fastback" is selected, the Failsafe Level Advance is restricted, however the advance to the new material level (when a valid measurement is made) is immediate.

values: 1 = restricted
2 = immediate
3 = fastback

Relay Parameters (P100 to P104, P110 to P113, P129)

If relays are to be used, alter the following parameters as required. **Otherwise, proceed to mA Output Parameters.**

Relays may be programmed as Standard Alarms or for Custom Relay operation.

For **Standard Alarms** (relays operate based on material level), select the Relay Set Up (P100) desired and alter the Standard Alarm (P101 to P104) parameters as required, before proceeding to Relay Failsafe (P129).

For Custom Relay operation, select the Relay Set Up (P100) which most closely matches your requirements, and alter the Custom Relay Parameters (P110 to P113) as required, before proceeding to Relay Failsafe.

P100 (G) RELAY SET UP

This parameter presets relays to operate as Standard Alarms. The **Relay Allocation** (relay / point number association) and Standard Alarm (P101 to P104) parameters are also preset.

SET UP	LU SAM #	RELAY #	POINT #	STANDARD ALARM (as % of Span, P007)
1	1	1 - 10	1 - 10	(Hi Alarm) P101 = 80.00%
	1	11 - 20	1 - 10	(Lo Alarm) P102 = 20.00%
	2	1 - 10	1 - 10	(Hi Hi Alarm) P103 = 90.00%
	2	11 - 20	1 - 10	(Lo Lo Alarm) P104 = 10.00%
2	1	1 - 10	1 - 10	(Hi Alarm) P101 = 80.00%
	1	11 - 20	1 - 10	(Hi Hi Alarm) P103 = 90.00%
	2	1 - 10	1 - 10	(Lo Alarm) P102 = 20.00%
	2	1 - 20	1 - 10	(Lo Lo Alarm) P104 = 10.00%
3	1	1 - 5	1 - 5	(Hi Alarm) P101 = 80.00%
	1	6 - 10	1 - 5	(Lo Alarm) P102 = 20.00%
	1	11 - 15	1 - 5	(Hi Hi Alarm) P103 = 90.00%
	1	16 - 20	1 - 5	(Lo Lo Alarm) P104 = 10.00%
	2	1 - 5	6 - 10	(Hi Alarm) P101 = 80.00%
	2	6 - 10	6 - 10	(Lo Alarm) P102 = 20.00%
	2	11 - 15	6 - 10	(Hi Hi Alarm) P103 = 90.00%
	2	16 - 20	6 - 10	(Lo Lo Alarm) P104 = 10.00%

Relay status during a measurement difficulty is dependent upon Failsafe programming. (See Failsafe Parameters (P070 to P072) and Relay Failsafe (P129). As preset, relay status is "held" at last known material levels until a valid measurement is made.

Independently altered Standard Alarms (P101 to P104), Relay Allocation (P110), Relay Function (P111) and Relay A / B Setpoints (P112/P113) are automatically reset when a Relay Set Up value is altered.

values: 1 = Set Up 1
2 = Set Up 2
3 = Set Up 3

Standard Alarms (P101 to P104)

In the RUN mode:

- when the material level rises to a Hi or Hi Hi Alarm value, the Alarm indicator is displayed and the allocated relay(s) de-energize.
- when the material level falls 5% of Span (P007) below the Hi or Hi Hi Alarm value, the Alarm indicator extinguishes, and the allocated relay(s) energize.
- when the material level falls below the Lo or Lo Lo Alarm value, the Alarm indicator is displayed and the allocated relay(s) de-energize.
- when the material level rises 5% of Span (P007) above the Lo and Lo Lo Alarm value, the Alarm indicator extinguishes, and the allocated relay(s) energize.

Enter all Standard Alarm material level values in Units (P005) or percent of Span (P007) as referenced to Empty (P006).

To display the current value (or enter a new value) in percent of Span

Press  % as required to display the % symbol.

P101 HI ALARM

Enter the Hi Alarm material level for the Point Number displayed.

values: -999 to 9999 (preset to 80.00% of Span)

P102 LO ALARM

Enter the Lo Alarm material level for the Point Number displayed.

values: -999 to 9999 (preset to 20.00% of Span)

P103 HI HI ALARM

Enter the Hi Hi Alarm material level for the Point Number displayed.

values: -999 to 9999 (preset to 90.00% of Span)

P104 LO LO ALARM

Enter the Lo Lo Alarm material level for the Point Number displayed.

values: -999 to 9999 (preset to 10.00% of Span)

"Ch" is displayed if a Custom Relay Parameter was previously operator altered. Use Relay A / B Setpoints (P112 / P113) instead.

If Custom Relay operation is not required, proceed to Relay Failsafe (P129).

"OFF" is displayed if the Relay Set Up (P100) selected does not use the Alarm parameter accessed.

Custom Relays (P110 to P113)

P110 RELAY ALLOCATION

Use this feature to alter the Relay Set Up (P100) relay / point number association, to have any relay operate based upon the operation of any point number.

When accessed, the Relay Symbol is displayed in the Point Type field and the Relay Number (corresponding to the LU SAM terminals) is displayed in the Point Number field.

e.g. To allocate Relay 3 to Point 1, with Relay Number 3 displayed, enter 1.

If a relay is allocated to more than one Point Number, when any Point Number (in the allocation range) is in alarm, the relay de-energizes.

When Relay Allocation is altered, affected alarm (P101 to P104) parameters display "ch" (changed), when accessed. Use the Relay A / B Setpoint (P112 / P113) parameters.

values: x (x = single Point Number (1-10) to be allocated to the Relay Number)
x.y (x = first Point Number (1-10), y = last Point Number (1-10), in the range)





P111 RELAY FUNCTION

Use this feature if alternate relay function, designation, or operation is required.

When accessed, the Relay Symbol is displayed in the Point Type field and the Relay Number (corresponding to the LU SAM terminals) is displayed in the Point Number field.

FUNCTION	DESIGNATION	OPERATION
Level	LL,L,H, or HH	similar to Standard Alarms but with Relay A/B Setpoints
In Bounds	b1 or b2*	alarms when level is between the Relay A/B Setpoints
Out of Bounds	b1 or b2*	alarms when level is not between the Relay A/B Setpoints
Rate	r1 or r2*	level rate of change alarm with Relay A/B Setpoints
Temperature	no designation	alarm is activated by independent Relay A/B Setpoints
LOE	no designation	relay de-energizes in the event of Failsafe Timer (P700) expiry
Cable Fault	no designation	relay de-energizes under transducer short or opened condition.
* The Relay Designation is included in the BIC-II (if used) data message (not displayed).		

To enter a Relay Designation:

1. Press  to display the Auxiliary Function symbol.
2. Press  or  to scroll access the desired relay designation and.
3. Press .

When the Relay Function is altered, affected Standard Alarm Parameters (P101 to P104) display "ch" (changed) when accessed. Use the Relay A / B Setpoints (P112 / P113).

To reset the Relay Function to use Standard Alarms, enter the desired Relay Set Up (P100).

values:	0 = off (relay always de-energized)
	1 = level alarm (preset)
	2 = in bounds alarm (relays de-energized on alarm)
	3 = out of bounds alarm (relays de-energized on alarm)
	4 = rate of change alarm (relays de-energized on alarm)
	5 = temperature alarm (relays de-energized on alarm)
	6 = LOE alarm (relays de-energized on alarm, Relay A / B Setpoints are not applicable)
	7 = transducer cable fault alarm

Independent Relay Setpoints

Relay A and B Setpoint values set the critical points (based on the Relay Function) where, in the RUN mode

1. Alarm Indicators (if programmed) are switched "ON" and OFF"
2. Relays are "energized" and "de-energized"

For most Relay Functions, setpoint values represent material levels, entered in Units (P005) or percent of Span (P007) as referenced to Empty (P006). Temperature alarm values are entered in degrees Celsius (°C).

Rate alarms are entered in Units/minute or percent of Span per minute. A positive value is entered for a filling rate alarm, negative for emptying.

RELAY FUNCTION	SETPOINTS*		RELAY ACTION	WHEN
	A	B		
Level H or HH	85 %	70 %	de-energizes	level rises to 85%
			energizes	level falls to 70%
Level L or LL	15 %	30 %	de-energizes	level falls to 15%
			energizes	level rises to 30%
In Bounds**	80%	50%	de-energizes	level falls to 78%
			energizes	level rises to 82%
			de-energizes	level rises to 52%
			energizes	level falls to 48%
Out of Bounds**	80%	50%	energizes	level falls to 78%
			de-energizes	level rises to 82%
			energizes	level rises to 52%
			de-energizes	level falls to 48%
Rate of Change	+10%	+5%	de-energizes	fill rate increases to 10%/min
			energizes	fill rate decreases to 5%/min
	-10%	-5%	de-energizes	empty rate increases to 10%/min
			energizes	empty rate decreases to 5%/min
Temperature	60	55	de-energizes	temperature rises to 60 °C
			energizes	temperature falls to 55 °C
	-30	-25	de-energizes	temperature falls to -30 °C
			energizes	temperature rises to -25 °C
* Values shown are for illustration purposes only. Enter values which apply to your particular installation.				
**2% factory set hysteresis, adjustable via P116.				

Important! Relay A / B Setpoint values cannot be exactly equal.

P112 RELAY A SETPOINT

Enter the critical point for the desired action to occur (based on the Relay Function selected).

values: -999 to 9999

P113 RELAY B SETPOINT

Enter the critical point for the desired action to occur (based on the Relay Function selected).

values: -999 to 9999

P 116 BOUND ALARM HYSTERISIS

For 'in bounds' and 'out of bounds' Relay Functions (P111 = 2 and 3 respectively), a hysteresis or dead band prevents relay chatter due to material level fluctuations at the upper or lower setpoint.

Enter hysteresis in % of span or units of P005. (Factory set at 2%).

The hysteresis value is applied above and below the upper and lower bound setpoints.

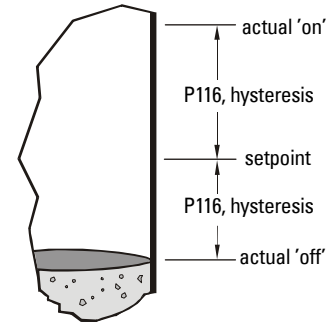

e.g. in bounds, lower setpoint





P129 RELAY FAILSAFE

Use this feature for relay failsafe operation independent from the Failsafe Material Level (P070).

When accessed, the Relay Symbol is displayed in the Point Type field and the Relay Number (corresponding to the LU SAM terminals) is displayed in the Point Number field.

- Select:
- "OFF" (preset) to have the relay respond to the Failsafe Material Level (P701).
 - "HOLd" to hold the relay at the "last known" state until normal operation resumes,
 - "dE" to have the relay de-energize immediately, or
 - "En" to have the relay energize immediately,

To select an independent Relay Failsafe option value:

1. Press  to display to the Auxiliary Function symbol,
2. Press  or  to scroll access the failsafe options.
3. Press  with the desired option displayed.

- values:
- "OFF"
 - "HOLd"
 - "dE"
 - "En"

mA Output Parameters (P200 to P203, P210 to P215, P219)

If LU AO mA outputs are to be used, alter the following parameters as required. Otherwise, proceed to Operation.

When a mA Output Parameter is accessed, the mA symbol is displayed in the Point Type field and the mA Output Number (corresponding to the LU AO terminals) is displayed in the Point Number field.

P200 mA RANGE

Enter the desired range of the mA output displayed.

value:	0 = OFF	}	20 mA = high level (unless P001 = 2 or 3, then 20 mA = low)
	1 = 0 to 20 mA		
	2 = 4 to 20 mA (preset)		
	3 = 20 to 0 mA	}	20 mA = low level (unless P001 = 2 or 3, then 20 mA = high)
	4 = 20 to 4 mA		

P201 mA FUNCTION

Use this feature to alter the automatic mA output/measurement relationship, if desired.

The mA Function automatically corresponds to "level", "space", or "distance" based upon Operation (P001). If a Tank Shape (P050) is programmed, the mA Function automatically corresponds to volume (unless the mA Allocation has been altered).

values: 1 = level
 2 = space
 3 = distance
 4 = volume

P202 mA ALLOCATION

Use this feature if Point Number to mA output allocation alteration is required.

Enter the Point Number(s) the mA output displayed, is to be based upon

As preset, LU AO mA outputs 1-10 are allocated to Point Numbers 1-10 respectively

If two or more Point Numbers are allocated to a single mA output, the output value represents the Multi-point Average. (The Quick Start Parameter values should be identical for all points). See *Technical Reference* Application Examples Example 3 - mA Multi Point Average.

When more than one mA output is allocated to the same Point Number, the mA Setpoint parameters may be used to establish separate or overlapping mA output spans. However, the mA Value/Transducer (P203) corresponds to the lowest mA Output number only.

values: x (x = single Point Number (1-10) to be allocated to the mA output displayed.

x,y (x = first Point Number (1-10), y = last Point Number (1-10), in the range)

P203 (V) mA VALUE/TRANSDUCER

View the current value of the mA output associated with the Point Number displayed.

This is the Auxiliary Reading displayed when  is pressed in the RUN mode and does not include any adjustment made using the 4 or 20 mA Trim (P214, P215) features.

If the Point Number is included in a mA Multi-point Average calculation, the displayed value is the average obtained from all Point Numbers included in the mA Allocation (P202) range.

If more than one mA output is allocated to the same Point Number, the value of the lowest mA Output Number is displayed.

values: 0.000 to 22.00

P210 0/4 mA SETPOINT

Use this feature to reference the minimum mA output to any point in the measurement range. Enter the material level (referenced to Empty, P006) corresponding to the minimum mA output. This feature is preset to 0% or 100% of Span (P007) as determined by Operation (P001).

Typically, this value is entered in Units (P005) or percent of Span (P007). If mA Function is set for "volume", enter the value in the Max Volume (P051) units or in percent of Max Volume.

values: -999 to 9999

P211 20 mA SETPOINT

Use this feature to reference the 20 mA output to any point in the measurement range between Empty (P006) and Span (P007).

Enter the material level (referenced to Empty, P006) corresponding to 20mA.

This feature is preset to 0% or 100% of Span (P007) as determined by Operation (P001).

Typically, the value is entered in Units (P005) or percent of Span (P007). If mA Function is set for "volume", enter the value in the Max Volume (P051) units or as a percent of Max Volume.

values: -999 to 9999

P212 mA MIN LIMIT

Use this feature to prevent the mA output from falling below the minimum acceptable mA input value (preset to 3.800 mA) of the device connected.

values: 0.000 to 22.00

P213 mA MAX LIMIT

Use this feature to prevent the mA output from exceeding the maximum acceptable mA input value (preset to 20.20 mA) of the device connected.

values: 0.000 to 22.00

P214 4 mA TRIM

Use this feature (in combination with 20 mA Trim) if the device connected to the mA output displayed is out of calibration, yet device recalibration is impractical.

Adjust this value as required to make the device connected indicate 4.000 mA when this parameter is accessed. Use of this feature does not affect the mA Value / Transducer (P203) value displayed.

values: -1.00 to 1.000

P215 20 mA TRIM

Use this feature (in combination with 4 mA Trim) if the device connected to the mA output displayed is out of calibration, yet device recalibration is impractical.





Adjust this value as required to make the device connected indicate 20.00 mA when this parameter is accessed. Use of this feature does not affect the mA Value / Transducer (P203) value displayed.

values: -1.00 to 1.000

P219 mA FAILSAFE

Use this feature if mA output failsafe operation, independent from the Failsafe Material Level (P071) is desired.

To select an independent mA Failsafe option value:

1. Press  to display the Auxiliary Function symbol.
2. Press  or  to scroll access the failsafe options.
3. Press  with the desired option displayed.

values: "OFF" to have the mA output respond to the Failsafe Material Level (P701) (F).
 "HOLd" to hold the output at the "last known" value until normal operation resumes.
 "LO" to produce the "Empty" mA output immediately on Failsafe Timer (P070) expiry.
 "HI" to produce the "Span" mA output immediately on Failsafe Timer (P070) expiry.

Alternatively, to produce an immediate mA output at a specific value, enter the value required.

values: 0.000 to 22.00

Enhancement Parameters

This section identifies all SITRANS LU10 operator programmable features designed for altering operation to suit individual operator preferences or overcome measurement difficulties.

Typically, these parameters are only altered as directed by the Troubleshooting Guide . If RUN mode performance requires improvement, access and alter the following parameters as required. Otherwise, proceed to Operation.

Parameter Category	Purpose	Page
Data Logging	to view previous maximum Temperature records	50
Profile Records	intended for use by Siemens Milltronics Service personnel	51
Installation Records	to identify length of service and power failure occurrence	54
Range Calibration	to compensate for measurement offset and/or sound velocity	55
Temperature Compensation	to override automatic temperature compensation features	57
Rate	to override Measurement Response (P003)	59
Measurement Verification	to override Measurement Response (P003)	61
Scanning	to override automatic scanning delay or use Aux. Transducer	63
Display Parameters	to override the preset display operating characteristics	65
SmartLinx Parameters	communications	67
Echo Processing	to troubleshoot false echo detection	68
Advanced Echo Processing	intended for use by Siemens Milltronics Service personnel	70
Test Parameters	intended for use by Siemens Milltronics Service personnel	78
Measurement Parameters	to verify Application Parameter programming	80
Master Reset	to reset numerous Parameter Values	81

When an Enhancement Parameter is altered, return to the RUN mode to verify the performance desired is achieved before making any other changes.

Data Logging Parameters (P300 and P302)

View the maximum temperature recorded in the RUN mode.

P300 (V) TEMPERATURE, TRANSDUCER MAX

Use this feature if vessel temperature is monitored by an Ultrasonic / Temperature transducer to view the highest temperature recorded (in °C).

values: -50 to 150

P302 (V) TEMPERATURE, SENSOR MAX

Use this feature if vessel temperature is monitored by a TS-3 Temp Sensor to view the highest temperature recorded (in °C).

When accessed, the TS-3 symbol is displayed in the Point Type field and the TS-3 Number (corresponding to the SITRANS LU10 terminals) is displayed in the Point Number field.

values: -50 to 150

Profile Records (P330 to P337)

The following parameters are for authorized Siemens Milltronics service personnel or Instrumentation Technicians familiar with Siemens Milltronics echo processing techniques.

Use these features to record and save a total of up to 10 Echo profiles, initiated manually (P330), or automatically (P331 et al). See Scope displays (P810) for echo profile viewing hardware / software requirements.

If 10 Echo Profiles are already saved, addresses 1 through 10 are filled, the oldest automatically initiated record is overwritten. Manually initiated records are not automatically overwritten. All records are automatically deleted in the event of a power interruption.

When a record is displayed, results are based on current programming (which may have been altered since the record was saved). This permits the effect on the echo profile to be observed when changing an echo parameter.

P330 PROFILE RECORD

In addition to serving as a library for profile records, this parameter provides two functions:

- manually records and saves echo profiles
- displays an echo profile, recorded manually or automatically, e.g. via an oscilloscope.

To select a record address:

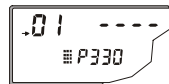

e.g. initial parameter display

Press until address index is enabled.



Press or to select the desired address, 1 to 10, and display the associated parameter value:

' - - - ' = no record

' x# ' = record

where: x = A, automatically initiated

 = U, manually initiated

 # = transducer number

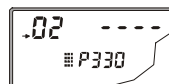

e.g. address 2 selected, no record saved

To manually record a profile:

Press transducer* fires and echo profile is recorded into the internal scope buffer for display.

To save a manual record:

Press to copy the echo profile record in the scope buffer and save it in the selected address in the record library. The parameter value field displays the new record ordinates.

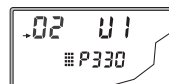

e.g. manually initiated record from transducer 1 saved in address 2

To display a record:

Press to copy the echo profile record in the selected address to the scope buffer, for display.

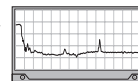
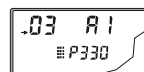

e.g. oscilloscope displays record in address 3

To delete a record:

Press to delete the echo profile record in the selected address. Parameter value returns to ' - - - '.

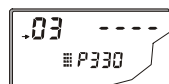

e.g. record deleted, address 3 clear

* Access the Scope Displays (P810) parameter to select the Transducer.

P331 (G) AUTO RECORD ENABLE

Use this feature (if desired) to enable / disable the Auto Profile Record function.

values: 0 = off
1 = on

P332 (G) AUTO RECORD TRANSDUCER

Use this feature (if desired) to specify the Transducer Point Number for which Auto Profile Records are saved.

This feature is preset to Point Number 1.

values: 0 = any Transducer
1 = Transducer 1 (preset)
2 = Transducer 2

P333 (G) AUTO RECORD INTERVAL

Enter the time (in minutes) to elapse after an Auto Profile Record is saved before another Auto Profile Record can be saved (subject to all other restrictions).

values: 0.000 to 9999 (preset to 120 minutes)

AUTO RECORD A / B Setpoints

Use Auto Record A Setpoint (P334) and Auto Record B Setpoint (P335) to define the boundaries within which the level must be for the resultant Echo Profile to be considered for an Auto Profile Record.

If "----" is displayed for either P334 or P335, Auto Profile Records are saved regardless of current level (subject to all other restrictions).

Enter the level value in Units (P004) or percent of Span (P007) as referenced to Empty (P006). (Ensure the % Symbol is displayed before attempting to enter a value in percent, see *Programming Keypad*).

P334 (G) AUTO RECORD A SETPOINT

Enter the critical level which, in conjunction with Auto Record B Setpoint, defines the boundaries for Auto Profile Records to be saved.

values: -999 to 9999

P335 (G) AUTO RECORD B SETPOINT

Enter the critical level which, in conjunction with Auto Record A Setpoint, defines the boundaries for Auto Profile Records to be saved.

values: -999 to 9999

P336 (G) AUTO RECORD FILLING / EMPTYING

Use this feature to restrict Auto Profile Records from being saved unless the level is rising, falling or either.

If the level changes at a rate in excess of the corresponding Filling / Emptying Indicator (P702 / P703) values, the Echo Profile is saved subject to this and other Auto Profile Record restrictions.

values: 0 = Auto Profile Record on filling or emptying (preset)

1 = Auto Profile Record on filling only.

2 = Auto Profile Record on emptying only.

P337 (G) AUTO RECORD LOE TIME

Use this feature to restrict Auto Profile Records from being saved unless an extended loss of echo (LOE) condition occurs.

If the LOE condition exceeds the period entered (in seconds) the Echo Profile is saved, subject to this and other restrictions.

When set for "0" (preset), LOE is not required for an Auto Profile Record to be saved.

values: 0.0 to 9999

Installation Records (P340 to P342)

Use these features to view data relating to this specific SITRANS LU10 installation.

P340 (V) DATE OF MANUFACTURE

View the date of manufacture of this SITRANS LU10.

values: YY:MM:DD format

P341 (V) RUN TIME

View the accumulated number of days this SITRANS LU10 has been operating, since the Date of Manufacture (P340).

This value is stored in EEPROM and updated once each day. Therefore, if the SITRANS LU10 is powered down at least once every 24 hour period, this value will always be less than 1.

values: 0.000 to 9999

P342 (V) START UPS

View the accumulated number of times power has been applied to the SITRANS LU10 (following a power interruption), since the Date Of Manufacture.

values: 1 to 9999

Range Calibration Parameters (P650 to P654)

P650 OFFSET CALIBRATION

Use this feature if the Empty (P006) value was estimated or if the reported material level is consistently high or low by a fixed amount (e.g. 2 cm).

Before using this feature, verify the

- Empty (P006) value (as measured or estimated) was entered correctly.
- Vessel atmosphere Temperature (P664) is correct.
- Offset Reading (P062) value (if used) was entered correctly.

To perform an Offset Calibration:

With the material at a **high** steady level...

- Press  to display the calculated distance*.
- Repeat step 1 at least 5 times to overcome Echo Lock (P721) and verify repeatability.
- Measure the actual distance* (e.g. with a tape measure).
- Enter the actual value. (The Offset Correction amount is stored in P652).

values: -999 to 9999

P651 SOUND VELOCITY CALIBRATION

Use this feature if:

- a) The vessel atmosphere is other than air.
- b) The vessel atmosphere temperature is unknown and a temperature sensing device is not used.
- c) The Reading accuracy is acceptable at higher material levels only.

To perform a Sound Velocity Calibration:

With the material at a **low** steady level perform the following steps.

1. Allow sufficient time for the vapour concentration to stabilize.
2. Press  to display the calculated distance*.
3. Repeat step 2 at least 5 times to overcome Echo Lock (P721) and verify repeatability.
4. Measure the actual distance* (e.g. with a tape measure).
5. Enter the actual value. (Velocity parameters P653 and P654 are adjusted accordingly).

Repeat this procedure if the vessel atmosphere type, concentration, or temperature varies from that present when the last sound velocity calibration was performed.

values: -999 to 9999

* When Operation (P001) for the Point Number displayed is set for:

- a) "level", the distance is from Empty (P006) to the material / object surface.
- b) "space" or "tripper", the distance is from Span (P007) to the material / object surface.
- c) "distance", the distance is from the transducer face to the material / object surface.

P652 OFFSET CORRECTION

View the amount of offset applied to the Reading.

This value is automatically adjusted when an Offset Calibration is performed.

Alternatively, if the amount of Offset Correction required is known (and performing an Offset Calibration is not desired), enter the amount to be added to the Reading before display.

values: -999 to 9999

P653 VELOCITY

View the current vessel atmosphere sound velocity.

This value is based on Velocity at 20°C (P654) for the current Temperature (P664), based on the sound velocity vs. temperature characteristics of air.

When a Sound Velocity Calibration is performed, this value is automatically adjusted as required to suit the current atmosphere type, concentration, and temperature.

Alternatively, if the current sound velocity is known, enter the current sound velocity. (Refer to *Technical Reference* Sound Velocity).

The units used are m/s if P005 = 1, 2, or 3 (ft/s if P005 = 4 or 5).

values: 50.01 to 2001 m/s (164.1 to 6563 ft/s)

P654 VELOCITY AT 20°C

View the current vessel atmosphere sound velocity normalized to 20°C (68°F).

This value is used to calculate Sound Velocity (P653), using Temperature (P664) based on the sound velocity vs. temperature characteristics of air.

After a Sound Velocity Calibration, this value may be checked to verify whether the vessel atmosphere is air (typically 344.1 m/s or 1129 ft/s).

Alternatively, if the vessel atmosphere sound velocity at 20°C (68°F) is known, and the sound velocity vs. temperature characteristics are similar to that of air, enter the sound velocity.

The units used are m/s if P005 = 1, 2, or 3 (or ft/s if P005 = 4 or 5).

values: 50.01 to 2001 m/s (164.1 to 6563 ft/s)

Temperature Compensation Parameters (P660 to P664)

P660 TEMP SOURCE

This feature is preset to "AUTO". On scanning a transducer, the SITRANS LU10 scans the TS-3 temperature sensor* assigned to the transducer. If a TS-3 sensor is not connected, the temperature measurement from the ultrasonic / temperature transducer is used. If the transducer used does not have an integral temperature sensor, the Temp Fixed (P661) value is used.

If the temperature of the atmosphere within the transducer beam varies with distance from the transducer, connect a TS-3 temperature sensor* and an ultrasonic / temperature transducer for the Point Number and select "average".

* Unless equipped with a TIB-9 Card, the SITRANS LU10 provides input terminals for only one TS-3 connection. When a TIB-9 card is installed, up to 10 TS-3 temperature sensors may be connected. Refer to *Installation* TIB-9 Card and Interconnection.

If the atmosphere temperature of several vessels is identical, connect a TS-3 Temperature Sensor to terminals 21 and 22 and select "TS-3 SENSOR # 1". The temperature measurement from the single TS-3 is used for the air temperature measurement of all Point Numbers allocated to TS-3 number 1. (See Temperature Sensor Allocation, P662).

values: 1 = AUTO
2 = Temp Fixed
3 = Ultrasonic / Temperature Transducer
4 = TS-3 Temperature Sensor
5 = Average
6 = TS-3 SENSOR # 1

P661 TEMP FIXED

Use this feature if a temperature sensing device is not used.

Enter the temperature (in °C) of the vessel atmosphere within the transducer beam. If the temperature varies with distance from the transducer, enter the average temperature. This value is preset to 20.00 °C.

values: -50 to 150

P662 TEMPERATURE SENSOR ALLOCATION

As preset, TS-3 # 1-10 are allocated to Point Numbers 1-10 respectively.

To alter this allocation, enter the TS-3 # whose temperature measurement will be used for the distance calculation of the Point Number displayed.

When more than one TS-3 temperature sensor is allocated to a Point Number, the temperature measurements from each sensor are averaged for that vessel.

values: x (x = single Point Number (1-10) to be allocated to the TS-3 # displayed)
 x.y (x = first Point Number (1-10), y = last Point Number (1-10), in the range).

P663 TEMPERATURE TRANSDUCER ALLOCATION

As preset, Ultrasonic/Temperature Transducers 1-10 are allocated to Point Number 1-10 respectively.

To alter this allocation, enter the Transducer # whose temperature measurement will be used for the distance calculation of the Point Number displayed.

When more than one transducer is allocated to a Point Number, the temperature measurements from each transducer are averaged for that vessel.

values: x (x = single Point Number (1-10) allocated to the Transducer # displayed)
 x.y (x = first Point Number (1-10), y = last Point Number (1-10), in the range).

P664 (V) TEMPERATURE

View the current vessel atmosphere temperature in °C.

This is the value displayed when  is pressed in the RUN mode.

If Temp Source (P660) is set to any value other than Fixed Temp, the value displayed is the temperature measured. If Temp Source is set to Fixed Temp, the P661 value is displayed.

values: -50 to 150

Rate Parameters (P700 to P707)

P700 MAX FILL RATE

Adjust the SITRANS LU10 response to increases in the actual material level (or advance to a higher Failsafe Material Level, P071).

Enter a value slightly greater than the maximum vessel filling rate.

This value (in Units (P005) or % of Span (P007) per minute) is automatically altered when Measurement Response (P003) is altered. See *Technical Reference* Measurement Response.

values: 0.000 to 9999

P701 MAX EMPTY RATE

Adjust the SITRANS LU10 response to decreases in the actual material level (or advance to a lower Failsafe Material Level, P071).

Enter a value slightly greater than the maximum vessel emptying rate.

This value (in Units (P005) or % of Span (P007) per minute) is automatically altered when Measurement Response (P003) is altered. See *Technical Reference* Measurement Response.

values: 0.000 to 9999

P702 FILLING INDICATOR

Enter the fill rate to activate the LCD Material Filling indicator and Smart Scan (P720).

This value (in Units (P005) or % of Span (P007) per minute) is automatically set to 10% of the Max Fill Rate (P700).

values: -999 to 9999

P703 EMPTYING INDICATOR

Enter the empty rate to activate the LCD Material Emptying indicator and Smart Scan (P720).

This value (in Units (P005) or % of Span (P007) per minute) is automatically set to 10% of the Max Empty Rate (P701).

values: -999 to 9999

P704 RATE FILTER

Use this feature to avoid Rate Value (P707) fluctuations due to a "splashing" material surface. This value is automatically altered when Measurement Response (P003) is altered. See *Technical Reference* Measurement Response.

This value automatically alters the Rate Update Time (P705) and / or Rate Update Distance (P706). Alternatively, these parameter values may be altered independently.

Enter the time period/distance the Rate Value is averaged before display update.

- values: 0 = rate display not required
- 1 = continuously averaged and updated
- 2 = 1 minute or 50 mm (2 in)
- 3 = 5 minutes or 100 mm (3.9 in)
- 4 = 10 minutes or 300 mm (11.8 in)
- 5 = 10 minutes or 1000 mm (39.4 in)

P705 RATE UPDATE TIME

Enter the time period (in seconds) over which the material level rate of change is averaged before Rate Value update.

values: 0.000 to 9999

P706 RATE UPDATE DISTANCE

Enter the material level change (in meters) to initiate a Rate Value update.

values: 0.000 to 9999

P707 (V) RATE VALUE

View the rate of material level change (in Units (P005) or % of Span (P007) per minute).

(A negative rate indicates the vessel is emptying).

This is the value displayed when  is pressed in the RUN mode.

values: 0.000 to 9999

Measurement Verification Parameters (P710 to P713)

P710 FUZZ FILTER

Use this feature to stabilize the reported material level, due to material level fluctuations (such as a rippling or splashing liquid surface), within the Echo Lock Window (P713).

This value (in % of Span, P007) is automatically altered when Measurement Response (P003) is altered. (See *Technical Reference* Measurement Response).

The higher the value entered, the greater the fluctuation stabilized. (0 = off)

values: 0 to 100

P711 ECHO LOCK

Use this feature to select the measurement verification process.

This value is automatically altered when Material (P002) and / or Measurement Response (P003) is altered. (See Measurement Response).

When set for "maximum verification" or "material agitator", a new measurement outside of the Echo Lock Window (P713), must meet the sampling criterion (P712).

For "total lock", Echo Lock Window (P713) is preset to "0". The SITRANS LU10 continuously searches for the best echo according to the algorithm chosen (P820). If the selected echo is within the window, the window is then centered about the echo. If not, the window widens with each successive shot until the selected echo is within the window. The window then returns to its normal width.

When Echo Lock is "off", the SITRANS LU10 responds immediately to a new measurement as restricted by the Max Fill / Empty Rate (P700 / P701); however, measurement reliability is affected.

values: 0 = off

1 = maximum verification

2 = material agitator

3 = total lock

P712 ECHO LOCK SAMPLING

The sampling criterion sets the number of consecutive echoes appearing above or below the echo currently locked onto, that must occur before the measurements are validated as the new reading (for Echo Lock P711 values 1 or 2).

P711 value	P712 preset value
1, max verification	5:5
2, material agitator	5:2

e.g. P711 = 2, material agitator
P712 = 5:2

A new reading will not be validated unless 5 consecutive measurements higher or 2 consecutive measurements lower than the current readings occur.

values:x.y x= # of 'above' echoes y = # of 'below' echoes

Resetting P711 returns P712 to the respective preset values.

P713 ECHO LOCK WINDOW

Use this feature to adjust the new measurement change permitted before Echo Lock is applied.

The Echo Lock Window is a "time window" (in msec) placed about the echo used to derive the Reading. When a new measurement falls within the window, the window is recentered and the new Reading is calculated. Otherwise, the new measurement is verified by Echo Lock (P711) before the SITRANS LU10 updates the Reading.

When "0" is entered (preset), the window is automatically calculated based on the Max Fill / Empty Rate (P700 / 701). This calculation is automatically performed when Measurement Response (P003) is altered. See Measurement Response.

For slower Measurement Response (P003) values the calculated Echo Lock Window is narrow. For faster values the window becomes increasingly wider, (When "TURBO" is selected the window is normally wide open).

values: 0.000 to 9999

Scanning Parameters (P720, P725 to P729)

P720 SMART SCAN

Select the condition(s) to add / remove the Point Number displayed to the Priority Point scan sequence (as indicated by the display symbol in the RUN mode).

In the RUN mode, if any of the conditions occur, Priority Point(s) are scanned each time a non-priority point is scanned. Otherwise, all vessels are scanned in numerical sequence.

Selecting "manual" allows the addition or removal of Priority Points by the following methods:

- pressing  on the local keypad
- sending an MT12 / MT13 message via the BIC-II (see *Technical Reference*)
- sending the appropriate message via compatible industry bus

values: 0 = off (numerical sequence only) (preset)

1 = manual

2 = Filling Indicator (P702) value exceeded

3 = Emptying Indicator (P703) value exceeded

4 = Filling / Emptying Indicator value exceeded

5 = Filling Indicator or Failsafe Timer (P070) exceeded

6 = Emptying Indicator or Failsafe Timer (P070) exceeded

7 = Filling / Emptying Indicator or Failsafe Timer exceeded

8 = Failsafe Timer exceeded

P725 AUXILIARY TRANSDUCER

Use this feature if a long range transducer measurement range, but a short range transducer Nearest Distance (see Installation Transducer Mounting) is required. In the RUN mode, if the material level is within the short range transducer measurement range, that measurement is processed. Otherwise, the long range transducer measurement is used.

With the long range transducer Point Number displayed, enter the short range Point Number.

values: 0 to 10 (0 = off, preset)

P726 LEVEL SYSTEM SYNC

Use this feature if another level measurement system is mounted near the SITRANS LU10.

See *Installation* Interconnection-Level System Synchronization.

values: 0 = not required

1 = synchronize level monitors (preset)

P727 (G) SCAN DELAY

Use this feature to adjust the delay before the next point is scanned. Enter the amount of delay in seconds. This value is automatically altered when Measurement Response (P003) is altered. (See *Technical Reference* Measurement Response).

values: 0.000 to 60.00

P728 SHOT DELAY

Use this feature if acoustic noise within the vessel is causing measurement difficulties. Enter the delay between transmit pulse shots (in seconds). This value is automatically altered when Measurement Response (P003) is altered. See *Technical Reference* Measurement Response.

values: 0.1 to 4.0

P729 (V) SCAN TIME

View the time elapsed (in seconds) since the point displayed was last scanned. This value may be viewed as an Auxilliary Reading in the Run mode (especially useful when setting up Smart Scan, P720). See *Operation* Keypad.

values: 0.000 to 9999

Display Parameters (P730 to P734, P740)





P730 (G) AUXILIARY READING

Use this feature to display operator selected Auxiliary Readings temporarily.

Select "OFF" to display Auxiliary Readings temporarily. Select "HOLD" to display Auxiliary Readings until another Auxiliary Reading is selected.

(See *Operation Keypad* for RUN mode Auxiliary Reading selection.)

To select the Auxiliary Reading operation desired:

1. Press  to display the Auxiliary Function symbol.
2. Press  or  to display the "OFF" or "HOLD" (preset) option as desired.
3. Press .

If desired, also enter the Parameter Number to default in the Auxiliary Reading display.

values: 000 to 999

P731 (G) AUXILIARY READING KEY

Use this feature to enable a specific Parameter Value to be monitored in the RUN mode.

Enter the Parameter Number whose value is to be displayed in the Auxiliary Reading field when is pressed in the RUN mode.

(See *Operation Keypad* for RUN mode Auxiliary Reading selection.)

values: 000 to 999 (preset to (P921) Material Reading)

P732 (G) DISPLAY DELAY

Use this feature if the Point Number display scrolls too quickly in the RUN mode.

Enter the delay (in seconds) before the display advances to the next Point Number.

(Point Number display scrolling is independent from transducer scanning.)

values: 0.5 to 10 (preset to 1.5 seconds)

P733 (G) SCROLL ACCESS

Use this feature to select the programming mode parameter scroll access option desired.

Select: "off" to scroll access all operator accessible parameters (P000 to P999).

"smart" to scroll access Quick Start, previously altered, and tagged parameters.

"tagged" to scroll access operator tagged parameters only.

If SmartLinx module is installed, the applicable protocol specific parameters (P750 - P789) are preset as tagged.

(Any accessed parameter may be *tagged* or *untagged* by pressing  .

 is displayed when a previously tagged or altered parameter is accessed.

values: 0 = off
1 = smart (preset)
2 = tagged

P734 (G) SCANNING INDICATORS

Use this feature to have the Scan Point indicators display the Point Numbers currently "on priority" (see SMART SCAN, P720). As preset, the Point Number being scanned is displayed.

values: 1 = Point Number being scanned
2 = Point Numbers on priority

P740 PERIPHERAL COMMUNICATIONS

Use this feature to select the ASCII message format used in Siemens Milltronics proprietary communications loop.

Select: "off" if peripherals are not used (increases the SITRANS LU10 processing speed).

"normal" to have messages transmitted in a continuous string of characters (requires less SITRANS LU10 processing time than formatted messages).

"formatted" to have commas inserted between the message fields (for easier message recognition e.g. when viewed on a monitor).

Refer to Technical Reference BIC-II Support if a BIC-II is used.

values: 0 = off
1 = normal (preset)
2 = formatted messages

SmartLinx Parameters

P750 - P789 PROTOCOL SPECIFIC PARAMETERS

These parameters are specific to the SmartLinx module installed. Refer to the module documentation for a list and description of the specific parameter requirements.

P772 BAUD RATE

This feature specifies the rate of communication in Kbaud. Any value can be entered, but only the values shown are supported.

4.8 = 4800 Baud (preset)

9.6 = 9600 Baud

19.2 = 19200 Baud

38.4 = 38400 Baud

P790 HARDWARE ERROR

Use this feature to display the results of ongoing hardware tests within the communications circuitry. If any test does not meet the PASS requirements, communication halts and tests are repeated until PASS requirements are met. Communication then resumes.

Displays:

PASS: no problem

FAIL: faulty SmartLinx module or SITRANS LU10

ERR1: unknown protocol, upgrade SITRANS LU10 software

P791 BUS ERROR

This feature indicates if an error condition is occurring on the bus.

Displays: 0 = no error

= error code, refer to the SmartLinx module documentation for explanation of the error code

P792 BUS ERROR COUNT

This register increments by 1 each time a bus error (P752) is reported. The register is factory set at 0 and can be preset to any value. The register is reset to 0 by master reset (P999).

Echo Processing Parameters (P800 to P807)

P800 NEAR BLANKING

Use this feature if the material level is incorrectly reported to be near the transducer face.

The *Near Blanking distance* (distance from the transducer face which is not ultrasonically measurable) is preset to a value depending on the transducer selected (P004).

blanking	transducer
0.3 m (1 ft)	ST-25, ST-50, ST-H, XPS-10, XPS-15
0.45 m (1.5 ft)	XCT-8, XCT-12
0.6 m (2 ft)	XPS-30
0.9 m (3 ft)	ST-100, LR-21, XPS-40, XLS-30, XLT-30
1.2 m (4 ft)	LR-13, XLS-60, XLT-60

Extend Near Blanking to overcome measurement difficulties which cannot be corrected by transducer location, mounting, or aiming.

The causes of measurement difficulties which may be corrected include:

- a vessel obstruction partly blocking the transducer acoustic beam.
- a transducer standpipe mount that is too narrow for its length.
- a transducer mounting which is resonant at the transducer frequency.

Extend Near Blanking to 150 mm (6 in) beyond the incorrect distance measured.

Ensure the Near Blanking distance is less than Empty (P006) - Span (P007).

To reset the automatic Near Blanking value

Press  .

values: 0.000 to 9999

P801 RANGE EXTENSION

Use this feature if an incorrect level is reported (when material level is lower than Empty, P006).

Range Extension is the distance in Units (P005) or % of Span (P007) beyond Empty, which is still ultrasonically measurable.

If Empty is substantially higher than the actual vessel bottom, increase Range Extension such that Empty plus Range Extension is greater than the transducer to vessel bottom distance.

This value is automatically preset to 20% of Span (P007).

values: 0.000 to 9999

P802 SUBMERGENCE SHIELD ON TRANSDUCER

Use this feature (if desired) when the transducer connected is equipped with a submergence shield.

When the transducer is submerged, the SITRANS LU10 detects that the monitored surface is within the Near Blanking (P800) distance, and immediately advances to "zero" distance operating displays and outputs accordingly.

values: 0 = off (preset)
1 = submergence transducer

P803 SHOT / PULSE MODE

Use this feature to increase response independent from Measurement Response (P003).

Select "short and long" to have short and long acoustic shots fired each time a vessel is scanned. Select "short" to have only short shots fired if the Echo Confidence (P805) produced by a short shot exceeds the short Confidence Threshold (P804).

This value is automatically altered when Measurement Response (P003) is altered. See *Technical Reference* Measurement Response.

values: 1 = short
2 = short and long

P804 CONFIDENCE THRESHOLD

Use this feature when an incorrect material level is reported.

The short and long Confidence Thresholds are preset to 10 and 5 respectively. If the Echo Confidence (P805) of a particular echo exceeds the Confidence Threshold, that echo is considered for evaluation by Sonic Intelligence®.

values: x.y x = short (0 to 99), y = long (0 to 99)

P805 (V) ECHO CONFIDENCE

Use this feature to monitor the effect of transducer aiming, location, and mechanical transducer / mounting isolation.

This is the value displayed when  is pressed for 4 seconds in the RUN mode.

Both short and long shot Echo Confidence is displayed.

"--" is displayed if the respective shot (short or long) was not included in the evaluation.

"E" is displayed if the transducer cable is open or short circuited.

"--:--" is displayed if no shots have been taken yet.

values: x:y x = short (0 to 99), y = long (0 to 99)

P806 (V) ECHO STRENGTH

Use this feature to view the strength (in dB above 1 μ V RMS) of the echo selected to base the distance calculation upon.

values: 0 to 99

P807 (V) NOISE

Observe the average and peak ambient noise (in dB above 1 μ V RMS) being processed.

The noise level is a combination of transient acoustic noise and electrical noise (induced into the transducer cable or receiving circuitry itself).

values: x:y x = average (-99 to 99), y = peak (-99 to 99)

Advanced Echo Processing (P810,P816-P825,P830-P835,P840-P845,P850-P852)

The following Echo Processing parameters are intended for use by authorized Siemens Milltronics Service personnel or Industrial Instrumentation Technicians familiar with Siemens Milltronics ultrasonic echo processing techniques.

P810 SCOPE DISPLAYS

Use this feature to monitor the results of Echo Processing parameter alterations.

Connect an oscilloscope to Display Board TP1, TP2, and TP3.

Sweep = 10 μ V/div. to 1 ms/div. (x 100 for real time); Amplitude = 1 V/div.; Trigger = external

Observe any combination of the following Scope Displays:

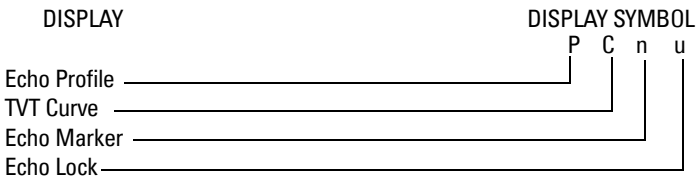

To select the Scope Display desired perform the following steps:

Press to display the Auxiliary Function symbol.

Press or to scroll access the desired Reading display symbols.

Press with the desired display symbols displayed.

Alternatively, a 4 digit binary value may be entered, where a "0" turns the associated signal display "off", and a "1" turns the associated display "on".

e.g. 1110 = PCn_ = Echo Profile, TVT Curve, and Echo Marker displays on.

See Technical Reference Echo Processing for Scope Display illustrations.

Use the Scope Displays after pressing (in the CAL mode) to observe the result of Echo Processing parameter alterations. (Take several measurements to verify measurement repeatability and overcome Echo Lock (P711) restrictions).

As preset, all displays are off.

P816 (V) ECHO TIME

Observe the time (in ms) between the transmit pulse and the processed echo.



values: 0.000 to 9999

PROFILE POINTER PARAMETERS

When a Profile Pointer Parameter is accessed, the Echo Lock Window scope display changes to a Profile Pointer display. The Profile Pointer may be moved to a number of points on the Echo Profile, to gain specific information dependent upon the Profile Pointer Parameter used.

To move the Profile Pointer to a specific point, enter the desired value. The Profile Pointer will move to the nearest acceptable Echo Profile point. The Profile Pointer is preset to "0".

Alternatively, to scroll the Profile Pointer along the Echo Profile

1. Press  to display the Auxiliary Function symbol.
2.  or  to move the Profile Pointer to the left or right respectively.

When the Profile Pointer Parameters are exited and  is pressed or the RUN mode is entered, the Profile Pointer display automatically changes back to the Echo Lock Window display.

P817 (V) PROFILE POINTER TIME

Observe the time (in ms) between the transmit pulse and the Profile Pointer.

values: 0.000 to 9999

P818 (V) PROFILE POINTER DISTANCE

Observe the distance (in P005 Units) between the transducer face and the Profile Pointer.

values: 0.000 to 9999

P819 (V) PROFILE POINTER AMPLITUDE

Observe the amplitude (in dB above 1 μ V) of the Echo Profile at the Profile Pointer position.

values: 0 to 99





P820 ALGORITHM

Use this feature to select the *Algorithm(s)*(mathematical operations) which the Sonic Intelligence® echo selection is to be based on.

This value is automatically altered by Material (P002).

If the wrong echo is processed, select an alternate algorithm, while observing the resultant echo processing displays.

To select an Algorithm perform the following steps:

1. Press  to display the Auxiliary Function symbol.
2. Press  or  to display the desired Reading display symbol(s).
3. Press  (when the desired Algorithm is displayed).

The material / vessel type most likely to benefit from a particular algorithm is included with the following option values.

- values:
- ALF = long range Area, Largest, and First average (general purpose, solids)
 - A = long range Area only (coarse, heaped solids)
 - L = long range Largest only (liquids, open vessels)
 - F = long range First only (liquids, closed vessel)
 - AL = long range Area and Largest average (fine heaped solids)
 - AF = long range Area and First average (coarse flat solids)
 - LF = long range Largest and First average (general purpose, liquids)
 - bLF = short range Largest or First (general purpose)
 - bL = short range Largest only (solids and open vessel liquids)
 - bF = short range First only (closed vessel liquids)

P821 SPIKE FILTER

Activate the Spike Filter if interference spikes are observed on the long shot Echo Profile display.

- values: 0 = off
1 = on (preset)

P822 NARROW ECHO FILTER

Use this feature (when monitoring solids (P002 = 2) only) if an echo from a partial transducer beam obstruction (seams, ladder rungs, etc.) is processed.

Enter the width of false echoes (in ms) to be removed from the long shot Echo Profile.

When a value is keyed in, the nearest acceptable value is entered.

- values: 0 = off (preset), greater = wider

P823 REFORM ECHO

Use this feature if the reported material level fluctuates slightly though the material surface is still (when monitoring solid Material (P002 = 2) only).

Enter the amount (in ms) of long shot Echo Profile smoothing required to eliminate jagged peaks in the Echo Profile.

When a value is keyed in, the nearest acceptable value is entered.

values: 0 = off (preset), greater = wider

P825 ECHO MARKER TRIGGER

Use this feature when the reported material level fluctuates slightly, due to a variable rise in the leading edge of the true echo on the Echo Profile.

Enter the value (in percent of echo height) to ensure the Echo Lock Window intersects the Echo Profile at the sharpest rising portion of the Echo Profile representing the true echo. This value is preset to 90% when P002=1 Liquid or 50% when P002=2 Solid.

values: 5 to 95

P830 TVT TYPE

Use this feature to select the TVT Curve most suited to the material and vessel.

This feature is automatically altered when Material (P002) is altered.

Do not select "TVT Slopes" when the "bF" or "bLF" Algorithm (P820) is selected.

values: 1 = TVT Short Curved
2 = TVT Short Flat
3 = TVT Long Flat
4 = TVT Long Smooth Front
5 = TVT Long Smooth
6 = TVT Slopes (see TVT Slope Min, P835)

P831 TVT SHAPER

Use this feature to turn the TVT Shaper "on" or "off".

Turn the TVT Shaper "on" before altering TVT Shaper Adjust. After TVT Shaper Adjust has been used to modify the TVT Curve (to avoid a false echo or pick up the true echo), this feature allows the TVT Shaper to be turned "on" and "off" while monitoring the effect.

values: 0 = off
1 = on

P832 TVT SHAPER ADJUST

Use this feature to bias the shape of the TVT curve, in order to avoid it crossing false echoes from fixed objects.

Adjustment to this parameter is best done while viewing the echo profile on an oscilloscope (refer to P810). When using an oscilloscope, the Echo Lock Window display becomes the TVT Curve Pointer.

The TVT curve is divided into 40 breakpoints, accessible by enabling the point number as the breakpoint index field. Each breakpoint is normalized to a value of 0, as displayed in the parameter value field. By changing the breakpoint value, up or down, the intensity of the bias applied to that breakpoint of the curve is respectively changed. By changing the value of adjacent breakpoints, the effective bias to the shaper can be broadened to suit the desired correction. In the case of multiple false echoes, shaping can be applied along different points of the curve. Shaping should be applied sparingly in order to avoid missing the true echo.

To change a breakpoint ...
with the desired transducer point selected



e.g. transducer 1

Press to set the point number to index.



e.g. index, breakpoint 1, value 0

Press to select the Auxiliary function



auxiliary function

Press to scroll the breakpoint index through points 1 to 40, and move the curve pointer left or right respectively.

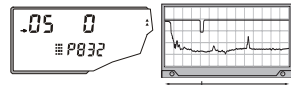

e.g. oscilloscope displays breakpoint 5, value 0

Press to change the bias value of the breakpoint, -50 to 50



e.g. breakpoint 5, value 14

Press to enter the change in value.



To select another transducer

Press to set the point number to transducer. Select desired transducer point.



e.g. return to transducer 1

P831, TVT shaper, must be ' on '.

P833 TVT START MIN

Use this feature to adjust the TVT Curve height to ignore false echoes (or pick up true echoes) near the start of the Echo Profile.

Enter the minimum TVT Curve start point (in dB above 1 μ V RMS).

This feature (preset to 45) should only be used if increased Near Blanking would extend farther than desired into the measurement range.

values: -30 to 225

P834 TVT START DURATION

Use this feature in conjunction with TVT Start Min (P833) to ignore false echoes (or pick up true echoes) near the start of the Echo Profile.

Enter the time (in ms) for the TVT Curve to decrease from the TVT Start Min (P833) point to the TVT Curve baseline.

values: 0 to 9999

P835 TVT SLOPE MIN

Enter the minimum slope (in dB / s) for the middle portion of the TVT Curve.

This feature (preset to 200) is used in conjunction with Minimum TVT Start Slope (when a long flat TVT Type is selected) to ensure the TVT Curve remains above false echoes which appear in the middle of the Echo Profile.

Alternatively, if TVT Type is set for "TVT Slopes" (P830 = 6), this value is preset to 2000. Use this feature to adjust the slope declination, as required.

values: 0 to 9999

P840 SHORT SHOT NUMBER

Enter the number of short shots to be fired (and results averaged) per transmit pulse.

values: 0 to 100

P841 LONG SHOT NUMBER

Enter the number of long shots to be fired (and results averaged) per transmit pulse.

This value is automatically altered when Measurement Response (P003) is altered. (See *Technical Reference* Measurement Response).

values: 0 to 200

- P842 SHORT SHOT FREQUENCY**
Use this feature to adjust the short shot transmit pulse frequency (in kHz).
This feature is automatically altered when Transducer (P004) is altered.
values: 10.00 to 60.00
- P843 LONG SHOT FREQUENCY**
Use this feature to adjust the long shot transmit pulse frequency (in kHz).
This feature is automatically altered when Transducer (P004) is altered.
values: 10.00 to 60.00
- P844 SHORT SHOT WIDTH**
Use this feature to adjust the width (in ms) of the short shot transmit pulse.
This feature is automatically altered when Transducer (P004) is altered.
values: 0.000 to 5.000
- P845 LONG SHOT WIDTH**
Use this feature to adjust the width (in ms) of the long shot transmit pulse.
This feature is automatically altered when Transducer (P004) is altered.
values: 0.000 to 5.000
- P850 SHORT SHOT BIAS**
Use this feature to slant the echo evaluation in favour of the short shot echo when both short and long shots are evaluated (see Shot Mode, P803). This feature is preset to 20.
values: 0 to 100
- P851 SHORT SHOT FLOOR**
Enter the minimum echo strength (in dB above 1 μ V), derived from a short shot, to be considered for evaluation. This feature is preset to 50.
values: 0 to 100
- P852 SHORT SHOT RANGE**
Enter the maximum distance in Units (P005) to be measured using short shot echoes.
This feature is automatically altered when Transducer (P004) is altered.
values: 0.000 to 9999

Test Parameters (P900 to P913)

Test Parameters are intended for use by Siemens Milltronics Service personnel.

P900 (V) SOFTWARE REV.

Access this parameter to determine the EPROM Rev. # without removing the enclosure lid.

values: 00.00 to 99.99

P901 (V) MEMORY

Press  to activate the SITRANS LU10 memory test.

When the test is successful, "PASS" is displayed. Otherwise, one of the following values is displayed, indicating the type of memory failure.

values: PASS = memory test successful
 F1 = RAM
 F2 = NOVDRAM
 F3 = EEPROM
 F4 = EPROM

P902 (V) WATCHDOG

Press  to reset the microprocessor.

On successful completion (in about 10 seconds) the SITRANS LU10 enters the RUN mode.

P903 (V) DISPLAY

Press  to activate the display test.

All LCD segments and symbols are temporarily displayed.

P904 (G) KEYPAD

Press each keypad key in the following sequence:



As each key is pressed, the associated keypad number is displayed. On successful test completion "PASS" is displayed. "FAIL" is displayed if a key is pressed out of sequence or the programmer keypad malfunctions.

P905 TRANSMIT PULSE

Press  to supply repeated transmit pulses to the transducer and / or view the transducer operating frequency (automatically altered by (P004) Transducer) for the Point Number displayed.

This feature may be used to monitor the transmit pulse with an oscilloscope connected to the transducer terminals.

values: 10.00 to 60.00

P906 COMMUNICATIONS

Press  to test the Siemens Milltronics proprietary communications circuit.

Before activating this feature, connect terminal block contacts 42 to 45 and 43 to 46.

On successful test completion, "PASS" is displayed. If "FAIL" is displayed, repeat the test. (The first test performed sets up the auto polarity function).

P907 PROGRAMMER INTERFACE

Press  to activate the programmer interface (two way infrared communications) test.

On successful test completion, "PASS" is displayed. Otherwise, "FAIL" is displayed.

P908 SCANNER

Press  to activate the scanner test.

When activated, the on board transducer scanning relays energize and de-energize in sequence.

(The transmit pulse is not supplied to the transducer terminals during this test).

P910 RELAY

Access this parameter to display the current state of the specified LU SAM relay.

Press  to alter the relay state (energized / de-energized) or enter the value corresponding to the specific relay state desired.

values: 0 = de-energized
1 = energized

P911 mA OUTPUT VALUE

Access this parameter to display the current value of the specified LU AO mA output.

Additionally, this feature may be used to enter a desired value. The mA output is immediately forced to the value entered regardless of any restrictions programmed.

values: 0.000 to 25.00

P912 TRANSDUCER TEMPERATURE

Access this parameter to display the vessel temperature in °C (as monitored by the connected temperature sensing transducer). "Err" is displayed if the transducer is not equipped with an integral temperature sensor.

values: -50 to 150

P913 SENSOR TEMPERATURE

Access this parameter to display the vessel temperature in °C (as monitored by the connected temperature sensor). "OPEn" is displayed if a TS-3 is not connected.

values: -50 to 150

Measurement Parameters (P920 to P923)

Use these parameters to verify Application Parameter programming, when performing a dynamic material level test over at least 2 empty / fill cycles for each vessel is impractical.

Access the following parameters to take an ultrasonic measurement and:

- display the corresponding Reading in the Parameter Value field.
- set the LU SAM (if used) relay status accordingly.
- set the LU AO (if used) mA output value accordingly.
- transmit the corresponding point data to the BIC-II (if used).

If measurements or simulation are desired but the SITRANS LU10 operation has not been verified, disable all associated process control equipment before accessing the following parameters.

To take an ultrasonic measurement, access one of the following parameters and perform the following steps.

Press  (repeat 5 times to overcome Echo Lock, P711).

Alternatively, press  to simulate a rising and falling material level. During the simulation, the system operates as though the material level was repeatedly cycling from full to empty to full, and so on, at a rate of 1% of Span (P007) per second.

The simulation starts at level = 0, unless a specific level value was entered before hand.

Press  to switch to the rising (or  for the emptying) simulation as required.

Holding the key increases (or decreases) the simulated rate of rise (or fall), to 4% of Span per second.

Press  to end the simulation, when desired.

During a measurement or simulation, the SITRANS LU10 display responds as though in the RUN mode, however the value displayed in the Reading field is affected by the Measurement Parameter selected, and the material level is displayed in the Auxiliary Reading field.

P920 READING MEASUREMENT

The Reading corresponds to all associated programming.

P921 MATERIAL MEASUREMENT

The Reading corresponds to the distance between Empty (P006) and the material level.

P922 SPACE MEASUREMENT

The Reading corresponds to the distance between the material level and Span (P007).

P923 DISTANCE MEASUREMENT

The Reading corresponds to the distance between the material level and the transducer face.

P924 VOLUME MEASUREMENT

The Reading corresponds to the volume calculation in percent of Max Volume (P051).

Press  to display in Max Volume units.

P927 DISTANCE PERCENT

same as P923, plus alternate reading in % press  .

P990 PARAMETER COPY

Use this feature to copy the parameter set from another point.

Enter the point number to copy from.

To copy a parameter set with the desired transducer point selected:

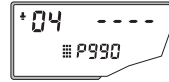

e.g. point 4

Enter the point to copy from.

Press 



e.g. copy from point 1

Press 

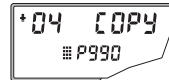

copying

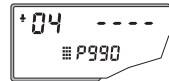

copy complete

Master Reset (P999)

P999 MASTER RESET

A *Global Master Reset* (reset all parameters to original values) should be performed:



- prior to initial programming if arbitrary Parameter Values were used during a "bench test".
- after replacing the SITRANS LU10 EPROM with a different software revision number.

When performing a Master Reset, the bar graph will indicate progress from 0 to 100%.



Following a Global Master Reset, complete reprogramming is required.

A *Point Number Master Reset* (reset the non-global parameters of the displayed Point Number to preset values) should be performed if a Point Number is being reassigned to a different vessel.

To perform a Global Master Reset:

1. With the Parameter Number field accessed, key in 999.
2. With the Point Number field accessed, key in 00.
3. Press   , "C.ALL" is displayed until the reset is complete.

To perform a Point Number Master Reset:

1. With the Parameter Number field accessed, key in 999.
2. With the Point Number field accessed, key in the Point Number to be reset (1 - 10).
3. Press   , "C.ALL" is displayed until the reset is complete.

P999 is not accessible via SmartLinX Interface.

Technical Reference

Transmit Pulse

The SITRANS LU10 transmit pulse consists of one or more electrical "shot" pulses, which are supplied to the scanning relays. The scanning relays are activated as required, to supply the transmit pulse to the appropriate transducer connected to the SITRANS LU10 terminals.

The transducer fires an acoustic "shot" for each electrical pulse supplied. After each shot is fired, sufficient time is provided for *echo* (shot reflection) reception, before the next (if applicable) shot is fired. After all shots of the transmit pulse are fired, the resultant echoes are processed.

The transmit pulse shot number, frequency, duration, delay, and associated measurement range are defined by parameters P803 and P840 to P852.

Echo Processing

Echo processing consists of echo enhancement, true echo selection, and selected echo verification.

Echo Enhancement is achieved by *filtering* (removing noise, P821 and P822) and *reforming* (connecting fragmented echo peaks, P823) the *echo profile* (digitized signal representing the echo signal received).

True echo selection is achieved by establishing the criteria which a portion of the echo profile must meet to be considered the *true echo* (echo reflected by the intended target).

Insignificant portions of the echo profile outside of the measurement range (Empty Distance P006 + Range Extension P801), below the TVT Curve (P830 to P835), and less than the Confidence Threshold (P804) and Short Shot Floor (P851) are automatically disregarded.

The remaining portions of the Echo Profile are evaluated using the Algorithm(s) (P820) and Short Shot Bias (P850) programmed. When a combination of Algorithms are used, the portion of the Echo Profile providing the best averaged Echo Confidence (P805), is selected as the true echo.

True echo verification is automatically achieved by comparing the position (relation in time after transmit) of the "new" echo to the previously accepted echo position.

If the new echo is within the Echo Lock Window (P713), the new echo is accepted and displayed, and LU SAM relays and LU AO mA outputs are updated as restricted by the Fuzz Filter (P710) and Rate Parameters (P700 to P703). If the new echo is outside of the Echo Lock Window, the new echo is not accepted until *Echo Lock* (measurement repeatability, P711) requirements are satisfied.

ECHO PROCESSING DISPLAYS (Scope Displays, P810)

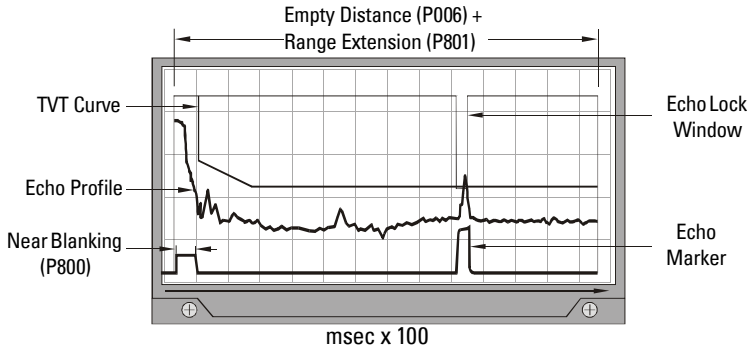

Distance Calculation

To calculate the "round trip" transducer to material level (object) distance, the *transmission medium* (atmosphere) sound velocity (P653) is multiplied by the acoustic transmission to reception time period. This result is divided by 2 to calculate the "one way" distance.

$$\text{Distance} = \frac{\text{Sound Velocity} \times \text{Time}}{2}$$

The Reading Value displayed is the result of performing any additional modification to the calculated distance (Operation P001, Units P-005, Volume Conversion, P050 to P054, Reading Value, P060 to P063.)

Sound Velocity

The sound velocity of the transmission medium is affected by the type, temperature, and vapour pressure of the gas or vapour present. As preset, the SITRANS LU10 assumes the vessel atmosphere is air at 20°C (68°F). Unless altered, the sound velocity used for the distance calculation is 344.1 m/s (1129 ft/s).

Variable air temperature is automatically compensated when a Siemens Milltronics ultrasonic / temperature transducer is used. If the transducer(s) are exposed to direct sunlight, TS-3 temperature sensor(s) should be used.

Also, if the temperature varies between the transducer face and the object monitored, a TS-3 temperature sensor, mounted near the material surface (solids) or submerged (liquids), should be used in combination with the ultrasonic/temperature transducer. Then when Temp Source, (P660) is set for "both", the transducer and TS-3 temperature measurements are averaged.

If the air temperature within all vessels is identical, a single TS-3 temperature sensor may be used to represent the temperature of all vessels if Temp Source (P660) is set to Temp Sensor # 1.

Atmosphere composition other than air can pose a challenge for ultrasonic level measurement. However, excellent results may be obtained if the atmosphere is

homogeneous (well mixed), at a fixed temperature, and consistent vapour pressure, by performing a Sound Velocity Calibration (P651).

The SITRANS LU10 automatic temperature compensation is based on the sound velocity / temperature characteristics of air and may not be suitable for other atmospheres. If the atmosphere temperature is variable, frequent Sound Velocity Calibrations may be required to maintain optimum measurement accuracy.

Sound Velocity calibration frequency may be determined with experience. If the sound velocity in several vessels is always similar, future calibrations may be performed on one of the vessels and the resultant Velocity (P653) entered directly for the other vessels.

If the sound velocity of a vessel atmosphere is found to be repeatable at specific temperatures, a chart or curve may be developed. Then, rather than performing a Sound Velocity Calibration each time the vessel temperature changes significantly, the anticipated Velocity (P653) may be entered directly.

Scanning

When echo processing is complete, (if more than one vessel is monitored) the scanning relay changes state to supply the transmit pulse to the next transducer to be scanned, after the Scan Delay (P727).

Scan Delay is automatically set by Measurement Response (P003). When high speed scanning is required (sometimes the case for equipment position monitoring), the Scan Delay may be reduced. Reduce the Scan Delay only as required, otherwise premature scanning relay fatigue could occur.

All vessels are scanned sequentially unless a Point Number is "on priority" (see Smart Scan, P720). If #1 of four vessels is on priority, the scanning sequence is 1,2,1,3,1,4,1,2,1,3,1,4 and so on.

Volume Calculation

The SITRANS LU10 provides a variety of volume calculation features (P050 to P055).

If the vessel to be monitored does not match any of the eight preset Tank Shape calculations, a Universal Volume calculation may be used. Use the level / volume graph or chart provided by the vessel fabricator (or create one based on the vessel dimensions).

From this graph, determine which Universal Volume calculation will provide the best results, and select the level vs volume breakpoints to be entered (32 max.). Generally, the more breakpoints entered, the greater the volume calculation accuracy.

Universal, Linear (P050 = 9)

This volume calculation creates a piece-wise linear approximation of the level / volume curve. This option provides best results if the curve has sharp angles joining relatively linear sections.



Enter a Level Breakpoint at each point (or minimum).

For combination curves (mostly), breakpoints are entered along the curve.

Universal, Curved

This volume calculation uses a curved approximation of the level / volume curve. This option is used for smooth curves.

- one breakpoint very near the minimum level
- one breakpoint at the tangent points of each arc
- one breakpoint at each arc apex
- two breakpoints very near the maximum level

For combination curves, ensure at least two breakpoints are entered immediately before and after any sharp angle (as well as one breakpoint exactly at the angle) on the curve.

Measurement Response

The SITRANS LU10 Measurement Response (P003) to material level change is designed to exceed the most demanding installation requirements.

The Measurement Response setting automatically adjusts various parameters affecting the SITRANS LU10 response to material level changes as follows:

PARAMETER			VALUES DEPENDENT ON MEASUREMENT RESPONSE (P003) VALUE				
Number	Name	(Units)	1 (slow)	2 (medium)	3 (fast)	4 (surge)	5 (turbo)
P070	Failsafe Timer	(min)	100	10	1	0.1	0
P700	Max Fill Rate	(m/min)	0.1	1	10	100	1000
P701	Max Empty Rate	(m/min)	0.1	1	10	100	1000
P702	Filling Indicator	(m/min)	0.01	0.1	1	10	100
P703	Emptying Indicator	(m/min)	0.01	0.1	1	10	100
P704	Rate Filter	(option)	4	3	2	2	2
P710	Fuzz Filter	(% of P007)	100	50	10	1	0
P711	Echo Lock	(option)	1 or 2 (dependent on Material, P002)			0	0
P713	Echo Lock Window		(dependent on P701/P702 and time since last valid measurement)				
P727	Scan Delay*	(s)	5	5	3	2	0
P728	Shot Delay	(s)	0.5	0.5	0.5	0.2	0.1
P803	Shot/Pulse Mode	(option)	2	2	2	1	1
P841	Long Shot Number	(none)	10	5	2	1	1

If any of these parameters are independently altered, a Measurement Response parameter alteration automatically changes the independently altered value.

* Scan Delay (P727) is globally set for all Point Numbers to the value associated with the fastest Measurement Response (P003) selected for any individual Point Number.

Slower Measurement Response provides greater measurement reliability. Faster independently set Max Fill / Empty Rates may be impeded by Echo Lock, Scan Delay and Shot Delay values.

Application Examples

The following examples describe the use of SITRANS LU10 programmable features, to meet the needs of specific process measurement requirements.

It is highly unlikely that your specific installation will match one of these examples exactly.

However, by reviewing the example (or combination of examples) that matches your installation best, the relationship between SITRANS LU10 features and process measurement requirements may be more easily recognized.

EXAMPLE 1. Level (or Material Volume) Measurement for a single vessel.

EXAMPLE 2. Space (or Remaining Vessel Capacity) Measurement for a single vessel.

EXAMPLE 3. Multi-point Average

EXAMPLE 4. Distance Measurement (less than 60 m).

Example 1 - Level Measurement

Material Level

This is the most common application of the SITRANS LU10 level monitor.

For this example we'll assume the following:

- one 30 m high cement silo is to be monitored.
- the maximum vessel filling rate is 0.08 m per minute.
- alarm indicators are required when the cement level exceeds 25 m or falls below 10 m.
- filling equipment is to be automatically deactivated at 27 m.
- in the event of a measurement difficulty, failsafe operation is to be activated in 2 minutes.
- if the difficulty doesn't subside, the filling process is to be stopped before a spill occurs.
- an XLT-30 transducer is mounted with its face flush with the top of the vessel.
- a TS-3 temperature sensor is connected to the Temp Sensor 1 terminals.
- a LU SAM is connected as BANK 1 to the Peripheral Communications terminals.

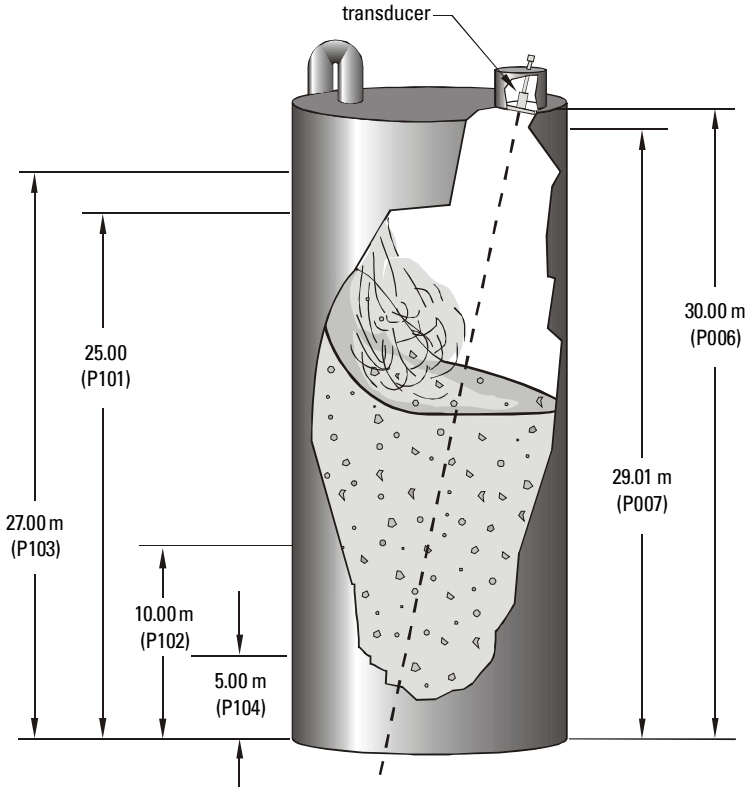

Parameter Settings for Point # 1

P001	Operation	Enter "1" for level .
P002	Material	Enter "2" for solid .
P003	Measurement Response	Enter "1" for slow (0.1 m/min).
P004	Transducer	Enter "107" for XLT-30 .
P005	Units	No entry required, (preset for meters).
P006	Empty	Enter "30" for transducer face to Empty equals 30.00 meters .
P007	Span	No entry required, (preset to 29.01 meters above Empty).
P070	Failsafe Timer	Enter "2" for failsafe activation after 2 minutes without a valid echo.
P071	Failsafe Material Level	Enter "H1" for advance to Span on "LOE" .
P072	Failsafe Advance	No entry required, (preset to restricted).
P100	Relay Set Up	Enter "3" for Hi, Lo, Hi Hi, and Lo Lo alarm relays.
P101	Hi Alarm	Enter "25" for Hi Alarm at 25.00 m .
P102	Lo Alarm	Enter "10" for Lo Alarm at 10.00 m .
P103	Hi Hi Alarm	Enter "27" for Hi Hi Alarm at 27.00 m .
P104	Lo Lo Alarm	Enter "5" for Lo Lo Alarm at 5.000 m .

With process control equipment disabled, enter the RUN mode to monitor system performance and alarm programming. Otherwise, perform a Reading Measurement simulation (P920).

When satisfied with system performance and programming:

- connect a high alarm indicator to LU SAM Relay # 1 (see P100 = 3).
- connect a low alarm indicator to LU SAM Relay # 6.
- connect a high high alarm indicator and filling equipment stop/start control to LU SAM Relay # 11.
- connect a low low alarm indicator to LU SAM Relay # 16.

(Note that LU SAM relays are de-energized in "alarm" conditions).

When monitoring dusty dry solids, measurement difficulties may be encountered, (especially when pneumatic filling equipment is used). For this example (assume the maximum filling rate), failsafe operates as follows.

e.g.	09:15 am	Echo lost at 6.00 m, low alarm is still on, failsafe countdown begins.
	09:17 am	Failsafe activated, actual level = 6.16 m, reported level = 6.00 m.
	09:57 am	Low alarm off, actual level = 9.36 m, reported level = 10.00 m.
	12:27 pm	High alarm on, actual level = 21.36 m, reported level = 25.00 m.
	12:47 pm	Infeed stopped, actual level = 22.96, reported level = 27.00 m.

When the dust settles (and the echo is regained) the reported level advances toward the actual level. When the reported level reaches 25.55 m (5% of Span less than the high high alarm trip point), the high high alarm goes off, restarting the infeed and filling the vessel to 27.00 m.

Material Volume

To perform a volume conversion for the preceding example, we'll assume:

- the vessel is cylindrically shaped with a flat bottom.
- the vessel volume for Empty to 29.01 m (Span) is 1457 m³.

Volume Parameter Settings For Point # 1

P050	Tank shape	Enter "1" for vertical cylinder with flat bottom.
P051	Max Volume	Enter "1457" for 1457 m³.

Now in the RUN mode the Reading represents material volume in m³.

Example 2 - Space Measurement

This mode of operation is commonly used when remaining vessel capacity is of more importance to the installation than the actual material level.

Space

For this example we'll assume the following:

- the vessel is a 3 ft diameter by 15 ft long cylinder (including the parabolic ends of 1.5 ft each).
- the maximum vessel filling rate is 1 ft per minute (slower at mid level).
- a mA output scaled from 4 mA at Full to 20 mA at Empty is required for PLC operation.
- in the event of a measurement difficulty, failsafe operation is to be activated in 30 seconds.
- if the difficulty doesn't subside, the mA output must immediately assume 22.00 mA.
- an XCT-8 transducer is mounted in a standpipe such that the XCT-8 face is 18 in. above the vessel top.
- an LU AO is connected to the Peripheral Communications terminals.
- a TS-3 temperature sensor is mounted in the vessel to monitor liquid temperatures.

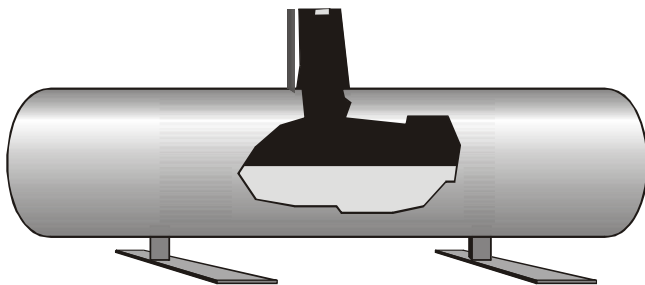

Parameter Settings For Point # 1

P001	Operation	Enter "2" for space .
P002	Material	No entry required (preset for liquid).
P003	Measurement Response	No entry required. (preset for medium , 1 m/min).
P004	Transducer	Enter "101" for XCT-8 .
P005	Units	Enter "4" for feet .
P006	Empty	Enter "4.5" for 4.50 ft (3 feet diameter plus 1.5 ft in standpipe).
P007	Span	Enter "3" for 3 ft (vessel diameter).
P070	Failsafe Timer	Enter ".1" for 6 seconds .
P071	Failsafe Material Level	Enter "Lo" for advance to Empty on "LOE" .

Parameter Settings For LU AO mA Output # 1

P200	mA Range	No entry required. (preset for 20 mA = low level , P001 = 2.)
P213	mA Max Limit	Enter "20.2" for 20.20 mA .
P219	mA Failsafe	Enter "20.2" for 20.20 mA .

Parameter Settings For Temperature Averaging

P660	Temp Source	Enter "5" for average XCT-8 and TS-3 temperatures.
------	-------------	---

With process control equipment disabled, enter the RUN mode to monitor system performance and alarm programming. (A Reading Measurement simulation (P920) may be performed to verify mA output programming).

When satisfied with system performance and programming, connect LU AO mA output 1 to the Programmable Logic Controller (PLC).

Note that on SITRANS LU10 "power off" the LU AO mA output is "held" and on LU AO "power off" the mA output drops to 0.00 mA. During a power interruption, the "last known" mA output value is maintained in memory for 1 hour minimum. If power is interrupted beyond 1 hour, on power resumption, the mA output immediately assumes the "new value".

Remaining Vessel Capacity

To perform a volume conversion for the preceding example, the following programming is required.

Volume Parameter Settings For Point # 1

P050	Tank Shape	Enter "7"* for horizontal cylinder with parabolic ends .
P051	Max Volume	Enter "117" for 117 cubic feet (Use vessel fabricators value).
P052	Tank Dimension A	Enter "1.5" for 1.5 ft (the horizontal length of one parabolic end).
P053	Tank Dimension L	Enter "12" for 12 ft (the horizontal length, excluding parabolic ends).

* This is the only tank shape where the Empty (P007) value must exactly equal the vessel height.

Now in the RUN mode, the Reading Value and LU AO mA output represents remaining vessel capacity in cubic feet. If the mA output is still to be scaled to "space" (distance from material to Full in feet) set the mA Function (P201) to "2".

Example 3 - mA Multi-point Average

This mode of operation may be used for bunkers with multiple material discharges and tank farms where several tanks contain the same material. As well as monitoring the amount of material in each bunker section (or tank) a mA output representing the average measurement may be used to calculate total material or remaining capacity.

For this example we'll assume the following:

- the bunker is 150 ft long by 60 ft deep max. and has 6 sections with individual discharge outlets.
- the maximum filling/discharge rate for each bunker section is 3 inches per minute.
- an XLS-30 transducer is mounted 65 ft above each discharge outlet.
- a mA output proportional to each bunker section material level is required by the PLC.
- a mA output proportional to the average material level is required for total material calculation.
- if a measurement difficulty occurs for greater than 2 minutes, 3.8 mA is required by the PLC.
- the XLS-30's are connected to the Transducer 1 to Transducer 6 terminals.
- an LU AO is connected to the SITRANS LU10 Peripheral Communications Terminals.

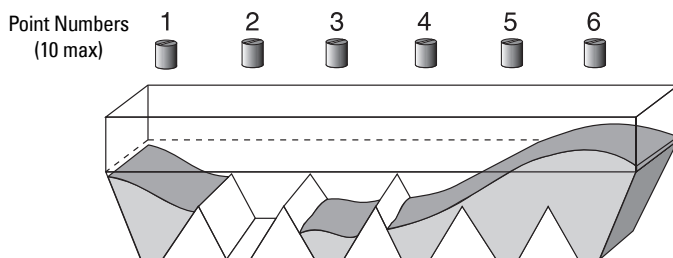

mA Output #	1	2	3	4	5	6	7 (avg.)
mA Output Value	14 mA	4 mA	7 mA	8 mA	16 mA	18 mA	11.2 mA



Parameter Settings For Point # 00 (Points 1 - 10)

P001	Operation	Enter "1" for level .
P002	Material	Enter "2" for solid .
P003	Measurement Response	Enter "1" for slow , 0.1 m/min (4 in/min).
P004	Transducer	Enter "109" for XLS-30 .
P005	Units	Enter "4" for feet .
P006	Empty	Enter "65" for transducer face to Empty equals 65 ft .
P007	Span	Enter "60" for max material level equals 60 ft .
P070	Failsafe Timer	Enter "2" for 2 minutes

Parameter Settings For LU AO mA Output # 00 (1 - 10)

P200	mA Range	No entry required (Empty = 4 ma; Full = 20 mA when P001 = 1).
P219	mA Failsafe	Enter "3.8" for 3.8 mA output on "LOE".

Parameter Settings For Point # 7, 8, 9 and 10.

P999	Master Reset	Press   with each unused Point Number displayed.
------	--------------	--

Ensure Point Number 00 is not still displayed or all programming will be cleared .

Parameter Settings For LU AO mA Output # 7

P202	mA Allocation	Enter "1.6" for mA output # 7 equals the Point Number 1 - 6 average.
------	---------------	--

With process control equipment disabled, enter the RUN mode to monitor system performance. Otherwise, perform a Reading Measurement simulation (P920) to verify programming.

When satisfied with system performance and programming:

- connect the LU AO mA outputs 1 - 6 to the PLC as required.
- connect the LU AO mA output 7 to the device indicating total material.

Note that on SITRANS LU10 "power off" the LU AO mA output is "held" and on LU AO "power off" the mA output drops to 0.00 mA. During a power interruption, the "last known" mA output value is maintained in memory for 1 hour minimum. If power is interrupted beyond 1 hour, on power resumption, the mA output immediately assumes the "new value".

Note: If a Tripper Car is used to fill each section of the bunker, see Example 4 as well.

Example 4 - Distance Measurement

This mode of operation may be used for equipment position monitoring up to 60 m (200 ft). Operation is similar to Space Measurement operation except that measurements are referenced to the transducer face.

For this example we'll assume the following:

- Transducer 10 (an XLS-60) is mounted horizontally* facing the Tripper Car.
- when the Tripper Car is at the far end stop, the transducer face to Tripper Car distance is 175 ft.
- when the Tripper Car is at the near end stop, the transducer face to Tripper Car distance is 5 ft.
- the Tripper Car travels at 7 ft/min, and is normally maintained 14 ft from either end stop.
- a mA output proportional to Tripper Car distance from the transducer is required for PLC operation.
- if the PLC reads 3.8 mA, the Tripper Car is to immediately stop.
- an LU AO is connected to the SITRANS LU10 Peripheral Communications terminals.

*When an XLS or XLT series transducer is mounted horizontally, install a support plate under the transducer to prevent possible mounting/conduit connection damage.

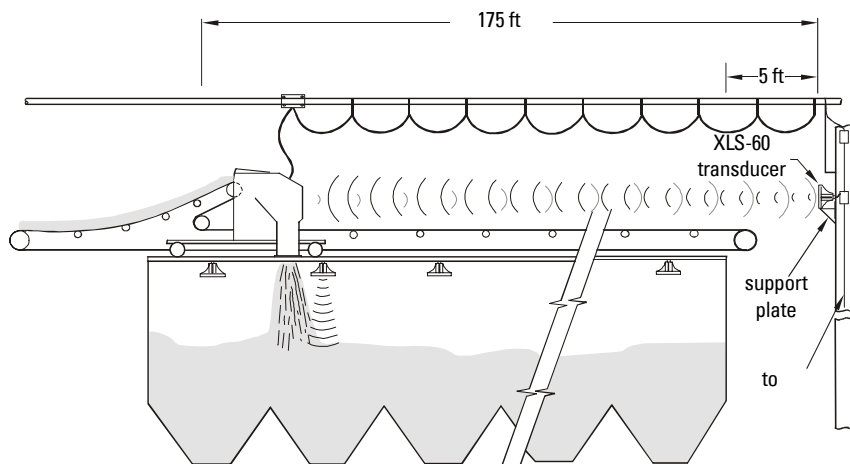

Parameter Settings For Point #10

P001	Operation	No entry required (preset to "3" for distance).
P002	Material	Enter "2" for solid .
P003	Measurement Response	No entry required (preset to "2" for medium response, 1 m/min).
P004	Transducer	Enter "110" for XLS-60 Transducer.
P005	Units	Enter "4" for feet .
P006	Empty	Enter "175" for 175 foot transducer face to Tripper Car max distance.
P007	Span	No entry required (preset to Empty, P006 when P001 = 3).
P070	Failsafe Timer	Enter "2" for 2 minutes (14 ft at the maximum travel rate).

Parameter Settings For LU AO mA Output # 10

P200	mA Range	No entry required (XLS-60 face=4mA* ; far=20mA when P001 = 3).
P219	mA Failsafe	Enter "3.8" for 3.8 mA output on "LOE".

* Objects near the transducer face (4 mA) cannot be reliably detected. Use controls to stop the Tripper Car before it approaches the transducers Nearest Distance. (See *Installation* Transducer Mounting.)

With the PLC disabled, enter the RUN mode (or perform a Reading Simulation, P920). When satisfied with system performance and programming, connect LU AO mA Output 10 to the PLC.

For a completely automated system, position the Tripper Car via the PLC, based upon bunker material level, as monitored by the remaining SITRANS LU10 Point Numbers. (See EXAMPLE 3 - mA Multi-point Average). When both examples 3 and 4 are used, the PLC may be programmed to operate as follows:

- fill bunker sections to predetermined levels based upon LU AO mA output 1 - 6 values.
- shuttle Tripper Car to lowest bunker section level.
- if a bunker section "LOE" occurs (3.8 mA), shuttle to the next lowest bunker section.
- if a Tripper Car "LOE" occurs (3.8 mA on mA Output 10), stop Tripper Car and material feed.
- when "LOE" subsides, restart material feed.
- when all bunker levels are full, stop material feed and "park" the Tripper Car.

Application Assistance

The preceding examples describe only a few ways in which the SITRANS LU10 can be applied to process measurement requirements.

The SITRANS LU10 can be used to monitor almost any process (within the temperature, measurement range, and chemical immunity capabilities of the system) where a distance measurement or determination of presence vs. lack of presence of an object is desired.

By thoroughly reviewing the parameters sections, you may identify some interesting ways of using the SITRANS LU10 to monitor specific processes.

e.g. 1 In a paper mill, one transducer may be used to monitor roll diameter, while another monitors the presence of paper to the roll. The feed can be stopped based on the roll diameter or a paper break.

e.g. 2 For a truck loading station, one transducer can monitor truck position while another monitors load height. The discharge can be stopped if the truck is out of position or when it's full, and the discharge chute can be positioned a minimal distance from the load during filling to keep dust down.

Siemens Milltronics has many years experience applying ultrasonic level measurement to a variety of processes in the mining, aggregate, lumber, grain, chemical, pulp and paper, water, and waste water industries.

If you encounter a difficulty applying the SITRANS LU10 to a process measurement requirement, or successfully apply the SITRANS LU10 to a "unique process" we may have never considered, contact Siemens Milltronics or your local distributor.

BIC-II Support

As preset, the SITRANS LU10 provides a digital output via the *Peripheral Communications* (20 mA bipolar serial current loop) terminals, capable of supporting the Siemens Milltronics BIC-II.

The SITRANS LU10 utilizes *simplex convention* communication protocol. Data messages are continuously transmitted at regular intervals (no poll is required) at 4800 baud. All data is transmitted in structured messages of ASCII characters consisting of eight data bits, no parity, and one stop bit.

If Peripheral Communications (P740) is set for "formatted" messages, a comma is inserted between each message field (except immediately preceding the "End of Message" characters).

MT-00 Measurement Message

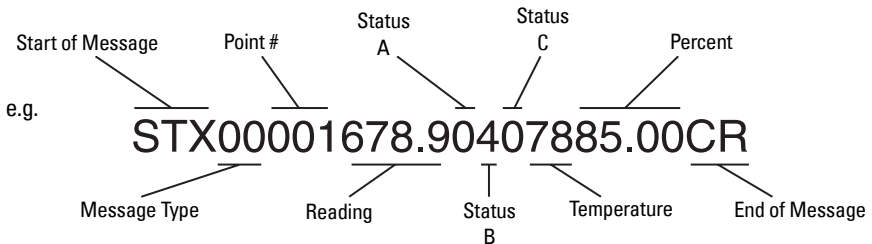

Field Name**Definition**

STX	\$02 (Start Of Message)
Message Type	2 characters, 00 (indicates the following data pertains to a scan point measurement)
Point #	3 characters, 001 to 010 (e.g. the message pertains to Point Number 1)
Reading	5 characters, 0.000 to 9999. (e.g. reading = 678.9, DDDD. = no data, EEEE. = overflow)
Status A	1 character, \$0 to \$F (convert to binary, e.g. temp, echo, and cable OK, not priority)

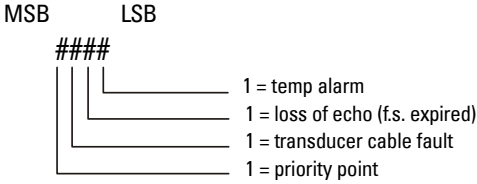

Status B	1 character, \$0 to \$F (convert to binary, e.g. scan point is in high alarm)
----------	---

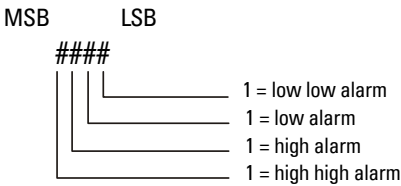

Status C	1 character, \$0 to \$F (convert to binary, e.g. scan point is not in rate or band alarm)
----------	---

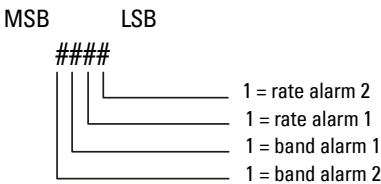

Temp	2 characters, \$32 to \$FA (convert to decimal and subtract 100, e.g. temperature = 20 °C)
Percent	5 characters, 00.00 to 9999. (e.g. current level = 85.00% of span, EEEE. = field overflow)
CR	\$0D (End Of Message)

MT-01 Hold Message

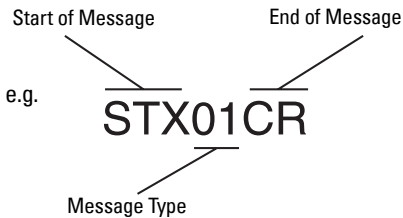

Field Name	Definition
STX	\$02 (Start Of Message)
Message Type	2 characters, 01 (indicates the SITRANS LU10 was removed from the RUN mode).
CR	\$0D (End Of Message)

MT-03 Point Not Scanned

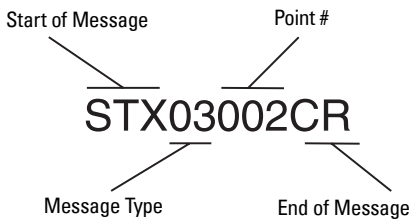

Field Name	Definition
STX	\$02 (Start Of Message)
Message Type	2 characters, 03 (indicates the Point Number is not in service).
Point #	3 characters, 001 to 010 (e.g. Point Number 2)
CR	\$0D (End Of Message)

If desired, the SITRANS LU10 is capable of receiving data messages from the host device, to put a vessel "on" or "off" priority. (See SMART SCAN, P720).

MT-12 Point On Priority

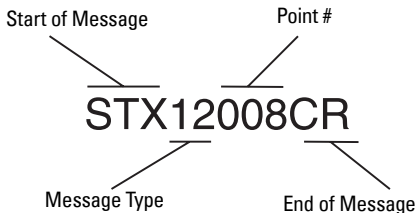

Field Name	Definition
STX	\$02 (Start Of Message)
Message Type	2 characters, 12 (put point on priority).
Point #	3 characters, 001 to 010 (e.g. Point Number 8)
CR	\$0D (End Of Message)

MT-13 POINT OFF PRIORITY

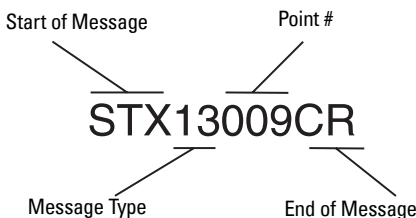

Field Name	Definition
STX	\$02 (Start Of Message)
Message Type	2 characters, 13 (take point off priority).
Point #	3 characters, 001 to 010 (e.g. Point Number 9)
CR	\$0D (End Of Message)

Maintenance

The SITRANS LU10 should require no maintenance, though good housekeeping practices in and around the area of the enclosure are recommended.

Wipe out the area of the enclosure lid docking bay recess with a clean dry cloth (if necessary) before installing the programmer.

Transducer inspection, to verify the effectiveness of the self cleaning design, is recommended. If material build-up **on the transducer face** is observed, to maintain maximum system performance, a schedule of regular cleaning should be adopted.

Troubleshooting Guide

SYMPTOM	CAUSE	ACTION
Display blank, Transmit Neon not flashing, transducer not pulsing	No power	Check power supply, wiring and voltage selection switch.
No response to programmer	Obstructed infrared interface, or defective programmer	Clean enclosure "docking bay" and programmer magnet slot.
Displays "Short" and "tb:(#)"	Short circuited transducer cable, or defective transducer	Repair or replace as necessary.
Displays "Open" and "tb:(#)"	Transducer not connected	Connect transducer, or remove Point # from service (P001=0).
	Open circuited transducer cable, or defective transducer	Repair or replace as necessary.
Displays "Error" and "tb:(#)"	Transducer connected wrong	Reverse BLK and WHT wires.
	Wrong Transducer (P004)	Enter correct value.
Displays "LOE"	Weak or non-existent echo	Relocate and / or reaim transducer at material level or object.
		Proceed to "Measurement Difficulties", (following page).
Displays "EEEE"	Reading too high	Select larger Units (P005), or lower Convert Reading (P061).
Displays "EEEEPrO"	Faulty EEPROM memory chip	Return to factory for repair or replacement.
Reading fluctuates while material level is still, (or vice versa)	Incorrect measurement stabilization	Alter Measurement Response (P003) accordingly.
		See <i>Technical Reference</i> Measurement Response.
Reading is fixed, regardless of the actual material level	Transducer beam obstructed, standpipe too narrow, or transducer mounting resonant	Relocate and / or reaim transducer at material level or object.
		Proceed to "Measurement Difficulties", (following page).
Material level reported is always "off" by the same amount	Incorrect Empty (zero) reference	See Empty (P006), Reading Offset (P063), Offset Calibration (P650), & Offset Correction (P652).
Measurement accuracy improves as level nears transducer	Incorrect Sound Velocity used for distance calculation	Use an ultrasonic / temperature transducer or a TS-3 temperature sensor.
		See <i>Technical Reference</i> Sound Velocity.
Reading is erratic, with little or no relation to material level	True echo too weak or wrong echo being processed	Relocate and / or reaim transducer at material level or object.
		Proceed to Measurement Difficulties.

Measurement Difficulties

If a measurement difficulty occurs for greater than the Failsafe Timer (P070) setting, "LOE" is flashed alternately with the Reading display. Under certain conditions, a measurement difficulty may cause the SITRANS LU10 to "lock on" to a false echo and report a fixed or wrong Reading.

Flashing "LOE" Display

If "LOE" is displayed, ensure the following:

1. Material (object) surface monitored is within the maximum range of the transducer.
2. Transducer (P004) value matches the transducer used.
3. Transducer is located and aimed properly.

(See the Transducer manual for the maximum range, mounting and rough aiming instructions.)

For optimum performance, adjust the transducer aiming while monitoring the Echo Confidence (P805) for various material levels over the measurement range. When complete, set the transducer aiming at the best angle for all levels.

To display Echo Confidence in the RUN mode

Press  and hold for 4 seconds (Failsafe Time Left changes to the Short:Long Confidence display).

To display Echo Confidence in the PROGRAM mode, access the Echo Confidence (P805) parameter. To update the value displayed after each aiming adjustment

Press  (5 times or more to verify stability)

If the condition persists (despite optimum aiming), optimize transducer performance. Adjust Short Shot Frequency, (P842) and Long Shot Frequency, (P843) for maximum Echo Confidence (P805).

Increase the Failsafe Timer (P070) value, if failsafe operation will not be compromised by the larger value.

If "LOE" is displayed only when a sloped bottom vessel is near Empty, the echo is probably being reflected away from the transducer. Install an empty "target plate" in the bottom of the vessel. When exposed (not covered by material), the target plate provides the reflective surface representative of an empty vessel.

Install a longer range transducer, enter the new Empty (P006) distance, and (if necessary) optimize aiming and frequency again.

If a longer range transducer is not available, connect an oscilloscope to the SITRANS LU10 (see Enhancement Parameters Scope Displays, P810).

If a discernible echo is observed (representative of the material / object surface), reduce the Confidence Threshold (P804) while taking new measurements (in the RUN or PROGRAM mode).

Sometimes, material simply cannot be detected during vessel filling. In these cases, set up failsafe operation such that the SITRANS LU10 "anticipates" the rate of material level increase and adjusts the reported Reading accordingly. This operation is reliable, as long as when the dust (or foam) settles a valid echo can be received. See *Technical Reference Application Examples Example 1 - Level Measurement*.

Fixed Reading

If the Reading is a fixed value, regardless of the transducer to material (object) surface distance, ensure the following:

1. Transducer sound beam is free from obstruction.
2. Material (object) surface monitored is not within the Transducers' nearest measurable distance.
3. Transducer is not in contact with any metal object.
4. Material agitator (if used) is "on" while the SITRANS LU10 is operating.

If the fixed Reading represents a distance more than 3 meters (9 feet) from the transducer face, the SITRANS LU10 is probably detecting some vessel interior obstruction. Aim away from (or remove) the obstruction.

If the obstruction cannot be removed or avoided, the SITRANS LU10 *TVT*(Time Varying Threshold) Curve must be modified to reduce the Echo Confidence derived from the sound reflected by the obstruction. (See *Enhancement Parameters Scope Displays, P810* and *TVT Shaper, P832*).

If the fixed Reading represents a minimal distance from the transducer face, the condition may be caused by a sound beam obstruction (check for this first), but could also be due to other factors.

If the material (object) surface is within the Transducers' *nearest distance* (see *Installation Transducer Mounting*), mount the transducer higher above (farther away from) the nearest object to be monitored.

If the transducer is mounted on a standpipe, grind smooth any burrs or welds on the inside or *open end*(the end that opens into the vessel). If the problem persists, install a larger diameter or shorter length standpipe, or *flare* (increase the diameter of) or cut the open end of the standpipe at a 45° angle.

For "ST-series" transducers **only**, ensure non-metallic mounting hardware (supplied) is used. Often, loosening over tightened mounting hardware will mechanically isolate the transducer from a resonant metallic surface.

Regardless of the mounting type, if difficulties persist, optimize transducer performance. Adjust Short Shot Frequency (P842) and Long Shot Frequency (P843) for maximum Echo Confidence (P805).

If the preceding remedies have not produced satisfactory results, the false echo has to be ignored. Extend Near Blanking (P800) to a distance (from the transducer face) to just beyond the distance represented by the Reading. This also increases the nearest distance the material level / object may come within the transducer face and still be detected.

If increasing Near Blanking is unacceptable (the transducer cannot be mounted higher) see Auxiliary Transducer (P725). Otherwise, the TVT Curve must be raised in the area of the false echo.

Connect an oscilloscope to the SITRANS LU10, (see *Enhancement Parameters* Scope Displays, P810). Adjust the TVT Start Min (P833), TVT Start Duration (P834), and TVT Slope Min (P835) slightly.

Continue making minor TVT Curve adjustments and taking new measurements while observing the Echo Marker position until the Echo Lock Window repeatedly locks onto the true echo. Verify the false echo is still ignored, regardless of the vessel material level, or empty / fill activity.

Wrong Reading

If the Reading is erratic, or jumps to some incorrect value periodically, ensure the following:

1. Material (object) surface monitored is not beyond the transducers maximum range.
2. Material is not falling in the transducer sound beam.
3. Material (P002) value matches the material monitored.
4. Measurement Response (P003) is not set too fast.
5. Transducer (P004) type entered matches the transducer used.

If the periodic incorrect value is always the same, see Fixed Reading. If the incorrect value seems to be random, ensure the material surface to transducer distance is less than the Empty value entered plus 20%. If the material / object monitored is outside this distance, increase Range Extension (P801) as required.

If the material monitored is a liquid, check for splashing in the vessel. Increase Measurement Response as required to stabilize the Reading, or install a stilling well (contact Siemens Milltronics or your local distributor).

Access the Noise (P807) parameter. If the peak value jumps wildly, verify the transducer cables are run in grounded metal conduit; separate from other wiring, and transducer cable shields are connected to the SITRANS LU10 shield terminals and not to ground elsewhere.

If the SITRANS LU10 is mounted in close proximity to (or transducer cables run near those of) another ultrasonic level monitor, see Level System Sync (P726).

Temporarily disable nearby SCR control drives, high voltage or current contactors. If the condition disappears, move the SITRANS LU10 to another location.

Set Echo Lock (P711) to "max verification" (response to material level changes may be slowed somewhat).

Increase the Confidence Threshold (small amounts at a time) while observing the results. If performance is not improved return the Confidence Threshold to the preset value.

Connect an oscilloscope to the SITRANS LU10, (see *Enhancement Parameters* Scope Displays, P810). While monitoring the Echo Marker, select the Algorithm (P820) best suited to the material / conditions.

If the "Area" algorithm is used and narrow noise spikes are evident on the (long shot) Echo Profile, turn the Spike Filter (P821) on and / or widen the Narrow Echo Filter (P822). Also, if the true echo has jagged peaks, use Reform Echo (P823).

If multiple echoes appear on the Echo Profile, typical of a flat material profile (especially if the vessel top is domed), use the "first" Algorithm.

If the Echo Profile repeatedly switches from short to long, adjust the Short Shot Range (P852) to stabilize the "shot" mode used for the echo evaluation. Also, adjust the Short Shot Bias to increase (or decrease) the amount of preference given to short shot echoes over long shot echoes.

Should a stable measurement still not be attainable, contact Siemens Milltronics or your local distributor.

Specifications

Power:	<ul style="list-style-type: none"> • 100 / 115 / 200 / 230 Vac \pm 15%, 50 / 60 Hz, 31 VA
Environmental:	<ul style="list-style-type: none"> • location : <ul style="list-style-type: none"> • indoor / outdoor • altitude : <ul style="list-style-type: none"> • 2000 m max • ambient temperature : <ul style="list-style-type: none"> • – 20 to 50 °C (– 5 to 122 °F) • relative humidity : <ul style="list-style-type: none"> • suitable for outdoor (Type 4X / NEMA 4X / IP65 enclosure) • installation category : <ul style="list-style-type: none"> • II • pollution degree : <ul style="list-style-type: none"> • 4
Scan Points:	<ul style="list-style-type: none"> • 10 points per SITRANS LU10 max • frequency independent
Range:	<ul style="list-style-type: none"> • 0.3 m (1 ft) to 60 m (200 ft) max
Accuracy:	<ul style="list-style-type: none"> • 0.25% of program range¹ or 6 mm (0.24"), whichever is greater
Resolution:	<ul style="list-style-type: none"> • 0.1% of program range¹ or 2 mm (0.08"), whichever is greater
Memory:	<ul style="list-style-type: none"> • EEPROM (non-volatile) no back-up battery required
Programming:	<ul style="list-style-type: none"> • via removable hand programmer and / or Dolphin interface package
Display:	<ul style="list-style-type: none"> • Custom Graphics LCD • 51 mm (2 in) x 127 mm (5 in) viewing area
Synchronization	<ul style="list-style-type: none"> • up to 16 SITRANS LU10 units can be synchronized together
Temperature Compensation:	<ul style="list-style-type: none"> • – 50 to 150 °C (– 50 to 302 °F) • integral transducer sensor • 1 TS-3 temperature sensor input (expandable to 10 inputs with optional TIB-9 card). • programmable fixed temperature
Temperature Error:	<ul style="list-style-type: none"> • with compensation: <ul style="list-style-type: none"> • 0.09% of range • fixed temperature: <ul style="list-style-type: none"> • 0.17% / °C deviation from programmed temperature.
Outputs:	<ul style="list-style-type: none"> • transducer drive: <ul style="list-style-type: none"> • 150 to 315 V peak (transducer model dependent)
Communications:	<ul style="list-style-type: none"> • proprietary bipolar current loop for Peripherals communication (see Options) • Dolphin compatible • SmartLinx compatible
Enclosure:	<ul style="list-style-type: none"> • Type 4X / NEMA 4X / IP65² • 285 mm W x 209 mm H x 92 mm D (11.2" W x 8.2" H x 3.6" D) • polycarbonate
Weight:	<ul style="list-style-type: none"> • 2.3 kg (5 lb)
Approvals:	<ul style="list-style-type: none"> • CE *, CSA <small>NRTL/C</small> • Lloyd's Register of Shipping, Categories ENV1, ENV2, ENV3, and ENV5 * EMC performance available upon request

1. Program range is defined as the empty distance to the face of the transducer (P006) plus any range extension (P801).

2. The use of approved watertight hubs/glands is required for Type 4X / NEMA 4X / IP65.

Programmer

- Power:
 - 9 V (ANSI / NEDA 1604, PP3 or equivalent) or 3 V lithium battery
- Ambient Temperature:
 - -20 to 50 °C (-5 to 122 °F)
- Keypad:
 - 20 keys with tactile feedback
- Interface:
 - non-invasive, digital, infra-red
- Enclosure:
 - general purpose
 - 67 mm W x 100 mm H x 25 mm D (2.6" W x 4" H x 1" D)
 - ABS plastic

Transducer

- Compatible Models:
 - ST Ultrason[®] , STH and Echomax[®] series
- Refer to the associated instruction manual.

Options

- Temperature Sensors:
 - TS-3

Refer to associated instruction manual.
- Expansion Card:
 - TIB-9 card, increases TS-3 inputs from 1 to 10 max
- Peripherals:
 - LU SAM, Satellite Alarm Module, 2 max
 - LU AO, Analog Output module, 1 max
 - BIC-II, Buffered Interface Converter, 1 max
 - 3 peripherals per SITRANS LU10 max
- SmartLinx Modules:
 - protocol specific modules for interface with popular industrial communications systems. Refer to associated product documentation.
- Dolphin:
 - Siemens Milltronics' Windows[®] based, software interface and infrared ComVerter link. Refer to associated product documentation.

Cable

- Transducer:
 - RG-62 A/U (or equivalent), 365m (1,200 ft) max.
 - See transducer instructions for short extensions (in grounded metal conduit, separate from other wiring)
- mA Output:
 - Belden 9552, shielded / twisted pair, 18 AWG (0.75 mm²) or equivalent
 - maximum separation 1,500 m (5,000 ft)
- Synchronisation:
 - Belden 8760, shielded / twisted pair, 18 AWG (0.75 mm²) or equivalent
- Relays:
 - No shielded cable necessary
- Bipolar current loop:
 - Belden 9552, shielded / twisted pair, 18 AWG (0.75 mm²) or equivalent
 - maximum separation 1,500 m (5,000 ft)
- Temperature Sensor:
 - Belden 8760, shielded / twisted pair, 18 AWG (0.75 mm²) or equivalent
 - 365 m (1,200 ft) per TS-3 maximum
- RS-232 Link:
 - Belden 8770, 3 conductor / shielded, 18 AWG (0.75 mm²) or equivalent
 - maximum separation 15 m (50 ft)

Programming Chart

PARAMETER		ALTERED VALUES FOR POINT #s									
#	NAME	1	2	3	4	5	6	7	8	9	10

SECURITY

P000	Lock (G)										
------	----------	--	--	--	--	--	--	--	--	--	--

QUICK START

P001	Operation										
P002	Material										
P003	Measurement Response										
P004	Transducer										
P005	Units (G)										
P006	Empty										
P007	Span										

VOLUME

P050	Tank Shape										
P051	Max Volume										
P052	Tank Dimension A										
P053	Tank Dimension L										
P054	Level Breakpoints	record values on a separate sheet									
P055	Breakpoint Volumes	record values on a separate sheet									

READING VALUE

P060	Decimal Position										
P061	Convert Reading										
P062	Offset Reading										

FAILSAFE

P070	Failsafe Timer										
P071	Failsafe Material Level										
P072	Failsafe Level Advance										

RELAYS

P100	Relay Set Up (G)										
P101	Hi Alarm										
P102	Lo Alarm										
P103	Hi Hi Alarm										
P104	Lo Lo Alarm										
P110	Relay Allocation										
P111	Relay Function										
P112	Relay A Setpoint										
P113	Relay B Setpoint										
P116	Bound Alarm Hysteresis										
P129	Relay Failsafe										

Programming Chart

PARAMETER		ALTERED VALUES FOR POINT #s									
#	NAME	1	2	3	4	5	6	7	8	9	10

mA OUTPUTS

P200	mA Range										
P201	mA Function										
P202	mA Allocation										
P203	mA Value/Transducer (V)										
P210	0/4 mA Setpoint										
P211	20 mA Setpoint										
P212	mA Min Limit										
P213	mA Max Limit										
P214	4 mA Trim										
P215	20 mA Trim										
P219	mA Failsafe										

DATA LOGGING

P300	Temp, Transducer Max (V)										
P302	Temperature, Sensor Max (V)										
P330	Profile Record										
P331	Auto Record Enable (G)										
P332	Auto Record Transducer (G)										
P333	Auto Record Interval (G)										
P334	Auto Record A Setpoint (G)										
P335	Auto Record B Setpoint (G)										
P336	Auto Record Filling/Emptying(G)										
P337	Auto Record LOE Time										
P340	Date of Birth										
P341	Run Time										
P342	Start Ups										

RANGE CALIBRATION

P650	Offset Calibration										
P651	Sound Velocity Calibration										
P652	Offset Correction										
P653	Velocity										
P654	Velocity @ 20 °C										

TEMPERATURE COMPENSATION

P660	Temp Source										
P661	Temp Fixed										
P662	Temp Sensor Allocation										
P663	Temp Transducer Allocation										
P664	Temperature (V)										

Programming Chart

PARAMETER		ALTERED VALUES FOR POINT #s									
#	NAME	1	2	3	4	5	6	7	8	9	10

RATE

P700	Max Fill Rate										
P701	Max Empty Rate										
P702	Filling Indicator										
P703	Emptying Indicator										
P704	Rate Filter										
P705	Rate Update Time										
P706	Rate Update Distance										
P707	Rate Value (V)										

MEASUREMENT VERIFICATION

P710	Fuzz Filter										
P711	Echo Lock										
P712	Reserved										
P713	Echo Lock Window										

SCANNING

P720	Smart Scan Mode (G)										
P725	Auxiliary Transducer										
P726	Level System Sync (G)										
P727	Scan Delay (G)										
P728	Shot Delay										
P729	Scan Time (V)										

DISPLAY

P730	Auxiliary Reading (G)										
P731	Auxiliary Reading Key (G)										
P732	Display Delay (G)										
P733	Scroll Access (G)										
P734	Scanning Indicators (G)										
P740	Peripheral Communications (G)										

ECHO PROCESSING

P800	Near Blanking										
P801	Range Extension										
P802	Submergence Transducer										
P803	Shot / Pulse Mode										
P804	Confidence Threshold										
P805	Echo Confidence (V)										
P806	Echo Strength (V)										
P807	Noise (V)										

Programming Chart

PARAMETER		ALTERED VALUES FOR POINT #s									
#	NAME	1	2	3	4	5	6	7	8	9	10

ADVANCED ECHO PROCESSING

P810	Scope Displays (G)										
P816	Echo Time										
P817	Profile Pointer Time										
P818	Profile Pointer Distance										
P819	Profile Pointer Amplitude										
P820	Algorithm										
P821	Spike Filter										
P822	Narrow Echo Filter										
P823	Reform Echo										
P824	(reserved)										
P825	Echo Marker Trigger										
P830	TVT Type										
P831	TVT Shaper										
P832	TVT Shaper Adjust	record values on a separate sheet									
P833	TVT Start Min										
P834	TVT Start Slope										
P835	TVT Slope Min										
P840	Short Shot Number										
P841	Long Shot Number										
P842	Short Shot Frequency										
P843	Long Shot Frequency										
P844	Short Shot Width										
P845	Long Shot Width										
P850	Short Shot Bias										
P851	Short Shot Floor										
P852	Short Shot Range										



www.siemens.com/processautomation

Siemens Milltronics Process Instruments Inc.
1954 Technology Drive, P.O. Box 4225
Peterborough, ON, Canada K9J 7B1
Tel: (705) 745-2431 Fax: (705) 741-0466
Email: techpubs.smpi@siemens.com

© Siemens Milltronics Process Instruments Inc. 2008
Subject to change without prior notice



7 M L 1 9 9 8 5 A N 0 2
Printed in Canada

Rev. 2.5