

# SIZE REDUCTION



**Pharmaceutics I**  
**Unit 4<sup>th</sup>**



# CONTENTS



---

## Course Contents

---

### **Size reduction**

Objectives, importance and theory of size reduction. Factors affecting, energy requirements, mechanisms and methods (dry/wet grinding) of size reductions. Principle, material of construction, applications, advantages and disadvantages of various mills like cutter mill, hammer mill, roller mill, ball mill, fluid energy mill, colloid mill. Study of latest industrial mills used in manufacturing of various dosage forms and their application.

---

# SIZE REDUCTION



What is the meaning of size reduction ?

- Size refers to physical Dimension of an object.
- Reduction refers to decrement or the process of decreasing the size.

# Simple definition of SIZE REDUCTION

- Size reduction is the operation carried out for reducing the size of bigger particles into smaller one of desired size and shape with the help of external forces.
- **COMMINUTION** is another term used for size reduction.



## Definition:

- Size reduction is the process of reducing large solid units or substance into smaller unit mass, coarse particles or fine particle.
- Size reduction process is also termed as *comminution* or *diminution* or *pulverisation*.

Types of powder	Specifications
Coarse powder	10/44
Moderate fine powder	44/85
Fine powder	85/120
Very fine powder	120/350

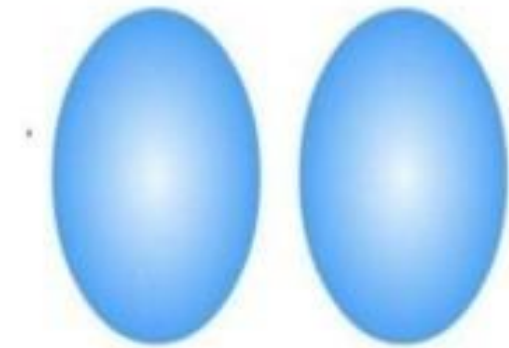

**Reduction in  
particle size**



**Increase in lipid  
nanoparticles  
concentration**





## Process of size reduction:

- Size reduction may be achieved by two methods:

1. *Precipitation method*

2. *Mechanical method*

1. **Precipitation method:** Substance + solvent  $\longrightarrow$  Mixture + another solvent  $\longrightarrow$  Precipitation of material  $\longrightarrow$  reduced size

( e.g. calcium carbonate, yellow mercuric oxide, bulk drugs etc.)

2. **Mechanical process:** Substance + mechanical force (grinding equipments like Ball mill, Colloid mill etc.)  $\longrightarrow$  reduced size

( e.g. *Dry grinding* in tables and capsules, *Wet grinding* in suspension, emulsion and ointments etc.)

# OBJECTIVES OF SIZE REDUCTION

- In the materials processing industry, size reduction or comminution is usually carried out in order to:
  - Increase the surface area because, in most reactions involving solid particles, the rate of reactions is directly proportional to the area of contact with a second phase.
  - Break a material into very small particles in order to separate the valuable amongst the two constituents.
  - Achieve intimate mixing.
  - To dispose solid wastes easily .
  - To improve the handling characteristics.
  - To mix solid particle more intimately.







## Advantages/ Applications/Significance and objectives of size reduction:

- Content uniformity
- Uniform flow
- Effective extraction of drugs
- Effective drying
- Improved physical stability
- Improved dissolution rate
- Improved rate of absorption



## Disadvantages of size reduction

- Drug degradation
- Contamination

# FACTORS AFFECTING ON SIZE REDUCTION



**1) Hardness**

**2) Toughness**

**3) Abrasiveness**

**4) Stickiness**

**5) Softening temperature**

**6) Material structure**

**7) Moisture content**

**8) Physiological effect**

**9) Purity required**

**10) Ratio of feed size to product ratio**

**11) Bulk density**



- **Hardness:**

- It is a surface property of the material.
  - It is frequently confused with a property named strength.
  - Thus, it is possible for a material to be very hard, but if it is brittle also then size reduction may present no special problems.
  - An arbitrary scale of hardness has been devised known as Moh's Scale;
    - Moh's Scale = 1 is for graphite
    - Moh's Scale < 3 is for soft material
    - Moh's Scale > 7 is for hard material
    - Moh's Scale = 10 is for diamond
- The harder the material the more difficult it is to reduce in size



- **Material structure:**

- Some substances are homogeneous in character.
- Mineral substances may have lines of weakness along which
- the materials splits to form flake-like particles.
- Vegetable drugs have a cellular structure often leading to long fibrous particles.



- **Abrasiveness:**

- Abrasiveness is a property of hard materials (particularly those of mineral origin).
- It may limit the type of machinery that can be used.
- During the grinding of some very abrasive substances the final powder may be contaminated with more than 0.1 percent of metal worn from the grinding mill



- **Softening temperature:**
- During size reduction process sometimes heat is generated which may cause some substances to soften, and the temperature at which this occurs can be important.
- Waxy substances, such as stearic acid, or drugs containing oils or fats are examples that may be affected.
- Some methods can be used to overcome this like cooling the mill, either by a water jacket or by passing a stream of air through the equipment.



**Friability:**

The friability of the material is its tendency to fracture during normal handling. In general, a crystalline material will break along well-defined planes and the power required for crushing will increase as the particle size is reduced.

**Stickiness:**

A sticky material will tend to clog the grinding equipment and it should therefore be ground in a plant that can be cleaned easily.

**Soapiness:**

In general, this is a measure of the coefficient of friction of the surface of the material. If the coefficient of friction is low, the crushing may be more difficult.

**Explosive:**

Such materials must be ground wet or in the presence of an inert atmosphere.

**Materials yielding dusts that are harmful to the health:**

Such material must be ground under conditions where the dust is not allowed to escape.

# PRINCIPLE OF SIZE REDUCTION



- **Cutting**: Material cut by sharp blades.  
e.g. cutter mill.
- **Compression**: Material crushed b/w roller by pressure  
e.g. roller mill.
- **Impact**: Material breaks by hammer or bars at high speed  
e.g. hammer mill.  
Moving particles strike against a stationary surface  
e.g. fluid energy mill.
- **Attrition**: Break down of material by rubbing action b/w  
two surfaces  
e.g. fluid energy mill.

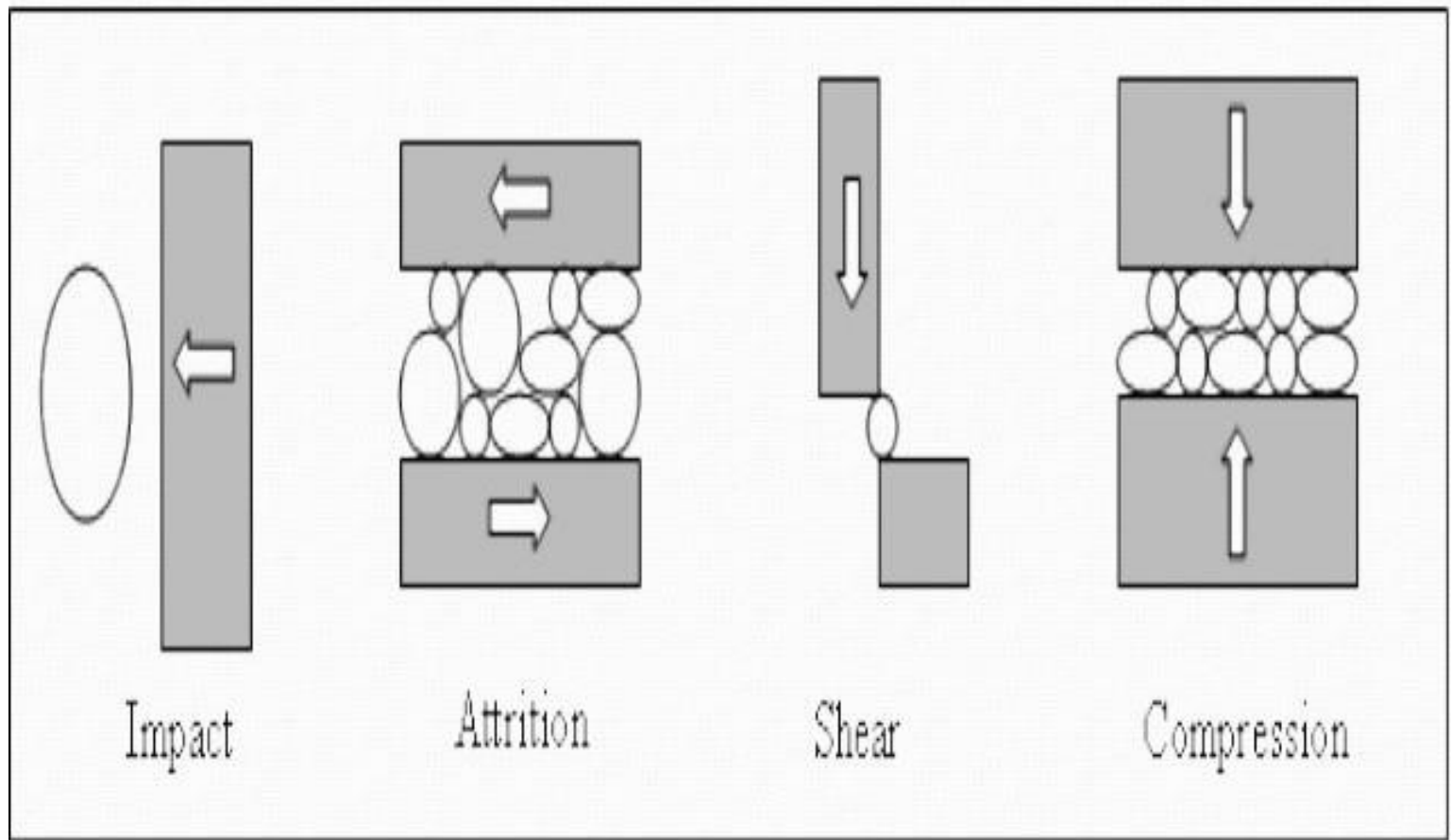



## COMMINUTION

### MECHANICAL

### CHEMICAL

#### external forces

- smashing
- breaking
- attrition
- peeling
- cutting
- crushing
- other

#### special forces

- thermal shock
- pressure change
- bombing with  
photon and other  
elemental particles
- other

#### chemical forces

- roztwarzanie
- rozpuszczanie
- spalanie
- biolugowanie
- inne



smashing

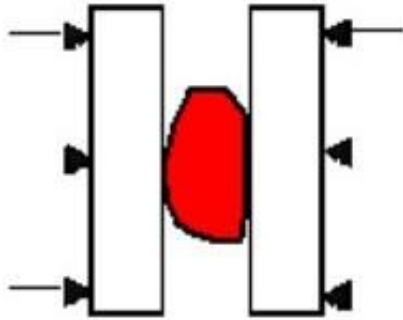

breaking

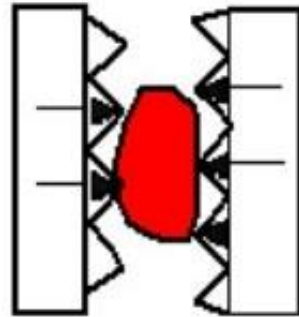

attrition

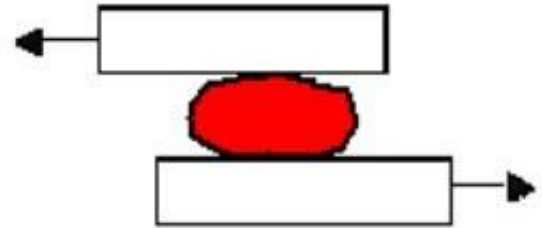

splitting

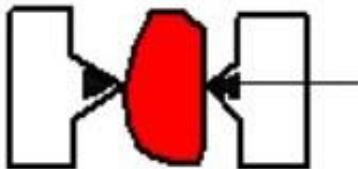

cutting

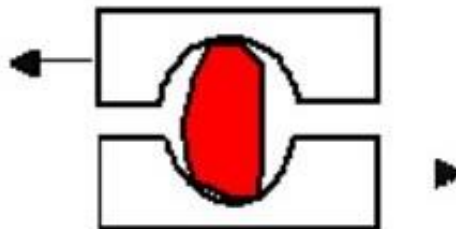

crunching

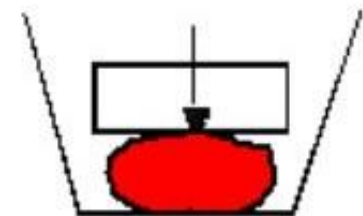

# CLASSIFICATION OF SIZE REDUCTION EQUIPMENTS



Sr. No.	Types Size reduction equipments	Examples
1.	<b>Crushers</b>	Edge runner mill, End runner mill
2.	<b>Grinders</b>	
	(a) <b>Impact mill</b>	Hammer mill
	(b) <b>Rolling-compression</b>	Roller mill
	(c) <b>Attrition mill</b>	Attrition mill
	(d) <b>Tumbling mill</b>	Ball mill
3.	<b>Ultra fine grinder</b>	Fluid energy mill
4.	<b>Cutting machine</b>	Cutter mill



<b>S.No.</b>	<b>Name of the mill</b>	<b>Mechanism of action</b>	<b>Uses</b>
1	Hammer mills	Impact	Used for almost all the drugs
2	Roller mills	Attrition & compression	Soft materials
3	Colloid mills	Impact & attrition	Used for almost all the drugs
4	Ball mill	Impact & attrition	Brittle drugs
5	Fluid energy mill	Impact & attrition	Moderately hard and friable materials

# **MOST IMP GTU QUESTION**

## **THEORIES OF SIZE REDUCTION / MILLING**



- A number of theories have been proposed to establish a relationship between energy input and the degree of size reduction produced.
- **Rittinger's theory :**
- **Bond's theory**
- **Kick's theory**
- **Walker's theory**



# Rittinger's theory



*Rittinger's theory suggests that energy required in a size reduction process is proportional to the new surface area produced.*

$$E = K_R (S_n - S_i)$$

where,  $E$  = energy required for size reduction

$K_R$  = Rittinger's constant

$S_i$  = initial specific surface area

$S_n$  = final specific surface area

**Application:** It is most applicable in size reducing brittle materials undergoing fine milling.

# Bond's theory



- ***Bond's theory states that the energy used in crack propagation is proportional to the new crack length produced.***

$$E = 2K_B \left( \frac{1}{\sqrt{d_n}} - \frac{1}{\sqrt{d_i}} \right)$$

- where, E = energy required
- $K_B$  = Bond's workindex
- $d_i$  = initial diameter of particles
- $d_n$  = final diameter of particles
- **Application:** This law is useful in rough mill sizing. The work index is useful in comparing the efficiency of milling operations.

# Kick's theory



- *Kick's theory states that the energy used in deforming (or fracturing) a set of particles of equivalent shape is proportional to the ratio of change of size/diameter*

$$E = K_k \log \frac{d_i}{d_n}$$

- where, E = energy required for size reduction
- $K_k$  = Kick's constant
- $d_i$  = initial diameter of particles
- $d_n$  = final diameter of particles
- **Application:** For crushing of large particles Kick's theory most useful.

# Walker's theory



- *Walker proposed a generalized differential form of the energy-size relationship:*

$$dE = -K \frac{dD}{D^n}$$

- Where E = amount of energy (work done) required to produce a change
- D = size of unit mass      K = Constant      n = constant
- For
- **n = 1.0** Walker equation becomes Kick's theory
- It is used for coarse particles > 1 um.
- **n = 1.5** Walker equation becomes Bond's theory.
- This theory is used when neither Kick's nor Rittinger's law is applicable.
- **n = 2.0** Walker equation becomes Rittinger's theory
- Used for fine particles < 1 um size.



# **VARIOUS EQUIPMENTS USE IN SIZE REDUCTION**



## Hammer mill:

**Principal:** Material is impact b/w rapidly moving hammers on a rotor & the powder material

**Uses:** it is used to mill dry materials, wet filter press cakes, ointments, slurries etc. Brittle material is best fractured by impact from blunt hammers; fibrous material is best reduced in size by cutting edges.

**Variants:** Stocks tornado mill, Fitzpatrick comminuting machine (Fitz mill), Micropulvelizer, hammer crusher etc.

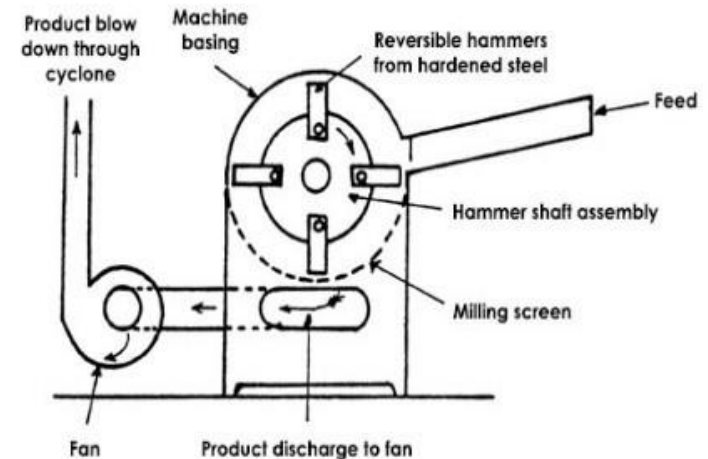

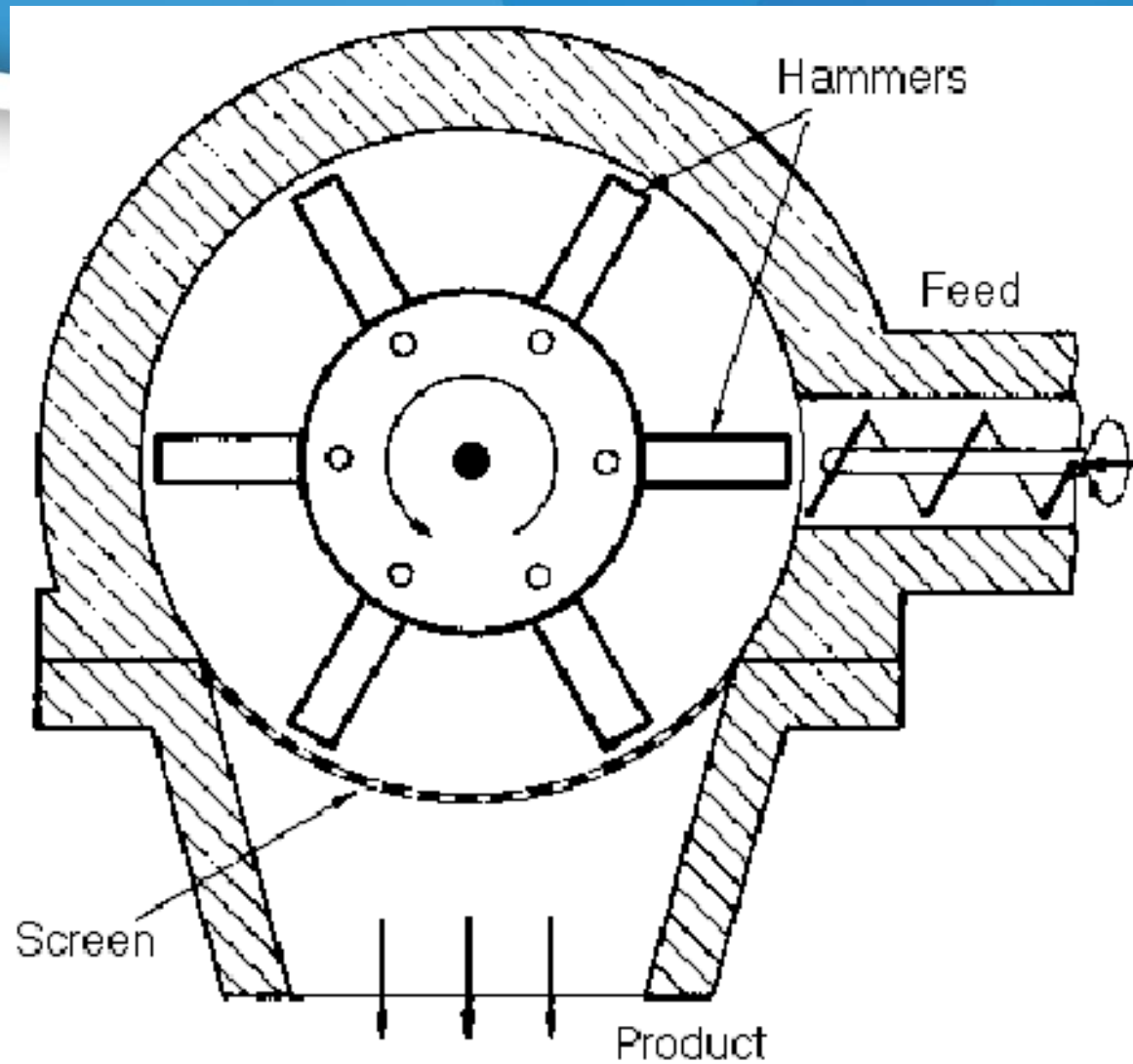
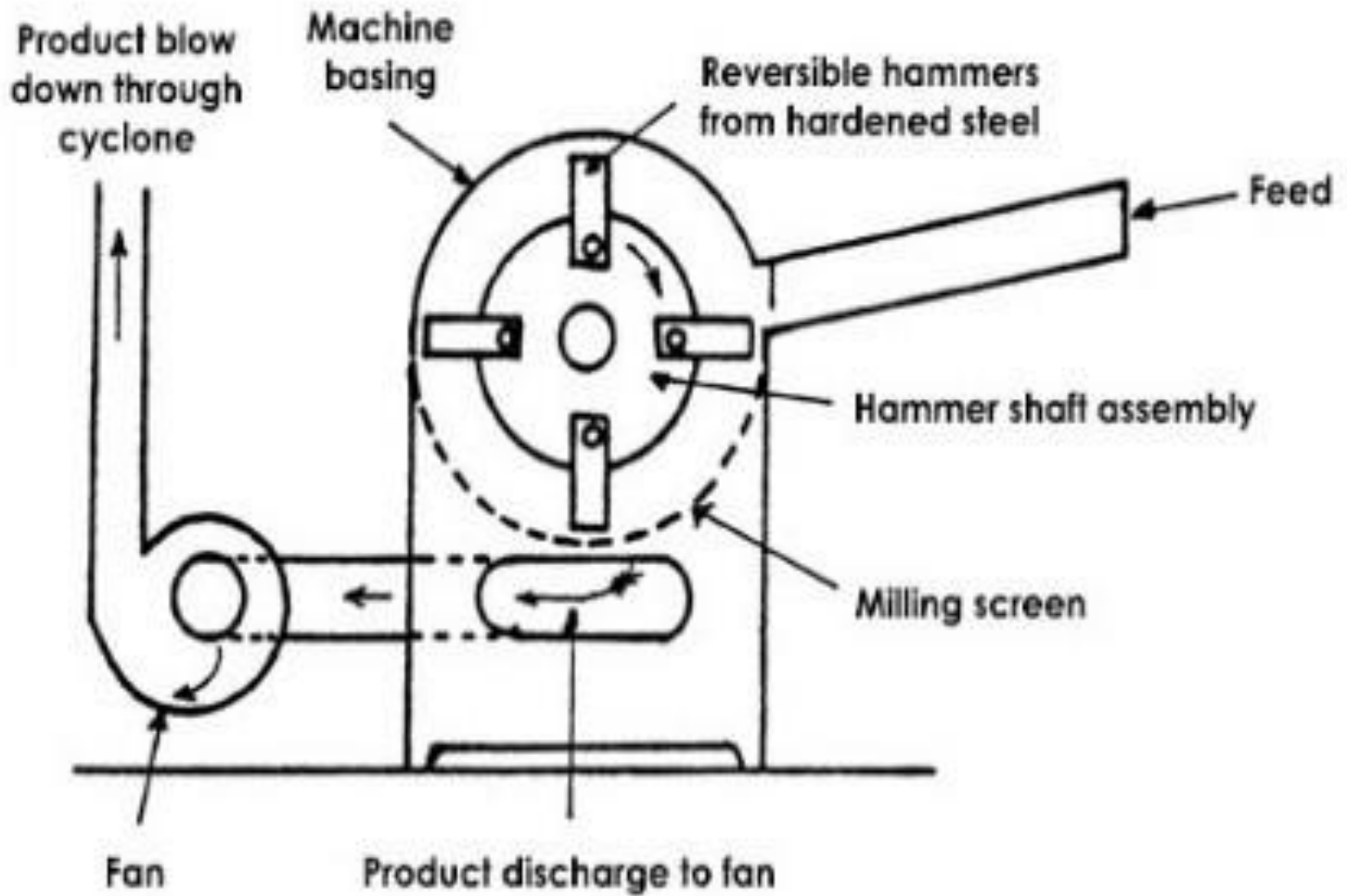

Fig. Hammer Mill





# HAMMER MILL



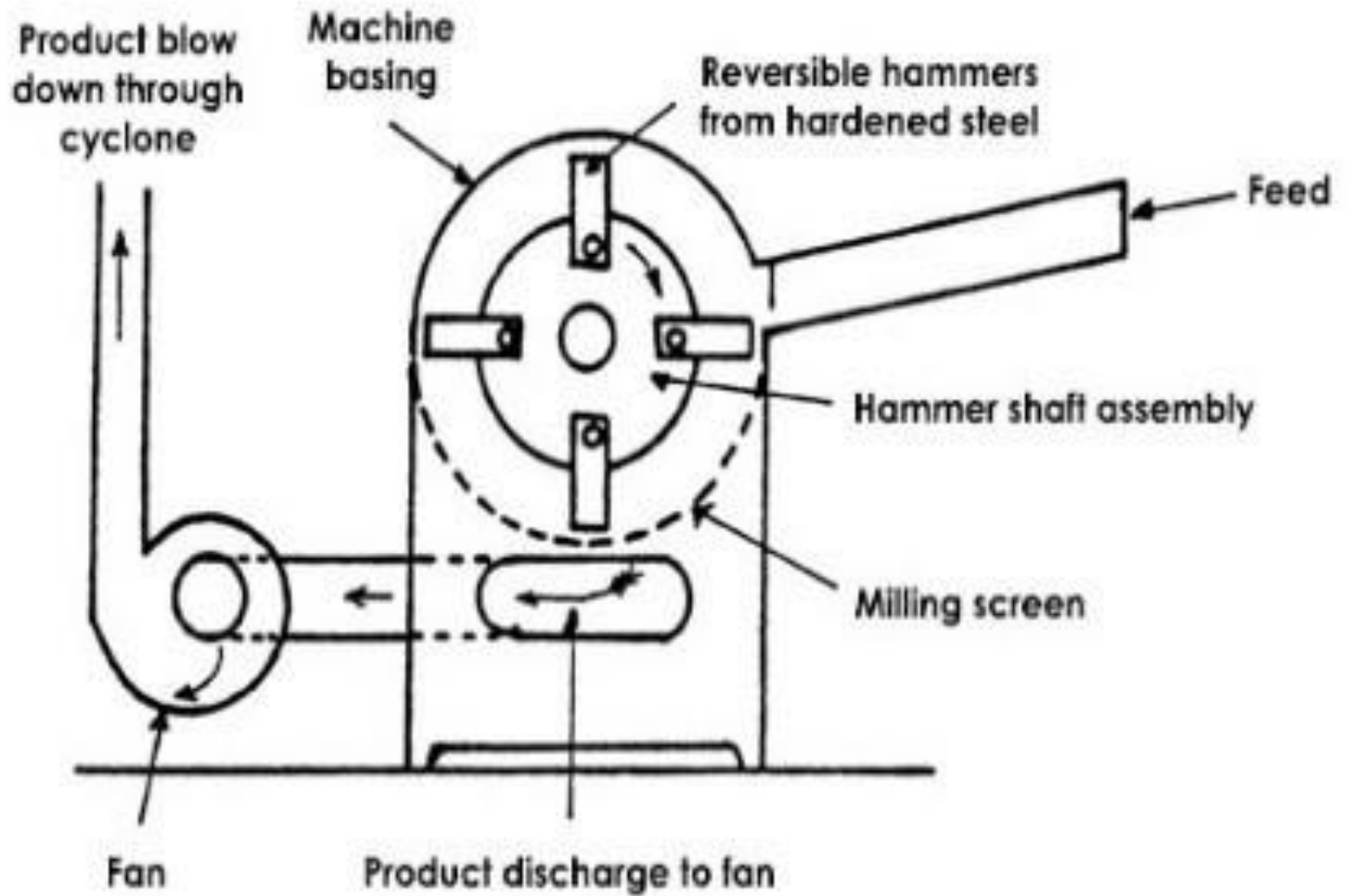

# ADVANTAGES OF HAMMER MILL



- It is rapid in action, and is capable of grinding many different types of materials.
- They are easy to install and operate, the operation is continuous.
- There is little contamination of the product with metal abraded from the mill as no surface move against each other.
- The particle size of the material to be reduced can be easily controlled by changing the speed of the rotor, hammer type, shape and size of the screen.

# DISADVANTAGES



- **Heat buildup during milling is more, therefore, product degradation is possible.**
- **Hammer mills cannot be employed to mill sticky, fibrous and hard materials.**
- **The screens may get clogged. Wearing of mill and screen is more with abrasive materials.**

# BALL MILL



- These are also known as tumbling mills.
- **Principle:** The ball mill works on the principle of impact between the rapidly moving balls and the powder material, both enclosed in a hollow cylinder.
- At low speeds, the balls roll over each other and attrition (rubbing action) will be the predominant mode of action. Thus, in the ball mill, impact or attrition or both are responsible for the size reduction.



Rotating direction of mill

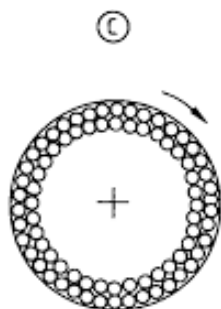
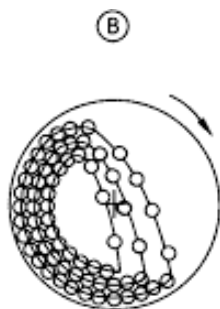
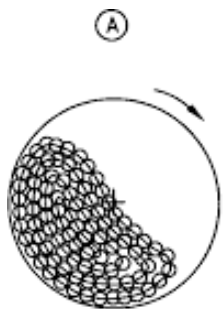
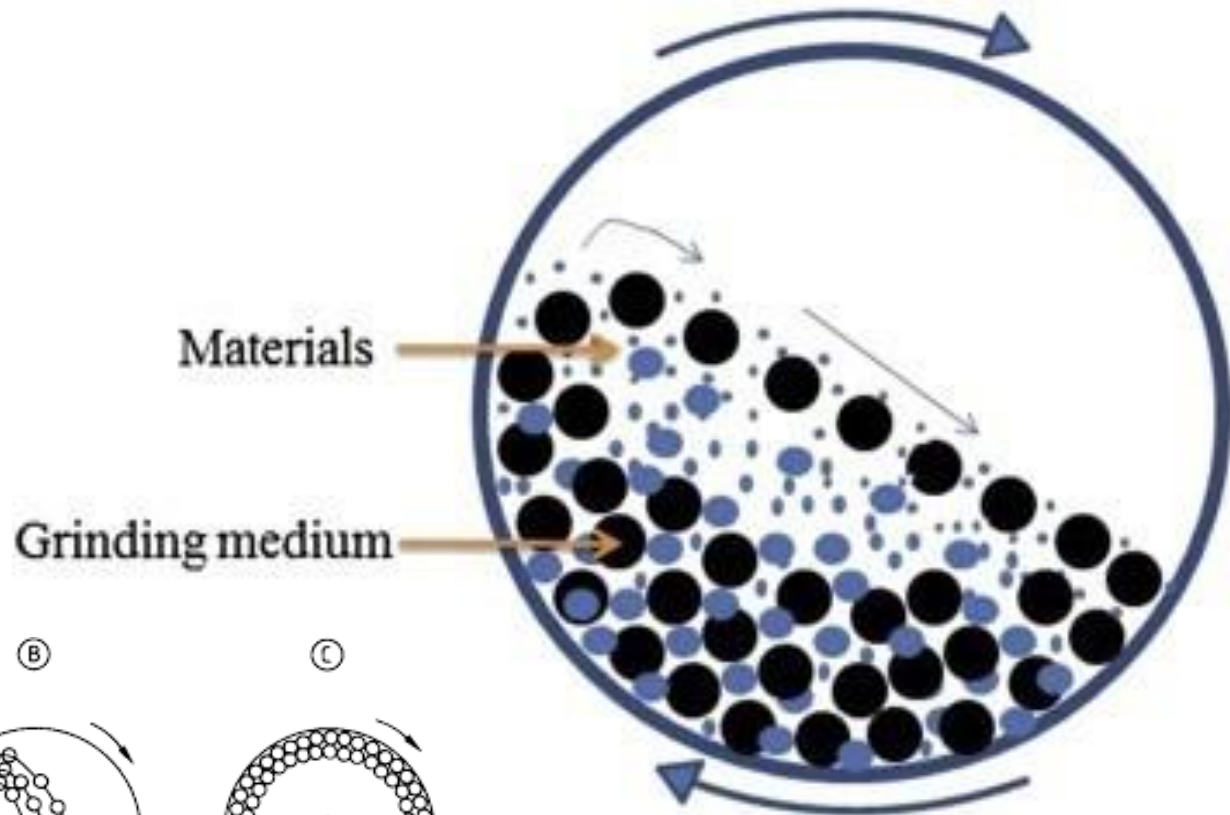

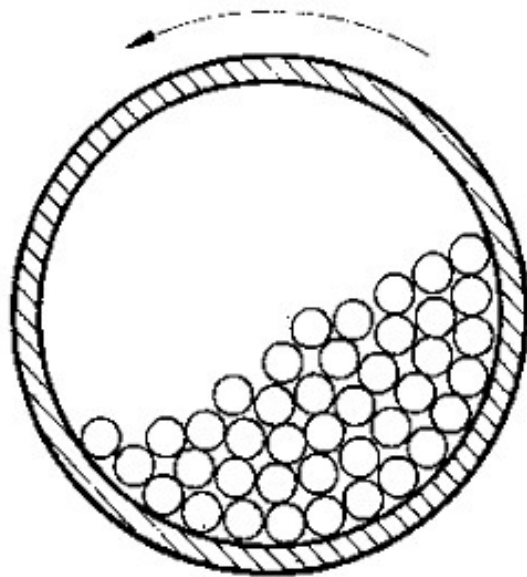

(a) Low speed with sliding

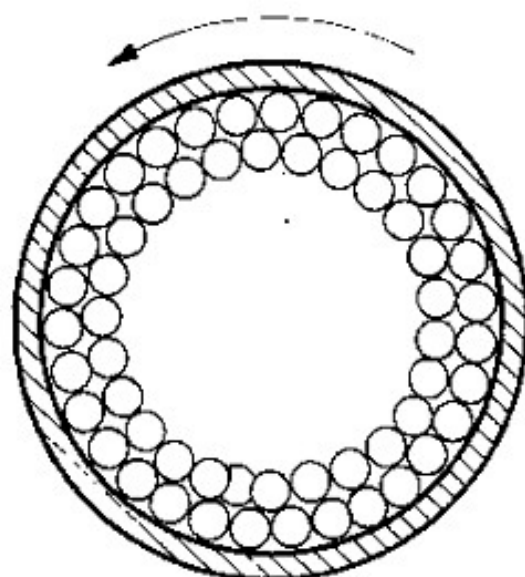

(b) High speed with centrifuging

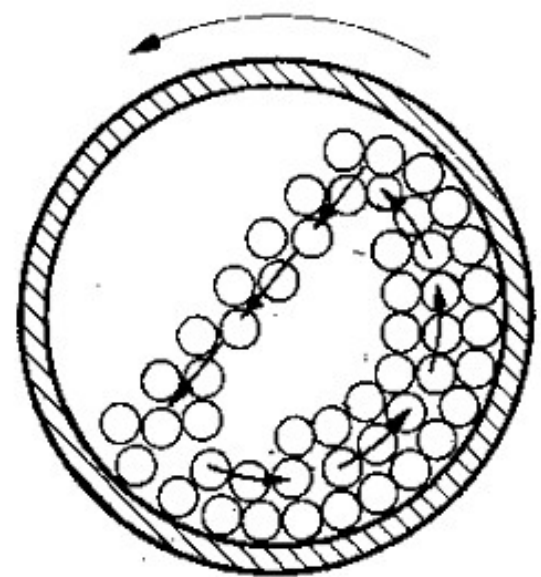

(c) Correct speed with cascading

Fig. Ball mill operation

**Uses:** Ball mill at low speed is used for milling dyes, pigments & insecticides. Stainless steel balls are preferred in the production of ophthalmic & parental products.

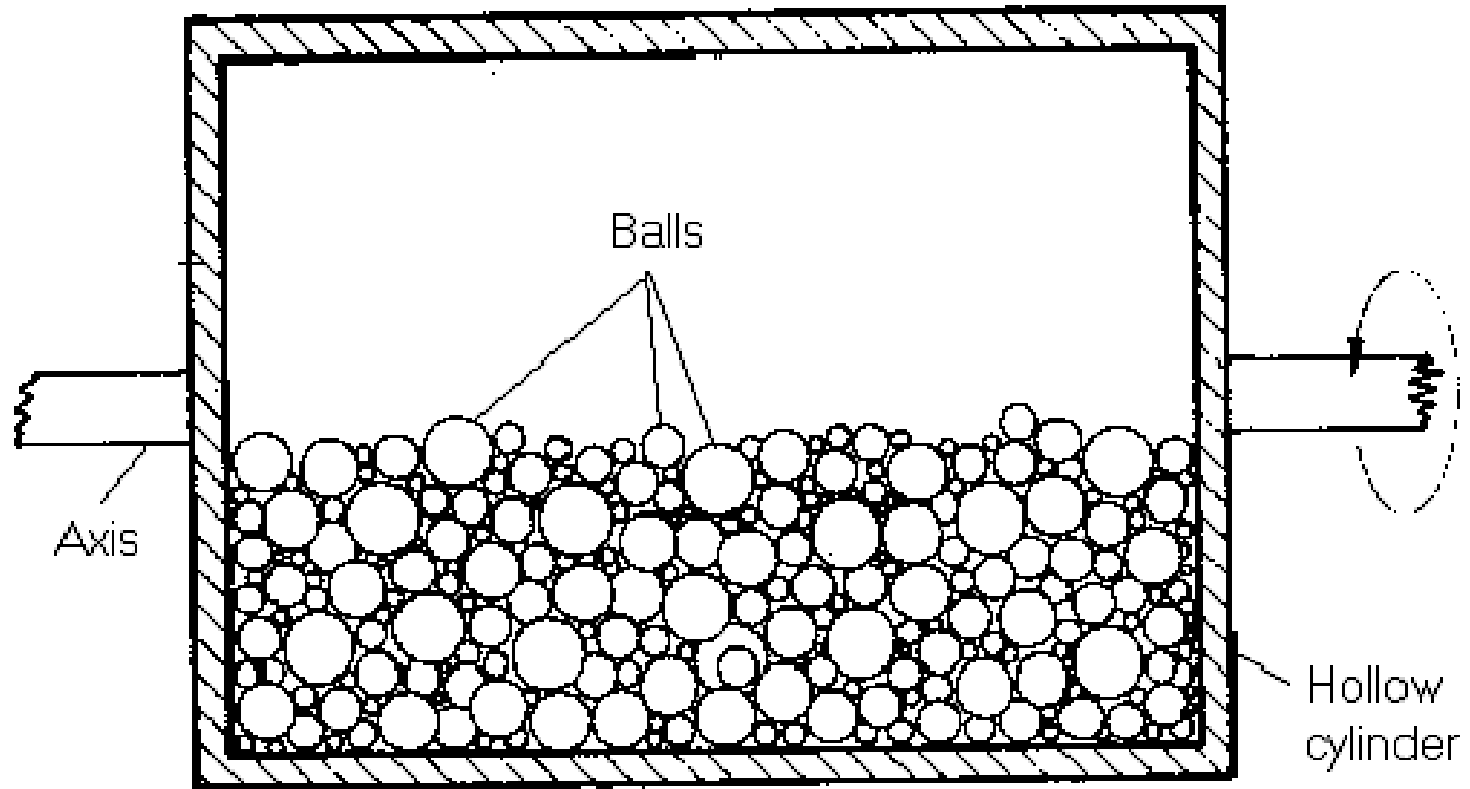

Fig. Ball mill



# Advantages:



- It can produce **very fine powder**.
- Ball mill is used for both **wet and dry grinding** processes.
- **Toxic substances** can be ground, as the cylinder is closed system.
- **Rod or bars** can also be used as grinding media.
- (example: **Sticky material** are size reduced) In ball mill,
- installation, operation and labour costs are **low**.

# Disadvantages:



- The ball mill is a **very noisy** machine.
- Ball mill is a **slow process**.
- **Soft, tacky, fibrous material** cannot be milled by ball mill.



# Ball mill or Pebble mill or Tumbling mill:

## Variants:

- Hardinge mill
- Continuous ball mill
- Vibrating ball mill



## Fluid energy mill or Jet mill or Microfibers or Ultrafine grinder:

**Principal:** Material reduced in the size by attrition & impact. The feed stock is suspended within a high velocity air stream. Milling takes place because of high velocity collision b/w the suspended particles.

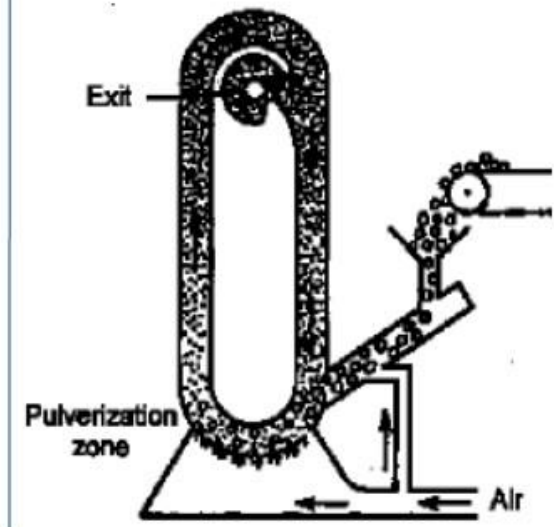

**Uses:** It is used for to reduce the particle size of antibiotics & vitamins. Moderately hard materials can be processed for size reduction. Ultra fine grinding can be achieved.

**Variants:** Centrifugal- impact pulverizer.

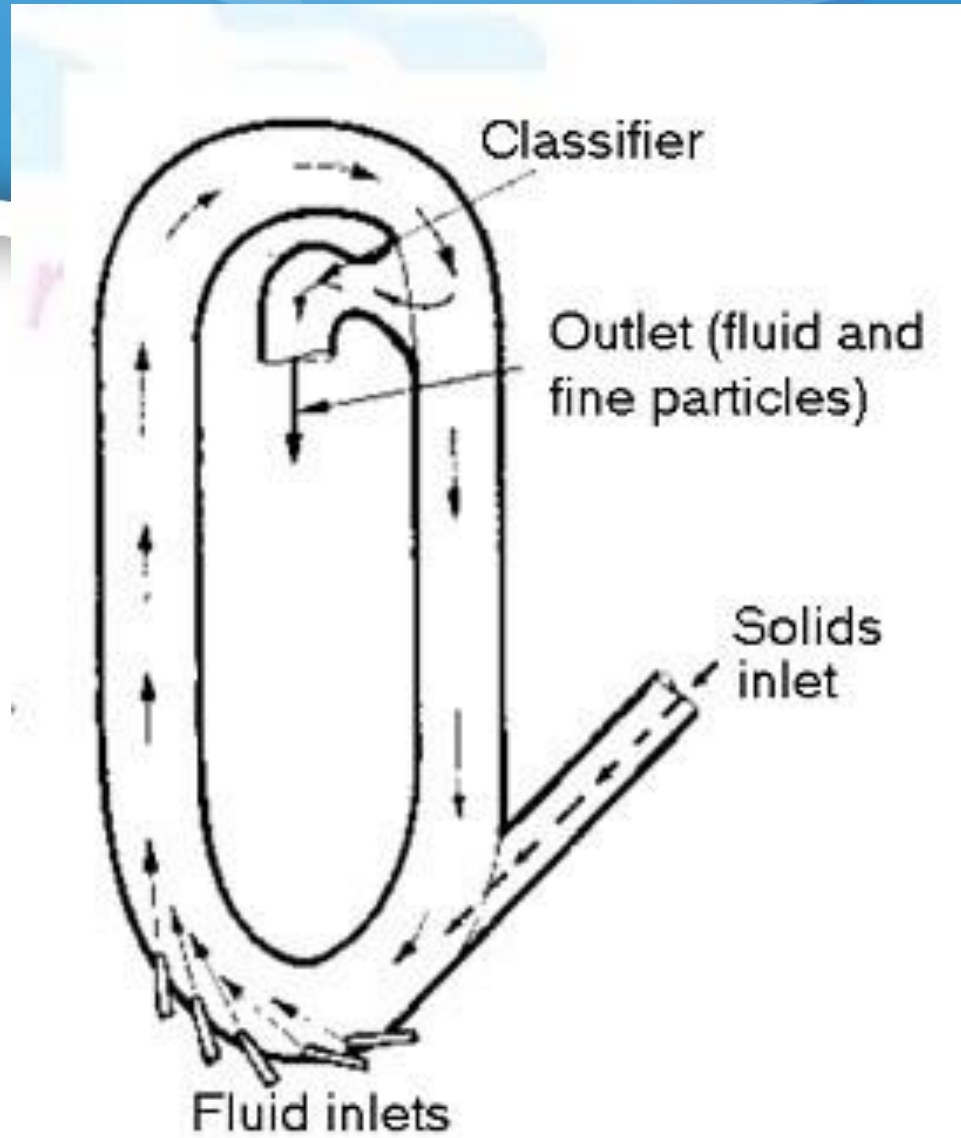
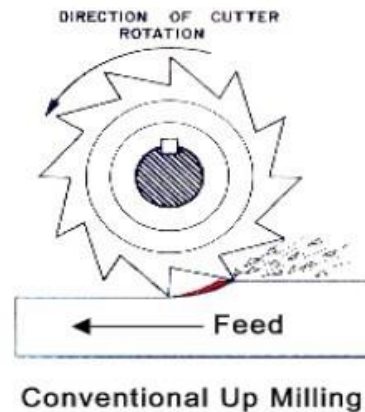

Fig. Fluid energy mill



## Rotary Cutter Mill:



Conventional Up Milling

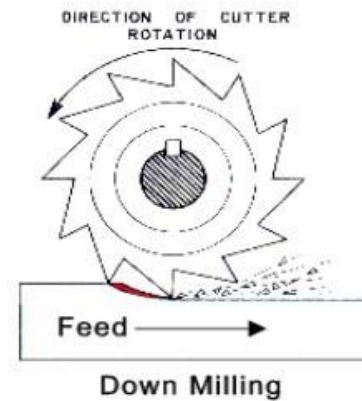

Down Milling

**Principle:** Cutting with sharp knives.

**Use:** Cutter mill is used for size reduction of tough & fibrous material like animal tissues, medicinal plants, plant parts. It is also used in the manufacture of rubber, plastics and plastic material.

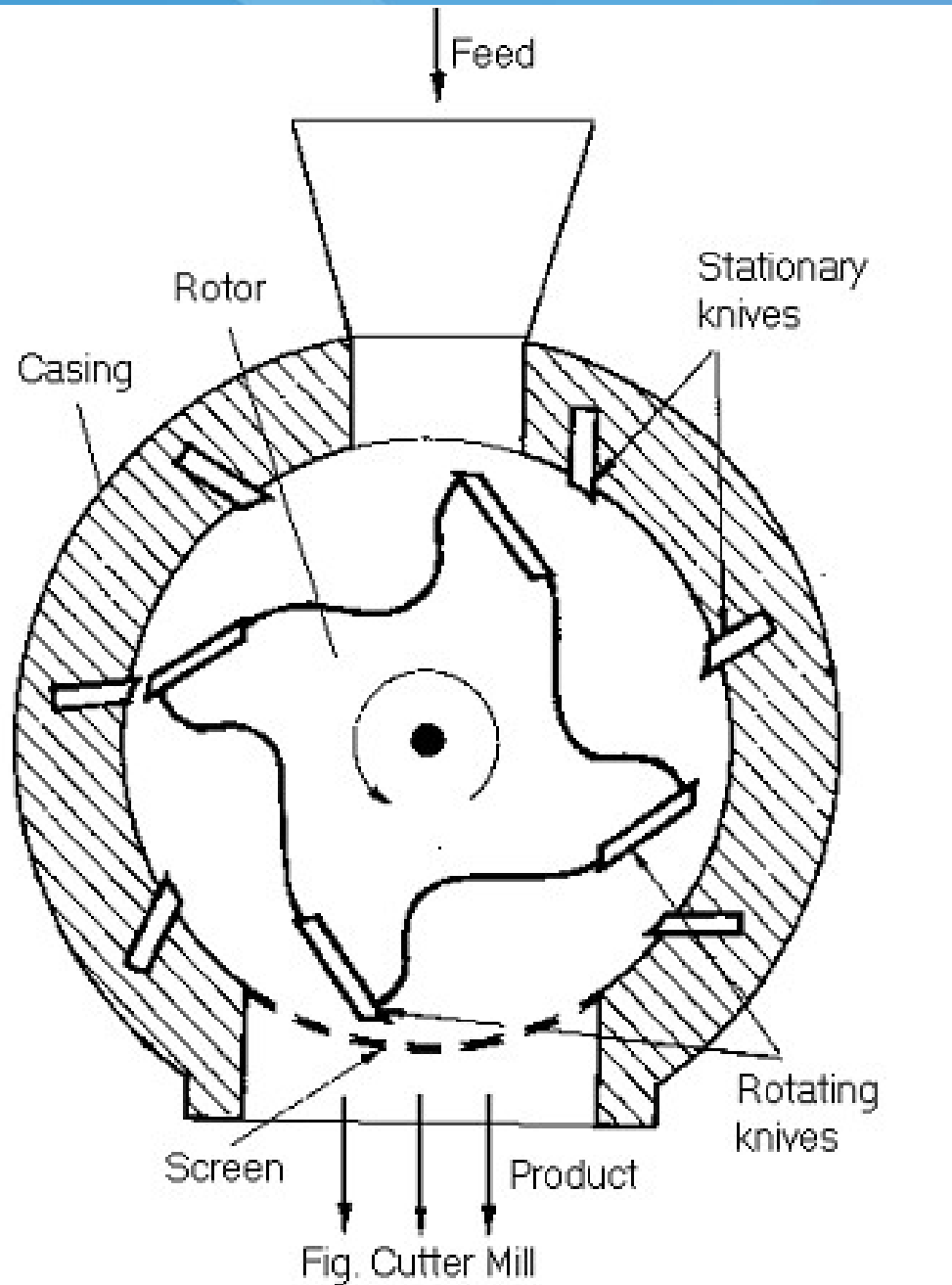

# ROLLER MILL



**Principal:** Material is crushed by the application of stress. Stress is applied by rotating heavy wheels, mullers or rollers.

**Uses:** for crushing seeds before extraction of fixed oil. Also used to crush soft tissue to help in penetration of solvents.

**Variants:** Multiple smooth rollers or corrugated, ribbed, or saw-toothed rollers can provide cutting action also



# ROLLER MILL

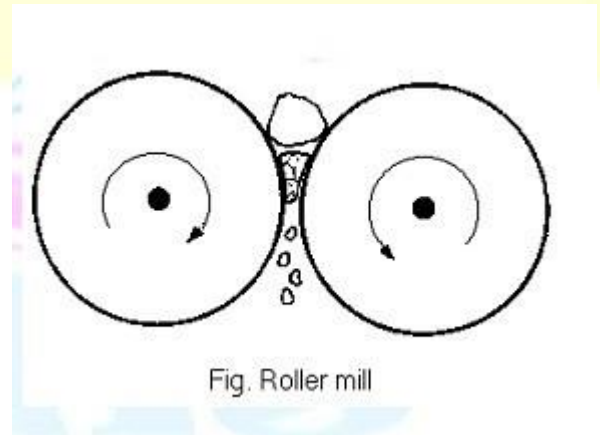
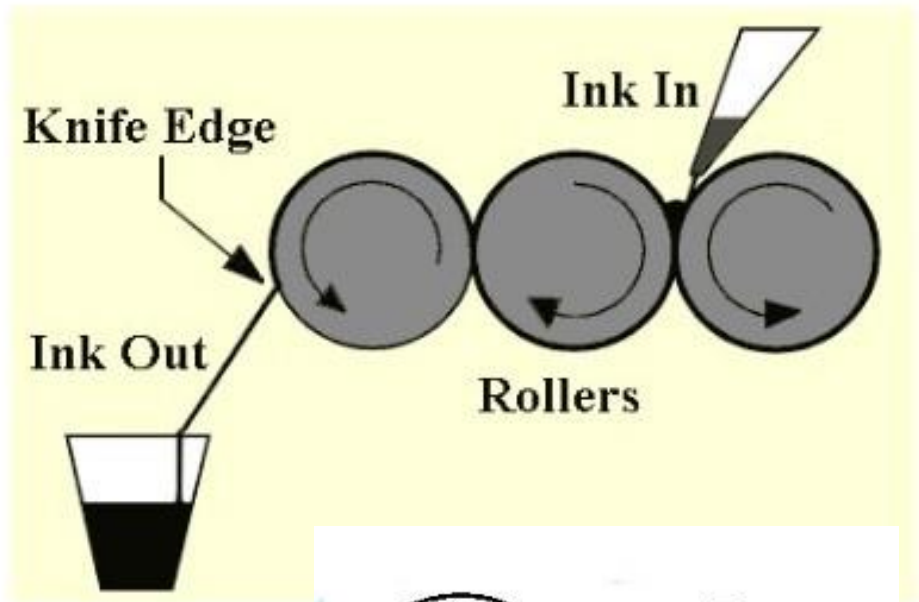
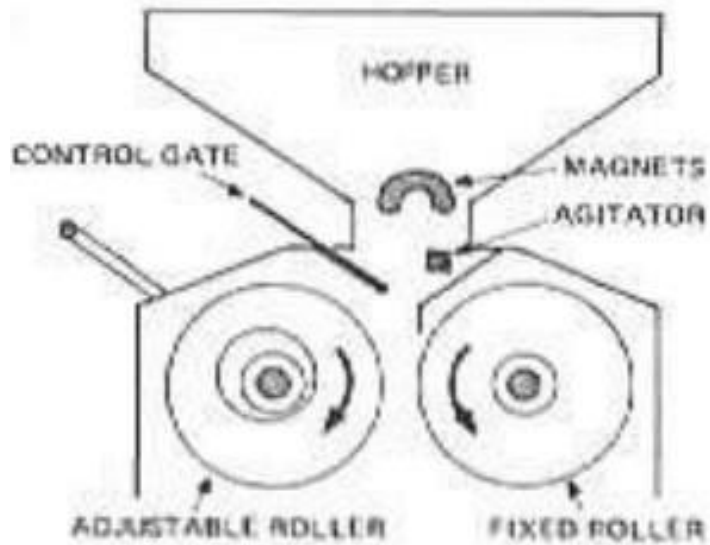

# ROLLER MILL





## Colloid mill:

**Principal:** Colloidal mill consists of two steel discs having clearance b/w them. When the material is passed through these discs, they get sheared. Thus coarse particles are broken down in small particles due to shear.

**Uses:** Colloidal mill is used for preparing colloidal dispersion, suspension, emulsion & ointments. It is used for dry milling. Fibrous material can be milled using rough surface rotor & stator.

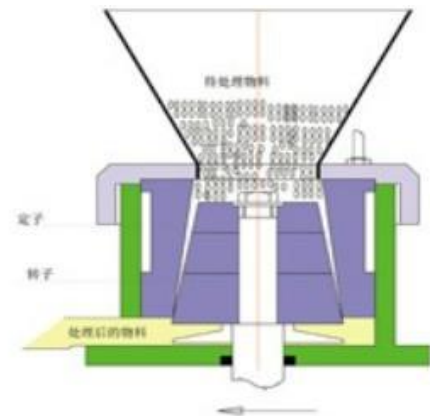

# Colloidal Mill

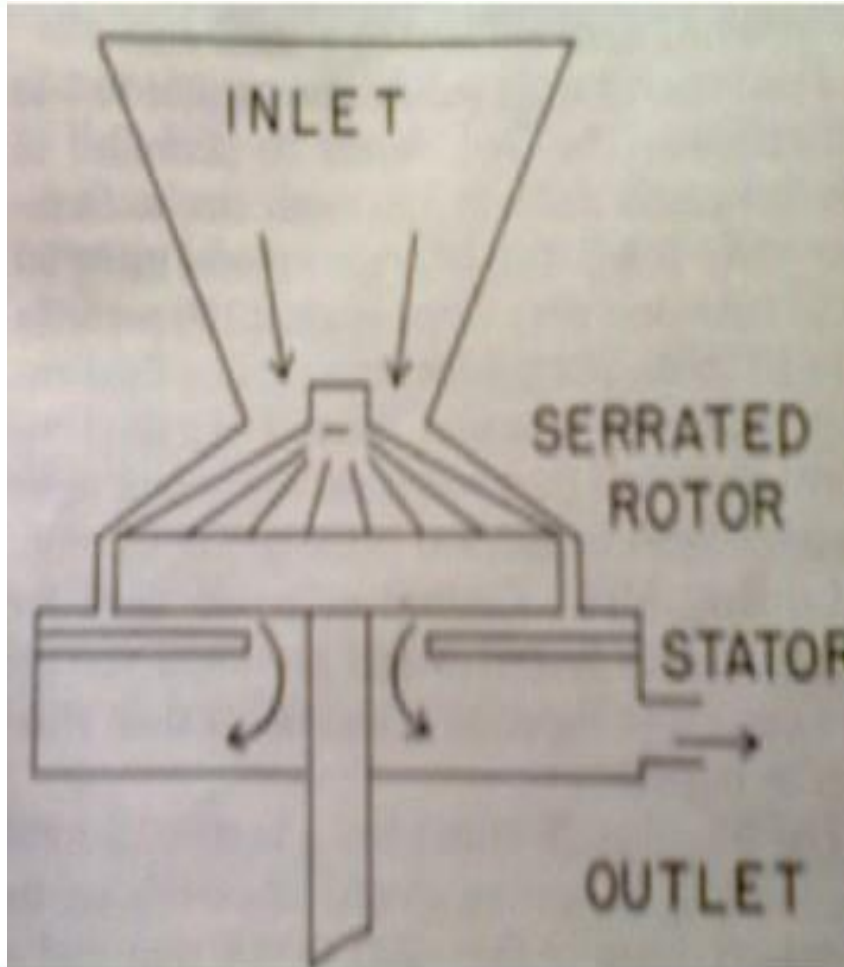



## Edge runner mill:

**Principal:** Size reduction is done by crushing due to heavy weight of stone. Shearing force is also involved during the movement of stones.



**Uses:** Edge runner mill is used for grinding tough materials to fine powder. It is still used for plant-based products.



## End runner mill:

**Principal:** Size reduction is done by crushing due to heavy weight of steel pestle. Shearing force is also involved during the movement of mortar & pestle.

**Uses:** End runner mill is used for grinding tough materials to fine powder. It is suitable for fine grinding.



