



---

# SIZING HANDBOOK & APPLICATION GUIDE

---

## **GAS VENT AND CHIMNEY PRODUCTS FOR CAPACITIES TO 100 MILLION BTU PER HOUR**

2001 Revision Including Tables For  
Fan-Assisted Combustion Appliances



### **WARNING**

Failure to follow the installation instructions could cause  
FIRE, CARBON MONOXIDE POISONING, OR DEATH. If you  
are unsure of installation requirements, call the phone  
number listed on the instructions or Sizing Handbook.

# CONTENTS

---

## FOREWORD

APPLICATION

MAXIMUM AND MINIMUM CAPACITIES

SELKIRK PRODUCT INFORMATION

## SECTION 1

INDIVIDUAL VENT TABLE

- 1-1 Definitions
- 1-2 Procedure for Using the Individual Vent Table
- 1-3 Example 1, Vent for a FAN-Assisted Appliance
- 1-4 Vent Size Reductions
- 1-5 Vertical Vents
- 1-6 Additional Important Information

## SECTION 2

COMBINED VENT TABLES

- 2-1 Definitions
- 2-2 Headings in the Combined Vent Tables
- 2-3 General Procedure
- 2-4 Procedure to Find Each Connector Size
- 2-5 Procedure to Find Common Vent Size
- 2-6 Example of Combined Vent System Design

## SECTION 3

GENERAL RULES

- 3-1 Applicability to Selkirk Products
- 3-2 Types of Gas-Burning Appliances
- 3-3 Appliance Operation and Venting Principles
- 3-4 Prohibited Applications of Tables
- 3-5 National and Local Building Codes
- 3-6 Correction for Altitude
- 3-7 Freedom From Connector Restrictions
- 3-8 Single Wall Connector Operating Problems
- 3-9 Cautions in Draft Hood Installation
- 3-10 Types of Rain Cap or Termination
- 3-11 Location of Rain Cap
- 3-12 Use of the Chimney for Gas Venting
- 3-13 Outdoor Vents for Indoor Appliances
- 3-14 Vent Damper Effects
- 3-15 Pilot Burner and Priming Effects
- 3-16 Fuel Gas Types

## SECTION 4

INDIVIDUAL VENTING

- 4-1 Appliance Types, Special Considerations
- 4-2 Minimum Vent Height
- 4-3 Avoiding Condensation
- 4-4 Compensating for Extra Elbows
- 4-5 In-Between Heights (interpolation)
- 4-6 The Ideal Vent

## SECTION 5

CONNECTORS FOR COMBINED VENT SYSTEMS

- 5-1 General Considerations
- 5-2 A Functional Definition for the Connector
- 5-3 Connector Length and Capacity
- 5-4 Connector Rise Estimation
- 5-5 Importance of Connector Rise
- 5-6 Connector Turn Limits: Elbows and Tees
- 5-7 Connector Size Combinations
- 5-8 Choices for Connector Configuration
- 5-9 Use Available Headroom for Best Operation
- 5-10 When in Doubt Use Larger Connector
- 5-11 Self-Venting Connectors

## SECTION 6

COMMON VENTS

- 6-1 Appliances Which Can Use Common Vents
- 6-2 Appliances Which Cannot Use Common Vents
- 6-3 Common Vent Interconnection Fittings
- 6-4 Size Choices for the Common Vent
- 6-5 Offsets in Common Vents
- 6-6 Common Vent Manifolds
- 6-7 Manifold Length
- 6-8 Manifold Size and Capacity
- 6-9 Connectors to a Manifold
- 6-10 Sloped vs. Horizontal Manifolds
- 6-11 Tapered or Constant Size Manifolds
- 6-12 Number of Manifoldded Appliances
- 6-13 Single Appliances with Two or More Draft Hoods or Flue Outlets
- 6-14 Beware of Alternate Sizing Rules

# CONTENTS

---

## SECTION 7

### MULTI-STORY VENTING

- 7-1 General
- 7-2 Indirect Appliances Only
- 7-3 Excluded Appliances: Direct Types
- 7-4 Fundamental Design Principles
- 7-5 Separation from Occupied Spaces
- 7-6 Air Supply Functions and Sources
- 7-7 Air Supply Methods and Details
- 7-8 Common Vent Location
- 7-9 Applying Combined Vent Tables to Multi-Story Systems
- 7-10 Example of Multi-Story Vent Design
- 7-11 Some Important Precautions
- 7-12 Number of Connections to Multi-Story Vents
- 7-13 Parallel Systems

## SECTION 8

### PROVIDING AIR SUPPLY

- 8-1 Air Supply Opening Location
- 8-2 Area of Ducts or Openings

## SECTION 9

### MECHANICAL DRAFT AND POWER VENTING

- 9-1 Equipment with Burner Inlet Fan or Blower
- 9-2 Induced Draft Equipment
- 9-3 Forced or Induced Draft Venting
- 9-4 Uses of Auxiliary Draft Equipment
- 9-5 Product Applications with Mechanical Draft
- 9-6 Selection of Mechanical Draft Equipment

## SECTION 10

### CAPACITIES THROUGH 48" DIAMETER

- 10-1 Individual Gas Vent Graph
- 10-2 Combined Gas Vent Graph
- 10-3 Chimneys for Equipment Needing Draft
- 10-4 Chimneys for Neutral Draft Equipment
- 10-5 Chimneys Operating at Forced Draft
- 10-6 General Factors for Chimney Sizing Graphs

## SECTION 11

### GENERAL DESIGN METHODS

- 11-1 The Chimney Design Equation
- 11-2 The Chimney Design Chart
- 11-3 Design Chart Recommended Factors
- 11-4 Steps to Use Design Chart, Figure 34, for Sizing
- 11-5 Example Using Design Chart to Find Gas Vent Size

## SECTION 12

### CHECKING VENT SYSTEM OPERATION

- 12-1 Draft Hood Spillage
- 12-2 Appliance Fails to Operate
- 12-3 Cold Backdraft
- 12-4 Hot Backdraft
- 12-5 Gas Leakage at Joints
- 12-6 Condensation Leakage
- 12-7 Gas and Condensate Leakage
- 12-8 Summary: The Trouble-Shooting Table

## SECTION 13

### CHIMNEYS FOR CONVENTIONAL FIREPLACES

## SECTION 14

### RELINING MASONRY CHIMNEYS

- 14-1 Options for Relining
- 14-2 Sizing Guidelines

# FIGURES

<b>FIGURE</b>		<b>SEC. REF.</b>
<b>1</b>	Individual Vent - Lateral and Height .....	<b>1-2</b>
<b>2</b>	Example of Individual Vent Dimensions .....	<b>1-3</b>
<b>3</b>	Combined Vent Dimensions and Example .....	<b>2-6</b>
<b>4</b>	Rain Cap Location Rules .....	<b>3-11</b>
<b>5</b>	Wall Furnace Vent Height .....	<b>4-2</b>
<b>6</b>	Individual Vent Length Limit Example .....	<b>4-3</b>
<b>7</b>	Connector Length Measurement .....	<b>5-3</b>
<b>8</b>	Connector Rise Measurement .....	<b>5-4</b>
<b>9</b>	Benefit of Greater Connector Rise .....	<b>5-5</b>
<b>10</b>	Connector Turn Examples .....	<b>5-6</b>
<b>11</b>	Size Combinations Allowed .....	<b>5-7</b>
<b>12</b>	Connector Direction Choices .....	<b>5-8</b>
<b>13</b>	Use Connector Rise Effectively .....	<b>5-9</b>
<b>14</b>	Relocate Rain Caps or Tee .....	<b>5-4</b>
<b>15</b>	Individual Vents Preferred .....	<b>6</b>
<b>16</b>	Proper Tee Size for Interconnection .....	<b>6-3</b>
<b>17</b>	Common Vent Offset and Manifold .....	<b>6-5</b>
<b>18</b>	Sloped vs. Horizontal Manifolds .....	<b>6-10</b>
<b>19</b>	Tapered or Constant Size Manifold .....	<b>6-11</b>
<b>20</b>	Separation of Air Supply for Multi-Story Venting .....	<b>7-5</b>
<b>21</b>	Outside Wall Air Supply for Multi-Story Venting .....	<b>7-7</b>
<b>22</b>	System Segment for Multi-Story Vent Design .....	<b>7-9</b>
<b>23</b>	Complete Multi-Story Vent System .....	<b>7-9</b>
<b>24</b>	Air Supply Methods Illustrated .....	<b>8-1</b>
<b>25</b>	Draft Conditions with Equipment Burner-Inlet Blower .....	<b>9-1</b>
<b>26</b>	Draft Conditions with Equipment Outlet Blower .....	<b>9-2</b>
<b>27</b>	System with Both Induced and Forced Draft .....	<b>9-3</b>
<b>28</b>	Induced Draft System for Manifolded Draft Hood Gas Appliances .....	<b>9-3</b>
<b>29</b>	Individual Vent Capacities Through 48" Size .....	<b>10-1</b>
<b>30</b>	Combined Vent Capacities Through 48" Size .....	<b>10-2</b>
<b>31</b>	Chimney Sizes for Appliances Needing Draft .....	<b>10-3</b>
<b>32</b>	Chimney Sizes for Neutral Draft Equipment .....	<b>10-4</b>
<b>33</b>	Chimney Sizes for Forced Draft Equipment .....	<b>10-5</b>
<b>34</b>	General Chimney Design Chart .....	<b>11</b>
<b>35</b>	Example of Manifolded Gas Vent .....	<b>11-5</b>
<b>36</b>	Solution to Manifolded Gas Appliance Example .....	<b>11-5</b>
<b>37</b>	Checking for Draft Hood Spillage .....	<b>12-1</b>
<b>38</b>	Chimney Sizing Chart for Fireplaces .....	<b>13</b>

# FOREWARD

---

## APPLICATION

This updated version of the Selkirk Sizing Handbook features tables of maximum input capacity rating for fan-assisted combustion Category I appliances, as well as those for draft hood appliances. Both individual and combined vents are included. In addition, the tables include minimum capacity values for fan-assisted combustion Category I appliances. Both the maximum and minimum values of capacity for fan-assisted appliances were calculated by Battelle Institute, using their VENT II computer program. This program was developed under the direction of the Gas Research Institute and applies to a wide variety of gas venting situations.

For draft hood appliances, input capacity ratings for all-Selkirk gas vents have not changed from previous Handbook editions and are the same as those in the National Fuel Gas Code. Formats of some of the tables have changed from previous editions of the Handbook to permit inclusion of limits for the two types of appliances. Also, headings of columns, increments of lateral lengths, and other details differ somewhat. Regardless of these changes, the fact remains that the maximum capacity ratings of Type B gas vents for draft hood appliances have stood the test of time since their first publication in the Handbook in 1961. Also, despite any changes in this edition, all previous versions of the Handbook are completely applicable to the venting of draft hood appliances. Comments applicable to fan-assisted appliances and to Categories II, III, and IV are superseded by the information in this edition.

Both draft hood and fan-assisted combustion appliances may be "listed" as Category I gas-burning equipment. The categorization process for residential gas furnaces and boilers now in effect is one part of the effort to provide venting provisions which match appliance operating features. Some important definitions are as follows:

- A Category I gas appliance may be defined as: "A non-condensing gas appliance that operates with a non-positive vent pressure."
- A fan-assisted combustion appliance is one which has a fan-assisted burner.
- A fan-assisted burner is defined as: "A burner which uses either induced or forced draft."
- A draft hood appliance can only be Category I appliance, while an appliance with a fan-assisted burner may fall into any of the four Categories; I, II, III, or IV.

The input capacity tables in this Sizing Handbook are for Category I fan-assisted, or for draft hood equipped appliances, or for vents for combinations of these two types. These tables also apply to any appliance for which Category I venting is permissible, even if the appliance may also be vented to operate under Category III conditions (such as horizontally through a wall).

For additional clarification, the other three appliance categories may be

defined as:

- Category II - "A condensing gas appliance that operates with a non-positive vent pressure."
- Category III - "A non-condensing gas appliance that operates with a positive vent pressure."
- Category IV - "A condensing gas appliance that operates with a positive vent pressure."

The category in which to place a fan-assisted combustion appliance is determined by tests in accordance with its test standard. For furnaces in Categories I and III the steady state efficiency (output divided by input) must be 83 percent or less. This is to be determined from the relationship between net flue gas temperature (rise above ambient) and flue gas composition (% CO<sub>2</sub>).

An appliance operating at a steady state efficiency over 83 percent may be placed in Category II or IV depending on its flue gas outlet pressure.

## For further clarification:

A non-condensing appliance is one in which, under continuous operation, there will be no water collected internally or in the vent.

A condensing appliance is one in which, during continuous operation, water may collect within the appliance or in the vent.

Pressure in the vent will be non-positive if the vent is able to operate by natural or gravity draft, but will be positive if the fan or burner produces additional vent pressure to cause flow.

Positive pressure also means that the internal static flue gas pressure is greater than atmospheric. In such systems, the vent joints must be sealed to prevent leakage.

Venting instructions furnished by a Category I appliance manufacturer should contain the same tables as furnished here, or should refer to the Gas Appliance Manufacturers' Association Tables, or to the National Fuel Gas Code. Venting instructions for appliances which fall into Category II, III, or IV should be specific to those appliances and should not show or allow the use of Type B gas vents.

The primary aim of this Sizing Handbook is to provide more detailed guidance on gas appliance venting than can be found in the codes or in appliance manufacturers' instructions. It is intended for the convenience and assistance of heating contractors, building inspectors, architects, engineers, and others concerned with the correct installation and configuration of Selkirk venting products for fuel burning equipment.

The first seven sections of this Handbook are applicable to gas-burning Category I equipment. Sections 1 and 2 provide tabulation of maximum inputs for both draft hood and fan-assisted equipment, as well as minimum inputs applicable only to fan-assisted equipment. Sizes from 3" to 24" diameter are covered with allowances for height and lateral length, as well as connector rise and operating combinations for combined vents.

**Sections 3 through 8** contain added important details on venting functions and the differences between draft hood and fan-assisted appliances as inlets or gas sources for the vent system. Rain cap locations, applications to other appliance types, connector limitations, manifolding, multi-story venting, and air supply are also discussed.

**Section 10** enhances the utility of this Handbook with graphs for capacities through 48" diameters for both gas vents and chimneys. Five specific graphs are provided which apply to selected draft hood and direct connected (non-draft hood) appliances burning gas, oil, or solid fuel. The Chimney Design Equation in Section 11 provides the basis for the general design method. Its application is illustrated with a detailed example.

**Section 12** discusses a method for checking vent operation and covers a variety of possible venting malfunctions with draft hood and fan-assisted combustion appliances.

**Section 13** provides chimney sizing guidelines data for conventional open front solid fuel-burning fireplaces, relating the chimney size and height to the fireplace frontal opening area.

The Selkirk Sizing Handbook is an appropriate "Approved Method" of vent design and sizing as defined in national standards, such as the National Fuel Gas Code ANSI Z223.1, NFPA 54, or ANSI/NFPA 211 Chimneys, Fireplaces, Vents, and Solid Fuel-Burning Appliances.

The National Fuel Gas Code contains several provisions enabling the use of these tables. Vents designed by application of these tables will satisfy paragraph 7.3.1, which reads:

**7.3.1 Minimum Safe Performance:** A venting system shall be designed and constructed so as to develop a positive flow adequate to remove flue or vent gases to the outside atmosphere.

**7.3.2 Equipment Draft Requirements:** A venting system shall satisfy the draft requirements of the equipment in accordance with the manufacturer's instructions.

**7.6.3 Size of Gas Vents:** Venting systems shall be sized and constructed in accordance with chapter 10 or other approved engineering methods\* and the gas vent and gas equipment manufacturer's instructions.

\* Reference may also be made to the chapter on chimney, gas vent, and fireplace systems of the "Equipment" Volume of the ASHRAE Handbook. (Chart 6 given in Part III of this Handbook is taken from Chapter 26 of the ASHRAE Handbook.)

The word "approved" as used in 7.6.3 means "acceptable to the authority having jurisdiction." This authority, usually the building official or inspector, has the right to apply and enforce the local building code, or a national venting code if it has been adopted, or appropriate manufacturers' instructions

(equipment or venting). Every effort has been made in the development of this edition of the Handbook to assure that the recommendations herein are consistent with National Codes and thus qualify for acceptance as "approved engineering methods."

## Maximum and Minimum Capacities

While the concept of maximum vent capacity has been known since the inception of venting theory, the parallel limit of minimum capacity based on limiting condensation has been dormant for many years. The earliest edition of capacity tables for Selkirk vents, published in 1955, contained tables with configuration limits based on both maximum and minimum limits. The next edition in 1956 tabulated specific maximum and minimum input ratings for individual Type B gas vents.

The concept of maximum and minimum limits was introduced in 1952 by Alan Kinhead in a pioneer theoretical paper "Operating Characteristics of a Gas Vent," published in the Proceedings of the Pacific Coast Gas Association of that year. Kinhead's work, backed up by extensive laboratory testing, showed that single wall materials required much higher heat inputs to prevent condensation in the vent than was needed for double wall Type B gas vents. The lowest input usable to avoid condensation became the minimum. Maximum capacity was defined as the highest input rating allowed for a draft hood appliance served by a specific configuration of vent. This is the input above which draft hood spillage may begin.

Experience in the field soon showed that tabulated minimum input capacities were of little interest due to a lack of problems with vent condensation in Type B gas vents. The following edition of the Selkirk Gas Vent Tables published in 1961 had a new format for individual vent capacities, dropping all minimum numbers and relegating mention of potential condensation to a simple paragraph on vent length limits.

Energy conservation desires spurred the development of higher efficiency gas appliances, leading to use of fan-assisted burners and eliminating the draft hood as part of the system. With steady state and annual efficiencies of Category I furnaces topping out at about 83 percent, their vents are exposed to higher concentrations of condensable moisture, as well as lower flue gas temperatures. Extensive theoretical and laboratory evaluation of cyclic operation for these appliances showed that condensation in vent connectors should be minimized (wetttime). Minimum capacity limits for Type B gas vents were developed and are shown in these tables for both individual and combined vents. Base lines for computing both minimum and maximum capacity limits were developed jointly by appliance manufacturers and the research groups. Specific assumptions were selected for factors, such as:

- Appliance efficiency
- Flue gas analysis and temperature
- Ambient indoor and outdoor conditions
- Generalized values for flow coefficients of pipe and fitting
- Generalized values for heat loss of materials

Most of these assumptions may be found in the default values used by the computer program VENT II V4.1.

## PRODUCT INFORMATION

These tables for individual and combined vents apply to size selection and system design for the complete spectrum of Selkirk vent and chimney products, with exceptions as noted in the Application Table below.

APPLICATION TABLE  
FOR CATEGORY I AND DRAFT HOOD APPLIANCES

Model/Individual Vent	APPLIANCE/VENT COMBINATION				
	Combined Vent		NAT + NAT	FAN + NAT	FAN + FAN
	NAT	FAN			
RV Round Gas Vent	OK	OK	OK	OK	OK
Oval Gas Vent	OK	OK	OK	OK	OK
QC Round Gas Vent	OK	OK	OK	OK	OK
All-Fuel Chimney <sup>(1)</sup>	OK	No <sup>(2)</sup>	OK	No <sup>(2)</sup>	No <sup>(2)</sup>
PS & IPS Chimney <sup>(3)</sup>	OK	OK	OK	OK	OK
Model DF Chimney <sup>(4)</sup>	OK	OK	OK	OK	OK
Flexi - Liner <sup>(5)</sup>	OK	OK	OK	OK	OK

Notes

- Where All-Fuel Chimney is used for gas venting, the connectors must be Type B gas vent, RV for example, for the tabulated capacities to apply (Do not oversize Selkirk Chimney for use as gas vent).
- Simulation of All-Fuel Chimney operations with the VENT II Program indicates possible problems with long wettimes and moisture accumulation, when serving fan-assisted appliances.
- Model PS and IPS, because they can be completely pressure-sealed, are suitable for both Category I (non-positive) and Category III (positive pressure) venting.
- Model DF Chimney is for gravity or neutral pressure applications only, however, with its air space construction it performs in the same way and may be used as Type B gas vent.
- Capacity reductions apply; see Section 14.

Capacities given in these tables apply to the double wall Type B gas vents, to Chimney factory-built chimneys when these are used with Type B connectors, and to Model PS/IPS chimneys when the entire system is Model PS/IPS or when Type B connectors are used. These tables are also applicable to equivalent materials having the same flow and heat loss characteristics.

Vents made with materials such as brick, masonry, clay tile and single wall, heavy gauge steel have different flow characteristics and/or higher heat losses than double wall Type B gas vents. These tables do not apply to such materials.

Selection of proper size and configuration of the vent to match appliance rating is important, but it is equally important to read and follow specific installation instructions for all parts of a vent or chimney system. Proper support, clearance to combustibles, joint assembly, and secure attachment of connectors to appliances are all essential to obtaining enduring satisfaction from venting products.

# SECTION 1 INDIVIDUAL VENT TABLE

## 1-1 DEFINITIONS FOR INDIVIDUAL VENTS

An "Individual Vent" is a single independent vent for one appliance. "Total Vent Height" is the vertical distance from the flue collar or draft hood outlet to the lowest discharge opening of the vent termination. "Lateral" is the horizontal distance or offset between the connection to the appliance and the entry to the vertical vent. Figure 1 shows these dimensions for a draft hood (NAT) appliance.

"FAN" in the column headings of the tables applies to fan-assisted combustion appliances in Category I.

"NR" not recommended due to potential for condensate formation and/or pressurization of the venting system.

"NAT" applies to natural draft vents on draft hood appliances.

"NA" not applicable due to physical or geometric constraints.

"MIN" is the minimum heat input based on analysis of cyclic operation intended to prevent excessive condensation.

"MAX" in the case of FAN appliances is the highest input allowed without causing positive pressure at the appliance outlet.

"MAX" for NAT appliances is the highest input allowed to avoid draft hood spillage.

## 1-2 PROCEDURE FOR USING THE INDIVIDUAL VENT TABLE

To determine the proper size for an individual vent, apply the table as follows:

**A.** Determine total vent height and length of lateral, based on appliance and vent location and height to top of vent, as indicated in Figure 1. If gas appliances, such as a furnace, boiler, or water heater, have not been chosen or installed, estimate height beginning at 6' above the floor. For attic or horizontal furnaces, floor furnaces, room heaters, and small boilers, the height location of the draft hood outlet or vent collar should be known.

**B.** Read down the height column to a height equal to or less than the estimated total height.

**C.** Select the horizontal row for the appropriate lateral (L) length.

**D.** Read across to the first column under the type of appliance (FAN or NAT) which shows an appliance input rating equal to or greater than the name plate sea level input rating of the appliance to be vented.

NOTE: For room heaters and floor furnaces with draft hoods, stop at the first NAT value which is equal to or greater than 1.4 times the name plate heat input (refer to paragraph 4.1).



# INDIVIDUAL VENTS - TABLE I

Capacity of Selkirk Gas Vents when connected directly to one appliance. (Not applicable to combined vents.)

		Selkirk Type B Gas Vent Diameter (Inches)																					
		3"			4"			5"			6"			7"			8"			10"			
		Appliance Input Rating In Thousands of Btu Per Hour																					
Height H (ft)	Lateral L (ft)	FAN		NAT	FAN		NAT	FAN		NAT	FAN		NAT	FAN		NAT	FAN		NAT	FAN		NAT	
		Min	Max	Max	Min	Max	Max	Min	Max	Max	Min	Max	Max	Min	Max	Max	Min	Max	Max	Min	Max	Max	
6	0	0	78	46	0	152	86	0	251	141	0	375	205	0	524	285	0	698	370	0	1121	570	
	2	13	51	36	18	97	67	27	157	105	32	232	157	44	321	217	53	425	285	75	675	455	
	4	21	49	34	30	94	64	39	153	103	50	227	153	66	316	211	79	419	279	110	668	445	
	6	25	46	32	36	91	61	47	149	100	59	223	149	78	310	205	93	413	273	128	661	435	
8	0	0	84	50	0	165	94	0	276	155	0	415	235	0	583	320	0	780	415	0	1261	660	
	2	12	57	40	16	109	75	25	178	120	28	263	180	42	365	247	50	483	322	71	770	515	
	5	23	53	38	32	103	71	42	171	115	53	255	173	70	356	237	83	473	313	115	758	503	
	8	28	49	35	39	98	66	51	164	109	64	247	165	84	347	227	99	463	303	137	746	490	
10	0	0	88	53	0	175	100	0	295	166	0	447	255	0	631	345	0	847	450	0	1377	720	
	2	12	61	42	17	118	81	23	194	129	26	289	195	40	402	273	48	533	355	68	852	560	
	5	23	57	40	32	113	77	41	187	124	52	280	188	68	392	263	81	522	346	112	839	547	
	10	30	51	36	41	104	70	54	176	115	67	267	175	88	376	245	204	504	330	142	817	525	
15	0	0	94	58	0	191	112	0	327	187	0	502	285	0	716	390	0	970	525	0	1596	840	
	2	11	69	48	15	136	93	20	226	150	22	339	225	38	475	316	45	633	414	63	1019	675	
	5	22	65	45	30	130	87	39	219	142	49	330	217	64	463	300	76	620	403	105	1003	660	
	10	29	59	41	40	121	82	51	206	135	64	315	208	84	445	288	99	600	386	135	977	635	
15	15	35	53	37	48	112	76	61	195	128	76	301	198	98	429	275	115	580	373	155	953	610	
	20	0	0	97	61	0	202	119	0	349	202	0	540	307	0	776	430	0	1057	575	0	1756	930
	2	10	75	51	14	149	100	18	250	166	20	377	249	33	531	346	41	711	470	59	1150	755	
	5	21	71	48	29	143	96	38	242	160	47	367	241	62	519	337	73	697	460	101	1133	738	
10	10	28	64	44	38	133	89	50	229	150	62	351	228	81	499	321	95	675	443	130	1105	710	
	15	34	58	40	46	124	84	59	217	142	73	337	217	94	481	308	111	654	427	150	1078	688	
	20	48	52	35	55	116	78	69	206	134	84	322	206	107	464	295	125	634	410	167	1052	665	
	30	0	0	100	64	0	213	128	0	374	220	0	587	336	0	853	475	0	1173	650	0	1977	1060
30	2	9	81	56	13	166	112	14	283	185	18	432	280	27	613	394	33	826	535	54	1351	865	
	5	21	77	54	28	160	108	36	275	176	45	421	273	58	600	385	69	811	524	96	1332	851	
	10	27	70	50	37	150	102	48	262	171	59	405	261	77	580	371	91	788	507	125	1301	829	
	15	33	64	NR	44	141	96	57	249	163	70	389	249	90	560	357	105	765	490	143	1272	807	
20	20	56	58	NR	53	132	90	66	237	154	80	374	237	102	542	343	119	743	473	160	1243	784	
	30	NR	NR	NR	73	113	NR	88	214	NR	104	346	219	131	507	321	149	702	444	195	1189	745	
	50	0	0	101	67	0	216	134	0	397	232	0	633	363	0	932	518	0	1297	708	0	2231	1195
	2	8	86	61	11	183	122	14	320	206	18	497	314	22	715	445	29	975	645	41	1620	1010	
5	5	20	82	NR	27	177	119	35	312	200	43	487	308	55	702	438	65	960	605	90	1600	996	
	10	26	76	NR	35	168	114	45	299	190	56	471	298	73	681	426	86	935	589	118	1567	972	
	15	59	70	NR	42	158	NR	54	287	180	66	455	288	85	662	413	100	911	572	136	1536	948	
	20	NR	NR	NR	50	149	NR	63	275	169	76	440	279	97	642	401	113	888	556	151	1505	924	
30	30	NR	NR	NR	69	131	NR	84	250	NR	99	410	259	123	605	376	141	844	522	183	1446	876	
	100	0	NR	NR	NR	0	218	NR	0	407	NR	0	665	400	0	997	560	0	1411	770	0	2310	1249
	2	NR	NR	NR	10	194	NR	12	354	NR	13	566	375	18	831	510	21	1155	700	360	1975	1170	
	5	NR	NR	NR	29	189	NR	33	347	NR	40	557	369	52	820	504	60	1141	692	82	1955	1159	
10	10	NR	NR	NR	33	182	NR	43	335	NR	53	542	361	68	801	493	80	1118	679	108	1923	1142	
	15	NR	NR	NR	40	174	NR	50	321	NR	62	528	353	80	782	482	93	1095	666	126	1892	1124	
	20	NR	NR	NR	47	166	NR	59	311	NR	71	513	344	90	763	471	105	1073	653	141	1861	1107	
	30	NR	NR	NR	NR	NR	NR	78	290	NR	92	483	NR	115	726	449	131	1029	627	170	1802	1071	
50	50	NR	NR	NR	NR	NR	NR	NR	NR	NR	147	428	NR	180	651	405	197	944	575	241	1688	1000	

**NOTES:**

- 1) Regardless of altitude or derating, always design the vent for sea level nameplate input.
- 2) "0" lateral applies to vertical vent attached to a top outlet flue collar (see definitions). Any vertical vent starting with a 90 degree elbow at a side outlet must use the 2-foot lateral capacity.
- 3) These capacities apply to all-Selkirk vents (no single wall connector material).

# INDIVIDUAL VENTS - TABLE I

Capacity of Selkirk Gas Vents when connected directly to one appliance. (Not applicable to combined vents.)

		Selkirk Type B Gas Vent Diameter (Inches)																					
		12"			14"			16"			18"			20"			22"			24"			
		Appliance Input Rating In Thousands of Btu Per Hour																					
Height H (ft)	Lateral L (ft)	FAN		NAT	FAN		NAT	FAN		NAT	FAN		NAT	FAN		NAT	FAN		NAT	FAN		NAT	
		Min	Max	Max	Min	Max	Max	Min	Max	Max	Min	Max	Max	Min	Max	Max	Min	Max	Max	Min	Max	Max	
6	0	0	1645	850	0	2267	1170	0	2983	1530	0	3802	1960	0	4721	2430	0	5737	2950	0	6853	3520	
	2	103	982	650	138	1346	890	178	1769	1170	225	2250	1480	296	2782	1850	360	3377	2220	426	4030	2670	
	4	147	975	640	191	1338	880	242	1761	1160	300	2242	1475	390	2774	1835	469	3370	2215	555	4023	2660	
	6	171	967	630	219	1330	870	276	1753	1150	341	2235	1470	437	2767	1820	523	3363	2210	618	4017	2650	
	8	0	0	1858	970	0	2571	1320	0	3399	1740	0	4333	2220	0	5387	2750	0	6555	3360	0	7838	4010
8	2	98	1124	745	130	1543	1020	168	2030	1340	212	2584	1700	278	3196	2110	336	3882	2560	401	4634	3050	
	5	154	1110	733	199	1528	1010	251	2013	1330	311	2563	1685	398	3180	2090	476	3863	2545	562	4612	3040	
	8	180	1097	720	231	1514	1000	289	2000	1320	354	2552	1670	450	3163	2070	537	3850	2530	630	4602	3030	
	10	0	0	2036	1060	0	2825	1450	0	3742	1925	0	4782	2450	0	5955	3050	0	7254	3710	0	8682	4450
	2	93	1244	850	124	1713	1130	161	2256	1480	202	2868	1890	264	3556	2340	319	4322	2840	378	5153	3390	
10	5	149	1229	829	192	1696	1105	243	2238	1461	300	2849	1871	382	3536	2318	458	4301	2818	540	5132	3371	
	10	187	1204	795	238	1669	1040	298	2209	1430	364	2818	1840	459	3504	2280	546	4268	2780	641	5099	3340	
	15	0	0	2380	1240	0	3323	1720	0	4423	2270	0	5678	2900	0	7099	3620	0	8665	4410	0	10393	5300
	2	86	1495	985	114	2062	1350	147	2719	1770	186	3467	2260	239	4304	2800	290	5232	3410	346	6251	4080	
	5	140	1476	967	182	2041	1327	229	2696	1748	283	3442	2235	355	4278	2777	426	5204	3385	501	6222	4057	
15	10	177	1446	936	227	2009	1289	283	2659	1712	346	3402	2193	432	4234	2739	510	5159	3343	599	6175	4019	
	15	202	1418	905	257	1976	1250	318	2623	1675	385	3363	2150	479	4192	2700	564	5115	3300	665	6129	3980	
	20	0	0	2637	1350	0	3701	1900	0	4948	2520	0	6376	3250	0	7988	4060	0	9785	4980	0	11753	6000
	2	81	1694	1100	107	2343	1520	139	3097	2000	175	3955	2570	220	4916	3200	269	5983	3910	321	7154	4700	
	5	135	1674	1079	174	2320	1498	219	3071	1978	270	3926	2544	337	4885	3174	403	5950	3880	475	7119	4662	
20	10	172	1641	1045	220	2282	1460	273	3029	1940	334	3880	2500	413	4835	3130	489	5896	3830	573	7063	4600	
	15	195	1609	1018	248	2245	1425	306	2988	1910	372	3835	2465	459	4786	3090	541	5844	3795	631	7007	4575	
	20	217	1578	990	273	2210	1390	335	2948	1880	404	3791	2430	495	4737	3050	585	5792	3760	689	6953	4550	
	30	0	0	3004	1550	0	4252	2170	0	5725	2920	0	7420	3770	0	9341	4750	0	11483	5850	0	13848	7060
	2	74	2004	1310	98	2786	1800	127	3696	2380	159	4734	3050	199	5900	3810	241	7194	4650	285	8617	5600	
30	5	127	1981	1289	164	2759	1775	206	3666	2350	252	4701	3020	312	5863	3783	373	7155	4622	439	8574	5552	
	10	164	1944	1254	209	2716	1733	259	3617	2300	316	4647	2970	386	5803	3739	456	7090	4574	535	8505	5471	
	15	187	1908	1220	237	2674	1692	292	3570	2250	354	4594	2920	431	5744	3696	507	7026	4527	590	8437	5391	
	20	207	1873	1185	260	2633	1650	319	3523	2200	384	4542	2870	467	5686	3650	548	6964	4480	639	8370	5310	
	30	246	1807	1130	305	2555	1585	369	3433	2130	440	4442	2785	540	5574	3565	635	6842	4375	739	8239	5225	
50	0	0	3441	1825	0	4934	2550	0	6711	3440	0	8774	4460	0	11129	3635	0	13767	6940	0	16694	8430	
	2	66	2431	1513	86	3409	2125	113	4554	2840	141	5864	3670	171	7339	4630	209	8980	5695	251	10788	6860	
	5	118	2406	1495	151	3380	2102	191	4520	2813	234	5826	3639	283	7295	4597	336	8933	5654	394	10737	6818	
	10	154	2366	1466	196	3332	2064	243	4464	2767	295	5763	3585	355	7224	4542	419	8855	5585	491	10652	6749	
	15	177	2327	1437	222	3285	2026	274	4409	2721	330	5701	3534	396	7155	4511	465	8779	5546	542	10570	6710	
100	20	195	2288	1408	244	3239	1987	300	4356	2675	361	5641	3481	433	7086	4479	506	8704	5506	586	10488	6670	
	30	232	2214	1349	287	3150	1910	347	4253	2631	412	5523	3431	494	6953	4421	577	8557	5444	672	10328	6603	
	0	0	3925	2050	0	5729	2950	0	7914	4050	0	10485	5300	0	13454	6700	0	16817	8600	0	20578	10300	
	2	44	3027	1820	72	4313	2550	95	5834	3500	120	7591	4600	138	9577	5800	169	11803	7200	204	14264	8800	
	5	107	3002	1803	136	4282	2531	172	5797	3475	206	7548	4566	245	9528	5769	293	11748	7162	341	14204	8756	
200	10	142	2961	1775	180	4231	2500	223	5737	3434	268	7478	4509	318	9447	5717	374	11658	7100	436	14105	8683	
	15	163	2920	1747	206	4182	2469	252	5678	3392	304	7409	4451	358	9367	5665	418	11569	7037	487	14007	8610	
	20	181	2880	1719	226	4133	2438	277	5619	3351	330	7341	4394	387	9289	5613	452	11482	6975	523	13910	8537	
	30	215	2803	1663	265	4037	2375	319	5505	3267	378	7209	4279	446	9136	5509	514	11310	6850	592	13720	8391	
	50	282	2657	1550	350	3856	2250	415	5289	3100	486	6956	4050	572	8841	5300	659	10979	6600	752	13354	8100	

**NOTES:**

- 1) Regardless of altitude or derating, always design the vent for sea level nameplate input.
- 2) "0" lateral applies to vertical vent attached to a top outlet flue collar (see definitions). Any vertical vent starting with a 90 degree elbow at a side outlet must use the 2-foot lateral capacity.
- 3) These capacities apply to all-Selkirk vents (no single wall connector material).

# INDIVIDUAL VENTS - TABLE II

Capacity of Selkirk Gas Vents with single wall metal connectors.\* (Not applicable to combined vents.)

		Vent and Connector Diameter (Inches)																							
		3"			4"			5"			6"			7"			8"			10"			12"		
		Appliance Input Rating In Thousands of Btu Per Hour																							
Height H (ft)	Lateral L (ft)	FAN		NAT	FAN		NAT	FAN		NAT	FAN		NAT	FAN		NAT	FAN		NAT	FAN		NAT	FAN		NAT
		Min	Max	Max	Min	Max	Max	Min	Max	Max	Min	Max	Max	Min	Max	Max	Min	Max	Max	Min	Max	Max	Min	Max	Max
6	0	38	77	45	59	151	85	85	249	140	126	373	204	165	522	284	211	695	369	371	1118	569	537	1639	849
	2	39	51	36	60	96	66	85	156	104	123	231	156	159	320	213	201	423	284	347	673	453	498	979	648
	4	NR	NR	33	74	92	63	102	152	102	146	225	152	187	313	208	237	416	277	409	664	443	584	971	638
8	0	37	83	50	58	164	93	83	273	154	123	412	234	161	580	319	206	777	414	360	1257	658	521	1852	967
	2	39	56	39	59	108	75	83	176	119	121	261	179	155	363	246	197	482	321	339	768	513	486	1120	743
	5	NR	NR	37	77	102	69	107	168	114	151	252	171	193	352	235	245	470	311	418	754	500	598	1104	730
10	0	37	87	53	57	174	99	82	293	165	120	444	254	158	628	344	202	844	449	351	1373	718	507	2031	1057
	2	39	61	41	59	117	80	82	193	128	119	287	194	153	400	272	193	531	354	332	849	559	475	1242	848
	5	52	56	39	76	111	76	105	185	122	148	277	186	190	388	261	241	518	344	409	834	544	584	1224	825
15	0	36	93	57	56	190	111	80	325	186	116	499	283	153	713	388	195	966	523	336	1591	838	488	2374	1237
	2	38	69	47	57	136	93	80	225	149	115	337	224	148	473	314	187	631	413	319	1015	673	457	1491	983
	5	51	63	44	75	128	86	102	216	140	144	326	217	182	459	298	231	616	400	392	997	657	562	1469	963
20	0	35	96	60	54	200	118	78	346	201	114	537	306	149	772	428	190	1053	573	326	1751	927	473	2631	1346
	2	37	74	50	56	148	99	78	248	165	113	375	248	144	528	344	182	708	468	309	1146	754	443	1689	1098
	5	50	68	47	73	140	94	100	239	158	141	363	239	178	514	334	224	692	457	381	1126	734	547	1665	1074
30	0	NR	NR	41	93	129	86	125	223	146	177	344	224	222	491	316	277	666	437	457	1092	702	646	1626	1037
	2	NR	NR	NR	NR	NR	80	155	208	136	216	325	210	264	469	301	325	640	419	526	1060	677	730	1587	1005
	5	NR	NR	NR	NR	NR	NR	186	192	126	254	306	196	309	448	285	374	616	400	592	1028	651	808	1550	973
50	0	34	99	63	53	211	127	76	372	219	110	584	334	144	849	472	175	1168	647	312	1971	1056	454	2996	1545
	2	37	80	56	55	164	111	76	281	183	109	429	279	139	610	392	215	823	533	296	1346	863	424	1999	1308
	5	49	74	52	72	157	106	98	271	173	136	417	271	171	595	382	215	806	521	366	1324	846	524	1971	1283
100	0	NR	NR	NR	91	144	98	122	255	168	171	397	257	213	570	367	265	777	501	440	1287	821	620	1927	1243
	2	NR	NR	NR	115	NR	NR	151	239	157	208	377	242	255	547	349	312	750	481	507	1251	794	702	1884	1205
	5	NR	NR	NR	NR	NR	NR	181	223	NR	246	357	228	298	524	333	360	723	461	570	1216	768	780	1841	1166
150	0	NR	NR	NR	NR	213	NR	NR	NR	NR	NR	NR	NR	389	477	305	461	670	426	704	1147	720	937	1759	1101
	2	33	99	66	51	181	133	73	394	230	105	629	361	138	928	515	176	1292	704	295	2223	1189	428	3432	1818
	5	36	84	61	53	174	121	73	318	205	104	495	312	133	712	443	168	971	613	280	1615	1007	401	2426	1509
200	0	48	80	NR	70	160	117	94	308	198	131	482	305	164	696	435	204	953	602	347	1591	991	496	2396	1490
	2	NR	NR	NR	89	148	NR	118	292	186	162	461	292	203	671	420	253	923	583	418	1551	963	589	2347	1455
	5	NR	NR	NR	112	NR	NR	145	275	174	199	441	280	244	646	405	299	894	562	481	1512	934	668	2299	1421
300	0	NR	NR	NR	NR	NR	NR	176	257	NR	236	420	267	285	622	389	345	866	543	544	1473	906	741	2251	1387
	2	NR	NR	NR	NR	214	NR	NR	NR	NR	315	376	NR	373	573	NR	442	809	502	674	1399	848	892	2159	1318
	5	NR	NR	NR	49	192	NR	69	403	NR	100	659	395	131	991	555	166	1404	765	273	2479	1300	395	3912	2042
400	0	NR	NR	NR	51	186	NR	70	351	NR	98	563	373	125	828	508	158	1152	698	259	1970	1168	371	3021	1817
	2	NR	NR	NR	67	175	NR	90	342	NR	125	551	366	156	813	501	194	1134	688	322	1945	1153	460	2990	1796
	5	NR	NR	NR	85	162	NR	113	324	NR	153	532	354	191	789	486	238	1104	672	389	1905	1133	547	2938	1763
500	0	NR	NR	NR	132	NR	NR	138	310	NR	188	511	343	230	764	473	281	1075	656	447	1865	1110	618	2888	1730
	2	NR	NR	NR	NR	NR	NR	168	295	NR	224	487	NR	270	739	458	325	1046	639	507	1825	1087	690	2838	1696
	5	NR	NR	NR	NR	NR	NR	231	264	NR	301	448	NR	355	685	NR	418	988	NR	631	1747	1010	834	2739	1627
600	0	NR	NR	NR	NR	NR	NR	NR	NR	NR	NR	NR	NR	540	584	NR	617	866	NR	895	1591	NR	1138	2547	1489

## NOTES:

- 1) Regardless of altitude or derating, always design the vent for sea level nameplate input.
- 2) "0" lateral applies to vertical vent attached to a top outlet flue collar (see definitions). Any vertical vent starting with a 90 degree elbow at a side outlet must use the 2-foot lateral capacity.
- 3) \*Use this table and single wall connectors only after careful and thorough consideration of Sec 3-8.

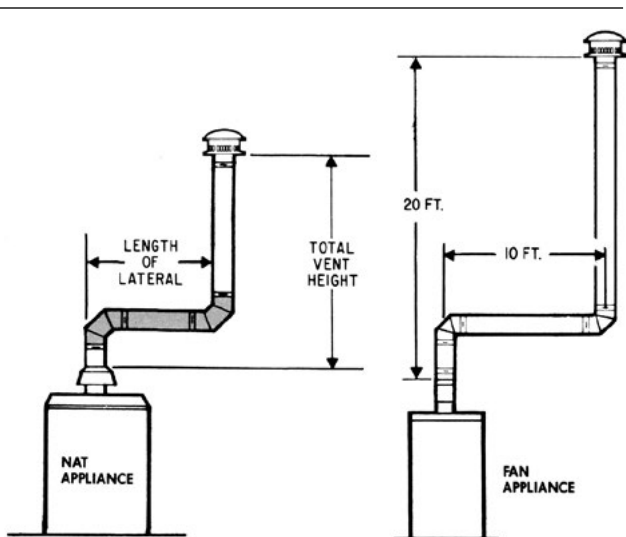

**FIG 1 - INDIVIDUAL VENT-LATERAL AND HEIGHT**

**FIG 2 - EXAMPLE OF INDIVIDUAL VENT DIMENSIONS**

- E. If the vent size shown at the top of the MAX column containing the correct maximum capacity rating is equal to or larger than the size of connection at the appliance, use the vent as shown by the table.
- F. For a FAN appliance, the appliance input rating must also be equal to or more than the MIN value shown in the FAN column. In other words, the rating must be within the MIN and MAX limits.
- G. If the vent shown is smaller than the appliance outlet size, see paragraph 1-4 for important conditions.
- H. For those readers with mathematical inclinations, graphical or linear interpolation between heights and laterals is permissible.

### 1-3 EXAMPLE 1, VENT FOR A "FAN" ASSISTED FURNACE

A typical individual vent is shown in Figure 2 for a FAN furnace with an input rating of 150,000 BTU per hour and a 5" outlet connection.

Procedure for an all Selkirk Vent, Table 1: Go down the height column to 20' and across on the 10' lateral line.

For this furnace, the MAX capacity under the 5" size heading is 229,000 BTU per hour and the MIN capacity is 50,000 BTU per hour. A 5" size RV vent will be correct.

### EXAMPLE 2, VENT FOR A "NAT" FURNACE

For a NAT furnace having a built-in draft hood and 6" outlet with the same 20' height and 10' lateral, read Table 1 across to 150,000 BTU per hour rating in the 5" column under NAT/MAX. (There is no minimum needed for NAT appliances with draft hoods.) This 5" size vent will be adequate despite the fact that the appliance has a 6" outlet because the vent is over 10' in height. See 1-4 below for more explanation of reductions.

## 1-4 VENT SIZE REDUCTIONS

If the vent size determined from the tables is smaller than the appliance draft hood outlet or flue collar, the smaller size may be used provided:

- A. The total vent height "H" is at least 10'.
- B. Vents or connectors for appliance draft hood outlets or flue collars 12" in diameter or smaller are not reduced more than one size (e.g., 12" to 10" is a one-size reduction).
- C. Vents or connectors for appliance draft hood or flue collars above 12" in diameter are not reduced more than two sizes (e.g., 24" to 20" is a two-size reduction).
- D. The maximum capacity listed in the table for a fan-assisted appliance is reduced by 10 percent (0.90 x maximum capacity).
- E. The draft hood outlet is greater than 4" in diameter. Do not connect a 3" diameter vent to a 4" diameter draft hood outlet. This provision does not apply to fan-assisted appliances.

## 1-5 VERTICAL VENTS

A vent with "O" lateral is vertical and is directly attached to a top outlet draft hood or flue collar. If an elbow or tee is needed as with a side outlet, use the 2' lateral capacity.

## 1-6 ADDITIONAL IMPORTANT INFORMATION

For general rules and restrictions see Section 3.

# SECTION 2 COMBINED VENT TABLES

## 2-1 DEFINITIONS FOR COMBINED VENTS

A "Combined Vent" is a vent for two or more appliances at one level served by a "Common Vent." "Least Total Height" is the vertical distance from the highest appliance outlet (draft hood or flue collar) to the lowest discharge opening of the vent top. This height dimension is illustrated in Figure 3 for a typical (FAN+ NAT) system. The same height measurement applies to FAN+FAN and NAT+NAT systems. Least total height is used for vent sizing of all connected appliances on one level.

"Connector Rise" for any appliance is the vertical distance from its outlet connection to the level at which it joins the common vent, as shown in Figures 3A and 3B.

A "Connector" for purposes of designing a combined vent is that part of the vent piping between the appliance outlet and its junction or interconnection to the rest of the system. Connectors are shown in color in Figure 3.

The "Common Vent" is that portion of the system serving two or more connected appliances. If connectors are joined before reaching the vertical vent, the run between the last entering connector and the vertical portion is also treated as part of the common vent. In Figure 3C, the vertical common vent is cross-hatched beginning at the interconnection tee.

## 2-2 HEADINGS IN THE COMBINED VENT TABLES

"FAN+FAN" refers to the maximum combined input rating of two or more fan-assisted appliances attached to the common vent.

"FAN+NAT" refers to the maximum combined input rating of one or more fan-assisted appliance and one or more draft hood-equipped appliance attached to the common vent.

"NAT+NAT" refers to the maximum combined input rating of two or more draft hood-equipped appliances attached to the common vent.

## 2-3 GENERAL PROCEDURE

A. For each connector, the correct size must be found from the applicable tables based on its appliance input, rise, and least total height. For draft hood (NAT) appliances the outlet size may be too small if there is not enough rise, therefore, connector design involves choosing the correct size and verifying whether use of a connector the same size as the outlet is within input rating limits.

B. For the common vent, the capacity table shows maximum combined ratings only. The size of the common vent is thus based on least total height and the combination of attached appliances, FAN+FAN, FAN+NAT, or NAT+NAT.

## 2-4 PROCEDURE TO FIND EACH CONNECTOR SIZE

Use Table III for connectors or Table IV for single wall metal connectors.

- Determine "least total height" for the system.
- Determine connector rise for each appliance.
- Enter the applicable vent connector table at the least total height. Continue across on the line for appliance connector rise to a MAX

input rating equal to or greater than that of the appliance. For a FAN appliance this input rating should also be greater than shown in the MIN column. Read the connector size at the top of the column. If Table IV for single wall shows "NR," use a double wall connector in accordance with Table III.

## 2-5 PROCEDURE TO FIND COMMON VENT SIZE

- Add all appliance BTU input ratings to get the total BTU input.
  - If one or both connectors are single wall metal, use Table IV for the common vent.
  - Enter the common vent table at the same least total height used for connectors.
  - Continue across and stop at the first applicable column of combined appliance input rating equal to or greater than the total. If Table IV for the common vent shows "NR," the entire system should be double wall.
  - Read the size of the common vent at the top of the applicable column (NAT+NAT, FAN+NAT, or FAN+FAN).
- Regardless of table results for size, the common vent must be at least as large as the largest connector.
  - For NAT+NAT appliance combinations, if both connectors are the same size, the common vent must be at least one size larger.

## 2-6 EXAMPLE OF COMBINED VENT SYSTEM DESIGN

Figure 3 shows a two-appliance "FAN+NAT" system, combining a draft hood water heater (NAT appliance) with a fan-assisted combustion Category I (FAN) furnace. The system is designed in the following steps using Table III for double wall connectors.

A. For the water heater, enter the vent connector table at a least total height of 15' and a connector rise of 1'. Read across to the MAX BTU per hour rating for a NAT appliance vent higher than 35,000. The table shows that a 4" size connector is needed. This size must be used beginning at the draft hood, regardless of draft hood size (which might be 3"). See Figure 3A.

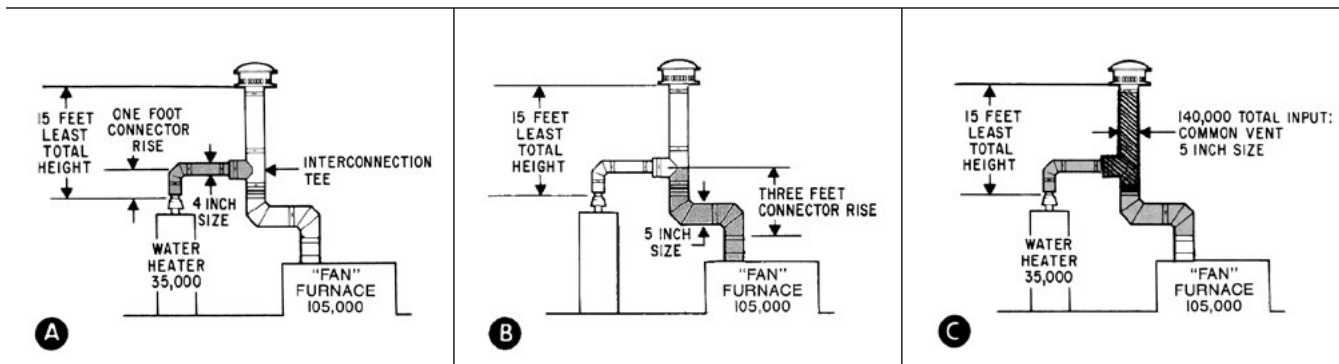

FIG. 3 -

COMBINED VENT DIMENSIONS AND EXAMPLE

# COMBINED VENTS - TABLE III

Capacity of Selkirk gas vents with Selkirk connector serving two or more appliances.

## VENT CONNECTOR TABLE

		Selkirk Type B Gas Vent Diameter (Inches)																																									
		3"						4"						5"						6"						7"						8"						10"					
		Appliance Input Rating Limits In Thousands of Btu Per Hour																																									
Vent Connector Height H (ft)	Rise R (ft)	FAN			NAT			FAN			NAT			FAN			NAT			FAN			NAT			FAN			NAT			FAN			NAT								
		Min	Max	Max	Min	Max	Max	Min	Max	Max	Min	Max	Max	Min	Max	Max	Min	Max	Max	Min	Max	Max	Min	Max	Max	Min	Max	Max	Min	Max	Max												
6	1	22	37	26	35	66	46	46	106	72	58	164	104	77	225	142	92	296	185	128	466	289																					
	2	23	41	31	37	75	55	48	121	86	60	183	124	79	253	168	95	333	220	131	526	345																					
	3	24	44	35	38	81	62	49	132	96	62	199	139	82	275	189	97	363	248	134	575	386																					
8	1	22	40	27	35	72	48	49	114	76	64	176	109	84	243	148	100	320	194	138	507	303																					
	2	23	44	32	36	80	57	51	128	90	66	195	129	86	269	175	103	356	230	141	564	358																					
	3	24	47	36	37	87	64	53	139	101	67	210	145	88	290	198	105	384	258	143	612	402																					
10	1	22	43	28	34	78	50	49	123	78	65	189	113	89	257	154	106	341	200	146	542	314																					
	2	23	47	33	36	86	59	51	136	93	67	206	134	91	282	182	109	374	238	149	596	372																					
	3	24	50	37	37	92	67	52	146	104	69	220	150	94	303	205	111	405	268	152	642	417																					
15	1	21	50	30	33	89	53	47	142	83	64	220	120	88	298	163	110	389	214	162	609	333																					
	2	22	53	35	35	96	63	49	153	99	66	235	142	91	320	193	112	419	253	165	658	394																					
	3	24	55	40	36	102	71	51	163	111	68	248	160	93	339	218	115	445	286	167	700	444																					
20	1	21	54	31	33	99	56	46	157	87	62	246	125	86	334	171	107	436	224	158	681	347																					
	2	22	57	37	34	105	66	48	167	104	64	259	149	89	354	202	110	463	265	161	725	414																					
	3	23	60	42	35	110	74	50	176	116	66	271	168	91	371	228	113	486	300	164	764	466																					
30	1	20	62	33	31	113	59	45	181	93	60	288	134	83	391	182	103	512	238	151	802	372																					
	2	21	64	39	33	118	70	47	190	110	62	299	158	85	408	215	105	535	282	155	840	439																					
	3	22	66	44	34	123	79	48	198	124	64	309	178	88	423	242	108	555	317	158	874	494																					
50	1	19	71	36	30	133	64	43	216	101	57	349	145	78	477	197	97	627	257	144	984	403																					
	2	21	73	43	32	137	76	45	223	119	59	358	172	81	490	234	100	645	306	148	1014	478																					
	3	22	75	48	33	141	86	46	229	134	61	366	194	83	502	263	103	661	343	151	1043	538																					
100	1	18	82	37	28	158	66	40	262	104	53	442	150	73	611	204	91	810	266	135	1285	417																					
	2	19	83	44	30	161	79	42	267	123	55	447	178	75	619	242	94	822	316	139	1306	494																					
	3	20	84	50	31	163	89	44	272	138	57	452	200	78	627	272	97	834	355	142	1327	555																					

## COMMON VENT TABLE

		Selkirk Type B Gas Vent Diameter (Inches)																																			
		4"						5"						6"						7"						8"						10"					
		Combined Appliance Input Rating In Thousands of Btu Per Hour																																			
Vent Height H (ft)		FAN	FAN	NAT	FAN	FAN	NAT	FAN	FAN	NAT	FAN	FAN	NAT	FAN	FAN	NAT	FAN	FAN	NAT	FAN	FAN	NAT	FAN	FAN	NAT												
		+FAN	+NAT	+NAT	+FAN	+NAT	+NAT	+FAN	+NAT	+NAT	+FAN	+NAT	+NAT	+FAN	+NAT	+NAT	+FAN	+NAT	+NAT	+FAN	+NAT	+NAT	+FAN	+NAT	+NAT												
6		92	81	65	140	116	103	204	161	147	309	248	200	404	314	260	672	520	410																		
8		101	90	73	155	129	114	224	178	163	339	275	223	444	348	290	740	577	465																		
10		110	97	79	169	141	124	243	194	178	367	299	242	477	377	315	800	627	495																		
15		125	112	91	195	164	144	283	228	206	427	352	280	556	444	365	924	733	565																		
20		136	123	102	215	183	160	314	255	229	475	394	310	621	499	405	1035	826	640																		
30		152	138	118	244	210	185	361	297	266	547	459	360	720	585	470	1209	975	740																		
50		167	153	134	279	244	214	421	353	310	641	547	423	854	706	550	1451	1188	860																		
100		175	163	NR	311	277	NR	489	421	NR	751	658	479	1025	873	625	1784	1502	975																		

### NOTES:

- 1) Regardless of altitude or derating, always design the vent for sea level nameplate input.
- 2) These capacities apply to all Selkirk vents (no single wall connector material).
- 3) For common vents with an offset, or 1 or 2 elbows above the interconnection, use 80 percent of the tabulated capacity.

# COMBINED VENTS - TABLE III

Capacity of Selkirk gas vents with Selkirk connector serving two or more appliances.

## VENT CONNECTOR TABLE

		Selkirk Type B Gas Vent Diameter (Inches)																					
		Appliance Input Rating Limits In Thousands of Btu Per Hour																					
		12"			14"			16"			18"			20"			22"			24"			
Vent Connector Height Rise H (ft) R (ft)		FAN		NAT	FAN		NAT	FAN		NAT	FAN		NAT	FAN		NAT	FAN		NAT	FAN		NAT	
		Min	Max	Max	Min	Max	Max	Min	Max	Max	Min	Max	Max	Min	Max	Max	Min	Max	Max	Min	Max	Max	
6	2	174	764	496	223	1046	653	281	1371	853	346	1772	1080	NA	NA	NA	NA	NA	NA	NA	NA	NA	NA
	4	180	897	616	230	1231	827	287	1617	1081	352	2069	1370	NA	NA	NA	NA	NA	NA	NA	NA	NA	NA
	6	NA	NA	NA	NA	NA	NA	NA	NA	NA	NA	NA	NA	NA	NA	NA	NA	NA	NA	NA	NA	NA	NA
8	2	186	822	516	238	1126	696	298	1478	910	365	1920	1150	NA	NA	NA	NA	NA	NA	NA	NA	NA	NA
	4	192	952	644	244	1307	884	305	1719	1150	372	2211	1460	471	2737	1800	560	3319	2180	662	3957	2590	
	6	198	1050	772	252	1445	1072	313	1902	1390	380	2434	1770	478	3018	2180	568	3665	2640	669	4373	3130	
10	2	196	870	536	249	1195	730	311	1570	955	379	2049	1205	NA	NA	NA	NA	NA	NA	NA	NA	NA	NA
	4	201	997	664	256	1371	924	318	1804	1205	387	2332	1535	486	2887	1890	581	3502	2280	636	4175	2710	
	6	207	1095	792	263	1509	1118	325	1989	1455	395	2556	1865	494	3169	2290	589	3849	2760	694	4593	3270	
15	2	214	967	568	272	1334	790	336	1760	1030	408	2317	1305	NA	NA	NA	NA	NA	NA	NA	NA	NA	NA
	4	221	1085	712	279	1499	1006	344	1978	1320	416	2579	1665	523	3197	2060	624	3881	2490	734	4631	2960	
	6	228	1181	856	286	1632	1222	351	2157	1610	424	2796	2025	533	3470	2510	634	4216	3030	743	5035	3600	
20	2	223	1051	596	291	1443	840	357	1911	1095	430	2533	1385	NA	NA	NA	NA	NA	NA	NA	NA	NA	NA
	4	230	1162	748	298	1597	1064	365	2116	1395	438	2778	1765	554	3447	2180	661	4190	2630	772	5005	3130	
	6	237	1253	900	307	1726	1288	373	2287	1695	450	2984	2145	567	3708	2650	671	4511	3190	785	5392	3790	
30	2	216	1217	632	286	1664	910	367	2183	1190	461	2891	1540	NA	NA	NA	NA	NA	NA	NA	NA	NA	NA
	4	223	1316	792	294	1802	1160	376	2366	1510	474	3110	1920	619	3840	2365	728	4681	2860	847	5606	3410	
	6	231	1400	952	303	1920	1410	384	2524	1830	485	3299	2340	632	4080	2875	741	4976	3480	860	5961	4150	
50	2	206	1479	689	273	2023	1007	350	2659	1315	435	3548	1665	NA	NA	NA	NA	NA	NA	NA	NA	NA	NA
	4	213	1561	860	281	2139	1291	359	2814	1685	447	3730	2135	580	4601	2633	709	5569	3185	851	6633	3790	
	6	221	1631	1031	290	2242	1575	369	2951	2055	461	3893	2605	594	4808	3208	724	5826	3885	867	6943	4620	
100	2	192	1923	712	254	2644	1050	326	3490	1370	402	4707	1740	NA	NA	NA	NA	NA	NA	NA	NA	NA	NA
	4	200	1984	888	263	2731	1346	336	3606	1760	414	4842	2220	523	5982	2750	639	7254	3330	769	8650	3950	
	6	208	2035	1064	272	2811	1642	346	3714	2150	426	4968	2700	539	6143	3350	654	7453	4070	786	8892	4810	

## COMMON VENT TABLE

		Selkirk Type B Gas Vent Diameter (Inches)																				
		Appliance Input Rating Limits In Thousands of Btu Per Hour																				
		12"			14"			16"			18"			20"			22"			24"		
Vent Height H (ft)		FAN	FAN	NAT	FAN	FAN	NAT	FAN	FAN	NAT	FAN	FAN	NAT	FAN	FAN	NAT	FAN	FAN	NAT	FAN	FAN	NAT
		+FAN	+NAT	+NAT	+FAN	+NAT	+NAT	+FAN	+NAT	+NAT	+FAN	+NAT	+NAT	+FAN	+NAT	+NAT	+FAN	+NAT	+NAT	+FAN	+NAT	+NAT
6		900	696	588	1284	990	815	1735	1336	1065	2253	1732	1345	2838	2180	1660	3488	2677	1970	4206	3226	2390
8		994	773	652	1423	1103	912	1927	1491	1190	2507	1936	1510	3162	2439	1860	3890	2998	2200	4695	3616	2680
10		1076	841	712	1542	1200	995	2093	1625	1300	2727	2113	1645	3444	2665	2030	4741	3278	2400	5123	3957	2920
15		1247	986	825	1794	1410	1158	2440	1910	1510	3184	2484	1910	4026	3133	2360	4971	3862	2790	6016	4670	3400
20		1405	1116	916	2006	1588	1290	2722	2147	1690	3561	2798	2140	4548	3552	2640	5573	4352	3120	6749	5261	3800
30		1658	1327	1025	2373	1892	1525	3220	2558	1990	4197	3326	2520	5303	4193	3110	6539	5157	3680	7940	6247	4480
50		2024	1640	1280	2911	2347	1863	3964	3183	2430	5184	4149	3075	6567	5240	3800	8116	6458	4500	9837	7813	5475
100		2569	2131	1670	3732	3076	2450	5125	4202	3200	6749	5509	4050	8597	6986	5000	10681	8648	5920	13004	10499	7200

### NOTES:

- 1) Regardless of altitude or derating, always design the vent for sea level nameplate input.
- 2) These capacities apply to all Selkirk vents (no single wall connector material).
- 3) For common vents with an offset, or 1 or 2 elbows above the interconnection, use 80 percent of the tabulated capacity.

# COMBINED VENTS - TABLE IV

Capacity of Selkirk gas vents with single wall metal connector\* serving two or more appliances.

## VENT CONNECTOR TABLE

		Single Wall Metal Vent Connector Diameter (Inches)																				
		3"		4"			5"			6"			7"			8"			10"			
		Appliance Input Rating Limits In Thousands of Btu Per Hour																				
Vent Connector Height Rise H (ft) R (ft)		FAN		NAT	FAN		NAT	FAN		NAT	FAN		NAT	FAN		NAT	FAN		NAT	FAN		NAT
		Min	Max	Max	Min	Max	Max	Min	Max	Max	Min	Max	Max	Min	Max	Max	Min	Max	Max	Min	Max	Max
6	1	NR	NR	26	NR	NR	46	NR	NR	71	NR	NR	102	207	223	140	262	293	183	447	463	286
	2	NR	NR	31	NR	NR	55	NR	NR	85	168	182	123	215	251	167	271	331	219	458	524	344
	3	NR	NR	34	NR	NR	62	121	131	95	175	198	138	222	273	188	279	361	247	468	574	385
8	1	NR	NR	27	NR	NR	48	NR	NR	75	NR	NR	106	226	240	145	285	316	191	481	502	299
	2	NR	NR	32	NR	NR	57	125	126	89	184	193	127	234	266	173	293	353	228	492	560	355
	3	NR	NR	35	NR	NR	64	130	138	100	191	208	144	241	287	197	302	381	256	501	609	400
10	1	NR	NR	28	NR	NR	50	119	121	77	182	186	110	240	253	150	302	335	196	506	534	308
	2	NR	NR	33	84	85	59	124	134	91	189	203	132	248	278	183	311	369	235	517	589	368
	3	NR	NR	36	89	91	67	129	144	102	197	217	148	257	299	203	320	398	265	528	637	413
15	1	NR	NR	29	79	87	52	116	138	81	177	214	116	238	291	158	312	380	208	556	596	324
	2	NR	NR	34	83	94	62	121	150	97	185	230	138	246	314	189	321	411	248	568	646	389
	3	NR	NR	39	87	100	70	127	160	109	193	243	157	255	333	215	331	438	281	579	690	437
20	1	49	56	30	78	97	54	115	152	84	175	238	120	233	325	165	306	425	217	546	664	336
	2	52	59	36	82	103	64	120	163	101	182	252	144	243	346	197	317	453	259	558	709	403
	3	55	62	40	87	107	72	125	172	113	190	264	164	252	363	223	326	476	294	570	750	457
30	1	47	60	31	77	110	57	112	175	89	169	278	129	226	380	175	296	497	230	528	779	358
	2	51	62	37	81	115	67	117	185	106	177	290	152	236	397	208	307	521	274	541	819	425
	3	54	64	42	85	119	76	122	193	120	185	300	172	244	412	235	316	542	309	555	855	482
50	1	46	69	34	75	128	60	109	207	96	162	336	137	217	460	188	284	604	245	507	951	384
	2	49	71	40	79	132	72	114	215	113	170	345	164	226	473	223	294	623	293	520	983	458
	3	52	72	45	83	136	82	119	221	123	178	353	186	235	486	252	304	640	331	535	1013	518
100	1	45	79	34	71	150	61	104	249	98	153	424	140	205	585	192	269	774	249	476	1236	393
	2	48	80	41	75	153	79	110	255	115	160	428	167	212	593	228	279	788	299	490	1259	469
	3	51	81	46	79	157	85	114	260	129	168	433	190	222	603	256	289	801	339	506	1280	527

## COMMON VENT TABLE

		Selkirk Type B Gas Vent Diameter (Inches)																	
		4"			5"			6"			7"			8"			10"		
		Combined Appliance Input Rating In Thousands of Btu Per Hour																	
Vent Height H (ft)		FAN	FAN	NAT	FAN	FAN	NAT	FAN	FAN	NAT	FAN	FAN	NAT	FAN	FAN	NAT	FAN	FAN	NAT
		+FAN	+NAT	+NAT	+FAN	+NAT	+NAT	+FAN	+NAT	+NAT	+FAN	+NAT	+NAT	+FAN	+NAT	+NAT	+FAN	+NAT	+NAT
6		NR	78	64	NR	113	99	200	158	144	304	244	196	398	310	257	665	515	407
8		NR	87	71	NR	126	111	218	173	159	331	269	218	436	342	285	730	569	460
10		NR	94	76	163	137	120	237	189	174	357	292	236	467	369	309	787	617	487
15		121	108	88	189	159	140	275	221	200	416	343	274	544	434	357	905	718	553
20		131	118	98	208	177	156	305	247	223	463	383	302	606	487	395	1013	808	626
30		145	132	113	236	202	180	350	286	257	533	446	349	703	570	459	1183	952	723
50		159	145	128	268	233	208	406	337	296	622	529	410	833	686	535	1418	1157	838
100		166	153	NR	297	263	NR	469	398	NR	726	633	464	999	846	606	1741	1459	948

### NOTES:

- 1) Regardless of altitude or derating, always design the vent for sea level nameplate input.
- 2) \*Use this table and single wall connectors only after careful and thorough consideration of Sec. 3-8.
- 3) For common vents with an offset, or 1 or 2 elbows above the interconnection, use 80 percent of the tabulated capacity.



**B.** For the 105,000 BTU per hour furnace, enter the vent connector table at the same least total height (15') at a connector rise of 3'. Read across to 163,000 under the FAN MAX column. The MIN is 51,000. Therefore, 5" is the correct connector size. See Figure 3B.

**C.** For the common vent, the sum of the two ratings is 140,000 BTU per hour. Enter the common vent table at 15' least total height. For a FAN+NAT combination, the maximum input of 5" vent is 164,000, so 5" is the proper size, as shown in Figure 3C.

**D.** Refer to Sections 6 and 7 for more help on design of combined vents.

---

## SECTION 3 GENERAL RULES

### 3-1 APPLICABILITY TO SELKIRK PRODUCTS

The gas vent tables in Sections 1 and 2 were developed specifically for UL listed Type B gas vents and are thus applicable to all sizes and shapes of gas vent from 3" to 24" diameters. Specific products (when used as gas vents) to which these tables apply are:

- A.** RV sizes 3" through 8" round
- B.** OV sizes 4", 5", 6" oval
- C.** QC sizes 10" through 24" round
- D.** Model DF sizes 10" through 24" round
- E.** Model DFS sizes 3" through 8" round
- F.** Model VP sizes 3" and 4" round
- G.** Model PS and IPS sizes 5" through 24" round
- H.** Chimney chimney sizes 5" through 14" round for draft hood appliances only
- I.** Flexi-Liner - Flexible Aluminum Chimney Liner may be sized using these tables and a reduction factor. See Section 14.

In addition to capacities given in the tables through 24" size, graphs and procedures in this Handbook can be used for those products more than 24" in diameter. These are:

- A.** QC 26" through 48"
- B.** Models PS and IPS 26" through 48"

### 3-2 TYPES OF GAS-BURNING APPLIANCES

The tables in this Handbook apply to:

- A.** All gas-burning appliances with draft hoods which have been approved, certified, or listed by a recognized listing agency (such as the American Gas Association or other laboratory administering appropriate test standards and maintaining a listing service).
- B.** All gas-burning appliances with draft hoods or fan assisted burners which are listed as Category I appliances.

Specific types of appliances and/or equipment to which these tables apply include:

- Central Furnaces (warm air types)
- Low Pressure Boilers (hot water and steam)
- Water Heaters
- Duct Furnaces
- Unit Heaters
- Vented Room Heaters (with appropriate input compensation)
- Floor Furnaces (with appropriate input compensation)
- Conversion Burners (with draft hoods)

### 3-3 APPLIANCE OPERATION AND VENTING PRINCIPLES

A gas-burning appliance with a draft hood depends on gravity flow for supply of combustion air, for flow of flue products through the heat exchanger, and for proper gas venting. The draft hood allows for proper combustion regardless of any venting malfunction. Its relief opening serves as a flue product exit in the event of a blocked vent or downdraft. The relief opening, however, also allows dilution air to enter the vent during normal appliance/vent operation. When this dilution air is obtained from within the heated space there is a loss of seasonal efficiency. This heated air loss can be reduced by installation of a vent damper which is designed to close, reducing the flow of air through the vent if the burner is off.

To improve annual fuel utilization efficiency (AFUE), many appliance manufacturers have designed fan-assisted combustion using mechanical means (blowers or fans) to obtain either induced or forced flow of combustion air, and combustion products. Greater efficiency results from two major effects. First, heat exchange improves because of higher internal flow velocity and, second, there is no longer a draft hood to cause heated air loss up the vent both when the appliance is operating and when it is not.

Lacking a draft hood, a fan-assisted combustion appliance uses pressure-sensing or flow-sensing controls to assure proper venting. The control must prove either that the appliance outlet is at neutral or negative pressure, or that adequate flow velocity exists. Without a draft hood to dilute the combustion products, gases entering the vent will have a higher water vapor content than those from a draft hood appliance. There may be a longer (wetttime) period of condensation in the vent, particularly where it connects to the appliance. These differences between fan-assisted and draft hood appliances are reflected in the tables by the lack of minimum capacities for draft hood appliances. The minimums for fan-assisted appliances are dependent on the heat input needed to control the duration of wetttime or condensation during start-up or cyclic operation.

### 3-4 PROHIBITED APPLICATIONS OF TABLES

The tables do not apply directly to:

- A. Wall furnaces (recessed heaters) which require Type BW vents. (See 4-1 A)
- B. Decorative gas appliances (gas fireplaces or logs) which generally require a specific vent size and are best individually vented. (See 4-1 D)
- C. Category II, III, or IV gas appliances, except that a Category III appliance may also be vented in accordance with Category I conditions. Specifically, if the vent for a Category III appliance is sized and configured (connector rise, total height, etc.) for the input, the vent will operate under non-positive pressure. This allows the use of Type B gas vent. For a Category III appliance to operate as a Category I, the vent size may need to be larger than the appliance flue collar.
- D. Gas-burning appliances listed for use only with chimneys, or dual fuel appliances, such as oil/gas, wood/gas, or coal/gas. Dual fuel appliances require chimneys sized in accordance with the appliance manufacturer's instructions or in accordance with procedures given in Section 10 of this Handbook.

### 3-5 NATIONAL AND LOCAL BUILDING CODES

The National Fuel Gas Code ANSI Z223.1/NFPA 54 is a valuable reference for permitted and prohibited use of Type B gas vents. Some localities have developed their own codes or may not have adopted the most recent version of an appropriate national code. Should a particular installation covered by these tables be in conflict with your local building code, consult your building inspector or other local administrative authority.

### 3-6 CORRECTION FOR ALTITUDE

Always design the vent (size, height, etc.) for the sea level name plate BTU input rating of the appliance, regardless of the actual de-rated operating input required by the local altitude. This is necessary because the volume of the flue or vent products does not change with altitude. For appliances capable of being operated at multiple inputs, design the vent for the greatest possible sea level input rating. Use the actual input at altitude for determining minimum capacity if the appliance has been de-rated.

### 3-7 FREEDOM FROM CONNECTOR RESTRICTIONS

The 2012 Edition of the National Fuel Gas Code contains a provision on vent connectors which reads as follows:

"12.11.1 When Required: A vent connector shall be used to connect gas utilization equipment to a gas vent, chimney, or single wall metal pipe, except when the gas vent, chimney, or single wall metal pipe is directly connected to the equipment."

For an individual Type B gas vent serving one appliance, there will be a connector only if single wall material is used up to the inlet of a Type B gas vent.

There will be no connector at all if the entire system (in accordance with 12.11.1) is Type B gas vent which is "directly connected to the equipment."

For any type of vent system, individual or combined, the code provision in effect says that the system will have no connectors if it is entirely of one material, such as Type B gas vent. For Type B products, there are, therefore, no limits other than those in this Handbook on offsets, branches, laterals, and manifolds as to length or location because these parts of the system are not connectors. They are parts of the gas vent!

### 3-8 SINGLE WALL METAL CONNECTOR OPERATING PROBLEMS

While tables applicable to single wall connectors have been included in this handbook, they are intended primarily for convenience in determining whether existing single wall connectors will need to be replaced with Type B, in retrofit installations. A comparison of these tables (II and IV) to those applicable to systems incorporating Type B connectors (I and III) shows that the use of single wall is very limited, especially for FAN appliances. Note that the MIN Btu inputs (the input necessary to assure that condensation will be minimized and sufficient draft developed) are much higher when single wall connectors are used.

Single wall metal vent connectors of any material, galvanized steel, stainless steel, or aluminum, have more than double the heat loss of Type B double wall gas vents. This means that their use may cause greater condensation; they may stay wet longer during appliance cycling; they allow excessive heat to be lost from the vent gases; and they may experience greater corrosion as compared to Type B. Single wall metal is at a particular disadvantage when used with higher efficiency fan-assisted appliances as can be seen by comparing capacity Tables I and II.

The American Gas Association publication "New Vent Sizing Tables" has this to say about wettime with fan-assisted appliances:

*"Fan-assisted appliances are likely to produce more condensate in a vent than draft hood-equipped models. Therefore, a way to limit wettime is needed.*

*"The potential to produce condensate must be controlled to limit corrosion. The period when the vent is wet is called the 'wetime.' Whenever the vent is wet with condensate, a potential for corrosion exists. The corrosion may be accelerated by contamination of the combustion air by household chemicals. If this occurs, the condensate may become highly acidic. There are two practical ways to limit the potential for corrosion:*

1. Provide clean, outdoor air to the appliance; and
2. Limit the length of wettime in the vent "

The duration of wettime and attendant corrosion in a vent may be minimized in two ways:

- Use double-wall Type B gas vent for the entire system, including connector.
- Operate the connector or vent well above the minimum (MIN) heat input.

There are several existing restrictions on single wall metal connectors in venting codes. These recognize that cold environments can lead to material or venting failure.

Single wall metal connectors are prohibited in attics and cold areas by provisions in the National Fuel Gas Code as follows:

"7.10.2 Materials: (b). Where the vent connector used for gas utilization equipment having a draft hood or a Category I appliance is located in or passes through an attic space or other unconditioned area, that portion of the vent connector shall be listed Type B or Type L or listed vent material having equivalent insulation qualities."

"7.10.12 Location: Where the vent connector used for gas utilization equipment having a draft hood or for Category I appliances is located in or passes through an attic, crawl space, or other area that can be cold, that portion of the vent connector shall be of listed double-wall Type B, Type L vent material or listed having equivalent insulation qualities."

Accordingly, does not recommend use of single wall connectors, especially for FAN appliances.

### 3-9 CAUTIONS IN DRAFT HOOD INSTALLATION

Correct installation of the appliance and its draft hood is vital to proper vent operation. Gas appliances having draft hoods are tested and listed by the certification agency with their draft hoods in position. Check this list to be sure the draft hood is correctly installed.

- **DO** install exactly as specified by manufacturer's instructions.
- **DO** place the draft hood free of obstructions below and to the side.
- **DO** make sure the draft hood is securely attached to the appliance.
- **DO** obtain correct draft hood from manufacturer, if draft hood is missing. If assistance is needed, check with gas supplier.
- **DON'T** alter pipe lengths between the draft hood and appliance flue outlet.
- **DON'T** change the position of the draft hood on the appliance.
- **DON'T** change the design of draft hood by adjusting or cutting baffles, skirt, etc.
- **DON'T** substitute or exchange draft hoods.
- **DON'T** locate the draft hood in a different room from that of the appliance.

### 3-10 TYPES OF RAIN CAP OR TERMINATION

The tables apply only to vents using UL listed rain caps. Installation of the UL listed rain cap assures full vent capacity and freedom from adverse wind effects. For satisfactory vent termination, the vent should extend completely through its flashing. It should not terminate in a combination roof jack or locally fabricated part, which might cause flow restrictions, corrosion problems, or gas escape into roof or attic areas. Avoid ventilator caps or any unlisted type which may have many undesirable effects; reduced capacity, adverse wind characteristics, or poor corrosion resistance.

### 3-11 LOCATION OF RAIN CAP

Regardless of the calculated total vent height required by the tables for a given capacity, all vents must be correctly terminated a sufficient distance above the roof surface and away from nearby obstructions. This is to avoid adverse wind effects or pressure areas which may reduce or impede vent flow.

For roofs from flat to 7/12 pitch, maintain a 1' vertical distance from roof surface to the lowest discharge opening. For roof pitches higher than 7/12, refer to Figure 4A.

Special precautions are desirable if there are nearby walls, as indicated in Figure 4B.

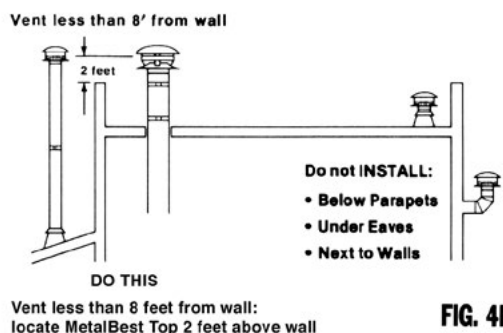
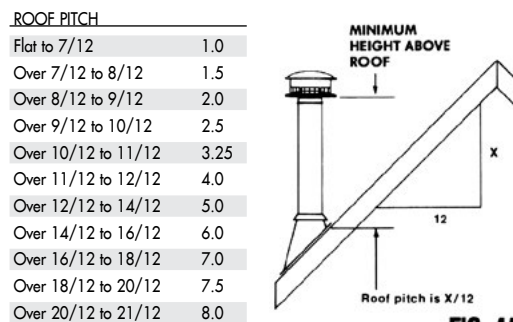

**FIG. 4 - RAIN CAP LOCATION RULES**

Tops for vents 14" and larger must be located in accordance with Figure 4B. The illustrations and rules given here are the same as those in the gas vent installation instructions. These rules were developed for rain caps listed in accordance with the Type B gas vent standard, UL-441.

#### Rule I (Sizes 3" through 12" Only)

The rain cap is suitable for installation on listed gas vents terminating a sufficient distance from the roof so that no discharge opening is less than 2' horizontally from the roof surface, and the lowest discharge opening will be no closer than the minimum height specified in Figure 4B. These minimum heights may be used provided that the vent is not less than 8' from any vertical wall or similar obstruction.

Rule 11 (14" and larger - or near walls)

For installations other than covered by the table above, or closer than 8' from a wall or similar obstruction, the top should be located such that the lowest discharge opening is at least 2' higher than any portion of a building within 10'. Vent tops 14" size and larger must comply with Rule 11 regardless of pitch.

### 3-12 USE OF THE CHIMNEY FOR GAS VENTING

The individual and combined gas vent tables apply to the Chimney only for draft hood (NAT) appliances. The Chimney is not recommended if any fan-assisted appliance is attached, either for individual or combined vent system. Simulation of cyclic operation of a high efficiency FAN appliance served by a Chimney on the computer program VENT II V4.1 indicated excessively long wettimes due to very low temperatures on the inner and outer walls of the chimney pipe.

Combinations either of draft hood appliances or fan-assisted appliances with a wood-burning stove or furnace using the Chimney are not recommended because of the potential for creosote blockage in the case of wood burning, as well as the problem of very low temperature operation with the gas-burning appliance. In either of these cases, the tables do not apply and the only recommendation is to AVOID SYSTEMS COMBINING WOOD AND GAS-BURNING APPLIANCES.

### 3-13 OUTDOOR VENTS FOR INDOOR APPLIANCES

When an outdoor vent serves an indoor draft hood appliance, a downdraft may occur causing draft hood spillage. As the vent cools when the appliance is off, warm air rising inside the building can draw cold air down the vent and out the draft hood relief opening. This makes it difficult to re-establish normal updraft and results in spillage.

Another cause for spillage from the draft hood may be that the air pressure at the draft hood is less than outside pressure. This causes air to flow through the vent from outside to inside when the appliance is off.

Some remedies:

- A. Provide outdoor air supply at the appliance level to rebalance pressures at the appliance location.
- B. Separate the appliance area from chimney action produced by air within the building with (a) a tight door or (b) a solid wall where access is possible only from outside. The latter is especially desirable for central furnaces and water heaters but not practical for room heaters or wall furnaces.
- C. Locate as much of the vent as possible within the heated building.

D. Construct an insulated, sealed chase around the vent, making sure that air space clearance to the chase insulation is maintained. Sealing off the top and bottom of the chase helps maintain higher temperatures around the vent. The chase should be continuous on all four sides, especially where it is next to attics and spaces under the roof.

With fan-assisted gas-burning equipment, reversal or downdraft is unlikely to cause priming problems because its combustion fan should produce enough pressure to prime and start vent operation. An insulated chase or indoor location for the Type B gas vent is still desirable to reduce heat loss and wettime, as well as for aesthetic reasons.

### 3-14 VENT DAMPER EFFECTS

An automatic vent damper, whether electrically or thermally actuated, does not change the maximum capacity of the vent for a draft hood appliance. When fully open, the flow resistance of the damper is very low, thus tabulated capacity values should be used. For combined vents with one draft hood and one fan-assisted appliance, however, a closed vent damper on the draft hood appliance side causes that part of the system to act like an inoperative fan-assisted appliance. Regardless, this does not change rated capacities for either the connectors or the common vent.

### 3-15 PILOT BURNER AND PRIMING EFFECTS

Capacities in the tables assume cold starts, such as with an intermittent ignition system (no standing pilot). The type of ignition system does not affect maximum capacities, but it does in practice affect minimums. A standing pilot on a furnace will keep vent gas temperatures slightly above ambient, while a tank of hot water plus water heater pilot operation will maintain flue gas temperature at 120 to 150 degrees F. into the draft hood. This flow of heat into a vent aids in priming, as well as reducing wettime.

The tables also assume that there are no adverse or building depressurization effects. A strong wind or mechanical ventilation may cause a downdraft with draft hood appliances which will prevent the vent from priming properly. A fan-assisted appliance is less likely to experience a downdraft problem if individually vented and may help to overcome a downdraft in a combined vent.

### 3-16 FUEL GAS TYPES

The input capacity values in the tables were computed for typical natural gas. They can be used for LP gases, such as propane and butane, and mixtures of these with air. With LP gases, the maximum capacity remains the same, but because these have less hydrogen and produce less water vapor, the possibility of condensation is somewhat less. To simplify matters, assume that minimum capacities are the same regardless of fuel type.

# SECTION 4 INDIVIDUAL VENTING

## 4-1 APPLIANCE TYPES, SPECIAL CONSIDERATIONS

**A. ROOM HEATERS, FLOOR FURNACES, WALL FURNACES:** If the appliance has a draft hood, assume an adjusted input 40 percent greater than name plate value and design vent for this increased input. Example: The vent for a 50,000 BTU per hour room heater will be 10' high with a 2' lateral. Adjusted input is  $1.4 \times 50,000 = 70,000$ . The NAT column in the tables shows that a 4" vent with 81,000 BTU per hour capacity will be adequate. If the appliance has a fan-assisted burner, use the FAN column without adjustment.

**B. CENTRAL HEATING BOILERS, GRAVITY AND FORCED AIR FURNACES, DUCT FURNACES AND UNIT HEATERS, CONVERSION BURNERS WITH DRAFT HOODS:** Use full tabulated capacities, depending on the type of appliance (NAT or FAN).

**C. COOKING EQUIPMENT: DOMESTIC, RESTAURANT, AND COMMERCIAL:** Use outlet size or five times input to determine individual vent size.

**D. DECORATIVE APPLIANCES: GAS-BURNING FIREPLACES:** Use outlet size or five times input to determine individual vent size.

## 4-2 MINIMUM VENT HEIGHT

Adequate vent height is one of the most critical factors in obtaining proper venting. The National Fuel Gas Code requires that a gas vent shall terminate at least 5' in vertical height above the highest connected draft hood or flue collar. The tables in the code and given here start at 6', therefore, the recommended minimum.

When using short vents, with or without laterals or offsets, a size increase is often necessary and is indicated by the tables. For appliances installed in attics, or with vents penetrating flat roofs, the minimum height rule takes precedence over the termination rule in Section 3-7.

For unit heaters, which are frequently hung close to ceilings for example, the minimum vent height of 6' must be observed even if the vent top must be 3' or 4' above a flat roof.

Vented recessed wall heaters or wall furnaces must terminate 12' or more above the bottom of the heater. For example: a 5' high recessed wall heater normally requires 7' of vent height as shown in Figure 5.

## 4-3 AVOIDING CONDENSATION

Avoid oversize or excessively long vents which may cause condensation. The tables define limits which minimize wettime in the indoor portions, as well as in the upper exposed end of the vent.

For individual vents, maximum vent length differs for draft hood (NAT) and fan-assisted (FAN) appliances. By adding height and

length of lateral, the following maximum lengths for all Selkirk Type B vents are obtained from the individual vent table: (Table

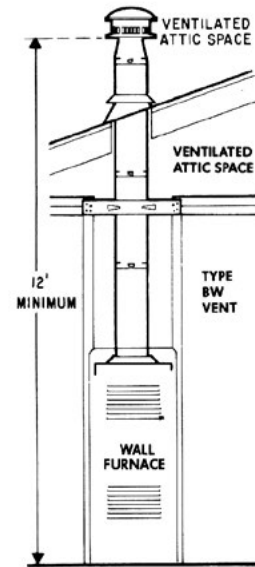

FIG. 5 - WALL FURNACE VENT HEIGHT

1)

These limits are illustrated for the 4" size in Figure 6. See also Section 3-10 on outdoor vents. The maximum vent lengths for FAN appliances were calculated on the basis of several assumed conditions, including flue gas temperature and composition and an ambient temperature of 42 degrees F., chosen as a

SIZE	MAXIMUM LENGTH	
	NAT	FAN
3"	52'	65'
4"	60'	120'
5"	70'	130'

representative value. Colder assumed temperatures or greater outdoor exposure of the vent would lead to shorter maximum allowable lengths or to greater possibilities of condensation. In order to minimize condensation, it is essential to operate closer to maximum than minimum capacity, and also to use the smallest feasible vent size.

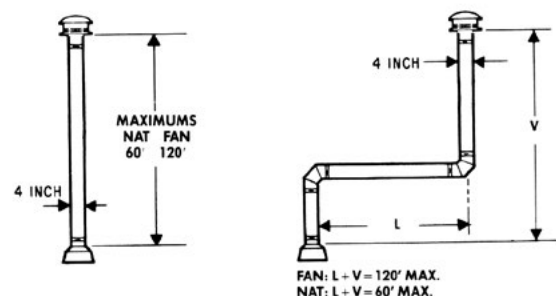

FIG. 6 - INDIVIDUAL VENT LENGTH LIMIT EXAMPLE

#### 4-4 COMPENSATING FOR EXTRA ELBOWS

Capacities shown for individual vents with laterals make allowance for two 90 degree turns anywhere in the system. Fittings for these turns may be:

- A. Two 90 degree elbows
- B. One 90 degree elbow and one tee
- C. Four 45 degree elbows
- D. Two 45 degree elbows and one tee

When more than two 90 degree turns are needed, a reduction in maximum (MAX) capacity must be made for each added turn. (Minimum capacity is not affect.)

For each additional elbow up to and including 45 degrees, the maximum capacity listed in the venting tables must be reduced by 5%. For each additional elbow greater than 45 degrees up to and including 90 degrees, the maximum capacity listed in the venting tables must be reduced by 10%. Thus, with more than two turns, use the following factors:

Three 90 degree turns: 90 percent of MAX capacity  
Four 90 degree turns: 80 percent of MAX capacity

#### 4-5 IN-BETWEEN HEIGHTS (INTERPOLATION)

There is no need to use the next highest height or an oversize vent for in-between situations, providing that a little calculation is employed. Assume the following problem:

- A. A FAN furnace rated at 210,000 BTU per hour
- B. It has a 6" outlet
- C. The vent needs to be only 12-1/2' high to meet termination requirements
- D. There will be a 2' lateral

Table I shows the following MAX capacities for a 5" vent

at 15': 226,000 BTU  
at 10': 194,000 BTU  
32,000 BTU difference

For 12-1/2', take one-half the difference ( $1/2 \times 32$ ) or 16,000 and add it to 194,000. Result: 210,000 or just right for this situation.

Comment: This example also illustrates how the tables may be used to reduce vent size if there is adequate height and capacity to do so.

This interpolation process can also be used to estimate in-between capacities for intermediate lengths of laterals, as well as in-between minimum capacities.

**CAUTION!** There is no way to estimate in-between capacity between a zero lateral (straight vertical vent) and a 2' lateral (which has two elbows). If the vent has just one 90 degree turn, use the 2' lateral capacity.

#### 4-6 THE IDEAL VENT

Whenever possible, an individual vent should be located directly over the appliance outlet. If the outlet is horizontal, one 90 degree elbow should be used with the vent directly over it. A straight vertical vent is easily supported by the appliance, or by firestops, or it may be suspended from its flashing and storm collar.

There is no need to offset the vertical vent so as to include a tee and bracket. The use of a tee for cleanout or inspection purposes is quite unnecessary for three reasons. First, using a Rain Cap keeps debris out, as well as birds. Second, clean-burning gas does not produce any deposits needing removal. Third, vent joints are easily opened to inspect the inside of the piping.

Should an offset be needed, the use of two elbows for the purpose will provide somewhat greater capacity than an elbow and a tee.

---

## SECTION 5 CONNECTORS FOR COMBINED VENT SYSTEMS

### 5-1 GENERAL CONSIDERATIONS

Combined vent systems for two or more gas appliances of either type (FAN or NAT) must be designed to prevent draft hood spillage for natural draft (NAT) appliances and to avoid positive pressure for fan-assisted (FAN) appliances. The connector and common vent tables have been computed by examining the most critical situation for any operating combination. The connector tables are based on the most critical condition for that particular appliance when operating by itself, while the common vent tables show sizes that assure adequate capacity and draft whether one or all appliances are operating simultaneously.

All the parts of a combined vent must be checked for capacity. For connectors, the size must be determined from the tables, particularly for low height vents or where headroom restricts available connector rise.

### 5-2 A FUNCTIONAL DEFINITION FOR THE CONNECTOR

The connector in a combined vent system is defined here as the piping from a draft hood or flue collar to the junction of the common vent or to a junction in a vent manifold. Proper connector design is vital to obtaining adequate capacity. The connector must produce its share of the total draft, for its NAT or FAN appliance, and must deliver enough heat to the common vent so that the common vent can contribute the balance of draft needed

From a code installation point of view, the Type B gas vent connector is a "gas vent." It is essential, however, for system design purposes to use the word "connector" so that its rise and configuration may be explained and tabulated.

The connector tables for combined vents show MIN and MAX capacities only for FAN appliances because it has been found that no minimums are needed for NAT appliances with Type B gas vent connectors.

Important factors in connector design include:

- Connector Material
- Connector Length
- Connector Rise
- Number
- Appliance location as it affects the piping arrangement
- Number of attached appliances or different connector sizes
- Connection to an offset or manifold rather than directly to the vertical common vent

### 5-3 CONNECTOR LENGTH AND CAPACITY

The calculated capacity for both Selkirk and single wall metal connectors serving a combined vent is based on a length in feet of 1-1/2 times the diameter in inches as in the table below:

SIZE	3"	4"	5"	6"	7"	8"	10"	12"	24"
LENGTH	4.5'	6'	7.5'	9'	10.5'	12'	15'	18'	36'

Increasing the length of the connector increases minimum capacity and decreases maximum capacity. A rule-of-thumb for maximum capacity only is that doubling connector length reduces its capacity by 10%. Also, a 1' difference (more or less) will not have a noticeable affect. Figure 7 shows that both vertical and horizontal vent piping must be included in connector length.

When horizontal lengths in excess of those stated above are necessary, the minimum capacity of the system should be determined by referring to the corresponding single appliance table. In this case, for each appliance the entire vent connector and common vent from appliance to vent termination should be treated as a single appliance vent (of the same size as the common vent), as if the others were not present. Any appliance failing to meet the MIN input may be prone to creating excessive condensation or insufficient draft within the vent system if operated by itself. In such case, options may include relocation of appliances, selective sequential or simultaneous operation of appliances, or separate vent installations.

FIG. 7 - CONNECTOR LENGTH MEASUREMENT

### 5-4 CONNECTOR RISE ESTIMATION

In combined venting, connector rise is the vertical distance traveled by the hot gases between the appliance draft hood outlet or flue collar up to the point in a junction or interconnection where mixing occurs with gases from another appliance.

Examples of various connector arrangements in Figure 8 show how to estimate rise. If a small connector enters a much larger manifold fitting, rise is based on the height of the smaller connector to where it enters the larger one. To be conservative and obtain full capacity, it is best to underestimate the rise.

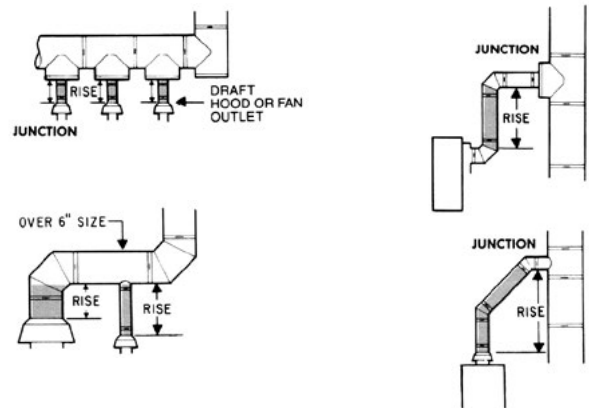

CONNECTOR RISE IS MEASURED AS THE VERTICAL DISTANCE FROM THE TOP OF THE DRAFT HOOD OUTLET TO THE LOWEST POINT OF INTERSECTION OF THE CONNECTOR AND THE COMMON VENT OR MANIFOLD.

FIG. 8 - CONNECTOR RISE MEASUREMENT

### 5-5 IMPORTANCE OF CONNECTOR RISE

Taking advantage of connector rise can result in using lower heights for the common vent. The connector rise table shows how this works. Assume a 63,000 BTU per hour NAT appliance with a 4" outlet is to be vented in combination with a much larger one. The following total heights are tabulated for a 4" size connector using Table 111.

CONNECTOR RISE	TOTAL HEIGHT
1'	50' (49' of common vent)
2'	15' (13' of common vent)
3'	8' (5' of common vent)
5'	5' (self-venting, needs no common vent)

The benefit of greater connector rise is illustrated in Figure 9.

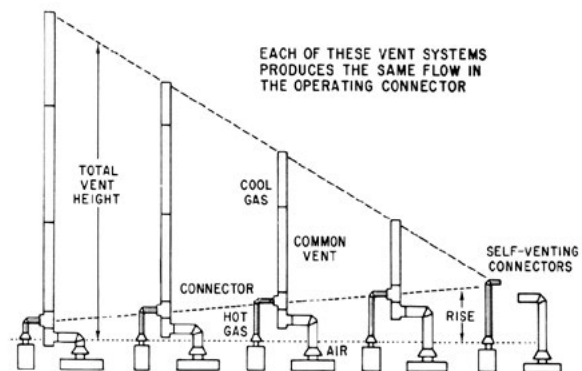

FIG. 9 - BENEFIT OF GREATER CONNECTOR RISE

### 5-6 CONNECTOR TURN LIMITS: ELBOWS AND TEES

To obtain full capacity, connectors for a combined vent should be limited to two 90 degree turns; either two elbows or an elbow and a tee as previously shown in Figure 3. If more turns are needed, there are three choices:

- A. Use the next size larger connector (this may increase minimum capacity)
- B. Use 1' more rise, if this is possible
- C. Reduce maximum connector capacity by 5 percent for each additional elbow up to and including 45 degrees. For each additional elbow greater than 45 degrees up to and including 90 degrees, reduce maximum vent connector capacity by 10 percent.

Choices A and B are illustrated in Figure 10.

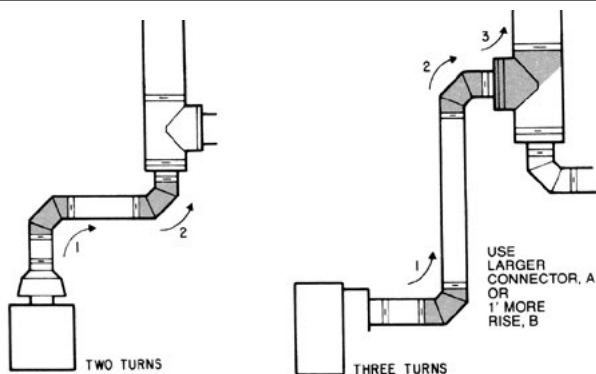

FIG. 10 - CONNECTOR TURN EXAMPLES

### 5-7 CONNECTOR SIZE COMBINATIONS

Computations for the combined vent tables give capacities for combining any two sizes of connectors, from two of the same size, up to allowing a larger connector having six times the area of the smaller. This limit also allows up to seven appliances having the same size connectors to be attached to a manifold or common vent.

The combined vent tables apply to combining any two draft hood or flue outlet sizes in the following ranges:

When the smaller is	3"	4"	5"	6"	7"	8"	10"
The larger may not exceed	7"	10"	12"	14"	16"	20"	24"

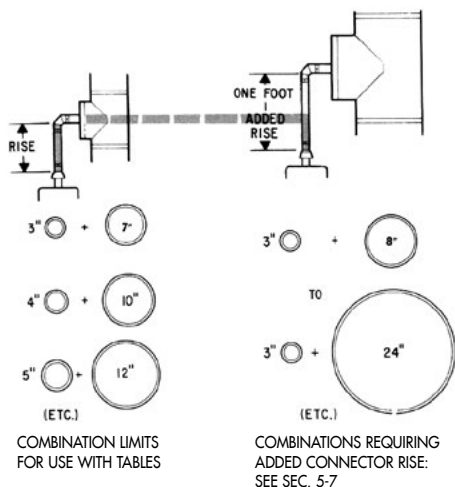

FIG. 11 - SIZE COMBINATIONS ALLOWED

If the larger draft hood exceeds the restrictions shown, the choices are:

- A. Increase the rise of the smaller connector by 1'. Use 2' of rise to get the same capacity as shown for 1' of rise. This choice is illustrated in Figure 11.
- B. Use the next larger connector, but make sure that it will operate at greater than its minimum capacity.

### 5-8 CHOICES FOR CONNECTOR CONFIGURATION

As long as connector rise and length requirements are met, it does not matter if the connector runs vertically then laterally, or laterally then vertically, or is sloped at any angle up to the common vent connection. The piping arrangements shown in Figure 12 for draft hood appliances are equally suitable for fan-assisted appliances.

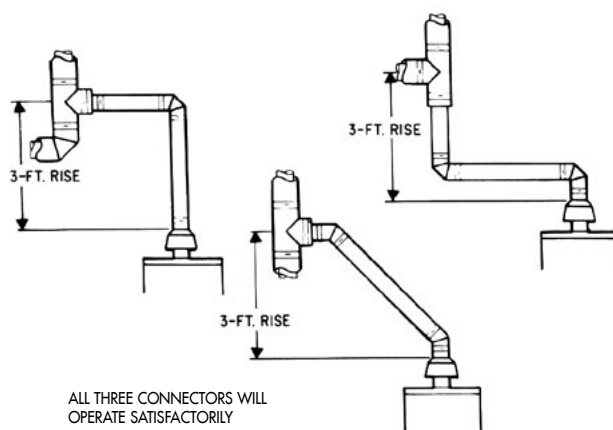

FIG. 12 - CONNECTOR DIRECTION CHOICES

### 5-9 USE AVAILABLE HEADROOM FOR BEST OPERATION

The rise in the connector of a combined vent system can be its most effective part. Take advantage of Type B gas vents 1" minimum clearance to ceilings or floor structure either for better venting or to eliminate the need for a possible size increase. This means that the interconnection tee is best located as high as possible as shown in Figure 13.

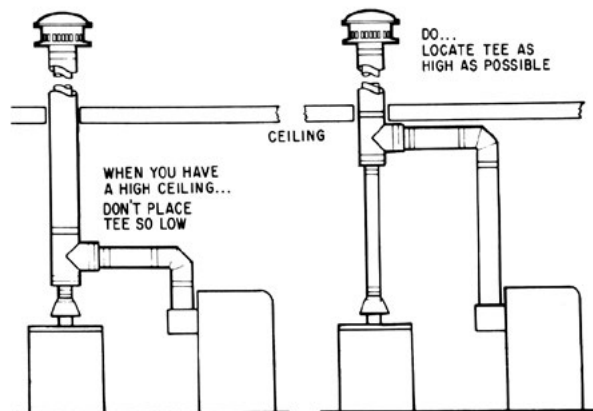

FIG. 13 - USE CONNECTOR RISE EFFECTIVELY



## 5-10 WHEN IN DOUBT USE LARGER CONNECTOR

Especially for combined vents, the maximum input for a connector may not allow it to be the same size as the draft hood or flue collar and a size increase may be needed. Also, if there is any uncertainty that connector rise may be insufficient, use the next larger size and increase the size directly at the draft hood outlet. This simple size increase precaution will help avert draft hood spillage or positive pressure problems with a fan-assisted appliance.

## 5-11 SELF-VENTING CONNECTORS

If any connector attached to a combined vent system has a rise of 5' or more, it may be installed as though it were an individual vent, using the appropriate individual vent table. This rule applies, for example, where Type B connectors enter the common vent in an attic. Allowance must be made in such cases for lateral length and number of turns. An attic interconnection is shown in the lower right hand corner of Figure 14.

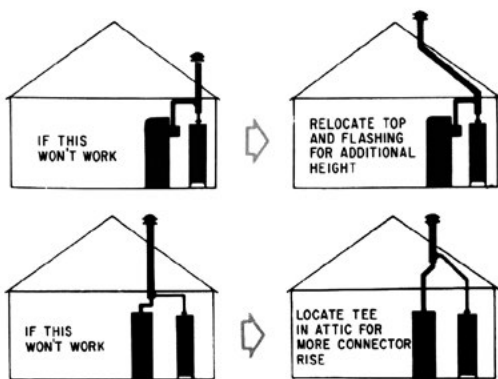

FIG. 14 - RELOCATE TOP OR TEE

# SECTION 6 COMMON VENTS

For purposes of this Handbook, the common vent is any part of the system carrying gases from two or more appliances. Thus, a manifold at the lower end of the system is also a part of the common vent. Common vents may be vertical above an interconnection tee, or they may have an offset. The first part of this discussion treats common vents serving two or more appliances at one level or floor. Multi-story common vents are covered in Section 7.

For low attics and flat roofed construction, a common vent system may be more expensive and less desirable than two individual vents. The installation of two individual vents as shown in Figure 15 eliminates two elbows, one tee, and possibly can use smaller sizes of Type B gas vent.

SHORT COMBINED VENTS  
MAY REQUIRE MANY  
FITTINGS, LARGE PIPING

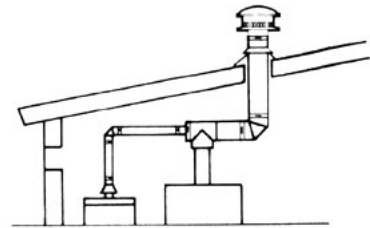

INDIVIDUAL VENTS PROVIDE  
GREATER RELIABILITY...  
MAY BE LESS EXPENSIVE

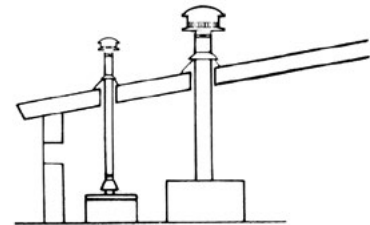

FIG. 15 - INDIVIDUAL VENTS PREFERRED

## 6-1 APPLIANCES WHICH CAN USE COMMON VENTS

Both draft hood and fan-assisted appliances may be common vented in any combination, as indicated by the headings in the common vent table. Appliance types include:

- Central heating furnaces
- Central heating boilers (hot water and steam)
- Water heaters
- Unit heaters
- Duct furnaces
- Room heaters\*
- Floor furnaces\*

\*If these have draft hoods, an appropriate design input increase of 40 percent is recommended in order to use the tables (see Section 4-1 also).

## 6-2 APPLIANCES WHICH CANNOT USE COMMON VENTS

The common vent tables do not apply to:

- A. Gas cooking appliances, which should be vented into an appropriate ventilator hood.
- B. Forced draft, commercial or industrial hot water or steam boilers without draft hoods. For this equipment see Sections 10 and 11.
- C. Clothes dryers which have high positive pressure exhaust systems and can also cause lint clogging.
- D. Categories II, III, or IV gas-burning equipment, for which the equipment manufacturer's venting instructions must be used.
- E. Gas-fired incinerators.

### 6-3 COMMON VENT INTERCONNECTION FITTINGS

Any tee used to join two connectors must be the same size as the common vent. The size of common vent called for by any of the three appliance combinations (FAN+FAN, FAN+NAT, NAT+NAT) determines the size of the tee. Using too small a tee will restrict flow when both appliances are operating. Correct choice of tee size is shown in Figure 16. This same rule applies to tee fittings used in manifolds, as will be discussed in Section 6-6.

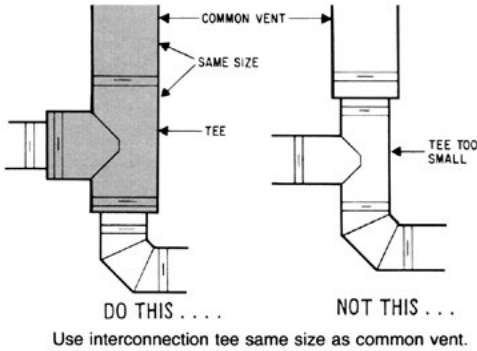

FIG. 16 - PROPER TEE SIZE FOR INTERCONNECTION

### 6-4 SIZE CHOICES FOR THE COMMON VENT

The common vent must be as large as the largest connector, but may not need to be any larger if sized in accordance with the tables. For example, a 30,000 BTU per hour NAT water heater is to be combined with an 80,000 BTU per hour FAN furnace. Outlet sizes are 3" and 4" respectively and total height will be 15'. A 4" common vent has a FAN+NAT capacity of 112,000 BTU per hour at 15' height, which is adequate for the combined input of these appliances. It is not necessary to use a larger common vent, if it is vertical above the interconnection tee, as shown in Figures 3 or 13.

### 6-5 OFFSETS IN COMMON VENTS

For each elbow in the common vent, up to and including 45 degrees, the maximum capacity listed in the sizing tables shall be reduced by 5%. For each elbow greater than 45 degrees up to and including 90 degrees, the maximum capacity listed in the sizing tables must be reduced by 10%. The two elbows which are generally used for such an offset should be adjusted so that the offset has as much upward slope as possible. An offset is illustrated in Figure 17, together with a reminder about reduced capacity.

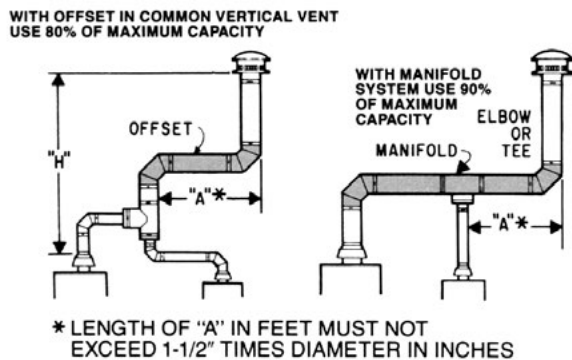

FIG. 17 - COMMON VENT OFFSET AND MANIFOLD

With an offset greater than 45 degrees located above an interconnection, maximum common vent capacity will be 80 percent or 0.80 times the input shown in the common vent table. Length of an offset should not exceed 1-1/2' for each inch of common vent diameter; 6' for 4" diameter, 7-1/2' for 5" diameter, etc. Length should be measured in the horizontal direction only. An offset sloped up at 45 degrees will have a horizontal length of roughly 0.70 times its actual length.

Where multiple offsets occur in a common vent, the total horizontal length of all offsets combined must not exceed 1-1/2' for each inch of common vent diameter.

For the example in Section 6-4, if there is an offset, capacity of 4" common vent would be  $0.8 \times 112$  or 89,600 BTU per hour. Capacity of 5" common vent would be  $0.8 \times 164$  or 131,000 BTU per hour, which is adequate. Connectors in this instance need not be increased.

### 6-6 COMMON VENT MANIFOLDS

A vent or connector manifold is a lateral extension of the common vent at its lower end, to which two or more gas appliances are connected. Sizing of this portion of the system must be determined from the **common vent tables** and not from the connector tables. The reason for this is the rule that any part of the system carrying gases from more than one appliance must be treated as the common vent.

### 6-7 MANIFOLD LENGTH

The length of a simple manifold must conform to the same rule as an offset. Manifold length in feet must not exceed 1-1/2 times the diameter in inches. A 5" size manifold must not exceed 7-1/2' in length, for example. Usually the lateral manifold joins the vertical part of the system through the side branch of a tee. Whenever a tee is used at the base of a vertical vent, it must be securely capped rather than just placed on a supporting bracket or plate to assure that there is no dilution or leakage which could diminish draft. Multiple appliances on a horizontal manifold as in Figure 18 should be installed as close together as practical, separated by a distance in feet not more than the connector diameter in inches (4" connector, not over 4' apart). This is particularly important for fan assisted appliances. If the appliances operate sequentially depending on load, the one nearest the vertical vent should start first.

Inclusion of a draft hood appliance with manifold fan assisted appliances can reduce the dewpoint of the vent gases and thus can also reduce the amount and duration of initial transient wettime.

### 6-8 MANIFOLD SIZE AND CAPACITY

Regardless of length, the capacity of a common vent having an inlet manifold should be taken as 90 percent of the value in the common vent tables. This configuration will frequently require a size increase over that needed for a vertical common vent.

When FAN appliances are being manifold vented, consideration must also be given to FAN MIN values. See discussion on compensating for extra length connectors in Sec. 5-3. Apply the same principles to manifold venting to assure that various appliances, if permitted to operate individually, will provide FAN MIN input necessary to prevent excessive condensation or loss of capability to produce draft in the vertical portion of the common vent.

## 6-9 CONNECTORS TO A MANIFOLD

All connectors to a manifold must have the required minimum rise. If a small connector enters the lower end of a large tee, as in Figure 8, the rise should be measured from appliance outlet up to the level of the size increase. This rule of adequate rise is extremely important if more than two appliances are manifolded. Many codes required that lateral parts of a venting system be sloped upward 1/4" per foot. This requirement has negligible benefits and may actually impair venting if the connector farthest away from the vertical vent does not get its proper rise.

If both NAT and FAN appliances are connected to a lateral manifold, locate and size the manifold so that both types have adequate rise. It does not matter if one or the other has more rise than necessary.

## 6-10 SLOPED VS. HORIZONTAL MANIFOLDS

Exceeding the minimum slope requirements for a manifold can cause trouble, such as draft hood spillage for the appliance most distant from the vertical vent. The lack of adequate connector rise for this situation is illustrated in Figure 18. It is far better to use a horizontal manifold than to slope it excessively.

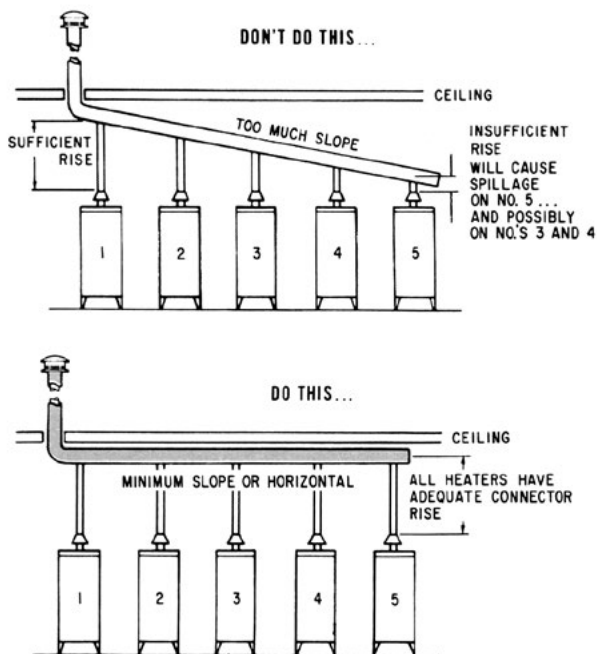

FIG. 18 - SLOPED VS. HORIZONTAL MANIFOLDS

## 6-11 TAPERED OR CONSTANT SIZE MANIFOLDS

Manifolds can be tapered for the actual input to the particular section, or they can be of constant diameter using the selected common vent size. There is no significant difference in operating characteristics of these two options, which are shown in Figure 19.

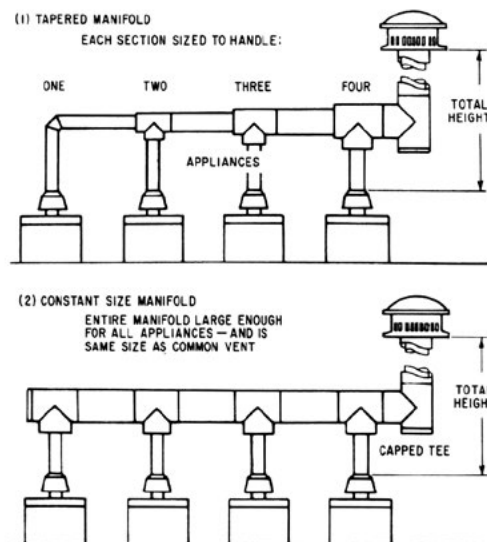

FIG. 19 - TAPERED OR CONSTANT SIZE MANIFOLD

**TAPERED** - For each section increase the total combined rated heat input by 11 percent (this is the same as reducing table capacity to 90 percent). Also, total height for that section can be found on the basis of the highest connected appliance outlet. As succeeding appliances are picked up, each input times 1.11 must be added to find the next size.

**CONSTANT SIZE** - Add up the rated inputs of all connected appliances and multiply this by 1.11. This number will be the design input for a manifold of constant size.

## 6-12 NUMBER OF MANIFOLDED APPLIANCES

Capacities for systems comprising up to seven identical appliances are covered in the connector and common vent tables. This also means that if the manifold has a combination of connector sizes, the total area of any group of larger sizes must not be more than six times the area of the smallest attached connector.

This rule of seven does not prohibit combining more than seven appliances or going beyond the area limit. For such instances, using 1' or more connector rise than needed or using a larger connector can solve the problem. For different connector sizes the rule of seven appliances or that the larger area must not exceed six times the smaller can be worked out using the table of connector areas below.

(Be sure to follow guideline outlined in 5-7)

Size	Area	Size	Area
3"	7 sq. in	12"	113 sq. in.
4"	13	14"	154
5"	20	16"	201
6"	28	18"	254
7"	38	20"	314
8"	50	22"	380
10"	78	24"	452

## 6-13 SINGLE APPLIANCES WITH TWO OR MORE DRAFT HOODS OR FLUE OUTLETS

Instructions for manifolding appliances having two or more outlets should be furnished by the appliance manufacturer. If not, the area of the manifold and its outlet connector should equal the sum of the outlet areas. If it is possible to shut off one or more of the side-by-side sections of such an appliance, all connectors into the manifold should conform to the connector rise provisions in the tables. Reason: The appliance will be operating as a combined vent, producing hot gases from only one section. If the sections cannot be shut off individually, the remainder of the vent system may be designed as an individual vent; otherwise use the appropriate common vent table.

## 6-14 BEWARE OF ALTERNATIVE SIZING RULES

Many building codes and vent piping installation standards contain alternate simplified rules for vent sizing based only on vent area. Beware of these. They do not take into account the many factors in good vent system design. Some of these rules date back to the days when masonry chimneys were the only choice and code writers were unaware of the proper technical basis for size estimation. Simplified rules can lead to three traps:

- First, they may result in an undersize vent which may not have adequate capacity.
- Second, they may prohibit the use of a vent the same size as the largest connector, which may be more than adequate in a variety of instances.
- Third, they completely ignore connector rise, which is the most important factor in combined vent system design, especially for draft hood appliances.

---

# SECTION 7 MULTI-STORY VENTING

## 7.1 GENERAL

A multi-story venting system is one which serves gas burning appliances located on two or more levels in a multi-story building or residence. At each level there may be a single appliance or there may be two appliances, such as a heating appliance and a water heater, manifolded and serving one particular occupancy or the entire floor. The heating appliances used for these situations are generally Category I central furnaces and boilers, which may be either draft hood or fan-assisted combustion types. Connection to a common vertical vent is made at each level, preferably with a connector or a connector manifold which does not penetrate the floor above.

## 7-2 INDIRECT APPLIANCES ONLY

An "indirect appliance" for purposes of this discussion is one which does not need to take its air supply from an occupied space. Such appliances may thus be located in closets or appliance rooms **separate or remote** from any occupied or habitable space. The closets or appliance rooms housing appliances on a multi-story vent must have access to outside air or to air from a non-habitable chase or air well. The procedures given here are for appliances which use conventional venting and are intended for connection to a Type B gas vent system. The type of furnace classed as a "direct vent furnace" is furnished with its own integral venting means and is thus not suitable for multi-story venting as described in this section.

## 7-3 INCLUDED APPLIANCES: DIRECT TYPES

Room heaters, wall furnaces, vented decorative fireplaces, and floor furnaces should not be served by a multi-story vent because these either obtain their air from occupied spaces or from under-floor areas which may communicate with occupied spaces. These appliances are termed "direct appliances" because in general their combustion air is taken "directly" from the heated occupied space. With "direct" appliances in modern, tightly sealed residences with low infiltration rates, the possibility exists for flow reversal in the vent due to wind or ventilation fan operation. Further, if there is a flow reversal or vent blockage with direct appliances on a multi-story system, combustion products could be discharged directly into an occupied space above. A direct appliance on a multi-story vent cannot be protected by spillage detection or an oxygen depletion sensor (O.D.S.) because these safety devices function only for the space in which the appliance is located. They cannot protect against a malfunction somewhere else in the system.

These considerations lead to the logical point that direct appliances should be individually vented and not interconnected on a multi-story vent. It is essential that safety devices function as intended so that a venting problem at any level will not affect any other appliance or occupied area.

## 7-4 FUNDAMENTAL DESIGN PRINCIPLES

A properly designed multi-story Type B gas vent requires more than just choosing the proper connector and common vent sizes. The appliance room or enclosure must be **separated** from any occupied space, preferably with sole access from an outdoor balcony or well-ventilated service area. A normally closed solid door into an occupied space is less desirable than access from an outdoor balcony. The **air supply** to the appliance room must always come from outdoors through grille-or louver-protected openings or ducts. The common vertical vent must be in a **location** which complies with building code requirements for fire resistance of the structure. Finally, sizing the connectors and the common vent **design** must follow rigorously the principles and dimensions to follow.

The recommendations for multi-story venting of gas appliances are theoretically sound and have proven themselves in many years of successful operation. The method of design of vents serving indirect appliances is simply an extension of previously developed combined venting principles and now applies to both draft hood and fan-assisted combustion appliances. The capability of multi-story venting combining these two types of appliances has been verified by laboratory tests. The venting and installation principles given here have also been incorporated into the National Fuel Gas Code ANSI Z223.1/NFPA 54.

### 7-5 SEPARATION FROM OCCUPIED SPACES

The separation of gas equipment from occupied spaces resolves the questions of safety arising from intercommunication of vents between various levels of a building. Separation insures that no flue products or vent gases can enter the building from the equipment room in the remote case that the common vent becomes obstructed at any level or the outlet is blocked. When such stoppage occurs, all vent gases from any draft hood appliance operating below the obstruction will exit through the upper connectors rather than through the vent outlet. Large quantities of flue products will be dumped into the space containing those appliances immediately below the obstruction, while at the same time appliances at lower levels will appear to be operating and venting normally.

Fan-assisted combustion appliances not having draft hoods will not encounter spillage problems, however, a vent blockage may force combustion products back through heat exchanger passages, possibly causing ignition or back pressure problems.

One practical plan used to separate or isolate the gas equipment is illustrated in Figure 20. Access to the gas equipment is through a door opening onto an outside balcony.

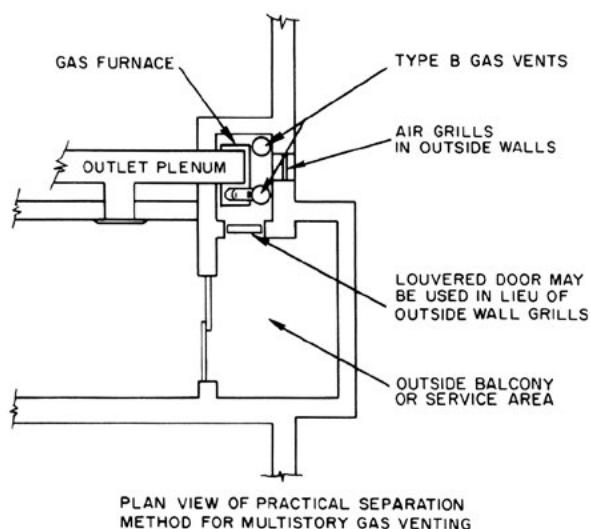

FIG. 20 - SEPARATION OF AIR SUPPLY FOR MULTI-STORY VENTING

### 7-6 AIR SUPPLY FUNCTIONS AND SOURCES

For indirect appliances delivering hot water or warm air to individual occupancies, a properly designed air supply serves several vital functions. Besides providing the gas units with air for combustion, ventilation, and draft hood dilution, an adequate air supply will maintain proper operation despite any venting obstruction or difficulty. If some type of malfunction causes flue or vent gas to escape into any appliance room, the air supply can provide a safe emergency vent gas exit. Any accumulation of additional combustion products caused by a venting obstruction or other difficulty can also be dispersed by the air supply. Thus, the air supply to the equipment room serves these five functions:

- A. Combustion air for the gas flame.
- B. Draft hood dilution air for proper venting.
- C. Ventilation air to avoid heat accumulations.
- D. Discharge to the atmosphere of vent gas escaping from appliances in the room.
- E. Discharge of vent gas accumulating in any appliance room, caused by venting obstructions in the common vertical vent.

### 7-7 AIR SUPPLY METHODS AND DETAILS

Air for indirect gas appliances located in separate rooms in a multi-level building can and should be taken from outside through building walls, from within air wells, or from ventilated chases. Occupancy of levels above and below every floor restricts the choice to horizontal supply through ducts or grilles, such as that shown in Section 8, Figure B. The other methods in Section 8 are not applicable as they presuppose ventilated attics or crawl spaces, or else they nullify the separation principle by using air from occupied spaces.

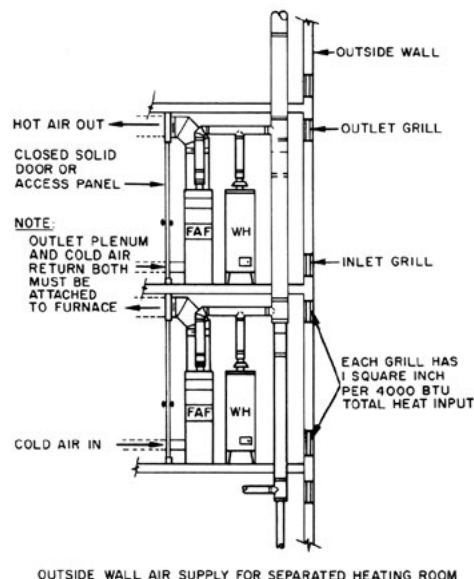

FIG. 21 - OUTSIDE WALL AIR SUPPLY FOR MULTI-STORY VENTING

To illustrate the ready applicability of the outside wall method, Figure 21 shows a small portion of a typical highrise venting system. A closed solid door or panel separates the appliance room from the inside of the building and both the cold air return and outlet plenum are attached to the furnace. Additionally, a change to horizontal ducts would permit the appliance room to be more centrally located.

Air supply to gas appliance rooms in multi-story buildings using the outside wall as shown in Figure 21 requires two openings. One opening should be at or near floor level and the other at or near ceiling level for best circulation. The required free area of each opening depends on the types of appliances in the room.

The required areas for openings, grilles, or ducts is based on Figure 24B in Section 8, "Providing Air Supply."

If ducts are used, they must also enter at floor and ceiling levels, but greater free area is required than for openings through a wall.

The table below gives free area requirements for openings or ducts as determined by the total rated input of appliances in a multi-story appliance room.

	Wall Opening	Ducts
Draft Hood Only	1 sq in/4,000 BTU	1 sq in/2,000 BTU
Draft Hood+ Fan-Assisted	1 sq in/4,000 BTU	1 sq in/2,000 BTU
Fan-Assisted Only	1 sq in/8,000 BTU	1 sq in/4,000 BTU

The vertical run of a multi-story vent may be located within a dedicated vertical chase or central core running from the lowest building level up through the roof. Use of this chase for ventilation air may further facilitate the location of appliance rooms by eliminating dependence on outside wall location for air supply. To serve as a ventilation air supply, the chase should communicate with the outdoors at both top and bottom, permitting normal thermal effects to create flow and assure a supply of fresh air at all levels.

### 7-8 COMMON VENT LOCATION

The location of all parts of a multi-story venting system must not compromise the fire protection required by the building code. The location should also protect (if possible) the vertical common vent from low ambient temperatures. It is undesirable to locate the common vent external to the building if an alternative protected location is possible.

For the system elevation in Figure 21, it must be assumed that the appliance room is built with rated fire walls, fire door, and that the floor penetration shown for the common vent is permissible.

Another location option for a multi-story vent is to place it in a fire rated shaft of its own with the appliance connector or manifold going through the wall to reach the common vent. This avoids floor penetration by the vertical vent.

### 7-9 APPLYING COMBINED VENT TABLES TO MULTI-STORY SYSTEMS

The following general design method for multi-story venting uses the combined vent tables. As with simple one-floor designs, connector rise and common vent height must act jointly to vent all attached appliances without draft hood spillage or causing positive pressure in any connector of a fan-assisted appliance.

By following capacity and height limits in the vent connector and common vent tables and the instructions illustrated in Figures 22 and 23, there is no limit to the height of the system or the number of floors which can be so connected. Also, the system will be sized to function properly when any one appliance or any combination or all appliances are operating.

A system serving a single draft hood appliance is illustrated in Figures 22 and 23. The system is divided into smaller simple combined vent systems, each with the minimum total height equal to the sum of connector rise plus distance between tees. Each vent connector (except the lowest in this instance) is sized using the vent connector table. Each section of vertical common vent must be large enough to carry the accumulated total input of appliances discharging into it.

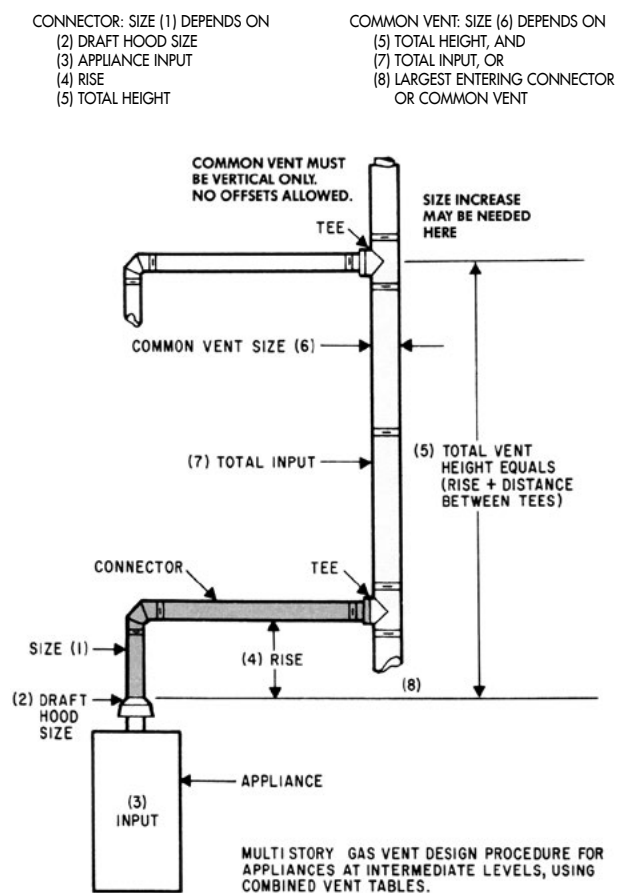

FIG. 22 - SYSTEM SEGMENT FOR MULTI-STORY VENT

The connector for the single appliance at the lowest level is sized as an individual vent, terminating at the first tee or interconnection. For two appliances at the first and succeeding levels, as in Figure 21, both the connector and common vent tables are used starting at the lowest level and a total height up to the next tee or interconnection.

At the second floor, the common vent for the appliance (or appliances) is considered to terminate at the next interconnection up, and so on to the highest connected appliance.

The top floor appliance must have total vent height adequate for its connector, as well as for the total accumulated input from below. Because this may necessitate a larger size vent or greater height above the roof, it may be preferable to use an individual vent for the top floor appliance. This results in greater total height for the next floor down and a possible reduction in vertical vent size.

### 7-10 EXAMPLE OF MULTI-STORY VENT DESIGN

Using the illustration of a multi-story vent, Figure 23, as a sample design problem, assume first that all four appliances are attached to a common vertical vent and that input of each is 100,000 with 5" draft hood outlets. The following table shows initial calculations.

Appliance	Total Input	Available Connector Rise	Total Vent Height	Connector Size	Common Vent* Size
1 (lowest)	100,000	12'	12'	5"	(Self-venting connector)
2	200,000	2'	12'	6"	7"
3	300,000	2'	12'	6"	8"
4 (top floor)	400,000	2'	8'	6"	10"

\* Vertical Common Vent

Next, assume that the top floor appliance is individually vented. For this reason it has been dropped from the revised table.

1	100,000	12'	12'	5"	(Self-venting connector)
2	200,000	2'	12'	6"	7"
3	300,000	2'	20'	6"	7"

The revised table shows that the added total height of vent eliminates a costly size increase and numerous fittings. Had the total height above the third floor appliance been only 18', a size increase to 8" would have been required. This also shows that it may frequently be less expensive to use a slightly higher vent where the added height permits choice of a smaller common vent.

### 7-11 SOME IMPORTANT PRECAUTIONS

- Offsets in the common vent are limited to a single offset and can not exceed 45 degrees from vertical. The horizontal length of the offset can not exceed 18 in./in. of the common vent diameter in which the offset is located. The common vent capacity listed in the common vent tables must be reduced by 20%
- Do not assume the total height for any appliance below the top floor to be the height to the common vent termination. No credit should be given to any height of common vent above the next interconnection up.
- Use available connector rise effectively, but if it is inadequate, use the next larger size connector. It is more important to size for maximum than minimum capacities.
- Connector manifolds as illustrated in Figure 21 should be sized just for their combined input and rise. They do not need to be the same size as the common vent at the interconnection tee. This entails either a size increaser going into the tee branch or the use of a tee with a branch inlet the same size as the manifold.
- The vertical body of an interconnection tee serving any level must be sized on the basis of the total cumulative rated input to the common vent above it. This means that the connector manifold will join increasingly larger tees at higher floors.
- Be sure that space for the common vent in its air shaft or chase allows room for fittings, clearance to combustibles, and access for proper assembly.
- Install a Rain Cap immediately to keep debris from entering and blocking the common vent.

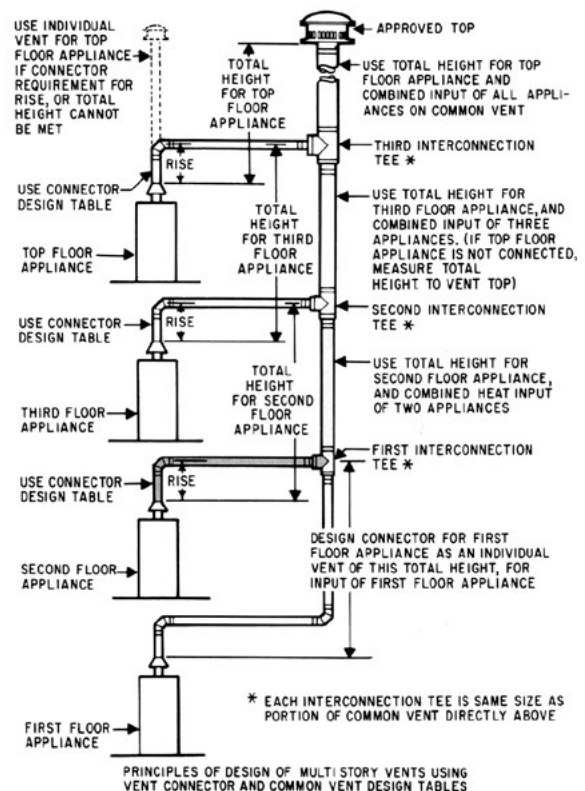

FIG. 23 - COMPLETE MULTI-STORY VENT SYSTEM

## 7-12 NUMBER OF CONNECTIONS TO MULTISTORY VENTS

Using the Combined Vent Tables, the connector rise of the entering connector must be 1' greater than shown wherever the common vent size becomes more than 7 times the area of that connector. This permits the first several appliances at lower levels of the multi-story system to use tabulated connector rises. As the common vent is increased in size at upper floors, connector rise may need to be increased 1' as soon as the common vent equals the 7 to 1 ratio. For constant size common vents exceeding the 7 to 1 ratio, the rise of all attached connectors must be 1' more than the tabulated values. This requirement obviously does not apply to systems employing self-venting connectors.

## 7-13 PARALLEL SYSTEMS

A great many applications may be connected to a single multi-story common vent using gas vent sizes up to 24". Such large vents require considerable space for access and are costly, as well as needing numerous increasing fittings. It may frequently prove more economical to group appliances into upper and lower common vent systems, so that smaller vent sizes can be used. Another suggested procedure is to use parallel common vents with staggered connections at alternate floors, thereby greatly increasing the least total height available to each connected appliance.

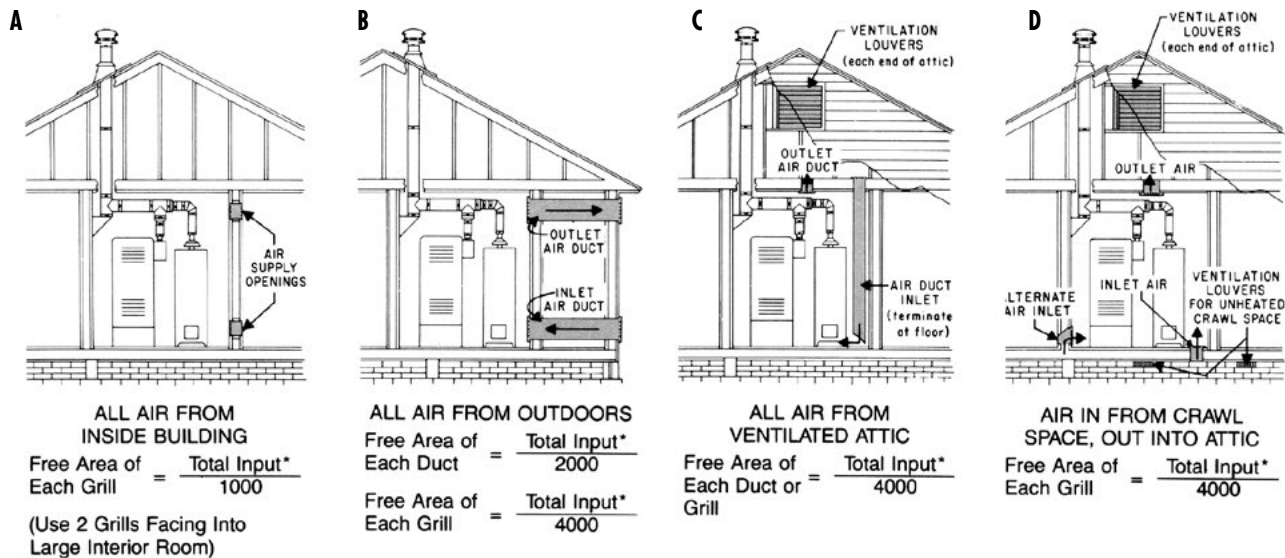

FIG. 24 - AIR SUPPLY METHODS ILLUSTRATED

# SECTION 8 PROVIDING AIR SUPPLY

## 8-1 AIR SUPPLY OPENING LOCATION

Make sure that all appliances and vents have an adequate air supply for combustion and venting using one of the methods shown in Figure 24 or an equivalent method. These suggestions are based on information in the National Fuel Gas Code, NFPA Standard No. 54, ANSI Z223.1. When installing the two openings, install one near floor level (at or below the combustion air opening of the appliance) and the other near the ceiling (above the relief opening of any draft hood). If ducts are used, cross sectional area of ducts and any grilles should be not less than the required free area of the opening.

Any of the methods shown in Figure 24 may be used in ordinary residential construction, however, method "B" with all air from outdoors is the only choice for appliance rooms in multi-story buildings.

## 8-2 AREA OF DUCTS OR OPENINGS

Required area for air supply depends on both the source and the type of appliance. Where the only appliance in the room is a fan-assisted type (FAN), air supply opening areas may be one-half of those for draft hood (NAT) appliances. For any appliance room with a draft hood appliance or a draft hood and fan-assisted appliance, full opening area is necessary. Required areas for the various methods are shown in the table accompanying Figure 24.



**REQUIRED FREE AREA FOR EACH OPENING OR DUCT, SQUARE INCHES  
BASED ON TOTAL INPUT\***

**APPLIANCE TYPES IN ROOM**

Air Supply Method	Draft Hood (NAT)	Combination (FAN + NAT)	Fan-Assisted (Fan Only)
A. All Air From Inside Building	sq. in. = Total Input 1000	Total Input 1000	Total input 2000
B. All Air From Outdoors Through wall Openings	sq. in. = Total Input 4000	Total Input 4000	Total Input 8000
B. All Air From Outdoors Through Ducts	sq. in. = Total Input 2000	Total Input 2000	Total Input 4000
C. All Air From Ventilated Attic	sq. in. = Total Input 4000	Total Input 4000	Total Input 8000
D. Air In From Crawl Space Out To Attic	sq. in. = Total Input 4000	Total Input 4000	Total Input 8000

\*Total Input - Total of all appliance nameplate input ratings.

# SECTION 9 MECHANICAL DRAFT AND POWER VENTING

This discussion covers the venting of fuel-burning equipment having sufficient flue gas pressure capability to be termed "forced draft." It also discusses use of auxiliary fans or blowers in various venting and chimney systems to produce draft or to overcome venting problems.

## 9-1 EQUIPMENT WITH BURNER INLET FAN OR BLOWER

There are three distinct variations in use of blowers at the combustion chamber inlet working in conjunction with the fuel burner.

**A.** Blowers which supply turbulent combustion air to aid fuel-air mixing in a combustion chamber which is under negative pressure. Residential pressure-atomizing oil burners are examples. To obtain proper negative overfire draft (which optimizes combustion) also requires steady negative (below atmospheric) pressure at the flue outlet. This will be produced by a natural draft chimney and may be controlled by a barometric draft regulator. This is tabulated on line "A" in Figure 25.

**B.** Blowers which supply sufficient combustion air and pressure to produce flow through the combustion chamber, but the combustion process does not need additional vent or chimney draft. This permits use of gravity or neutral draft venting products, such as Type B gas vent for conversion burners and Model DF chimney or ULTRA-TEMP for equipment burning oil, coal, or wood. A draft

regulator may be used for such equipment to prevent excess draft from affecting combustion or efficiency. This is tabulated on line "B" in Figure 25.

**C.** Blowers with enough power to overcome internal flue passage pressure losses (in fire-tube boilers for example) and which also produce positive pressure at the outlet. This outlet pressure must be added to gravity draft as the motive force for flow in a chimney. If positive outlet pressure exists, the use of a sealed pressure-tight chimney, such as Model PS or IPS, is required. This is tabulated on line "C" in Figure 25.

The above types of equipment usually have integral blower/burner systems and all could be considered forced combustion systems. Only those described in paragraph C, however, truly produce forced chimney draft.

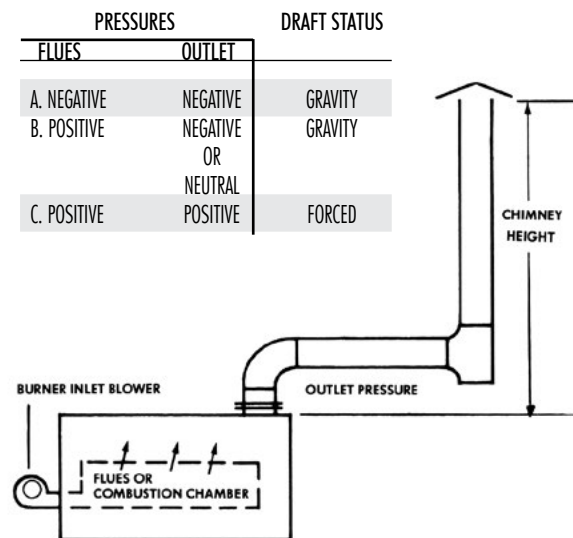

**FIG. 25 - DRAFT CONDITIONS WITH EQUIPMENT  
BURNER-INLET BLOWER**

## 9-2 INDUCED DRAFT EQUIPMENT

Flow of combustion air into the burner end of fuel-burning equipment may be "induced" by a fan or blower at the outlet end of the heat exchanger passages. This blower may be integral with the equipment or installed as a required auxiliary. Location at the combustion chamber outlet produces negative pressure in the combustion chamber, but vent or chimney pressure may be neutral for gravity flow as in Section 9-1 B, or positive to augment flow in the chimney, as in Section 9-1C. The three pressure conditions are tabulated in Figure 26.

## 9-3 FORCED OR INDUCED DRAFT VENTING

From the standpoint of pressures in a vent or chimney system with mechanical draft, there are two conditions:

**A.** Forced draft exists wherever the static pressure in the vent or chimney is greater than atmospheric, at the blower outlet for example.

**B.** Induced draft exists wherever the static pressure is less than atmospheric, at a blower inlet for example.

There are three possible locations for a draft blower or fan relative to the vent system:

**A.** Connector or breeching inlet (same as equipment outlet). With a blower at this location, producing greater than atmospheric static pressure in the vent, all parts of the system can be considered under forced draft. This location is shown in Figure 26.

**B.** Between the chimney connector and the vertical vent. With the draft blower somewhere in the piping between the equipment outlet and vent outlet (possibly at the base of the vertical chimney), the piping leading to the blower will be under induced draft, while the piping exiting the blower will be under forced draft. This location is shown in Figure 27.

**C.** At the vent or chimney outlet. This location places the entire system under induced draft, as in Figure 28, which illustrates an inducer serving a manifolded gas vent system. Location of an inducer at the terminus is preferred whenever the piping (vent or chimney) was originally installed as a gravity system. Outlet blowers are the choice if needed for products such as Type B, RV and QC, as well as for Models DF and ULTRA-TEMP

For gravity vent systems installed outdoors, use of forced draft

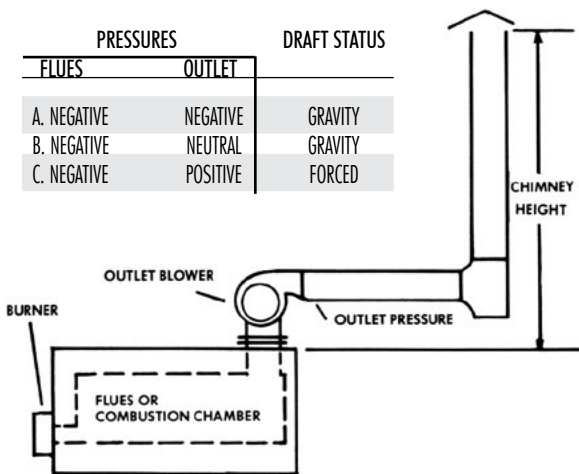

**FIG. 26 - DRAFT CONDITIONS WITH EQUIPMENT OUTLET BLOWER**

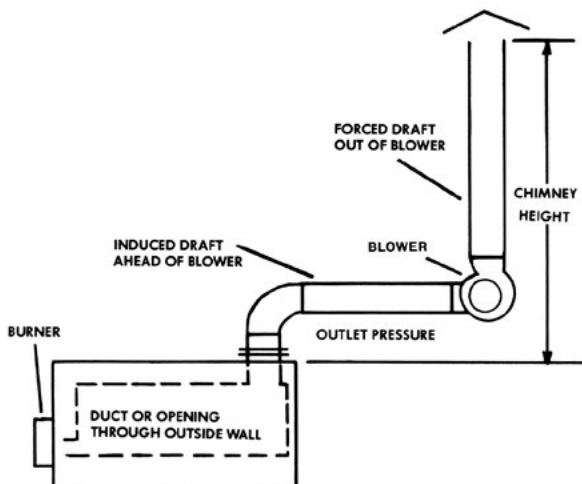

**FIG. 27 - SYSTEM WITH BOTH INDUCED AND FORCED DRAFT**

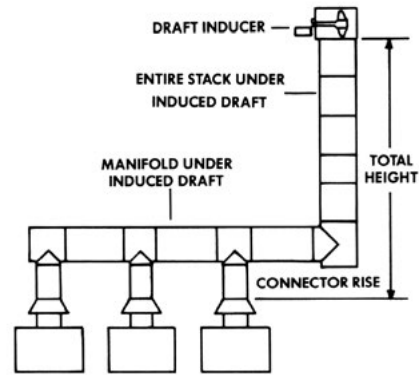

**FIG. 28 - INDUCED DRAFT SYSTEM FOR MANIFOLD DRAFT HOOD GAS APPLIANCES**

even for the outdoor portion is undesirable because of the positive pressure effect on system joints. Even though gas leakage out of the joints poses no hazard to occupants, such leakage may cause discoloration, condensation, and corrosion. With joint leakage, when burning oil or other corrosive fuels, product life may be severely shortened.

#### 9-4 USES OF AUXILIARY DRAFT EQUIPMENT

Draft boosters, fans, or blowers can solve a variety of venting problems:

- A.** Long horizontal vents, with inadequate rise or capacity, possibly created by restrictions on penetrating floors or roofs. An example is an exit blower where the vent exits through a wall.
- B.** Inadequate capacity due to space limitations or connection of larger equipment to an existing system.
- C.** Excessive number of turns creating high pressure loss and inadequate flow.
- D.** Need for greater draft or flow than a low height vent can produce.
- E.** Erratic or inadequate venting caused by wind, adverse internal pressures, restricted air supply, or indoor-outdoor temperature differences.
- F.** Need for greater draft hood dilution to prevent spillage or to reduce heat loss to surroundings by reducing gas and surface temperature of the vent.
- G.** Incorrect design of combined or manifold vent system with insufficient connector rise.
- H.** Roof location problems created by penthouses or nearby mechanical equipment.
- I.** Need to obtain high vertical exit velocity to meet code requirements for dispersing the discharge plume. The use of forced draft, even with moderate additional boost pressure of 0.50" water column, can increase capacity of a given chimney size. Forced draft will allow use of a vent or chimney with a smaller diameter than a gravity system.

There is an added cost of electrical power, plus the draft equipment itself, and of controls to prove vent or chimney flow before burner ignition is permitted.

### 9-5 PRODUCT APPLICATIONS WITH MECHANICAL DRAFT

For those Models RV, QC, DF, and Chimney products in the table below, the operating pressure requirement of neutral or negative requires that the draft inducer be placed either at the vent outlet or just ahead of the final single chimney length. Only the Model PS or IPS chimneys can operate at positive pressure, with mechanical draft equipment located anywhere in the system.

Type Classification	Model	Pressure limit *	Allowable Mechanical Draft
Type B	RV 3"- 8"	Neutral or Negative	Induced Only
Type B	QC 10"- 48"	Neutral or Negative	Induced Only
Building Heating Chimney & Type B	DF 10"- 24"	Neutral or Negative	Induced Only
Residential Chimney	6"- 14"	Neutral or Negative	Induced Only
Building Heating Chimney	PS 5"- 48"	Positive or Negative	Forced or Induced
Building Heating Chimney	IPS 5"- 48"	Positive or Negative	Forced or Induced

\* Neutral as used here means that internal/external pressure differences be within same limits as with gravity venting.

The Model PS and IPS chimney systems provide assurance of leak-free operation, together with versatility for use at any gas temperature up to 1,400 degrees F. and at any velocity or pressure likely to be encountered with heating or auxiliary power equipment. These product characteristics, together with the system design methods in Sections 10 and 11 of this Handbook, often permit worthwhile economies of space and chimney material.

### 9-6 SELECTION OF MECHANICAL DRAFT EQUIPMENT

Draft boosters and fans must be carefully matched to the venting or chimney system. The draft developed, flow rate, power requirements, and inlet and outlet size must all be taken into account. Details of choosing and matching such equipment are beyond the scope of this Handbook. Reference may be made, however, to the chimney chapter in the ASHRAE Handbook, Equipment Volume.

Because of the many possible approaches to design and selection, fan and blower manufacturers' literature should also be thoroughly studied. Section 10 has been prepared to aid in rapid estimation of vent chimney sizes for mechanical draft or for mechanical boost when operating at neutral or slightly negative internal gas pressures. More precise size estimation is possible by using the general design chart in Section 11 or the ASHRAE Handbook, chimney chapter.

For assistance in the selection or design of a Selkirk venting system to be used in conjunction with any well known power equipment, contact your Representative giving full information, including building plans and elevation, type of

draft inducer or power exhaust and heating equipment being specified, and all other pertinent data.

## SECTION 10 CAPACITIES THROUGH 48" DIAMETER

This section provides graphs for rapid preliminary estimation of gas vent and chimney sizes. For draft hood gas appliances with all Selkirk Type B vents from 14" to 48" diameters, Figure 29 and 30 show individual and combined vent capacities for selected configurations. For chimneys, sizes from 10" to 48", Figures 31, 32, and 33 show capacities for preselected draft conditions. These charts were obtained using a computer program based on the general design method outlined in Section 11. For more precise capacities or more accurate sizes the methods in Section 11 should be used. Using the tables for individual or combined gas vents is preferred over the use for charts for vents which are 24" size or less.

The gas vent capacities shown in Figures 29 and 30 provide extended and intermediate capacity values, thus extending the utility of this Handbook. Also, they indicate that there is no problem in using long laterals or heights greater than 100', provided that the entire system, from appliance to top, is Type B gas vent.

The graphs for chimneys Figures 31, 32, and 33 have been re-computed using resistance factors for Model PS chimney, as given in the product catalog. They show greater capacity than those in previous versions of this Handbook.

### 10-1 INDIVIDUAL GAS VENT GRAPH

The curves for input capacity versus vent size in Figure 29 were computed to yield conservative results over the entire size range. The assumed lengths of lateral should suffice for the majority of simple one-appliance systems. The lateral connector limits in Figure 29 also apply to any offset in the system, but only one such offset or lateral is allowed. The capacity values given also apply to a system with two elbows, as was shown in Figures 1 and 2. The lateral or offset must be the same material as the vertical vent.

Where Figure 29 indicates maximum lateral or offset length, capacity is for that exact length. For any shorter lateral, capacity will be greater, thus providing a margin of safety for graph values. For practical purposes, the graph values in Figure 29 are the same as those in the individual vent tables as they were derived by cross plotting and interpolating the original calculations.

## 10-2 COMBINED GAS VENT GRAPH

For combined gas vents serving appliances with draft hoods, Figure 30 indicates the size of the common vents only, or the size of a manifold for a given input and vent height. The capacities are thus conservative for vertical common vents serving just two appliances if there is no manifold or offset. In the 14" to 24" size range, the tables are to be preferred, however, Figure 30 is useful for heights greater than 100'.

At heights less than 100', the appropriate vent height and rise should be used to find connector size.

For heights greater than 100', the 100' height values in the vent connector table should be used. Common vent capacities are based on the length of offset or lateral shown on graph, Figure 30. For shorter laterals, offsets, or manifolds, capacity will be greater, thus the values in Figure 30 are generally conservative.

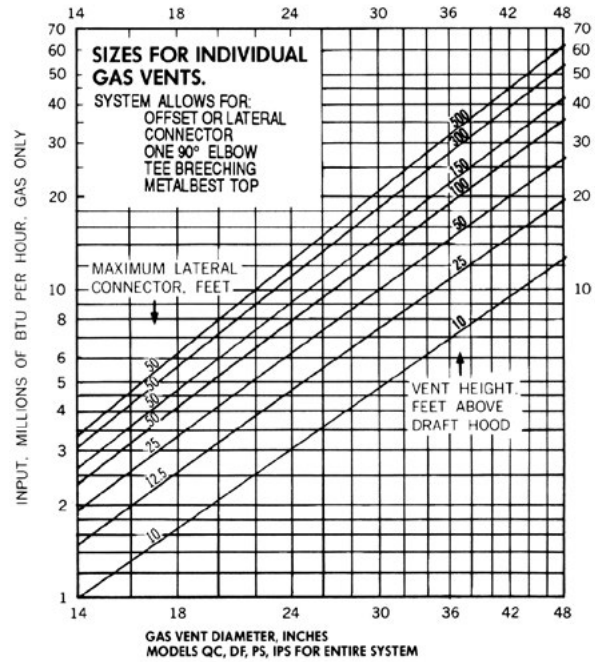

FIG. 29 - INDIVIDUAL VENT CAPACITIES THROUGH 48" DIAMETER FOR GAS APPLIANCES WITH DRAFT HOODS

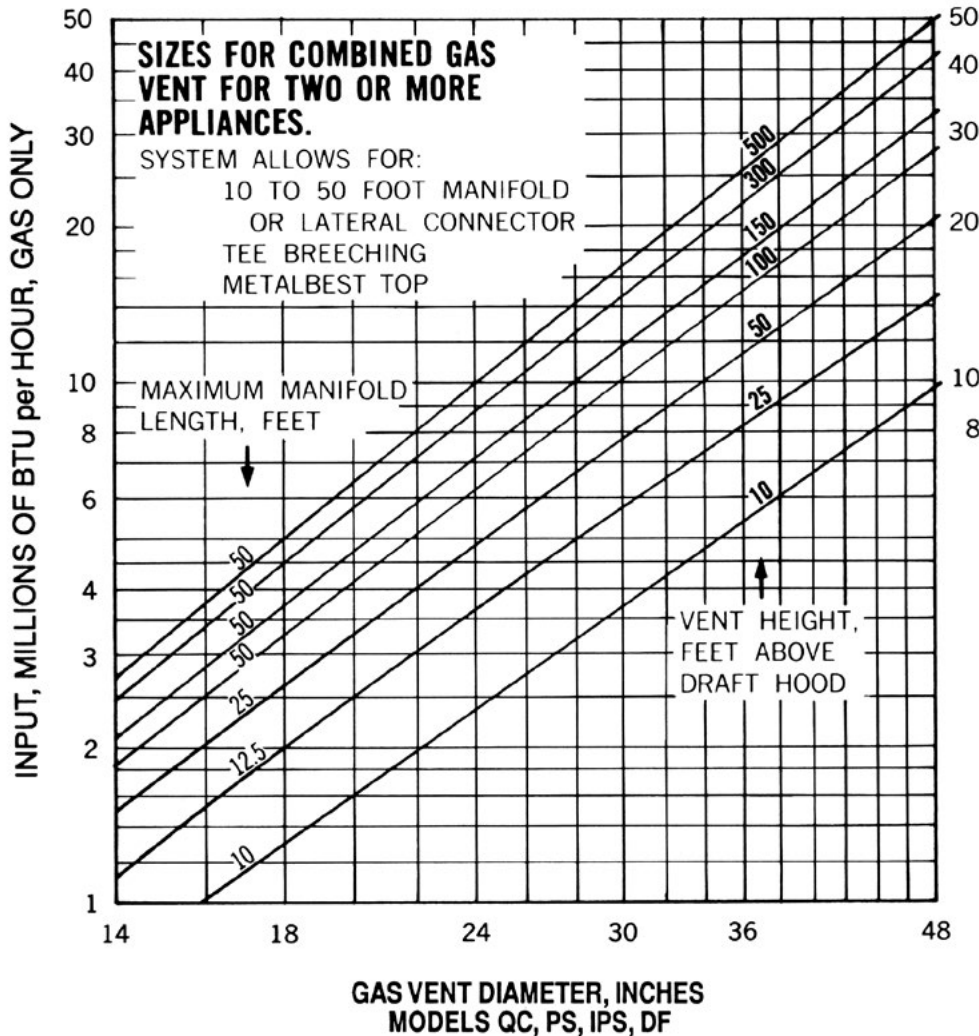

FIG. 30 - COMBINED VENT CAPACITIES THROUGH 48" DIAMETER FOR GAS APPLIANCES WITH DRAFT HOODS

### 10-3 CHIMNEYS FOR EQUIPMENT NEEDING DRAFT

Many types of fuel-burning equipment require negative (below atmospheric) static draft at their outlets. This draft may be needed to assure adequate combustion air, to overcome variations in flow resistance through a fuel bed, or to prevent escape of combustion products from the combustion system.

Draft and combustion requirements of specific equipment may be used to obtain a more precise estimate of chimney heights and sizes. For preliminary purposes, Figure 31 has been computed to show what heights and sizes will produce at least -0.10" water column draft. The values in Figure 31 apply to all the indicated fuels: gas, oil, coal, and wood, for equipment operating at reasonable efficiencies. If less than -0.10" draft is needed, a draft regulator should do the job.

The computations in Figure 31 (also for Figures 32 and 33) take into account factors such as the variation in friction factor with the Reynolds Number, and also heat loss from the chimney gases through chimney walls. An estimated overall heat transfer coefficient of 0.50 BTU per hour, square foot, degree F temperature difference was used. This 0.50 value is appropriate or conservative for Models DF, ULTRA-TEMP, and PS. For Model IPS, the overall heat loss coefficient depends on insulation thickness and can be much less than the assumed value. Thus, Model IPS should produce slightly more draft due to its lower heat loss.

Studies of vents and chimneys larger than 10" diameter have shown that the effect of heat loss on capacity or draft drops appreciably up to 18" size. Above that size, heat loss can be neglected as a major factor in determining draft. For consistency, however, the heat loss parameter was used in calculations.

Systems needing draft need a certain minimum height. As the theoretical draft tabulation in Section 11 shows, theoretical draft at 300 degrees F. above ambient is roughly 0.50" water column per 100' of height. For 0.10" water column of draft (negative), minimum height will be one-fifth of 100, or 20'. Figure 31 shows a minimum height of 25' because some of the draft energy is used to overcome friction losses in the chimney piping.

### 10-4 CHIMNEYS FOR NEUTRAL DRAFT EQUIPMENT

Equipment not requiring chimney draft operates in the same manner as a Category I fan-assisted combustion appliance. With a fan or blower as part of the combustion system, there may be no need for the chimney to aid the combustion process. This brings the minimum chimney height down considerably, as only enough theoretical draft is needed to overcome flow losses in the chimney itself.

In Figure 32, a minimum height of 10' is shown, but it could be less. Comparing Figures 31 and 32 at 100' height shows that there is very little difference. For 24" diameter, capacity in Figure 32 is 17.7 million BTU per hour for a neutral draft appliance. For one needing -0.10 draft, capacity of 24" diameter is 16.0 million BTU per hour, as shown in Figure 31.

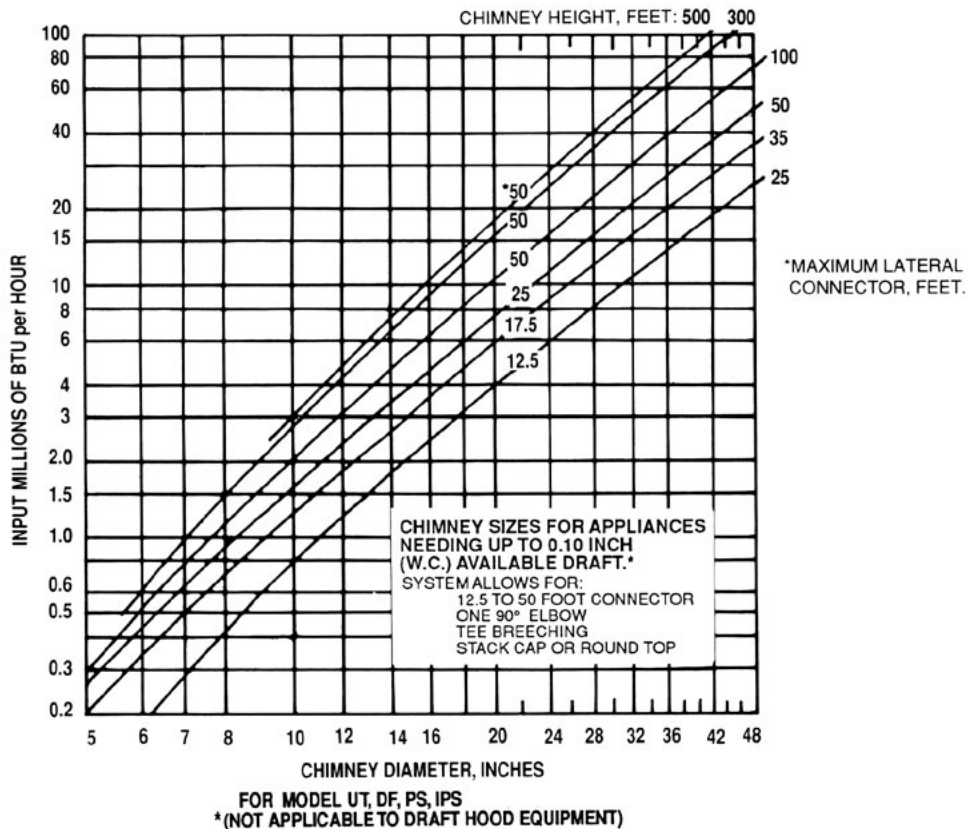

FIG. 31 - CHIMNEY SIZES FOR APPLIANCES NEEDING DRAFT  $\Delta p = D_t - 0.10$

### 10-5 CHIMNEYS OPERATING AT FORCED DRAFT

Many boilers and other types of fuel-burning equipment have sufficient blower power to develop positive outlet flue gas pressures. A common operating condition for their chimneys is at 0.50" water column greater than atmospheric pressure. With this much pressure added to theoretical draft, chimney size may be smaller than for neutral or negative draft systems. On the other hand, positive pressure requires a chimney which can be sealed at all joints. For positive pressures of 0.50" water column, Figure 33 indicates capacities to 500' of height. For a 100' high 24" diameter, capacity is just under 25 million BTU per hour as compared to 17.7 million for the same neutral draft system. Conversely, for 17.7 million BTU per hour, a 22" diameter chimney will be more than adequate at 0.50" of forced draft.

A word of caution: The forced draft graph Figure 33 must not be used to size systems using ULTRA-TEMP or Model DF chimneys, or QC gas vent. It is applicable only to Model PS and IPS chimneys.

Also note that operation with forced draft allows long lateral lengths without concern for priming of the chimney. For any height given in Figure 33, the allowable lateral length (or offset) is 50'.

### 10-6 GENERAL FACTORS FOR CHIMNEY SIZING GRAPHS

As noted, the graphs, Figures 31, 32, and 33, for chimney size are applicable to five fuel selections: natural gas, propane, No. 2 oil, heavy oil, and coal/wood. For these choices, the parameters of flue gas temperature and composition were selected as tabulated here:

Fuel Selection	Chimney Inlet Temp. Rise Degree F.	CO2 Percent	Oxygen Percent	Excess Air Percent	Mass Flow LB/1000 BTU
Natural Gas	350	8.5	5.98	36.04	1.001
Propane	455	10.0	5.72	33.9	0.992
No. 1 & 2 Oil	400	12.5	3.72	20.5	0.916
No. 4,5,6 Oil	420	13.5	3.91	21.81	0.929
Coal/Wood	500	15.0	4.10	23.77	1.006

The curves for input vs. size represent exact solutions for the specific vent configurations given, using the above natural gas factors. Comparison of capacities using the flow factors for the other fuels indicates that sizes selected on the basis of natural gas input will be conservative for these other fuels. Other standard factors include operation at sea level with an ambient temperature of 60 degrees F. If the equipment operating conditions conform to the parameters in the table, chimney selection can be made from the appropriate graph.

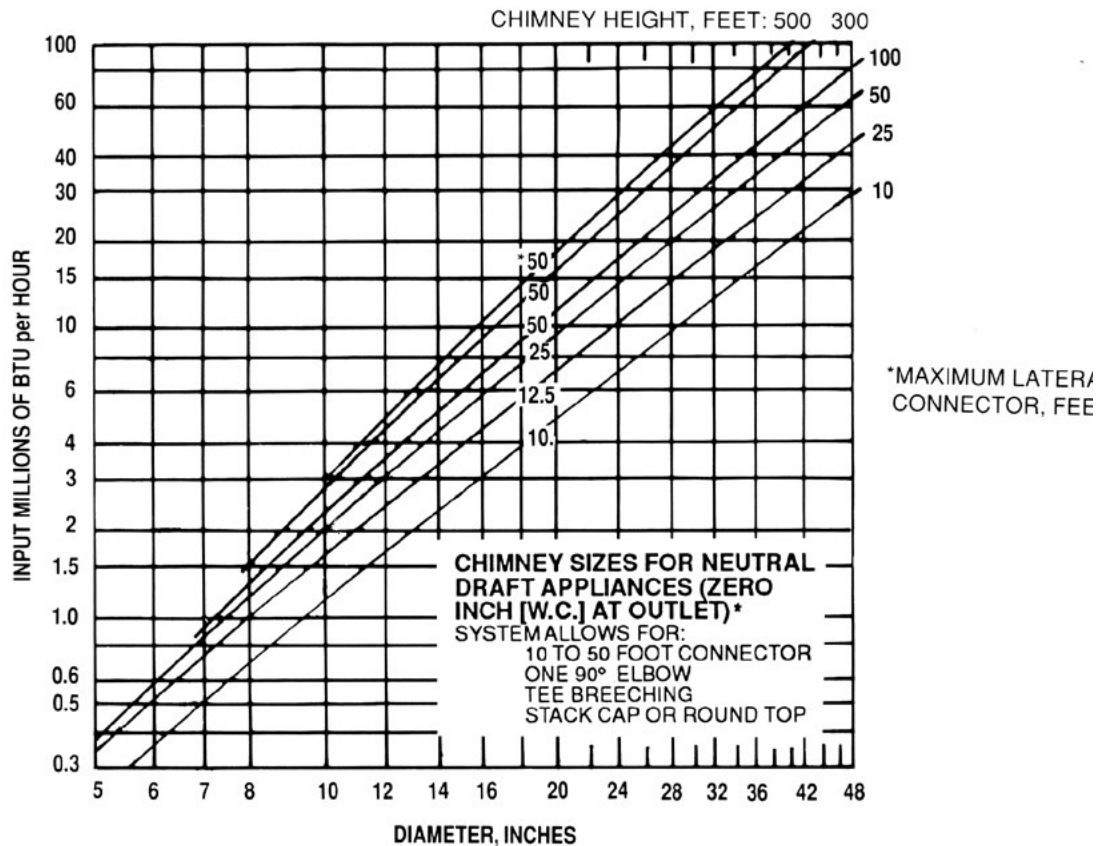

FOR MODELS UT, DF, PS, IPS  
 \*(NOT APPLICABLE TO DRAFT HOOD EQUIPMENT)

FIG. 32 - CHIMNEY SIZES FOR NEUTRAL DRAFT EQUIPMENT

The sizes and draft capability of systems using natural gas and propane have been compared with results from the Battelle computer program VENT II V 4.1. The comparison indicates that capacities given for those gases are adequate. Specifically, when Model PS resistance coefficients are used, VENT II V 4.1 shows that the chimney will produce negative, neutral, or positive pressure draft using the same operating parameters as were used for three graphs.

Regardless of sizes suggested by the graphs, selection should be conservative unless there are constraints, such as available space in a building. Excessive negative draft can be controlled by a chimney damper. A system designed to operate with neutral draft will not experience difficulties if draft pressure is slightly negative. To be conservative does not

require a great increase in size. For example, if the input and configuration call for an odd dimension of chimney—say 23"—a 24" diameter chimney will be adequately conservative. Similarly, where the size comes out exactly, a small increase in height will increase draft or capacity as needed.

For solid fuels, the calculations for coal and wood do not take into account ash, tar, or creosote deposits or accumulations inside a chimney. If the equipment used is expected to create such deposits, a size increase allowance is desirable, together with an inspection and maintenance program to prevent excessive buildup.

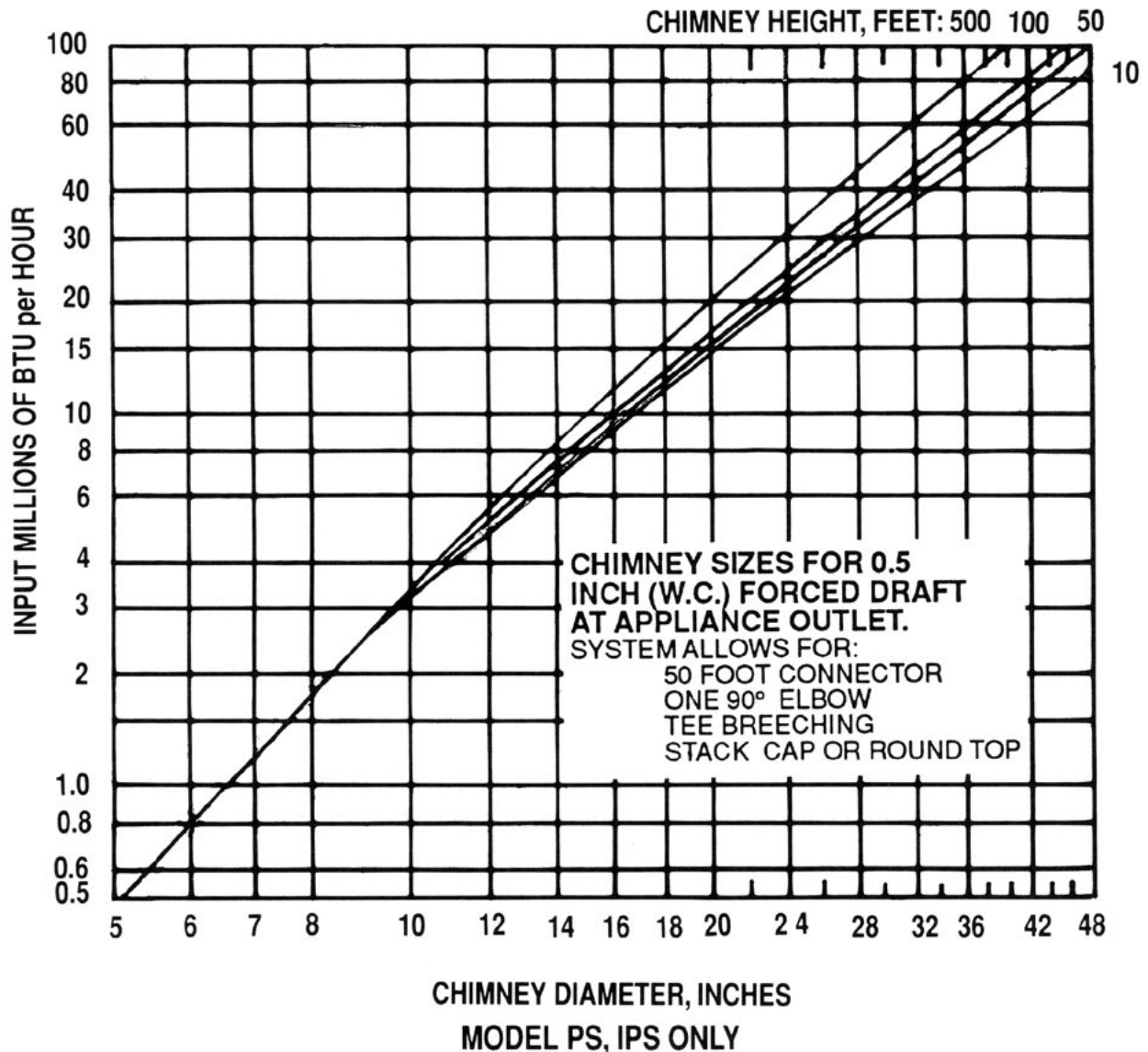

**FIG. 33 - CHIMNEY SIZES FOR FORCED DRAFT EQUIPMENT**

# SECTION 11 GENERAL DESIGN METHODS

For chimney systems of any complexity or differing from the specific configuration shown in Section 10, the general chimney design chart, Figure 34, can be used. This chart, technically a "Cascade Chart," is based on equations first published by ASHRAE in 1971. The equations and resulting design method are explained in the ASHRAE Handbook Equipment Volume, Chimney Chapter, and are given here in the sections to follow.

## 11-1 THE CHIMNEY DESIGN EQUATION

$$I = 4.13 \times (10)^5 \frac{(di)^2}{M} \left( \frac{\Delta p B}{k T_m} \right)^{0.5} \quad (11) \text{ in Chimney Chapter ASHRAE Handbook}$$

- I = Input, Btu per hour
- di = Inside Diameter, inches
- M = Mass Flow in piping, lb. gas per 1000 Btu input
- $\Delta p$  = Pressure drop, inches of water
- B = Barometric pressure, inches of mercury
- k = System flow resistance, velocity heads
- Tm = Mean chimney gas temperature, degrees Rankine or (degrees F + 460)

This equation is intended to be used for chimneys and gas vents 10" diameter and larger. It does not account for heat losses (cooling of gases). Theoretical studies have shown that for sizes over 18", heat loss has little effect on capacity or size. In the 12" to 18" size range, heat loss is of diminishing importance. For smaller sizes of gas vent, 12" and less, the use of tables is to be preferred.

The chimney design equation requires that actual conditions in the vent or chimney be used to get a correct solution. For draft hood appliances, gas composition, temperature, and mass flow values must be those in the gas vent. For direct connected appliances with no barometric damper, the appliance outlet and chimney inlet flow conditions are exactly the same. If a barometric damper is used for draft control, it is desirable to design for slightly more draft than is actually needed. For example, if the equipment needs 0.04" W.C. draft, design for 0.06 should allow for variations in system operation. Gas composition, temperature, and mass flow with a barometric damper, however, should be the same as for direct-connected equipment.

As an example, assuming the vent system factors in Section 10-6 for natural gas, the chimney design equation may be solved for input with the following values for a 100' high, 24" diameter chimney with a 50' lateral. Fittings used are: 90 degree fixed elbow (k=0.30), 90 degree tee (K=1.25), and stack cap (k=0.50). The equipment will operate with a temperature rise of 350 degrees F. and 8.5 percent CO<sub>2</sub>. PS Catalog value for piping flow resistance at a total length L of 150' using a piping friction factor of 0.3 is:

$$k = 0.3 (L/di) = 0.3 (150/24) = 1.875$$

Total flow resistance is:

Elbow	0.30
Tee	1.25
Cap	0.50
Piping	<u>1.875</u>
k=	3.925, system total flow resistance

Next, and very important, the value of Dp must be found using the table below and the Theoretical Draft Table. For this example, the approximate column for theoretical draft is used.

These same equations for " $\Delta p$ " are also for use with the design

### PRESSURE EQUATIONS FOR $\Delta p$

Equipment Outlet Pressure	Da= Avail. Draft	$\Delta p$ Equations
<b>1) Negative:</b> Needs draft equal to Da	Subtract Da from Dt	$\Delta p = Dt - Da$
<b>2) Neutral or zero:</b> draft hood or fan assisted category I appliance	Da equals zero	$\Delta p = Dt$
<b>3) Positive:</b> forced draft pressure equal to Da	Add Da to Dt	$\Delta p = Dt + Da$
<b>4) Any of above with draft inducer producing Db</b>	Add Db as needed	
1b) Negative + inducer		$\Delta p = Dt - Da + Db$
2b) Neutral + inducer		$\Delta p = Dt + Db$
3b) Positive + inducer		$\Delta p = Dt + Da + Db$

NOTE: All "D" and " $\Delta p$ " values are in inches water column static pressure

chart. For neutral draft (or zero equipment outlet pressure), internal piping losses will be equal to theoretical draft, which is a Dp of 0.55" W.C. per 100' of height. Ambient temperature is assumed at 600F. Operating gas temperature is the sum of rise plus ambient or 410 degrees F. The equation uses absolute temperature, Tm = 410 + 460 degrees F. absolute. Reviewing these factors:

- k = 3.925
- di = 24"
- M = 1.001 at 8.5% CO<sub>2</sub>
- $\Delta p$  = 0.55" water column
- B = 29.92" of mercury (sea level assumed)
- Tm = 410 + 460 = 870 degrees F. absolute

The exact numerical solution to the equation is 16,497,614, or for practical purposes 16.5 million BTU per hour. The graph for this same diameter, Figure 31, shows a capacity of 17.7 million BTU per hour. The difference is due to use of a lower piping friction coefficient (0.228 rather than 0.30) in the computer program for the graph, together with more precise theoretical draft, with some allowance for heat loss. Therefore, it can be seen that the equation or the general design chart as illustrated here gives conservative results.

## 11-2 THE CHIMNEY DESIGN CHART

The multi-section cascade chart, Figure 34, contains the necessary factors for a graphical solution to vent and chimney capacity or sizing problems. Very little math is needed to set up resistance and pressure loss factors, as will be shown subsequently. After a little practice, simply drawing a few lines on a copy of this chart will provide a quick, useful estimate of chimney or vent size.



### 11-3 DESIGN CHART RECOMMENDED FACTORS

The tables to follow are for guidance in selecting reference points and lines on the design chart, or for solution of the design equation.

#### CHIMNEY AND VENT DESIGN CONDITION

FUEL	APPLIANCE	CO <sub>2</sub> % t,	RISE F
Natural Gas	Direct Connected Appliance	8.5	430
Natural Gas	Draft Hood, In Vent System	5.3	300
Natural Gas	Fan-Assisted Category I	7.0	227
Propane	Direct Connected Appliance	9.0	470
Propane	Draft Hood, In Vent System	6.0	300
Propane	Fan-Assisted Category I	8.0	284
Oil	Residential	9.5	440
#1, 2 Oil	Over 400,000 BTU/Hr	12.5	400
Heavy Oil	Commercial/Industrial Boiler	13.5	420
Coal/Wood	Commercial/Industrial Boiler	15.0	500

#### CONVERSION FACTORS

BTU per Hour Input = Boiler Horsepower x 44,000
= Gallons per Hour Oil x 140,000 (Nos. 1 and 2)
= Gallons per Hour Oil x 150,000 (Nos. 4, 5, 6)
= lb. per Hour Coal x 13,000
= cu. ft. per Hour Natural Gas x 1,000
= kilowatts x 3,414

#### FLOW RESISTANCE COEFFICIENTS

k values (velocity heads, dimensionless) for sizes 10" and larger.

COMPONENT	PRODUCE	
	QC, DF	PS, IPS
90 Degree Elbow	0.75	0.30
45 Degree Elbow	0.25	0.15
30 Degree Elbow	—	0.12
90 Degree Wye	—	0.60
90 Degree Tee	1.25	1.25
45 Degree Lateral Tee	—	0.40
Drain Section	—	0.25
Exit Cone	—	1.25
Stack Cap, Round Top	0.5	0.50
Piping - Boiler Stacks	0.3(L/di)	0.3(L/di)

#### GENERAL FACTORS

Draft Hood	1.5
Barometric Regulator	0.5
Direct Connection	0.0

#### INITIAL ASSUMPTION FOR DESIGN CHART

Direct connected vent or chimney	k= 5.0
Combined gas vent	k = 7.5

For combined gas vent, after first trial, multiply assumed k of system (components + piping) by 1.5 to obtain appropriate design flow resistance coefficient.

For k value to use in equation or chart. k = sum of resistances of all components plus piping factor.

#### THEORETICAL DRAFT AT SEA LEVEL, Dt

(Relative to 60 degree F. ambient)

Dt, Draft per 100' of Height, Inches Water		
Chimney Temperature Rise, Degrees F.	Approx Dt	Precise Dt
100	0.2	0.237
150	.3	.329
200	.4	.408
300	.5	.537
400	.6	.639
500	.7	.721
700	.8	.843
900	.9	.932

Approximate values recommended for use with design chart or equation.

#### EXCESS AIR PERCENT TO CO<sub>2</sub> CONVERSION

The following equations convert excess air percent (XS) to CO<sub>2</sub> percent (dry basis) if operating conditions are in terms of excess air.

NAT. GAS	CO <sub>2</sub> =1072/(XS+90.11)
PROPANE	CO <sub>2</sub> =1261/(XS+91.63)
NO. 2 OIL	CO <sub>2</sub> =1444/(XS+95.00)
NO. 6 OIL	CO <sub>2</sub> =1577/(XS+95.00)
COAL/WOOD	CO <sub>2</sub> =1822/(XS+97.70)

#### ALTITUDE CORRECTION (FOR CHART ONLY)

Multiply operating input by factor to obtain design input for chimney, stack, or connector.

ALTITUDE	FACTOR	B. BAROMETER
Sea Level	1.00	29.92" Hg
2,000'	1.08	27.8" Hg
4,000'	1.16	25.8" Hg
6,000'	1.25	24.0" Hg
8,000,	1.34	22.3" Hg
10,000,	1.45	20.6" Hg

### 11-4 STEPS TO USE DESIGN CHART, FIGURE 34, FOR SIZING

**A.** Find out flue gas CO<sub>2</sub> (or excess air) and temperature rise. If these are not known, use appropriate values from "design conditions" Table in 11 -3.

**B.** From temperature, height, and draft needed, estimate "Δp" using "theoretical draft" and "pressure equations." Examples of Δp calculation as used for Figures 31, 32, and 33 cover three important cases.

**C.** Enter design chart along CO<sub>2</sub> percent line in "A" grid.

**D.** At fuel line (natural, oil, etc.) go vertically to temperature rise line in "A" grid.

**E.** Turn left at temperature rise, horizontally, to transfer line in "B" grid.

**F.** Go up (or down) to line for first assumed system resistance k, either 5.0 or 7.5.

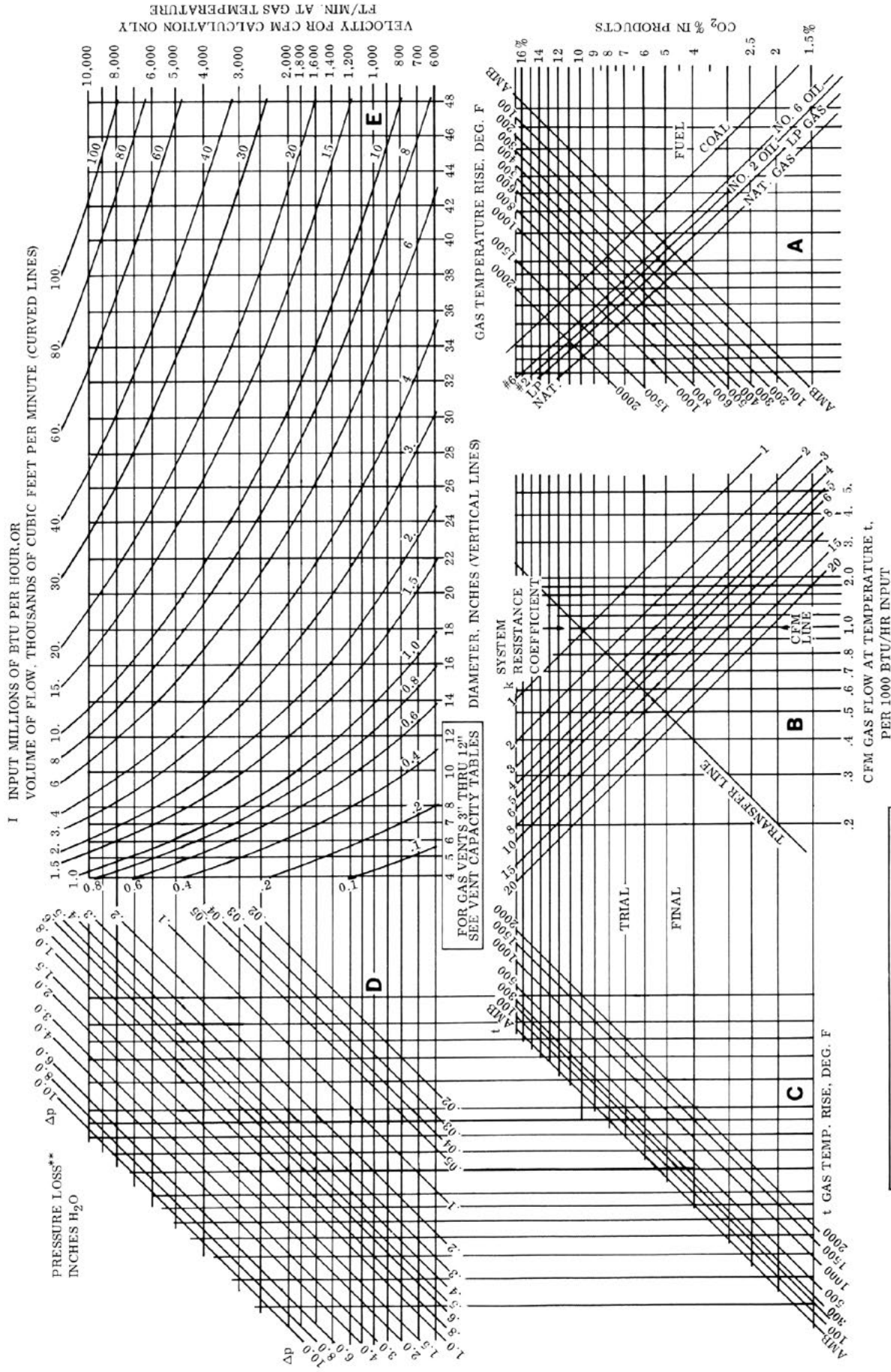

DESIGN CHART FOR VENTS CHIMNEYS, DUCTS,  
APPLICABLE TO COMBUSTION PRODUCTS AND AIR

**EXAMPLE**

**FIG. 34 - GENERAL CHIMNEY DESIGN CHART**

- G. Turn left again, horizontally, to temperature rise line in "C" grid.
- H. At temperature rise in "C," go vertically to the  $\Delta p$  value as previously calculated in "D" grid.
- I. From  $\Delta p$ , go horizontally to right to or between curved lines of input as appropriate in "E" grid.
- J. Read size below intersection with curved lines.
- K. Refigure system flow resistance of piping using size  $d_i$  (Just found) in piping length equation: " $k=0.3L/d_i + \text{components}$ ," as given in equation example.
- L. Repeat steps C through K until the same size is obtained on successive tries. (It should not take more than three passes.)

### 11-5 EXAMPLE USING DESIGN CHART TO FIND GAS VENT

GIVEN: Six draft hood-type gas boilers on a constant diameter manifold. Each is fired at 1,600,000 BTU per hour. Manifold is 80' long. Total vent height is 400'. Elevation is 6000 feet (see altitude correction). Connector rise is 4'. System is all double wall Type B. Boilers are individually controlled.

Find diameter of manifold, common vent, and connectors.

See Figure 35 for the boiler and vent system diagram.

Solution is by drawing horizontal and vertical lines on chart as in Figure 36. Simultaneous operation determines manifold and vertical common vent size. Altitude correction is 1.25, so that combined design input is  $6 \times 1,600,000 \times 1.25 = 12,000,000$  BTU per hour.

Operating condition for a natural gas draft hood appliance is given as: 300 degree rise at 5.3% CO<sub>2</sub>. (See chimney and vent design conditions table).

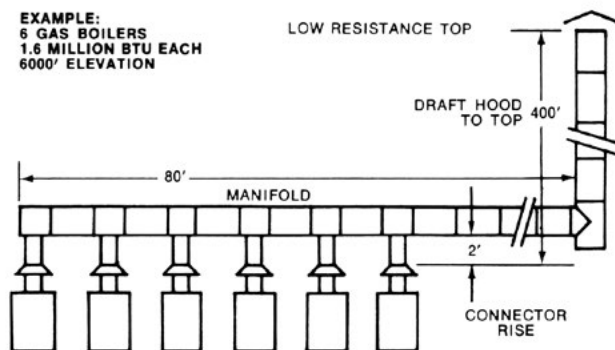

FIG. 35 - EXAMPLE OF MANIFOLD GAS VENT

- A. Enter grid A at 5.3% CO<sub>2</sub> line, go to natural gas line, then vertically to 300 degree rise.
- B. Go to transfer line in grid B then to assumed  $k=7.5$ . At this point, follow dashed line for first trial. (For subsequent  $k$  values, any flow path includes a draft hood, two tees and the top.)
- C. Go horizontally to 300 degree rise in grid C.
- D. For 400' of height at 300 degree rise four times the value per 100 feet:  $\Delta p = 4 \times 0.5" = 2.0"$  W.C. (From approximate Dt column)
- E. Go from C to  $\Delta p = 2.0$  in grid D.
- F. Go horizontally to grid E at 12 million BTU.
- G. Read first approximate size is 22" diameter.
- H. Recompute  $k$  as follows:

	Draft Hood 1.5
	Two Tees 2.5
	<u>Top 0.5</u>
Total fittings	4.5
Piping $0.3(480/22)$	<u>6.5</u>
TOTAL $k$	11.0

- Multiply total  $k$  (11.0) by 1.5 for combined vent to get design  $k$ ,  $11.0 \times 1.5 = 16.5$
- Repeat steps A through G using new  $k = 16.5$  (This is solid line shown on Fig. 36 which leads to second trial diameter of 28")
- Recompute piping  $k$  factor  $k=0.3(480/28) = 5.1$ 

Add total fittings	<u>4.5</u>
Total $k$	9.6
Multiply total $k$ (9.6) by 1.5	=14.4
- New design  $k = 14.4$
- Repeat steps A through G, shown as dashed line, with  $k = 14.4$ .
- Result is diameter just under 28", therefore use 28" size for manifold and common vent.
- For connector size, input of each boiler must be corrected for altitudes using 1.25 factor. Use  $1,600,000 \times 1.25 = 2$  million BTU per hour at 4' of rise.

The vent connector table (III) shows capacity of an 18" connector as 2,220,000 BTU per hour at 4' rise. This is the size to use unless the boiler needs a larger connector, in which case the connector must be the same size as the draft hood outlet.

For connectors, the rule is that with two sizes to choose, always use the larger size, even if it is greater than draft hood outlet size.



---

# SECTION 12

# CHECKING

# VENT

# SYSTEM

# OPERATION

The major purpose of this Handbook is to provide dimensional and capacity information for venting systems to assure prior to installation that there will be adequate vent capacity and trouble-free operation. Many vents in the field, however, may deviate from these recommendations yet not pose any problems. Just because dimensions may differ is no automatic indication of a real or potential malfunction. Conversely, due to numerous variables in appliance operation and system surroundings there may be an occasional venting difficulty despite every effort to meet codes and follow capacity tables. A common problem involves the choice between complying with the venting code, which may allow an alternate but inadequate size of vent, and the tables which call for a possibly more expensive venting system.

The use of fan-assisted combustion appliances alone or in combination opens some new possibilities for things to go wrong either in a venting system or with the appliance itself. For both draft hood appliances and fan-assisted appliances, the problems which may be related to the venting system are discussed in the following text.

## 12-1 DRAFT HOOD SPILLAGE

This is the escape of flue gases from the relief opening of the draft hood of a NAT appliance. On start-up, a little spillage of short duration is normal, but if it does not stop after a minute or two, there may be something wrong in the vent system. Spillage may be detected by introducing smoke into the flue products ahead of the draft hood or by observing if the flame of a match goes out when it is held at the edge of the draft hood relief opening. The way to do the match test is shown in Figure 37, which is taken from the gas vent installation instructions.

Common causes of continued draft hood spillage due to problems in the vent itself include the following:

- A. Inadequate connector size in a combined vent system.
- B. Insufficient connector rise in a combined vent system.
- C. Blockage in the system, which may be partial or total.
- D. An excessively long connector (especially if it is single wall).
- E. Too many 90 degree fittings --- excessive flow resistance
- F. Vent not high enough.
- G. Incorrect cap causes flow restriction.
- H. Pressure or thermal effects discussed in Sections 12-2, 12-3,

---

Complete all gas piping, electrical, and vent connections. After adjusting the appliance and lighting the main burner, allow a couple of minutes for warmup. Hold a lighted match just underneath the rim of the draft hood relief opening. Proper venting will draw the flame toward or into the draft hood. Improper venting, indicated by escape or spillage of burned gas, will cause match to flicker or go out. Smoke from a lighted candle will also be drawn into the draft hood if the vent is drawing properly.

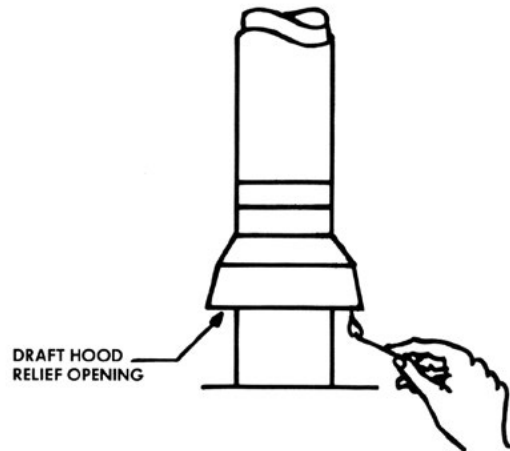

FIG. 37 - CHECKING FOR DRAFT HOOD SPILLAGE

---

and 12-4.

Once the cause has been determined as one of the above, the remedy can be found by checking the vent against the tables if it is otherwise unobstructed. In some instances it has been found that using a listed vent cap of low flow resistance (see cause G) will solve the problem.

## 12-2 APPLIANCE FAILS TO OPERATE

There are many possible reasons for an appliance to fail to operate, some of which may be related to the vent system. Others may be due to burner ignition or other control difficulties.

An undersized or otherwise improper vent system may cause a venting safety control to prevent burner ignition or shut it down if draft hood spillage occurs. With a fan assisted combustion appliance, under Category I conditions, positive pressure in the vent or inadequate vent flow may prevent or interrupt burner operation. With a draft hood appliance equipped with a spillage detection device, the burner may shut off if spillage continues for a period of time or the burner may operate intermittently for short periods. Its operating duration may be dependent on how long it takes for the spillage detection control to be activated.

If the vent is causing this problem, the size and configuration should be checked against the tables and other factors in this Handbook. Also, check for blockage or an improper vent cap. If the vent system is correct and there are no adverse indoor pressure conditions, finding the cause will depend on a careful analysis of the instructions for appliance installation, operation, and trouble shooting.

### 12-3 COLD BACKDRAFT

If a draft hood appliance is not operating and cold air is coming out the relief opening, this is actually not a venting malfunction. For this to occur there must be an indoor outdoor temperature difference which causes cold air to be drawn down the vent, such as might occur if the vertical vent piping is entirely outdoors. This flow reversal also can be caused by fan or fireplace operation. See Section 3-13 for more discussion of this problem.

A cold backdraft can also occur due to winds. A vent terminating improperly next to an outside wall or below the eaves can easily be reversed by a wind blowing against that wall. Cold air will enter the vent and exit through the draft hood because the vent will act just like a hole in the wall or an open window.

### 12-4 HOT BACKDRAFT

One way this problem can occur is if a cold backdraft has reversed flow in the vent and the appliance burner comes on. With cold air entering the top and flowing downward in the vent, this will appear to be draft hood spillage. This will cause total spillage of hot flue products because the vent will not be carrying away any flue products.

If the cold backdraft is caused by indoor mechanical equipment, such as a kitchen exhaust system, the vent may never prime. But, in the case of an unsteady wind, a drop in wind velocity may allow the vent to get started right.

A hot backdraft can also occur in a vent system combining a FAN appliance with a NAT appliance. If the common vent has insufficient capacity for the FAN appliance, or if it becomes blocked, some or all the products of combustion from the FAN appliance will be flowing out of the NAT appliance's draft hood. If the NAT appliance operates under these conditions, it will experience total spillage as well. Obviously, if this occurs, both appliances should be shut off until the situation is corrected.

### 12-5 GAS LEAKAGE AT JOINTS

The vent pressure capability of fan-assisted appliances varies widely, but regardless, a fan can produce more pressure in a vent than gravity flow. Draft hood appliances must have negative or below atmospheric pressure at the draft hood to draw in dilution air and prevent spillage. But, a fan-assisted appliance can produce both positive pressure and adequate vent flow at the same time. Appliances which do this fall into Category III or IV. Only a Category III appliance has a high enough outlet temperature to prevent condensation. Only Category I and Category III appliances have high enough vent temperatures to obtain gravity flow. Both also have the ability to produce gas leakage at product joints if used with an incorrectly sized Type B vent or a related gravity-only venting product (Type L is one).

Gas leakage can occur at piping and fitting joints or between elbow segments if there is positive vent pressure. This could be due to:

- A. Control malfunction on the appliance.
- B. An undersized vent.
- C. Any use of Type B gas vent on an appliance which creates Category III conditions in the vent; in other words, positive pressure.

The remedy to positive pressure causing joint leakage problems with either a Category I or III appliance is to use a larger or higher vent with increased capacity or to reduce its flow resistance.

The **incorrect** remedy and one which violates the Type B product UL listing is to tape the joints externally. This action forces wet combustion gases into the air space between inner and outer walls, leading to abnormal, excessive condensation and possible premature corrosion failure of the outer pipe.

### 12-6 CONDENSATION LEAKAGE

With appliances operating at average steady state efficiencies of 75 percent to 80 percent, the probability of condensed water actually dripping from Type B is so low that it can be considered negligible. This applies to most draft hood equipment of types such as furnaces, boilers, and water heaters. When steady state efficiencies rise above 80 percent and the appliance has no draft hood, the water vapor concentration in the vent will be higher and, thus, water can condense at a higher temperature (higher dew point because of no draft hood dilution air). If the vent gases are cooled excessively as with long laterals in cold, unheated locations, condensation leakage occurs if the vent does not warm up or there are repeated short operating cycles.

Condensate leakage is also a possibility if Type B is used on a Category II or Category IV appliance. The gravity venting capability of a Category II appliance is marginal and it is not possible to determine a usable minimum capacity. Any Type B gas vent used on either a Category II or Category IV appliance may encounter serious problems and should be replaced with a vent suitable for the application.

### 12-7 GAS AND CONDENSATE LEAKAGE

A Category IV appliance, falling in the very high efficiency class, produces positive vent pressure and very wet flue products at a temperature which is too low for gravity venting. Using a Type B gas vent on this type of appliance can lead to both gas and liquid leaks at all product joints. Category IV appliances require "special gas vents," the type of which may be furnished or specified by the appliance manufacturer. There is no other choice.

## 12-8 SUMMARY THE TROUBLE SHOOTING

The following table indicates by **X** marks which problem may be expected in the many possible combinations of appliance and vents. The analysis is very brief for Categories II, III, and IV because these appliances are not likely to be used with Type B gas vent, nor are they permitted to be combined with draft hood appliances.

**TYPE B GAS VENT TROUBLE-SHOOTING TABLE**

		DRAFT HOOD SPILLAGE	NO START OR EARLY SHUT OFF	COLD BACKDRAFT	HOT BACKDRAFT	GAS LEAKAGE AT JOINTS	LIQUID CONDENSATE LEAKAGE
<b>CATEGORY I APPLIANCES AND DRAFT HOOD APPLIANCES ON TYPE B GAS VENTS</b>	INDIVIDUAL VENT						
	NAT OFF			X			
	NAT ON	X	X		X		
	FAN OFF						
	FAN ON		X			X	X
	COMBINED VENT						
	NAT + NAT BOTH OFF			X			
	NAT + NAT ONE ON	X	X		X		
	NAT + NAT BOTH ON	X	X		X		
	FAN + FAN BOTH OFF						
	FAN + FAN ONE ON		X			X	X
	FAN + FAN BOTH ON		X			X	X
	NAT + FAN BOTH OFF			X			
	NAT + FAN FAN ON				X	X	X
	NAT + FAN NAT ON	X	X				
NAT + FAN BOTH ON	X	X		X	X	X	
<b>SPECIAL GAS VENT ONLY</b>	<b>CATEGORY II</b>		X				X
	<b>CATEGORY III</b>					X	X
	<b>CATEGORY IV</b>					X	X
<b>REFER TO SECTION 12-</b>		<b>1</b>	<b>2</b>	<b>3</b>	<b>4</b>	<b>5</b>	<b>6</b>

**TYPE B GAS VENT TROUBLE-SHOOTING TABLE**

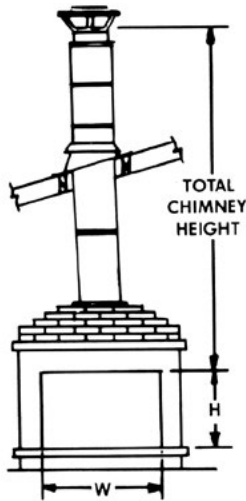

**Note:**  
Chimney offsets are limited to 30° from vertical and require no additional considerations.

**ALWAYS FOLLOW MANUFACTURER'S INSTALLATION INSTRUCTIONS.**

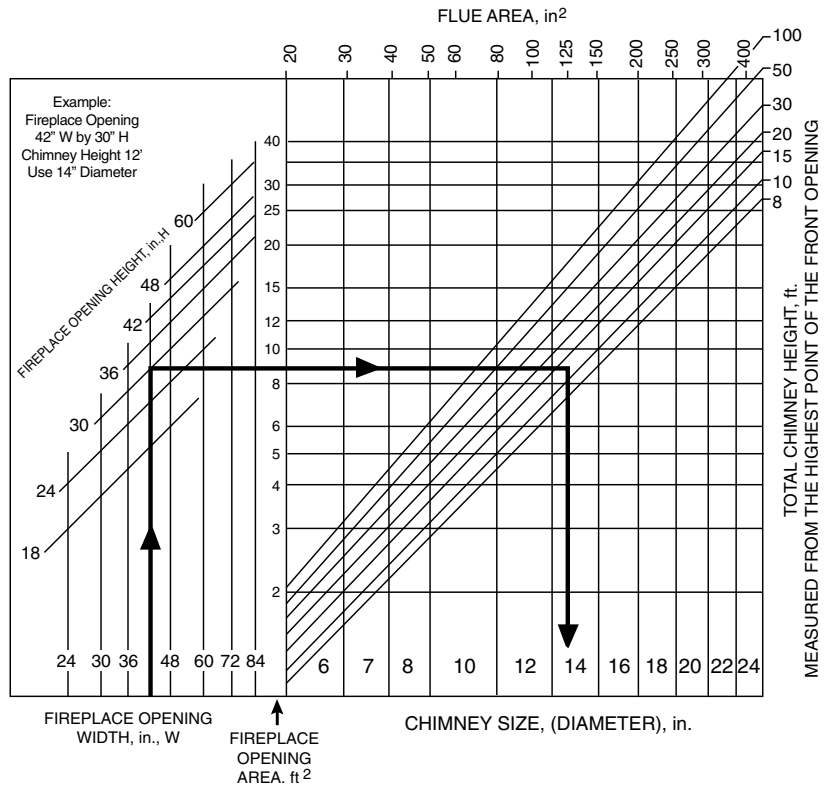

**FIG. 38 - CHIMNEY SIZING CHART FOR FIREPLACES**

# SECTION 13 CHIMNEYS FOR CONVENTIONAL FIREPLACES

A conventional fireplace is one of all-masonry construction or one having a steel shell which is intended for use with a wide open front. Whether or not glass doors are used, the correct size of chimney depends mostly on the maximum frontal opening area and chimney height. Ideally, if a damper is installed in such a fireplace, it should have a full open area of twice the chimney area or more. Otherwise, the restrictive effect or flow resistance of the damper may call for a larger or taller chimney.

Studies of fireplace operation have shown that to prevent smoking the average air inlet velocity into the full open area should be at least 0.80' per second, or about 50' per minute. This is comparable to the minimum capture velocity of conventional ventilation hoods over cooking appliances.

The chimney sizing chart, Figure 38, for fireplaces is based on obtaining an average air velocity of at least 0.80' per minute into the fireplace opening. The chart was compiled from an equation which assumes a reasonable size of wood fire (or gas logs) burning in the hearth area. Actually, except for very low or smoldering fires, required chimney size and height does not vary much with the size of fire. Also, the type of chimney selected has no effect on its required size and height.

Selection of the chimney type depends mainly on its surroundings. In combustible construction the choice is the Chimney, which is specifically intended for use with any solid fuel application. In non-combustible surrounding, Model DF, PS, or IPS can be used. For residential applications needing chimneys larger than 14" size, Models DF, PS and IPS can be enclosed in a masonry or other non-combustible chase to provide the necessary protection to surrounding structure. Fiber insulated Model IPS has been granted a Type "HT" Listing as a Building Heating Appliance Chimney, better qualifying it for use when a larger diameter chimney is required, a noncombustible chase is an option, and local code requires an "HT" rating. Multiple, symmetrically attached Chimney systems with equivalent or larger cross-sectional areas may also be used. (Example - two 14" Chimney may be used on a fireplace requiring a single 18" chimney.)



---

# SECTION 14

# RELINING MASONRY

# CHIMNEYS

## 14-1 OPTIONS FOR RELINING

When an existing masonry chimney is inspected and found to require modification in order to make it suitable for use with gas burning appliances, a variety of options are available.

Where Type B gas vent can be installed within a flue which is otherwise unused, it may provide the most cost effective solution to the situation, and is advantageous since it provides extra insulating value as compared to single wall liners, thereby reducing condensation. In other situations, a flexible chimney liner may be easier to install and provide acceptable service.

## 14-2 SIZING GUIDELINES

When Type B gas vent is installed within a masonry chimney, the tables and guidelines covered in previous sections of this handbook apply.

When a corrugated metallic chimney lining system is to be installed, current sizing guidelines suggest that Tables I through IV (as appropriate) may be employed if a reduction of 20% is applied to all maximum capacity values. Minimum capacities remain unchanged. Bends or offsets in the corrugated lining system may require additional capacity reductions as noted in the previous sections. The 20% reduction for corrugated metallic chimney liner includes an allowance for one long radius 90 degree turn at the bottom of the liner.

## REFERENCE

New Vent Sizing Tables, American Gas Association, Catalog No. T20002, October 1990 or later

National Fuel Gas Code, ANSI Z223.1, or NFPA 54, 1958 or later, American Gas Association

Chimneys, Fireplaces, and Solid Fuel-Burning Appliances, NFPA211, 1988 or later, National Fire Protection Association

ASHRAE Handbook, Equipment Volume, Chapter on Chimneys, 1972 Edition or later, American Society of Heating, Refrigerating, and Air Conditioning Engineers

An Interactive Personal Computer Program for Design and Analysis of Venting Systems for One or Two Gas Appliances, Users Manual for Vent 11 (Version 4.1) with Diskettes, Topical Report (Sept. 1 1989-July 1990), Gas Research Institute

R.L. Stone: A Practical General Chimney Design Method, ASHRAE Transactions 1971, Paper No. 2175.



## WARNING

Failure to follow the installation instructions could cause FIRE, CARBON MONOXIDE POISONING, OR DEATH. If you are unsure of installation requirements, call the phone number listed on the instructions or Sizing Handbook.



# From Appliance to Rooftop

## THE COOLEST UNDER THE HOTTEST CONDITIONS



When independently tested at 2100° F in accordance with the UL 103HT chimney test protocol, "The

Selkirk Sure-Temp Chimney exhibited the coolest (outer skin) temperatures..."  
Not surprising! Our unique insulation is designed and is thoroughly tested to meet our own strict internal standards before being pressure packed into each chimney section, ensuring a 100% fill. This special blend of insulation allows Sure-Temp Chimneys to outperform the major brands tested at containing heat and controlling heat surge. These characteristics ensure that Sure-Temp Chimneys maintain higher internal flue temperatures, creating a stronger draft and reducing the potential for creosote formation...the leading cause of chimney fires.

## IMPROVED FEATURE FOR TYPE "B" RV GAS VENTS



- Snap together non-positional lock system
- Die formed ends
- For venting gas fired appliances, water heaters, furnaces, stoves, etc.



Selkirk Type "B" Gas Vent assemblies with a snap and our non-positional lock system rotates 360° to easily handle offsets. Die formed ends ensure consistency of the double wall construction which provides a built-in airspace that keeps the heat in. This creates a quick, strong vent action, enhancing appliance performance. The use of our new LockTab® feature gives installers the option of engaging this tab instead of using sheet metal screws.

## USE DSP STOVE PIPE FOR OPTIMUM CHIMNEY SYSTEM PERFORMANCE



Model DSP is a connector pipe that links your wood stove or oil fired appliance to an insulated chimney. The connector is an important component to these systems because its correct size, arrangement and installation improve the performance and safety of the heating system. The inner liner of Model DSP is made from corrosion resistant 400 series stainless steel. Together with the stainless steel insulated chimney this combination forms an all-stainless steel system to help your appliance perform safely and efficiently. The Double Wall Stove Pipe is listed to ULC S-641 and UL 103 Standards-your guarantee of safety.

COMPLETE CHIMNEY AND VENTING SYSTEMS FOR YOUR HOME.



5030 Corporate Exchange Blvd.  
Grand Rapids, MI 49512  
Toll Free: 1.800.992.VENT (8368)

www.selkirkcorp.com