



Volkswagen MK7 & Audi 8V A3/S3  
Kohlefaser Luft-Technik Intake System  
Installation Guide - [Click HERE to Shop](#)



**Skill Level 1**  
**- Easy -**  
**Basic Skills**  
**Required**



Proper service and repair procedures are vital to the safe, reliable operation of all motor vehicles as well as the personal safety of those performing the repairs. Standard safety procedures and precautions (including use of safety goggles and proper tools and equipment) should be followed at all times to eliminate the possibility of personal injury or improper service which could damage the vehicle or compromise its safety.

## INTRODUCTION

### Our Kohlefaser Luft-Technik intake systems offer the following features:

- CNC bent aluminum pipes available in a wrinkle black powder coat finish
- Hand-laid carbon fiber air box
- Dyno proven results
- In-house designed by ECS Tuning Engineers
- 4-Ply silicone couplers
- High flow cotton gauze air filter
- All mounting hardware included
- Easy installation

Take your time and enjoy the project, it should take you a couple of hours or less. Read all of these instructions first and you should be able to breeze right through the install, and there's even a DIY video which can be found by clicking [HERE](#). Be sure to reference the list of required tools below before you begin to make sure you have everything that you need to finish the job. Thank you for looking to ECS Tuning for all your performance and repair needs, we appreciate your business!

- **1/4" Drive Ratchet, Sockets, & Extensions** ..... [ES#2823235](#)
- **Plier and Cutter Set**..... [ES#2804496](#)
- **Flat and Phillips Screwdrivers** ..... [ES#2225921](#)
- **Torx Drivers and Sockets** ..... [ES#11417/8](#)
- **Locking Hose Clamp Pliers**..... [ES#2702616](#)

## TABLE OF CONTENTS

Kit Contents.....	<a href="#">pg.4</a>
Installation and Safety Information.....	<a href="#">pg.6</a>
Removing the Stock Intake System.....	<a href="#">pg.7</a>
Installing the Silicone Coolant Hose Reroute Kit.....	<a href="#">pg.11</a>
Installing the ECS Kohlefaser Luft-Technik Intake System.....	<a href="#">pg.12</a>
Adjusting the Intake System.....	<a href="#">pg.17</a>
Final Installation Steps.....	<a href="#">pg.21</a>
Installing the Secondary Air Filter Adapter Kit.....	<a href="#">pg.23</a>
Carbon Fiber Cleaning and Care.....	<a href="#">pg.25</a>

## RELATED UPGRADES

These upgrades are the perfect compliment to your new ECS Tuning intake system!



**MK7 ECS Big Bore Turbo Inlet Pipe:**  
[ES#3604024](#)



**MK7 ECS Turbo Muffler Delete:**  
[ES#3162698](#)



**MK7 ECS Charge Pipe Kit:**  
Click [HERE](#) to see all available finishes

**KIT CONTENTS**

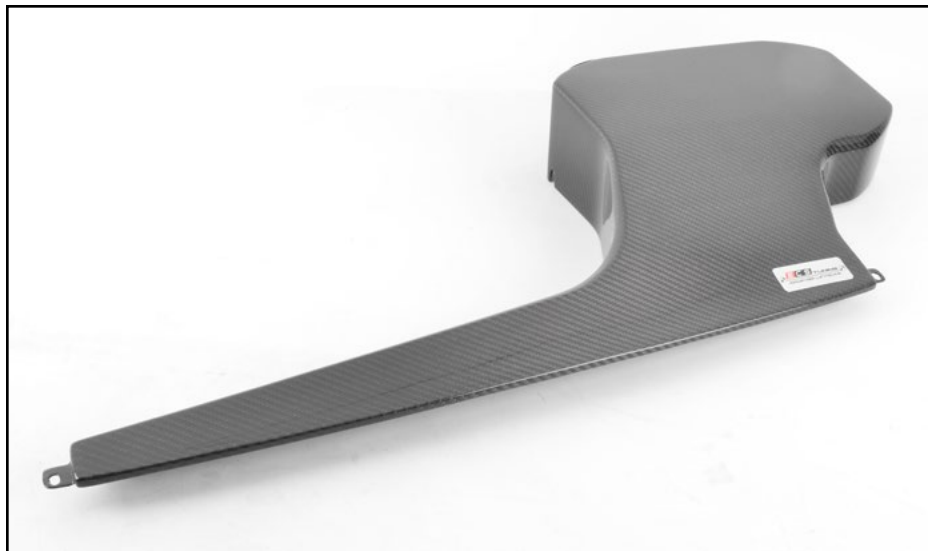

MK7 Kohlefaser Air Box Lid  
(QTY 1)

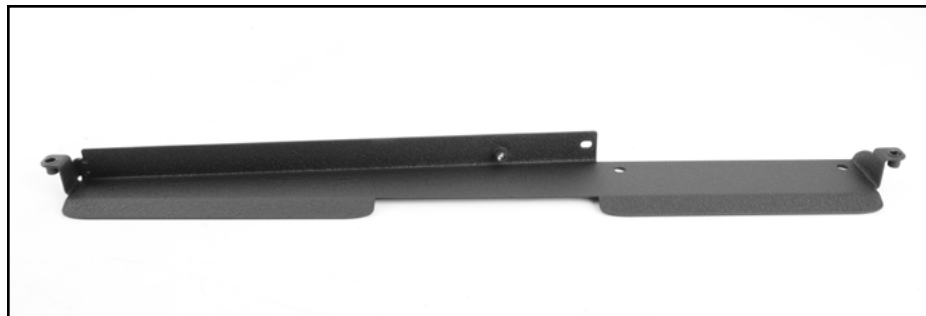

MK7 Kohlefaser Air Scoop  
(QTY 1)



MK7 Intake Tube  
(QTY 1)



Air Filter w/Clamp  
(QTY 1)



5/16" Bulb Seal  
(10" length)



Silicone Turbo Inlet Hose\*  
(QTY 1)



Carbon Fiber Turbo Inlet\*  
(QTY 1)

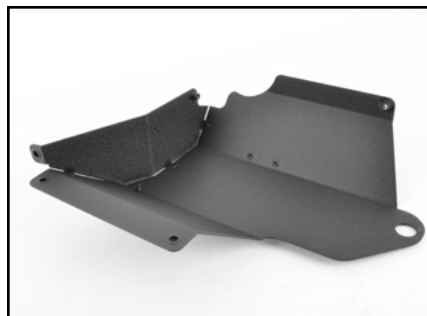

MK7 Kohlefaser Heat Shield  
(QTY 1)



Silicone Coolant Hose  
(QTY 1)

\*Your kit will include **ONE** of these



**KIT CONTENTS**

M6x50mm Bolt  
(QTY 1)



M6 Lock Washer  
(QTY 1)



M6x20mm Bolt  
(QTY 4)



M6 Flat Washer  
(QTY 5)



M6x16mm Bolt  
(QTY 4)



M6 Nylon Washer  
(QTY 3)



Air Box Grommet  
(QTY 2)



Secondary Air Filter Adapter Kit\*  
(QTY 1)

**\*Available separately**

## INSTALLATION NOTES

- **RH** refers to the *passenger side* of the vehicle.
- **LH** refers to the *driver side* of the vehicle.
- Always use the proper torque specifications.
- If applicable to this installation, torque specifications will be listed throughout the document and at the end as well.
- Please read all of these instructions and familiarize yourself with the complete process **BEFORE** you begin.

## GENERAL PREPARATION AND SAFETY INFORMATION

ECS Tuning cares about your health and safety, please read the following safety information. This information pertains to automotive service in general, and while it may not pertain to every job you do, please remember and share these important safety tips.

- Park your car in a safe, well lit, level area.
- Shut the engine off and remove the key from the ignition switch.
- Make sure any remote start devices are properly disabled.
- **ALWAYS** wear safety glasses.
- Make sure the parking brake is applied until the vehicle is safely lifted and supported.
- Whether lifting a vehicle using an automotive lift or a hydraulic jack, be sure and utilize the factory specified lift points.
- Lifting a vehicle in an incorrect location can cause damage to the suspension/running gear.
- **ALWAYS** support the vehicle with jack stands.
- **ALWAYS** read and follow all safety information and warnings for the equipment you are using.



**NEVER** get underneath a vehicle that is supported only by a jack, and **ALWAYS** make sure that the vehicle is securely supported on jack stands.

## REMOVING THE STOCK INTAKE SYSTEM

### Step 1:

Carefully pull the vacuum hose off the side of the air box.

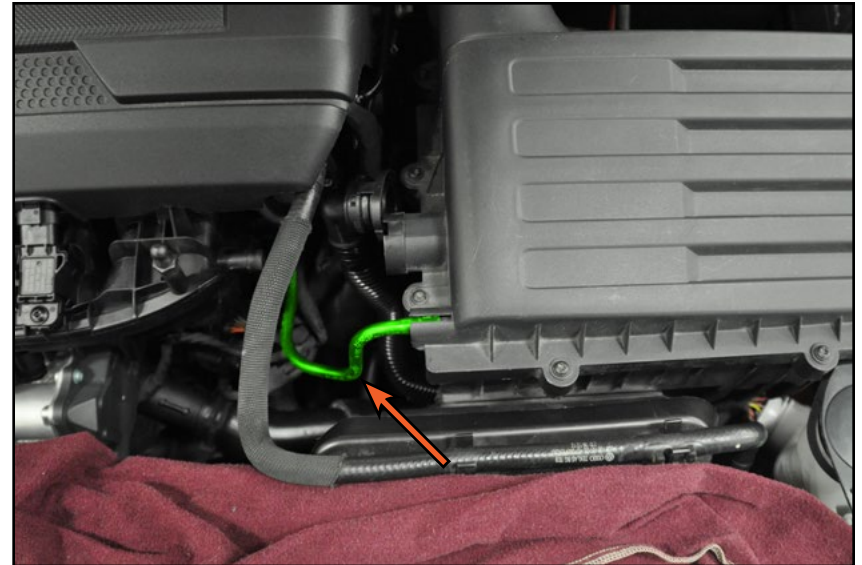

### Step 2:

Some vehicles will have a secondary air injection tube connected to the side of the air box. If your vehicle is equipped with this system, disconnect the hose at this time as described below.

#### NORMAL INSTALLED STATE:

The tabs keep the hose "locked" onto the fitting.

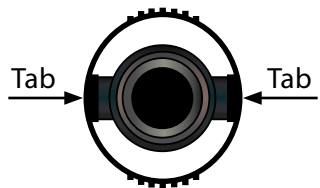

**TO REMOVE:** Squeeze the knurled sides of the locking ring together and the tabs will expand out and unlock, allowing you to pull the connector off of the air box.

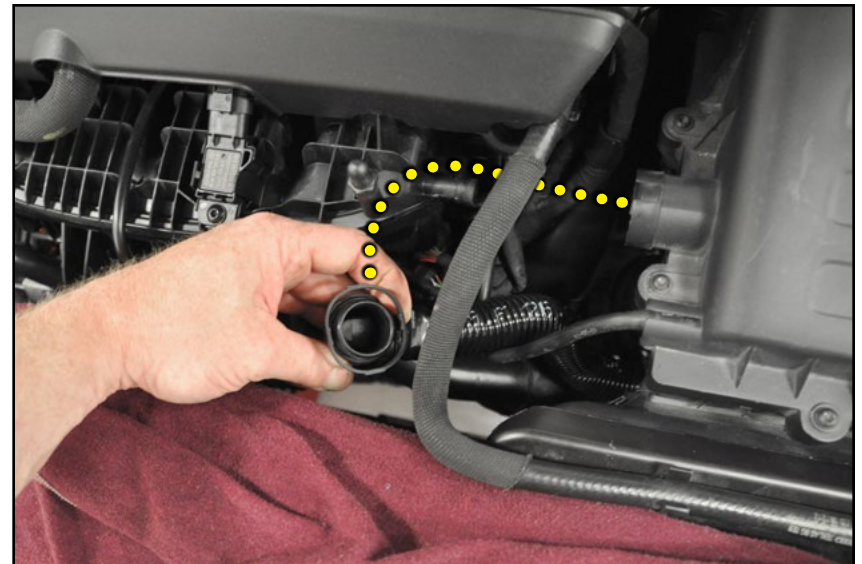
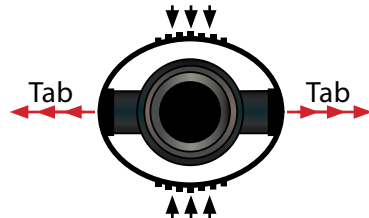

## REMOVING THE STOCK INTAKE SYSTEM

### Step 3: Locking Hose Clamp Pliers

You'll have to remove the air box, so begin by loosening the spring clamp between the air box and the intake tube, then pull the intake tube off of the air box.



### Step 4:

Remove the air box in the following order:

1. Pull up on intake tube side of the air box (the rearmost side) to release the mounting grommets. Do not lift up on the front side of the air box yet.
2. Push downward on the front edge of the air box to release it from the air scoop on the core support (see **RED** inset photo).
3. Lift the air box rearward and out of the engine bay.

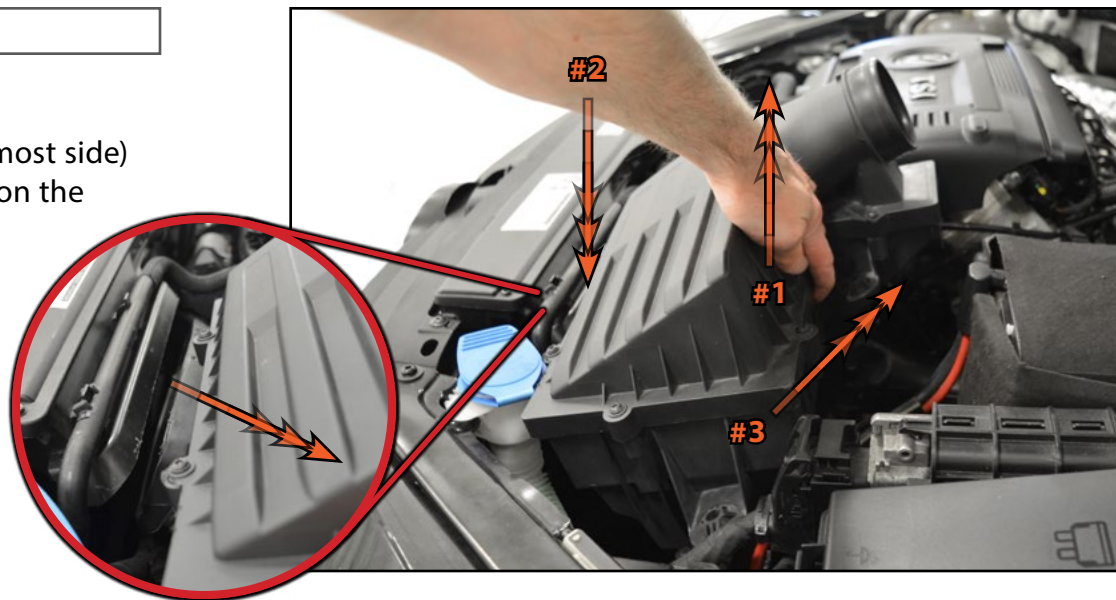



## REMOVING THE STOCK INTAKE SYSTEM

### Step 5:

Remove the engine cover by pulling upward on the four corners.



### Step 6: Flat Blade Screwdriver

Release the clamp which secures the intake tube to the turbo inlet, then remove the intake tube.



## REMOVING THE STOCK INTAKE SYSTEM

### Step 7: T25 Torx

Release the coolant hose from the air scoop (circled in **YELLOW**), then remove the two screws which secure the air scoop to the core support (arrows).

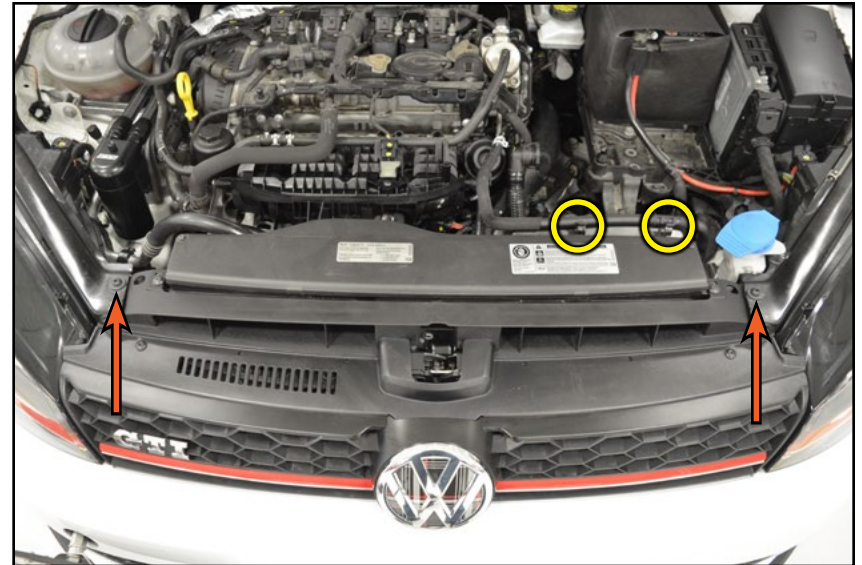

### Step 8:

Roll the air scoop downward to release the clips which are securing it into the core support (**#1 in the photo**), then remove it from the engine bay (**#2 in the photo**).

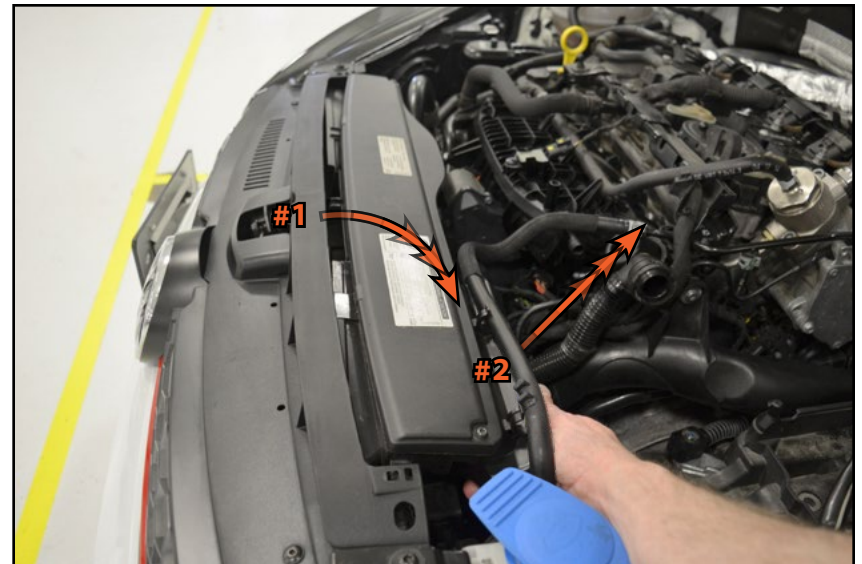



## INSTALLING THE SILICONE COOLANT HOSE REROUTE KIT

### Step 1:

1. Loosen both hose clamps on the stock coolant hose (highlighted in **GREEN** in **Photo #1**) and slide them inward.
2. Remove the hose from the engine, then connect the new ECS hose in its place.
3. Now it's time to swap the hoses at the radiator hose connection (body side). To do this you will need to perform the following steps quickly to minimize how much coolant will be lost:
  - Have one or two rags handy to soak up any lost coolant
  - Twist the hose to release it from the radiator hose fitting (shown in the **YELLOW** inset photo below)
    - ***This fitting can be extremely fragile, be careful here to avoid breaking it***
  - Remove the hose and quickly cover with your thumb
  - Connect the ECS hose (highlighted in **RED** in **Photo #2**) to the radiator hose fitting
  - Tighten both hose clamps
  - Clean up any spilled coolant from the engine bay

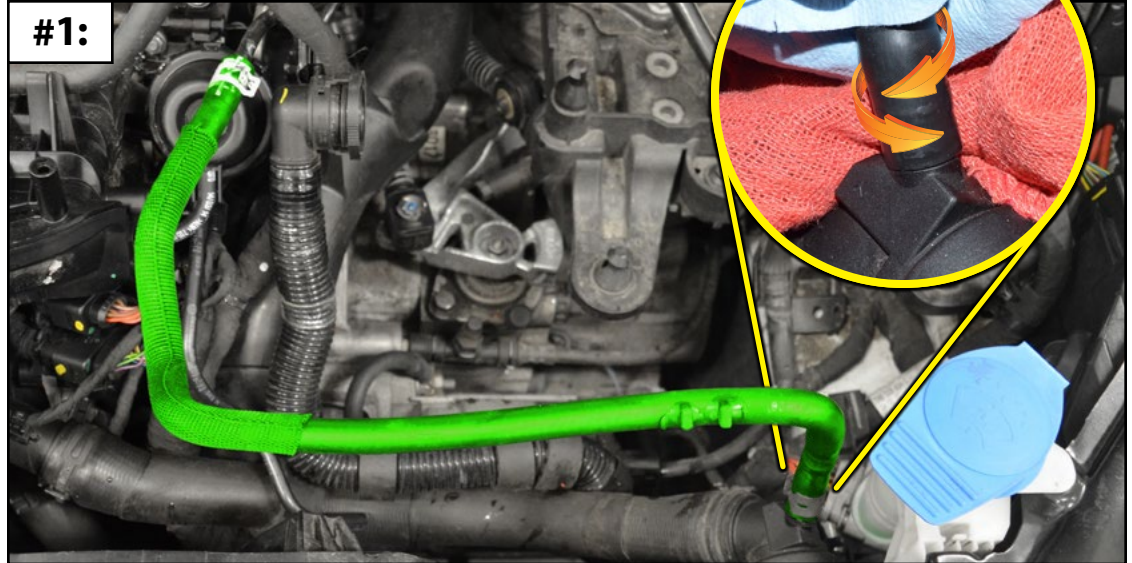

If your vehicle is equipped w/SAI you will need to skip ahead to [Page 23](#) **before** installing the intake system.

# INSTALLING THE ECS KOHLEFASER LUFT-TECHNIK INTAKE SYSTEM

## Step 1:

Push the two air box grommets (highlighted in **RED** in **Photo #1**) into the heat shield so that the larger end of the grommet is on the bottom as shown. Ensure that the coolant hose clip (arrow in **Photo #1**) is installed in the bottom of the heat shield.

Ensure that the bulb seal is installed inside the intake tube opening in the heat shield (highlighted in **GREEN** in **Photo #2**).

Loosely install three of the M6x20mm bolts and flat washers through the air scoop and into the heat shield (arrows in **Photo #3**). Loosely install the three M6x16mm bolts and nylon washers into the heat shield (**BLUE** inset in **Photo #3**). These bolts will secure the carbon fiber lid. Leave all of these bolts loose for now, we'll tighten them up after we adjust the system fitment later on.

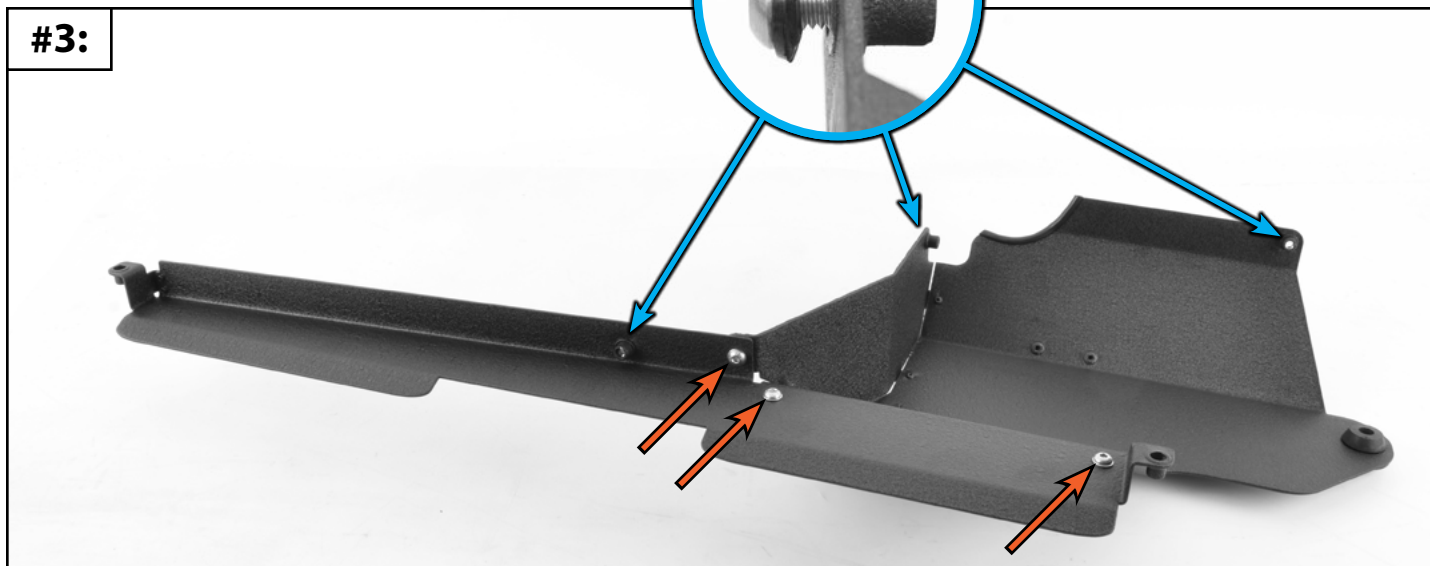
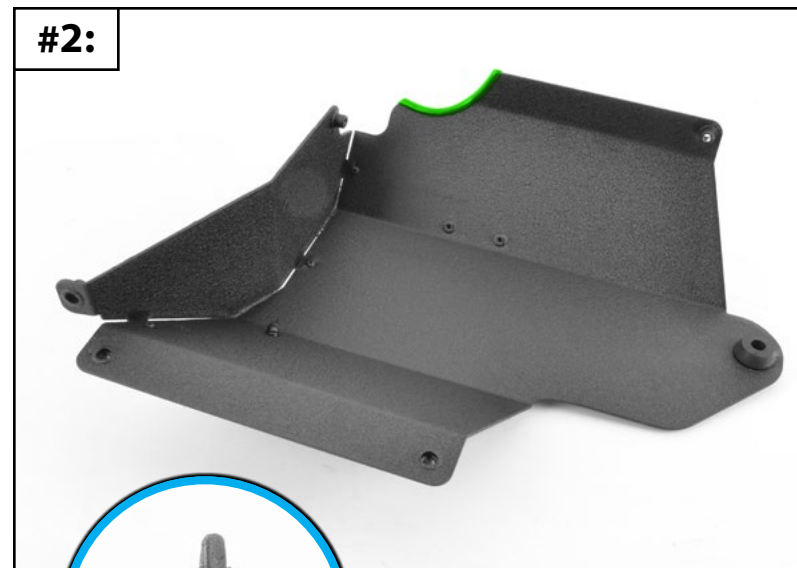
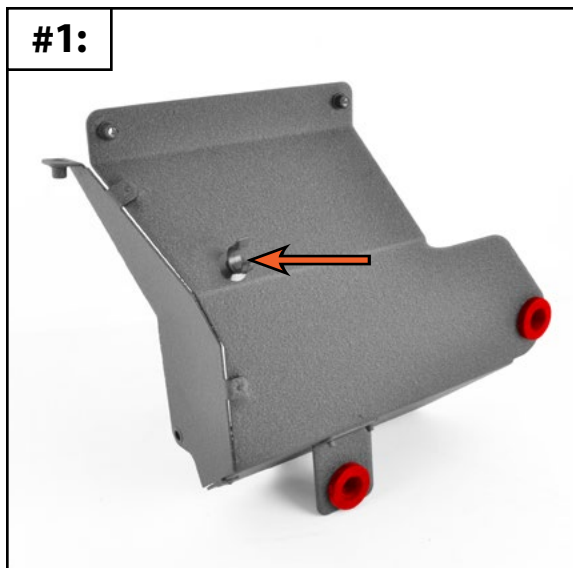



# INSTALLING THE ECS KOHLEFASER LUFT-TECHNIK INTAKE SYSTEM

**Step 2:**

Guide the heat shield into position, being sure to slide the front of the air scoop inside the radiator core support (**Photo #1 & Photo #2**).

Push down on the two mounting grommets to seat them onto the studs (**Photo #3 & Photo #4**).

Secure the silicone coolant hose inside the clip on the bottom side of the heat shield (**Photo #5**).

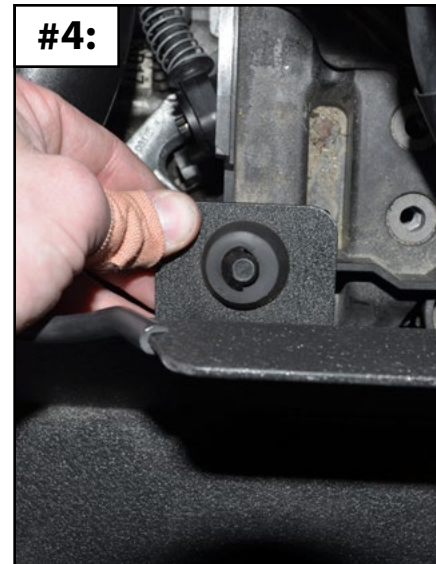
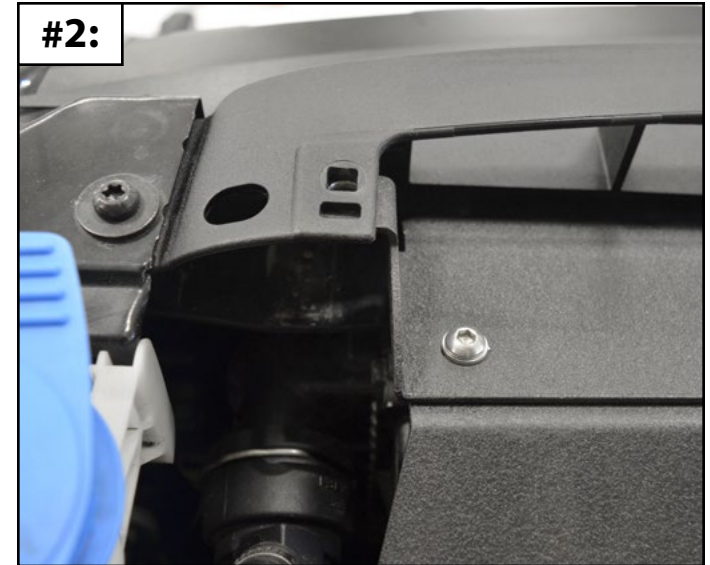
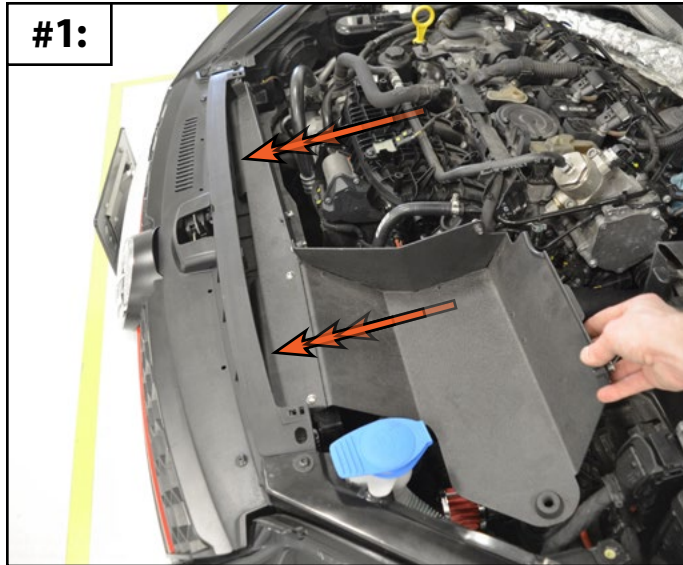

## INSTALLING THE ECS KOHLEFASER LUFT-TECHNIK INTAKE SYSTEM

### Step 3:

Identify the bolt hole location on the side of the cylinder head (**Photo #1**), just above the bolt location for the charge pipe.

Slide the provided M6x50mm bolt and M6 lock washer through the mounting hole in the intake tube (**Photo #2**).

Loosely install the intake tube into position (**Photo #3**). It's best to thread this bolt in by hand to avoid cross-threading it. Removing the battery is very helpful here as it gives you a lot more room to work.

Connect the vacuum hose (highlighted in **GREEN** in **Photo #4**) which was connected to the stock air box onto the port on the bottom of the intake tube.

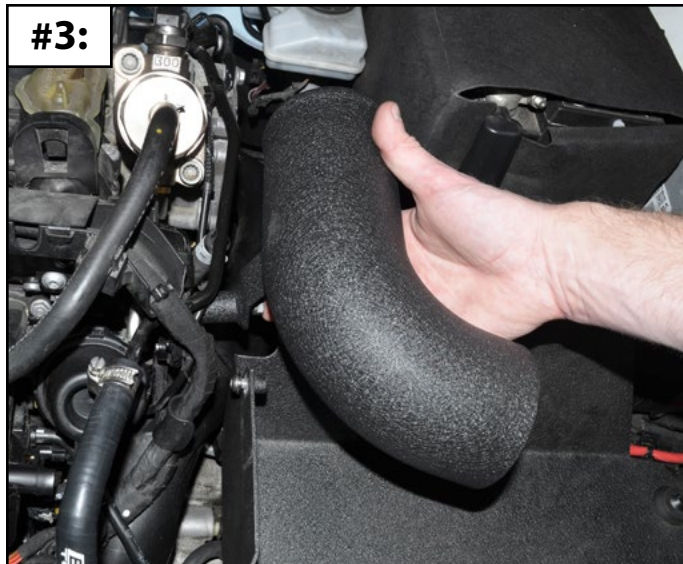
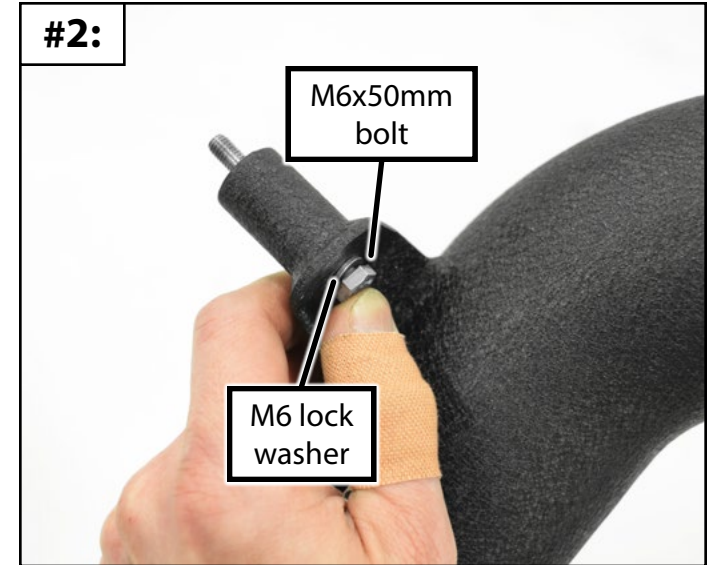
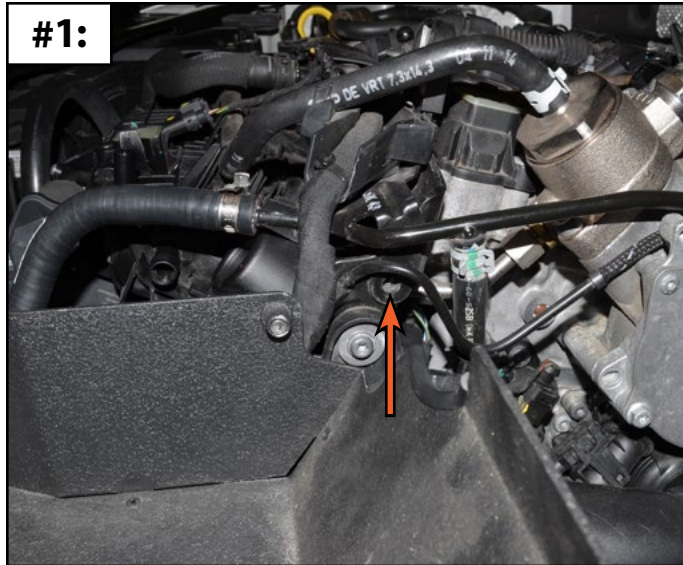



# INSTALLING THE ECS KOHLEFASER LUFT-TECHNIK INTAKE SYSTEM

**Step 4:**

There are two different turbo inlet options for our MK7 intake system, each one installs in a similar fashion:

**Silicone Turbo Inlet Coupler:**

- Connect the silicone turbo inlet coupler between the intake tube and the turbo inlet. Leave the hose clamps loose for now, we'll tighten them up after adjusting system fitment.

**Option #1: Silicone Turbo Inlet Coupler**

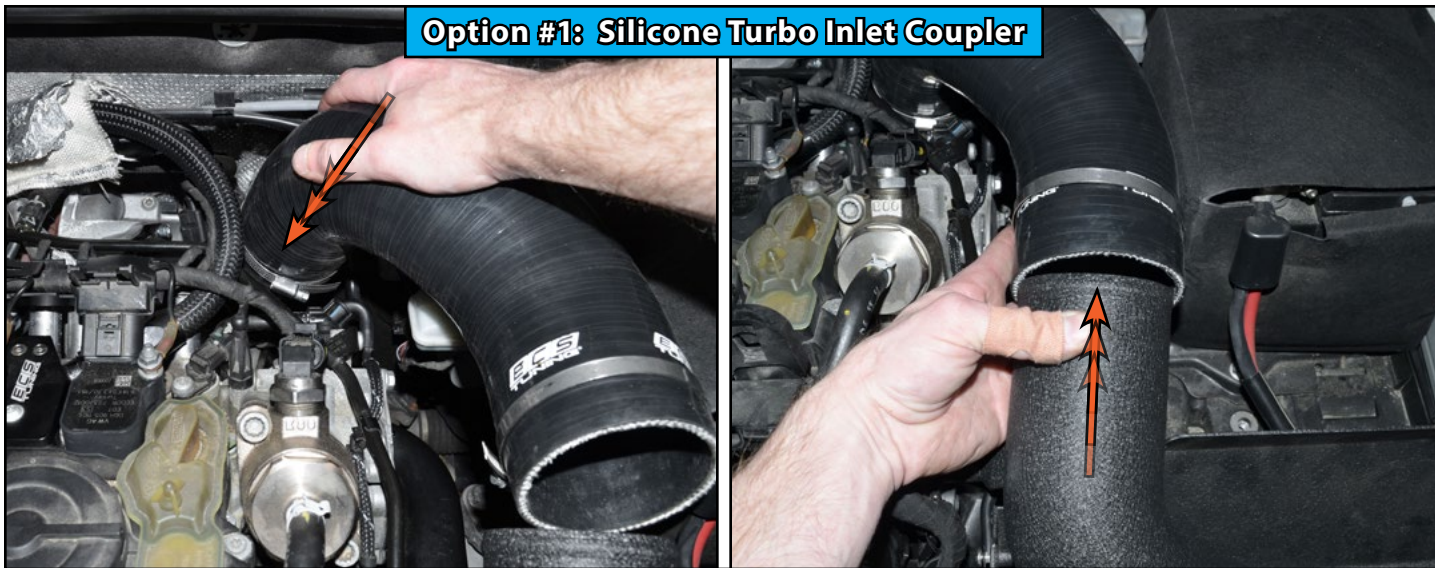

**Carbon Fiber Turbo Inlet:**

- Use the provided silicone couplers and clamps to connect the carbon fiber turbo inlet between the intake tube and the turbo inlet. Leave the hose clamps loose for now, we'll tighten them up after adjusting system fitment.

**Option #2: Carbon Fiber Turbo Inlet**

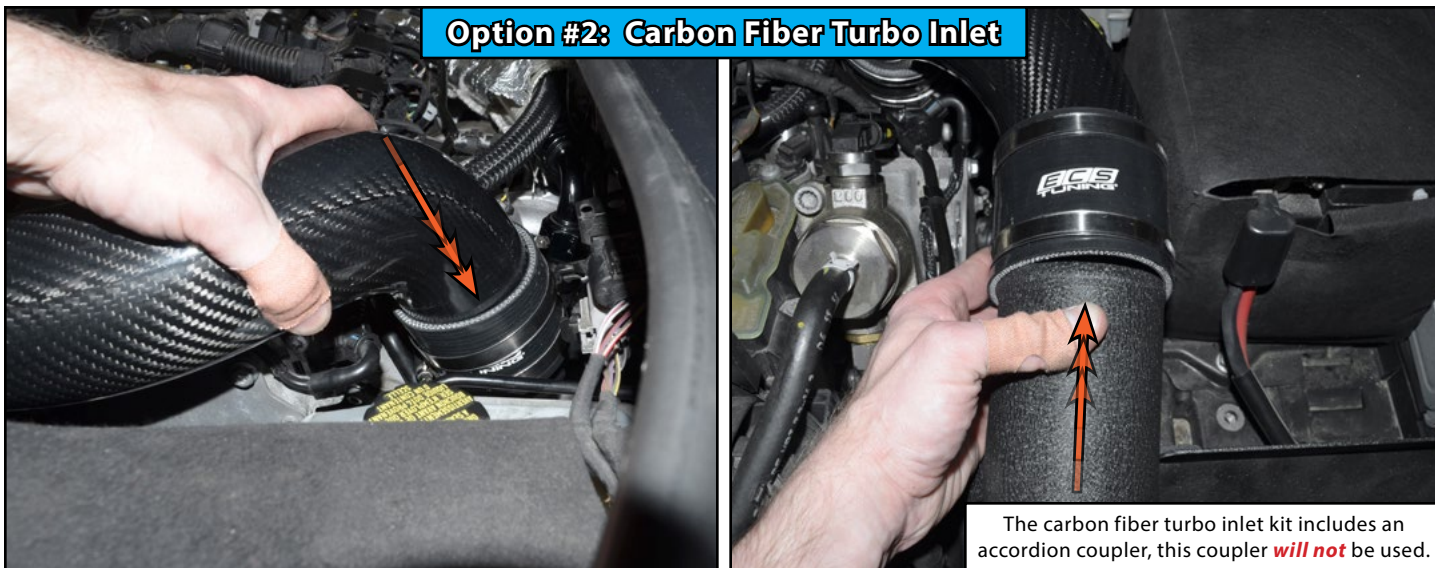

The carbon fiber turbo inlet kit includes an accordion coupler, this coupler **will not** be used.

## INSTALLING THE ECS KOHLEFASER LUFT-TECHNIK INTAKE SYSTEM

### Step 5: Flat Blade Screwdriver

Push the air filter over the end of the intake pipe and tighten the clamp until snug.

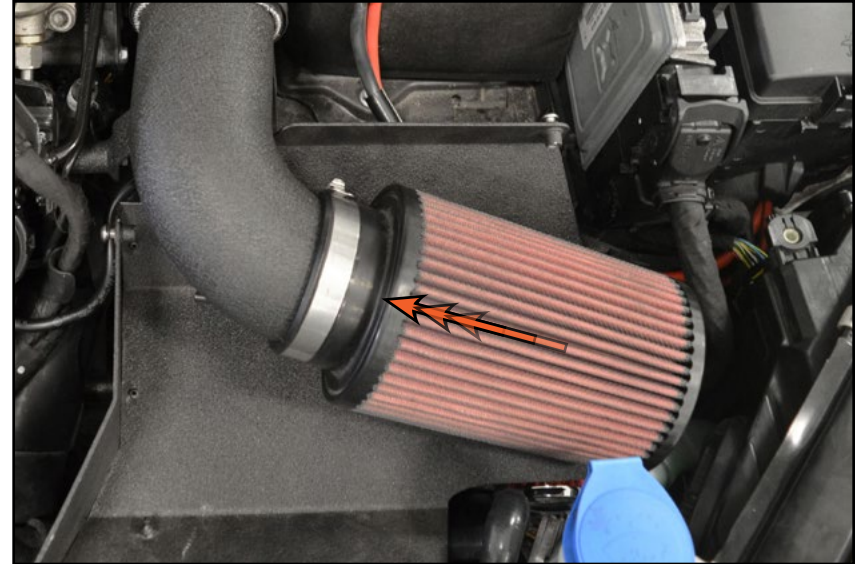

### Step 6:



Now it's time to take a moment and adjust the fitment of the new intake system. Please continue to the next page for more information on this.

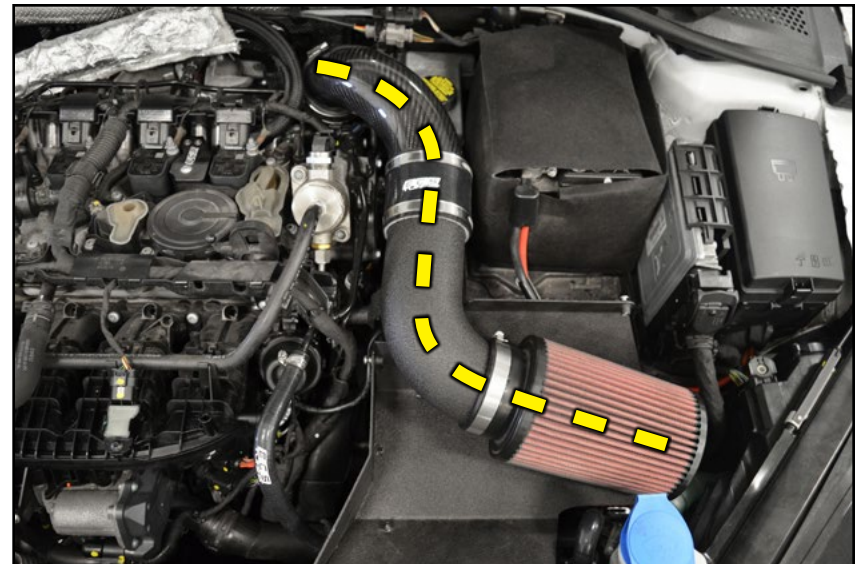



## ADJUSTING THE INTAKE SYSTEM

### Step 1:

Here we have a few photos of what happens when an intake system is not properly installed and adjusted. It's important to understand what happened and how to avoid it:

**Photo #1** shows the damage which was caused by metal-to-metal contact between the intake tube and the heat shield. The intake tube on this vehicle had been pitched forward too far, so as the engine rocked back and forth, the tube banged into the heat shield.

**Photo #2** shows the damage which was caused on the same vehicle because the bulb seal was not installed inside the heat shield (though it was reinstalled before this photo was taken). This caused the intake tube to wear itself against the heat shield as the engine rocked back and forth.

**Photo #3** shows an install where the air filter was being pushed downward into the heat shield. As the engine moved around, the air filter rubbed through the powdercoat finish.

All of these situations are avoidable with a little bit of patience. Let's look at what you should be looking for when adjusting your new intake:

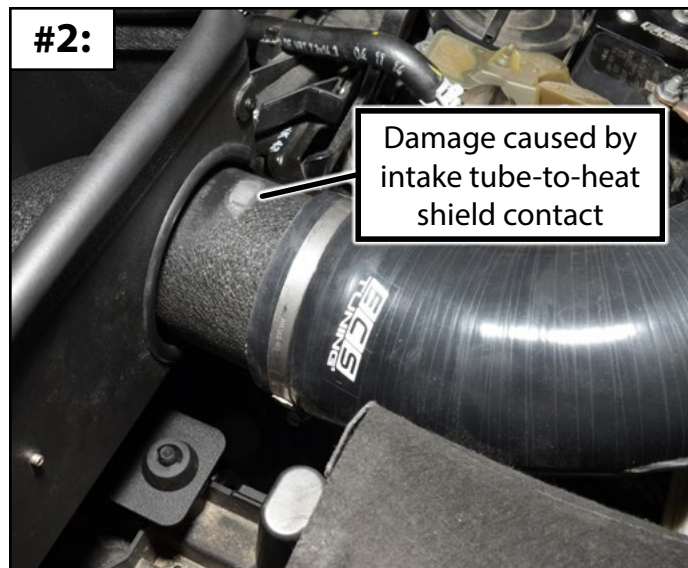
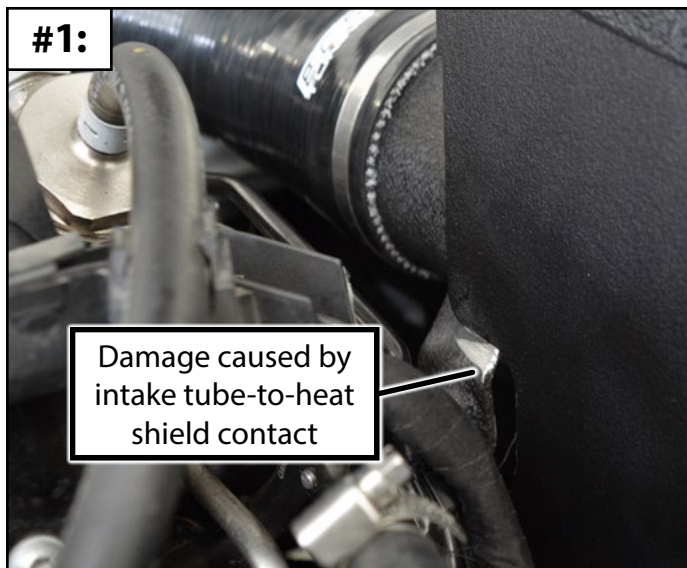

## ADJUSTING THE INTAKE SYSTEM

### Step 2:

The air scoop and heat shield feature side-to-side adjustment slots to help you fine-tune their fitment.

Leave the three screws (YELLOW arrows) loose to allow the scoop to move side-to-side, then tighten them down until snug.

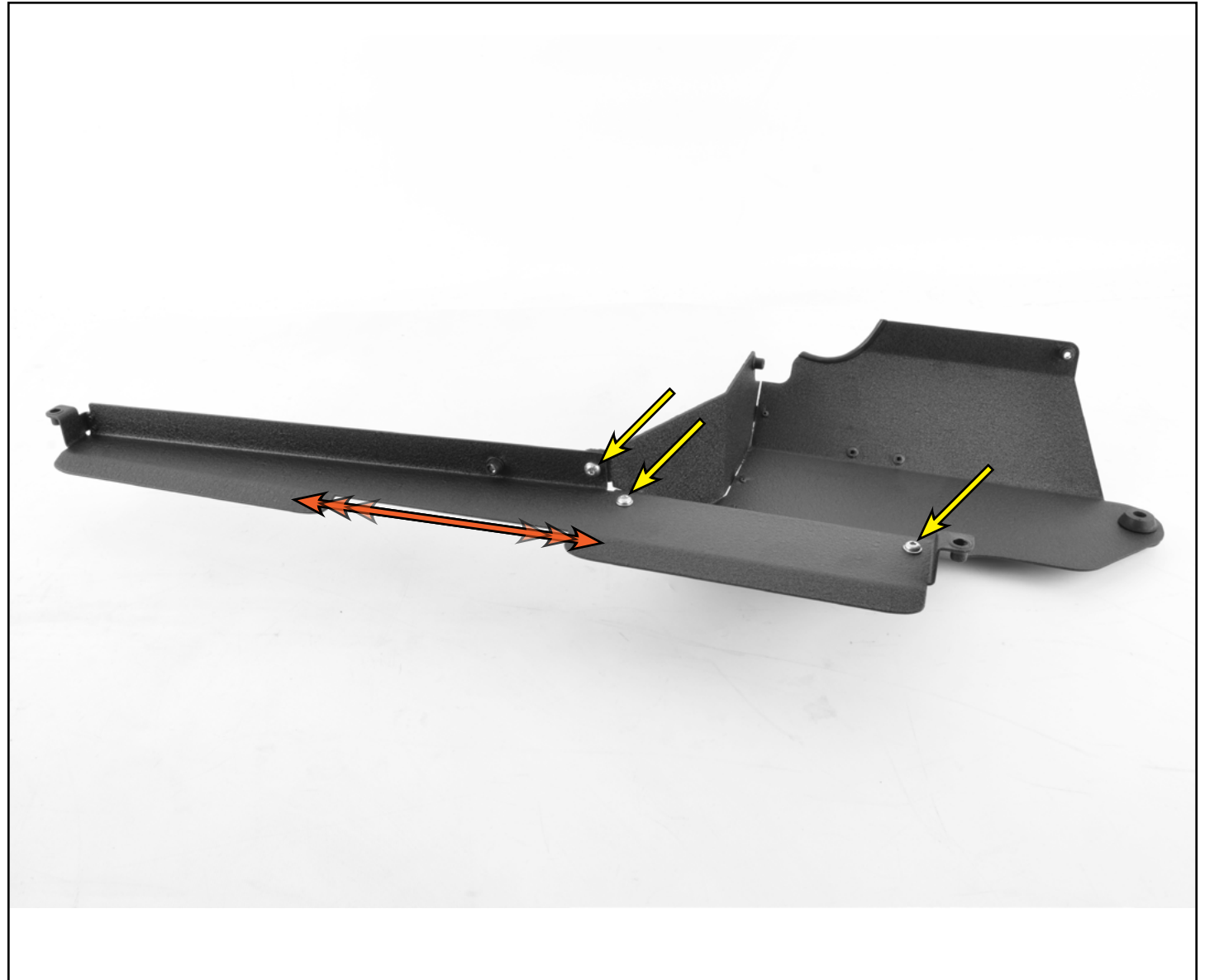



## ADJUSTING THE INTAKE SYSTEM

### Step 3:

This next part applies to both the silicone turbo inlet coupler (not shown) and the carbon fiber turbo inlet (shown in the photos on the right).

The LH photo shows an improperly adjusted carbon fiber turbo inlet, note how twisted the turbo inlet is in relation to the intake tube. This is illustrated with the **RED** lines in the LH photo.

We want the turbo inlet to follow as straight a line as possible between the intake tube and the turbo. This is illustrated with the **GREEN** lines in the RH photo.

Be aware that if the turbo inlet is twisted one way or the other, this can have a big effect on this step.

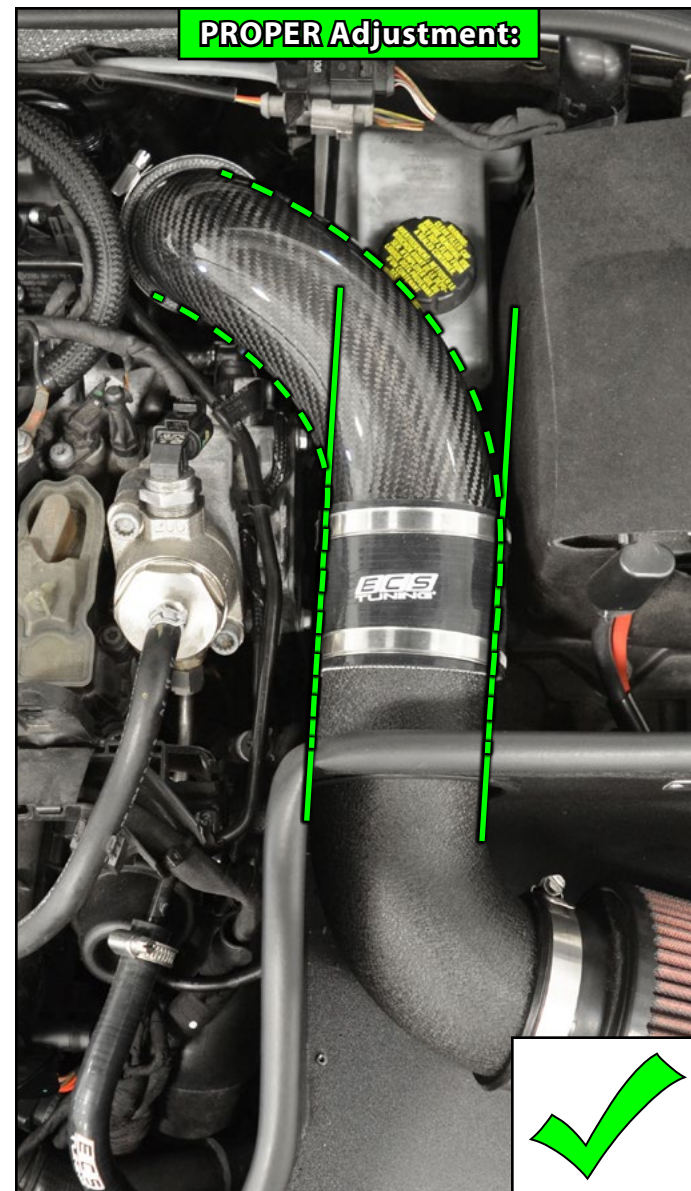

## ADJUSTING THE INTAKE SYSTEM

### Step 4:

The other way to confirm proper turbo inlet adjustment is to look at the pipes from the side and check to see if they are level. The goal is to find get the pipes a balance between how level they sit front-to-back, while also trying to keep the air filter from rubbing against the bottom face of the heat shield (**Photo #3** on [Page 17](#)).

The top photo (**RED** highlights and lines) shows improper adjustment. Look closely and you can see how the intake pipe dips down where it connects to the turbo inlet.

The bottom photo (**GREEN** highlights and lines) shows proper adjustment. The top edge of the pipes follow a nice straight line front-to-back.

Once you are happy with the system adjustment you can perform the following steps:

Tighten all of the hose clamps until snug.

Tighten the bolts which secure the heat shield to the air scoop until they make contact + 1/8 turn.



Please continue to the next page for final installation steps once you are satisfied with the system fitment.

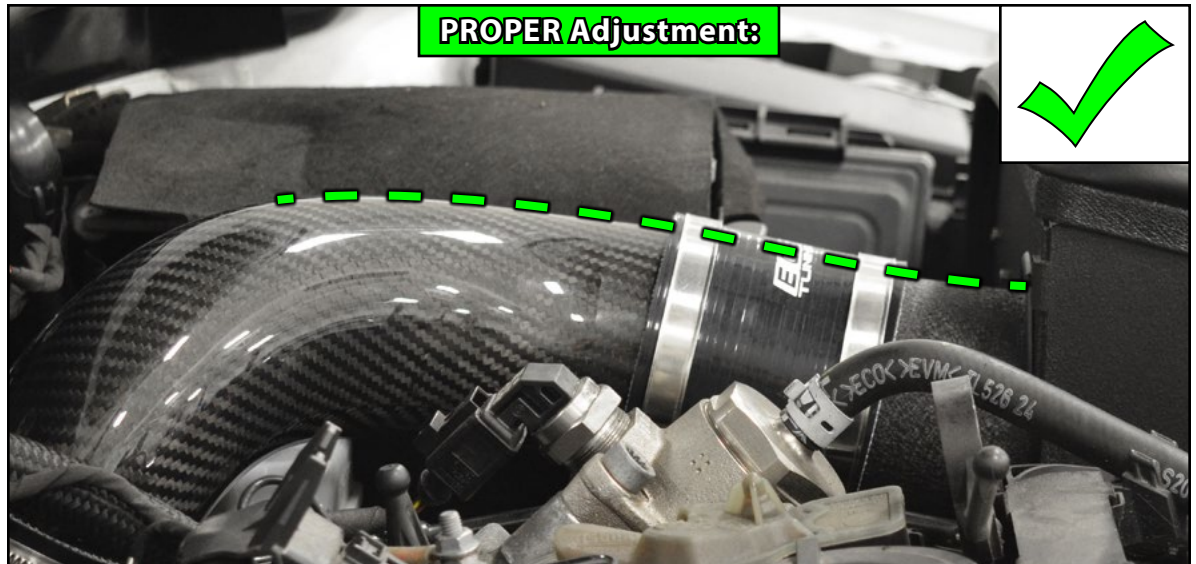
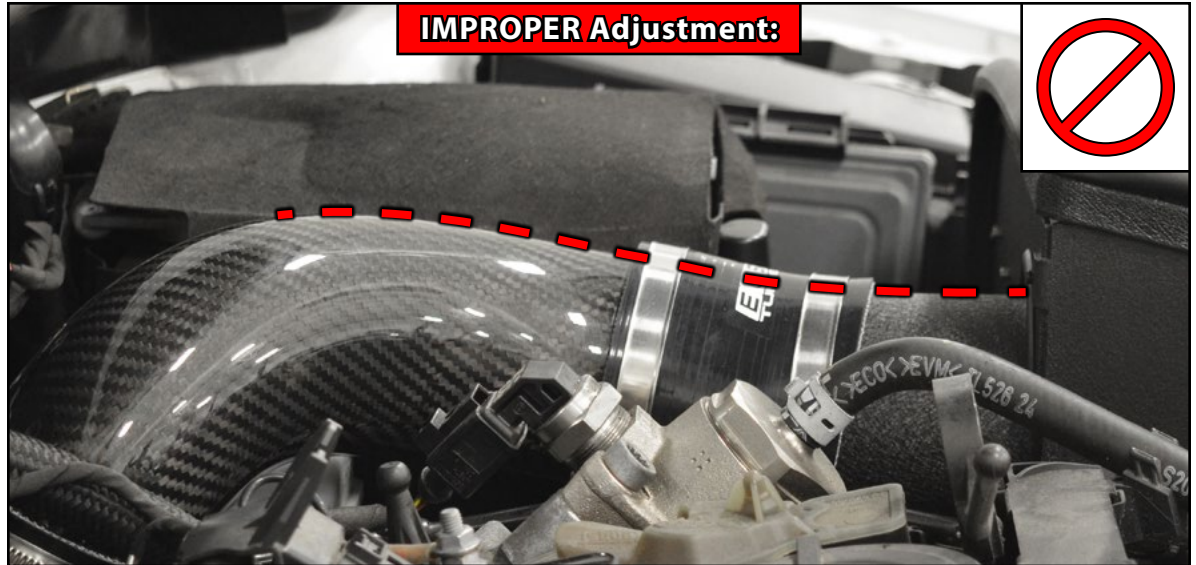



## FINAL INSTALLATION STEPS

### Step 1:

Now it's time to install the carbon fiber air box lid into place. Start by making sure that the three M6 bolts in the heat shield and air scoop are loosely installed (**YELLOW** inset photos). Next, slide the ears on the front edge of the air box lid underneath the core support, then pivot the lid rearward while aligning the three M6 bolts into their slots.

You want to make sure that the black nylon M6 washer is between the bolt head and the air box lid, this will help to protect the carbon fiber finish from damage.

Tighten the bolts until they make contact +  $\frac{1}{8}$  additional turn. Over-tightening these bolts could crack the carbon fiber.

Our installation video does a nice job of outlining this process, it can be found by clicking [HERE](#).

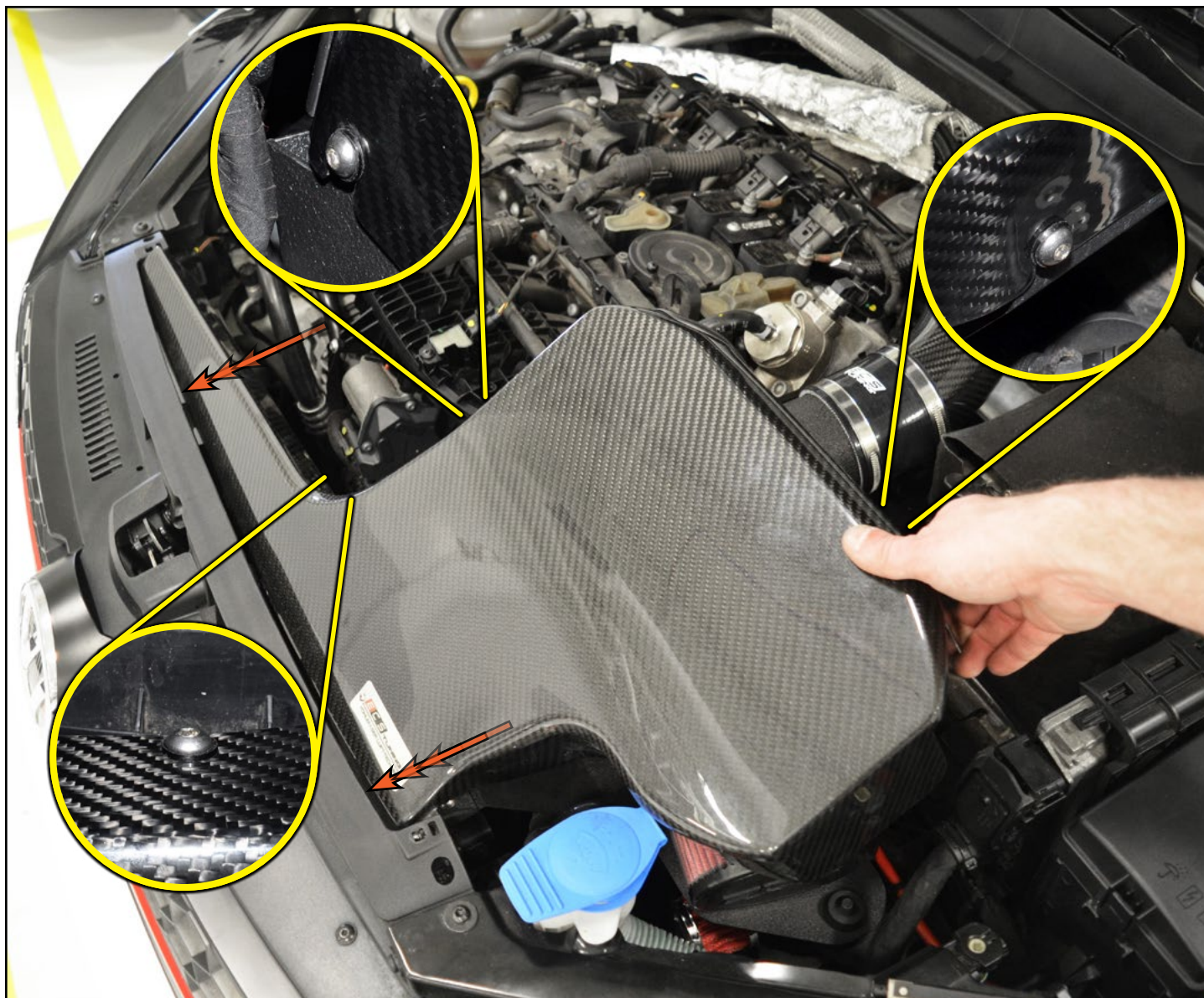



## FINAL INSTALLATION STEPS

### Step 2:

Install the two M6 steel flat washers onto the remaining M6 bolts, then install the bolts (arrows) through the core support, through the carbon fiber air box lid, and into the threaded holes in the air scoop assembly.

*Your Kohlefaser Luft-Technik Intake System installation is complete!*

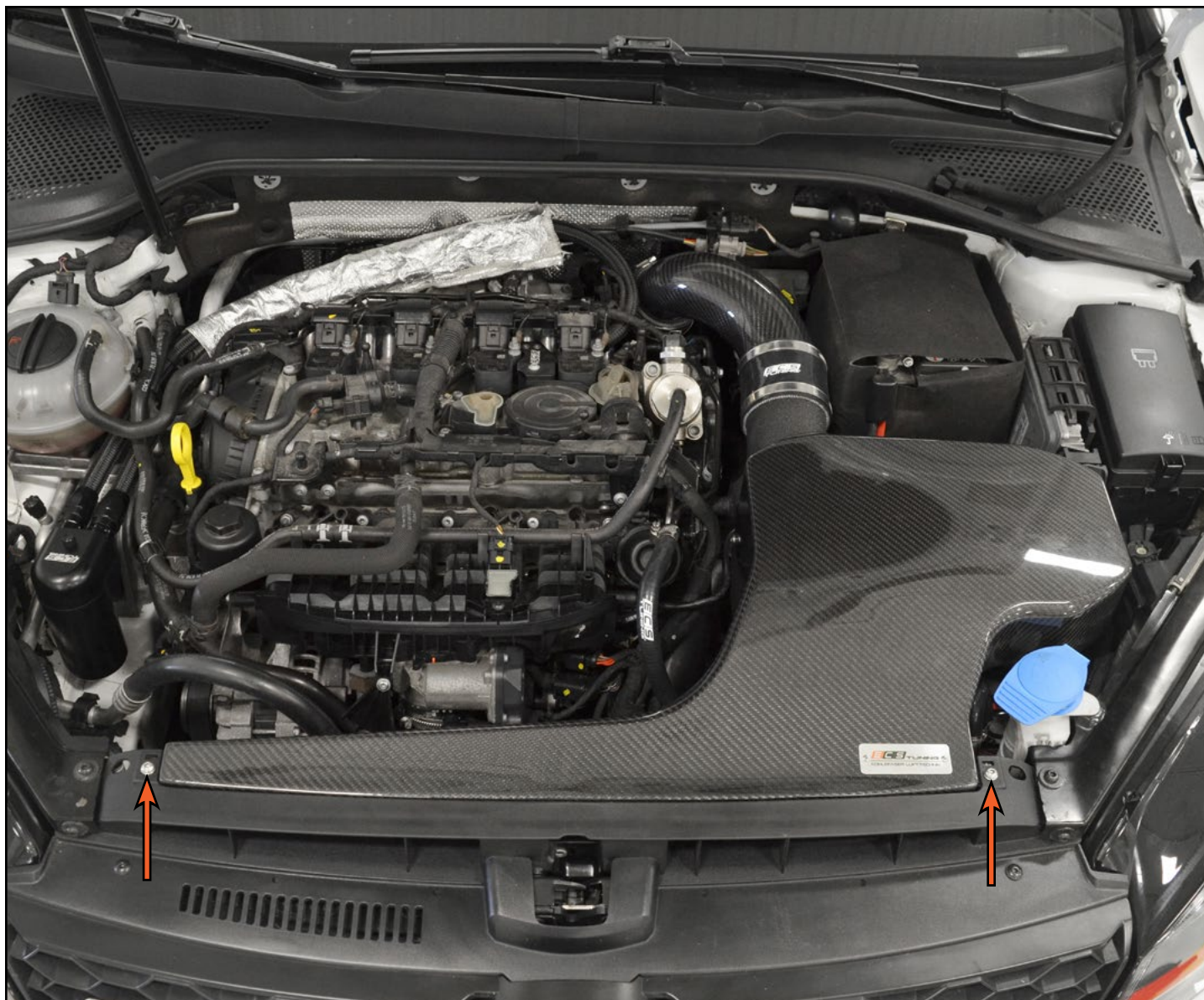

## INSTALLING THE SECONDARY AIR FILTER ADAPTER KIT

\*The mounting grommet which is included in this kit will not be used, only the spacer is required for this application.

These components are available for purchase separately if your vehicle is equipped with Secondary Air Injection (SAI). The kit can be found on our website by clicking [HERE](#), or you can enter your vehicle information into the drop-down menu on [ecstuning.com](#), then select:

- **Engine > Intake > Performance > ECS > Accessories**



SAI Air Filter w/Clamp



SAI Air Filter Adapter



SAI Air Filter Bracket



Rubber Spacer & Mounting Grommet\*

### Step 1: Flat Blade Screwdriver - or - 7mm Socket & Ratchet

Remove from the secondary air injection kit from its packaging, and tighten the hose clamp which secures the filter until it is snug.





## INSTALLING THE SECONDARY AIR FILTER ADAPTER KIT

### Step 2:

Place the secondary air intake assembly onto the outermost air box mounting stud (the stud which is nearest to the fender) so the filter and adapter hang down below the mounting stud.

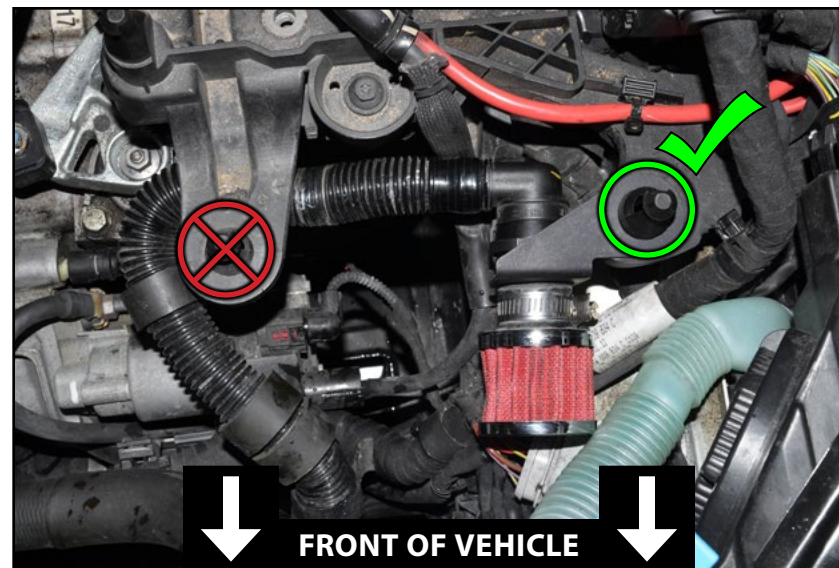

### Step 3:

Route the original secondary air intake tube over to the adapter and connect the two together. Rotate the filter assembly as necessary so the secondary air intake tube does not kink or bind.

Allow the assembly to hang in place for now, when you install the carbon fiber air box the innermost air box mounting grommet will hold the secondary air intake securely in place. As you can see in the photo, the secondary air intake is almost completely hidden underneath the heat shield.

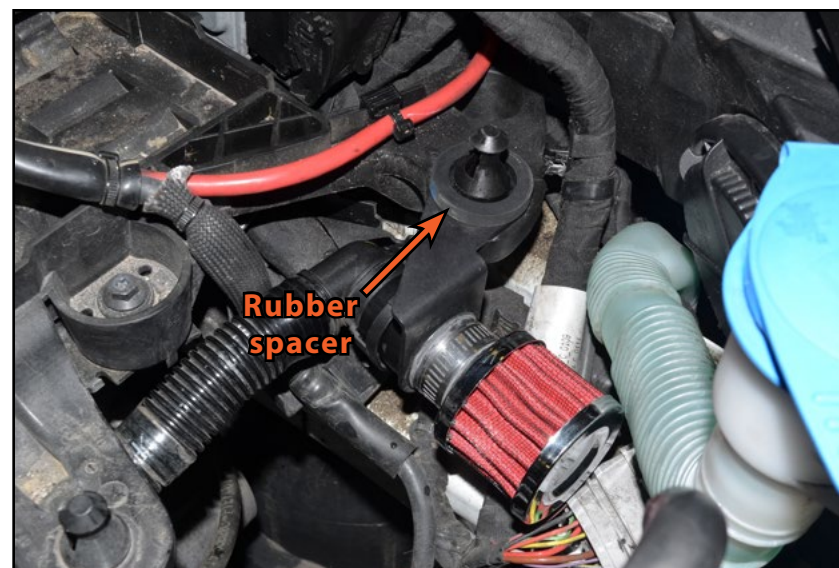

Click [HERE](#) to jump back to the intake system installation.



## CARBON FIBER CLEANING AND CARE

ECS Tuning Carbon Fiber intake systems are clear coated for excellent finish durability and UV resistance right out of the box.

Carbon fiber can be washed with any gentle cleanser or soap. If it is safe for the paint on your car, it will be safe for the carbon fiber.

Be extra careful not to nick or deeply scratch the clear coat on the carbon fiber. This can lead to water intrusion into the carbon fiber which will damage the finish and the integrity of the intake.

If the clear coat does get nicked or deeply scratched to expose the carbon fiber, seal the damaged area thoroughly with a clear coat touch up or clear nail polish.

To retain UV resistance and protect the finish, we recommend regular waxing with a high quality caranuba wax.

Small surface scratches and light oxidation can be buffed out using the same methods and cautions you would use on the vehicle paint.

**Carbon Fiber Cleaning and Care Kit, available at [ecstuning.com](http://ecstuning.com).**

[ES#2914954](#)



## Your Kohlefaser Luft-Technik intake system installation is complete!



### These instructions are provided as a courtesy by ECS Tuning

Proper service and repair procedures are vital to the safe, reliable operation of all motor vehicles as well as the personal safety of those performing the repairs. Standard safety procedures and precautions (including use of safety goggles and proper tools and equipment) should be followed at all times to eliminate the possibility of personal injury or improper service which could damage the vehicle or compromise its safety.

Although this material has been prepared with the intent to provide reliable information, no warranty (express or implied) is made as to its accuracy or completeness. Neither is any liability assumed for loss or damage resulting from reliance on this material. SPECIFICALLY, NO WARRANTY OF MERCHANTABILITY, FITNESS FOR A PARTICULAR PURPOSE OR ANY OTHER WARRANTY IS MADE OR TO BE IMPLIED WITH RESPECT TO THIS MATERIAL. In no event will ECS Tuning, Incorporated or its affiliates be liable for any damages, direct or indirect, consequential or compensatory, arising out of the use of this material.