



SOFTSTARTER HANDBOOK



FOREWORD

This book is written with the thought of being a general guide for people working with softstarter applications but also for those just interested in learning more about this type of starting method. It doesn't matter if you are an expert or novice, hopefully you will find some interesting and useful information either by reading from cover to cover or just the chapters of interest.

The index at the end of the book can be used to simplify your search.

The content of this book is very much based on the 20 years of experience we have within ABB of developing, manufacturing and selling low voltage softstarters.

The book is not a complete technical guide or manual for all type of ABB Softstarters that may exist on the market. It is a complement to the technical catalogues and brochures we have for our products and will give a general picture of what to think about when working with softstarters.

More information about softstarters as well as other ABB products is available on www.abb.com

All advice given in this book is only general and every single application must be handled as a specific case.

ABB Automation Technology Products AB, Control
February 2003

Magnus Kjellberg

Sören Kling

ABB will not take any responsibility for any type of faults or damage due to the use of this handbook.

Contents

Standards	...1
European Directives	...1
CE Marking	...1
Specification in USA and Canada	...1
Used standards	...1
General about motors	...2
Squirrel cage motors	...3
Voltage	...4
Power factor	...5
Speed	...6
Torque	...7
Slip-ring motors	...7
Different starting methods	...8
Direct-on-line start (D.O.L)	...9
Star-delta start	...10
Frequency converter	...12
Softstarter	...13
Common problem when starting and stopping motors	...14
Different applications	...15
Centrifugal fan	...16
Direct-on-line start (D.O.L)	...16
Star-delta start	...17
Softstarter	...17
Selection of a suitable Softstarter	...18
Centrifugal pump	...19
Direct-on-line start (D.O.L)	...19
Star-delta start	...20
Softstarter	...21
Selection of a suitable Softstarter	...22

Compressor	...23
Direct-on-line start (D.O.L)	...23
Star-delta start	...24
Softstarter	...25
Selection of a suitable Softstarter	...26
Conveyor belt	...27
Direct-on-line start (D.O.L)	...27
Star-delta start	...28
Softstarter	...29
Selection of a suitable Softstarter	...30
How to select a softstarter	...31
Description of the softstarters	...33
Description of different components	...34
Common settings	...36
Start ramp	...36
Stop ramp	...36
Initial voltage	...36
Current limit	...37
Step down voltage	...38
Adjustable rated motor current	...38
Different indications	...39
Different voltage names	...40
Ambient temperature	...41
High altitudes	...42
Start of several motors	...43
Parallel start of motors	...43
Sequential start of motors	...44

Different ways of connecting the softstarter	...45
In-Line connection	...46
Inside Delta connection	...46
Location of the main contactor	...47
Basic settings	...49
Table for settings without current limit function	...50
Table for settings with current limit function	...51
Starting capacity and overload protection	...52
Starting capacity for softstarters	...52
Starting capacity when using by-pass contactor	...53
Starting capacity when using overload protection	...53
Number of starts/hour	...54
Intermittance factor	...54
Harmonics	...55
Harmonic content	...55
Explosive atmospheres (EEx)	...56
Hazardous areas and zones	...57
Location and selection of softstarter	...57
Co-ordination	...58
Types of co-ordination	...59
Utilization Categories	...60
Types of fuses	...61
Where to find the co-ordination tables	...62
How to read the co-ordination tables	...63
ESD aspects	...65
Two type of faults and different circuits	...65
Electro static voltage levels	...66
Protection against ESD damages	...66

Frequently Asked Questions (FAQ)	...67
Environmental information	...69
LCA	...69
EPD	...70
Industrial IT	...71
Different levels	...72
Softstarter level	...72
Formulas and conversion factors	...73
Formulas	...73
Quantities and units	...75
Conversion factors	...76
Glossary	...78
IV Index	...84

Standards



All ABB low voltage softstarters are developed and manufactured according to the rules set out in the IEC (International Electrotechnical Commission) which is a part of the International Standard Organisation, ISO.

ISO issue IEC publications that act as a basis for the world market.

Softstarters built according to these standards are in most countries not subject to any other tests besides the manufacturer responsibility. In some countries, law requires certificates.

For softstarters used on board ships, maritime insurance companies sometimes require certificates of approval from BV (Bureau Veritas), GL (Germanischer Lloyd) and LRS (Lloyd's Register of Shipping) or other independent certification organisation.

European Directives

There are three essential European directives:

Low Voltage Directive 73/23/EEC

Concerns electrical equipment from 50 to 1000 V AC and from 75 to 1500 V DC.

Machines Directive 89/392/EEC

Concerns safety specifications of machines and equipment on complete machines.

Electromagnetic Compatibility Directive 89/336/EEC

Concerns all devices able to create electromagnetic disturbance including the level of emission and immunity.

CE Marking

When a product is verified according to its applicable EN standard (EN 60947-4-2 for softstarters) the product will then fulfil both the "Low Voltage Directive" and "Electromagnetic Compatibility Directive" and it is allowed to use the CE marking on the product. In this case the CE marking does not cover the "Machines Directive" concerning the connection of the softstarter for a safe run of the motor.

The CE marking is not a quality label; it is proof of conformity with the European Directives concerning the product.

Specifications in USA and Canada

The specifications for the American and Canadian markets are quite equal but differ a lot from the IEC standards and other European specifications.

USA	UL	Underwriters Laboratories
		File ref. 072301-E161428
		110800-E161428

Canada	CSA	Canadian Standards
		File ref. 1031179

Used standards

Following standards are used or partly used for the softstarters.

- IEC 60947-1
- IEC 60947-4-2
- EN 60947-1
- EN 60947-4-2
- UL 508
- CSA C22.2 No. 14 - M91
- LRS 00/00154

About Motors

Modern electrical motors are available in many different forms, such as single phase motors, three-phase motors, brake motors, synchronous motors, asynchronous motors, special customised motors, two speed motors, three speed motors, and so on, all with their own performance and characteristics.

For each type of motor there are many different mounting arrangements, for example foot mounting, flange mounting or combined foot and flange mounting. The cooling method can also differ very much, from the simplest motor with free self-circulation of air to a more complex motor with totally enclosed air-water cooling with an interchangeable cassette type of cooler.

To ensure a long lifetime for the motor it is important to keep it with the correct degree of protection when under heavy-duty conditions in a server environment. The two letters IP (International Protection) state the degree of protection followed by two digits, the first of which indicates the degree of protection against contact and penetration of solid objects, whereas the second states the motor's degree of protection against water.

The end of the motor is defined in the IEC-standard as follows:

- The D-end is normally the drive end of the motor.
- The N-end is normally the non-drive end of the motor.

Note that in this handbook we will focus on asynchronous motors only.

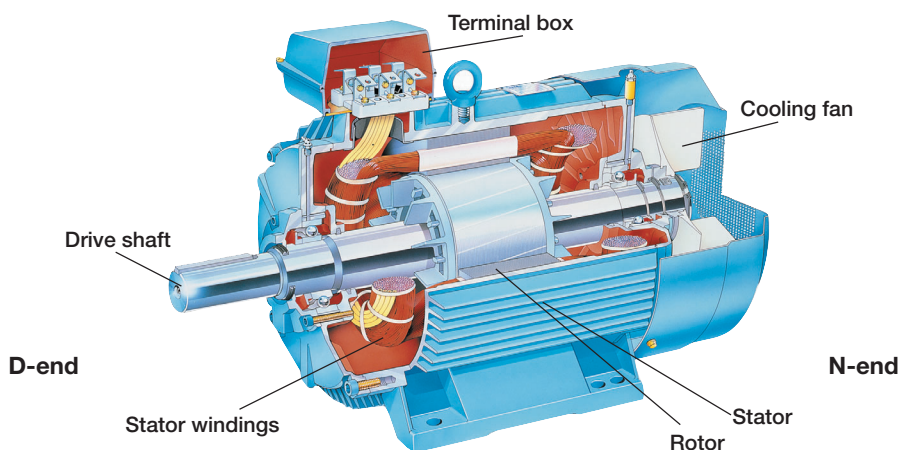

Squirrel cage motors

In this book the focus has been placed on the squirrel cage motor, the most common type of motor on the market. It is relatively cheap and the maintenance cost is normally low. There are many different manufacturers represented on the market, selling at various prices. Not all motors have the same performance and quality as for example motors from ABB. High efficiency enables significant savings in energy costs during the motor's normal endurance. The low level of noise is something else that is of interest today, as is the ability to withstand severe environments.

There are also other parameters that differ. The design of the rotor affects the starting current and torque and the variation can be really large between different manufacturers for the same power rating. When using a softstarter it is good if the motor has a high starting torque at Direct-on-line (D.O.L) start. When these motors are used together with a softstarter it is possible to reduce the starting current further when compared to motors with low starting torque. The number of poles also affects the technical data. A motor with two poles often has a lower starting torque than motors with four or more poles.

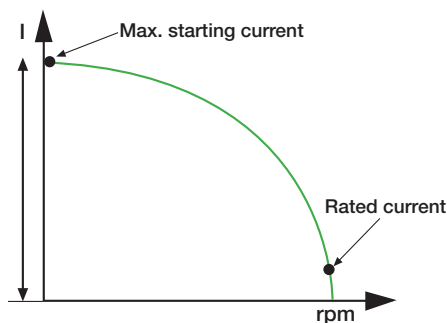

Current diagram for typical squirrel cage motor

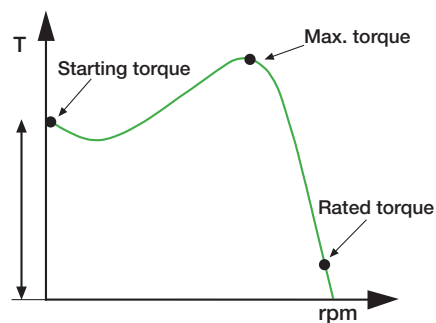

Torque diagram for a typical squirrel cage motor

Voltage

Three-phase single speed motors can normally be connected for two different voltage levels. The three stator windings are connected in star (Y) or delta (D).

The windings can also be connected in series or parallel, Y or YY for instance. If the rating plate on a squirrel cage motor indicates voltages for both the star and delta connection, it is possible to use the motor for both 230 V, and 400 V as an example.

The winding is delta connected at 230 V and if the main voltage is 400 V, the Y-connection is used.

When changing the main voltage it is important to remember that for the same power rating the rated motor current will change depending on the voltage level.

The method for connecting the motor to the terminal blocks for star or delta connection is shown in the picture below.

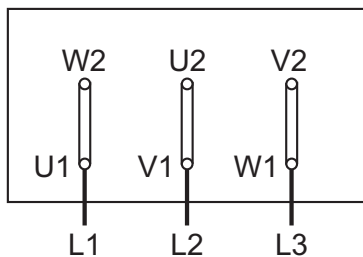
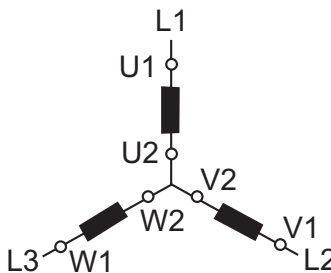
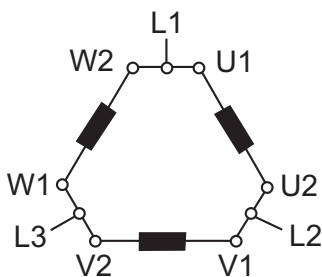

Δ – Connection
230 V
(400 V)

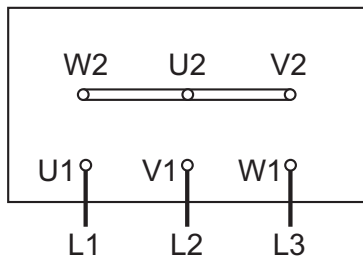

Y – Connection
400 V
(690 V)

Wiring diagram for Y- and Delta connection

Power factor

A motor always consumes active power, which it converts into mechanical action. Reactive power is also required for the magnetisation of the motor but it doesn't perform any action. In the diagram below the active and reactive power is represented by P and Q, which together give the power S.

The ratio between the active power (kW) and the reactive power (kVA) is known as the power factor, and is often designated as the $\cos \phi$. A normal value is between 0.7 and 0.9, when running where the lower value is for small motors and the higher for large ones.

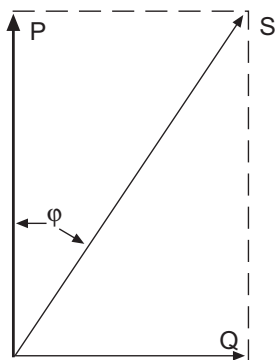

Diagram indicating P, Q, S and $\cos \phi$

Speed

The speed of an AC motor depends on two things: the number of poles of the stator winding and the main frequency. At 50 Hz, a motor will run at a speed related to a constant of 6000 divided by the number of poles and for a 60 Hz motor the constant is 7200 rpm.

To calculate the speed of a motor, the following formula can be used:

$$n = \frac{2 \times f \times 60}{p}$$

n = speed

f = net frequency

p = number of poles

Example:

4-pole motor running at 50 Hz

$$n = \frac{2 \times 50 \times 60}{4} = 1500 \text{ rpm}$$

This speed is the synchronous speed and a squirrel-cage or a slip-ring motor can never reach it. At unloaded condition the speed will be very close to synchronous speed and will then drop when the motor is loaded.

The difference between the synchronous and asynchronous speed also named rated speed is "the slip" and it is possible to calculate this by using the following formula:

$$s = \frac{n_1 - n}{n_1}$$

s = slip (a normal value is between 1 and 3 %)

n_1 = synchronous speed

n = asynchronous speed (rated speed)

Table for synchronous speed at different number of poles and frequency:

No. of poles	50 Hz	60 Hz
2	3000	3600
4	1500	1800
6	1000	1200
8	750	900
10	600	720
12	500	600
16	375	450
20	300	360

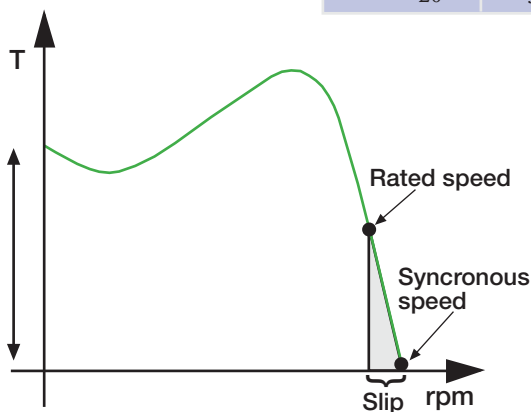

Diagram showing synchronous speed vs. rated speed

Torque

The starting torque for a motor differs significantly depending on the size of the motor. A small motor, e.g. ≤ 30 kW, normally has a value of between 2.5 and 3 times the rated torque, and for a medium size motor, say up to 250 kW, a typical value is between 2 to 2.5 times the rated torque. Really big motors have a tendency to have a very low starting torque, sometimes even lower than the rated torque. It is not possible to start such a motor fully loaded not even at D.O.L start.

The rated torque of a motor can be calculated using the following formula:

$$M_r = \frac{9550 \times P_r}{n_r}$$

M_r = Rated torque (Nm)

P_r = Rated motor power (kW)

n_r = Rated motor speed (rpm)

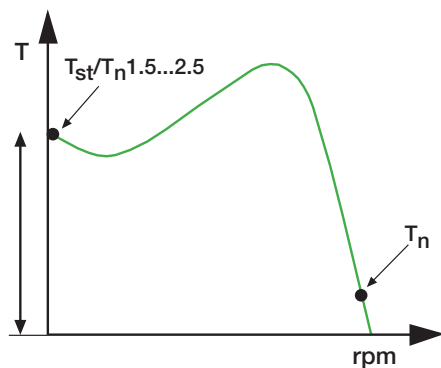

Torque diagram for a typical squirrel cage motor

Slip-ring motors

In some cases when a D.O.L start is not permitted due to the high starting current, or when starting with a star-delta starter will give too low starting torque, a slip-ring motor is used. The motor is started by changing the rotor resistance and when speeding up the resistance is gradually removed until the rated speed is achieved and the motor is working at the equivalent rate of a standard squirrel-cage motor.

The advantage of a slip-ring motor is that the starting current will be lower and it is possible to adjust the starting torque up to the maximum torque.

In general, if a softstarter is going to be used for this application you also need to replace the motor.

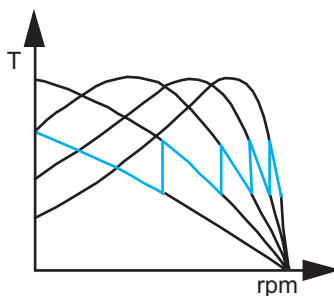

Torque diagram for a slip-ring motor

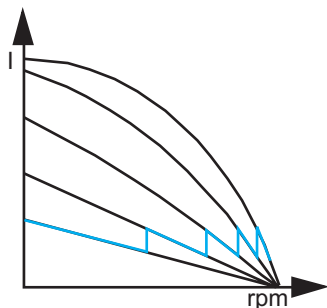

Current diagram for a slip-ring motor

Different starting methods

The following is a short description of the most common starting methods for squirrel cage motors.

An overview of common problems when starting and stopping a motor with different starting methods, see page 14

Direct-on-line start (D.O.L)

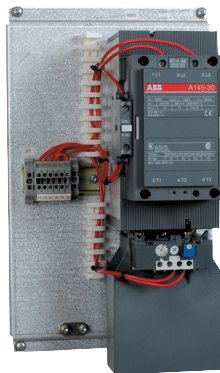

Frequency converter



Start-delta start

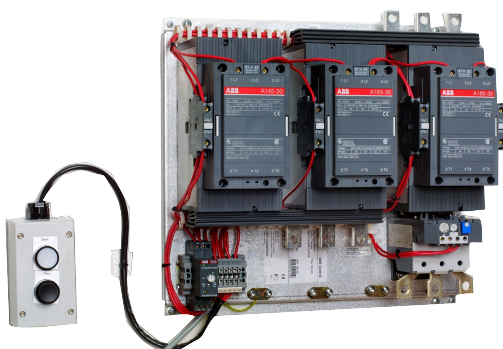

Softstarter



Direct-on-line start (D.O.L)

This is by far the most common starting method available on the market. The starting equipment consists of only a main contactor and thermal or electronic overload relay. The disadvantage with this method is that it gives the highest possible starting current. A normal value is between 6 to 7 times the rated motor current but values of up to 9 or 10 times the rated current exist. Besides the starting current there also exists a current peak that can rise up to 14 times the rated current since the motor is not energised from the the first moment when starting.

The values are dependent on the design and size of the motor, but in general, a smaller motor gives higher values than a larger one.

During a direct-on-line start, the starting torque is also very high, and is higher than necessary for most applications. The torque is the same as the force, and an unnecessary high force gives unnecessary high stresses on couplings and the driven application. Naturally, there are cases where this starting method works perfectly and in some cases also the only starting method that works.

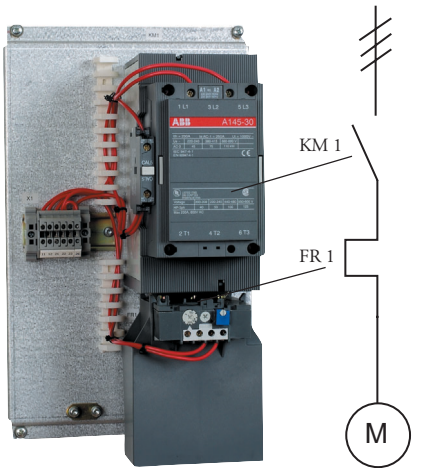

D.O.L. starter with contactor and O/L relay

Single line diagram for a D.O.L.

- KM 1 Main contactor
- FR 1 Overload relay

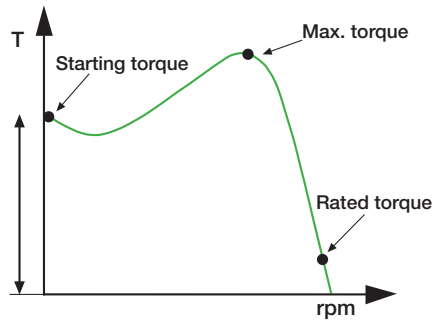

Torque/speed curve att D.O.L. start

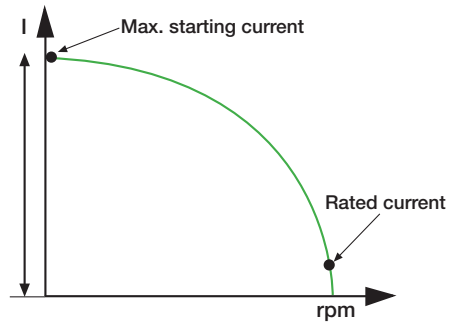

Current curve at D.O.L. start

Star-delta start

This is a starting method that reduces the starting current and starting torque. The device normally consists of three contactors, an overload relay and a timer for setting the time in the star-position (starting position). The motor must be delta connected during a normal run, in order to be able to use this starting method.

The received starting current is about 30 % of the starting current during direct on line start and the starting torque is reduced to about 25 % of the torque available at a D.O.L start. This starting method only works when the application is light loaded during the start. If the motor is too heavily loaded, there will not be enough torque to

accelerate the motor up to speed before switching over to the delta position.

When starting up pumps and fans for example, the load torque is low at the beginning of the start and increases with the square of the speed. When reaching approx. 80-85 % of the motor rated speed the load torque is equal to the motor torque and the acceleration ceases. To reach the rated speed, a switch over to delta position is necessary, and this will very often result in high transmission and current peaks. In some cases the current peak can reach a value that is even bigger than for a D.O.L start. Applications with a load torque higher than 50 % of the motor rated torque will not be able to start using the start-delta starter.

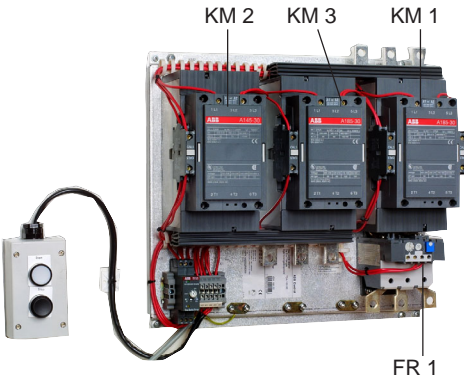

Star-delta starter with contactors and O/L relay

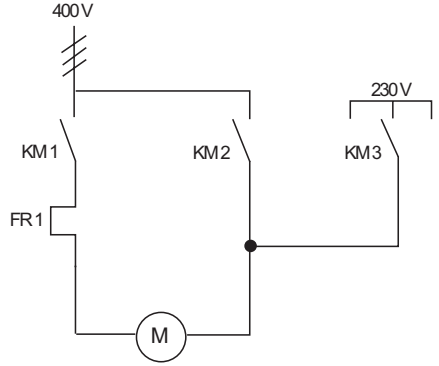

Single line diagram for a Star-delta starter

- KM 1 Main contactor
- KM 2 Delta contactor
- KM 3 Star contactor
- FR 1 Overload relay

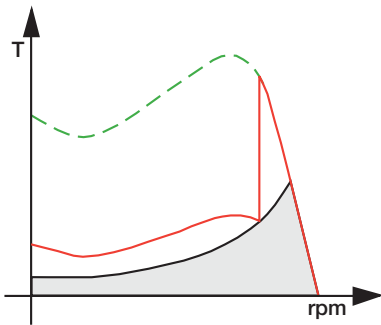

Torque/speed curve at Star-Delta start

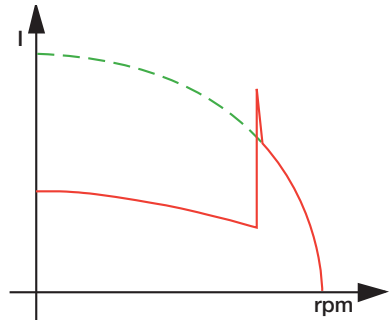

Current curve at Star-Delta start

Frequency converter

The frequency converter is sometimes also called VSD (Variable Speed Drive), VFD (Variable Frequency Drive) or simply Drives, which is probably the most common name.

The drive consists primarily of two parts, one which converts AC (50 or 60 Hz) to DC and the second part which converts the DC back to AC, but now with a variable frequency of 0-250 Hz. As the speed of the motor depends on the frequency this makes it possible to control the speed of the motor by changing the output frequency from the drive and this is a big advantage if there is a need for speed regulation during a continuous run.

In many applications a drive is still only used for starting and stopping the motor, despite the

fact that there is no need for speed regulation during a normal run. Of course this will create a need for much more expensive starting equipment than necessary.

By controlling the frequency, the rated motor torque is available at a low speed and the starting current is low, between 0.5 and 1.0 times the rated motor current, maximum $1.5 \times I_n$. Another available feature is softstop, which is very useful, for example when stopping pumps where the problem is water hammering in the pipe systems at direct stop. The softstop function is also useful when stopping conveyor belts from transporting fragile material that can be damaged when the belts stop too quickly.

It is very common to install a filter together with the drive in order to reduce the levels of emission and harmonics generated.



Frequency converter

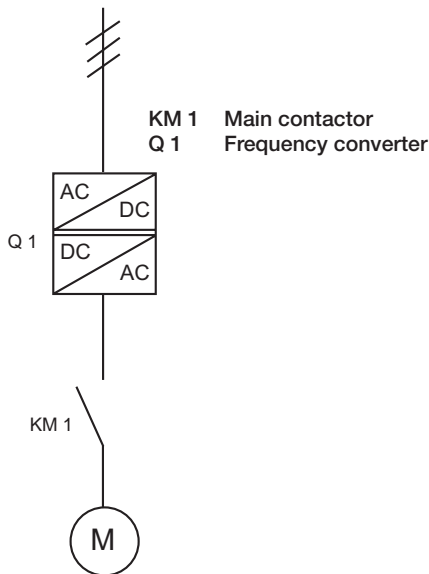

Single line diagram for a frequency converter

Softstarter

A softstarter has different characteristics to the other starting methods. It has thyristors in the main circuit, and the motor voltage is regulated with a printed circuit board. The softstarter makes use of the fact that when the motor voltage is low during start, the starting current and starting torque is also low.

During the first part of the start the voltage to the motor is so low that it is only able to adjust the play between the gear wheels or stretching driving belts or chains etc. In other words, eliminating unnecessary jerks during the start.

Gradually, the voltage and the torque increase so that the machinery starts to accelerate.

One of the benefits with this starting method is the possibility to adjust the torque to the exact need, whether the application is loaded or not. In principle the full starting torque is available, but with the big difference that the starting procedure is much more forgiving to the driven machinery, with lower maintenance costs as a result.

Another feature of the softstarter is the softstop function, which is very useful when stopping pumps where the problem is water hammering in the pipe system at direct stop as for star-delta starter and direct-on-line starter.

The softstop function can also be used when stopping conveyor belts to prevent material from damage when the belts stop too quickly.



Softstarter

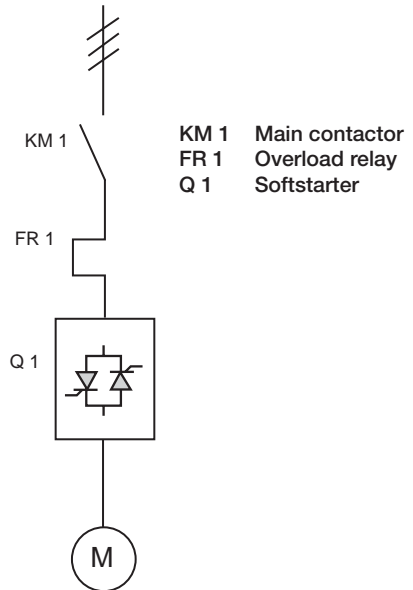

Single line diagram for a softstarter

Common problems when starting and stopping motors with different starting methods

Type of problem Type of starting method

	Direct-on-line	Star-delta start	Drives	Softstarter
Slipping belts and heavy wear on bearings	Yes	Medium	No	No
High inrush current	Yes	No	No	No
Heavy wear and tear on gear boxes	Yes	Yes (loaded start)	No	No
Damaged goods / products during stop	Yes	Yes	No	No
Water hammering in pipe system when stopping	Yes	Yes	Best solution	Reduced
Transmission peaks	Yes	Yes	No	No

Auto transformer start and start of a part winding motor have similar problems to the star-delta start.

Different applications

All motors are used for starting and running different applications. This chapter covers the most common ones. The different applications will also result in different load conditions for the motor. There are two factors to consider:

1. **Braking load torque**, a direct braking force on the motor shaft. To be able to accelerate, the motor has to be stronger than the load. The accelerating torque is the difference between the available motor torque and the load torque.

$$\text{Accelerating torque} = \text{Available motor torque} - \text{load torque}$$

2. **Involved moment of inertia or flywheel mass** will also affect the start. The bigger inertia the longer starting time for the same motor.

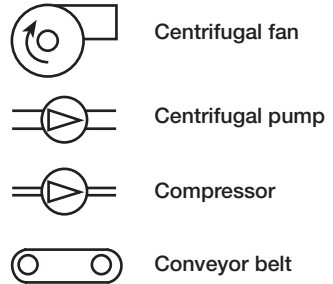
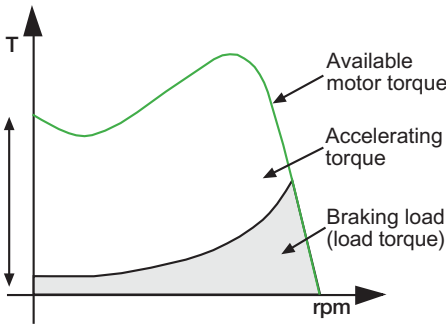

Centrifugal fan



For some applications the motor is started with reduced load torque, i.e. unloaded start. Big centrifugal fans are often started with a closed damper and this will make the start easier (shorter) but since the moment of inertia is still present the starting time might be quite long anyway.

Direct-on-line start

Centrifugal fans are very often driven by one or more drive belts. During a D.O.L start these belts have a tendency to slip. The reason is that these types of fans always have a more or less high moment of inertia (big flywheel). So even if the fan is started unloaded, the flywheel is still there.

The belts slip depending on whether the starting torque from the motor is too high during the start sequence and the belts are not able to transfer these forces. This typical problem gives high maintenance costs but also production losses when you need to stop production to change belts and bearings.

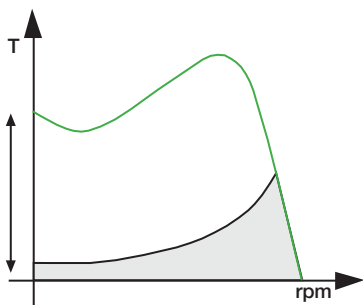

Torque/speed curve at D.O.L start

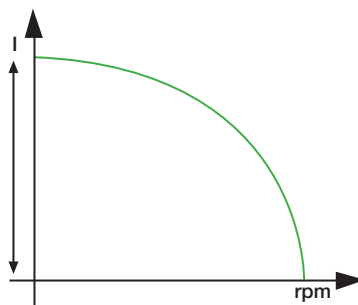

Current curve at D.O.L start

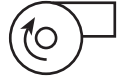

Star-delta starter (Y-D)

The star-delta starter gives lower starting torque but depending on the fact that the load torque increases with the square of the speed, the motor torque will not be high enough in the star position to accelerate the fan to the rated speed.

When switching over to delta position it will be both a high transmission and current peak, often equal to values when making a D.O.L start or even higher, with a slipping belt as a result. It is possible to reduce the slip by stretching the belts very hard. This gives high mechanical stresses on bearings both in the motor and the fan with high maintenance costs as result.

Softstarter

The key to solve these problems is to reduce the starting torque from the motor during start. By using an ABB softstarter the voltage is decreased to a low value at the beginning of the start, low enough to avoid slip but high enough to start up the fan. The softstarter provides the ability to adjust to fit any starting condition, both unloaded and fully loaded starts.

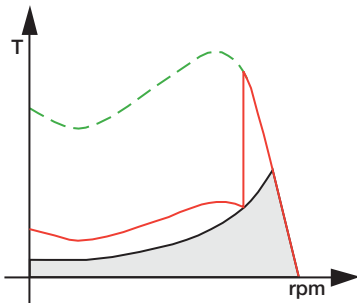

Torque/speed curve at Star-Delta start

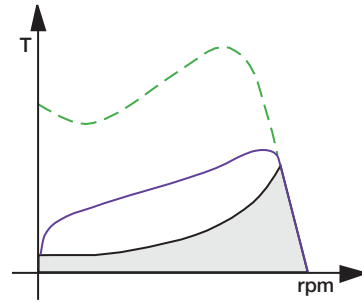

Torque/speed curve when using a softstarter

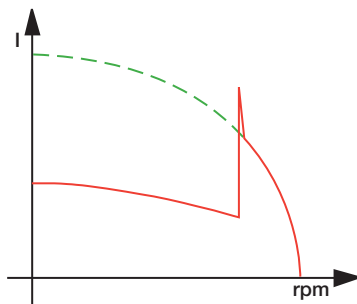

Current curve at Star-Delta start

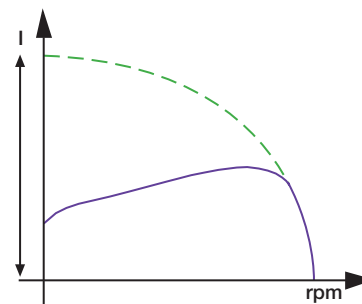

Current curve when using a softstarter



Selection of a suitable softstarter

Normal start

For fans with small or medium large flywheels, select a softstarter according to the rated motor power.

The above is valid if the time for D.O.L start is less than 5 seconds.

Heavy duty start

For fans with large flywheels, select a softstarter designed for heavy duty start according to the rated motor power. It is also possible to select a softstarter for normal start, select a unit with one size bigger power rating than the motor and use an overload relay class 30.

The above is valid if the time for D.O.L start is more than 5 seconds.

Recommended basic settings:

Start ramp: 10 sec.

Stop ramp: 0 sec.

Initial voltage: 30 %

Current limit is recommended for use.

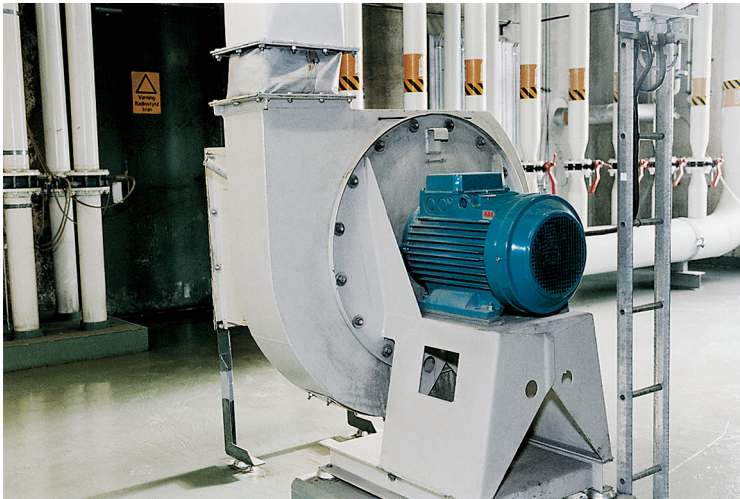

Application with a centrifugal fan

Centrifugal pump



There are a lot of different types of pumps; like piston pumps, centrifugal pumps, screw pumps etc. But the most common version is the centrifugal pump and we have selected this one to describe.

Direct-on-line start

Starting up a pump is normally not a problem for a squirrel cage motor. The problem is the wear and tear depending on pressure waves in the pipe system created when the motor starts and stops too quickly. During a D.O.L start the motor gives much too high starting torque with the result that the motor accelerates and reaches nominal speed too quickly. The reason is that the braking load torque is low for a pump during start. This starting method also gives maximum possible starting current.

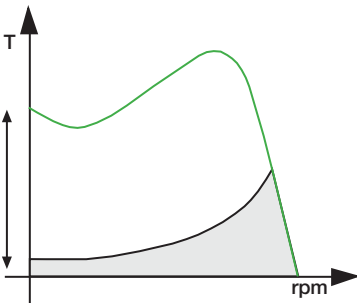

Torque/speed curve at D.O.L start

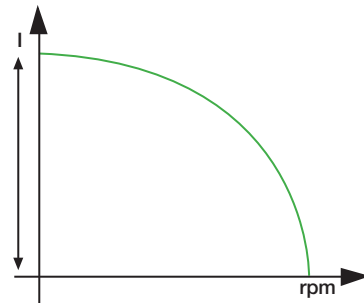

Current curve at D.O.L start



Star-delta starter (Y-D)

By using a star-delta starter it is possible to reduce the starting torque. The motor torque in the star position is too weak to be able to complete the start and reach the rated speed.

The quadratic load torque will become too high for the motor when reaching approx. 80-85 % of the rated speed and the switch over to the delta position will give both high transmission and current peaks with pressure waves as a result. The current peaks can be equally high as at a D.O.L start or even higher.

When stopping a pump

During stop it is also normal to have problems. When making a direct stop by disconnecting the main supply the motor stops too quickly. Depending on high mass flow in the pipe system the water will continue with the same speed for a short period and then come back again, backwards in the pipe system. This creates high pressure shocks on valves and gives high mechanical stresses on the pipe system.

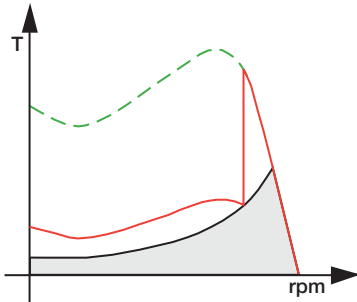

Torque/speed curve at Star-Delta start

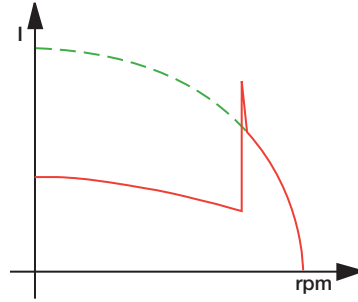

Current curve at Star-Delta start



Softstarter

By using an ABB softstarter the voltage is reduced during the start sequence with the result that the motor torque is reduced. During the start sequence the softstarter increases the voltage so that the motor will be strong enough to accelerate the pump to the nominal speed without any torque or current peaks. A normal starting current with a softstarter when starting a fully loaded centrifugal pump is approx. 4 times rated motor current.

Also during the stop sequence the softstarter is the solution. The softstarter reduces the voltage during stop via a voltage ramp and the motor becomes weaker and weaker. Because of this the water speed slows down very smoothly without creating any pressure waves.

A special function on the softstarter is sometimes available, called "step-down voltage", which ensures an optimum setting to the actual need for any pipe system.

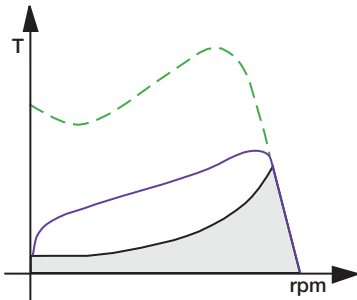

Torque/speed curve when using a softstarter

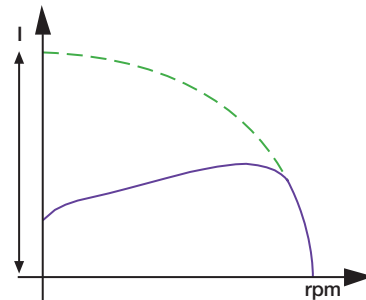

Current curve when using a softstarter



Selection of a suitable softstarter

Normal start

Starting a pump is a typical normal start condition.

Select a softstarter according to the rated motor power.

Heavy duty start

Not applicable for this application.

Recommended basic settings:

Start ramp: 10 sec.

Stop ramp: 20 sec.

Initial voltage: 30 %

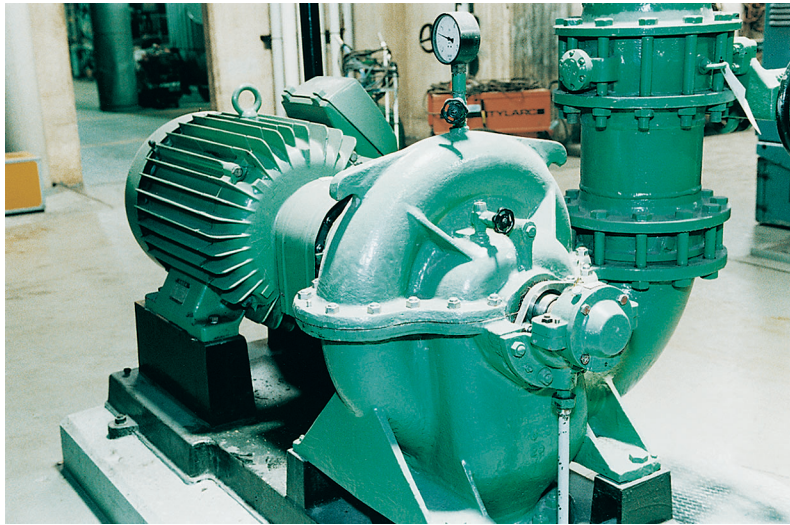

Application with a pump.

Compressor



Smaller compressors are often of piston type and the load torque increases linearly with the speed. Screw compressors are often used when there is a bigger need for air flow and this type has a load torque increasing with the square of the speed. Drive belts are often used between motor and compressor but direct connections via some type of toothed couplings are also common. Some compressors are started with reduced load.

Direct-on-line start (D.O.L)

Compressors started direct-on-line are exposed to high mechanical stresses on the compressor itself, but also on drive belts and couplings. The result is shortened endurance. In cases where the

drive belts are used the belts very often slip during start. The high starting torque received during starting with this method is the source of the problems. The starting current is always high at D.O.L start. A normal value can be approx. 7 times rated motor current.

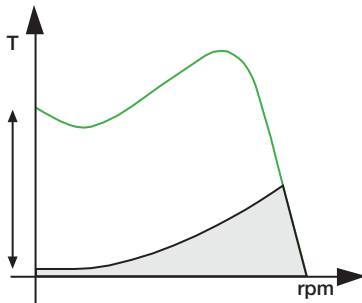

Torque/speed curve at D.O.L start

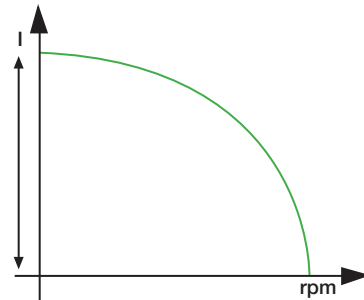

Current curve at D.O.L start



Star-delta starter (Y-D)

Star-delta start gives a lower starting torque and starting current but the motor is too weak during the start up to be able to accelerate the motor up to nominal speed. When switching to the delta position both current and torque peaks

will occur with high mechanical stresses as a result. Compressors are very often running at no load condition for longer periods when the pressure in the system is high. A motor running under these circumstances always has a poor power factor and low efficiency. Some times the value is so low that it must be compensated.

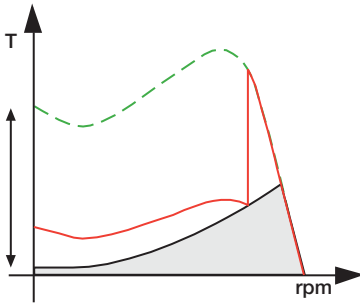

Torque/speed curve at Star-delta start

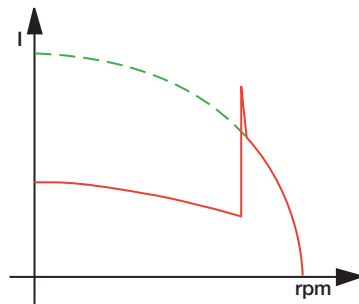

Current curve at Star-delta start



Softstarter

By using an ABB softstarter it is possible to limit the starting torque to a level suitable for all different applications. The result is less stress on couplings, bearings and no slipping belts during start. The maintenance cost will be reduced to a minimum. When using a softstarter the starting current received is approx. 3 to 4 times the rated motor current.

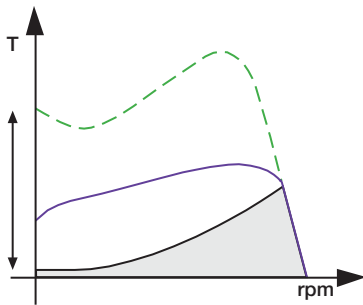

Torque/speed curve when using a softstarter

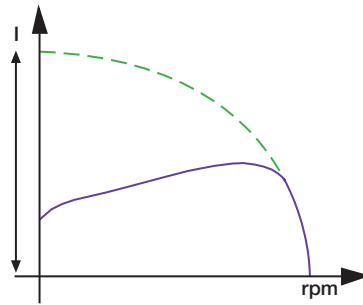

Current curve when using a softstarter



Selection of a suitable softstarter

Normal start

For compressors with D.O.L starting time less than 5 seconds, select a softstarter according to the rated motor power.

Heavy duty start

For compressors with D.O.L starting time more than 5 seconds, select a softstarter designed for heavy duty start according to the rated motor power.

It is also possible to select a softstarter for normal start, select a unit with one size bigger power rating than the motor and use an overload relay class 30.

Recommended basic settings:

Start ramp: 10 sec.

Stop ramp: 0 sec.

Initial voltage: 30 % (piston compressor)
40 % (screw compressor)



Application with a compressor

Conveyor belt

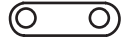

Conveyor belts can have a lot of different looks and directions of use. It is a typical constant torque load with low to high braking torque depending on how heavy it is loaded.

Direct-on-line start (D.O.L)

Conveyor belts often need a starting torque very near or just above the rated torque of the motor. A direct-on-line start with a normal squirrel cage motor gives approx. 1.5 to 2.5 times rated torque of the motor depending on motor size, type etc. When making a direct-on-line start there is a very high risk of slipping between the belt and

the driving role depending on this high starting torque.

Gearboxes and couplings are also exposed to high mechanical stresses. This result is considerable wear and tear and often high maintenance costs. Sometimes fluid couplings are used to reduce the transferred torque. This method is expensive and requires a lot of maintenance.

Low braking torque

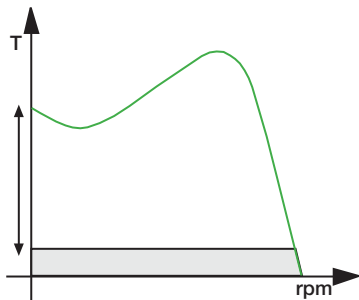

Torque/speed curve at D.O.L start

High braking torque

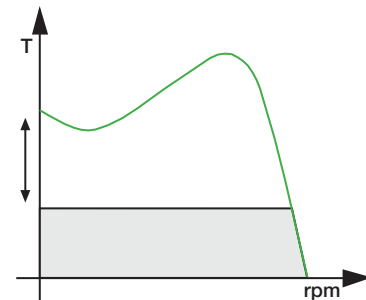

Torque/speed curve at D.O.L start

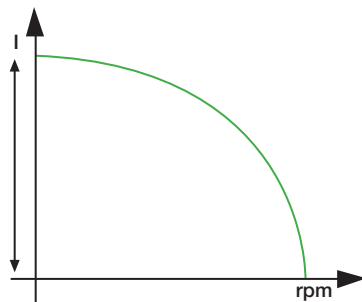

Current curve at D.O.L start

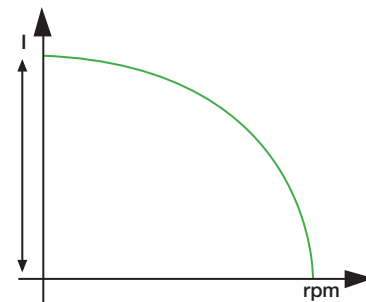

Current curve at D.O.L start

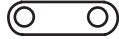

Star-delta start

It is not possible to use this starting method when the load torque is close to the rated motor torque during start (see figure below, High braking torque).

Low braking torque

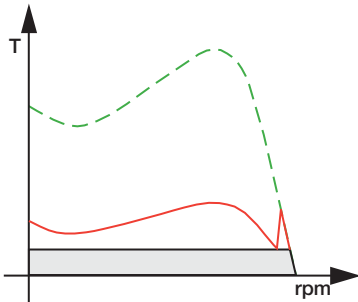

Torque/speed curve at Star-delta start

High braking torque

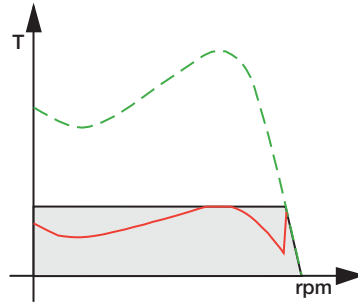

Torque/speed curve at Star-delta start

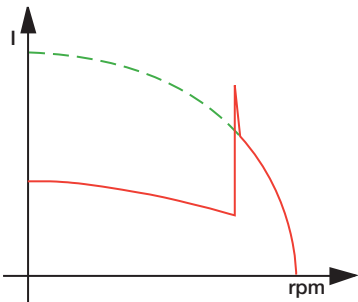

Current curve at Star-delta start

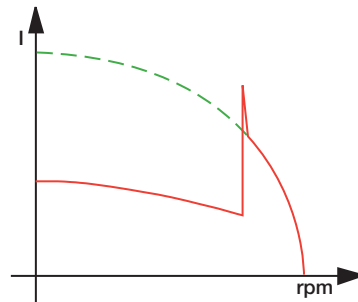

Current curve at Star-delta start

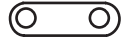

Softstarter

By using an ABB softstarter the starting torque can be reduced to a minimum value still able to start up the conveyor belt. The setting possibility of the softstarter makes it possible to adjust the torque to exactly the level that is necessary for the start. The result is the least possible stress on

gearboxes and couplings and no slipping belts during start. This will reduce the maintenance cost to a minimum. When using a softstarter you will receive approx. 3 to 4 times rated motor current during start.

Low braking torque

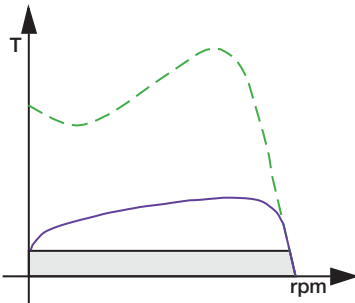

Torque/speed curve when using a softstarter

High braking torque

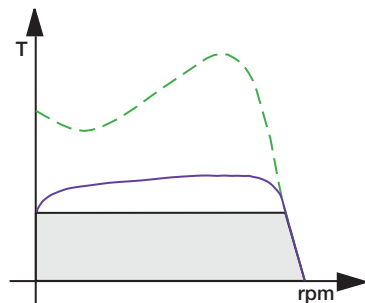

Torque/speed curve when using a softstarter

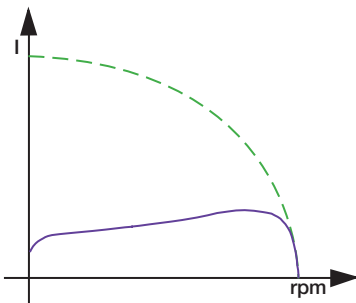

Current curve when using a softstarter

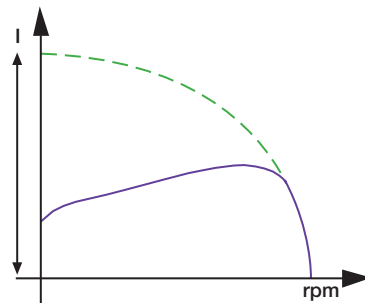

Current curve when using a softstarter

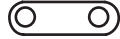

Selection of a suitable softstarter

Normal start

A start of short and light loaded conveyor belt is a typical normal start.

For conveyors with D.O.L starting time less than 5 seconds, select a softstarter according to the rated motor power.

Heavy duty start

Conveyor belts can in some cases be very long and if the belt is fully loaded during start the starting time can be very long. For such applications select a softstarter designed for heavy duty start. It is also possible to select a softstarter for normal start if the softstarter is chosen one size larger than the rated motor power and use an overload relay class 30.

Recommended basic settings:

Start ramp: 10 sec.

Stop ramp: 0 sec.

(If fragile material use 10 seconds)

Initial voltage: 40 %



Application with a conveyor belt

How to select a softstarter for different applications

It is normally possible to select a softstarter according to the rated motor power. In some cases it is necessary to select a larger softstarter than the rated motor power depending on the starting conditions (heavy duty start, many starts/h etc.) The starting capacity of a softstarter is very much depending on the thyristor capacity and the heat sink.

The table below can be used as a guide to select a softstarter if you need a quick answer and you want to be sure that the size is large enough to suit the application. This selection will not give the most optimized solution.

If an optimised solution is required, the software selection program "ProSoft" for selection of softstarters can be used, available on www.abb.com/lowvoltage.

Quick guide

Normal start

Typical applications

- »Bow thruster
- »Compressor
- »Elevator
- »Centrifugal pump
- »Conveyor belt (short)
- »Escalator

Selection

Select the softstarter according to the rated motor power.

For units with built-in overload, select trip class 10.

Heavy duty start

Typical applications

- »Centrifugal fan
- »Crusher
- »Mixer
- »Conveyor belt (long)
- »Mill
- »Stirrer

Selection

For softstarters designed for normal start, select one size larger than the rated motor power.

For softstarters designed for heavy duty start, select according to the rated motor power.

For units with built-in overload, select trip class 30.

If more than 6 starts /h

Select one size larger than the selection above.

Description of the softstarters

- Design, settings and signals

A softstarter in general is built up with a few main components such as a printed circuit board (PCB), heat sink, thyristors, fans and housing (plastic or metal). The controlling circuits can be of digital type, analogue type or a combination of these. The output signal relays can be of a type with fixed function or as a free programmable type where the user can decide upon the output function.

The softstarter is sometimes equipped with a built-in electronic overload relay (EOL) replacing the conventional bi-metal relay which is normally used. A built in EOL has much better accuracy than a conventional relay, since the values are calculated electronically and this is especially useful when on intermittent duty.

The need for communication between different devices in a plant and from the devices to a control board is increasing all the time. Many of today's softstarters are equipped with a port for such communication, which normally consists of a few fibre optic cables instead of former solutions, which often required hundreds of thousands of wires. Many different communication protocols exist today and some of them are more common than others, for example Modbus, Profibus, DeviceNet, Interbus-S, LON Works and so on.

Description of different components:

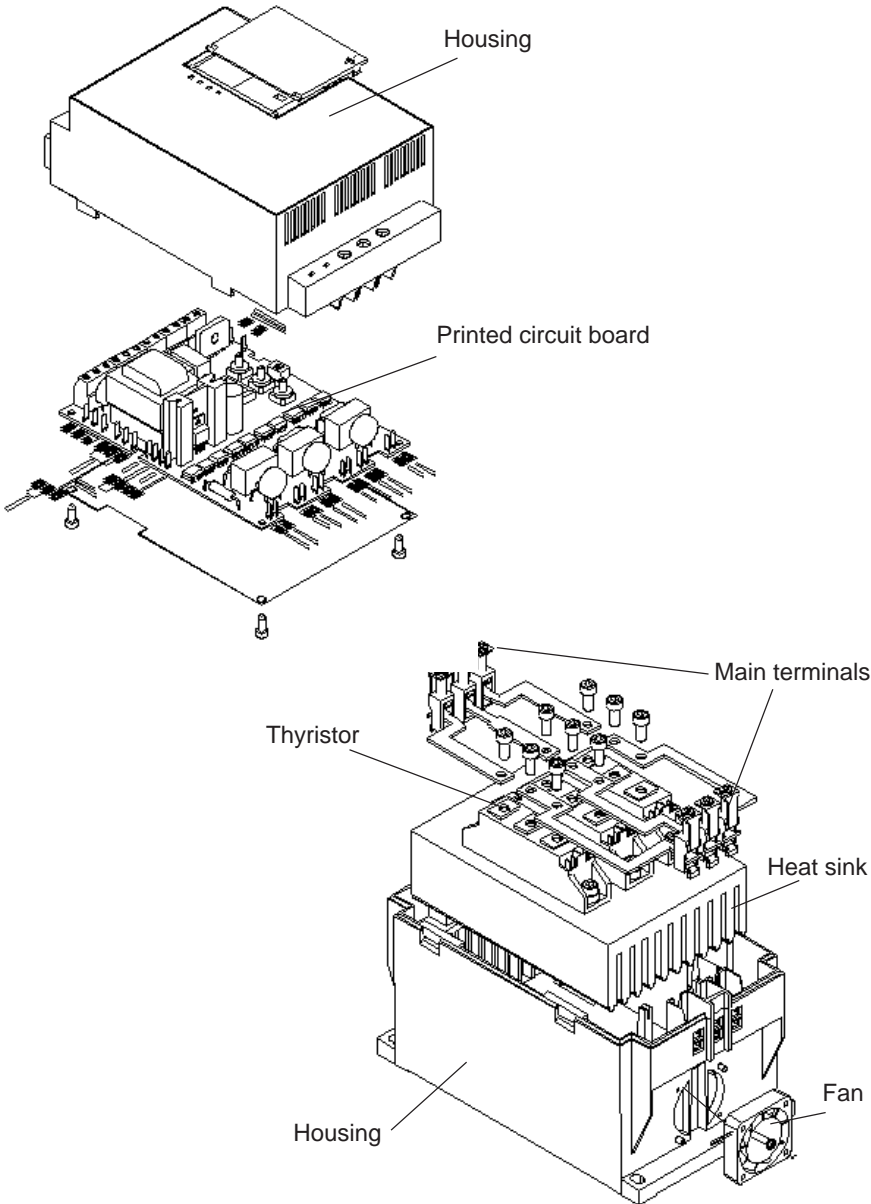

Printed circuit board is used to control the firing of the thyristors based on the current and voltage references, and also for the calculation of different values, for example the power factor, active power, etc. It can also be used for storing historical data, the event log, indicating trends and much more.

Heat sink is used to get rid of the heat in the softstarter generated by the current during the start and the continuous run. The capacity of the heat sink very much reflects the starting capacity and the operational current of the softstarter.

Fans are used to increase the cooling capacity of the heat sink. One, two or several fans can be used depending on size and design. Some smaller softstarters don't have fans at all and the number of starts may be limited.

Housing can be made of plastic material, metal or a combination of these, and its function is to protect the inside components from mechanical and electrical damage. It is also used to protect the components from dust and dirt. For total outside protection from dust and dirt a separate enclosure is often required since the degree of protection (IP class) of the unit itself is too low.

Thyristors are semi-conducting components connected in an anti-parallel fashion and placed in two or three phases of the main circuit. They regulate (by increasing or decreasing) the level of voltage during start and the stop ramp, as described in the picture below. During a continuous run the thyristors are conducting fully.

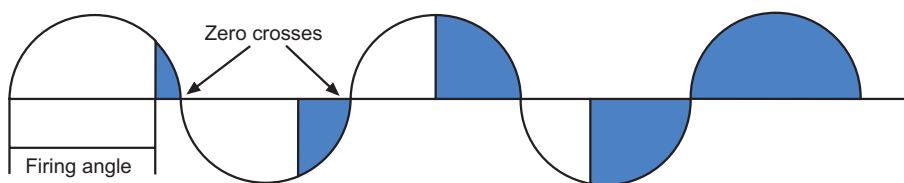

Start: The thyristors let part of the voltage through at the beginning and then increase it, according to the set ramp time for the start.

Stop: The thyristors are fully conducting and when soft stopping, they decrease the voltage according to the set ramp time for stop.

Off : Thyristor is non-conducting

On : Thyristor is conducting

Common settings

This section includes a short description of some common setting parameters available on most of the softstarters. Other settings may be available depending on the type of softstarter and manufacturer. The setting can be done either by adjusting potentiometers, changing dip switches, using a key pad, a computer or similar.

Start ramp is the time from where the softstarter start its ramp (initial voltage) until full voltage is reached. The ramp time should not be too long, as this will only result in unnecessary heating of the motor and a risk of the overload relay to trip. If the motor is unloaded the start time for the motor will probably become shorter than the set ramp time, and if the motor is heavily loaded, the start time will probably become longer.

Stop ramp is used when a soft stopping of the motor is required, for example a pump or a conveyor belt. The stop ramp is the time from full voltage until stop voltage (initial voltage) is reached. If the ramp time is set to zero the stop will be like a direct stop.

Initial voltage. Sometimes named pedestrian voltage or torque, this is the point from where the softstarter starts or stops its ramps. The torque of the motor will drop with the square of the voltage and if the voltage is set too low, for example 20 %, the starting torque will become $0.2^2 = 0.04 = 4\%$ only, and the motor will not start from the very beginning. Therefore it is very important to find a level that is just high enough to make the motor take off directly to avoid unnecessary heating.

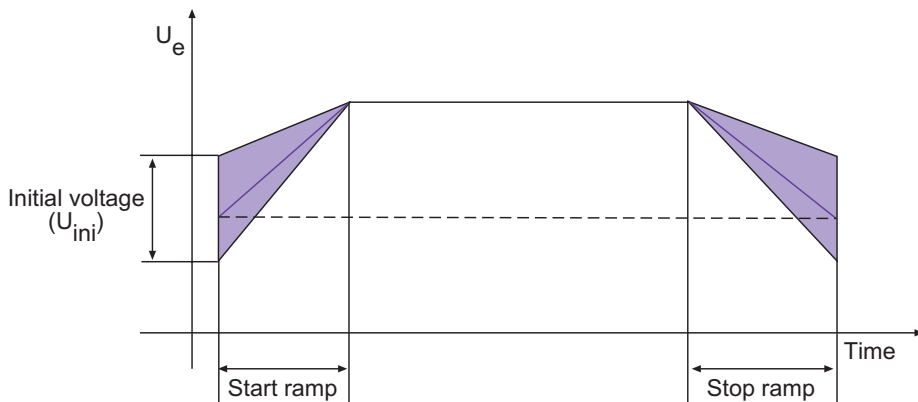
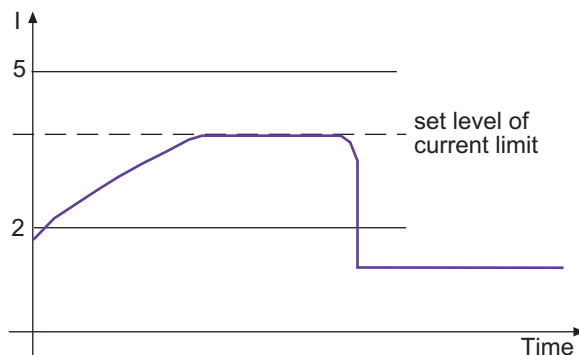
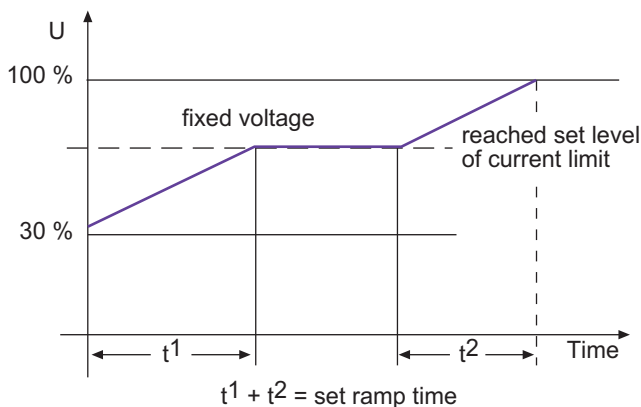

Diagram showing start ramp, stop ramp and initial voltage

Current limit can be used in applications where a limited starting current is required, or at a heavy-duty start when it is difficult to achieve a perfect start with the setting of the initial voltage and the start ramp only. When the current limit is reached, the softstarter will temporarily stop increasing the voltage until the current drops below the set limit, and then continues ramping up to full voltage.

Note that this feature is not available on all softstarters.



Current limit function in softstarter use

Step down voltage gives a special type of stop ramp. It is possible to adjust the voltage to drop to a level where the speed of the motor starts to reduce immediately at the stop command. For low loaded motors the speed will not reduce until a very low voltage is reached, but using the step down voltage function can eliminate this phenomenon and is especially useful for stopping pumps.

Adjustable rated motor

current makes it possible to set the motor rated current on the softstarter for the used motor. This setting may affect other values as well, such as the trip level of the electronic overload relay, the level of the current limit function and so on.

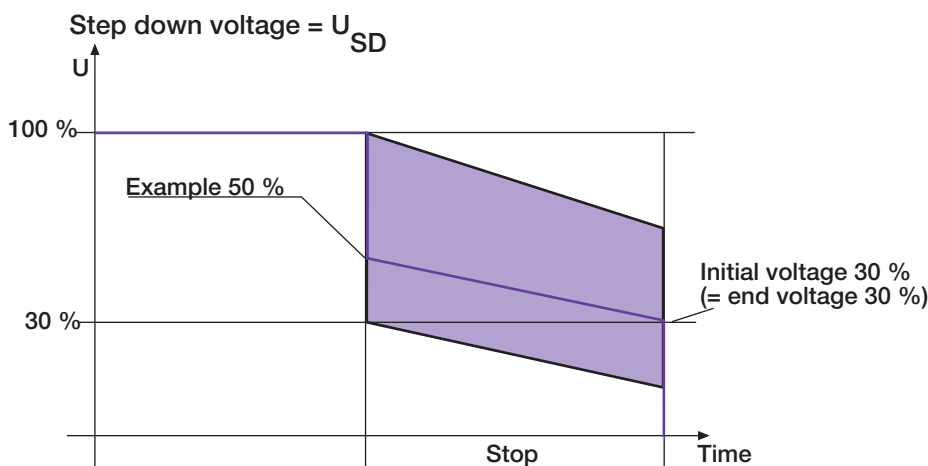

Curve showing the step down voltage function

Different indications

The indications on a softstarter differ very much from one type to another and also between manufacturers. Some of the most common indications are described below.

On normally indicates that the power supply is connected to the softstarter and that the unit is ready to start the motor.

Top of Ramp indicates that the start ramp is completed and full voltage is reached. If a by-pass contactor is used it will be activated at this point.

Fault indication can be of many different types. One is if there is an internal fault on the softstarter itself, a fault on the feeding side (phase loss, blown fuse or similar) or on the motor side (motor not connected, phase missing etc.)

Overload indicates that the overload protection has tripped. The reason for a tripping overload can be too high motor current, too long starting time, too many starts after each other, wrong set overload, wrong trip class of overload or a combination of these.

Overtemperature indicates that the softstarter unit is over-heated, due to the number of starts exceeded, too high-rated current, too long starting time or similar.

Different voltages

Different named voltages are used for the softstarters. The name and use of these different voltages is stated in the IEC-standard as below.

Main Voltage (U_e),

which is the voltage feeding the motor and also the voltage exposed to the main circuit (thyristors) in the softstarter. 200 - 690 V are normal values.

Supply voltage (U_s),

which is the voltage feeding the electronic components inside the softstarter, for example the printed circuit board. Common values are 110 - 120 V or 220 - 240 V.

Control Voltage (U_c),

which is the voltage for controlling the start and stop command of the softstarter. Values between 24 - 480 V exist.

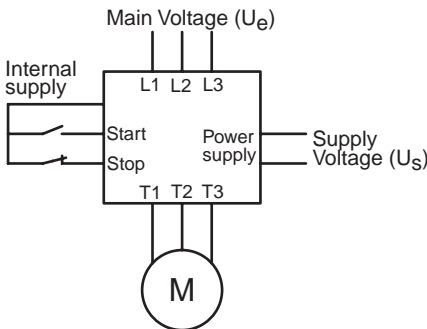

Main voltage and supply voltage to a softstarter

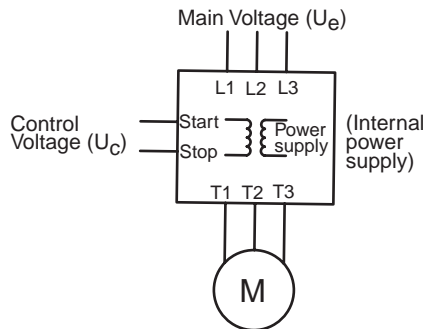

Main voltage and control voltage to a softstarter

Ambient temperature

The ambient temperature is the average surrounding temperature of the softstarter over a period of 24 hours. For most types of softstarter the temperature may not exceed 40 °C without derating the operational current for the unit.

The maximum ambient temperature during operation differs from one type of softstarter to another and must be checked individually according to the manufacturer's specification.

When using an ABB softstarter with an ambient temperature of above 40 °C, the following formula can be used to calculate the operational current:

$$I_e \text{ derated} = I_e - (\Delta T \times I_e \times 0.008)$$

$I_e \text{ derated}$ = maximum operational current after derating

I_e = rated current of the softstarter

ΔT = temperature difference

0.008 = derating factor

Example 1

Rated current: 105 A

Ambient temperature: 48 °C

Derating with 0.8 % per °C above 40 °C
(PS S 18...300)

$$\Delta T = 48 - 40 \text{ °C} = 8 \text{ °C}$$

$$\text{New current} = I_e - (\Delta T \times I_e \times 0.008) = 105 - (8 \times 105 \times 0.008) = 98,2 \text{ A}$$

Example 2

Rated current: 300 A

Ambient temperature: 46 °C

Derating with 0.8 % per °C above 40 °C
(PS S 18...300)

$$\Delta T = 46 - 40 \text{ °C} = 6 \text{ °C}$$

$$\text{New current} = I_e - (\Delta T \times I_e \times 0.008) = 300 - (6 \times 300 \times 0.008) = 285,6 \text{ A}$$

Derating when used at high altitudes

When a softstarter is used at high altitudes the rated current for the unit has to be derated, due to less cooling. For most manufacturers the catalogue values are valid up to 1000 m above sea level before derating is necessary.

In some cases a larger softstarter is required to be able to cope with the motor current when used at high altitudes.

For ABB softstarters the following formula can be used for calculating the derating:

$$\% \text{ of } I_e = 100 - \frac{x - 1000}{150}$$

x = actual altitude for the softstarter

Example:

Softstarter with rated current 300 A used at 2500 meter above sea level.

$$\begin{aligned} \% \text{ of } I_e &= 100 - \frac{2500 - 1000}{150} = \\ &= 100 - \frac{1500}{150} = 90 \end{aligned}$$

$$I_e = 300 \times 0.9 = 270 \text{ A}$$

The diagram below can also be used for defining the derating of the softstarter.

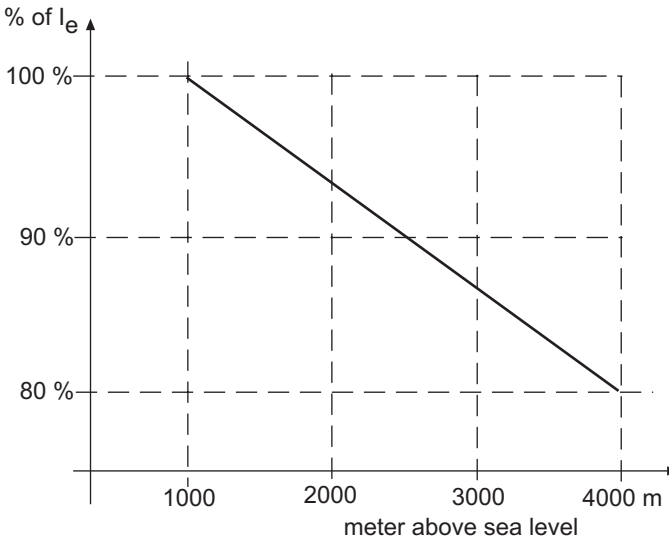

Derating of motor current at high altitudes

Start of several motors

In some applications, more than one motor will be started with one softstarter, in parallel with each other or in a sequence. This is often possible to do but some data has to be taken into consideration.

Parallel start of motors

If a softstarter is going to be used for starting several motors at the same time (parallel start), there are two important parameters to check:

1. The softstarter must be able to cope with the rated current for all motors together.
2. The softstarter must be able to cope with the starting current for all motors together until rated speed is achieved.

Note! If a by-pass contactor is used for the softstarter, only point 2 above has to be taken into consideration.

Example:

Start of two motors with $I_c = 100$ A and relative starting current $4 \times I_c$.
Starting time is 10 seconds.
Total starting current is $100 \times 4 \times 2 = 800$ A over 10 seconds.

Check the softstarter starting capacity graph to verify the selected size.

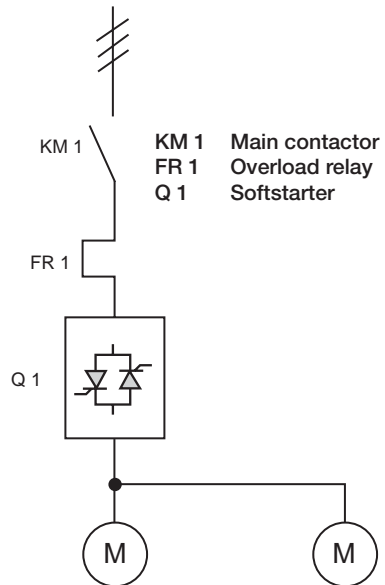

Parallel start of motors using a softstarter

Sequential start of motors

If a softstarter is going to be used for starting several motors one by one (sequential start), it is important to check that the softstarter is able to cope with the starting current for each motor during the whole starting sequence.

Example:

Start of three motors with $I_e=100$ A and relative starting current $4 \times I_e$.
 Starting time for the motors is:
 Motor 1 = 5 seconds
 Motor 2 = 10 seconds
 Motor 3 = 8 seconds

The starting current for the motors is $100 \times 4 = 400$ A and the total starting time is $5 + 10 + 8 = 23$ seconds.

Check the softstarter starting capacity graph to verify the selected size.

Note! It is not possible to add the starting time for each motor if the rated current is different from one motor to another. A separate calculation has to be made for those applications.

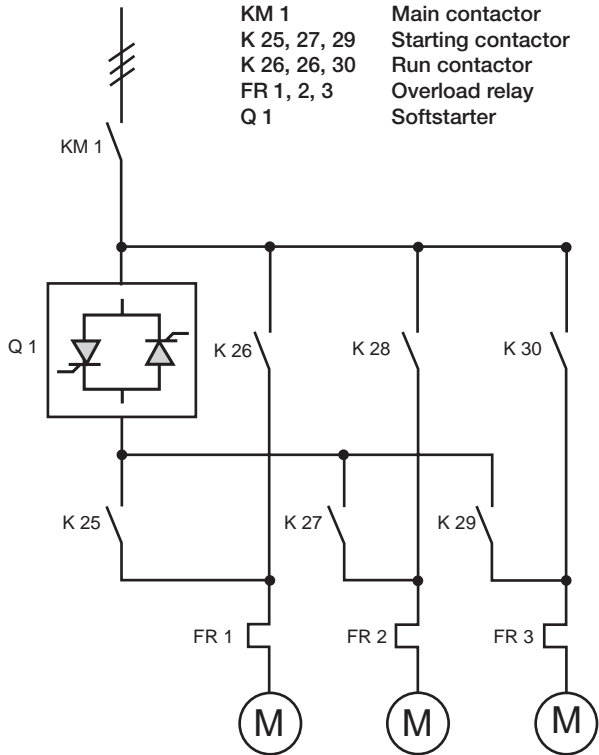

Sequential start of motors using a softstarter

Different ways of connecting the softstarter

There are two different ways of connecting the softstarter - In line, which is the most common method, and Inside Delta. Note that only a few types of softstarters can actually be connected Inside Delta for example the ABB softstarter range PS S 18/30...300/515.

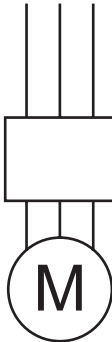

In line

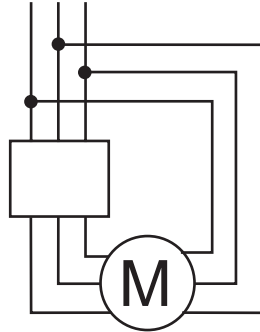

Inside Delta

In-line connection

This is easily the most common way to connect the softstarter.

All three phases are connected in a series with the overload relay, the main contactor and other devices used just like the diagram below. The selected devices for Inline connection must be chosen to cope with the rated motor current.

Example: 100 A motor requires a 100 A softstarter, 100 A main contactor etc.

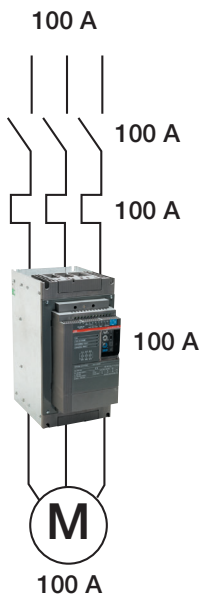

Softstarter connected In-line with the motor

Inside Delta connection

The Inside Delta connection makes it possible to place the softstarter in the delta circuit and in that way it can easily replace an existing Y/D-starter.

When the softstarter is Inside Delta it will only be exposed to 58 % ($1/\sqrt{3}$) of the In-line current. Therefore it is possible to downsize the devices in order to achieve a more cost-effective solution.

Example: A 100 A motor requires a 58 A softstarter, a 58 A main contactor if placed in the delta circuit, etc.

A motor used for an Inside Delta connection must be able to delta-connect during a continuous run. In the USA and some other countries a special six-wire motor has to be ordered for this type of connection.

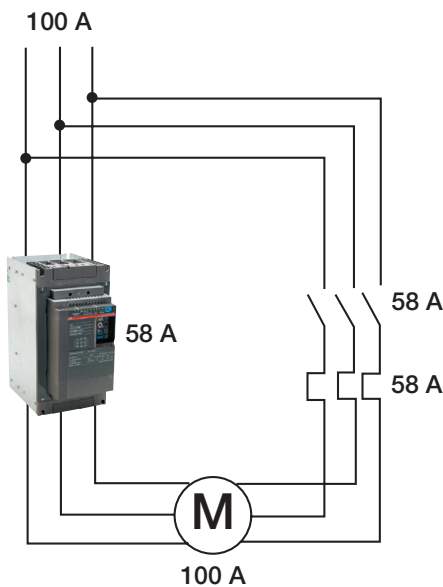

Softstarter connected Inside Delta

Location of the main contactor

When using the softstarter Inside Delta there are two options for the main contactor: in the delta circuit or outside. Both locations will stop the motor but in alternative A, the motor is still considered to be under tension.

In alternative B the main contactor must be chosen according to the rated current of the motor, while the contactor in alternative A can be chosen according to 58 % ($1/\sqrt{3}$) of the rated current.

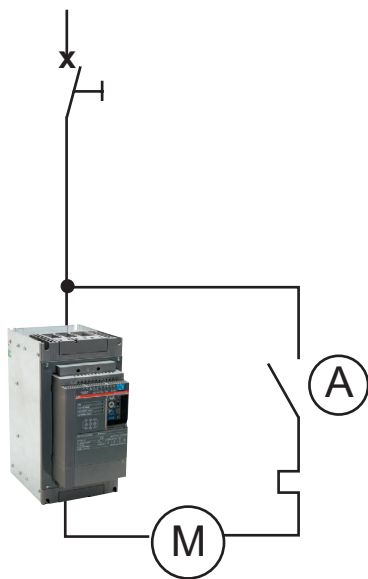

Alternative A
Main contactor located in the delta circuit

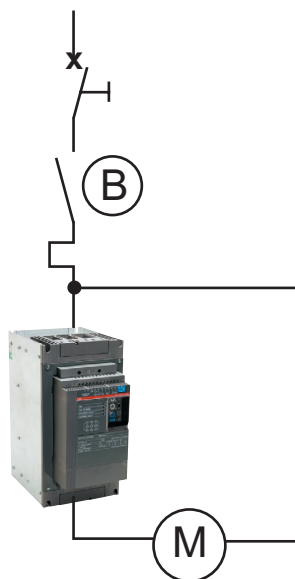

Alternative B
Main contactor located outside the delta circuit

Basic settings for different applications

The required settings for the softstarter will differ from one application to another depending on the type of load, motor characteristics, how much the motor is loaded, etc.

For a more in depth description of each setting, please see chapter "Description of the softstarters".

Note ! All settings on next page are only proposals and may change from one application to another and therefore need to be checked individually.

Settings when using a softstarter without current limit function

Type of load	Ramp time for start (sec.)	Ramp time for stop (sec.)	Initial voltage U_{ini}
Bow thruster	10	0	30 %
Centrifugal fan	10	0	30 %
Centrifugal pump	10	20	30 %
Centrifuge	10	0	40 %
Conveyor belt	10	0 ¹⁾	40 %
Crusher	10	0	60 %
Escalator	10	0	30 %
Heat pump	10	20	30 %
Hydraulic pump	10	0	30 %
Lifting equipment	10	10	60 %
Mill	10	0	60 %
Piston compressor	10	0	30 %
Rotary converter	10	0	30 %
Scraper	10	10	40 %
Screw compressor	10	0	40 %
Screw conveyor	10	10	40 %
Stirrer, Mixer	10	0	60 %
Unloaded motor	10	0	30 %

1) If fragile material, use 10 seconds.

Settings when using a softstarter with current limit function

Type of load	Ramp time for start (sec.)	Ramp time for stop (sec.)	Initial voltage U_{ini}	Current limit ($\times I_e$)
Bow thruster	10	0	30 %	3
Centrifugal fan	10	0	30 %	4
Centrifugal pump	10	20	30 %	3.5
Centrifuge	10	0	40 %	4.5
Conveyor belt	10	0 ¹⁾	40 %	4
Crusher	10	0	60 %	5
Escalator	10	0	30 %	3.5
Heat pump	10	20	30 %	3.5
Hydraulic pump	10	0	30 %	3.5
Lifting equipment	10	10	60 %	4
Mill	10	0	60 %	5
Piston compressor	10	0	30 %	4
Rotary converter	10	0	30 %	3
Scraper	10	10	40 %	4.5
Screw compressor	10	0	40 %	4
Screw conveyor	10	10	40 %	4
Stirrer, Mixer	10	0	60 %	5
Unloaded motor	10	0	30 %	2.5

1) If fragile material, use 10 seconds.

Starting capacity and overload protection

Starting capacity for soft-starters

When starting a squirrel cage motor there will always be a starting current (I_{st}) which is higher than the rated motor current.

The starting current depends on what type of starting method is used and in some cases also the size of the motor, particular at D.O.L-start. For a softstarter a normal value is 3-4 times the rated motor current.

Heavy duty applications normally require a starting current between 4 and 5 times the rated motor current.

The maximum permitted starting time for a softstarter depends on the starting time. The ratio between the current and time is displayed in the graph below.

A higher starting current will give a shorter possible starting time, for example a crusher application. A lower current will allow a longer starting time, for example a pump application.

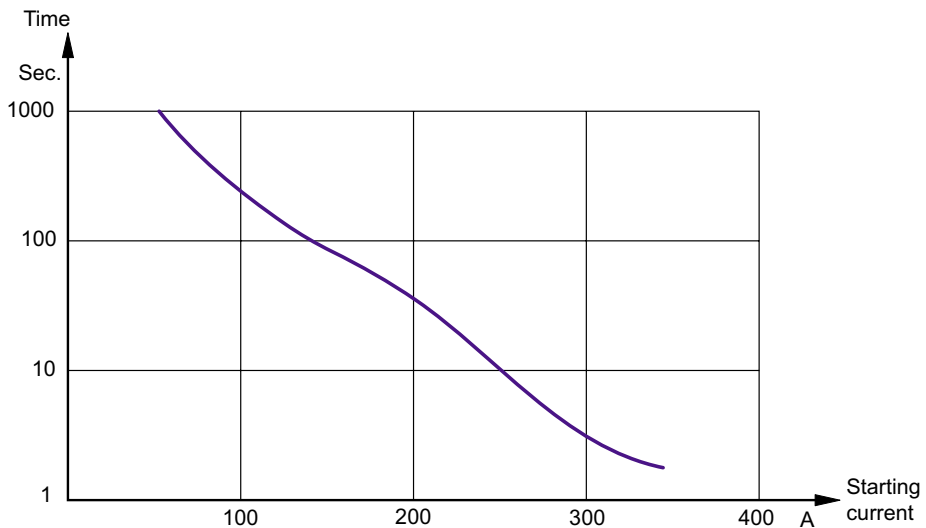

Typical starting capacity graph for a softstarter

Starting capacity when using by-pass contactor

When using a softstarter with a by-pass contactor it is sometimes possible to select a softstarter with a lower rated power than the motor rated power since the softstarter will be working during start and stop only, not continuously.

The softstarter can not withstand the rated motor current and therefore a check of the starting capacity must be carried out for the selected size.

Starting capacity when using overload protection

The overload protection for the motor (thermal or electronic) will very often set the limit of the starting capacity. A class 10 relay is used for normal starts in general while a class 30 relay is used for heavy-duty starts where a longer starting time must be used.

In some applications where the overload protection is by-passed (other protection active) during a start to achieve a longer available starting time, it is particularly important to check the softstarter starting capacity since this will be the limitation.

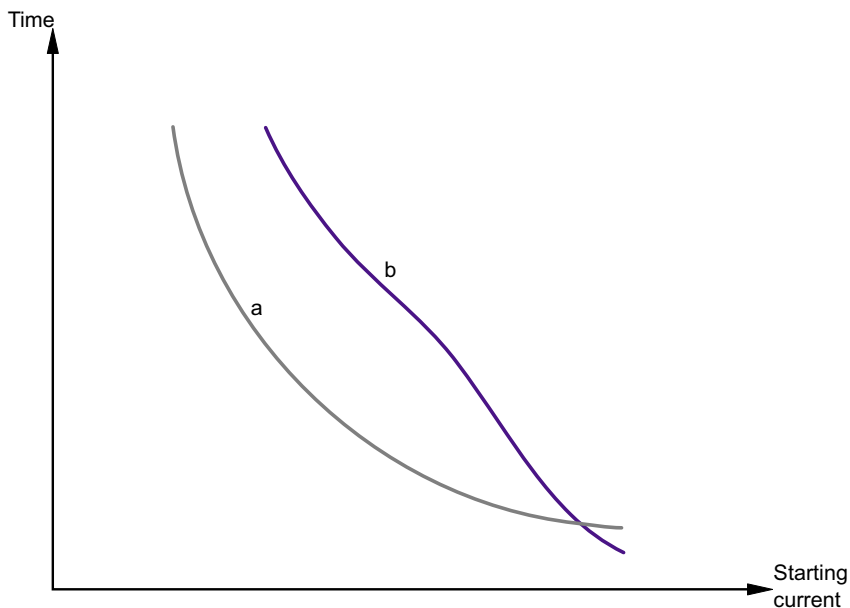

a) Tripping curve for overload protection

b) Max starting capacity for a softstarter (This will limit the starting time / current if the overload is by-passed during start)

Number of starts/hour

The maximum number of starts/hour for a softstarter depends on several different factors such as the starting current, ambient temperature, starting time and the intermittens factor.

Intermittens factor

The intermittens factor is a figure indicating how long the softstarter has been running for (starting time and running time) compared with the total cycle time.

It is important to define the intermittens factor when talking about the number of starts/hour since the OFF time is the cooling time for the softstarter.

A high starting current and a long starting time require a longer OFF time than a low starting current and short time to maintain the same number of starts/hour.

Examples:

If a softstarter has been running for 5 minutes of a total duty cycle of 10 minutes then the intermittens factor is 50 % ON time and 50 % OFF time.

If a softstarter has been running for 45 minutes of a duty cycle of 60 minutes then the intermittens factor is 75 % ON time and 25 % OFF time.

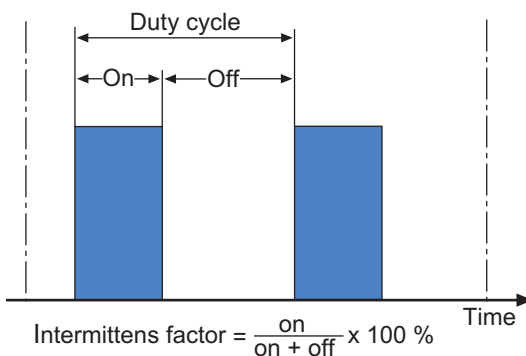

Harmonics

Harmonics are unwanted voltages and currents existing in almost every electrical system today and are always a multiple of the rated frequency.

Typical harmonics are 3rd, 5th, 7th, 9th etc. The harmonics contribute to the unnecessary heating of motors, cables and other equipment and may shorten the lifetime of these devices if exposed for a long period of time.

It can sometimes also disturb functions on electronics and systems. The harmonic contents and the level naturally depends on the source but also on several other parameters such as the impedance in the feeding network, the motor, capacitors and other devices used in the system altogether - in other words a quite complex phenomenon.

Harmonic content and softstarters

The question of harmonic content for softstarter applications is actually in general not relevant at all. These reflections usually come from drive applications where harmonics are generated continuously and a filter is always required in public networks and very often used also in industrial networks. With our softstarters we fulfil the EMC directive concerning emission and immunity and there is no need for any particular actions regarding this matter at all.

Explosive atmospheres (Ex)

For plants in environments where the hazard of explosion is due to an explosive mixture of gases, explosive matter or combustible dust other than explosive dust, special provisions are applicable regarding the use of electrical material. For electrical motors there are two main principles for explosion protection. One is to design the motor so that no sparks or dangerous heat occurs. The other method is to isolate sparks and dangerous heat inside the motor to prevent ignition of any explosive mixture of gases outside the motor.

The different classes of explosive protection (Ex) are described by the following parts of IEC 60079:

IEC 600079-1:	flameproof enclosures "d"
IEC 600079-2:	pressurised enclosures "p"
IEC 600079-5:	powder filling "q"
IEC 600079-6:	oil immersion "o"
IEC 600079-7:	increased safety "e"
IEC 600079-11:	intrinsic safety "i"
IEC 600079-18:	encapsulation "m"
IEC 600079-22:	caplights for mines susceptible to firedamp (under consideration)

Example: Electrical apparatus for explosive atmospheres - oil immersion "o" shall be recognised as Exo.

Hazardous areas and zones

The hazardous areas are categorised in zones as follows:

Zone 0

An area in which an explosive gas atmosphere is present continuously or for long periods. Only intrinsically-safe circuits of category Exi may be used in this zone. Motors are thus excluded.

Zone 1

An area in which an explosive gas atmosphere is likely to occur in normal operation. Motors of category Exd, Exe and Exp may be used in this zone.

Zone 2

An area in which an explosive gas atmosphere is not likely to occur during normal operation and if it does occur it will exist for a short period only. Equipment permitted in zones 0 and 1 may of course be used. Under certain conditions the equipment, motors for instance, need not to be of explosion-protected design.

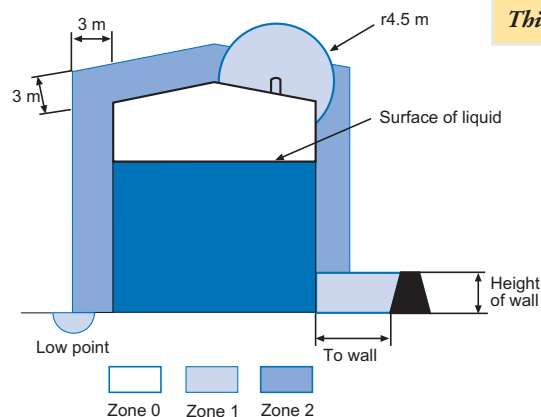

Example of classification and extent of the hazardous area in a tank

Location and selection of softstarter for Ex environments

If a softstarter is going to be used for an Ex application it is normally located in a separate enclosure outside any of the hazardous zones. The overload relay used shall be of a special version designed for EEx motors, for example TA 25 DU...V 1000 to T 900 DU/SU...V 1000. This type of relay has a more accurate tripping curve compared with the standard relay. Special attention has to be paid to this.

The softstarter type and size and other devices used in the circuit shall suitably be selected according to type 2 co-ordination.

Note !

If any electrical equipment is going to be used in any of the hazardous zones a special enclosure (steel box or similar) must be able to withstand an inside explosion caused by any of the components without letting anything out to the surroundings. This solution is in general very unusual.

Co-ordination

By co-ordination we mean a selected combination of electrical apparatus which is safe for the surroundings and personnel, even if an overload or a fault should occur in the system.

The co-ordinated group must ensure the following four essential functions:

- **Protection against overloads.** A protection, which guards all components, cables and the motor from overheating, active for all currents up to, locked rotor current. This device will send a trip signal to a disconnection mean, which is normally a contactor used for the motor control.
- **Motor control.** This function is commonly carried out by a contactor.
- **Protection against short-circuits,** which takes care of all currents above the locked rotor current - i.e. all fault currents.
- **Isolation.** Ensure an isolating air-gap when opened for personnel safety.

The co-ordinations for the ABB softstarters are done according to IEC 60947-4-2 "AC semiconductor motor controllers and starters" and EN 60947-4-2.

The provisions of IEC 60947-1, General Rules, are applicable to IEC 60947-4-2 where specifically called for.

Types of co-ordination

The standard IEC 60947-4-2 defines two types of co-ordination according to the expected level of service continuity. The standard IEC 60947-1, General Rule are applicable to this standard, where specifically called for.

Type 1:

Co-ordination requires that, under short-circuit conditions, the device shall cause no danger to persons or installation and may not be suitable for further service without repair and replacement of parts.

Type 2:

Co-ordination requires that, under short-circuit conditions, the device shall cause no danger to persons or installation and shall be suitable for further use. For hybrid controllers and starters, the risk of contact welding is recognized, in which case the manufacturer shall indicate the measures to be taken as regards the maintenance of the equipment.

Note !

When using a softstarter in a type 2 co-ordination, replacing the fuses and restart has to be accepted after a short-circuit. Only semi-conductor fuses can be used to achieve a type 2 co-ordination for a softstarter.

Utilization Categories

Some utilization categories are stated in the standard IEC 60947-4-2, "AC semiconductor motor controllers and starters". The one used for ABB Low Voltage softstarters is AC-53.

Utilization Category	Typical application
AC-52a	Control of slip-ring motor stators: 8 h duty with on-load currents for start, acceleration, run
AC-52b	Control of slip-ring motor stators: intermittent duty
AC-53a	Control of squirrel cage motors: 8 h duty with on-load currents for start, acceleration, run
AC-53b	Control of squirrel cage motors: intermittent duty
AC-58a	Control of hermetic refrigerant compressor motors with automatic resetting of overload releases: 8 h duty with on-load currents for start, acceleration, run
AC-58b	Control of hermetic refrigerant compressor motors with automatic resetting of overload releases: intermittent duty

Remarks

AC-53 is the utilization category used for softstarters in general since this is about controlling squirrel cage motors. This is the category stated in the header of the co-ordination tables for softstarters.

AC-53a is about softstarter designed for use without by-pass contactor.

AC-53b is about softstarter designed for use with by-pass contactor.

Types of fuses

There are basically three types of fuses used on the market (see below) with different functions and characteristics. One type of fuse cannot in general replace another type without checking the other protection devices in the circuit since the protection characteristic of the fuse is different between the types. If replacing a 100 A fuse with another 100 A fuse (same rating) without checking the type there is a risk of losing protection since the first type may be of type with both short-circuit protection and thermal protection while the replacement fuse is only short-circuit protection.

gL/gG fuses have a combination of short circuit protection and thermal overload protection ($5s > 3,5 \times I_n$) for cables.

If using these types of fuses together with a softstarter, type 1 co-ordination can be achieved. For type 2 co-ordination semi-conductor fuses must be used.

aM fuses have only a short-circuit protection ($5s > 9 \times I_n$), and for thermal overload protection a separate protection device is required.

If using these types of fuses together with a softstarter, type 1 co-ordination can be achieved. For type 2 co-ordination semi-conductor fuses must be used.

Semi-conductor fuses (High speed fuses) are the only type of fuses that are fast enough to achieve a fully type 2 co-ordination when using a softstarter. A separate overload relay for the motor protection is always required in combination with this type of fuse. If replacing the semi-conductor fuses with an MCCB, MMS or similar, type 1 co-ordination will be achieved instead.

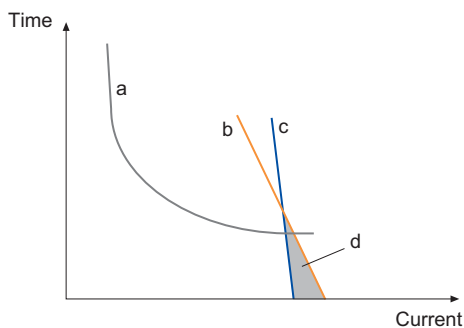

- a: Characteristic of the overload relay
- b: Characteristic of a gL/gG fuse
- c: Characteristic of a semi-conductor fuse
- d: Area where the gL/gG fuse is not fast enough to achieve a type 2 co-ordination

Where to find the co-ordination tables

The co-ordination tables for softstarters can be found on internet page www.abb.com under Low Voltage Products - Product Coordination.

When selecting the wanted product type, for example softstarters the table below will show up.

U _e	Main voltage for the application
I _q	Short-circuit current rating
Coor. Type	Type of co-ordination
Starting type	Type of start, normal or heavy duty
SCPD type	Type of protection device
Size kW	Rated motor power range
Table	Name of the co-ordination table (click on the text to open)
Last Update	Latest date of table update

SOFTSTARTERS

U _e V	I _q kA	Coor. type	Starting type	SCPD type	Size kW	Table	Last Update
400	50	1	Normal	MMS	0.06 ... 50	MMPS4050LIN40-1	13/11/01
			Normal	MMS	15 ... 50	MMPD4050LIN40-1	13/11/01
			Normal	MCCB	0.37 ... 400	MBPS4050LIN40-1	13/11/01
400	65	2	Normal	Fuse	1.5 ... 160	PSS4065LINE40	14/11/01
			Normal	Fuse	1.5 ... 55	PSS4065LINE50	20/11/00
			Normal	Fuse	30 ... 450	PSD4065LINE40	14/11/01
			Normal	Fuse	25 ... 400	PSD4065LINE50	20/11/00
			Normal	Fuse	7.5 ... 132	PSS4065DELTA40	20/11/00
			Normal	Fuse	7.5 ... 110	PSS4065DELTA50	20/11/00
415	65	2	Normal	Fuse	1.5 ... 75	PSS4165LINE40	20/11/00
			Normal	Fuse	1.5 ... 55	PSS4165LINE50	20/11/00
			Normal	Fuse	30 ... 500	PSD4165LINE40	20/11/00
			Normal	Fuse	30 ... 400	PSD4165LINE50	20/11/00
			Normal	Fuse	7.5 ... 132	PSS4165DELTA40	20/11/00
			Normal	Fuse	8 ... 110	PSS4165DELTA50	20/11/00
440	50	1	Normal	MCCB	0.37 ... 400	MBPS4450LIN40-1	13/11/01
500	50	1	Normal	MCCB	0.37 ... 355	MBPS5050LIN40-1	13/11/01
	65	2	Normal	Fuse	2.2 ... 90	PSS5065LINE40	20/11/00
			Normal	Fuse	2.2 ... 75	PSS5065LINE50	20/11/00
			Normal	Fuse	45 ... 550	PSD5065LINE40	20/11/00

Example of starter range, U_e = 400 - 500 V.

How to read the co-ordination tables

In the header of the selected table, information about softstarter type, main voltage, short-circuit rating, maximum ambient temperature, IEC-standard and co-ordination type can be found.

Motor	Indicates the rated output of the motor and maximum current. If this does not correspond fully to the actual motor, select according to the maximum current.
Softstarter	Indicates suitable softstarter type and size for this motor.
Semi-conductor fuses	Indicates rated current and type of semi-conductor fuse.
Switch fuse	Indicates suitable switch fuse for the semi-conductor fuses.
Thermal overload relay	Indicates suitable thermal overload relay, type and setting range.
Line contactor	Indicates suitable line (main) contactor for the motor. This contactor is given with AC-3 rating.
By-pass contactor	Indicates suitable by-pass contactor which is not required for the co-ordination. This contactor is given with AC-1 rating.

SOFTSTARTERS WITH FUSES

500 V - 65 kA - Normal start - up, type : 2

Note : PSS5065LINE40

PSS50/40

SOFTSTARTERS PS S 03 ... 142									
500 V, 65 kA (up to 40°C) IEC 947-4-2, type 2, AC-53a,b									
Starter and fuses in line									
Motor	Softstarter	Semi-conductor fuses	Switch Fuse	Thermal Overload Relay	Line contactor	By-pass contactor			
							Rated Output [kW]	Max current [A]	Type
	3.5	PS S 03-480B	16	170M1359	OS 160RD0380	TA25DU4.0	2.8 - 4.0	A9	Built-in
5.5	9	PS S 12-480B	40	170M1363	OS 160RD0380	TA25DU14	10 - 14	A9	Built-in
7.5	12	PS S 18/30-500	40	170M1364	OS 160RD0380	TA25DU14	10 - 14	A12	A9
		PS S 12-480B	40	170M1363	OS 160RD0380	TA25DU14	10 - 14	A12	Built-in
	14	PS S 18/30-500	50	170M1364	OS 160RD0380	TA25DU14	10 - 14	A16	A9
		PS S 25-480B	50	170M1364	OS 160RD0380	TA25DU14	10 - 14	A16	Built-in
11	17	PS S 18/30-500	50	170M1364	OS 160RD0380	TA25DU19	13 - 19	A26	A9
	18	PS S 18/30-500	50	170M1364	OS 160RD0380	TA25DU19	13 - 19	A26	A9
15	22	PS S 25-480B	50	170M1364	OS 160RD0380	TA25DU25	18 - 25	A26	Built-in
	23	PS S 30/52-500	80	170M1366	OS 160RD0380	TA25DU32	24 - 32	A30	A9

Example of co-ordination table: 500V, 65kA, normal start, type 2 (PSD5065LINE40)

Starter and fuses In-line

The co-ordinations with the devices In-line are based on this circuit diagram.

Note that the by-pass contactor is not required for the co-ordination.

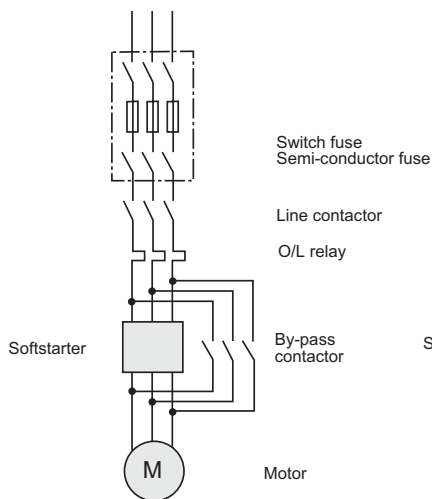

Starter and fuses In-line
Line contactor AC-3
By-pass contactor AC-1

Starter Inside Delta and fuses In-line

The co-ordinations with the softstarter Inside Delta are based on this circuit diagram.

Note that the by-pass contactor is not required for the co-ordination.

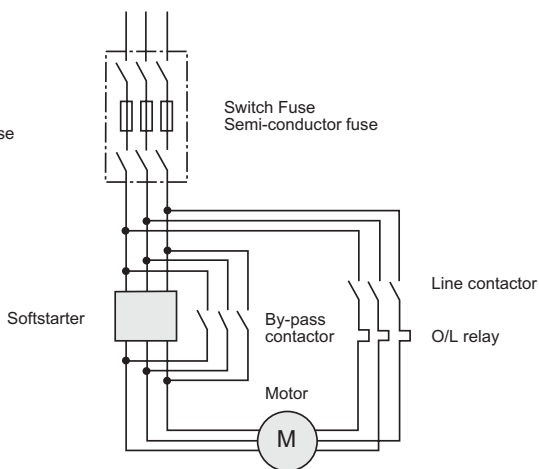

Starter inside delta and fuses In-line
Line contactor AC-3
By-pass contactor AC-1
Line contactor and by-pass contactor Inside Delta connected

ESD – Electro Static Discharge



An increasing problem today with the use of more and more electronic equipment in our systems is the Electro Static Discharge (ESD). The main source of the problem is the wrong handling of electronic components, printed circuit-boards, etc. A component damaged by ESD has been exposed to a too high voltage level and today the components are much more sensitive depending on integration, which means more functions in the same capsule. The distances between the conductors are decreased and therefore the insulation distance will be at a minimum. A value of 0.002 mm is common in modern integrated circuits.

Electro static charge is caused in three different ways:

- Rubbing of two surfaces to each other.
- Separation of two surfaces from each other, for example when removing a plastic cover from its contents.
- Induction caused by static electricity without any contact of the material.

Two type of faults and different circuits

The ESD damages are divided into two groups of faults: direct fault and latent defect. The direct faults are quite easy to detect since the component will not work at all and this is very often discovered at the factory before shipping.

The latent defects can be very difficult to identify since the component is not working in a reliable way and the life length of the device may be reduced dramatically.

Fault generated by ESD

Digital circuits:

- "Ones" becomes "zeros" and "zeros" becomes "ones" for no reason.
- No "ones" or "zeros" at all (the circuit is dead).

Analogue circuits:

- Worsening accuracy of measuring
- Wrong voltage levels that require adjustments
- Malfunction

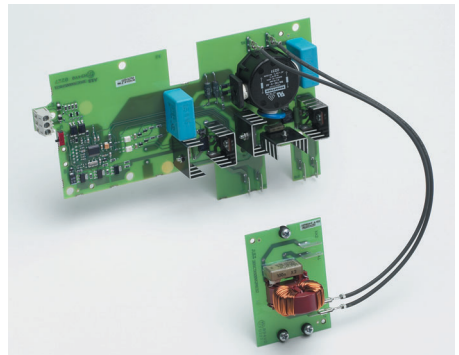

Printed Circuit Board (PCB)

Electro static voltage levels

A voltage level of between 100-500 V can destroy any electronic components in principle. The most sensitive components can only withstand voltages between 25-170 V.

Sometimes it is possible to hear a "click" sound when touching an object and that is typical ESD phenomena. When it is possible to hear that "click" sound the voltage level is already at least 3,5 kV. Sometimes it is also possible to see a spark when touching an object and the voltage level is then at least 10 kV.

Below some values are given for typical Electro static charge:

Walking on a wall-to-wall carpet:	10 - 20 kV
Walking on a plastic floor (PVC):	2 - 5 kV
Walking on an anti-static floor:	0 - 2 kV
Lifting paper from a table:	5 - 35 kV
Rising from a chair:	10 -25 kV

Protection against ESD damages

It is possible to reduce the risk of ESD to a minimum for the equipment. This is very important to remember when making service and/or repair with electronic components for example the printed circuit board on a softstarter.

Actions to prevent damages:

- Avoid charge if possible
- Always use a wrist strap or similar connected to ground potential when working with electrical components
- Always use the right type of package (ESD protected bags, etc.)
- Connect all machines and apparatus to ground potential
- High humidity

Frequently asked questions (FAQ)

Main contactor

Q Is there any requirement to put a main contactor in series before the softstarter?

A The softstarter does not require any main contactor but we recommend the use of one for emergency stop and/or trip of the overload relay. In some applications an MCCB can be used instead of the main contactor.

Ambient temperature

Q Can I use a softstarter if the ambient temperature is higher than the recommended value during operation?

A The softstarter can normally be operated at a higher ambient temperature during operation if the rated current for the unit is derated according to the manufacturer's recommendation.

Thyristor shorted

Q Is it possible to run a softstarter with one thyristor shorted?

A Yes, it is possible but not for all types of softstarters.

Soft stop applications

Q What applications are suitable for soft stop?

A Pumps and conveyor belts loaded with fragile products are the two main applications suitable for soft stop.

Advantages of by-pass

Q What are the advantages of using by-pass?

A Reduction of power loss. It is also possible to reduce the enclosure size and use a higher IP-class since air ventilation is not required.

Power loss

Q What is the power loss of a softstarter during a continuous run?

A The values can normally be found in the catalogue. For ABB softstarters the following formula can be used (for example for PS S 18...300):

$$P_{L\text{Tot}} = [3 \times I_e \times 1.0] + 50 \text{ (W)}$$
 reduced to 50 W only which is the power of the cooling fans when using by-pass.

I_e is the operational current of the motor.

Utilisation category

Q What utilisation category should be used for the main contactor and the by-pass contactor?

A Main contactor: always use AC-3.
By-pass contactor: it is possible to use AC-1.

Fault indication when starting

Q Why does the softstarter indicate a fault when the start signal is given to the main contactor and softstarter at the same time?

A If the main contactor is closed too late the softstarter will indicate this as a phase loss fault. Delay the start signal to the soft starter by approx. 0.5 sec. to solve this phenomenon.

Test without motor

Q Can I test a softstarter without using a motor?

A No, this is not possible since there will be no current going through the softstarter and some types will also indicate loss of load.

Overload relay trips during start

Q Why does the overload relay trip during start?

A Possible reasons can be one of these or in a combination:

- too low current limit
- too long ramp time
- too low initial voltage
- wrong tripping class on the overload
- wrong setting on the overload

Separate overload relay when using by-pass

Q Do I need a separate overload relay when using a softstarter with built-in electronic overload and by-pass?

A If the current transformers of the softstarter can be installed so that the measuring can be performed when by-passed a separate relay is not required; otherwise yes.

Different frequency

Q Can I use the same softstarter at both 50 and 60 Hz?

A It is possible with all type of ABB softstarters as long as the curve is sinusoidal.

Voltage fluctuations

Q What voltage fluctuations are allowed for the softstarters?

A The minimum and maximum value where we can guarantee full function is -15 % to +10 % of the rated value. This is also stated in the IEC-standard.

Example: 400 V - 15 % to +10 % \geq 340 V - 440 V range.

Semi-conductor fuses

Q Do I always have to use semi-conductor fuses?

A When using semi-conductor fuses a type 2 co-ordination can be achieved. It is possible to use an MCCB (moulded case circuit breaker) or MMS (manual motorstarter) instead but then with a type 1 co-ordination. For a more in-depth description see the chapter on co-ordination.

Environmental information

How a product affects the environment is a matter that is becoming more and more important when designing new products today but also when updating existing product ranges. In order to get a complete picture of all environmental aspects, there are some different methods of doing this.

LCA

LCA (Life Cycle Assessment) is a management tool for appraising and quantifying the entire life cycle of particular materials, the impact of products or activities over their total lifetime by analysing the entire life cycle of particular materials, processes, products, technologies, services or activities. The most important aspects affecting the environment for a softstarter has proven to be:

- Choice of material in the softstarter
- Energy losses during lifetime
- Recycling possibilities

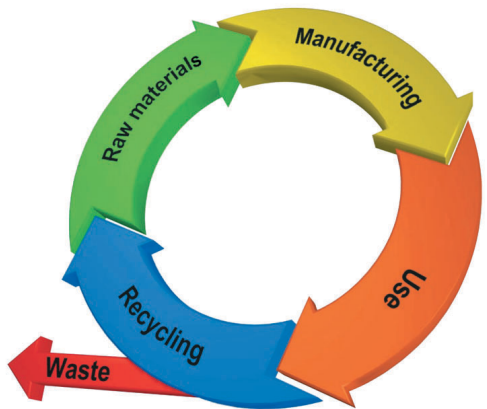

The LCA process includes the entire lifecycle of a product



EPD

EPD (Environmental Product Declaration) is a document describing the environmental effects both during manufacturing and the usage of a specific product, for example the softstarter range PS S 18/30...300/515. The document includes among other things a material list indicating kg/product used of aluminium, copper, steel, glass, etc. and also tables for energy consumption

and losses. It is possible to see the difference when using the softstarter In-line, Inside Delta and/or with a by-pass contactor.

Tables for global warming potential, ozone depletion potential, acidification potential and so on are also included. The complete declaration is available on www.abb.com under document number 1SFC 288007-en.

Type of material	kg/product	kg/kW
Aluminium	2.2	0.03
Cardboard	2.4	0.03
Copper and copper alloys	3.1	0.04
Steel	4	0.05
Wood	0.83	0.01
Polymers	1.7	0.02
Epoxy resin	0.033	0.000
Glass	0.025	0.0003
Silicone rubber	0.0047	0.9*10 ⁻⁴

Example of a material list for a softstarter.

ABB has committed, as a key element of its business strategy, to a broad program of product development and positioning under the Industrial IT umbrella (IIT). The main reason behind the Industrial IT certification is to make it easier and more effective to combine products into systems and solutions.

All products that pass the Industrial IT certification tests achieve the Industrial IT enabled sign.

Enabled products are verified for properties that make them work together in a pre-defined manner with other enabled products in an Industrial IT environment throughout the full life cycle of the plant. This means that IIT certified products should be easier to:

- Purchase
- Design
- Engineer
- Install
- Commission
- Operate
- Maintain
- De-install

Different levels

In order to acknowledge the fact that there are different requirements on integration properties between different applications and markets, there are four levels that a certain product can be certified for:

Level 0 - Information

- Product is supplied with minimal aspect set in prescribed formats including Product Information, Product Classification, Product Documentation, CAD Data and Technical Data.

Level 1 - Connectivity

- As Information, plus.
- Hardware can be physically connected via defined interfaces.
- Software is installed and handled in a consistent way.
- Basic interoperability of the product in the environment it is inserted in.
- Basic data can be exchanged via defined protocols.

Level 2 - Integration

- As Connectivity, plus.
- Aspect Object Types are provided with at least the Basic set of Aspects.
- Extended data can be exchanged via defined protocols.
- Relevant functionality is available as Aspect Systems on integration level 2.

Level 3 - Optimisation

- As Integration, plus.
- Aspect Object Types are provided with at least the Extended set of Aspects.
- Relevant functionality is available as Aspect Systems on integration level 3.
- The product is handled consistently throughout the life cycle and value chain.

Softstarter level

All our softstarter ranges today are Industrial IT enabled with the suite name Control IT Softstarters, certification level 0 - Information.

An Industrial IT enabled product can be recognized by the Industrial IT enabled sign on the packing.

More information and documentation is available on www.abb.com

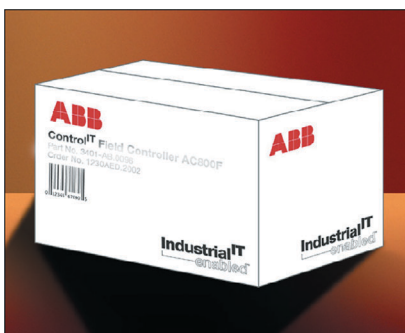

Formula and conversion factors

In this chapter some useful formula and conversion factors can be found. The formulas can be used for calculating for example rated motor torque, moment of inertia, flywheel mass, etc. The conversion factors can be used to convert for example kW to HP, Celsius to Fahrenheit, km/h to miles/hour, etc.

Formula

Ohm's law

$$I = \frac{U}{R} \quad R = \frac{U}{I} \quad U = I \times R$$

I = Current (ampere)

U = Voltage (volt)

R = Resistance (ohm)

Rated motor torque

$$M_r = \frac{9550 \times P_r}{n_r}$$

M_r = Rated torque, Nm

P_r = Rated motor power, kW

n_r = Rated motor speed, rpm

Moment of inertia

$$J = \frac{m(R^2 + r^2)}{2}$$

J = Moment of inertia, kgm^2

m = Mass for the flywheel, kg

R = Outer radius, m

r = Inner radius, m

Flywheel mass

$$mD^2 \text{ or } GD^2 \quad (mD^2 \sim GD^2)$$

mD^2 = Flywheel mass, kpm^2

GD^2 = Flywheel mass, kgm^2

Relation Moment of inertia and Flywheel mass

$$J = \frac{1}{4} GD^2 = \frac{1}{4} mD^2$$

J = Moment of inertia, kgm^2

mD^2 = Flywheel mass, kpm^2

GD^2 = Flywheel mass, kgm^2

**Moment of inertia on load shaft
recalculated to the motor shaft**

$$J'_b = \frac{J_b \times n_b^2}{n_r}$$

J'_b = Moment of inertia recalculated to the motor shaft, kgm^2

J_b = Moment of inertia for the load, kgm^2

n_b = Speed of the load, rpm

n_r = Speed of the motor, rpm

**Load torque on load shaft
recalculated to the motor shaft**

$$M'_b = \frac{M_b \times n_b}{n_r}$$

M'_b = Load torque recalculated to the motor shaft, Nm

M_b = Load torque, Nm

n_b = Speed of the load, rpm

n_r = Speed of the motor, rpm

Electrical power

$$P = \frac{U \times I \times \text{PF}}{1000}$$

P = Power in kW (1-phase)

PF = Power factor

$$P = \frac{U \times I \times \text{PF} \times \sqrt{2}}{1000}$$

P = Power in kW (2-phase)

$$P = \frac{U \times I \times \text{PF} \times \sqrt{3}}{1000}$$

P = Power in kW (3-phase)

Quantities and units

Length

yd.	=	yard
m	=	metre
mm	=	millimetre
cm	=	centimetre
in.	=	inch
ft.	=	feet
km	=	kilometre

Time

h	=	hour
min	=	minute
s	=	second

Weight

oz.	=	ounce
lb.	=	pound
kg	=	kilogram
g	=	gram

Power / Energy

HP	=	horsepower
W	=	watt
kW	=	kilowatt
kWh	=	kilowatt-hours

Volume

l	=	litre
ml	=	millilitre
cu.in.	=	cubic inch
cu.ft.	=	cubic feet
gal.	=	gallon
fl.oz.	=	fluid ounce

Electrical

A	=	Ampere
V	=	Volt
W	=	Watt
Ω	=	Ohm
F	=	Farad

Conversion factors

Length

1 mile	=	1,609344 km	1 km	=	0,621 mile
1 yd	=	0,9144 m	1 m	=	1,09 yd
1 ft	=	0,3048 m	1 m	=	3,28 ft
1 in	=	25,4 mm	1 mm	=	0,039 in

Velocity

1 knot	=	1,852 km/h	1 km/h	=	0,540 knot
1 mile/h	=	1,61 km/h	1 km/h	=	0,622 mile/h
1 m/s	=	3,6 km/h	1 km/h	=	0,278 m/s

Area

1 acre	=	0,405 ha	1 ha	=	2,471 acre
1 ft²	=	0,0929 m ²	1 m²	=	10,8 ft ²
1 in²	=	6,45 cm ²	1 cm²	=	0,155 in ²

Volume

1 ft³	=	0,0283 m ³	1 m³	=	35,3 ft ³
1 in³	=	16,4 cm ³	1 cm³	=	0,0610 in ³
1 gallon	=	4,55 l (UK)	1 l	=	0,220 gallon (UK)
1 gallon	=	3,79 l (US)	1 l	=	0,264 gallon (US)
1 pint	=	0,568 l	1 l	=	1,76 pint

Mass

1 lb	=	0,454 kg	1 kg	=	2,20 lb
1 oz	=	28,3 g	1 g	=	0,0352 oz

Moment of Inertia

1 Nm²	=	2,42 ft.-lb ²	1 ft.-lb²	=	0,41322 Nm ²
1 kgm²	=	0,2469 ft.-lb ²	1 ft.-lb²	=	4,0537 kgm ²
1 oz.-in²	=	0,000434 ft.-lb ²	1 ft.-lb²	=	2304,147 oz.-in ²

Force

1 kp	=	9,80665 N	1 N	=	0,102 kp
1 lbf	=	4,45 N	1 N	=	0,225 lbf

Energy

1 kpm	=	9,80665 J	1 J	=	0,102 kpm
1 cal	=	4,1868 J	1 J	=	0,239 cal
1 kWh	=	3,6 MJ	1 MJ	=	0,278 kWh

Power

1 hp	=	0,736 kW	1 kW	=	1,36 hp
1 hp	=	0,746 kW (UK,US)	1 kW	=	1,34 hp (UK;US)
1 kcal/h	=	1,16 W	1 W	=	0,860 kcal/h

Temperature

0 °C	=	32 °F
°C	=	5 / 9 (°F-32)
0 °F	=	-17,8 °C
°F	=	9 / 5 (°C+32)

Glossary

AC	Alternating current.
Ambient Temperature	Ambient temperature is the temperature of water, air or surrounding medium where the equipment is used or stored.
Asynchronous speed	The speed of an AC induction motor at full load and full voltage, also defined as the rated speed.
Bearing	A component used to reduce the friction and wear between rotating devices.
By-pass	A by-pass contactor is used to by-pass another device, for example a softstarter to reduce the power loss.
CSA	Canadian Standard Association
Current limit	An electronic method to limit the starting current to the motor during start up. It is normally possible to adjust the function so that the motor torque will be high enough to take off.
Cycle	A sequence of operations that is repeated regularly or the time it takes to complete one operation.
D-end	The end that is normally the drive end of an electrical motor.
DC	Direct current
Degree of Protection	Defined and stated as IP (International Protection) class indicating the degree of protection against contact and penetration of solid objects and water.
Derating	When a device has to be operated with reduced ratings (normally the current) due to high ambient temperature or high altitude.
D.O.L	Direct-on-line

Duty Cycle	The total cycle from one start to the next, including ramp time for start and stop, operation and pause time, if any.
Efficiency	The ratio between mechanical output and electrical input. The percentage given indicates how effective the motor is at converting electrical energy to mechanical energy.
EMF	Electromotive Force, another term for voltage or potential difference, for example the voltage generated by a motor.
EPD	Environmental Product Declaration, a description of how a specific product affects the environment.
ESD	Electro Static Discharge.
Fault	Any malfunction that occur and interferes with normal operation.
Flywheel mass	The total mass (mD^2 or GD^2) of a rotating body normally given in kpm^2 or kgm^2 . The value of the flywheel mass is 4 times the moment of inertia.
Frequency	The number of periodic cycles per unit of time.
Gate	The control element of an SCR (thyristor). When giving a small positive voltage to the SCR it will start conducting.
Heat Sink	A component often made of aluminium used to get rid of the heat inside an electrical device generated by the current.
Heavy Duty Start	A start with a load that has a high or very high moment of inertia. A starting time D.O.L. of more then 5 seconds can be defined as a heavy-duty start.

High load torque	The braking torque on the motor shaft caused by the load. If the braking torque is equal or nearly equal to the rated motor torque it can be defined as high load torque.
IEC	International Electrotechnical Commission which is part of the International Standard Organisation.
Inertia	A measure of a body's resistance to change in velocity whether the body is moving at a constant speed or is at rest. The velocity can be rotational or linear.
Induction motor	An AC motor with a primary winding (usually the stator) connected to the power supply and a secondary winding (usually the rotor) carrying the induced current.
In-Line connection	A connection type where the devices in the main supply are connected in series with each other.
Inside Delta connection	A connection type where the devices are connected inside the motor delta circuit. The current is reduced to $1/\sqrt{3} = 58\%$ compared to the line current.
Integrated Circuit (IC)	A small electronic unit that can consist of thousands of transistors usually mounted on a PCB.
Intermittens factor	The relation between how long a machinery is working (ON time) and how long it is resting (OFF time) in a cycle.
Jog	Momentary moving of the motor by repetitive closure of a circuit using a contact element or a pushbutton.
LCA	Life Cycle Assessment, an analysis of how a product affects the environment from "cradle to grave".

LCD	Liquid Crystal Display, a readout interface used in digital watches and laptop computers.
LED	Light-emitting diode.
Locked Rotor Current	The current taken from the line when a rotor is at a standstill at rated voltage and frequency. It is the on line current when starting the motor direct.
Megger Test	This is normally measured in megohms using full voltage with low current and is used to measure the resistance in an insulation system. It can be used for checking the thyristors, for example.
Micro processor	A central processing unit utilising large-scale integration technology.
MCCB	Moulded Case Circuit Breaker
MMS	Manual Motor Starter
N-end	The end that is normally the non-drive end of an electrical motor.
NEMA	The National Electrical Manufacturers Association (USA)
Network	A number of nodes connected to each other with some type of communication medium. A network can be of single link type or multiple link type.
Noise	Unwanted disturbances in a communication medium that tend to obscure the data content.
Normally Closed Contact (NC)	A contact or set of contacts that are closed when the relay or switch is de-energised. The contact(s) open when a relay or switch is energised.

Normally Open Contact (NO)	A contact or set of contacts that are open when the relay or switch is de-energised. The contact(s) close when the relay or switch is energised.
Normal Start	A start with a load that has small or medium high moment of inertia. A starting time D.O.L. of less than 5 seconds can be defined as normal start.
Overload relay	A device used to avoid overheating of the motor. Can be of electronic or thermal type.
Parallel start	Parallel start of motors is normally when two or more motors are started at the same time with the same starting equipment.
PCB	Printed Circuit Board.
PLC	Programmable Logic Controller, consists of a central processor, input/output interfaces and a memory designed as an industrial control system. A PLC system is used for the storage of instructions, timing, counting, report generation I/O control and more.
Power	Work done per unit of time measured in horsepower (HP) or watt (W).
Power Factor	The phase difference measured between the voltage and the current in an AC circuit represented by the cosine angle.
Protocol	A set of conventions governing the format and timing of data between communication devices.
Reversing	Changing of the rotation direction of the rotor or motor armature.
SCR	Silicon Controlled Rectifier often referred to as a thyristor.

Semi-conductor fuses	A special type of high-speed fuse used as thyristor protection since normal (gG/gL or aM) fuses are not fast enough.
Sequential start	Sequential start of motors is normally when two or more motors are started one by one in a sequence with the same starting equipment.
Serial Communication	The way of transmitting data in a network between different nodes, using some type of protocol.
Slip	The difference (usually expressed in percentage) between the synchronous speed and the rotor speed of an AC induction motor.
Star connection	The connection type where each winding in a polyphase circuit is connected at one end to a common point.
Synchronous speed	The speed of the rotating magnetic field on an AC induction motor determined by the frequency and the number of magnetic poles in each phase of the stator windings.
Thyristor	A solid-state switch that has an anode, cathode and a control element called the gate, which makes it possible to turn it on at will. It can rapidly switch large currents at high voltages.
Tripping class	The tripping class defines the starting time at a specific current before tripping occurs. Different classes exist, for example 10, 20, 30 etc. where class 30 allows the longest starting time.
Torque	A measure of the turning force ability for a device.
UL	Underwrites Laboratories (an approval agency).
Y connection	See Star connection.

Index

A

- Accelerating torque 15
- Adjustable rated motor current 38
- Ambient temperature 41

B

- Braking load torque 15

C

- CE Marking 1
- Centrifugal fan. *See* Fan
- Centrifugal pump. *See* Pump
- Co-ordination 58, 59
 - table of 62, 63
- Common problems, table of 14
- Compressor 23
 - Suitable softstarter 26
- Control voltage 40
- Conveyor belt 27
 - Suitable softstarter 30
- CSA specifications 1
- Current limit 37

D

- D-end 2
- Delta connection 4
- Direct-on-line start 9, 16, 19, 23, 27

E

- Electro Static Discharge(ESD) 65, 66
- Electronic overload relay (EOL) 33
- Environmental Product Declaration (EPD) 70
- Explosive atmospheres (Ex) 56
 - Zone categories 57

F

- Fan 35
 - Suitable softstarter 18
- FAQ - Softstarters 67
- Fault 39
- Firing angle 35
- Formula and conversion factors 73
- Frequency drive 12
- Fuses 61, 64

G

- Glossary 78

H

- Harmonics 55
- Heat sink 35
- High altitudes, derating 42
- Housing 35

I

- In-line connection 46
- Indications 39
- Industrial IT 71, 72
 - Levels of certification 72
- Initial voltage 36
- Inside delta connection 46

L

- Life Cycle Assessment (LCA) 69

M

Main voltage 40

Motors

about 2

calculations, speed 6

calculations, torque 7

mechanical overview 2

Parallel start 43

problems, start & stop 14

Sequential start 44

Slip-ring 7

Squirrel cage 3

Winding 4

O

Overload 39

Overload relay. See Electronic
overload relay (EOL)

P

Power factor 5

Printed Circuit Board (PCB) 35

Pump 19

stopping a pump 20

Suitable softstarter 22

Q

Quick guide, softstarter applications
31

S

Settings 36

Adjustable rated motor current 38

Current limit 37

Initial voltage 36

Start ramp 36

Step down voltage 38

table, with current lim. 51

table, without current lim. 50

settings

Stop ramp 36

Softstarter 13, 17, 21, 25, 29

Component picture 34

How to select - Quickguide 31

Indications 39

Starting capacity 52

starts/hour 54

using by-pass contactor 53

using overload protection 53

Standards 1

Star-delta start 10

Star-delta starter 17, 20, 24, 28

Start connection 4

Start ramp 36

Starting capacity 52, 53

Step down voltage 38

Stop ramp 36

Supply voltage 40

T

Temperature, derating 41

Thyristor 35

U

UL specifications 1

Utilization Categories 60

V

Voltage 4

Voltage definitions 40



ABB Automation Technologies AB/Cewe-Control, SE-721 61 Västerås, Sweden, Telephone +46 21 32 07 00, Telefax +46 21 12 60 01
Id.No **1SFC132002M0201**, ed. 2, September 2004, ATAP/GL/XM, reprinted in Sept.2004/Edita Västra Aros