

# Soil Compaction Handbook





# Soil Compaction

Soil compaction is defined as the method of mechanically increasing the density of soil. In construction, this is a significant part of the building process.

If performed improperly, settlement of the soil could occur and result in unnecessary maintenance costs or structure failure.

Almost all types of building sites and construction projects utilize mechanical compaction techniques.

## SOIL DENSITY

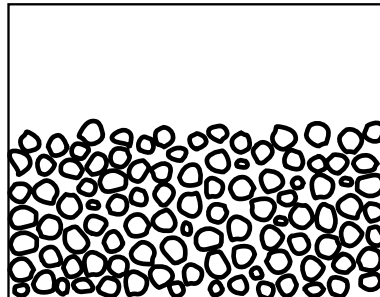

Loose Soil (poor load support)

Figure 1

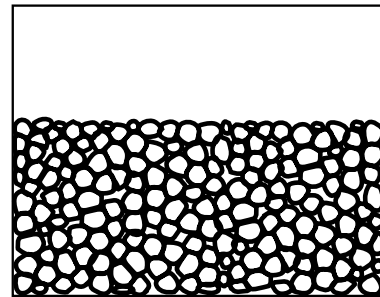

Compacted Soil (improved load support)

## What is soil?

Soil is formed in place or deposited by various forces of nature—such as glaciers, wind, lakes and rivers—residually or organically. Following are important elements in soil compaction:

- Soil type
- Soil moisture content
- Compaction effort required

## Why compact?

There are five principle reasons to compact soil:

- Increases load-bearing capacity
- Prevents soil settlement and frost damage
- Provides stability
- Reduces water seepage, swelling and contraction
- Reduces settling of soil

## Types of compaction

There are four types of compaction effort on soil or asphalt:

- Vibration
- Impact
- Kneading
- Pressure

These different types of effort are found in the two principle types of compaction force: static and vibratory.

*Static force* is simply the deadweight of the machine, applying downward force on the soil surface, compressing the soil particles. The only way to change the effective compaction force is by adding or subtracting the weight of the machine. Static compaction is confined to upper soil layers and is limited to any appreciable depth. Kneading and pressure are two examples of static compaction.

*Vibratory force* uses a mechanism, usually engine-driven, to create a downward force in addition to the machine's static weight. The vibrating mechanism is usually a rotating eccentric weight or piston/spring combination (in rammers). The compactors deliver a rapid sequence of blows (impacts) to the surface, thereby affecting the top layers as well as deeper layers. Vibration moves through the material, setting particles in motion and moving them closer together for the highest density possible. Based on the materials being compacted, a certain amount of force must be used to overcome the cohesive nature of particular particles.

## RESULTS OF POOR COMPACTION

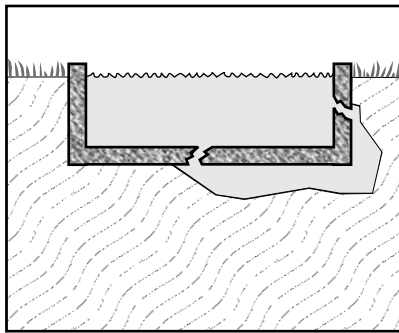

Basement & Pool  
Cracks & Leaks

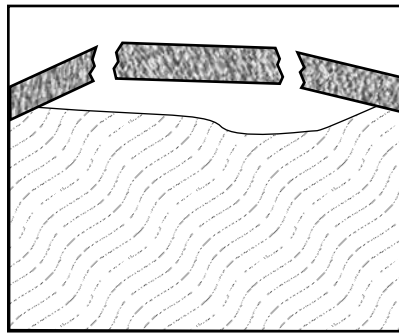

Slab Cracks

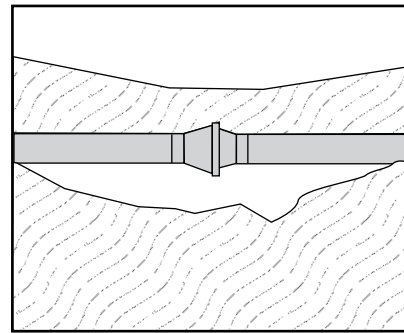

Pipe Leakage  
& Breaks

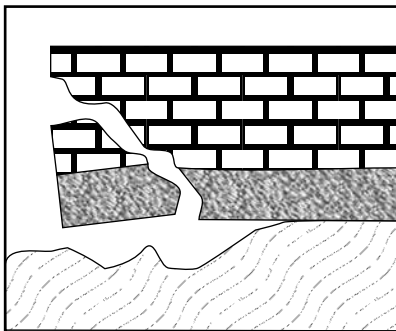

Foundation Erosion

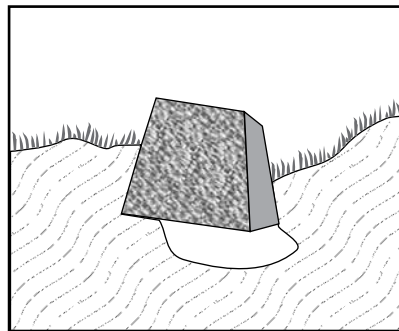

Erosion Gullies  
Under Abutments

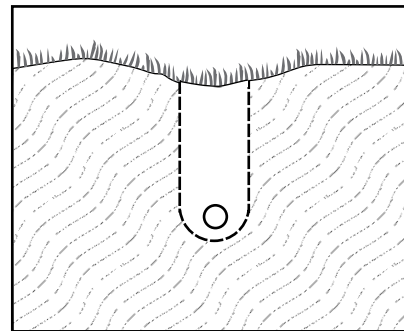

Utility Trench  
Settling

**Figure 2**

These illustrations show the results of improper compaction and how proper compaction can ensure a longer structural life, eliminating future foundation problems.

## Soil Types and Conditions

Every soil type behaves differently with respect to maximum density and optimum moisture. Therefore, each soil type has its own unique requirements and controls both in the field and for testing purposes. Soil types are commonly classified by grain size, determined by passing the soil through a series of sieves to screen or separate the different grain sizes.

[See Figure 3]

Soil classification is categorized into 15 groups, a system set up by AASHTO (American Association of State Highway and Transportation Officials). Soils found in nature are almost always a combination of soil types. A *well-graded* soil consists of a wide range of particle sizes with the smaller particles filling voids between larger particles. The result is a dense structure that lends itself well to compaction.

A soil's makeup determines the best compaction method to use.

There are three basic soil groups:

- Cohesive
- Granular
- Organic (this soil is not suitable for compaction and will not be discussed here)

## SIEVE TEST

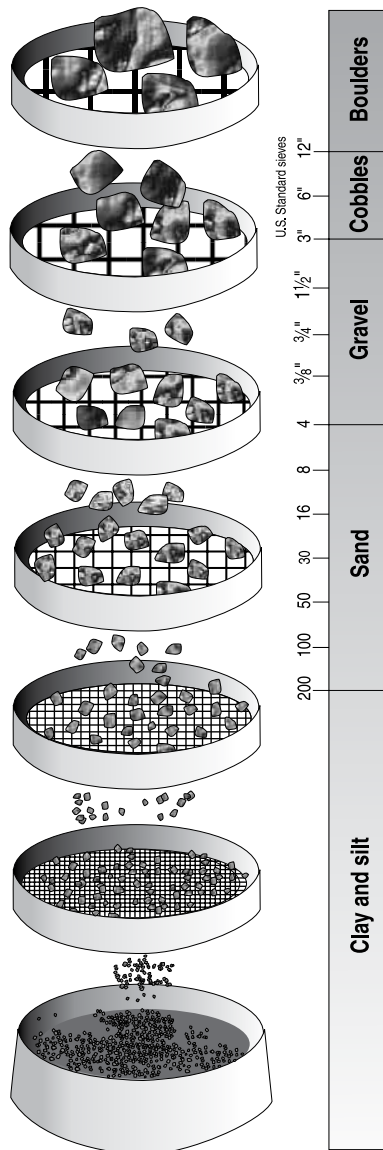

Figure 3

## Cohesive soils

Cohesive soils have the smallest particles. Clay has a particle size range of .00004" to .002". Silt ranges from .0002" to .003". Clay is used in embankment fills and retaining pond beds.

### Characteristics

Cohesive soils are dense and tightly bound together by molecular attraction. They are plastic when wet and can be molded, but become very hard when dry. Proper water content, evenly distributed, is critical for proper compaction. Cohesive soils usually require a force such as impact or pressure. Silt has a noticeably lower cohesion than clay. However, silt is still heavily reliant on water content. [See Figure 4]

## Granular soils

Granular soils range in particle size from .003" to .08" (sand) and .08" to 1.0" (fine to medium gravel). Granular soils are known for their water-draining properties.

### Characteristics

Sand and gravel obtain maximum density in either a fully dry or saturated state. Testing curves are relatively flat so density can be obtained regardless of water content.

The tables on the following pages give a basic indication of soils used in particular construction applications. [See Figures 5, 6 & 7]

## GUIDE TO SOIL TYPES

Figure 4

What to look for	Appearance/feel	Water movement	When moist...	When dry...
<b>Granular soils</b> , fine sands and silts.	Coarse grains can be seen. Feels gritty when rubbed between fingers.	When water and soil are shaken in palm of hand, they mix. When shaking is stopped, they separate.	Very little or no plasticity.	Little or no cohesive strength when dry. Soil sample will crumble easily.
<b>Cohesive soils</b> , mixes and clays.	Grains cannot be seen by naked eye. Feels smooth and greasy when rubbed between fingers.	When water and soil are shaken in palm of hand, they will not mix.	Plastic and sticky. Can be rolled.	Has high strength when dry. Crumbles with difficulty. Slow saturation in water.

## RELATIVE DESIRABILITY OF SOILS AS COMPACTED FILL

Group Symbol		Soil Type	Relative Desirability for Various Uses (1=best; 14=least desirable)									
			Rolled Earth Fill Dams			Canal Sections		Foundations		Roadways		
			Homogeneous Embankment	Core	Shell	Erosion Resistance	Compacted Earth Lining	Seepage Important	Seepage Not Important	Fills		Surfacing
										Frost Heave Not Possible	Frost Heave Possible	
GRAVELS	GW	Well-graded gravels, gravel/sand mixtures, little or no fines	--	--	1	1	--	--	1	1	1	3
	GP	Poorly-graded gravels, gravel/sand mixtures, little or no fines	--	--	2	2	--	--	3	3	3	--
	GM	Silty gravels, poorly-graded gravel/sand/silt mixtures	2	4	--	4	4	1	4	4	9	5
	GC	Clay-like gravels, poorly graded gravel/sand/clay mixtures	1	1	--	3	1	2	6	5	5	1
SANDS	SW	Well-graded sands, gravelly sands, little or no fines	--	--	3*	6	--	--	2	2	2	4
	SP	Poorly-graded sands, gravelly sands, little or no fines	--	--	4*	7*	--	--	5	6	4	--
	SM	Silty sands, poorly-graded sand/silt mixtures	4	5	--	8*	5**	3	7	6	10	6
	SC	Clay-like sands, poorly-graded sand/clay mixtures	3	2	--	5	2	4	8	7	6	2
LEAN CLAYS & SILTS	ML	Inorganic silts and very fine sands, rock flour, silty or clay-like fine sands with slight plasticity	6	6	--	--	6**	6	9	10	11	--
	CL	Inorganic clays of low to medium plasticity, gravelly clays, sandy clays, silty clays, lean clays	5	3	--	9	3	5	10	9	7	7
	OL	Organic silts and organic silt-clays of low plasticity	8	8	--	--	7**	7	11	11	12	--
FAT	MN	Organic silts, micaceous or diatomaceous fine sandy or silty soils, elastic silts	9	9	--	--	--	8	12	12	13	--
	CH	Inorganic clays of high plasticity, fat clays	7	7	--	10	8***	9	13	13	8	--
	OH	Organic clays of medium high plasticity	10	10	--	--	--	10	14	14	14	--

Figure 5

MATERIALS		Vibrating Sheepsfoot Rammer	Static Sheepsfoot Grid Roller Scraper	Vibrating Plate Compactor Vibrating Roller Vibrating Sheepsfoot	Scraper Rubber-tired Roller Loader Grid Roller
	Lift Thickness	IMPACT	PRESSURE with kneading	VIBRATION	KNEADING with pressure
GRAVEL	12+	Poor	No	Good	Very Good
SAND	10+/-	Poor	No	Excellent	Good
SILT	6+/-	Good	Good	Poor	Excellent
CLAY	6+/-	Excellent	Very Good	No	Good

Figure 6

### Effect of moisture

The response of soil to moisture is very important, as the soil must carry the load year-round. Rain, for example, may transform soil into a plastic state or even into a liquid. In this state, soil has very little or no load-bearing ability.

### Moisture vs soil density

Moisture content of the soil is vital to proper compaction. Moisture acts as a lubricant within soil, sliding the particles together. Too little moisture means inadequate compaction—

the particles cannot move past each other to achieve density. Too much moisture leaves water-filled voids and subsequently weakens the load-bearing ability. The highest density for most soils is at a certain water content for a given compaction effort. The drier the soil, the more resistant it is to compaction. In a water-saturated state the voids between particles are partially filled with water, creating an apparent cohesion that binds them together. This cohesion increases as the particle size decreases (as in clay-type soils). [See Figure 8]

FILL MATERIALS					
	Permeability	Foundation Support	Pavement Subgrade	Expansive	Compaction Difficulty
GRAVEL	Very High	Excellent	Excellent	No	Very Easy
SAND	Medium	Good	Good	No	Easy
SILT	Medium Low	Poor	Poor	Some	Some
CLAY	None+	Moderate	Poor	Difficult	Very Difficult
ORGANIC	Low	Very Poor	Not Acceptable	Some	Very Difficult

Figure 7

## Soil density tests

To determine if proper soil compaction is achieved for any specific construction application, several methods were developed. The most prominent by far is soil density.

### Why test

Soil testing accomplishes the following:

- Measures density of soil for comparing the degree of compaction vs specs
- Measures the effect of moisture on soil density vs specs
- Provides a moisture density curve identifying optimum moisture

## MOISTURE VS SOIL DENSITY

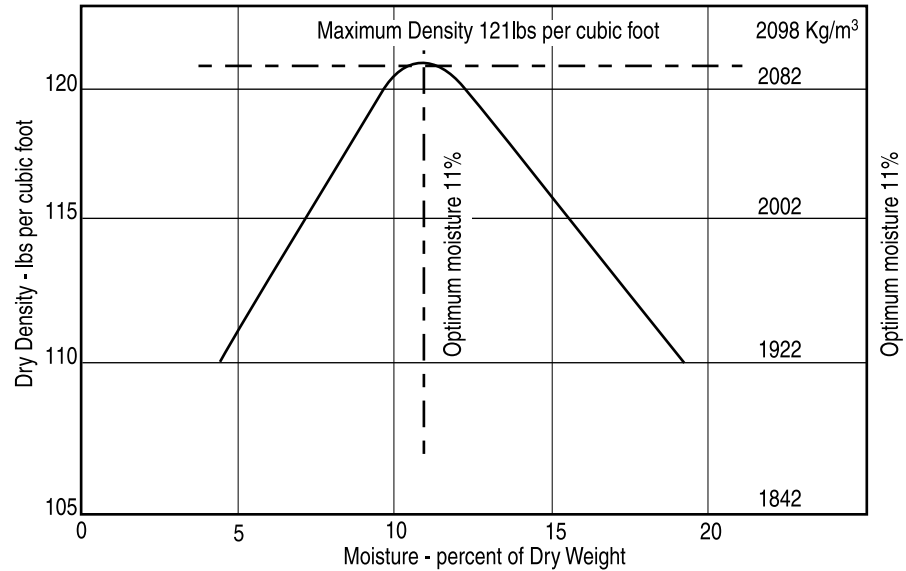
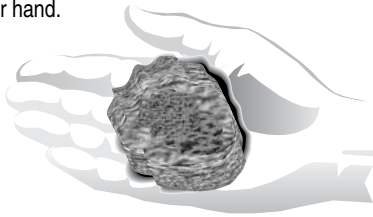

Figure 8

## HAND TEST

A quick method of determining moisture density is known as the "Hand Test."

Pick up a handful of soil. Squeeze it in your hand. Open your hand.



If the soil is powdery and will not retain the shape made by your hand, it is too dry. If it shatters when dropped, it is too dry.

If the soil is moldable and breaks into only a couple of pieces when dropped, it has the right amount of moisture for proper compaction.

If the soil is plastic in your hand, leaves small traces of moisture on your fingers and stays in one piece when dropped, it has too much moisture for compaction.

Figure 9

## Types of tests

Tests to determine optimum moisture content are done in the laboratory. The most common is the Proctor Test, or Modified Proctor Test. A particular soil needs to have an ideal (or optimum) amount of moisture to achieve maximum density. This is important not only for durability, but will save money because less compaction effort is needed to achieve the desired results.

### Proctor Test (ASTM D1557-91)

The Proctor, or Modified Proctor Test, determines the maximum density of a soil needed for a specific job site. The test first determines the maximum density achievable for the materials and uses this figure as a reference. Secondly, it tests the effects of moisture on soil density. The soil reference value is expressed as a percentage of density. These values are determined before any compaction takes place to develop the compaction specifications. Modified Proctor values are higher because they take into account higher densities needed for certain types of construction projects. Test methods are similar for both tests. [See Figure 10]

### Field tests

It is important to know and control the soil density during compaction. Following are common field tests to determine on the spot if compaction densities are being reached.



## PROCTOR TEST

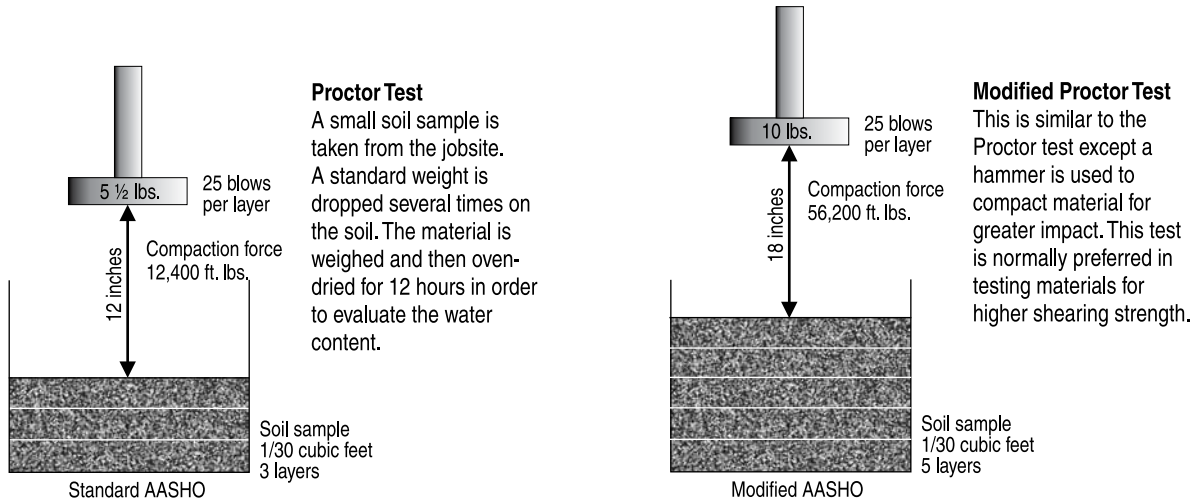

Figure 10

## FIELD DENSITY TESTING METHODS

	Sand Cone	Balloon Densometer	Shelby Tube	Nuclear Gauge
<b>Advantages</b>	<ul style="list-style-type: none"> <li>• Large sample</li> <li>• Accurate</li> </ul>	<ul style="list-style-type: none"> <li>• Large sample</li> <li>• Direct reading obtained</li> <li>• Open graded material</li> </ul>	<ul style="list-style-type: none"> <li>• Fast</li> <li>• Deep sample</li> <li>• Under pipe haunches</li> </ul>	<ul style="list-style-type: none"> <li>• Fast</li> <li>• Easy to redo</li> <li>• More tests (statistical reliability)</li> </ul>
<b>Disadvantages</b>	<ul style="list-style-type: none"> <li>• Many steps</li> <li>• Large area required</li> <li>• Slow</li> <li>• Halt equipment</li> <li>• Tempting to accept flukes</li> </ul>	<ul style="list-style-type: none"> <li>• Slow</li> <li>• Balloon breakage</li> <li>• Awkward</li> </ul>	<ul style="list-style-type: none"> <li>• Small sample</li> <li>• No gravel</li> <li>• Sample not always retained</li> </ul>	<ul style="list-style-type: none"> <li>• No sample</li> <li>• Radiation</li> <li>• Moisture suspect</li> <li>• Encourages amateurs</li> </ul>
<b>Errors</b>	<ul style="list-style-type: none"> <li>• Void under plate</li> <li>• Sand bulking</li> <li>• Sand compacted</li> <li>• Soil pumping</li> </ul>	<ul style="list-style-type: none"> <li>• Surface not level</li> <li>• Soil pumping</li> <li>• Void under plate</li> </ul>	<ul style="list-style-type: none"> <li>• Overdrive</li> <li>• Rocks in path</li> <li>• Plastic soil</li> </ul>	<ul style="list-style-type: none"> <li>• Miscalibrated</li> <li>• Rocks in path</li> <li>• Surface prep required</li> <li>• Backscatter</li> </ul>
<b>Cost</b>	• Low	• Moderate	• Low	• High

Figure 11

## SAND CONE TEST

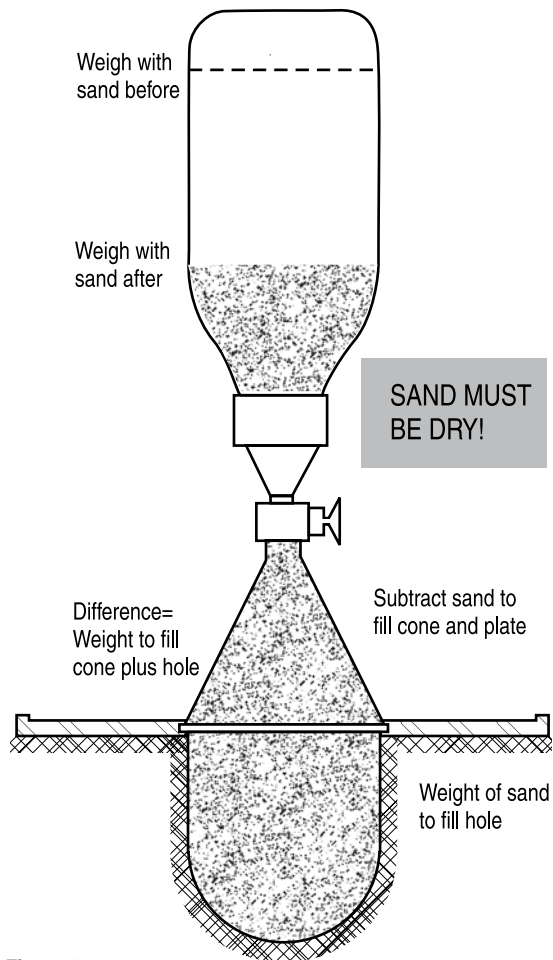

Figure 12

## Sand Cone Test (ASTM D1556-90)

A small hole (6" x 6" deep) is dug in the compacted material to be tested. The soil is removed and weighed, then dried and weighed again to determine its moisture content. A soil's moisture is figured as a percentage. The specific volume of the hole is determined by filling it with calibrated dry sand from a jar and cone device. The dry weight of the soil removed is divided by the volume of sand needed to fill the hole. This gives us the density of the compacted soil in lbs per cubic foot. This density is compared to the maximum Proctor density obtained earlier, which gives us the relative density of the soil that was just compacted. [See Figure 12]

## Nuclear Density (ASTM D2922-91)

Nuclear Density meters are a quick and fairly accurate way of determining density and moisture content. The meter uses a radioactive isotope source (Cesium 137) at the soil surface (backscatter) or from a probe placed into the soil (direct transmission). The isotope source gives off photons (usually Gamma rays) which radiate back to the meter's detectors on the bottom of the unit. Dense soil absorbs more radiation than loose soil and the readings reflect overall density. Water content (ASTM D3017) can also be read, all within a few minutes. A relative Proctor Density is obtained after comparing maximum density with the compaction results from the test. [See Figure 13]

## NUCLEAR TEST

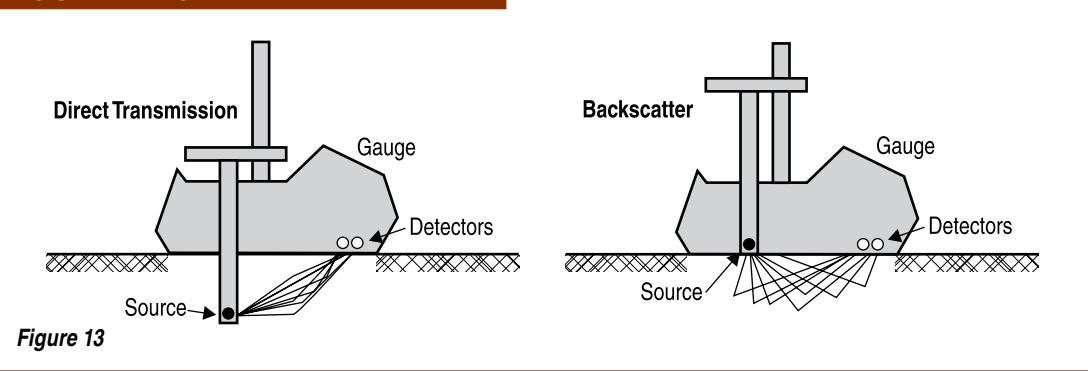

Figure 13

## Soil Modulus (soil stiffness)

This field-test method is a very recent development that replaces soil density testing. Soil stiffness is the ratio of force-to-displacement. Testing is done by a machine that sends vibrations into the soil and then measures the deflection of the soil from the vibrations.

This is a very fast, safe method of testing soil stiffness. Soil stiffness is the desired engineering property, not just dry density and water content. This method is currently being researched and tested by the Federal Highway Administration.

# Compaction Equipment

## Applications

The desired level of compaction is best achieved by matching the soil type with its proper compaction method. Other factors must be considered as well, such as compaction specs and job site conditions.

- Cohesive soils—clay is cohesive; its particles stick together.\* Therefore, a machine with a high impact force is required to ram the soil and force the air out, arranging the particles. A *rammer* is the best choice, or a *pad-foot vibratory roller* if higher production is needed. [See Figure 14]  
\*The particles must be sheared to compact.
- Granular soils—since granular soils are not cohesive and the particles require a shaking or vibratory action to move them, *vibratory plates* (forward travel) are the best choice.

## COHESIVE SOILS



Figure 14

Reversible plates and smooth drum vibratory rollers are appropriate for production work. Granular soil particles respond to different frequencies (vibrations) depending on particle size. The smaller the particle, the higher the frequency necessary to move it. As you compact soils with larger particles, move up to larger equipment to obtain lower frequencies and higher compaction forces. [See Figure 15]

## GRANULAR SOILS

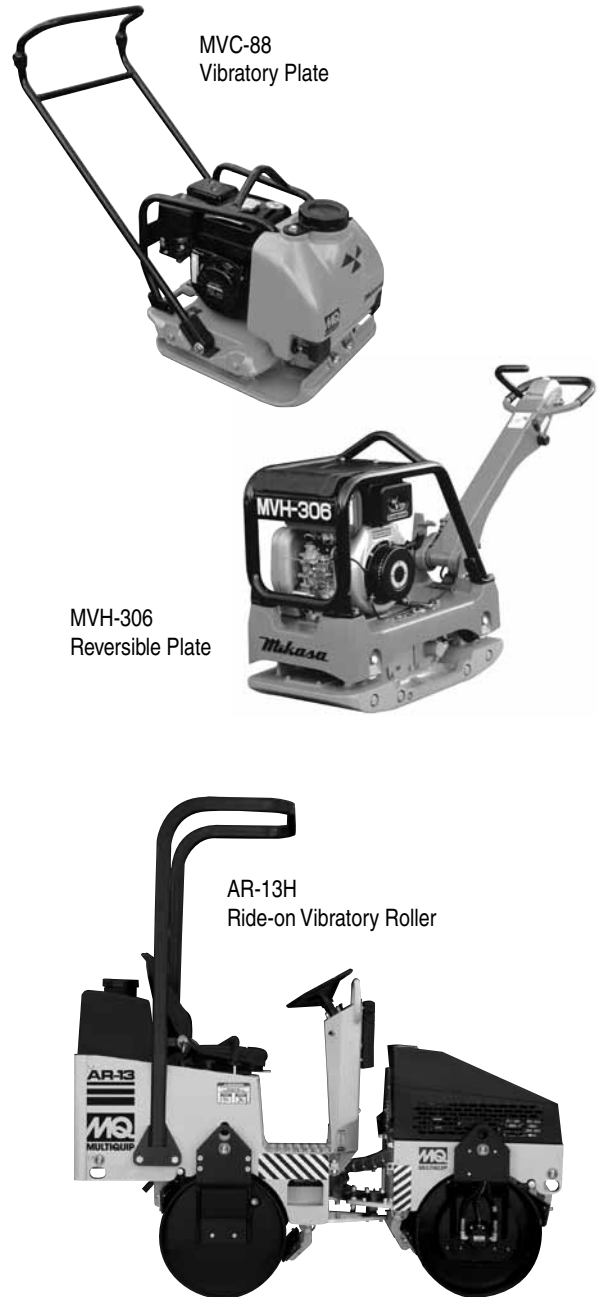

Figure 15

Normally, soils are mixtures of clay and granular materials, making the selection of compaction equipment more difficult. It is a good idea to choose the machine appropriate for the larger percentage of the mixture. Equipment testing may be required to match the best machine to the job.

Asphalt is considered granular due to its base of mixed aggregate sizes (crushed stone, gravel, sand and fines) mixed with bitumen binder (asphalt cement). Consequently, asphalt must be compacted with pressure (static) or vibration.

### Compaction machine characteristics

Two factors are important in determining the type of force a compaction machine produces: *frequency* and *amplitude*.

*Frequency* is the speed at which an eccentric shaft rotates or the machine jumps. Each compaction machine is designed to operate at an optimum frequency to supply the maximum force. Frequency is usually given in terms of vibrations per minute (vpm).

*Amplitude* (or nominal amplitude) is the maximum movement of a vibrating body from its axis in one direction. Double amplitude is the maximum distance a vibrating body moves in both directions from its axis. The apparent amplitude varies for each machine under different job site conditions. The apparent amplitude increases as the material becomes more dense and compacted.

### Lift height and machine performance

Lift height (depth of the soil layer) is an important factor that affects machine performance and compaction cost. Vibratory and rammer-type equipment compact soil in the same direction: from top to bottom and bottom to top. As the machine hits the soil, the impact travels to the hard surface below and then returns upward. This sets all particles in motion and compaction takes place.

As the soil becomes compacted, the impact has a shorter distance to travel. More force returns to the machine, making it lift off the ground higher in its stroke cycle. If the lift is too deep, the machine will take longer to compact the soil and a layer within the lift will not be compacted.

[See Figure 16]

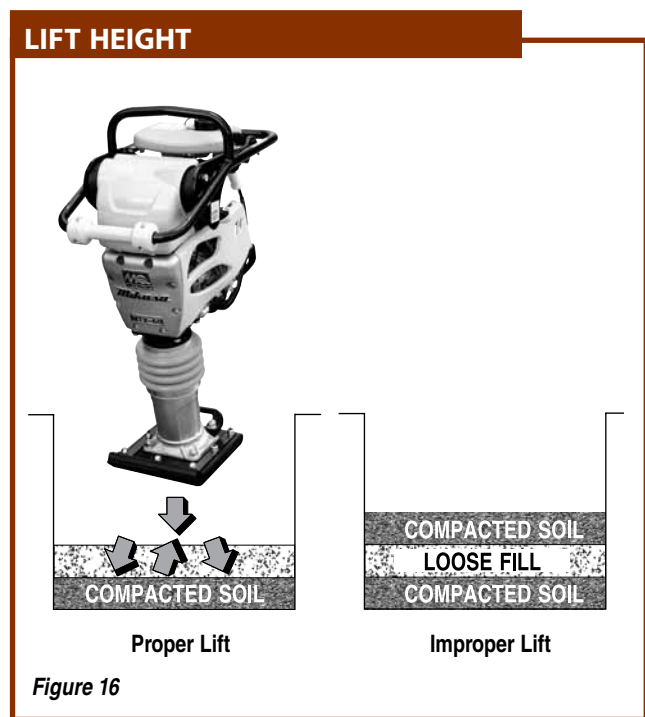

Figure 16

Soil can also be over-compacted if the compactor makes too many passes (a pass is the machine going across a lift in one direction). Over-compaction is like constantly hitting concrete with a sledgehammer. Cracks will eventually appear, reducing density. This is a waste of man-hours and adds unnecessary wear to the machine.

### Compaction specifications

A word about meeting job site specifications. Generally, compaction performance parameters are given on a construction project in one of two ways:

- Method Specification—detailed instructions specify machine type, lift depths, number of passes, machine speed and moisture content. A “recipe” is given as part of the job specs to accomplish the compaction needed. This method is outdated, as machine technology has far outpaced common method specification requirements.
- End-Result Specification—engineers indicate final compaction requirements, thus giving the contractor much more flexibility in determining the best, most economical method of meeting the required specs. Fortunately, this is the trend, allowing the contractor to take advantage of the latest technology available.

## Equipment types

### Rammers

Rammers deliver a high impact force (high amplitude) making them an excellent choice for cohesive and semi-cohesive soils. Frequency range is 500 to 750 blows per minute. Rammers get compaction force from a small gasoline or diesel engine powering a large piston set with two sets of springs. The rammer is inclined at a forward angle to allow forward travel as the machine jumps. Rammers cover three types of compaction: impact, vibration and kneading. [See Figure 17]

### Vibratory plates

Vibratory plates are low amplitude and high frequency, designed to compact granular soils and asphalt. Gasoline or diesel engines drive one or two eccentric weights at a high speed to develop compaction force. The resulting vibrations cause forward motion. The engine and handle are vibration-isolated from the vibrating plate. The heavier the plate, the more compaction force it generates. Frequency range is usually 2500 vpm to 6000 vpm. Plates used for asphalt have a water tank and sprinkler system to prevent asphalt from sticking to the bottom of the baseplate. Vibration is the one principal compaction effect. [See Figure 17]

### Reversible vibratory plates

In addition to some of the standard vibratory plate features, reversible plates have two eccentric weights that allow smooth transition for forward or reverse travel, plus increased compaction force as the result of dual weights. Due to their weight and force, reversible plates are ideal for semi-cohesive soils.

A reversible is possibly the best compaction buy dollar for dollar. Unlike standard plates, the reversible's forward travel may be stopped and the machine will maintain its force for "spot" compaction. [See Figure 17]

## EQUIPMENT TYPES



Figure 17

Figure 18

## EQUIPMENT APPLICATIONS

	Granular Soils	Sand and Clay	Cohesive Clay	Asphalt
Rammers		B	A	
Vibratory Plates	A	B		A
Reversible Plates	B	A	C	C
Vibratory Rollers	B	A	C	A
Rammax Rollers	C	A	A	

- A** — Provides optimum performance for most applications.
- B** — Provides acceptable performance for most applications.
- C** — Limited performance for most applications. Testing required.

\* Chart is provided as a guideline only. Jobsite variables can affect machine performance.



## ROLLER TYPES



V303E  
Vibratory Roller



MRH800GS  
Vibratory Roller



P33/24 HHMR  
Roller



AR13H  
Ride-on Vibratory Roller



RW3015P48  
Ride-on Roller

Figure 19

### Rollers

Rollers are available in several categories: walk-behind and ride-on, which are available as smooth drum, padded drum and rubber-tired models; and are further divided into static and vibratory sub-categories.

[See Figure 18]

### Walk-behind

#### Smooth

A popular design for many years, smooth-drum machines are ideal for both soil and asphalt. Dual steel drums are mounted on a rigid frame and powered by gasoline or diesel engines. Steering is done by manually turning the machine handle.

Frequency is around 4000 vpm and amplitudes range from .018 to .020. Vibration is provided by eccentric shafts placed in the drums or mounted on the frame.

### *Padded*

Padded rollers are also known as trench rollers due to their effective use in trenches and excavations. These machines feature hydraulic or hydrostatic steering and operation. Powered by diesel engines, trench rollers are built to withstand the rigors of confined compaction. Trench rollers are either skid-steer or equipped with articulated steering. Operation can be by manual or remote control. Large eccentric units provide high impact force and high amplitude (for rollers) that are appropriate for cohesive soils. The drum pads provide a kneading action on soil. Use these machines for high productivity.

### *Ride-on*

Configured as static steel-wheel rollers, ride-ons are used primarily for asphalt surface sealing and finishing work in the larger (8 to 15 ton) range. Small ride-on units are used for patch jobs with thin lifts. The trend is toward vibratory rollers. Tandem vibratory rollers are usually found with drum widths of 30" up to 110", with the most common being 48".

Suitable for soil, sub-base and asphalt compaction, tandem rollers use the dynamic force of eccentric vibrator assemblies for high production work. Single-drum machines feature a single vibrating drum with pneumatic drive wheels. The drum is available as smooth for sub-base or rock fill, or padded for soil compaction. Additionally, a ride-on version of the pad foot trench roller is available for very high productivity in confined areas, with either manual or remote control operation.

### *Rubber-tire*

These rollers are equipped with 7 to 11 pneumatic tires with the front and rear tires overlapping. A static roller by nature, compaction force is altered by the addition or removal of weight added as ballast in the form of water or sand. Weight ranges vary from 10 to 35 tons. The compaction effort is pressure and kneading, primarily with asphalt finish rolling. Tire pressures on some machines can be decreased while rolling to adjust ground contact pressure for different job conditions.

## Safety and General Guidelines

As with all construction equipment, there are many safety practices that should be followed while using compaction equipment. While this handbook is not designed to cover all aspects of job site safety, we wish to mention some of the more obvious items in regard to compaction equipment. Ideally, equipment operators should familiarize themselves with all of their company's safety regulations, as well as any OSHA, state agency or local agency regulations pertaining to job safety. Basic personal protection, consisting of durable work gloves, eye protection, ear protection, approved hard hat and work clothes, should be standard issue on any job and available for immediate use.

In the case of walk-behind compaction equipment, additional toe protection devices should be available, depending on applicable regulations. All personnel operating powered compaction equipment should read all operating and safety instructions for each piece of equipment. Additionally, training should be provided so that the operator is aware of all aspects of operation.

No minors should be allowed to operate construction equipment. No operator should run construction equipment when under the influence of medication, illegal drugs or alcohol. Serious injury or death could occur as a result of improper use or neglect of safety practices and attitudes. This applies to both the new worker as well as the seasoned professional.

### **Shoring**

Trench work brings a new set of safety practices and regulations for the compaction equipment operator. This section does not intend to cover the regulations pertaining to trench safety (OSHA Part 1926, Subpart P). The operator should have knowledge of what is required *before* compacting in a trench or confined area. Be certain a "competent person" (as defined by OSHA in Part 1926.650 revised July 1, 1998) has inspected the trench and follows the OSHA guidelines for inspection during the duration of the job. Besides the obvious danger of a trench cave-in, the worker must also be protected from falling objects. Unshored (or shored) trenches can be compacted with the use of remote control compaction equipment. This allows the operator to stay outside the trench while operating the equipment.

Safety first!

## Glossary

**AASHO** American Association of State Highway Officials.

**Adhesion** a property of soil which causes the particles to stick together.

**Aggregate** stone or gravel that was crushed and screened to various sizes for use in concrete, asphalt or road surfaces.

**Amplitude** the total vertical distance the vibrating drum or plate is displaced from a resting or neutral position from the eccentric moment.

**ASTM** American Society for Testing Materials.

**Backfill** materials used in refilling a cut or other excavation, or the act of such refilling.

**Ballast** heavy material, such as water, sand or metal which has no function in a machine except to increase its weight.

**Bank** a mass of soil rising above an average level. Generally, any soil which is to be dug from its natural position.

**Bank Gravel** a natural mixture of cobbles, gravel, sand and fines.

**Bank Yards** soil or rock measured in its original position before digging.

**Base** the course or layer of materials in a roadway section on which the actual pavement is placed. It may be of different types of materials ranging from selected soils to crushed stone or gravel.

**Berm** an artificial ridge of earth, generally side- slopes of a roadbed.

**Binder** fines which fill voids or hold gravel together when dry.

**Borrow Pit** an excavation from which fill material is taken.

**BPR** U.S. Bureau of Public Roads.

**BUREC** U.S. Bureau of Reclamation.

**Capillary** a phenomenon of soil which allows water to be absorbed either upward or laterally.

**Centrifugal Force** the force generated from the unbalanced condition of eccentric shaft rotation at a given speed.

**Clay** material composed and derived from the decomposition of rock which consists of microscopic particles.

**Clean** free of foreign material; in reference to sand or gravel, lack of a binder.

**Cohesion** a property of soil which holds the particles together by sticking. Also, the soil's ability to resist shear is determined by its degree of cohesiveness.

**Cohesive Material** a soil having properties of cohesion.

**Compacted Yards** measurement of soil or rock after it is placed and compacted in a fill.

**Compressibility** a property of soil which permits deformation when subjected to a load.

**Core** a cylindrical piece of an underground formation, cut and raised by a rotary drill with a hollow bit. The impervious center of an earthfill dam.

**Crown** the elevation of a road surface at its edges, to encourage drainage.

**Datum** any level surface taken as a plane of reference from which to measure elevations.

**Density** the ratio of the weight of a substance to its volume.

**Embankment** a fill with a top higher than the adjoining natural surface.

**Elasticity** a characteristic of soil which allows deformation during a subjected load, but returns almost to its original configuration after removal of the force.

**Fines** clay or silt particles in soil.

**Finish Grade** the final grade required by specifications.

**Foot** in tamping rollers, one of a number of projections from a cylindrical drum.

**Frequency** referring to rotational speed of the eccentric shaft—usually rated in “Vibrations Per Minute”—which is equal to the RPM of the shaft.

**Frost Line** the greatest depth to which ground is expected to freeze in a given location.



**Grade** usually the surface elevation of the ground at points where it meets a structure. Also, surface slope.

**Grain Size Curve** a soil graph analysis showing the percentage size variations by weight.

**Granular Material** a sandy type of soil with particles that are coarser than cohesive material and do not stick to each other.

**Gravel** a cohesionless aggregate of rock fragments with varying dimensions of 3.0 to .08 inches.

**Gumbo** material in the plastic state identified by a soapy or waxy appearance.

**Humus** organic material formed by the decomposition of vegetation.

**Impervious** resistant to movement of water.

**In Situ** natural undisturbed soil in place.

**Lift** a layer of fill as spread or compacted.

**Liquid Limit** the water content at which soil passes from a plastic to a liquid state.

**Loam** a soft, easily worked soil containing sand, silt, clay and decayed vegetation.

**Optimum Moisture Content** that percent of moisture at which the greatest density of a soil can be obtained through compaction.

**Pass** a working trip or passage of an excavating, grading or compaction machine from point A to point B. (One direction only.)

**Permeability** a characteristic of soil which allows water to flow through it because of gravity.

**Plastic** the ability of a soil to be rolled into a fine thread at a certain moisture content.

**Plastic Limit** the lowest moisture content at which a soil can be rolled into a 1/8" diameter thread without breaking.

**Proctor** a method developed by R.R. Proctor for determining the density/moisture relationship in soils. It is almost universally used to determine the maximum density of any soil so that specifications may be properly prepared for field construction requirements.

**Proctor, Modified** a moisture density test of more rigid specification than Proctor. The basic difference is the use of heavier weight dropped from a greater distance in laboratory tests.

**Quicksand** fine sand or silt that is prevented from settling firmly together by upward movement of underground water.

**Sand** a cohesionless aggregate of round and angular fragments of rock with a particle size between 2.0 and .05mm.

**Shearing Resistance** a soil's ability to resist sliding against neighboring soil grains when force is applied. Internal friction and cohesion determine shear resistance.

**Shrinkage** soil volume which is reduced when subjected to moisture; usually occurs in fine grain soils.

**Silt** soil material composed of particles between .005 and .05mm in diameter.

**Soil** the loose surface material of the earth's crust.

**Stabilize** to make soil firm and prevent it from moving.

**Sub-base** the layer of material placed to furnish strength to the base of a road.

**Subgrade** the surface produced by grading native earth, or cheap imported materials which serve as a base for more expensive paving.

Acknowledgements: Budinger & Associates, Geotechnical & Material Engineers, for their assistance with some material.





© COPYRIGHT 2011, MULTIQUIP INC.  
SOILCOMPACTHNDK REV. A (0212\_BD)

Connect with us on



**MULTIQUIP INC.**  
POST OFFICE BOX 6254  
CARSON, CA 90749  
310-537-3700 • 800-421-1244  
FAX: 310-537-3700  
E-MAIL: [mq@multiquip.com](mailto:mq@multiquip.com)  
[www.multiquip.com](http://www.multiquip.com)