



Solar Heating and Cooling

Solar Heating and Cooling (SHC) Technology – The Basics



Solar heating and cooling is a clean, reliable and cost-effective technology that is reducing utility bills for thousands of homes and businesses. Today, Americans across the country are at work manufacturing and installing systems that significantly reduce our dependence on imported fuels. We need smart policies to expand this fast-growing job-producing sector.

- Umbrella term used to represent four different applications:
 1. solar water heating
 2. solar space heating
 3. solar cooling
 4. solar pool heating
- Not to be confused with solar thermal ELECTRIC

How does SHC work?

- SHC systems trap the heat from the sun (solar radiation) and transfer the heat to water or air for use as thermal energy.
- While both SHC systems and solar photovoltaic (PV) systems involve collector panels, they are very different technologies.

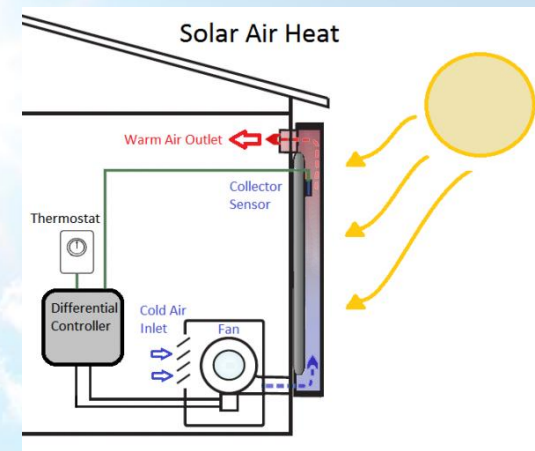
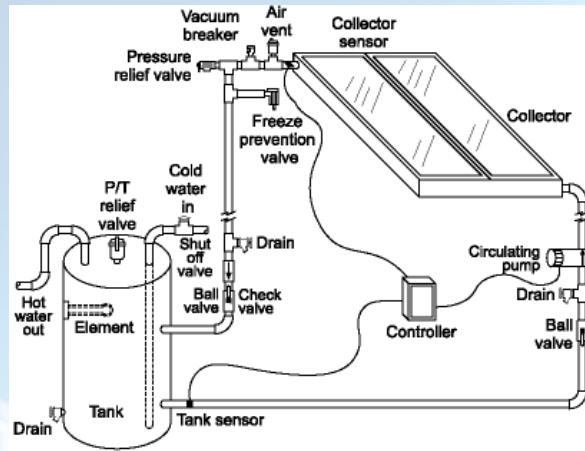

- Solar water heating systems are composed of three main elements: the solar collector, insulated piping, and a hot water storage tank. While there are many design variations, essentially the solar collector gathers the heat from the sun and transfers the heat to potable water. This heated water flows out of the collector to a hot water tank, and is used as necessary.

Why is SHC important?

- Water heating, space heating, and space cooling accounted for 72% of the energy used in an average household in the U.S. in 2010 - representing a huge market potential for solar heating and cooling technologies!

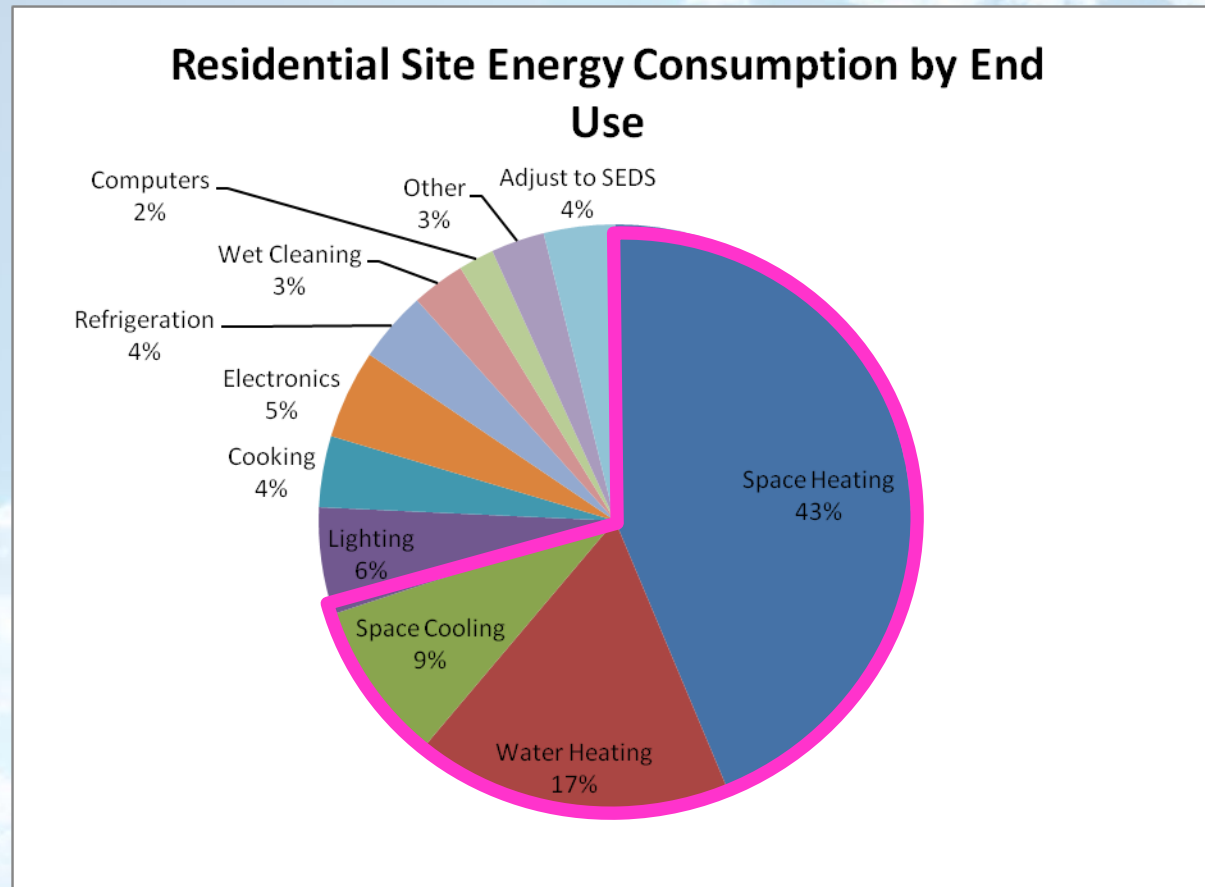

How does SHC help with energy security?

- Solar heating and cooling technologies can displace the need for natural gas, fuel oil, and electricity to heat homes and businesses, thereby reducing the dependence on imported fuels.

2010 Residential Energy End-Use Splits for Fuel Type for Space Heating, Water Heating, Space Cooling

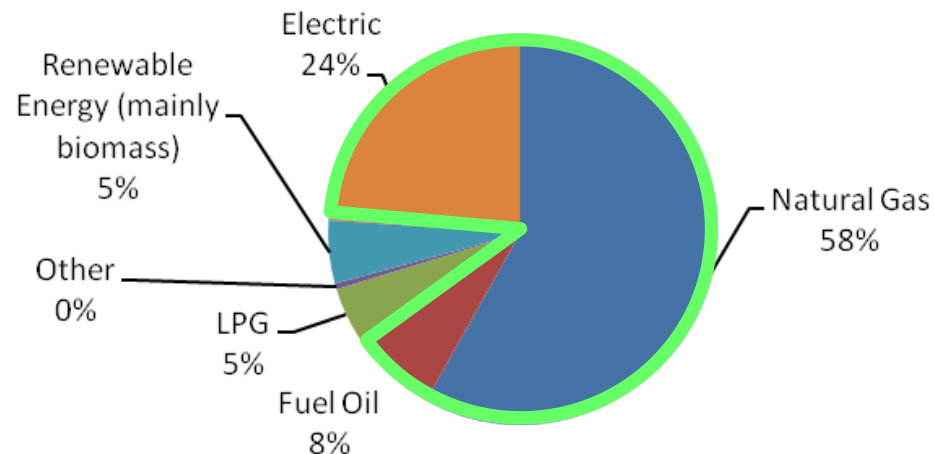

How does SHC grow the U.S. economy?

- SHC imported \$13.6 million dollars of SHC goods in 2010, but exported \$16.3 million dollars, for a positive trade balance of \$3 million.
- For every dollar invested in SHC technology, 79 cents will stay in the U.S. This helps drive investment in the U.S. and keeps our nation economically competitive.



Source: GTM Research

Source: U.S. Solar Energy Trade Assessment, 2011

www.seia.org

How does SHC create jobs in the U.S.?

- Americans in all 50 states are at work today designing, manufacturing and installing these systems. In 2010, the solar industry supported 100,000 jobs in all 50 states and is expected to grow 26 percent in 2011. These are quality jobs with good benefits that cannot be sent overseas.



Closer Look:

FLS Energy recently installed the largest SWH system in the U.S. at Prestage Foods in St. Pauls, NC. The system will produce an average of 100,000 gallons of hot water a day for use in the turkey processor's operations. During construction, more than 50 construction employees were working on site, 7 days a week.

The Polls are in...

- According to independent polling conducted by Gotham Research Group, SHC is viewed positively, by a 10-1 ratio (48 percent to 4 percent).
- Three out of four (74 percent) Americans agree, 'the growth of the solar water heating industry will produce jobs and help the American economy.'
 - This support is strong across regions of the country and across party lines.

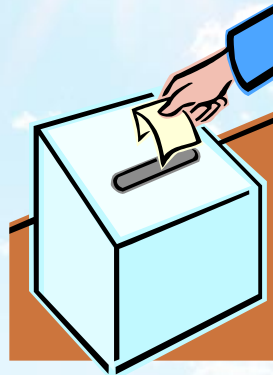

How can we grow the SHC market in the U.S.?

- Extend the 30% federal ITC (expires 2016)
- Include SHC technologies as *generating* technologies to be eligible for Solar Renewable Energy Credits (SRECs) or Renewable Energy Credits (RECs) in state and federal Renewable Portfolio Standards (RPS) or Clean Energy Standards (CES)
- Allow commercial pools to take the 30% federal ITC
- Establish a thermal RPS on a state and/or federal level
- Adopt strong building energy codes that encourage builders to include SHC on new buildings
- Implement section 523 of the 2007 Energy Act, requiring 30% of the hot water demand for all new or renovated federal buildings to come from solar energy.
- Establish strong manufacturing incentives (48c extension or additional funding)
- Increase workforce training for SHC
- Continue to allow SWH to qualify for the ENERGY STAR label. As of May 2012, there were already 493 ENERGY STAR-certified solar water heating models.



A Closer Look at Solar Water Heating

Solar Water Heating Technology - Economics

*How much will it cost to install a SWH system on my house?
What's my return on investment?*

- **Short answer:** I have no idea.
- **Longer Answer:** It depends. Solar water heating systems are affordable for families. The return on investment can be as little as 3-6 years, the lowest of any solar technology. Commercial systems help companies reduce and manage their energy bills, managing long-term costs. Meanwhile, fossil fuel prices fluctuate significantly and are expected to rise significantly over the next decade.
- **Longest Answer OR “Here’s what you need to know to get the answer”**
 - How much hot water does your family use in a day? This will determine your hot water load, and how many collectors you will need.
 - How much annual sunlight does your area receive? This will help to determine the solar fraction for your area, or how much SWH can contribute to your hot water needs.
 - How much are you currently paying to heat your water? Are you currently using natural gas, or fuel oil, or electricity?
 - What federal, state, and local incentives are available?

Solar Water Heating Technology - Economics

To address the issue of the small up-front cost, solar integrators have developed a number of financing options for their customers.

- **Power-Purchase Agreement (PPA)** – Customer purchases only the thermal energy generated from the system.
- **Property-Assessed Clean Energy (PACE)** – Up-front cost is paid by a local government fund and repaid by homeowner through property taxes
- **Solar Renewable Energy Certificate (SREC)** – in those states in which SWH qualifies as a generating technology for SRECs, the value of the SREC sold can help to offset the cost of the system

More on Solar Water Heating

- A properly designed and installed solar water heating system can be expected to provide a significant percentage (40 to 80 percent) of a building's hot water needs.
- Many residential solar water heating projects can be completed in as little as one day.

Simulated U.S. Solar Water Heating Solar Fraction

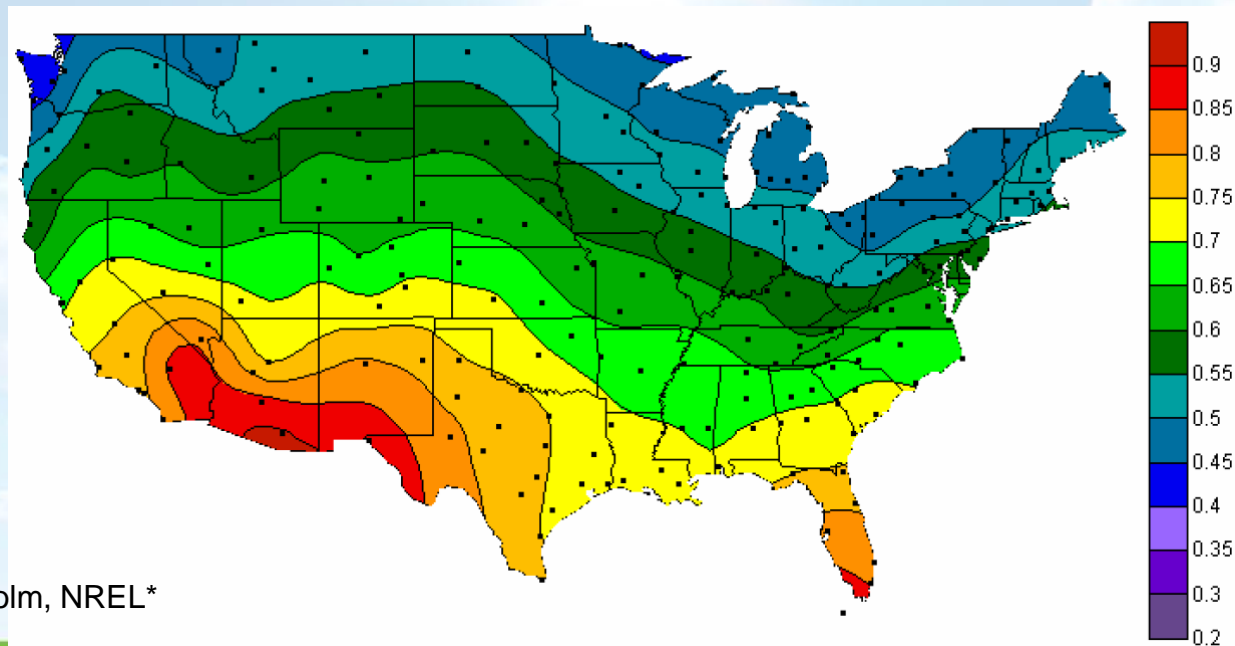

Source: Paul Denholm, NREL*

* Denholm, P. "The Technical Potential of Solar Water Heating to Reduce Fossil Fuel Use and Greenhouse Gas Emissions in the United States" National Renewable Energy Lab, March 2007; Figure 4

Solar Water Heating Continues Steady Growth

- Solar water heating grew 5% in 2010 to 2.4 million square feet of collectors sold, while solar pool heating rebounded from a five-year low in 2009 and grew 13 percent in 2010 to 10 million square feet of collectors sold. This is equivalent to a combined solar heating and cooling capacity of 814 MW_{thermal} in 2010 alone.
- Today there are an estimated 2.3 million solar water heating and pool heating systems installed in the U.S.

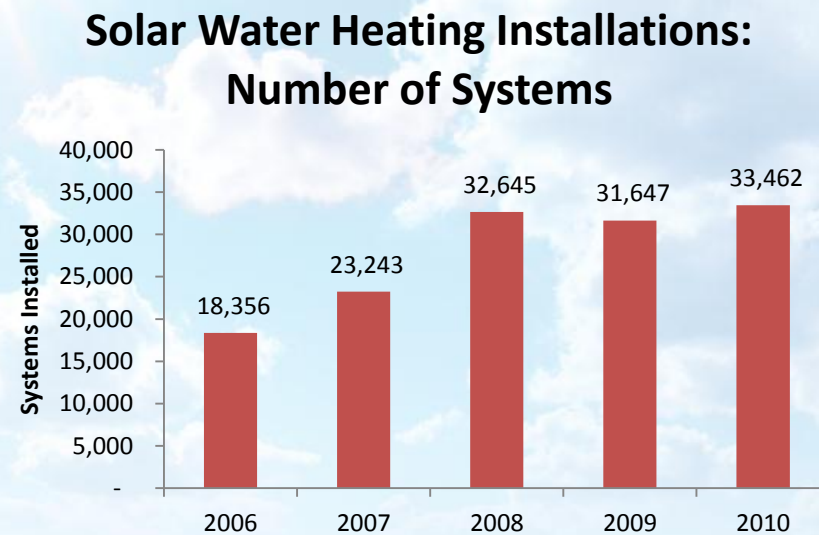
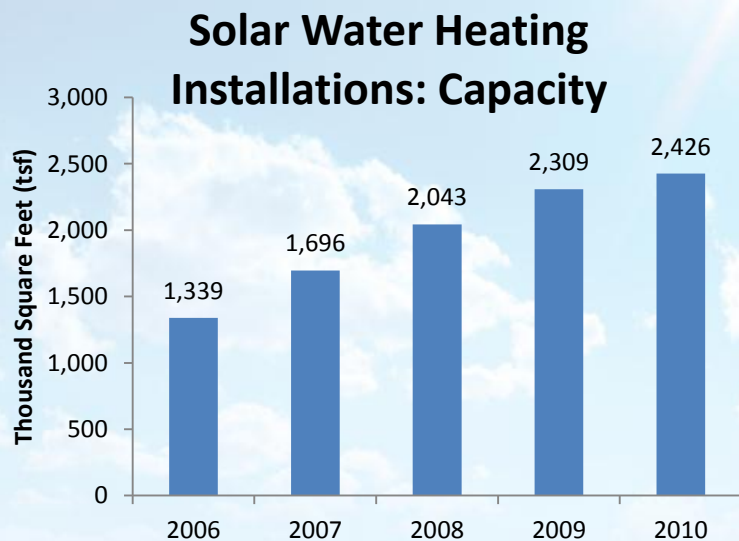

Where are the major SWH installation markets?

- California maintained its position as the leading installer of solar water heating systems in 2010 as the overall market grew 5 percent to 2.4 million square feet, or 158 MW_{th}, compared to 2.3 million square feet, or 150 MW_{th}, in 2009.

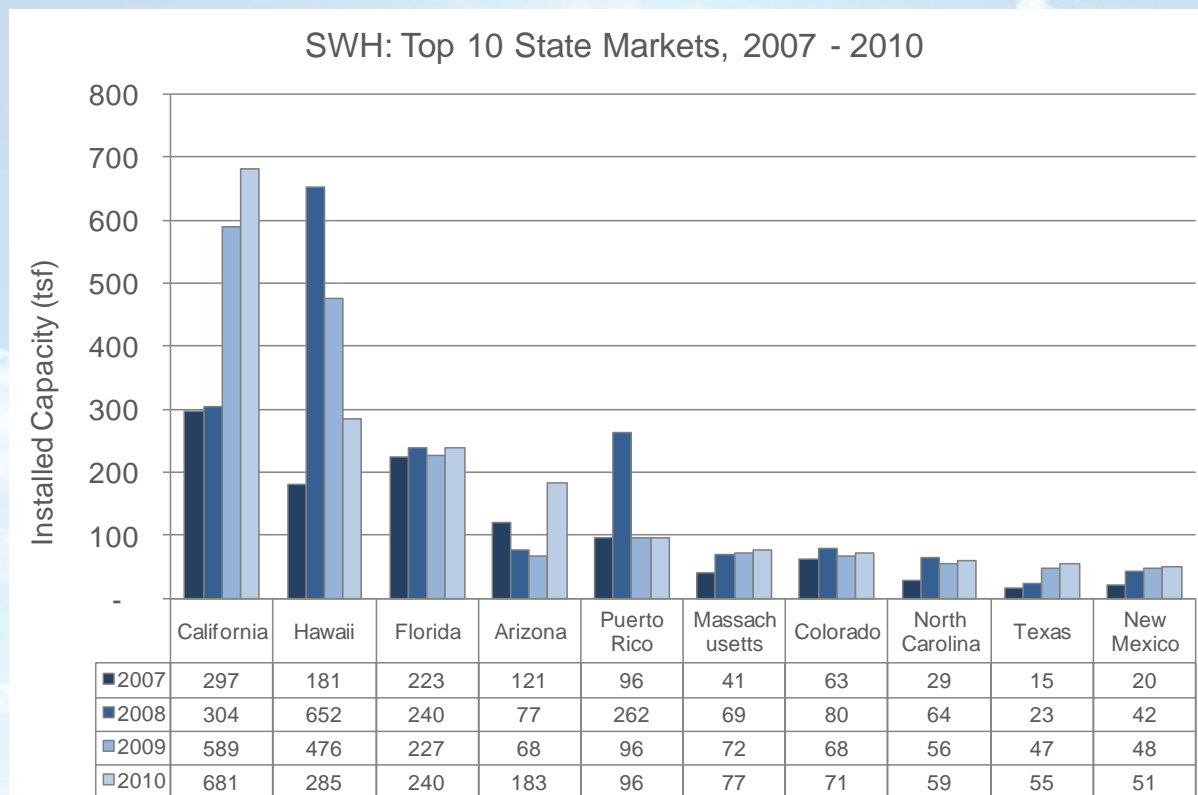

A Closer Look at SWH: how does it work?

- 3 basic components:
 - (1) collector
 - (2) storage tank
 - (3) insulated piping
- The solar collector gathers the heat from the sun and transfers the heat to potable water. This heated water flows out of the collector to a hot water tank, and is used as necessary; this type of system is called open-loop, or a direct system.
- Auxiliary heating can remain connected to the hot water tank for back-up if necessary.

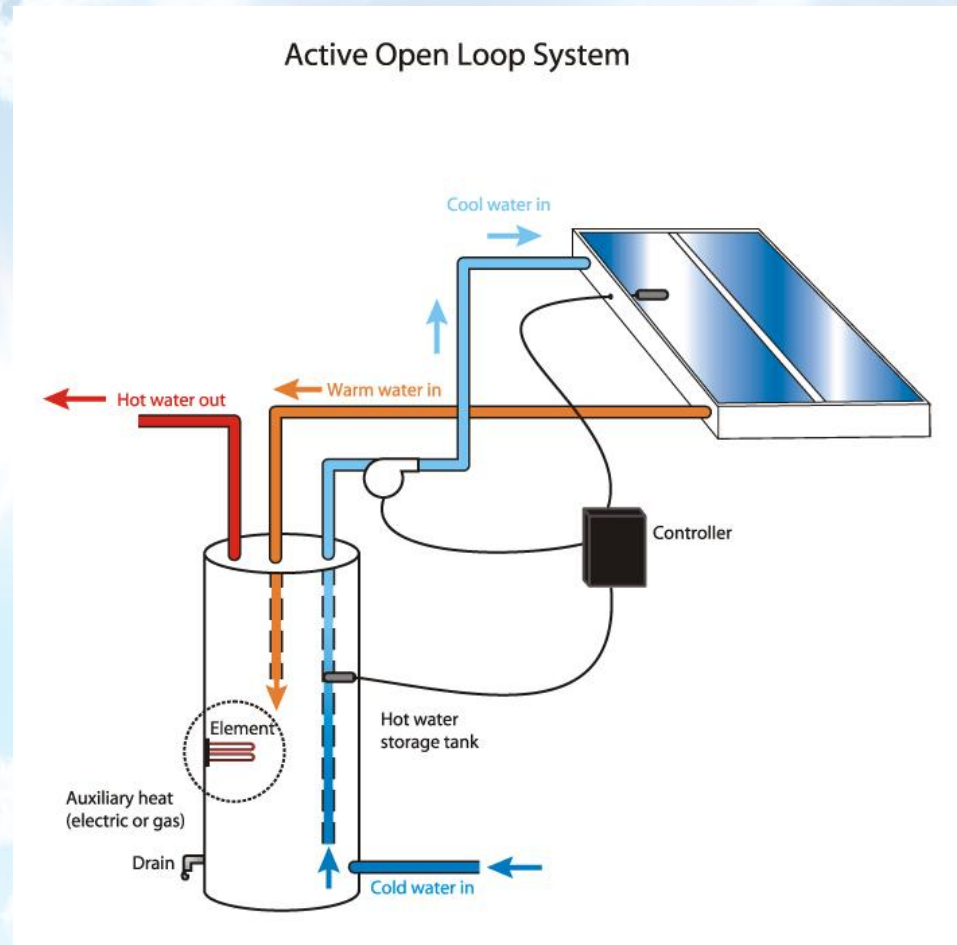

A Closer Look at SWH: how does it work?

System Design

- Active Systems:
 - Include pumps and electronic controls
 - Include a freeze protection system for colder climates.
 - Indirect systems: also called “closed loop”. In colder climates with the possibility of freezing temperatures, an antifreeze solution, such as non-toxic propylene glycol, is heated in the solar collector and circulated to the hot water storage tank via a heat exchanger. The potable water in the storage tank is warmed by the hot, antifreeze-filled heat exchanger, and the heated water can then be used as necessary, while the cooled glycol is piped back to the solar collector to be heated again.
 - Drainback systems: when no sunlight is available for heating, the solar pump turns off and the water “drains back” into the storage tank by means of gravity
 - Direct systems: also called “open loop”, potable water is pumped through the collector; only applicable in non-freezing climates.
- Passive Systems:
 - No pumps or controls
 - Relies on gravity and thermodynamic principles to circulate water

Solar Water Heating: System Design

Integral Collector Storage System

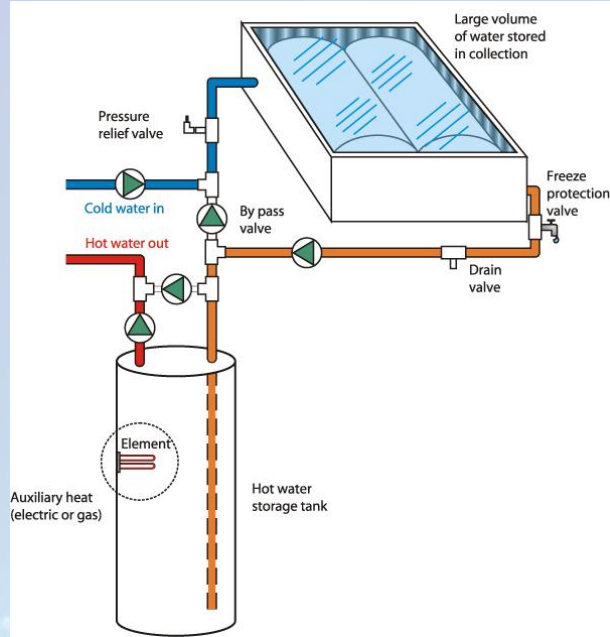

Closed Loop, Anti-Freeze System

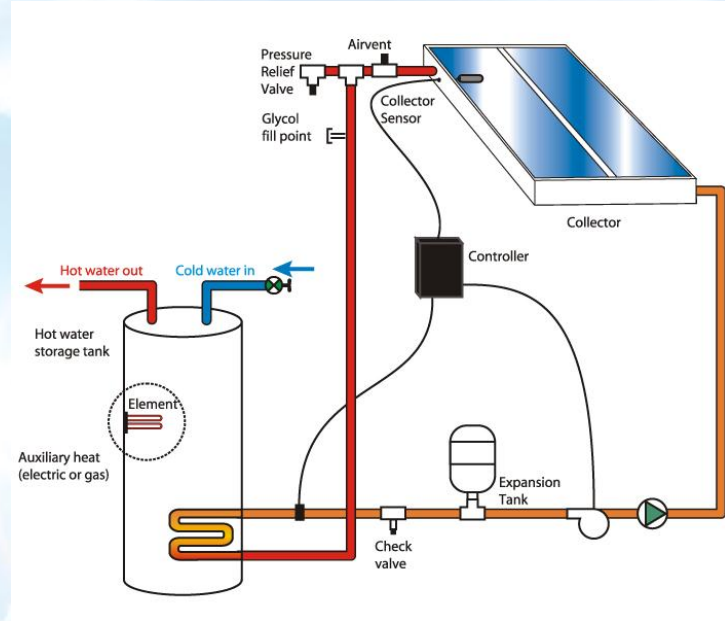

A Closer Look at SWH: are there different collectors?

Collectors

- Low-temp, medium-temp, and high-temp collectors based on the glazing on the cover plate or tube
- 4 main collector types:
 - Flat plate
 - Copper pipes create a matrix of “risers” and are affixed to an absorber plate contained in an insulated box covered with a tempered glass or a polymer cover plate.
 - Evacuated Tube
 - Consists of rows of parallel, transparent glass tubes that have been “evacuated” of air, creating a highly efficient heat insulator for the fluid that runs inside the length of the tube.
 - Generally used when higher water temperatures are needed
 - Integral Collector Storage (ICS)
 - Thermosiphon

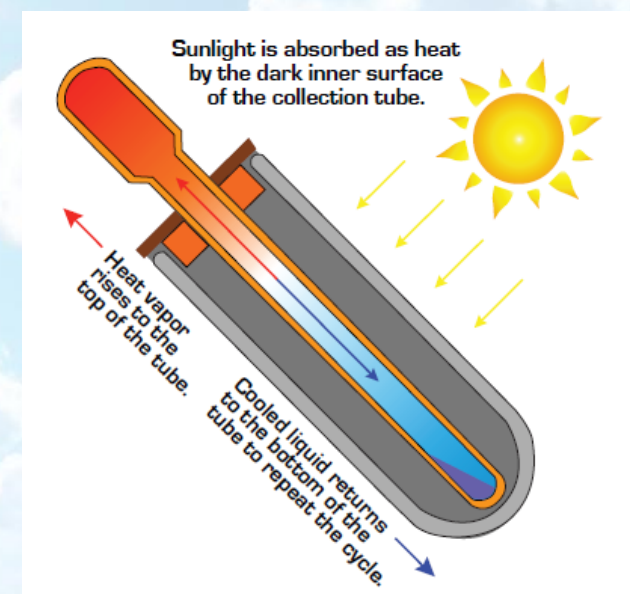
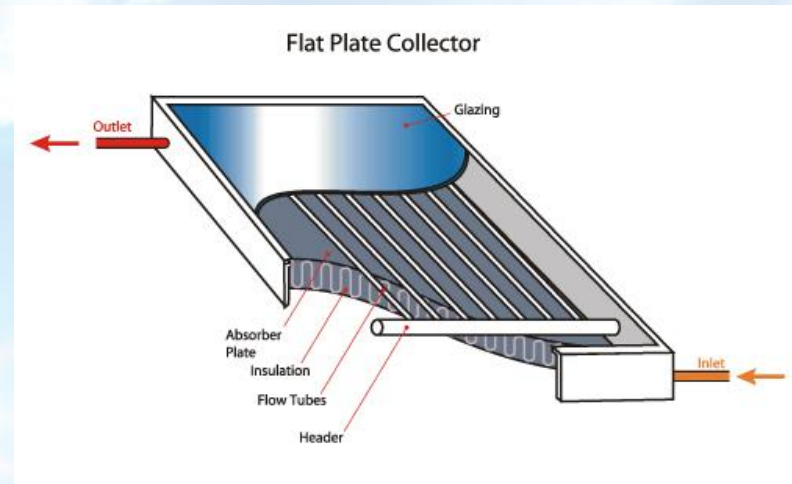

Questions?

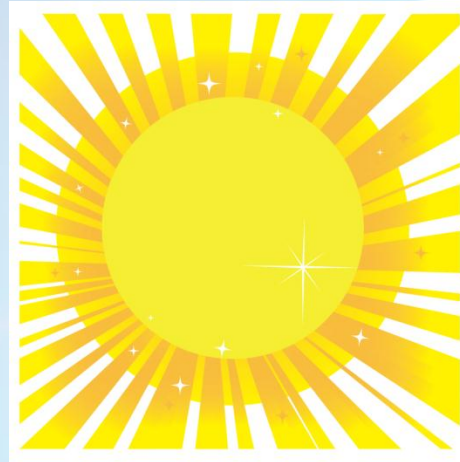

For more info, visit www.seia.org