



# **SolarEdge**

## **HD-Wave Inverter**

### **Installation Guide**

For Europe & APAC  
Version 1.1

# Disclaimers

## Important Notice

---

Copyright © SolarEdge Inc. All rights reserved.

No part of this document may be reproduced, stored in a retrieval system or transmitted, in any form or by any means, electronic, mechanical, photographic, magnetic or otherwise, without the prior written permission of SolarEdge Inc.

The material furnished in this document is believed to be accurate and reliable. However, SolarEdge assumes no responsibility for the use of this material. SolarEdge reserves the right to make changes to the material at any time and without notice. You may refer to the SolarEdge web site ([www.solaredge.com](http://www.solaredge.com)) for the most updated version.

All company and brand products and service names are trademarks or registered trademarks of their respective holders.

Patent marking notice: see <http://www.solaredge.com/groups/patent>

The general terms and conditions of delivery of SolarEdge shall apply.

The content of these documents is continually reviewed and amended, where necessary. However, discrepancies cannot be excluded. No guarantee is made for the completeness of these documents.

The images contained in this document are for illustrative purposes only and may vary depending on product models.

## Emission Compliance

---

This equipment has been tested and found to comply with the limits applied by the local regulations. These limits are designed to provide reasonable protection against harmful interference in a residential installation. This equipment generates, uses and can radiate radio frequency energy and, if not installed and used in accordance with the instructions, may cause harmful interference to radio communications. However, there is no guarantee that interference will not occur in a particular installation. If this equipment does cause harmful interference to radio or television reception, which can be determined by turning the equipment off and on, you are encouraged to try to correct the interference by one or more of the following measures:

- Reorient or relocate the receiving antenna.
- Increase the separation between the equipment and the receiver.
- Connect the equipment into an outlet on a circuit different from that to which the receiver is connected.
- Consult the dealer or an experienced radio/TV technician for help.

Changes or modifications not expressly approved by the party responsible for compliance may void the user's authority to operate the equipment.

# Support and Contact Information

If you have technical problems concerning SolarEdge products, please contact us:

Country	Phone	E-Mail
Australia (+61)	1800 465 567	<a href="mailto:support@solaredge.net.au">support@solaredge.net.au</a>
APAC (Asia Pacific)		<a href="mailto:support-asia@solaredge.com">support-asia@solaredge.com</a>
Belgium (+32)	0800 78889	<a href="mailto:support@solaredge.be">support@solaredge.be</a>
China (+86)	186-0166-3934	<a href="mailto:support_china@solaredge.com">support_china@solaredge.com</a>
France (+33)	0800 917410	<a href="mailto:support@solaredge.fr">support@solaredge.fr</a>
Germany (+49)	089-45459730	<a href="mailto:support@solaredge.de">support@solaredge.de</a>
Italy (+39)	800 784 824	<a href="mailto:support@solaredge.it">support@solaredge.it</a>
Japan (+81)	03-6261-1274	<a href="mailto:support@solaredge.jp">support@solaredge.jp</a>
Netherlands (+31)	0800 0221089	<a href="mailto:support@solaredge.nl">support@solaredge.nl</a>
US & Canada (+1)	510-498-3200	<a href="mailto:ussupport@solaredge.com">ussupport@solaredge.com</a>
United Kingdom (+44)	0800 028 1183	<a href="mailto:support@solaredge.uk">support@solaredge.uk</a>
Greece (+30)	0800 125574	<a href="mailto:support@solaredge.com">support@solaredge.com</a>
Israel (+972)	073 240-3122	
New Zealand (+64)	0800 144 875	
Worldwide (+972)	073 240-3118	
Fax (+972)	073 240-3117	

Before contact, make sure to have the following information at hand:

- Model and serial number of the product in question.
- The error indicated on the inverter screen or on the SolarEdge monitoring portal, if there is such an indication.
- System configuration information, including the type and number of modems connected and the number and length of strings.
- The communication method to the SolarEdge server, if the site is connected.
- The inverter software version as appears in the ID status screen (see *ID Status* on page 37).

# Contents

<b>Disclaimers</b> .....	<b>1</b>
Important Notice .....	1
Emission Compliance .....	1
<b>Support and Contact Information</b> .....	<b>2</b>
<b>Contents</b> .....	<b>3</b>
<b>HANDLING AND SAFETY INSTRUCTIONS</b> .....	<b>6</b>
Safety Information .....	6
<b>IMPORTANT SAFETY INSTRUCTIONS</b> .....	<b>7</b>
<b>Chapter 1: Introducing the SolarEdge Power Harvesting System</b> .....	<b>9</b>
SolarEdge Power Optimizer .....	9
SolarEdge Inverter .....	9
SolarEdge Monitoring Portal .....	9
Installation Procedure .....	9
Installation Equipment List .....	10
Inverter Transport and Storage .....	10
<b>Chapter 2: Installing the Power Optimizers</b> .....	<b>11</b>
Safety .....	11
Installation Guidelines .....	11
Step 1: Mounting the Power Optimizers .....	12
Step 2: Connecting a PV Module to a Power Optimizer .....	12
Step 3: Connecting Power Optimizers in Strings .....	13
Step 4: Verifying Proper Power Optimizer Connection .....	14
<b>Chapter 3: Installing the Inverter</b> .....	<b>15</b>
Inverter Package Contents .....	15
Identifying the Inverter .....	15
Inverter Interfaces .....	15
Mounting the Inverter .....	16
<b>Chapter 4: Connecting the AC and the Strings to the Inverter</b> .....	<b>18</b>
Connecting the AC Grid to the Inverter .....	18
Connecting the Strings to the Inverter .....	19
Selecting a Residual Current Device (RCD) .....	20
<b>Chapter 5: Commissioning the Installation</b> .....	<b>21</b>
Step 1: Activating the System .....	21
Step 2: Pairing Power Optimizers to the Inverter .....	22
Step 3: Verifying Proper Operation .....	24
Step 4: Reporting and Monitoring Installation Data .....	24
The SolarEdge Monitoring System .....	24
Providing Installation Information .....	25
Site Mapper Application .....	25
Creating a Site in the SolarEdge Monitoring Portal .....	26
Paper Template .....	26
<b>Chapter 6: User Interface</b> .....	<b>27</b>
LCD User Buttons .....	27

Inverter Configuration – Setup Mode .....	28
Configuration Menu Options .....	31
Country and Grid .....	31
Language .....	31
Communication .....	31
Power Control .....	33
Display .....	33
Maintenance .....	34
Information .....	34
Status Screens - Operational Mode .....	35
Initial Status .....	35
Main Inverter Status .....	35
Energy Meter Status .....	36
Telemetry Status .....	36
ID Status .....	37
Server Communication Status .....	37
IP Status .....	37
ZigBee Status .....	38
Wi-Fi Status .....	38
GSM Status .....	38
Communication Ports Status .....	39
Smart Energy Management Status .....	39
Power Control Status .....	40
<b>Chapter 7: Setting Up Communication .....</b>	<b>41</b>
Communication Types .....	41
Communication Connectors .....	41
Removing the Inverter Cover .....	42
Creating an Ethernet (LAN) Connection .....	42
Creating an RS485 Bus Connection .....	45
Additional Connection Options .....	48
Creating a Wireless ZigBee Connection .....	48
Creating a Wi-Fi Connection .....	48
Verifying the Connection .....	48
<b>Appendix A: Errors and Troubleshooting .....</b>	<b>49</b>
Troubleshooting Communication .....	49
Troubleshooting Ethernet Communication .....	49
Troubleshooting RS485 Communication .....	50
Additional Troubleshooting .....	50
Error Codes .....	50
Power Optimizer Troubleshooting .....	54

---

<b>Appendix B: Technical Specifications</b> .....	<b>55</b>
<b>Appendix C: Mechanical Specifications</b> .....	<b>58</b>
<b>Appendix D: Inverter Arc Detection and Interruption</b> .....	<b>59</b>
<b>Appendix E: Replacing and Adding System Components</b> .....	<b>61</b>
Replacing an Inverter .....	61
<b>Appendix F: Safe DC™</b> .....	<b>63</b>

# HANDLING AND SAFETY INSTRUCTIONS

During installation, testing and inspection, adherence to all the handling and safety instructions is mandatory. **Failure to do so may result in injury or loss of life and damage to the equipment.**

## Safety Information

The following safety symbols are used in this document. Familiarize yourself with the symbols and their meaning before installing or operating the system.

### WARNING!



Denotes a hazard. It calls attention to a procedure that, if not correctly performed or adhered to, could result in **injury or loss of life**. Do not proceed beyond a warning note until the indicated conditions are fully understood and met.

### CAUTION!



Denotes a hazard. It calls attention to a procedure that, if not correctly performed or adhered to, could result in **damage or destruction of the product**. Do not proceed beyond a caution sign until the indicated conditions are fully understood and met.

### NOTE



Denotes additional information about the current subject.

### IMPORTANT SAFETY FEATURE



Denotes information about safety issues.

Disposal requirements under the Waste Electrical and Electronic Equipment (WEEE) regulations:



### NOTE

Discard this product according to local regulations or send it back to SolarEdge.

# IMPORTANT SAFETY INSTRUCTIONS

SAVE THESE INSTRUCTIONS

## WARNING!



The inverter cover must be opened only after shutting off the inverter ON/OFF switch located at the bottom of the inverter. This disables the DC voltage inside the inverter. Wait five minutes before opening the cover. Otherwise, there is a risk of electric shock from energy stored in the capacitors.

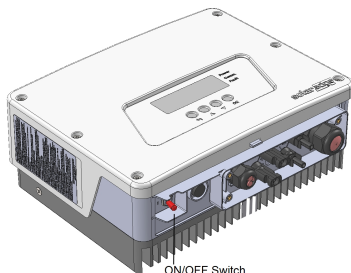

## WARNING



Before operating the inverter, ensure that the inverter AC power cable and wall outlet are grounded properly.

## WARNING



Opening the inverter and repairing or testing under power must be performed only by qualified service personnel familiar with this inverter.

## WARNING!



Do not touch the PV panels or any rail system connected when the inverter switch is ON, unless grounded.

## WARNING!



Under single fault conditions, the Safe DC voltage is only guaranteed when using modules of up to 95V<sub>oc</sub>.

## CAUTION!



This unit must be operated under the specified operating specifications, as described in the latest technical specification datasheet provided with the unit .

## CAUTION!



**HEAVY OBJECT.** To avoid muscle strain or back injury, use proper lifting techniques, and if required - a lifting aid when removing or replacing.

## NOTE



Use PV modules rated according to IEC 61730 class A..

## NOTE



The symbol  appears at grounding points on the SolarEdge equipment. This symbol is also used in this manual.



**NOTE**

The following warning symbols appear on the inverter warning label:



Risk of electric shock



**5 Minutes**

Risk of electric shock from energy stored in the capacitor. Do not remove cover until 5 minutes after disconnecting all sources of supply.



Hot surface – To reduce the risk of burns, do not touch.

# Chapter 1: Introducing the SolarEdge Power Harvesting System

The SolarEdge power harvesting solution maximizes the power output from any type of solar Photovoltaic (PV) installation while reducing the average cost per watt. The following sections describe each of the system's components.

## SolarEdge Power Optimizer

---

The SolarEdge power optimizers are DC-DC converters connected to PV modules in order to maximize power harvesting by performing independent Maximum Power Point Tracking (MPPT) at the module level.

The power optimizers regulate the string voltage at a constant level, regardless of string length and environmental conditions.

The power optimizers include a safety voltage function that automatically reduces the output of each power optimizer to 1 Vdc in the following cases:

- During fault conditions
- The power optimizers are disconnected from the inverter
- The inverter's ON/OFF switch is turned OFF

Each power optimizer also transmits module performance data over the DC power line to the inverter.

Two types of power optimizers are available:

- Module Add-on power optimizer – connected to one or more modules
- Smart modules - the power optimizers are embedded into a module

## SolarEdge Inverter

---

The SolarEdge inverter efficiently converts DC power from the modules into AC power that can be fed into the main AC service of the site and from there to the grid. The inverter also receives the monitoring data from each power optimizer and transmits it to a central server (the SolarEdge monitoring portal; requires Internet connection).

## SolarEdge Monitoring Portal

---

The SolarEdge monitoring portal enables monitoring the technical and financial performance of one or more SolarEdge sites. It provides past and present information on the system performance both at the system and module levels.

## Installation Procedure

---

The following is the procedure for installing and setting up a new SolarEdge site. Many of these also apply to modification of an existing site.

1. [Connecting Power Optimizers in Strings](#), page 13
2. [Recording power optimizer serial numbers \(optional\)](#), page 25
3. [Mounting the inverter](#), Page 16
4. [Connecting the AC and the Strings to the Inverter](#), page 18.
5. [Commissioning and activating the installation](#), page 21.
6. [Connecting the inverter to the SolarEdge monitoring portal](#), page 26.
7. [Configuring the inverter](#), page 27

## Installation Equipment List

---

Standard tools can be used during the installation of the SolarEdge system. The following is a recommendation of the equipment needed for installation:

- Allen screwdriver for M5/M6/M8 screw types
- Standard flat-head screwdrivers set
- Non-contact voltage detector
- Cordless drill or screwdriver and bits suitable for the surface on which the inverter will be installed
- Suitable hardware for attaching the inverter mounting bracket to the surface to which it will be connected
- M6 (1/4") or M8 (5/16") stainless bolts, nuts, and washers for attaching the power optimizer to the racking (not required for smart modules)
- MC4 crimper
- Wire cutters
- Wire strippers
- Voltmeter

For installing the communication options, you may also need the following:

- For Ethernet:
  - CAT5/6 twisted pair Ethernet cable with RJ45 connector.
  - If using a CAT5/6 cable spool: RJ45 plug and RJ45 crimper
- For RS485:
  - Four- or six-wire shielded twisted pair cable.
  - Watchmaker precision screwdriver set

## Inverter Transport and Storage

---

Transport the inverter in its original packaging, facing up and without exposing it to unnecessary shocks. If the original package is no longer available, use a similar box that can withstand the weight of the inverter (refer to the inverter weight in the specification datasheet provided with the unit), has a handle system and can be closed fully.

Store the inverter in a dry place where ambient temperatures are -25°C - +65°C / -13°F - 149°F.

# Chapter 2: Installing the Power Optimizers

## Safety

The following notes and warnings apply when installing the SolarEdge power optimizers. Some of the following may not be applicable to smart modules:

**WARNING!**

When modifying an existing installation, turn OFF the inverter ON/OFF switch and the AC circuit breaker on the main AC distribution panel.

**WARNING!**

Input and output connectors are not watertight until mated. Open connectors should be mated to each other or plugged with appropriate watertight caps.

**CAUTION!**

Power optimizers are IP65/NEMA4 rated. Choose a mounting location where optimizers will not be submerged in water.

**CAUTION!**

This unit must be operated according to the operating specifications provided with the unit.

**CAUTION!**

Cutting the power optimizer input or output cable connector is prohibited and will void the warranty.

**CAUTION!**

All PV modules must be connected to a power optimizer.

**CAUTION!**

If you intend to mount the optimizers directly to the module or module frame, first consult the module manufacturer for guidance regarding the mounting location and the impact, if any, on module warranty. Drilling holes in the module frame should be done according to the module manufacturer instructions.

**CAUTION!**

Installing a SolarEdge system without ensuring compatibility of the module connectors with the optimizer connectors may be unsafe and could cause functionality problems such as ground faults, resulting in inverter shut down. In order to ensure mechanical compatibility of the SolarEdge optimizers and the modules to which they are connected, use identical connectors from the same manufacturer and of the same type on both the power optimizers and on the modules.

**IMPORTANT SAFETY FEATURE**

Modules with SolarEdge power optimizers are safe. They carry only a low safety voltage before the inverter is turned ON. As long as the power optimizers are not connected to the inverter or the inverter is turned OFF, each power optimizer will output a safe voltage of 1V.

## Installation Guidelines

- The steps in this chapter refer to module add-on power optimizers. For smart modules, start from *Step 3: Connecting Power Optimizers in Strings* on page 13. Also refer to the documentation supplied with the smart modules.
- The power optimizer can be placed in any orientation.
- Position the power optimizer close enough to its module so that their cables can be connected.

- To allow for heat dissipation, maintain a 2.5 cm/ 1" clearance distance between the power optimizer and other surfaces.
- The minimum and maximum string length guidelines are stated in the power optimizer datasheets.
- Refer to the SolarEdge Site Designer for string length verification. The SolarEdge Site Designer is available on the SolarEdge website at <http://www.solaredge.com/groups/support/downloads>, under Software Tools.
- Completely shaded modules may cause their power optimizers to temporarily shut down. This will not affect the performance of the other power optimizers in the string, as long as the minimum number of unshaded power optimizers connected in a string of modules is met. If under typical conditions fewer than the minimum optimizers are connected to unshaded modules, add more optimizers to the string.
- Do not leave the power optimizers connectors disconnected. Open connectors should be mated to each other.

**NOTE**

The images contained in the following sections are for illustrative purposes only and may vary depending on product models.

## Step 1: Mounting the Power Optimizers

For each of the power optimizers<sup>1</sup>:

1. Determine the power optimizer mounting location and use the power optimizer mounting brackets to attach the power optimizer to the support structure. For frame-mounted power optimizers follow the instructions supplied with the optimizers.
2. If required, mark the mounting hole locations and drill the hole.

**CAUTION!**

Do not drill through the power optimizer or through the mounting holes. The drilling vibrations can damage the power optimizer and will void the warranty.

3. Attach each power optimizer to the rack using the M6 (1/4") stainless steel bolts, nuts and washers. Apply torque of 9.5 N\*m / 7 lb\*ft.
4. Verify that each power optimizer is securely attached to the supporting structure or the module.

**NOTE**

Record power optimizer serial numbers and locations, as described in *Providing Installation Information* on page 25.

## Step 2: Connecting a PV Module to a Power Optimizer

For each of the power optimizers<sup>2</sup>:

- Connect the Plus (+) output connector of the module to the Plus (+) input connector of the power optimizer.
- Connect the Minus (-) output connector of the module to the Minus (-) input connector of the power optimizer.

<sup>1</sup>Not applicable to smart modules.

<sup>2</sup>Not applicable to smart modules.

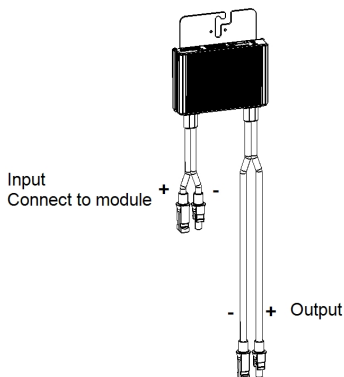

Figure 1: Power optimizer connectors



**NOTE**

Images are for illustration purposes only. Refer to the label on the product to identify the plus and minus input and output connectors.

### Step 3: Connecting Power Optimizers in Strings

You can construct parallel strings of unequal length, that is, the number of power optimizers in each string does not have to be the same. The minimum and maximum string lengths are specified in the power optimizer datasheets. Refer to the SolarEdge Site Designer for string length verification.



**NOTE**

The total cable length of the string (excluding power optimizers' cables) should not exceed 1000ft./300m from DC+ to DC- of the inverter.

Use at least 11 AWG/ 4 mm<sup>2</sup> DC cables.

1. Connect the Minus (-) output connector of the string's first power optimizer to the Plus (+) output connector of the string's second power optimizer.
2. Connect the rest of the power optimizers in the string in the same manner.

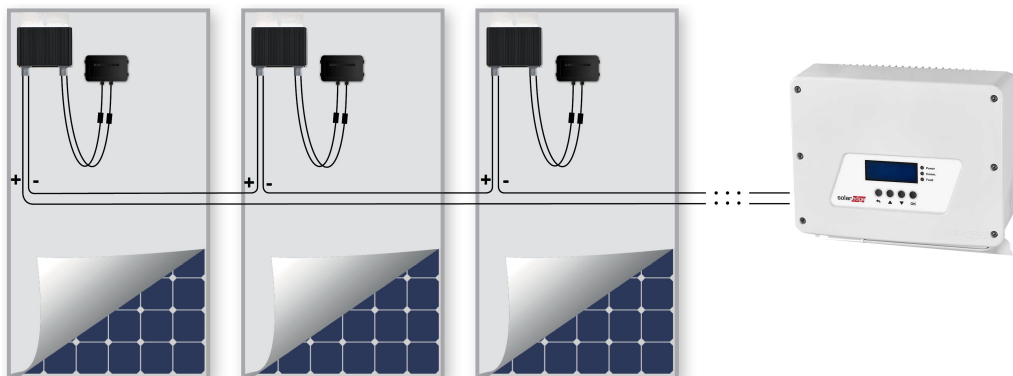

Figure 2: Power optimizers connected in series

- If you intend to monitor the installation, using the SolarEdge monitoring portal, record the physical location of each power optimizer, as described in *Providing Installation Information* on page 25.

**WARNING!**

Input and output connectors are not watertight until mated. Open connectors should be mated to each other or plugged with appropriate watertight caps.

## Step 4: Verifying Proper Power Optimizer Connection

After a module is connected to a power optimizer, the power optimizer outputs a safe voltage of 1V. Therefore, the total string voltage should be equal to 1V times the number of power optimizers connected in series in the string. For example, if 10 power optimizers are connected in a string, then 10V should be produced.

Make sure the modules are exposed to sunlight during this process; otherwise, the power optimizers may not be powered. If you use a tracker, the power optimizer will turn ON only if the tracker is tracking the sun and the module provides at least 2W.

In SolarEdge systems, due to the introduction of power optimizers between the PV modules and the inverter, the short circuit current  $I_{SC}$  and the open circuit voltage  $V_{OC}$  hold different meanings from those in traditional systems.



For more information about the SolarEdge system's string voltage and current, refer to the  $V_{OC}$  and  $I_{SC}$  in *SolarEdge Systems Technical Note*, available on the SolarEdge website at:

[http://www.solaredge.com/files/pdfs/isc\\_and\\_voc\\_in\\_solaredge\\_systems\\_technical\\_note.pdf](http://www.solaredge.com/files/pdfs/isc_and_voc_in_solaredge_systems_technical_note.pdf).

### ► To verify proper power optimizers connection:

Measure the voltage of each string individually before connecting it to the other strings or to the inverter. Verify correct polarity by measuring the string polarity with a voltmeter. Use a voltmeter with at least 0.1V measurement accuracy.

For troubleshooting power optimizer operation problems, refer to *Power Optimizer Troubleshooting* on page 54.

## Chapter 3: Installing the Inverter

Install the inverter either before or after the modules and power optimizers have been installed.



### CAUTION!

Do not rest the connectors at the bottom of the inverter on the ground, as it may damage them. To rest the inverter on the ground, lay it on its back.

## Inverter Package Contents

- One SolarEdge inverter
- Mounting bracket kit
- Installation guide (with activation card and instructions)
- For built-in wireless communication, antenna
- AC ferrite bead kit

## Identifying the Inverter

Refer to the sticker on the inverter that specifies its **Serial Number** and its **Electrical Ratings**. Provide the serial number when contacting SolarEdge support. The serial number is also required when opening a new site in the SolarEdge monitoring portal.

## Inverter Interfaces

The following figure shows the inverter connectors and interfaces.

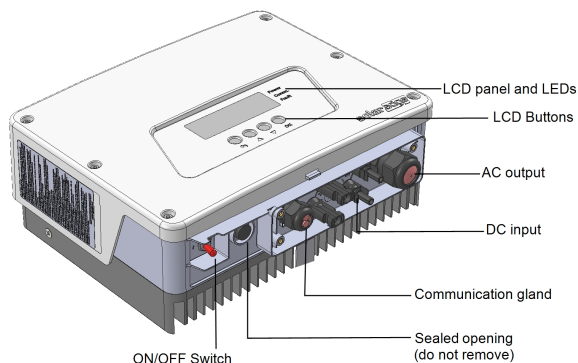

**Figure 3: Inverter Interfaces**

- **AC output:** For connection of the AC grid
- **DC inputs:** For connection of the PV installation
- **ON/OFF switch:** Turning this switch ON starts the operation of the power optimizers, enables power production and allows the inverter to begin exporting power to the utility grid. Turning it OFF reduces the power optimizer voltage to a low safety voltage and inhibits exportation of power. When this switch is OFF, the inverter control circuitry remains powered up.
- **LCD buttons:** Used for accessing configuration menu options and displaying status screens, as described in *User Interface* on page 27. Pressing these buttons produces beeping sounds and lights up the LCD for 30 seconds.
- **A communication gland,** for connection of inverter communication options. Refer to *Setting Up Communication* on page 41 for more information.



- **LCD panel:** displays inverter information and configuration parameters
- **LCD LEDs:** three LEDs indicate the following inverter statuses:

Color	Description	Functionality
Green	Power production	<p><b>On</b> - The inverter is producing power.</p> <p><b>Blinking</b> - Standby mode. The inverter is in Standby mode until its working voltage is reached. The inverter then enters Production mode and produces power.</p> <p><b>Off</b> - The inverter is not producing power. This may be during Night mode, when the inverter ON/OFF switch is OFF or when an error occurs.</p>
Yellow	Communication and inverter shutdown	<p><b>Blinking:</b></p> <ul style="list-style-type: none"> <li>○ Monitoring information is being received from a power optimizer.</li> <li>○ The inverter is being shut down.</li> </ul>
Red	Fault	<p><b>On</b> - There is an error. Refer to <i>Errors and Troubleshooting</i> on page 49 for more information.</p> <p><b>Blinking</b> - The inverter is being shut down.</p>

All LEDs turn on while the inverter is being configured.

## Mounting the Inverter

The mounting brackets kit includes the following parts:

- Two brackets for mounting on a wall/pole (screws not included)
- Two screws with washers for fastening the inverter brackets to the wall brackets.

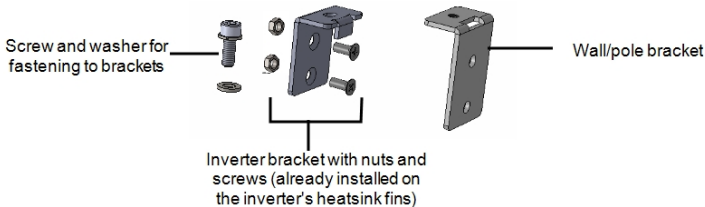

Figure 4: Mounting brackets and screws



### NOTE

Make sure the mounting surface or structure can support the weight of the inverter.

1. Determine the inverter mounting location, on a wall, stud framing or pole. To allow proper heat dissipation, maintain the following minimum clearance areas between the inverter and other objects:
  - If installing a single inverter:
    - 20 cm (8") to the top of the inverter.
    - At least 10 cm (4") to the bottom of the inverter.
    - 10 cm (4") to the right and left of the inverter.
  - If installing multiple inverters:
    - When installing inverters one above of the other, leave at least 40 cm (16") between inverters.

- The inverter brackets are attached to the designated heatsink fins ready for wall mounting. For installation on a pole, remove the two brackets and attach them to the central heatsink fin one below the other (do not over tighten so the bracket height can be adjusted).

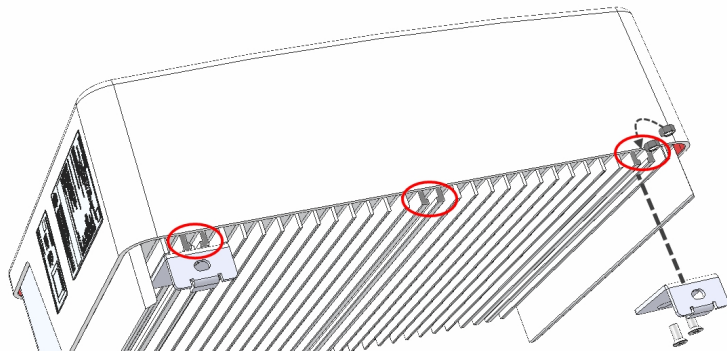

**Figure 5: Mounting the inverter brackets**

- Position the wall mounting brackets against the wall/pole and mark the drilling hole locations (refer to *Mechanical Specifications* on page 58 for inverter and mounting bracket dimensions).
- Drill the holes and mount the brackets. Verify that the bracket is firmly attached to the mounting surface.
- Hang the inverter on the bracket : Lift the inverter from the sides, or hold it at the top and bottom of the inverter to lift the unit into place. Lower the inverter so that the notches on the inverter brackets are inserted in the holes of the wall brackets, as shown below.

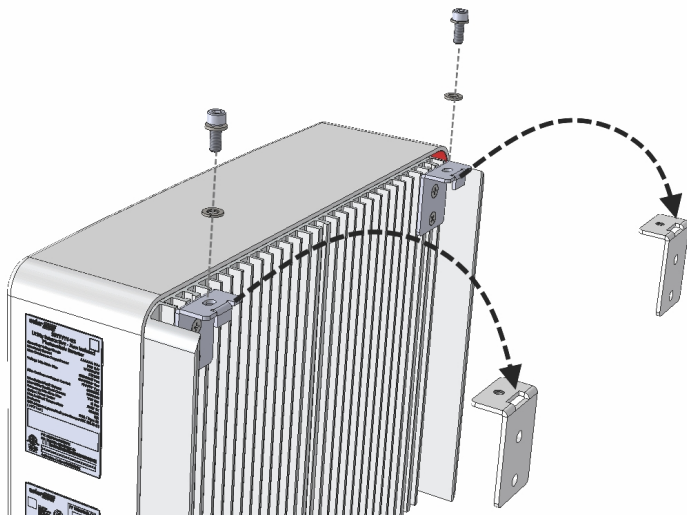

**Figure 6: Hanging the inverter on the bracket**

- Insert the screws at the top of the inverter brackets and fasten the two brackets together.
- Verify that the brackets are firmly attached to the mounting surface.

# Chapter 4: Connecting the AC and the Strings to the Inverter

Refer to *Technical Specifications* on page 55 for inverter specifications.

## Connecting the AC Grid to the Inverter

The AC output gland can fit an AC cable external gauge of PG21 (9-16mm diameter).

The maximum wire size for the input terminal blocks is 16mm<sup>2</sup>.

For more wiring information refer to the *SolarEdge Recommended AC Wiring Application Note*, available on the SolarEdge website at

<http://www.solaredge.com/files/pdfs/application-note-recommended-wiring.pdf>.



1. Turn OFF the AC circuit breaker.
2. Open the inverter cover: Release the six Allen screws and carefully move the cover horizontally before lowering it.



### CAUTION!

When removing the cover, make sure not to damage internal components. SolarEdge will not be held responsible for any components damaged as a result of incautious cover removal.

3. Strip 58 mm / 2.32" of the external cable insulation and strip 8 mm / 0.32" of the internal wire insulation.

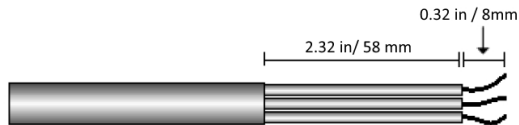

Figure 7: Insulation stripping – AC (3-wire cable)

4. Open the AC cable gland and insert the cable through the gland (see *Figure 3*).



### WARNING!

Turn OFF the AC before connecting the AC terminals. If connecting equipment grounding wire, connect it before connecting the AC Line and Neutral wires.

5. Insert the AC cable through the supplied Ferrite bead.
6. Connect the AC wires according to the labels on the terminal block.

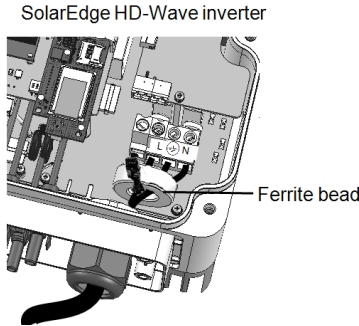

**Figure 8: AC connection**

7. Tighten the screws of each terminal with a torque of 1.2-1.5 N\*m / 0.88-1.1 lb\*ft.
8. Check that the wires are fully inserted and cannot be pulled out easily.
9. Tighten the AC cable gland with a torque of 2.8-3.3 N\*m / 2.0-2.4 lb\*ft.
10. Verify that there are no unconnected wires to the inverter and that the unused terminal screws are tightened.

## Connecting the Strings to the Inverter

Connect the string to the DC input pairs. If required, connect additional strings in parallel using an external combiner box/branch cables before connecting to the inverter.



**NOTE**

Functional electrical earthing of DC-side negative or positive poles is prohibited because the inverter has no transformer. Grounding (earth ground) of module frames and mounting equipment of the PV array modules is acceptable.



**NOTE**

SolarEdge's fixed input voltage architecture enables the parallel strings to be of different lengths. Therefore, they do not need to have the same number of power optimizers, as long as the length of each string is within the permitted range.

Connect the DC connectors of each string to the DC+ and DC- connectors according to the labels on the inverter.

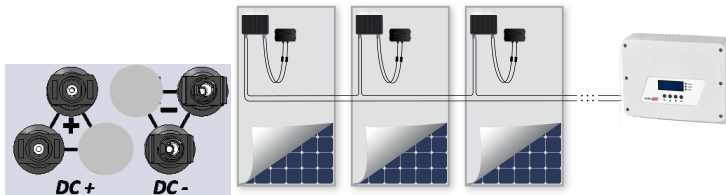

**Figure 9: Inverter DC Connections**

## Selecting a Residual Current Device (RCD)

### IMPORTANT SAFETY FEATURE



All SolarEdge inverters incorporate a certified internal Residual Current Device (RCD) in order to protect against possible electrocution and fire hazard in case of a malfunction in the PV array, cables or inverter. There are 2 trip thresholds for the RCD as required for certification (DIN VDE 0126-1-1). The default value for electrocution protection is 30 mA, and for slow rising current is 300 mA.

If an external RCD is required by local regulations, check which type of RCD is required for the relevant electric code. SolarEdge recommends using a type-A RCD. The recommended RCD value is 100mA or 300mA unless a lower value is required by the specific local electric codes. When required by local regulations, the use of an RCD type B is permitted.



### NOTE

For multiple inverters, an RCD per inverter is required.

In installations where the local electric code requires an RCD with a lower leakage setting, the discharge current might result in nuisance tripping of the external RCD. The following steps are recommended to avoid nuisance tripping of the external RCD:

- Select the appropriate RCD for correct operation of the installation: An RCD with a rating of 30mA may actually trip at a leakage as low as 15mA (according to IEC 61008). High quality RCDs will typically trip at a value closer to their rating.
- Configure the trip voltage of the inverter' internal RCD to a lower value than the trip current of the external RCD. The internal RCD will trip if the current is higher than the allowed current, but because the internal inverter RCD automatically resets when the residual currents are low it saves the manual reset.

For detailed information, refer to the RCD Selection for SolarEdge Inverters Application Note, available on the SolarEdge website at <http://www.solaredge.com/files/pdfs/se-application-rcd-selection.pdf>.



## Chapter 5: Commissioning the Installation

This chapter describes how to activate the system, pair the power optimizers to the inverter and verify the proper functioning of the system.

### Step 1: Activating the System

1. Verify that the inverter ON/OFF switch is OFF.
2. If not already removed, remove the inverter cover: Open the inverter cover's six Allen screws and carefully pull the cover horizontally before lowering it.



#### WARNING!

ELECTRICAL SHOCK HAZARD. Do not touch uninsulated wires when the inverter cover is removed.

3. Activate the inverter:
  - a. Verify that the card S/N matches the inverter S/N.
  - b. Insert the card into the slot marked "CARD" on the communication board.
  - c. Turn AC ON.
  - d. LCD shows: `Running Script...` → Done!

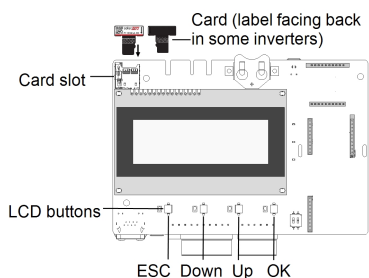

Figure 10: Communication board and activation card

If LCD shows: `Failed`:

- Turn AC OFF and ON (reset), and repeat the activation process.
- Use the activation code that appears on the certification inverter label to manually activate the inverter.
- If the problem persists, contact SolarEdge Support.



#### NOTE

You can use the activation code that appears on the certification inverter label to activate the inverter in case of a script error or a missing activation card.

4. Verify that the inverter is configured to the proper country: Press the up or down buttons until reaching the ID status screen:

```
DSP1/2:1.0210/1.0034
CPU:0003.14xx
Country:ESP
```

5. If required, perform the following additional steps before closing the inverter cover:

- Country settings or inverter configuration using the internal LCD user buttons – refer to *Country and Grid* on page 31.
  - Communication options connection – refer to *Setting Up Communication* on page 41.
6. Close the inverter cover by tightening the screws with a torque of 9.0 N\*m/ 6.6 lb\*ft.
  7. If an additional external DC switch is installed between the power optimizers and the inverter(s) then turn it ON.

A status screen similar to the following appears on the LCD panel:

```
Vac [ V ]   Vdc [ V ]   Pac [ w ]
240.7      14.1      0.0
P_OK : 000 / 000 < S_OK >
                OFF
```

8. Verify that the following information appears on the LCD panel:
  - **P\_OK**: Appears only upon pairing process completion and first telemetry reception from the power optimizers. Indicates connection to the power optimizers and that at least one power optimizer is sending monitoring data. If P\_OK does not appear, check the power optimizer, string and DC input connections.
  - **000/000**: Appears only upon first telemetry reception from the power optimizers. Indicates the number of power optimizers that have been paired to this inverter. At this stage, the number should be 000, since no power optimizers have been paired.
  - **S\_OK**: the connection to the SolarEdge monitoring portal is successful (should appear only if the inverter is connected to the server). If S\_OK is not displayed and the inverter is connected to the server, refer to *Errors and Troubleshooting* on page 49.
  - **Vac [V]**: the grid AC output voltage. Verify the correct value.
  - **Vdc [V]**: The DC input voltage of the longest string connected to the inverter. There should be a safety voltage of 1V for each power optimizer in the string.



#### NOTE

A measurement error on the inverter LCD of  $\pm 3$  V is acceptable.

- **Pac [w]**: the AC output power (should be **0.0** since the inverter is OFF).
- **OFF**: the inverter ON/OFF switch is in the OFF position.

## Step 2: Pairing Power Optimizers to the Inverter

Once all connections are made, all the power optimizers must be logically paired to their inverter. The power optimizers do not start producing power until they are paired with an inverter. This step describes how to assign each inverter to the power optimizers from which it will produce power.

Perform this step when the modules are exposed to sunlight. If the string length is changed or a power optimizer is replaced, repeat the pairing process.

1. Perform pairing: Press and hold down the inverter LCD OK button (rightmost on the communication board; see *Figure 10*) for about **10 seconds**. The following message is displayed:

```
Keep holding button
for pairing, release
to enter menu...
Remaining: 3 sec
```

Keep holding for 5 seconds until the following is displayed:

```
Pairing
Turn Switch To On
```

2. Turn the inverter ON/OFF switch to ON within 5 seconds. If you wait longer than 5 seconds the inverter exits the pairing mode. The following message is displayed indicating that the inverter is performing the pairing:

```
Pairing
Remaining [sec]:180
```

3. Wait for the completion of the pairing (remaining seconds is 0). If pairing fails, an error is displayed. In this case, repeat the pairing steps, and refer to *Power Optimizer Troubleshooting* on page 54. If the problem persists, contact SolarEdge Support. When pairing succeeds, the following message is displayed:

```
Pairing
Pairing Completed
```

4. Upon pairing completion, the inverter continues with assigning numbers to the power optimizers and mapping them into strings:
  - *Power optimizer detection* - the power optimizer IDs are detected and each optimizer is assigned a unique number, which is later used by the inverter for synchronizing telemetries. This detection is performed while the optimizers are in safe voltage.
  - *String detection* - During this procedure the logical string of each optimizer is detected. This detection is performed while some optimizers are set to MaxVout mode.

The detection and assignment of power optimizers may take up to 2 minutes.

The system startup process begins:

Since the inverter is ON, the power optimizers start producing power and the inverter starts converting AC.



#### WARNING!

When you turn ON the inverter ON/OFF switch, the DC cables carry a high voltage and the power optimizers no longer output a safe 1V output.

When the inverter starts converting power after the initial connection to the AC, the inverter enters Standby mode until its working voltage is reached. This mode is indicated by the flickering green inverter LED.

While the inverter is in Standby mode, it monitors the grid and verifies correct grid voltage and frequency. The following message is displayed:

```
Waking Up...
Remaining: 051 Sec
```

The countdown indicates the seconds remaining until entering the Production mode. This time is in accordance with local regulations and is typically between three to five minutes.

When countdown is complete, the inverter enters Production mode and produces power. The steadily lit green inverter LED indicates this mode.



## Step 3: Verifying Proper Operation

After the wake-up time is over, a status screen similar to the following appears on the inverter LCD panel:

```
Vac [ V ]   Vdc [ V ]   Pac [ W ]
240 . 7   371 . 9   2349 . 3
P_OK : XXX / YYY <S_OK>
                ON
```

- Verify the following:
  - The green inverter LED is steadily lit.
  - The ON/OFF indicator on the LCD panel reads **ON**.
  - P\_OK: XXX/YYY**: There is a connection to the power optimizers and at least one power optimizer is sending monitoring data. Optimizers send telemetries in a frequency of up to 10 minutes.
  - S\_OK** appears, if the inverter is connected to the SolarEdge monitoring portal.
  - Vac [V]** specifies the measured grid AC output voltage.
  - Vdc [v]** : Specifies the DC input voltage, which should equal the sum of the output voltages of all modules (and should be within the operating range of the inverter).
  - Pac [W]** specifies the AC output power produced.
- Take note of the serial # on the inverter label using the detachable 2D barcode sticker on each device. This information is used in the SolarEdge monitoring portal to identify this inverter and is needed to open a new site in the monitoring portal.

Your SolarEdge power harvesting system is now operational.

## Step 4: Reporting and Monitoring Installation Data



### NOTE

This step requires connecting one of the communication options. Refer to *Setting Up Communication* on page 41.

## The SolarEdge Monitoring System

The SolarEdge cloud-based monitoring platform (monitoring portal) enables accessing SolarEdge site information, including up-to-date information viewed in a physical or logical view. The monitoring portal is described in detail in the *SolarEdge Monitoring Portal User Guide*, available on the SolarEdge website at <http://www.solaredge.com/files/pdfs/solaredge-monitoring-portal-user-guide.pdf>. The SolarEdge monitoring portal can display logical and physical layouts of the installed system, as follows:



- Logical Layout:** Shows a schematic logical layout of the components in the system, such as: inverters, strings and modules, as well as their electrical connectivity. This view enables you to see which modules are connected in each string, which strings are connected to each inverter, and so on.
- Physical Layout:** Shows a schematic physical layout of the components in the system, such as: inverters, strings and modules, as well as their electrical connectivity. This view enables a bird's eye view of the actual location of a system component.

Using the portal, you can:

- View the latest performance of specific components.
- Find under-performing components, such as modules, by comparing their performance to that of other components of the same type.
- Pinpoint the location of alerted components using the physical layout.
- See how components are connected to each other.
- Pair power optimizers remotely.

To display a logical layout, insert the inverter serial number in the new site created in the application. When the communication between the inverter and the monitoring server is established, the logical layout is displayed.

To display a physical layout, you need to map the locations of the installed power optimizers. To generate a physical mapping, use either the Site Mapper application or a mapping template, which should be filled out using the detachable stickers (see *Providing Installation Information*, below).

The logical and physical mapping can be used for debugging a problem using the SolarEdge monitoring portal.

If you do not report the physical and logical mapping of the installed power optimizers to SolarEdge, the SolarEdge monitoring portal will show the logical layout indicating which power optimizers are connected to which inverter, but will not show strings or the physical location of power optimizers.

The inverter may be connected to the SolarEdge monitoring portal via LAN or via an external modem connected to the inverter's RS232 connector. Alternatively, you can connect the inverter to another inverter that is already connected to the server, in a master-slave configuration. Refer to *Setting Up Communication* on page 41.

## Providing Installation Information

Use one of the following methods to connect your PV system to the SolarEdge cloud-based monitoring platform (monitoring portal).

### Site Mapper Application

#### Android

Use the SolarEdge Site Mapper smart-phone application to scan the power optimizer and inverter 2D bar-codes, and map the system physical layout in the SolarEdge monitoring portal. This application is integrated with the SolarEdge monitoring portal and enables:

- Simple on-site registration of new systems.
- Creating, editing and verifying system physical layout.
- Scanning and assigning the power optimizer serial number to the correct location in the system physical layout.

For detailed information, refer to the *SolarEdge Site Mapper* demo movies:

[Creating new sites using the SolarEdge Site Mapper mobile application](#)



[Mapping power optimizers using the SolarEdge Site Mapper mobile application](#)



### iPhone

Use the SolarEdge Site Mapper smartphone application to scan the power optimizer and inverter 2D barcodes. This application creates an XML file that can be uploaded to the SolarEdge monitoring portal during site registration. The SolarEdge Site Mapper can be downloaded from the application stores.

For detailed information, refer to the *SolarEdge Site Mapper Software Guide* or to the *Site Mapper* demo movie, available on the SolarEdge website at <http://www.solaredge.com/groups/installer-tools/site-mapper>.

### Creating a Site in the SolarEdge Monitoring Portal

Create the site in the monitoring portal using the registration form available at <https://monitoring.solaredge.com/solaredge-web/p/login>. Fill out all required information in the form, which includes information about your installation, as well as details about its logical and physical mapping.



### Paper Template

Fill out the Physical Layout Template (downloadable from the SolarEdge site) using the detachable 2D barcode stickers on each power optimizer. Once the form is completed, scan it and upload the scanned file to the SolarEdge monitoring portal during site registration. For an example paper template, refer to <http://www.solaredge.com/files/pdfs/physical-layout-template.pdf>.



## Chapter 6: User Interface

### LCD User Buttons

Use the four buttons located under the LCD panel for controlling the LCD menus and configuring the inverter. When pressing the buttons, a beeping sound is produced as input confirmation.

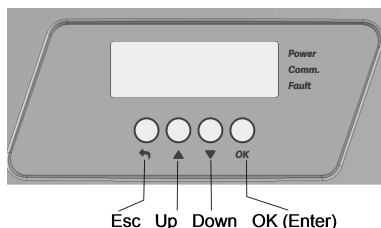

Figure 11: LCD buttons

Use the four user buttons to control the LCD panel menus:

- **Esc**: Moves the cursor (>) to the beginning of the currently displayed parameter; goes to the previous menu, and cancels a value change with a long press (until **Aborted** is displayed).
- **Up** and **Down**: Moves the cursor from one menu option to another, moves among the characters of a displayed parameter, and toggles between possible characters when setting a value.
- **OK (Enter)**: Selects a menu option and accepts a value change with a long press (until **Applied** is displayed).

Use the three rightmost buttons **Up**, **Down** and **OK** sequentially for entering the Setup mode.

The LCD screen displays status information of the system and various menus for configuration options. The LCD panel and buttons are used during the following processes:

- **Operational mode**: The LCD panel allows checking for proper system operation. Refer to *Status Screens - Operational Mode* on page 35 for a description of this option. Use the up and down buttons to toggle through the informative displays.
- **Setup mode**: Upon installation, an installer may perform basic configuration, as described in *Inverter Configuration – Setup Mode* on the next page.
- **Error messages**: In the event of a problem, an error message may be displayed on the LCD panel. For more information, refer to *Errors and Troubleshooting* on page 49 and *Inverter Configuration – Setup Mode* on the next page.

## Inverter Configuration – Setup Mode

After inverter installation, an installer may perform basic system configuration. Configuration is done when the inverter is in Setup mode.

### ▶ To enter Setup mode:

1. Turn the inverter ON/OFF switch to OFF (AC remains ON).

#### WARNING!

If the inverter was operating properly (power was produced by the power optimizers), the following message is displayed.



```
DC VOLTAGE NOT SAFE
DO NOT DISCONNECT
VDC: 72.0
```

This message is displayed until the DC voltage is safe (50V). Do not open the cover until the voltage is safe or until at least five minutes have passed.

2. Press the **OK** button for at least 5 seconds. The following message is displayed:

```
Please enter
Password
*****
```

3. Press the **Up**, **Down** and **OK** buttons (Up=1, Down=2, OK=3) for entering the Setup mode password:  
▲▼ **OK** ▲▼ **OK** ▲▼.

```
Country <Italy>
Language <Eng>
Communication
Power Control
Display
Maintenance
Information
```

The inverter is now in Setup mode and all its LEDs are lit. The inverter automatically exits Setup mode if no buttons are pressed for more than 2 minutes.

The following shows a hierarchical tree of the menu options, which are described in *Configuration Menu Options* on page 31. Actual menus may vary from shown depending on the firmware version of the inverter and on the country.

Main menu:

```
Country <Italy>
Language <Eng>
Communication
Power Control
Display
Maintenance
Information
```

Country:

```
Germany+
Spain
France
.
.
.
```

Language:

```
English
German
Spanish
French
Italian
```

Communication<sup>1</sup>

```
Server<LAN>
LAN Conf
RS485-1 Conf<S>
ZigBee Conf<S>
Wi-Fi Conf<N/A>
RS232 Conf
Cellular Conf
GPIO Conf <MTR>
```

<sup>1</sup>If ZigBee is connected, the Wi-Fi Conf menu is not displayed. If ZigBee is not connected, ZigBee Conf and Wi-Fi Conf are both displayed with <N/A>.

## Power Control:

```
Grid Control <En>
Energy Manager
RRCR Conf.
Reactive Pwr Conf.
Active Pwr Conf.
Phase Balance <Dis>
Wakeup Conf.
P(f)
Advanced
Load Defaults
```

## Display:

```
Temperature <C>
LCD On Time <30>
TLM On Time <15>
```

## Maintenance:

```
Date and Time
Reset Counters
Factory Reset
SW Upgrade SD-Card
AFCI <Dis>
Diagnostics
Standby Mode
Grid Protection
```

## Information:

```
Versions
Error Log
Warning log
Hardware IDs
```

## Configuration Menu Options

This section describes how to use the LCD menus for configuring the inverter.

### Country and Grid

1. Select the **Country** option to specify the country in which the inverter is installed and the grid to which it is connected. This parameter may arrive pre-configured. If so, verify that it is set to the proper country.



#### WARNING!

The inverter must be configured to the proper country in order to ensure that it complies with the country grid code and functions properly with that country grids.

A list of countries is displayed. If no country is configured, the value is <NONE>.



#### NOTE

If an inverter is not configured to any country, it will not produce energy, and the following message will be displayed on the LCD:

No Country Selected

A plus sign (+) near the country indicates that another menu will be displayed after selection.

2. Confirm your country selection in the confirmation screen: Toggle to **YES** and press **Enter**.

### Language

1. Select the **Language** option to set the language in which the LCD should display.
2. Confirm your language selection in the confirmation screen: Toggle to **YES** and press **Enter**.

### Communication

1. Select the **Communication** option to define and configure:
  - The communication option used by the inverter to communicate with the SolarEdge monitoring portal
  - The communication option used to communicate between multiple SolarEdge devices or other external non-SolarEdge devices, such as electricity meters or loggers.
2. Select **Server** to set which communication method is used to communicate between devices and the SolarEdge monitoring portal. Refer to for a full description of these communication options.



#### NOTE

The Server menu shows only the communication options installed in the inverter.

The following shows a hierarchical tree of the menu options in the **Communication** menu.

For detailed information about all the configuration options, refer to the *Communication Options Application Note*, available on the SolarEdge website at

[http://www.solaredge.com/files/pdfs/solaredge-communication\\_options\\_application\\_note\\_v2\\_250\\_and\\_above.pdf](http://www.solaredge.com/files/pdfs/solaredge-communication_options_application_note_v2_250_and_above.pdf).





## Communication1:

```

Server <LAN>
LAN Conf
RS485-1 Conf <S>
ZigBee Conf <S>
Wi-Fi Conf <N/A>
RS232 Conf
Cellular Conf
GPIO Conf <MTR>

```

## Server:

```

LAN
RS485
Zigbee
Wi-Fi
Cellular
RS232
None

```

## LAN Conf:

```

IP Config
Set DHCP <en>
Set IP
Set Mask
Set Gateway
Set DNS
Set Server Addr
Set Server Port

```

## RS485-1 Conf:

```

Device Type <SE>
Protocol <M>
Device ID <1>
Slave Detect <#>
Slave List <#>

```

## ZigBee Conf. (enabled only if the ZigBee internal module is connected):

```

Device Type <SE>
Protocol <MPS>
Device ID <1>
PAN ID
Scan Channel
Load ZB Defaults

```

<sup>1</sup>If ZigBee is connected, the Wi-Fi Conf menu is not displayed. If ZigBee is not connected, ZigBee Conf and Wi-Fi Conf are both displayed with <N/A> and their menus are not accessible.

Wi-Fi Conf (enabled only if the internal module is connected):

```
Scan Networks
Set key
Load Defaults
```

RS232 Conf:

```
Device Type <SE>
Protocol <GSM>
Set APN
Set Modem Type
Set User Name
Set Password
```

GPIO Conf:

```
Device Type <RRCR>
```

## Power Control

For detailed information about active and reactive power control options refer to the *Power Control Application Note*, available on the SolarEdge website at [http://www.solaredge.com/files/pdfs/application\\_note\\_power\\_control\\_configuration.pdf](http://www.solaredge.com/files/pdfs/application_note_power_control_configuration.pdf).



```
Grid Control <En>
Energy Manager
RRCR Conf.
Reactive Pwr Conf.
Active Pwr Conf.
Phase Balance <Dis>
Wakeup Conf.
P (f)
Advanced
Load Defaults
```

The Grid Control option is disabled by default. Enabling it opens additional options in the menu, as shown on page 29.

## Display

Select **Display** to set the following:

```
Temperature <C>
LCD On Time <30>
TLM On Time <15>
```

- **Temperature:** Select Celsius or Fahrenheit units.
- **LCD On Time <30>:** The number of seconds that the LCD backlight is ON after pressing the LCD light button. Set a value within the range of 10-120 seconds.
- **TLM On Time <15>:** The number of minutes that the LCD backlight is ON while viewing the Telemetry window. Set a value within the range of 1-120 minutes.

## Maintenance

Select **Maintenance** to set the following options:

```
Date and Time
Reset Counters
Factory Reset
SW Upgrade SD-Card
AFCI <Dis>
Diagnostics
Standby Mode
Grid Protection
```

- **Date and Time:** Set the internal real-time clock. If connected to the SolarEdge monitoring portal, the date and time are set automatically and only time zone should be set.
- **Reset Counters:** Resets the accumulated energy counters that are sent to the SolarEdge monitoring portal
- **Factory Reset:** Performs a general reset to the default device settings.
- **SW Upgrade SD-Card:** Perform a software upgrade using an SD card.
- **Diagnostics:** Displays the Isolation Status and optimizers status screens. Refer to [www.solaredge.com/files/pdfs/application\\_note\\_isolation\\_fault\\_troubleshooting.pdf](http://www.solaredge.com/files/pdfs/application_note_isolation_fault_troubleshooting.pdf).
- **AFCI:** Enables or disables arc-fault self-test.
- **Standby Mode:** Enables/disables Standby Mode - for remote commissioning.
- **Grid Protection:** Available in specific countries. Enables viewing and setting grid protection values. Refer to [http://www.solaredge.com/files/pdfs/viewing\\_grid\\_protection\\_values.pdf](http://www.solaredge.com/files/pdfs/viewing_grid_protection_values.pdf).



## Information

Select **Information** to display the following options:

```
Versions
Error Log
Warning log
Hardware IDs
```

- **Versions:** Displays inverter firmware versions:
  - **ID:** The inverter ID.
  - **DSP 1/2:** The DSP digital control board firmware version
  - **CPU:** The communication board firmware version



### NOTE

Please have these numbers ready when you contact SolarEdge Support.

- **Error Log:** Displays the last five errors.
- **Warning Log:** Displays the last five warnings.

- **Hardware IDs:** Displays the following HW serial numbers (if exist, and connected to the inverter):
  - **ID:** the inverter's ID
  - **RGM1:** Modbus meter (with lower Modbus ID)
  - **RGM2:** A second external Modbus meter (with the higher Modbus ID)
  - **ZB:** Zigbee MAC address
  - **Cell:** MEID (CDMA) or IMEI (GSM)
  - **WiFi:** Wi-Fi MAC address

## Status Screens - Operational Mode

During normal operation pressing the LCD buttons turns on the LCD backlight.

Additional presses display the following screens one after the other.

### Initial Status

```
Vac [ V ]   Vdc [ V ]   Pac [ W ]
240.7      371.9      2349.3
P_OK :   X X X / Y Y Y   < S _ O K >
                                O N
```

- **Vac [V]:** The AC output voltage
- **Vdc [V]:** The DC input voltage
- **Pac [W]:** The AC output power

### Main Inverter Status

```
Vac [ V ]   Vdc [ V ]   Pac [ W ]
240.7      371.9      3210.0
Fac [ Hz ]   OPs _ Ok   Temp
50.0          11         28.2
```

- **Vac [V]:** The AC output voltage.
- **Vdc [V]:** The DC input voltage.
- **Pac [W]:** The AC output power.
- **Fac [Hz]:** The AC output frequency.
- **OPs\_Ok:** Number of optimizers sending telemetries (indicating that they are paired)
- **Temp [C or F]:** The inverter heat sink temperature

## Energy Meter Status

Displays the total energy produced during the last day, month, year and since inverter installation.

```
Day [ Wh ] :      0 . 0
Month [ kWh ] :   0 . 0
Year [ kWh ] :    0 . 0
Total [ kWh ] :   0 . 0
```

If a meter is connected to the inverter, the following status screen, showing the power and energy readings, is displayed instead of the above screen.

If the meter is set to Export +Import, there are two status screens, with the first line displaying: "Export Meter" or "Import Meter". The following is an example of an export meter status:

```
Export Meter
Status :      <OK / Error# >
Power [ W ] :      xxxxxx . x
Energy [ Wh ] :    xxxxxx . X
```

- **Status:** Displays OK if the meter is communicating with the communication board.
- **<Error message>:** If there is a meter error, it is displayed in this line.
- **Power (W):** Depending on the meter type connected to the inverter, this line displays the exported or imported power in Watts.
- **Energy (Wh):** The total energy read by the meter, in Watt/hour. The value displayed in this line depends on the meter type connected to the inverter and its location:
  - If a bidirectional meter is connected at the consumption point, this value is the consumed energy.
  - If the meter is installed at the production connection point, this value is the energy produced by the site.
  - If the meter is installed at the grid connection point, this value is the energy exported to the grid.

If the inverter is connected to the SolarEdge server, this value will also be displayed in the monitoring portal.



### NOTE

This data is accumulated according to an internal real-time clock.

## Telemetry Status

This screen displays the last power optimizer telemetry received. The display changes as each power optimizer sends its telemetry.

In order to verify proper installation, the installer may view the Telemetry window for some time in order to observe the power optimizers' report process.

```
Module : 10288063 1B
Energy [ Wh ] : 56.7
Vdc_O [ V ] : 40.0
Vdc_I [ V ] : 38.3
I_in [ A ] : 7.8
Temp [ C ] : 28.0
```

- **Module:** Power optimizer serial number
- **Energy:** power optimizer energy

- **Vdc\_O**: Power optimizer output voltage
- **Vdc\_I**: Power optimizer input voltage (module voltage)
- **I\_in**: Power optimizer input current
- **Temp**: Power optimizer temperature

## ID Status

This screen displays the inverter software version and the country to which the inverter is configured.

```
DSP1 / 2 : 1 . 0 2 1 0 / 1 . 0 0 3 4
CPU : 0 0 0 3 . 1 4 x x
Country : ESP
```

- **ID**: The inverter ID.
- **DSP 1/2**: The DSP digital control board firmware version
- **CPU**: The communication board firmware version
- **Country**: the current country setting

## Server Communication Status

```
Server : LAN <S_OK>
Status : <OK>
xxxxxxx
<ERROR MESSAGE>
```



### NOTE

If the connection method is CDMA (Cellular) or GSM, the server screen is replaced with the Cellular or GSM status screens (see *Status Screens - Operational Mode* on page 35 and *GSM Status* on the next page).

- **Server**: The method of connection to the SolarEdge monitoring portal.
- **S\_OK**: The connection to the SolarEdge monitoring portal is successful (should appear only if the inverter is connected to the server).
- **Status**: Displays OK if the inverter established successful connection and communication with the specified server port/device (LAN, RS485, Wi-Fi or ZigBee module).
- **xxxxxxx**: Eight-bit Ethernet communication connection status: A string of 1s and 0s is displayed. 1 indicates OK, 0 indicates an error.
- **Error message**, according to failure.

## IP Status

This screen describes the Ethernet configuration: IP, Mask, Gateway and MAC address (Media Access Control) of the Inverter.

```
IP 192 . 1 6 8 . 2 . 1 1 9
MSK 255 . 255 . 255 . 0
GW 192 . 1 6 8 . 2 . 1
MAC 0 - 2 7 - 0 2 - 0 0 - 3 9 - 3 6
```

## ZigBee Status

This screen describes the ZigBee configuration:

```
PAN : XXXXX
CH : XX / XXXX  RSSI : <L>
MID : XXXX  XX
```

- **RSSI:** The receive signal strength indication of the closest ZigBee in the system. L = low, M = medium, H = high and (-) = no signal.
- **PAN ID:** The ZigBee transceiver PAN ID
- **Ch.:** The ZigBee transceiver channel
- **ID:** The ZigBee transceiver ID
- **MID:** The Master ID of the coordinator (master) ZigBee module. This field is shown only in devices with router (slave) ZigBee modules, and after a successful ZigBee association. If a ZigBee module is not connected, a **No ZigBee** message is displayed instead of the **MID** field.

## Wi-Fi Status

This screen describes the Wi-Fi configuration:

```
IP : 192.168.2.119
GW : 192.168.2.1
SSID : xxxxxxxx
RSSI : <L/M/H/->
```

- **IP:** The DHCP provided address
- **GW:** The gateway IP address
- **SSID:** Service Set Identifier - the name of a wireless local area network (WLAN). All wireless devices on a WLAN must employ the same SSID in order to communicate with each other.
- **RSSI:** The receive signal strength indication of the closest Wi-Fi in the SolarEdge system. L = low, M = medium, H = high and - = no signal.

## GSM Status

If a GSM modem is connected, this screen replaces the Server status screen:

```
Server : Cell   <S_OK>
Status :          <OK>
MNO : <xxxxxxx>  Sig : 5
<Error message>
```

- **Server:** The method of communication to the SolarEdge monitoring portal. Should display **Cell**.
- **Status:** Displays OK if the inverter established a successful physical connection to the modem.
- **S\_OK:** The last communication to the SolarEdge monitoring portal was successful (appears if the inverter is connected to the portal). If S\_OK is not displayed, refer to *Status Screens - Operational Mode* on page 35.
- **MNO:** The mobile network operator name
- **Sig:** The signal strength, received from the modem. A value between 0-5, (0 = no signal, 5 = excellent)

signal).

- **Error message** per communication connection status failure.

## Communication Ports Status

```

      Dev Prot  ##
RS485-1<SE><S> <-->
RS485-2<SE><S> <-->
ZigBee <SE><MPS><-->
    
```

- **##**: The total number of slaves detected on the specific port
- **Dev**: The type of device that was configured to a specific port (based on the port’s functionality), as follows:
  - **SE**: SolarEdge device (default)
  - **LGR**: Non-SolarEdge logger
  - **MLT**: Multiple devices, such as meters and batteries
  - **HA**: Home automation devices (for load management)
- **PROT**: The protocol type to which the port is set:
  - For a SolarEdge device:

RS485 protocol	ZigBee protocol
<b>S</b> : SolarEdge slave	
<b>M</b> : SolarEdge master	
	<b>P2P</b> : ZigBee point-to-point
	<b>MPM</b> : ZigBee multipoint master (for the SolarEdge ZigBee home gateway or for load management by the inverter)
	<b>MPS</b> : ZigBee multipoint slave (for a ZigBee router module)

- For electricity meters, refer to the *application note - Connecting an Electricity Meter to SolarEdge Devices* at <http://www.solaredge.com/files/pdfs/solaredge-meter-installation-guide.pdf>.
- **SS**: SunSpec - for a non-SolarEdge logger (monitoring and control)



## Smart Energy Management Status

This screen is displayed only when Smart Energy Management is enabled. The screen shows energy details of the site:

```

Site Limit:      7.0 kW
Site Prod:       10.0 kW
Site Export:     4.0 kW
Self-consume:   6.0 kW
    
```

- **Site Limit**: The limit that was defined for the site
- **Site Prod**: The power produced by the site
- **Site Export**: The power that is fed into the grid
- **Self-consume**: The PV power consumed by the site



For more information, refer to the *Export Limitation Application Note*, available on the SolarEdge website at [http://www.solaredge.com/files/pdfs/products/feed-in\\_limitation\\_application\\_note.pdf](http://www.solaredge.com/files/pdfs/products/feed-in_limitation_application_note.pdf).



## Power Control Status

This screen is displayed only when Power Control is enabled (available from communication board (CPU) firmware version 2.7xx/3.7xx and later).

```
PWR CTRL: REMOTE
PWR Limit: 10.04 kW
CosPhi: 0.9
Power Prod: 7000W
```

- **PWR CTRL:** The power control status:
  - **REMOTE** - Communication with the RRCR or smart energy manager is confirmed/validated.
  - **LOCAL** - The power is controlled locally (e.g. by a fixed limit), or this inverter limits the PV power production to its relative portion of the feed-in power limit, as a result of disconnected communication with the smart energy manager. If this status appears, check the communication to the smart energy manager or the communication to the meter.
- **PWR Limit:** The inverter maximum output power set by one of the power limiting options:
  - RRCR
  - Smart energy manager (Feed-in limitation)
  - P(f)
  - P(U)
  - Q(U)
- **Cos Phi:** The ratio between active to reactive power
- **Power Prod:** The power produced by the inverter

For more information, refer to the *Power Control Application Note*, available on the SolarEdge website at [http://www.solaredge.com/files/pdfs/application\\_note\\_power\\_control\\_configuration.pdf](http://www.solaredge.com/files/pdfs/application_note_power_control_configuration.pdf).



# Chapter 7: Setting Up Communication

Power optimizers send information to the inverter via the DC power lines (the PV output circuit). The information is sent from the inverter to the SolarEdge monitoring portal through the Internet. In order to send the data from the inverter, a communication connection must be set up, as described in this chapter. Communication setup is not required for power harvesting, however is needed for using the SolarEdge monitoring portal.

This chapter describes setting up communication between multiple inverters for a master/slave configuration.

### CAUTION!



When connecting the communication cables, make sure that the ON/OFF switch at the bottom of the inverter is turned OFF, and the AC is turned OFF. When configuring the communication parameters, make sure that the ON/OFF switch is OFF, and the AC is turned ON.

## Communication Types

- **Ethernet:** used for a LAN connection
- **RS485:** used for the connection of multiple SolarEdge devices on the same bus in a master-slave configuration. RS485 can also be used as an interface to external devices, such as meters and third party data loggers.
- **ZigBee:** optional wireless communication (purchased separately; refer to the supplied manual, also available at <http://www.solaredge.com/groups/products/communication> (under ZigBee).
- **Wi-Fi:** optional wireless connection (purchased separately; refer to the supplied manual, also available at <http://www.solaredge.com/groups/products/communication> (under Wi-Fi).



Only communication products offered by SolarEdge are supported.

## Communication Connectors

A communication gland with multiple openings is used for connection of the various communication options. The table below describes the functionality of each gland opening. Unused openings should remain sealed.

Opening for cable size (diameter)	Connection type
2.5 - 5 mm	RS485
4.5 - 7 mm, with cut	Ethernet (CAT5/6)
2 - 4 mm, with cut	ZigBee or Wi-Fi antenna cable

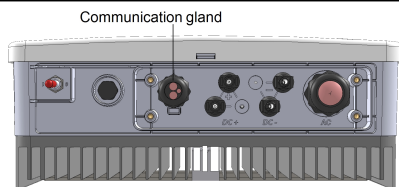
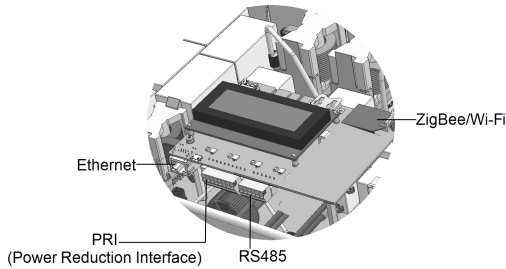

Figure 12: Communication Gland

The communication board has a standard RJ45 terminal block for Ethernet connection, a 6-pin terminal block for RS485 connection, and an 8-pin connector for power control devices.

Additional optional components can be connected to the communication board: the ZigBee or Wi-Fi modules used for optional wireless connections.



**Figure 13: Communication board connectors**

## Removing the Inverter Cover

Use the following procedure for cover removal for communication connection or maintenance.

1. Turn OFF, or verify that the inverter ON/OFF switch is OFF.
2. Verify that AC to the inverter is OFF, or disconnect the AC to the inverter by turning OFF the circuit breakers on the distribution panel. Wait 5 minutes for the capacitors to discharge.
3. Open the inverter cover’s six Allen screws and carefully pull the cover horizontally before lowering it.



### CAUTION!

When removing the cover, make sure not to damage internal components. SolarEdge will not be held responsible for any components damaged as a result of incautious cover removal.

## Creating an Ethernet (LAN) Connection

This communication option enables using an Ethernet connection to connect the inverter to the monitoring portal through a LAN.

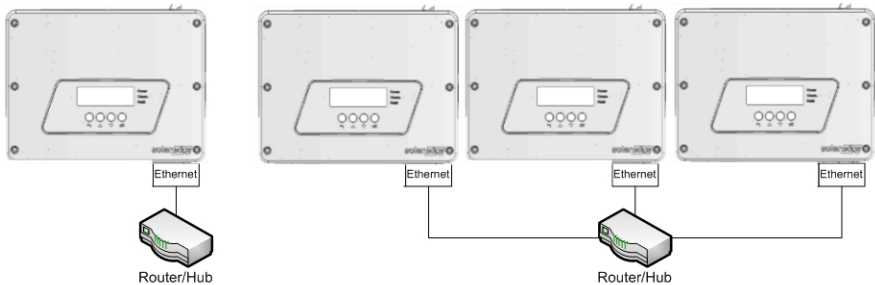

**Figure 14: Example of Ethernet connection**

Ethernet cable specifications:

- Cable type – CAT5/CAT6
- Maximum distance between the inverter and the router – 100 m/ 330 ft.

**NOTE**



If using a cable longer than 10 m / 33 ft in areas where there is a risk of induced voltage surges by lightning, it is recommended to use external surge protection devices. For details refer to: [http://www.solaredge.com/files/pdfs/lightning\\_surge\\_protection.pdf](http://www.solaredge.com/files/pdfs/lightning_surge_protection.pdf). If grounded metal conduit are used for routing the communication wires, there is no need for a lightning protection device.



► **To connect the Ethernet cable:**

1. Remove the inverter cover as described in *Removing the Inverter Cover* on the previous page.
2. Open the communication gland.



**CAUTION!**

The gland includes a rubber waterproof fitting, which should be used to ensure proper sealing.

3. Remove the plastic seal from the large opening that has a cut in the rubber fitting .
4. Remove the rubber fitting from the gland and insert the CAT5/6 cable through the gland and through the gland opening in the inverter .
5. Push the cable into the cut opening of the rubber fitting.

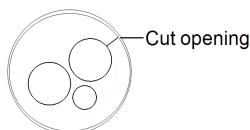
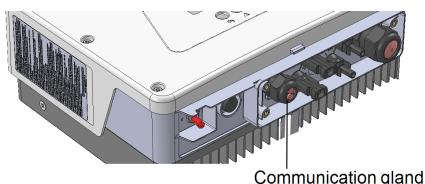
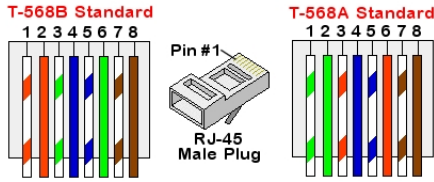

**Figure 15: Communication gland and rubber fitting**

CAT5/6 standard cables have eight wires (four twisted pairs), as shown in the diagram below. Wire colors may differ from one cable to another. You can use either wiring standard, as long as both sides of the cable have the same pin-out and color-coding.

RJ45 Pin #	Wire Color <sup>1</sup>		10Base-T Signal 100Base-TX Signal
	T568B	T568A	
1	White/Orange	White/Green	Transmit+
2	Orange	Green	Transmit-
3	White/Green	White/Orange	Receive+
4	Blue	Blue	Reserved
5	White/Blue	White/Blue	Reserved
6	Green	Orange	Received-
7	White/Brown	White/Brown	Reserved
8	Brown	Brown	Reserved

<sup>1</sup>The inverter connection does not support RX/TX polarity change. Supporting crossover Ethernet cables depends on the switch capabilities.



**Figure 16: Standard cable wiring**

6. Use a pre-terminated cable to connect via gland #1 to the RJ45 plug on the inverter's communication board or, if using a spool of cable, connect as follows:
  - a. Insert the cable through the gland.
  - b. Remove the cable's external insulation using a crimping tool or cable cutter and expose eight wires.
  - c. Insert the eight wires into an RJ45 connector, as described in *Figure 16*
  - d. Use a crimping tool to crimp the connector.
  - e. Connect the Ethernet connector to the RJ45 port on the communication board.

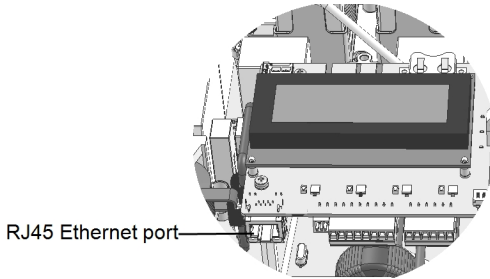

**Figure 17: The RJ45 Ethernet connection**

7. For the switch/router side, use a pre-terminated cable or use a crimper to prepare an RJ45 communication connector: Insert the eight wires into the RJ45 connector in the same order as above (*Figure 16*).
8. Connect the cable RJ45 connector to the RJ45 port of the Ethernet switch or router. You can connect more than one inverter to the same switch/router or to different switches/routers, as needed. Each inverter sends its monitored data independently to the SolarEdge monitoring portal.
9. The inverter is configured by default to LAN. If reconfiguration is required:
  - a. Make sure the ON/OFF switch is OFF.
  - b. Turn ON the AC to the inverter by turning ON the circuit breaker on the main distribution panel.
  - c. Use the internal user buttons to configure the connection, as described in *Communication* on page 31.

**NOTE**



If your network has a firewall, you may need to configure it to enable the connection to the following address:

- Destination Address: prod.solaredge.com
- TCP Port: 22222 (for incoming and outgoing data)

10. Verify the connection, as described in *Verifying the Connection* on page 48.

## Creating an RS485 Bus Connection

The RS485 option enables creating a bus of connected inverters, consisting of up to 31 slave inverters and 1 master inverter. Using this option, inverters are connected to each other in a bus (chain), via their RS485 connectors. The first and last inverters in the chain must be terminated.

RS485 wiring specifications:

- Cable type: Min. 3-wire shielded twisted pair (a 4-wire cable may be used)
- Wire cross-section area: 0.2- 1 mm<sup>2</sup>/ 24-18 AWG (a CAT5 cable may be used)
- Maximum nodes: 32
- Maximum distance between first and last devices: 1 km /3300 ft.

### NOTE

If using a cable longer than 10 m / 33 ft in areas where there is a risk of induced voltage surges by lightning, it is recommend to use external surge protection devices. For details refer to:

[http://www.solaredge.com/files/pdfs/lightning\\_surge\\_protection.pdf](http://www.solaredge.com/files/pdfs/lightning_surge_protection.pdf). If grounded metal conduit are used for routing the communication wires, there is no need for a lightning protection device.



### NOTE

If an electricity meter is connected to your inverter, it uses the RS485 port and therefore an RS485 Expansion Kit is required (available form SolarEdge; Refer to [http://www.solaredge.com/files/pdfs/RS485\\_expansion\\_kit\\_installation\\_guide.pdf](http://www.solaredge.com/files/pdfs/RS485_expansion_kit_installation_guide.pdf)).



The following sections describe how to physically connect the RS485 bus and how to configure the bus.

### ► To connect the RS485 communication bus:

1. Remove the inverter cover as described in *Removing the Inverter Cover* on page 42.
2. Remove the seal from one of the openings in communication gland and insert the wire through the opening.
3. Pull out the 6-pin RS485 terminal block connector, as shown below:

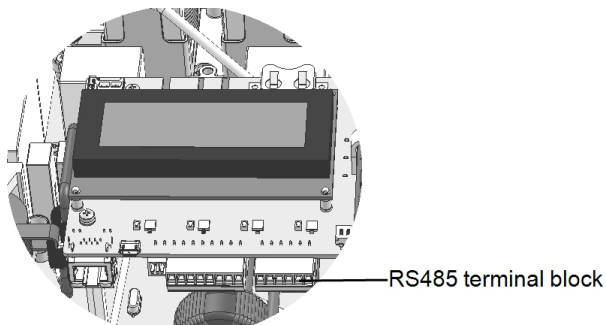
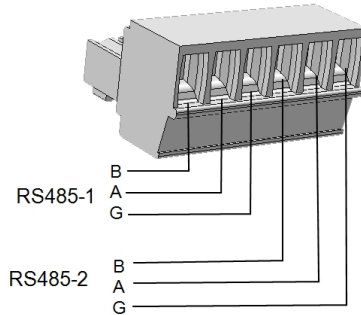

Figure 18: The RS485 terminal block

- Loosen the screws of pins A(+), B(-), and G on the left of the RS485 terminal block (RS485-1).



**Figure 19: RS485 terminal block**

- Insert the wire ends into the **G**, **A** and **B** pins shown above. Use Four- or six-wire twisted pair cable for this connection. You can use any color wire for each of the **A**, **B** and **G** connections, as long as the same color wire is used for all A pins, the same color for all B pins and the same color for all G pins.
- For creating an RS485 bus - connect all B, A and G pins in all inverters. The following figure shows this connection schema:

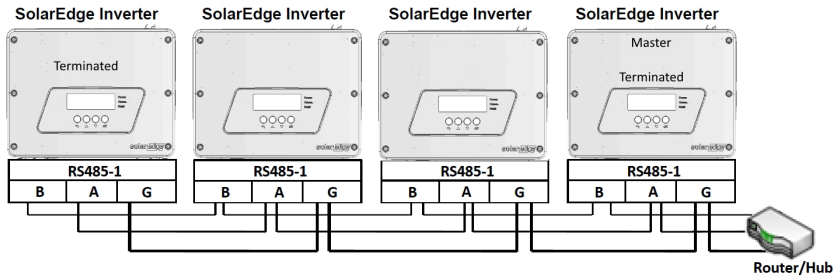

**Figure 20: Connecting the inverters in a chain**



**NOTE**

Do not cross-connect B, A and G wires. Do not insert wires into RS485- 2 pins.

- Tighten the terminal block screws.
- Check that the wires are fully inserted and cannot be pulled out easily.
- Push the RS485 terminal block firmly all the way into the connector on the right side of the communication board.

10. Terminate the first and last SolarEdge device (inverter/Control and communication gateway, etc.) in the chain by switching a termination DIP-switch inside the inverter to ON (move the switch up). The switch is located on the communication board and is marked SW2.

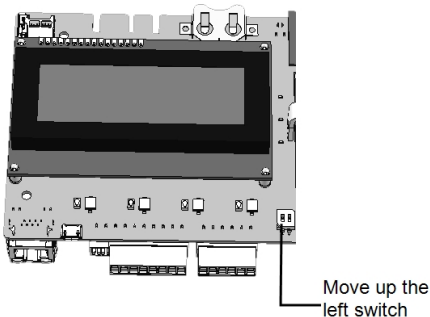

Figure 21: RS485 termination switch



**NOTE**

Only the first and last SolarEdge devices in the chain should be terminated. The other inverters in the chain should have the termination switch OFF (down position).

► **To connect to the monitoring portal:**

1. Designate a single inverter as the connection point between the RS485 bus and the SolarEdge monitoring portal. This inverter will serve as the master inverter.
2. Connect the master to the SolarEdge monitoring portal via the LAN or ZigBee communication option.

► **To configure the RS485 communication bus:**

All inverters are configured by default as slaves. If reconfiguration is required:

1. Make sure the ON/OFF switch is OFF.
2. Turn ON the AC to the inverter by turning ON the circuit breaker on the main distribution panel.



**WARNING!**

ELECTRICAL SHOCK HAZARD. Do not touch uninsulated wires when the inverter cover is removed.

3. Use the internal buttons to configure the connection (slightly touch the black square buttons). To set the inverter designated as master, select the following in the LCD menus:
  - Communication → Server → LAN, ZigBee or Wi-Fi
  - RS485-1 Conf. → Device Type → SolarEdge
  - RS485-1 Conf. → Protocol → Master
  - RS485-1 Conf. → Slave Detect

The system starts automatic detection of the SolarEdge slave inverters connected to the master inverter. The inverter should report the correct number of slaves. If it does not, verify the connections and terminations.

4. Verify the connection of the master to the SolarEdge monitoring portal, as described in *Verifying the Connection* on the next page.



## Additional Connection Options

### Creating a Wireless ZigBee Connection

This communication option enables using a ZigBee connection to connect one or several devices to the SolarEdge monitoring portal.

The ZigBee device is provided with a user manual, which should be reviewed prior to connection. It is available on the SolarEdge website at <http://www.solaredge.com/groups/products/communication> (under ZigBee).



### Creating a Wi-Fi Connection

This communication option enables using a Wi-Fi connection for connecting the device to the SolarEdge monitoring portal.

The Wi-Fi kit can be purchased separately and assembled during system installation. The Wi-Fi kit is provided with a user manual, which should be reviewed prior to connection. It is available on the SolarEdge website at <http://www.solaredge.com/groups/products/communication> (under Wi-Fi).



### Verifying the Connection

After connecting and configuring a communication option, perform the following steps to check that the connection to the monitoring server has been successfully established.

1. Close the inverter cover: Attach the inverter cover and secure it by tightening the screws with a torque of 9.0 N\*m/6.6 lb.\*ft. For proper sealing, first tighten the corner screws and then the two central screws.
2. Turn ON the AC to the inverter by turning ON the circuit breaker on the main distribution panel.
3. Wait for the inverter to connect to the SolarEdge monitoring portal. This may take up to two minutes.

A status screen similar to the following appears on the LCD panel:

```
V a c [ V ]   V d c [ V ]   P a c [ w ]
2 4 0 . 7     1 4 . 1     0 . 0
P _ O K :   0 0 0 / 0 0 0   < S _ O K >
                                O F F
```

**S\_OK:** Indicates that the connection to the SolarEdge monitoring portal is successful. If S\_OK is not displayed, refer to *Troubleshooting Communication on the facing page*.

# Appendix A: Errors and Troubleshooting

This appendix describes the error messages that appear on the LCD panel when an error occurs, and how to troubleshoot them. For further assistance, contact SolarEdge Support.

## Troubleshooting Communication

### Troubleshooting Ethernet Communication

When using Ethernet communication, use the **Server Communication Status** window to identify the location of the error:

```

Server : LAN      <S_OK>
Status :         <OK>
          xxxxxxxx
<ERROR MESSAGE>
    
```

xxxxxxx is a string of 1s and 0s showing an eight-bit communication connection status. 1 indicates OK and 0 indicates an error.

Bit Location	Error Message	Cause and Troubleshooting
1st	LAN Disconnected	Physical connection fault. Check the cable pin-out assignment and cable connection. Refer to <i>Creating an Ethernet (LAN) Connection</i> on page 42.
2nd	DHCP Failed, or Invalid DHCP Config	IP settings issue. Check the router and inverter configuration. Consult your network IT.
3rd	Gateway Ping Failed	Ping to router failed. Check the physical connection to the switch/router. Check that the link LED at the router /switch is lit (indicating phy-link). If OK - contact your network IT, otherwise replace the cable or change it from cross to straight connection.
4th	G Server Ping Failed	Ping to google.com failed. Connect a laptop and check for internet connection. If internet access is unavailable, contact your IT admin or your internet provider. For Wi-Fi networks, ensure that username and password are as defined in the internet provider AP/router.
5th	Server x Ping Failed	Ping or connection to SolarEdge server failed.. Check the SolarEdge server address, under <b>LAN Conf</b> submenu: Address: prod.solaredge.com Port: 22222 Check with your network administrator whether a firewall or another device is blocking transmission.
6th		
7th		
8th	Tcp Connect. Failed	

## Troubleshooting RS485 Communication

1. If the message **Master Not Found** appears, check the connections to the master device and fix if required.
2. If after slave detection the number of slaves displayed in the master under **RS485-X Conf** → **Slave Detect** is smaller than the actual number of slaves, use the slave list to identify missing slaves and troubleshoot connectivity problems:
  - a. Select **RS485-X Conf** → **Slave List**. A list showing the serial numbers of the detected slaves is displayed.
  - b. To view the details of a detected slave device, select its serial number entry.

```

ID: 5000FE01-4F
Last Communication
17/02/2015
14:24:01
```

- **ID:** Serial number
- **Last Communication:** date and time (dd:mm:yy 24h) of last communication with the master. If this device is detected for the first time after the master wakeup, **N/A** appears for this information.

## Additional Troubleshooting

1. Check that the modem or hub/router is functioning properly.
2. Check that the connection to the internal connector on the communication board is properly done.
3. Check that the selected communication option is properly configured.
4. Use a method independent of the SolarEdge device to check whether the network and modem are operating properly. For example, connect a laptop to the Ethernet router and connect to the Internet.
5. Check whether a firewall or another type of network filter is blocking communication.

## Error Codes

The error messages include an error number and a description, and have the following format:

```

Error Code 3xD2

<Line 1>
<Line 2>
```

**(#-X#):** A code indicating the source of error and the error information sent to the monitoring server. This information is used by SolarEdge Support for advanced troubleshooting.

**Line 1-2:** Error message

Code	Error Message	Troubleshooting
3xB	No Country Selected	Select the country as described in <i>Country and Grid</i> on page 31
3x2	Inv. Comm. Error	No communication with the digital board. Contact SolarEdge support.
3xC	SW Error	
3xA	Phase Unbalance	<ul style="list-style-type: none"> <li>o Check the grid connection.</li> <li>o Check the GND connection.</li> <li>o Check the L1, L2 and Neutral connections.</li> <li>o Verify symmetric load between L1 and L2.</li> <li>o Consult the local grid authority.</li> </ul>
3xF	SW Error	Contact SolarEdge support.
3x6A	For info contact your installer	Inverter remotely locked. Contact your installer.
3x6E	Meter Comm. Error	Refer to the meter troubleshooting in <a href="http://www.solaredge.com/sites/default/files/solaredge-meter-installation-guide.pdf">http://www.solaredge.com/sites/default/files/solaredge-meter-installation-guide.pdf</a>
3x6A	OFF/ON to Reconnect	Turn the ON/OFF switch to ON to initiate production.
18xA9		RCD Sensor Error. Contact SolarEdge support.
18xA6-A8 , 18xAA	HW error	Contact SolarEdge support.
18xAB		Over voltage in DC input of the inverter. Check the strings' voltage.
18xC	ARC_DETECTED	Refer to <i>Inverter Arc Detection and Interruption</i> on page 59.
18xD	ARC_PWR_DETECT	Refer to <i>Inverter Arc Detection and Interruption</i> on page 59.
18x19-36/A-C	V-L1/L2/L3 <b>Max</b> 1/2/3	AC voltage too high <ul style="list-style-type: none"> <li>o Verify that the inverter is set to the correct country.</li> <li>o Turn OFF the inverters in the site and verify AC grid voltage.</li> <li>o If the inverter is located far from the connection point to the grid, use a larger gauge AC wire.</li> <li>o Consult the grid operator.</li> <li>o If permitted by local authorities, change the grid protection values. Refer to <a href="http://www.solaredge.com/files/pdfs/viewing_grid_protection_values.pdf">http://www.solaredge.com/files/pdfs/viewing_grid_protection_values.pdf</a></li> </ul>
18x37	V-Line Max	
18x19-36/A-C	V-L1/L2/L3 <b>Min</b> 1/2/3	AC voltage too low <ul style="list-style-type: none"> <li>o Verify that the inverter is set to the correct country.</li> <li>o Consult the grid operator.</li> <li>o If permitted by local authorities, change the grid protection values. Refer to <a href="http://www.solaredge.com/files/pdfs/viewing_grid_protection_values.pdf">http://www.solaredge.com/files/pdfs/viewing_grid_protection_values.pdf</a></li> </ul>
18x38	V-Line Min	
18x39/3B/3C	I-ACDC L1/L2/L3	AC overcurrent. Contact SolarEdge support.
18x3D	I-RCD STEP	Ground Current – RCD. Contact SolarEdge support.
18x3E	I-RCD MAX	

Code	Error Message	Troubleshooting
18x40-59/A-F	F-L1/L2/L3 <b>Max</b> 1/2/3	AC frequency too high (Line 1/2/3) <ul style="list-style-type: none"> <li>Verify that the inverter is set to the correct country.</li> <li>Consult the grid operator.</li> <li>If permitted by local authorities, change the grid protection values. Refer to <a href="http://www.solaredge.com/files/pdfs/viewing_grid_protection_values.pdf">http://www.solaredge.com/files/pdfs/viewing_grid_protection_values.pdf</a></li> </ul>
18x40-59/A-F	F-L1/L2/L3 <b>Min</b> 1/2/3	AC frequency too low (Line 1/2/3) Handle as for the error above.
18x60/18x62	Islanding Trip1/2	AC grid voltage malfunction. When AC voltage returns the inverter should restart after the reconnection time. If the problem persists, consult with the grid operator.
18x64-66	TZ L1/L2/L3	AC overcurrent. Contact SolarEdge support.
18x6F/70/71	Vsrg L1/L2 /L3 Max	AC voltage surge. <ul style="list-style-type: none"> <li>Check the AC connection to inverter.</li> <li>Verify that the inverter is set to the correct country.</li> <li>Check with the grid operator if a large surge source or irregular load exists near the site.</li> <li>Verify that the output wire size matches the distance between the inverter and the location of the grid connection.</li> <li>Use a larger gauge wire for the AC output.</li> <li>Refer to the <i>AC Wiring Application Note</i> <a href="http://www.solaredge.com/files/pdfs/application-note-recommended-wiring.pdf">http://www.solaredge.com/files/pdfs/application-note-recommended-wiring.pdf</a></li> </ul>
18x75	Overtemp	Temperature too high <ul style="list-style-type: none"> <li>Verify proper inverter clearances.</li> <li>Make sure the heat-sink fins are clean and unobstructed.</li> </ul>
18x76	Undertemp	Temperature too low Make sure the inverter is installed in a location with ambient temperatures within the range specified in the datasheet.
18x7B	MainError	Grid measurements are out of range. Contact the grid operator.
18x7F	IRCDMax	RCD current surge. Ground faults may occur due to insufficient insulation to the ground. <div style="display: flex; align-items: center; margin-top: 10px;">  <div style="background-color: black; color: white; padding: 2px 5px; font-weight: bold;">WARNING!</div> <div style="background-color: #cccccc; padding: 5px; margin-left: 5px; font-size: small;">ELECTRICAL SHOCK HAZARD. Do not touch uninsulated wires when the inverter cover is removed.</div> </div> <p>Only a qualified technician should handle this problem, and only after taking proper precautions.</p> <ol style="list-style-type: none"> <li>Turn the inverter ON/OFF switch to OFF.</li> <li>Wait five minutes for the input capacitors to discharge.</li> <li>Disconnect the AC breaker.</li> <li>Disconnect the DC inputs.</li> <li>Connect each DC string separately, turn the AC and the inverter</li> </ol>

Code	Error Message	Troubleshooting
		<p>ON/OFF switch to ON, until the error appears for the faulty string.</p> <ul style="list-style-type: none"> <li>Do not connect strings with a grounding fault to the inverter. A certified installer must fix the faulty string before connecting it to the inverter</li> <li>For further documentation, contact SolarEdge Support.</li> </ul>
18x85	Temp Sensor fault	Broken or unconnected temperature sensor. Contact SolarEdge Support.
18x86	Isolation	<p>PV Isolation fault. The inverter has detected the PV solar array is not properly isolated from ground earth. The isolation is checked each time the inverter starts up.</p> <ul style="list-style-type: none"> <li>Check the PV installation for isolation problems and ground leakage.</li> <li>Only a certified PV installer must fix the faulty string before connecting it to the inverter.</li> <li>Refer to <a href="http://www.solaredge.com/files/pdfs/application_note_isolation_fault_troubleshooting.pdf">www.solaredge.com/files/pdfs/application_note_isolation_fault_troubleshooting.pdf</a></li> </ul>
18x89	RCD Test	Contact SolarEdge support.
18x9E	Controller 3 Err	Contact SolarEdge support.
18xA3-5	Tz Over current 1/2/3	Contact SolarEdge support.
18xA6-8	Tz Over voltage cap1/2/3	<ul style="list-style-type: none"> <li>Verify that the inverter is set to the correct country.</li> <li>Turn OFF the inverters in the site and verify AC grid voltage.</li> <li>If the inverter is located far from the connection point to the grid, use a larger gauge AC wire.</li> <li>Consult the grid operator.</li> <li>If permitted by local authorities, change the grid protection values. Refer to <a href="http://www.solaredge.com/files/pdfs/viewing_grid_protection_values.pdf">http://www.solaredge.com/files/pdfs/viewing_grid_protection_values.pdf</a></li> </ul>
18xA9	Tz Over current Rcd	Contact SolarEdge support.
18xB2-4	Vf1/2/3 surge	<p>Ground current surge.</p> <ul style="list-style-type: none"> <li>Check the AC connection to the inverter</li> <li>Check with the grid operator if a large surge source or irregular load exists near the site.</li> <li>If the grid does not have problems contact SolarEdge support.</li> </ul>

## Power Optimizer Troubleshooting

If the inverter status screen indicates that not all power optimizers are paired or not all are reporting (P\_OK xxx/yyy, and x<y), those optimizers can be identified through the LCD. Refer to <http://www.solaredge.com/files/pdfs/products/inverters/non-responding-power-optimizers.pdf>



Problem	Possible cause and troubleshooting
Pairing failed	Power optimizers are shaded. If you connected the inverter to the SolarEdge monitoring portal, retry pairing remotely (during sunlight). Make sure to leave the inverter ON/OFF switch ON and that S_OK appears on the LCD.
String voltage is 0V	Power optimizer(s) output is disconnected. Connect all power optimizer outputs
String voltage not 0V but lower than number of optimizers	Power optimizer(s) not connected in the string. Connect all power optimizers
	Module(s) not connected properly to power optimizer inputs (not applicable to smart modules).
	Connect the modules to the optimizer inputs
	String reverse polarity. Check string polarity using a voltmeter and correct if needed.
String voltage is higher than the number of optimizers	Extra power optimizer(s) connected in the string (not applicable to smart modules). Check if an extra power optimizer is connected in the string. If not – proceed to next solution.
	A module is connected directly to the string, without a power optimizer (not applicable to smart modules).
	<b>WARNING!</b> If the measured voltage is too high, the installation may not have a safe low voltage. <b>PROCEED WITH CARE!</b> A deviation of $\pm 1\%$ per string is reasonable.
	Verify that only power optimizers are connected in the string and that no module outputs are connected without a power optimizer. If the problem persists, proceed to the next step.
	Power optimizer(s) malfunction. <ul style="list-style-type: none"> <li>○ Disconnect the wires connecting the power optimizers in the string.</li> <li>○ Measure the output voltage of each power optimizer to locate the power optimizer that does not output 1V safety voltage. If a malfunctioning power optimizer is located, check its connections, polarity, module, and voltage.</li> <li>○ Do not continue before finding the problem and replacing the malfunctioning power optimizer. If a malfunction cannot be bypassed or resolved, skip the malfunctioning power optimizer, thus connecting a shorter string.</li> </ul>

## Appendix B: Technical Specifications

	SE2200H	SE3000H	SE3500H	SE3680H <sup>1</sup>	SE4000H	SE5000H <sup>2</sup>	SE6000H	
<b>OUTPUT</b>								
Rated AC Power Output	2200	3000	3500	3680	4000	5000	6000	VA
Maximum AC Power Output	2200	3000	3500	4000	4000	5000	6000	VA
AC Output Voltage (Nominal)	220 / 230							Vac
AC Output Voltage Range	184 - 264.5							Vac
AC Frequency (Nominal)	50 / 60 ± 5							Hz
Maximum Continuous Output Current	10	14	16	16	18.5	23	27.5	A
Max. continuous overcurrent protection	10	14	16	16	18.5	23	27.5	A
Residual Current Detector / Residual Current Step Detector	300 / 30							mA
Inrush current AC (Peak/Duration)	2.8/20							Aac(rms) / ms
Max. output fault current	38							A
Power factor range	1 (adjustable from -0.95 to +0.95)							
Total harmonic distortion	<3%							
Protective class	Class I							
Utility Monitoring, Islanding Protection, Country Configurable Thresholds	Yes							

<sup>1</sup>SE3680H is limited to 16A.

<sup>2</sup>SE5000H is limited to 4600VA in Germany



	SE2200H	SE3000H	SE3500H	SE3680H <sup>1</sup>	SE4000H	SE5000H <sup>2</sup>	SE6000H	
Overvoltage category	III							
<b>INPUT</b>								
Recommended Maximum DC Power <sup>3</sup> (Module STC)	3400	4650	5425	5700	6200	7750	9300	W
Transformer-less, Ungrounded	Yes							
Maximum Input Voltage	480							Vdc
Nominal DC Input Voltage	380						380	Vdc
Maximum Input Current	8.5	11.5	13.5	15	15	16.5	16.5	Adc
Maximum back-feed current	0							
Reverse-Polarity Protection	Yes							
Ground-Fault Isolation Detection	600k $\Omega$ Sensitivity							
Overvoltage category	III							
Maximum Inverter Efficiency	99.2							%
European Weighted Efficiency	98.3	98.8				99		%
Nighttime Power Consumption	<2.5							W
<b>ADDITIONAL FEATURES</b>								
Supported Communication Interfaces	RS485, Ethernet, ZigBee (optional), Wi-Fi (optional), Cellular (Optional)							
<b>STANDARD COMPLIANCE</b>								

<sup>1</sup>SE3680H is limited to 16A.

<sup>2</sup>SE5000H is limited to 4600VA in Germany

<sup>3</sup>Limited to 155% DC oversizing

	SE2200H	SE3000H	SE3500H	SE3680H <sup>1</sup>	SE4000H	SE5000H <sup>2</sup>	SE6000H	
Safety	IEC-62109-1/2, AS-3100							
Grid Connection Standards	AS-4777, VDE-AR-N-4105, VDE 0126-1-1, UTE_C_15-712, G83/2, G59/3, CEI-021, EN 50438, IEC61727, IEC62116, ÖNORM, TF3.2.1, C10-11, NRS 097-2-1							
Emissions	IEC61000-6-2, IEC61000-6-3, IEC61000-3-11, IEC61000-3-12, FCC part15 class B							
RoHS	Yes							
<b>INSTALLATION SPECIFICATIONS</b>								
AC Output	Cable Gland - diameter 9-16							mm
AC TB cross section	1 - 16							mm <sup>2</sup>
DC Input	1 x MC4				2 x MC4 pair			
Dimensions (HxWxD)	280 x 370 x 142							mm
Weight	9.5							kg
Cooling	Natural Convection							
Operating Temperature Range	-20 to +60 <sup>3</sup> (-40°C option)							°C
Protection Rating	IP65 / Type 3R - Outdoor and Indoor							

<sup>1</sup>SE3680H is limited to 16A.

<sup>2</sup>SE5000H is limited to 4600VA in Germany

<sup>3</sup>De-rating from 50°C

# Appendix C: Mechanical Specifications

The following figure provides dimensions of the mounting brackets for the HD-Wave inverters. Dimensions in mm [in].

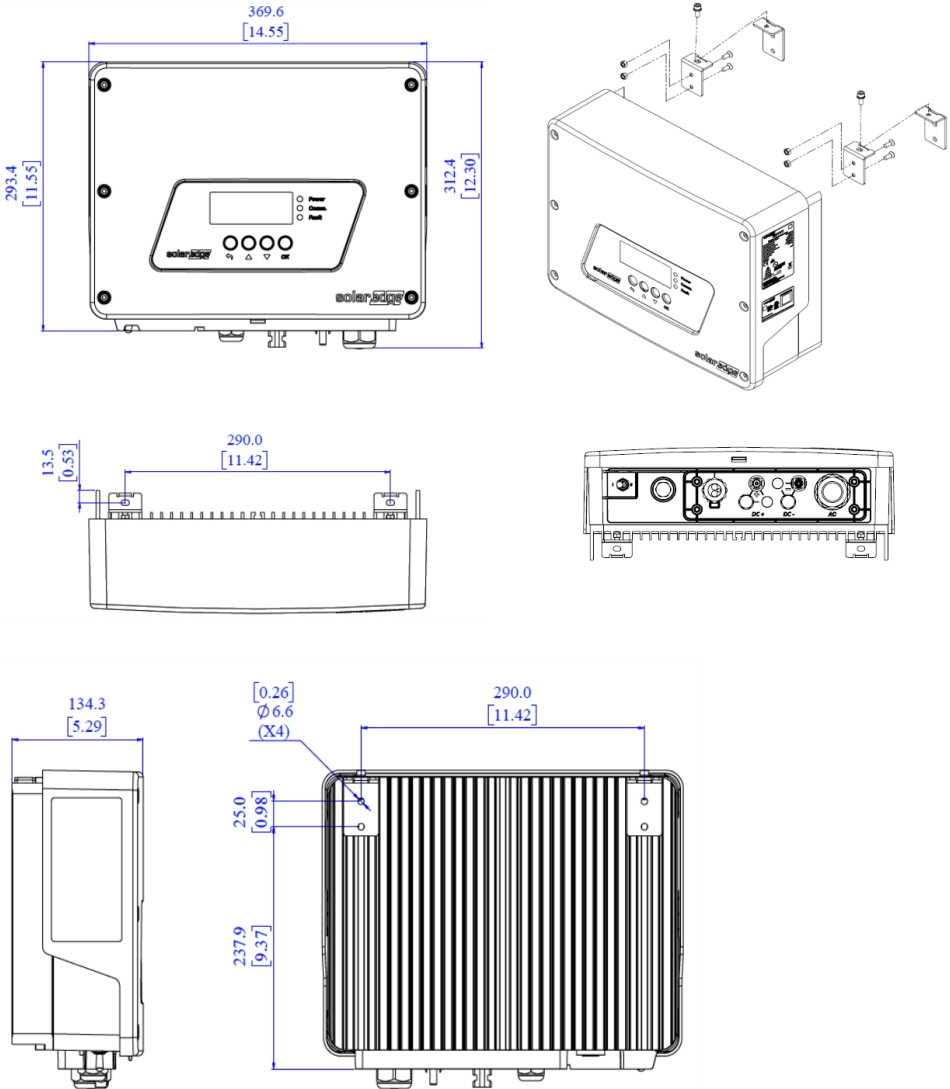

Figure 22: HD-Wave inverter dimensions

## Appendix D: Inverter Arc Detection and Interruption

An electric arc is an ongoing high-energy discharge, resulting from a current through a normally non-conductive material such as air.

When connectors or cables in a PV system are improperly connected or are damaged, the electric current may pass through the air, causing an electric arc. Arcs generate heat which can cause fires and they also pose an electrocution risk to those working near them.

SolarEdge inverters can detect arcs and interrupt production. A qualified person must re-enable the inverter after properly checking the installation.

Two modes of inverter reconnection are available after an arc detection event:

- **Manual Reconnect** - The system must be manually restarted on site following inverter shut down.
- **Auto Reconnect** - Reconnects the system automatically a certain period of time after an arc detection event. If the arc detection persists, the time to reconnection increases progressively.

The arc detection option is disabled by default.

### ▶ To enable/disable arc detection:

1. Enter Setup mode and scroll to the **Maintenance** menu.
2. Select **AFCI** → **Enable** or **Disable**.

### ▶ To enable manual reconnect / auto connect:

1. Enter Setup mode and scroll to the **Maintenance** menu.
2. Select **AFCI** → **AFCI Mode** and choose the required mode: **Manual Reconnect** or **Auto Reconnect**.



```
Manual Reconnect
Auto Reconnect
```

### ▶ To manually test the arc detection functionality:

1. Make sure the inverter ON/OFF switch is turned ON.
2. Use the LCD light button to select **Maintenance** → **Manual AFCI Test**.
  - If the test is successful, the following message is displayed:



```
Manual Test PASS
```

The inverter production is then interrupted (as if a real arc detection has occurred), and the following error message is displayed (numbered either 150 or 151):

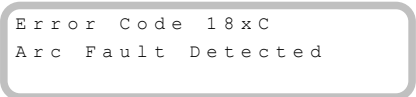

```
Error Code 18xC
Arc Fault Detected
```

Perform manual restart to resume system operation: Turn the inverter ON/OFF switch to OFF and then to ON. The inverter performs an arc detection self-test and starts normal operation.

- If the test fails, contact SolarEdge support.

▶ **To troubleshoot arc-fault failures:**

The inverter continuously performs arc detection while producing power. If an electric arc occurred in the PV system, the inverter detects it and stops producing power. The following error message is displayed (numbered either 150 or 151):

```
Error Code 18xC  
Arc Fault Detected
```

If this message is displayed:

1. Turn the inverter ON/OFF switch to OFF.
2. Check all PV strings for the correct open-circuit voltage:
  - Inspect all connections and cables between the power optimizers in the strings: Verify they are connected properly by firmly pushing the plugs and verifying the connectors are locked.
  - Inspect all connections and cables between the PV modules and the power optimizers: Verify they are connected properly by firmly pushing the plugs and verifying the connectors are locked.
  - Verify that the strings are firmly attached to the Safety Switch terminal blocks.
3. Perform manual restart to resume system operation: Turn the inverter ON/OFF switch to OFF and then ON. The inverter performs an arc detection self-test and starts normal operation.

▶ **To troubleshoot self-test failures:**

If the self-test fails, the inverter displays an error message indicating that the arc detector hardware failed during wake-up tests:

```
Error Code 18x8D  
AFCI  
self-test failed
```

The inverter transmits an error message to the monitoring portal, and continuously repeats the arc detection self-test until it is successful.

If the problem persists, contact SolarEdge support.

# Appendix E: Replacing and Adding System Components



## NOTE

If you are permanently disassembling the installation or part of it, make sure to use the disposal methods dictated by local regulations.

## Replacing an Inverter

1. Turn off the AC circuit breaker.
2. Turn OFF the inverter ON/OFF switch, and wait until the LCD indicates that the DC voltage is safe (<50V), or wait five minutes before continuing to the next step.



## WARNING!

If you cannot see the inverter panel, or if a malfunction is indicated on the LCD panel, wait five minutes for the input capacitors of the inverter to discharge.

3. Open the inverter cover as described in *Removing the Inverter Cover* on page 42.
4. Disconnect the DC plugs from the inverter.
5. Disconnect the AC wires from the AC terminal block and remove the ferrite bead.

SolarEdge HD-Wave inverter

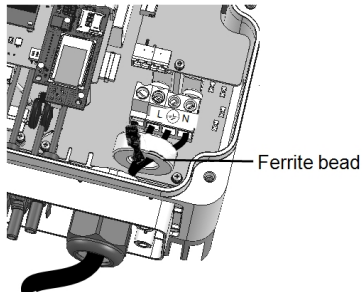
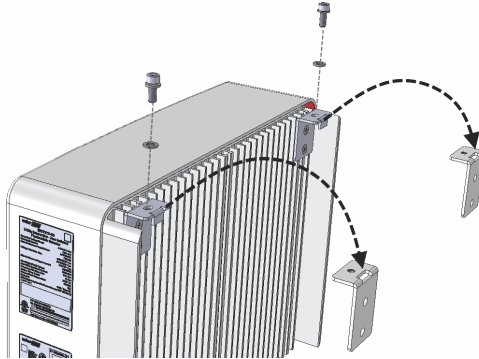

Figure 23: AC connections

6. Remove the screws securing the inverter to the mounting brackets and lift the inverter from the mounting bracket.



**Figure 24: Mounting brackets**



**NOTE**

If you remove the old inverter and do not immediately install a new one, use insulation tape to isolate each of the AC and DC wires

7. Place the new inverter on the mounting brackets and secure it using the screws.
8. Reconnect the cables: Follow the instructions of *Installing the Inverter* on page 15.
9. Close the inverter cover.
10. Perform the commissioning steps as described in *Commissioning the Installation* on page 21.

## Appendix F: Safe DC™

When AC supply to the inverter is shut off (by shutting off the AC breaker at the site), or when the inverter ON/OFF switch is turned to OFF, the DC voltage drops to a safe voltage of 1V per optimizer.

The SolarEdge inverters are certified for compliance with the following standards as disconnection devices for PV generators, meaning that they can replace a DC disconnect:

- IEC 60947-3:1999 + Corrigendum: 1999 + A1:2001 + Corrigendum 1:2001 + A2:2005;
- DIN EN 60947-3
- VDE 0660-107:2006-03
- IEC 60364-7-712:2002-05
- DIN VDE 0100-712:2006-06.

In compliance with these standards, the disconnection mechanism operates as follows:

1. Turn the inverter ON/OFF switch, located at the bottom of the inverter, to OFF, or disconnect the AC by shutting off the AC breaker at the site. The DC voltage displayed on the inverter LCD begins to decrease.

If the AC breaker was shut off, the LCD does not display. In this case, wait five minutes.

2. When the DC voltage reaches a safe voltage, the PV connectors at the input to the inverter can be disconnected. A galvanic separation then exists between the PV array and the inverter.



### WARNING!

Under single fault conditions, the Safe DC voltage is only guaranteed when using modules of up to 95Voc.



If you have technical queries concerning our products,  
please contact our support through SolarEdge service portal:  
<http://www.solaredge.com/groups/support/services>

Australia (+61)	1800-465-567
Belgium (+32)	0800-78889
China(+86)	186-0166-3934
France (+33)	0800-917410
Germany (+49)	089-45459730
Italy (+39)	800-784-824
Japan (+81)	03-6261-1274
United Kingdom (+44)	0800-028-1183
US & Canada (+1)	510-498-3200
Greece (+30)	00800-125574
Israel (+972)	073-240-3122
Netherlands (+31)	0800-022-1089
New Zealand (+64)	0800 144 875
Worldwide (+972)	073-2403118
Fax (+972)	073-240-3117
Email to:	<a href="mailto:support@solaredge.com">support@solaredge.com</a>

[www.solaredge.com](http://www.solaredge.com)

**solar**edge



MAN-01-00250-1.1