





STP 21-24-SMCT

HEADQUARTERS  
DEPARTMENT OF THE ARMY



Soldier's Manual of  
Common Tasks  
Skill Level 2, 3, and 4

AUGUST 2003

DISTRIBUTIONRESTRICTION: Approvedforpublicrelease;  
distributionisunlimited.



**This publication is available at Army  
Knowledge OnLine ([www.us.army.mil](http://www.us.army.mil)) and  
the General Dennis J. Reimer Training and  
Doctrine Digital Library at  
([www.adtdl.army.mil](http://www.adtdl.army.mil))**



**\*STP 21-24-SMCT**

Soldier Training Publication  
No. 21-24-SMCT

Headquarters  
Department of the Army  
Washington, DC, 31 August 2003

**SOLDIER'S MANUAL OF  
COMMON TASKS  
Skill Levels 2, 3, and 4  
TABLE OF CONTENTS**

	Page
<b>PREFACE</b> .....	vi
<b>Chapter 1. Introduction</b> .....	1-1
<b>Chapter 2. Training Guide</b> .....	2-1
<b>Chapter 3 Skill Levels 2, 3, and 4 Tasks</b> .....	3-1
<b>Skill Level 2</b>	
<hr/>	
<b>Subject Area 1: Individual Conduct and Laws of War</b>	
181-101-2023 Enforce the Uniform Code of Military Justice (UCMJ).....	3-1
181-105-2001 Enforce the Law of War and the Geneva and Hague Conventions.....	3-7
181-105-2002 Conduct Combat Operations According to the Law of War .....	3-11
224-176-2426 Enforce Compliance with Media Ground Rules .....	3-13
331-202-1050 Enforce Compliance with the Code of Conduct .....	3-15
805C-PAD-2503 Enforce Compliance with the Army's Equal Opportunity and Sexual Harassment Policies .....	3-17
<hr/>	
<b>Subject Area 2: First Aid</b>	
081-831-0101 Request Medical Evacuation.....	3-21
081-831-1054 Evacuate Casualties .....	3-27
081-831-9000 Implement Preventive Medicine Measures (PMM) ...	3-31

**Distribution Restriction:** Approved for public release; distribution is unlimited.

\*This manual supersedes STP 21-24-SMCT, 1 October 1992.

<b>Subject Area 3: Nuclear, Biological, and Chemical</b>	
031-503-1023	Protect Yourself from Nuclear, Biological, and Chemical Injury/Contamination When Changing Mission-Oriented Protective Posture Gear ..... 3-38
031-503-2001	Identify Chemical Agents Using M256-Series Chemical Agent Detector Kit ..... 3-43
031-503-2023	Measure Radiation Dose Rate and Total Dose ..... 3-47
031-503-3002	Conduct Unmasking Procedures ..... 3-50
031-503-3004	Supervise the Crossing of a Contaminated Area ..... 3-52
031-503-3005	Submit an NBC 1 Report ..... 3-55
031-503-3008	Implement Mission-Oriented Protective Posture ..... 3-57
031-503-3010	Supervise the Employment of Nuclear, Biological, and Chemical Markers ..... 3-59
031-503-4002	Supervise Unit Preparation for a Nuclear, Biological, and Chemical Attack ..... 3-62
031-506-1053	Report Nuclear, Biological and Chemical Information Using NBC 4 Report ..... 3-65
031-506-2061	Conduct a Mask Fit Test ..... 3-67
<b>Subject Area 4: Survive (Combat Techniques)</b>	
061-283-6003	Adjust Indirect Fire ..... 3-70
071-326-0608	Use Visual Signaling Techniques ..... 3-79
071-326-5704	Supervise Construction of a Fighting Position ..... 3-101
071-326-5705	Establish an Observation Post ..... 3-103
<b>Subject Area 5: Navigate</b>	
071-329-1019	Use a Map Overlay ..... 3-106
<b>Subject Area 20: Casualty Reporting and Handling</b>	
805C-PAD-2060	Report Casualties ..... 3-114
<b>Subject Area 21: Defense Measures</b>	
071-430-0002	Conduct a Defense by a Squad ..... 3-118
<b>Subject Area 22: Unit Operations</b>	
071-326-5502	Issue a Fragmentary Order ..... 3-123
071-326-5503	Issue a Warning Order ..... 3-125
551-88N-0002	Prepare for Unit Move ..... 3-127
<b>Subject Area 23: Security and Control</b>	
301-371-1200	Process Captured Materiel ..... 3-131
<b>Subject Area 25: Equipment Checks</b>	
091-CLT-4029	Supervise Preventive Maintenance Checks and Services ..... 3-135
101-92Y-0003	Enforce Compliance with Supply Discipline Procedures ..... 3-137

101-92Y-0004	Enforce Property Accountability Policies.....	3-140
101-92Y-0005	Enforce Compliance with Property Accountability Policies .....	3-152
101-92Y-0006	Inspect Equipment for Accountability, Cleanliness, and Serviceability.....	3-170

---

**Subject Area 27: Risk Management**

850-001-2000	Employ Accident Prevention Measures and Risk Management Process .....	3-171
--------------	---	-------

---

**Subject Area 28: Administration/Management**

805C-PAD-2044	Recommend Individual for Award .....	3-172
805C-PAD-2145	Counsel a Soldier on the Contents of a Noncommissioned Officer Evaluation Report and NCOER Checklist .....	3-175
805C-PAD-2146	Prepare the Rater's Portion of a Noncommissioned Officer Evaluation Report.....	3-177
805C-PAD-2402	Provide Input on Personnel Actions Affecting Subordinates.....	3-181
805C-PAD-2407	Recommend Disciplinary Action for a Soldier .....	3-184
805C-PAD-2461	Maintain Accountability of Personnel (Status Report).....	3-186
805C-PAD-2472	Prepare a Duty Roster .....	3-188

**Skill Level 3**

---

**Subject Area 1: Individual Conduct and Laws of War**

805C-PAD-3238	Enforce the Equal Opportunity Program .....	3-190
---------------	---	-------

---

**Subject Area 4: Survive (Combat Techniques)**

052-192-4053	Supervise Minefield Breaching Operations .....	3-195
071-410-0012	Conduct Occupation of an Assembly Area .....	3-197
071-420-0021	Conduct a Movement to Contact by a Platoon.....	3-200
071-430-0028	Consolidate a Unit.....	3-202
071-430-0029	Reorganize a Unit .....	3-204

---

**Subject Area 5: Navigate**

071-332-5000	Prepare an Operation Overlay .....	3-206
--------------	------------------------------------	-------

---

**Subject Area 19: Crowd Control**

191-378-4302	Form Squad-Size Riot Control Formations .....	3-224
--------------	---	-------

---

**Subject Area 21: Defense Measures**

052-195-3066	Direct Construction of Nonexplosive Obstacles .....	3-232
071-410-0019	Control Organic Fires.....	3-247
441-091-3000	Supervise the Implementation of Air Defense Measures .....	3-252

---

**Subject Area 22: Unit Operations**

071-326-3013	Conduct a Tactical Road March .....	3-256
071-326-5805	Conduct a Route Reconnaissance Mission.....	3-260
071-332-5021	Prepare a Situation Map .....	3-263
071-720-0015	Conduct an Area Reconnaissance by a Platoon....	3-264
101-92Y-0002	Plan Tactical Re-Supply Operations .....	3-269
301-371-1150	Identify Intelligence and Electronic Warfare (IEW) Assets .....	3-281
551-88M-0001	Lead a Convoy Serial/March Unit.....	3-286
551-88N-0003	Plan Unit Move.....	3-289

---

**Subject Area 23: Security and Control**

191-379-4407	Plan Convoy Security Operations .....	3-291
301-371-1052	Protect Classified Information and Material.....	3-297
805C-PAD-3594	Store Classified Information and Materials.....	3-305

---

**Subject Area 24: Enemy Personnel**

191-379-4450	Supervise Handling of Enemy Personnel and Equipment at Squad Level .....	3-307
--------------	---	-------

---

**Subject Area 27: Risk Management**

850-001-3001	Control Mission Safety Hazard.....	3-311
--------------	------------------------------------	-------

---

**Subject Area 28: Administration/Management**

805C-PAD-3147	Prepare the Senior Rater's Portion of a Noncommissioned Officer Evaluation Report (NCOER).....	3-312
---------------	--	-------

---

**Skill Level 4**

---

**Subject Area 2: First Aid**

081-831-1047	Supervise the Implementation of Preventive Medicine Policies .....	3-315
081-831-1055	Ensure Unit Combat Lifesaver Requirements Are Met .....	3-326

---

**Subject Area 4: Survive (Combat Techniques)**

071-326-5775	Coordinate with an Adjacent Platoon .....	3-335
101-CLT-0198	Supervise Tactical Feeding Operation .....	3-338

---

**Subject Area 19: Crowd Control**

191-379-5400	Form the Platoon into a Riot Control Formation.....	3-341
--------------	---	-------

---

**Subject Area 21: Defense Measures**

071-430-0006	Conduct a Defense by a Platoon.....	3-359
--------------	-------------------------------------	-------

---

**Subject Area 22: Unit Operations**

091-CLT-3009	Supervise Maintenance Operations .....	3-363
101-92Y-0001	Supervise Supply Activities .....	3-365

151-357-0001	Supervise CSS Functions During Platoon Operations .....	3-370
151-357-0002	Coordinate Combat Service Support (CSS) Operations .....	3-373
159-200-2020	Integrate Threat Capabilities into Mission Planning.....	3-376
181-101-4001	Conduct a Search/Seizure .....	3-378
551-721-4326	Perform Duties as Convoy Commander .....	3-384
<hr/>		
<b>Subject Area 23: Security and Control</b>		
191-379-4408	Plan Security for a Command Post (CP) .....	3-384
<hr/>		
<b>Subject Area 26: Crime Prevention</b>		
191-379-4425	Implement the Unit's Crime Prevention Program ...	3-394
<hr/>		
<b>Subject Area 27: Risk Management</b>		
850-001-4001	Integrate Risk Management into Mission Plans .....	3-396
<hr/>		
<b>Subject Area 28: Administration/Management</b>		
805C-PAD-4359	Manage Soldier's Deployment Requirements .....	3-397
805C-PAD-4550	Prepare a Standing Operating Procedure (SOP) ...	3-401
805C-PAD-4597	Integrate Newly Assigned Soldiers .....	3-403
<b>Appendix A</b>	<b>Proponent or Agency Codes.....</b>	<b>A-1</b>
<b>Appendix B</b>	<b>Guide to Forms .....</b>	<b>B-1</b>
<b>Glossary .....</b>	<b>Glossary-1</b>	
<b>References .....</b>	<b>References-1</b>	

## PREFACE

This manual is one of a series of soldier training publications that support individual training. Commanders, trainers, and soldiers will use this manual and STP 21-1-SMCT, *Soldier's Manual of Common Tasks, Skill Level 1*, to plan, conduct, sustain, and evaluate individual training of common tasks in units.

This manual contains a common task training plan for skill levels (SL) 1 through 4 and task summaries for SL 2 through SL 4 critical common tasks that support unit wartime missions. This manual is the only authorized source for these common tasks. Task summaries in this manual supersede any common tasks appearing in MOS-specific soldier's manuals.

Training support information, such as reference materials, is also included. Trainers and first-line supervisors should ensure SL 2 through SL 4 soldiers have access to this publication in their work areas, unit learning centers, and unit libraries.

This manual applies to both active and Reserve Component soldiers.

Unless this manual states otherwise, masculine pronouns do not refer exclusively to men.

The proponent of this publication is the Commander, United States Army Training and Doctrine Command (TRADOC), with the Commander, United States Army Training Support Center (ATSC) designated as the principle publishing, printing and distribution agency. Proponents for the specific tasks are the Army schools and agencies as identified by the school code, listed at appendix A, consisting of the first three digits of the task identification number. All comments, suggestions and recommended changes to this publication should be submitted as follows: Record any comments or questions regarding the task summaries contained in this manual on a DA Form 2028 (*Recommended Changes to Publications and Blank Forms*) and send it to the respective task proponent with information copies forwarded to: Commander, U.S. Army Training and Doctrine Command, ATTN: ATTG-I, Fort Monroe, VA 23651-5000, and Commander, U.S. Army Training Support Center, ATTN: ATIC-ITSC-CM, Fort Eustis, VA 23604-5166.

### REPRODUCIBLE FORMS

Following the very favorable acceptance of previous skill level 1 SMCTs "pocket-size" format, the August 2003 revisions (STP 21-1-SMCT and STP 21-24-SMCT) are printed in 5-by-7-inch format. This size precludes incorporating full-size, reproducible forms in these manuals. Instead, these manuals include a Guide to Forms (appendix B). In the online versions of the new manuals, appendix B contains electronic links to the downloadable,



reproducible forms. Where online access is not available, the soldier's unit must obtain hard copies of these forms

---

**SPECIAL NOTE FROM THE STAFF  
CONCERNING THE REVISED SMCT**

Experienced trainers will notice that, in addition to numerous new tasks in the revised SMCT, there are many tasks for which the skill level has been lowered from that in the past. This reflects results from the recent survey of approximately 19,000 enlisted soldiers, their commanders, and senior leaders, to determine who was actually performing certain tasks, and the amount of learning that was actually filtering down in the “one room schoolhouse” of the working Army. When it was established that a significant percentage of soldiers were performing those tasks at skill levels that were above their own, it was decided to lower the task designation, giving trainers—and the Army—the full advantage of accelerated learning at every level. This SMCT, if anything, reflects back to its users a faithfulness to this spirit of Army training from whom it derived, an allegiance and gratitude to the profession and legacy of every United States Army soldier.

Thank you.

United States Army Training and Doctrine Command

United States Army Training Support Center

---



## Chapter 1

### Introduction

#### 1-1. GENERAL INTRODUCTION

This manual contains the critical common tasks for skill levels 2, 3, and 4. Mastering the performance of these tasks will help the individual soldier fight better and survive on the battlefield, and perform across the full spectrum of operations. Each soldier must be able to perform all critical common tasks for his or her own skill level and below. The individual soldier shares responsibility with the trainer to sustain the skills and knowledge required to perform all critical common tasks.

**a. Individual Soldiers.** To ensure you can perform each task, have another soldier or your supervisor periodically evaluate your performance using the task summaries. If you have questions about how to perform a task or which task to perform, ask your first-line supervisor. The first-line supervisor knows how to perform each task and can direct you to the appropriate training materials. You should also check the Reimer Digital Library for new training materials. It is your responsibility to use these materials to maintain your proficiency.

**b. Trainers.** If you are a supervisor and trainer and have soldiers working for you, you must train them to do the tasks for their skill level and below. Commanders and trainers should use the Soldier's Manual of Common Tasks (SMCT), military occupational specialty (MOS) specific soldier's training publications (STPs), and mission training plans (MTPs) to establish effective training plans and programs which integrate individual and collective tasks.

#### 1-2. SMCT AND SUPPORT OF BATTLE-FOCUSED TRAINING

**a. Overview.** The SMCTs document the common tasks by skill level on which all soldiers must be trained and evaluated. These documents assist leaders in identifying the strengths and weaknesses of the soldiers in their unit and provide a means for evaluating the effectiveness of the unit's individual training program. Evaluation results also tell leaders where to concentrate training to improve unit readiness and help soldiers develop professionally.

**b. Leader's Assessment.** The leader's assessment focuses on specific unit mission requirements. It gives commanders a way to evaluate soldier performance on individual tasks that directly support their unit mission. These tasks may be common tasks as well as MOS-specific tasks. Leader's assessments should be conducted year round. Unit commanders should make leader's comments an integral part of their unit training so hands-on evaluation is systematically performed at the unit level.

(1) Tasks selected for leader's assessments include, but are not limited to, individual tasks that—

- (a) Support the units mission essential task list (METL).
- (b) Support other non-METL unit tasks as shown in the MTP.
- (c) Are identified by higher headquarters for inclusion in planned individual training.
- (d) Were rated as substandard on previous training feedback, such as the common task test (CTT) or annual general inspections.
- (e) Are relevant to the soldier's MOS but not required in his current duty assignment.

(2) Leaders may conduct their assessment—

- (a) Before, during, or after individual skills training.
- (b) As part of MTP training.
- (c) On the job.
- (d) At specially prepared test sites or in a battlefield scenario.
- (e) During training or job breaks.
- (f) After hours in the barracks.
- (g) During special squad or individual competitive events.

(3) The leader's assessment evaluates the combat effectiveness of soldiers and the unit. Commanders can use this evaluation to correct training deficiencies and plan unit training. Commanders can also use the results for personnel actions (such as preparing enlisted evaluation reports, making recommendations for promotions, and other personnel management decisions).

**c. Common Task Test (CTT).** The CTT is a hands-on test to evaluate proficiency on critical combat and survival tasks. A new CTT is fielded each year, based on STP 21-1-SMCT and STP 21-24-SMCT. Refer to AR 350-1 for details on test administration and scoring. Units may administer the CTT *any time* during the test period. CTT evaluations should be integrated with training exercises to conserve resources and improve realism. For example, units could test soldiers on CTT tasks during—

- MTP evaluations and other collective training activities.
- Weapons qualification.
- Gas chamber training.
- Stations in a soldier battlefield course or military stakes competition.

The CTT is a routine part of the training schedule; it is a major event on the unit calendar. Like the leader's assessment, CTT results are objective measures for the commander to use to evaluate unit readiness and the

effectiveness of the training program. Leaders also consider CTT results when preparing enlisted evaluation reports and recommending soldiers for promotion.

### 1-3. SMCT FEATURES

a. **Common Task Training Plan.** The common task training plan (chapter 2) lists, by skill level, the critical common tasks for which all soldiers are responsible. It indicates where each task is first taught to standard and how often training on the task is required to sustain proficiency. Leaders should use this information to develop a comprehensive unit training plan.

b. **Task Summary.** Each task summary documents the performance requirements of a critical common task. The summaries provide the soldier and the trainer with the information necessary to evaluate the critical tasks. The task summaries use the following format:

- **Task Title.** The task title identifies the action to be performed.
- **Task Number.** A ten-digit number identifies each task. The first three digits of the number represent the proponent code for that task. (A list of the proponent codes is given in appendix A.) Include the entire ten-digit task number, along with the task title, in any correspondence relating to the task.
- **Conditions.** The task conditions identify all the equipment, tools, materials, references, job aids, and supporting personnel the soldier needs to perform the task. This section identifies environmental conditions that can alter task performance (such as visibility, temperature, or wind). This section also identifies specific cues or events (such as a chemical attack or identification of an unexploded ordnance hazard) that trigger task performance.
- **Standard.** A task standard specifies the requirements for task performance by indicating how well, completely, or accurately a product must be produced, a process must be performed, or both. Standards are described in terms of accuracy, tolerances, completeness, format, clarity, number of errors, quantity, sequence, or speed of performance.
- **Training and Evaluation Guide.** This section has two parts. The first part, Performance Steps, lists the individual steps the soldier must complete to perform the task. The second part is the Performance Evaluation Guide. This provides guidance on how to evaluate a soldier's performance of the task. It is composed of three subsections. The *Evaluation Preparation* subsection identifies special setup procedures and, if required, instructions for evaluating the task performance. Sometimes the conditions and standard must be modified so the task can be evaluated in a situation that does not exactly duplicate actual field performance. This subsection may also include instructions the evaluator should give to the soldier before the performance test. The *Performance Measures* subsection identifies the

criteria for acceptable task performance. The soldier is rated (GO/NO GO) on each specific action or specific product produced. As indicated in the *Evaluation Guidance* subsection, the soldier must score a GO on all (or each specified) performance measure to receive a GO on the task.

- **References.** This section identifies references that provide more detailed and thorough explanations of task performance requirements than that given in the task summary description. This section identifies resources the soldier can use to improve or maintain performance.

Additionally, task summaries can include safety statements, environmental considerations, and notes. Safety statements (danger, warning, caution) alert users to the possibility of immediate death, personal injury, or damage to equipment. Notes provide additional information to support task performance.

**c. Training Support.** This manual includes the following that provide additional training support information.

- Appendix A (Proponent School and Agency Codes)—lists the task proponents and agency codes (first three digits of the task number) with addresses for submitting comments concerning specific tasks in this manual.

- Appendix B (Guide to Forms)—explains the use of various SMCT training and evaluation forms and, in the online version, provides links to the forms.

- Glossary—lists abbreviations and acronyms and their definitions.

- References—lists all reference materials cited in the task summaries by type, identification number, title, and date.

#### **1-4. CONDUCTING COMMON TASK TRAINING AND EVALUATION**

**a. Role of the Commander.** As a commander, you must ensure that your training plan prepares the unit for the full spectrum of operations. The plan should enable your soldiers to develop and sustain proficiency on the MOS-specific and common tasks for their skill level. Use critical common task summaries to evaluate your soldiers' proficiency on those tasks critical to your unit mission. An effective training program converts unproductive time into effective training time. This will upgrade the skills of individual soldiers and promote the development of junior leaders. To develop an effective unit training program we reiterate, from the STP 21-1-SMCT, the following seven-step approach—

**Step 1.** Set the objectives for training.

**Step 2.** Plan the resources (personnel, time, funds, facilities, devices, training aids).

**Step 3.** Train the trainers.

**Step 4.** Provide the resources.

**Step 5.** Manage risks, environmental and safety considerations.

**Step 6.** Conduct the training.

**Step 7.** Evaluate the results.

**b. Role of the Trainer.** Although training is everyone's business, you, the NCO, are the key to training the individual soldiers assigned to your unit. You should be the first to recognize which tasks each soldier can or cannot perform. You must ensure each soldier takes steps to master these tasks. This manual will assist you, the trainer, in doing what trainers do best—train. To train effectively, you must perform the following functions.

**(1) Plan the training.** You can usually integrate or conduct training for specific common tasks concurrently with other training or during slack periods. Use the Common Task Training Plan in chapter 2 to identify the critical common tasks for which each soldier is responsible.

**(2) Prepare yourself.** Get training guidance from your chain of command on when to train, what to train, and what resources are available. Know the training objectives for each task and ensure you can perform the task. Gather the necessary training references for each task, as listed in the task summary.

**(3) Obtain the resources.** Gather the required resources and prepare the training site according to the conditions statement and the evaluation preparation section of the task summary. Ensure equipment needed to complete the task is operational. Coordinate the use of training aids and devices.

**(4) Train the soldiers.** Show the soldiers how to do the task to standard and explain each step. Give each soldier at least one chance to perform the task.

**(5) Evaluate the soldiers.** Evaluate how well the soldiers perform. You may conduct the evaluation during individual training or while evaluating individual performance during the conduct of unit collective tasks. Use the Common Task Training Plan to determine how often to check soldiers to ensure they maintain proficiency.

**(6) Record the results.** Record the GO/NO GO results in the leader book. You may use DA Form 5165-R; see the Guide to Forms (appendix B) at the end of this publication. Do not make written entries directly on the evaluation guides in the SMCT.

**(7) Retrain and reevaluate.** Work with soldiers until they can perform the task to specific soldier's manual standard.

---

*Good training increases the professionalism of each soldier and helps to develop an efficient unit. You are a vital link in the conduct of good training.*

---





**Chapter 2**  
**Training Guide**

**2-1. COMMON TASK TRAINING PLAN**

The Common Task Training Plan provides information to help the trainer plan, prepare, train, evaluate, and monitor individual training in units. It lists, by general subject area and skill level, the critical common tasks soldiers must perform, the initial training location, and a suggested frequency of training. The training location column uses brevity codes to indicate where the task is first taught to standards. If the task is taught in the unit the word "UNIT" appears in this column. "SD" indicates tasks trained via self-development media. If it is taught in the training base, the brevity code (BCT, OSUT, AIT) of the resident course appears. Brevity codes and resident courses are listed below.

ANCOC	Advanced NCO Course
BNCOC	Basic NCO Course
PLDC	Primary Leadership Development Course
BCT	Basic Combat Training
OSUT	One Station Unit Training
AIT	Advanced Individual Training
UNIT	Trained in/by the Unit
SD	Self-Development Training

The sustainment training column lists how often (frequency) soldiers should train on the task to ensure they maintain their proficiency. This information is not a requirement, but rather a guide the commander can use to develop a comprehensive unit training plan. The commander, with the unit trainers, is in the best position to determine on which tasks and how often soldiers need training to maintain unit readiness.

<b>Frequency Codes</b>	
AN	Annually
SA	Semi-Annually
QT	Quarterly

<b>Common Task Training Plan</b>			
<i>Task Number</i>	<i>Title</i>	<i>Training Location</i>	<i>Sustainment Training Frequency</i>
<b>Skill Level 1</b>			
<b>Subject Area 1. Individual Conduct and Laws of War</b>			
<b>181-101-1013</b>	Comply with the Uniform Code of Military Justice (UCMJ)	BCT/OSUT	AN
<b>181-105-1001</b>	Comply with the Law of War and the Geneva and Hague Conventions	BCT/OSUT	AN
<b>224-176-1425</b>	Interact with News Media	BCT/OSUT	AN
<b>331-202-1049</b>	Comply with the Requirements of the Code of Conduct	BCT/OSUT	AN
<b>805C-PAD-1245</b>	Support Unit and Family Readiness Through the Army Family Team Building (AFTB) Program	BCT/OSUT	AN
<b>805C-PAD-1391</b>	Comply with the Army's Equal Opportunity and Sexual Harassment Policies	BCT/OSUT	AN
<b>Subject Area 2. First Aid</b>			
<b>081-831-1000</b>	Evaluate a Casualty	BCT/OSUT	AN
<b>081-831-1003</b>	Perform First Aid to Clear an Object Stuck in the Throat of a Conscious Casualty	BCT/OSUT	AN
<b>081-831-1005</b>	Perform First Aid to Prevent or Control Shock	BCT/OSUT	AN
<b>081-831-1007</b>	Perform First Aid for Burns	BCT/OSUT	AN

<b>Common Task Training Plan</b>			
<b>Task Number</b>	<b>Title</b>	<b>Training Location</b>	<b>Sustainment Training Frequency</b>
081-831-1008	Perform First Aid for Heat Injuries	UNIT	AN
081-831-1025	Perform First Aid for an Open Abdominal Wound	UNIT	AN
081-831-1026	Perform First Aid for an Open Chest Wound	UNIT	AN
081-831-1032	Perform First Aid for Bleeding of an Extremity	BCT/OSUT	AN
081-831-1033	Perform First Aid for an Open Head Wound	BCT/OSUT	AN
081-831-1034	Perform First Aid for a Suspected Fracture	BCT/OSUT	AN
081-831-1042	Perform Mouth-to-Mouth Resuscitation	BCT/OSUT	SA
081-831-1044	Perform First Aid for Nerve Agent Injury	BCT/OSUT	QT
081-831-1045	Perform First Aid for Cold Injuries	UNIT	AN
081-831-1046	Transport a Casualty	BCT/OSUT	AN
081-831-1053	Practice Individual Preventive Medicine Countermeasures	BCT/OSUT	SA
<b>Subject Area 3. Nuclear, Biological, and Chemical (NBC)</b>			
031-503-1013	Decontaminate Yourself and Individual Equipment Using Chemical Decontaminating Kits	BCT/OSUT	AN

<b>Common Task Training Plan</b>			
<b>Task Number</b>	<b>Title</b>	<b>Training Location</b>	<b>Sustainment Training Frequency</b>
<b>031-503-1015</b>	Protect Yourself from NBC Injury/Contamination with Mission-Oriented Protective Posture (MOPP) Gear	BCT/OSUT	AN
<b>031-503-1017</b>	Respond to Depleted Uranium	BCT/OSUT	AN
<b>031-503-1018</b>	React to Nuclear Hazard/Attack	BCT/OSUT	AN
<b>031-503-1019</b>	React to Chemical or Biological Hazard/Attack	BCT/OSUT	AN
<b>031-503-1035</b>	Protect Yourself from Chemical/Biological Contamination Using Your Assigned Protective Mask	BCT/OSUT	AN
<b>031-503-1036</b>	Maintain Your Assigned Protective Mask	BCT/OSUT	AN
<b>031-503-1037</b>	Detect Chemical Agents Using M8 or M9 Detector Paper	BCT/OSUT	AN
<b>Subject Area 4. Survive (Combat Techniques)</b>			
<b>052-192-1042</b>	Perform Self-Extraction From a Mined Area	AIT	QT
<b>052-192-1242</b>	Locate Mine and Booby Trap Indicators by Visual Means	AIT	AN
<b>071-326-0502</b>	Move Under Direct Fire	BCT/OSUT	SA
<b>071-326-0503</b>	Move Over, Through, or Around Obstacles (Except Minefields)	BCT/OSUT	SA

<b>Common Task Training Plan</b>			
<b>Task Number</b>	<b>Title</b>	<b>Training Location</b>	<b>Sustainment Training Frequency</b>
071-326-0510	React to Indirect Fire While Dismounted	BCT/OSUT	SA
071-326-0511	React to Flares	BCT/OSUT	SA
071-326-0513	Select Temporary Fighting Positions	BCT/OSUT	SA
071-326-3002	React to Indirect Fire While Mounted	UNIT	AN
071-326-5703	Construct Individual Fighting Positions	BCT/OSUT	SA
071-331-0815	Practice Noise, Light, and Litter Discipline	BCT/OSUT	SA
071-331-1004	Perform Duty as a Guard	BCT/OSUT	AN
071-410-0002	React to Direct Fire While Mounted	UNIT	AN
071-710-0006	Plan Use of Night Vision Devices	UNIT	SA
093-401-5040	React to Unexploded Ordnance Hazards	UNIT	SA
551-88M-0005	Operate a Vehicle in a Convoy	UNIT	SA
<b>Subject Area 5. Navigate</b>			
071-329-1006	Navigate from One Point on the Ground to Another Point While Dismounted	BCT/OSUT	SA
071-329-1030	Navigate from One Point on the Ground to Another Point While Mounted	UNIT	SA

<b>Common Task Training Plan</b>			
<b>Task Number</b>	<b>Title</b>	<b>Training Location</b>	<b>Sustainment Training Frequency</b>
<b>Subject Area 6. Communicate</b>			
113-571-1022	Perform Voice Communications	BCT/OSUT	SA
113-600-2001	Communicate Via a Tactical Telephone	BCT/OSUT	AN
113-637-2001	Communicate Via a Tactical Radio in a Secure Net	BCT/OSUT	AN
<b>Subject Area 7. See</b>			
071-331-0804	Perform Surveillance Without the Aid of Electronic Devices	UNIT	SA
071-730-0014	Identify Combat Vehicles	UNIT	SA
<b>Subject Area 8. Hand Grenades and Land Mines</b>			
071-325-4401	Perform Safety Checks on Hand Grenades	BCT/OSUT	SA
071-325-4407	Employ Hand Grenades	BCT/OSUT	SA
071-325-4425	Employ an M18A1 Claymore Mne	BCT/OSUT	QT
<b>Subject Area 9. M16-Series Rifle</b>			
071-008-0007	Engage Targets with an M16-Series Rifle Using an AN/PAS-13 Series Thermal Weapon Sight	BCT/OSUT	AN
071-311-2025	Maintain an M16-Series Rifle	BCT/OSUT	SA
071-311-2027	Load an M16-Series Rifle	BCT/OSUT	SA

<b>Common Task Training Plan</b>			
<b>Task Number</b>	<b>Title</b>	<b>Training Location</b>	<b>Sustainment Training Frequency</b>
071-311-2028	Unload an M16-Series Rifle	BCT/OSUT	SA
071-315-2308	Engage Targets with an M16-Series Rifle Using a Night Vision Sight AN/PVS-4	BCT/OSUT	QT
<b>Subject Area 10. M240B Machine Gun</b>			
071-000-0005	Prepare a Range Card for a Machine Gun	UNIT	SA
071-025-0001	Maintain an M240B Machine Gun	AIT	QT
071-025-0003	Load an M240B Machine Gun	AIT	QT
071-025-0004	Unload an M240B Machine Gun	AIT	QT
071-025-0007	Engage Targets with an M240B Machine Gun	AIT	QT
<b>Subject Area 11. M249 Machine Gun</b>			
071-010-0006	Engage Targets with an M249 Machine Gun	BCT/OSUT	AN
071-312-4025	Maintain an M249 Machine Gun	BCT/OSUT	QT
071-312-4027	Load an M249 Machine Gun	BCT/OSUT	AN
071-312-4028	Unload an M249 Machine Gun	BCT/OSUT	AN
<b>Subject Area 12. M60 Machine Gun</b>			
071-312-3025	Maintain an M60 Machine Gun	UNIT	SA

<b>Common Task Training Plan</b>			
<b>Task Number</b>	<b>Title</b>	<b>Training Location</b>	<b>Sustainment Training Frequency</b>
071-312-3027	Load an M60 Machine Gun	UNIT	SA
071-312-3028	Unload an M60 Machine Gun	UNIT	SA
071-312-3031	Engage Targets with an M60 Machine Gun	UNIT	SA
<b>Subject Area 13. MK19 Machine Gun</b>			
071-030-0001	Maintain an MK19 Machine Gun	UNIT	AN
071-030-0004	Engage Targets with an MK19 Machine Gun	UNIT	AN
071-030-0005	Load an MK19 Machine Gun	UNIT	AN
071-030-0006	Unload an MK19 Machine Gun	UNIT	AN
071-030-0007	Perform a Function Check on an MK19 Machine Gun	UNIT	AN
<b>Subject Area 14. Caliber .50 M2 Machine Gun</b>			
071-022-0001	Maintain a Caliber .50 M2 Machine Gun	UNIT	QT
071-022-0003	Load a Caliber .50 M2 Machine Gun	UNIT	QT
071-022-0004	Unload a Caliber .50 M2 Machine Gun	UNIT	QT
071-313-3454	Engage Targets with a Caliber .50 M2 Machine Gun	UNIT	QT



<b>Common Task Training Plan</b>			
<b>Task Number</b>	<b>Title</b>	<b>Training Location</b>	<b>Sustainment Training Frequency</b>
<b>Subject Area 15. M136 Launcher</b>			
071-054-0001	Prepare an M136 Launcher for Firing	BCT/OSUT	AN
071-054-0002	Restore an M136 Launcher to Carrying Configuration	BCT/OSUT	AN
<b>Subject Area 16. M203 Grenade Launcher</b>			
071-311-2125	Maintain an M203 Grenade Launcher	BCT/OSUT	QT
071-311-2127	Load an M203 Grenade Launcher	BCT/OSUT	QT
071-311-2128	Unload an M203 Grenade Launcher	BCT/OSUT	QT
071-311-2129	Correct Malfunctions of an M203 Grenade Launcher	BCT/OSUT	QT
071-311-2130	Engage Targets with an M203 Grenade Launcher	BCT/OSUT	QT
<b>Subject Area 17. M4 Carbine</b>			
071-100-0003	Engage Targets with an M4 or M4A1 Carbine	UNIT	AN
071-100-0004	Maintain an M4 or M4A1 Carbine	UNIT	AN
<b>Subject Area 18. 9-mm Pistol</b>			
071-004-0001	Maintain an M9 Pistol	UNIT	AN
071-004-0003	Load an M9 Pistol	UNIT	AN
071-004-0004	Unload an M9 Pistol	UNIT	AN
071-004-0006	Engage Targets with an M9 Pistol	UNIT	AN

<b>Common Task Training Plan</b>			
<b>Task Number</b>	<b>Title</b>	<b>Training Location</b>	<b>Sustainment Training Frequency</b>
<b>Subject Area 19. Crowd Control</b>			
191-376-4121	Use a Riot Baton	BCT/OSUT	QT
191-376-4122	Position Yourself in Riot Control Formations	BCT/OSUT	QT
<b>Subject Area 20. Casualty Reporting and Handling</b>			
101-515-1997	Inter Isolated Remains (After Receiving Authorization)	BCT/OSUT	SA
101-515-1998	Evacuate Isolated Remains	BCT/OSUT	SA
101-515-1999	Recover Isolated Remains	BCT/OSUT	SA
<b>Subject Area 21. Defense Measures</b>			
052-191-1361	Camouflage Yourself and Your Individual Equipment	BCT/OSUT	QT
052-191-1362	Camouflage Equipment	UNIT	SA
191-376-4114	Control Entry to and Exit from a Restricted Area	BCT/OSUT	SA
301-371-1000	Report Intelligence Information	BCT/OSUT	AN
301-371-1050	Implement Operations Security (OPSEC) Measures	UNIT	AN

<b>Common Task Training Plan</b>			
<i>Task Number</i>	<i>Title</i>	<i>Training Location</i>	<i>Sustainment Training Frequency</i>
<b>Skill Level 2</b>			
<b>Subject Area 1. Individual Conduct and Laws of War</b>			
<b>181-101-2023</b>	Enforce the Uniform Code of Military Justice (UCMJ)	PLDC	AN
<b>181-105-2001</b>	Enforce the Law of War and the Geneva and Hague Conventions	UNIT	AN
<b>181-105-2002</b>	Conduct Combat Operations According to the Law of War	UNIT	AN
<b>224-176-2426</b>	Enforce Compliance with Media Ground Rules	UNIT	SA
<b>331-202-1050</b>	Enforce Compliance with the Code of Conduct	UNIT	AN
<b>805C-PAD-2503</b>	Enforce Compliance with the Army's Equal Opportunity and Sexual Harassment Policies	PLDC	QT
<b>Subject Area 2. First Aid</b>			
<b>081-831-0101</b>	Request Medical Evacuation	PLDC	AN
<b>081-831-1054</b>	Evacuate Casualties	PLDC	SA
<b>081-831-9000</b>	Implement Preventive Medicine Measures (PMM)	PLDC	SA

<b>Common Task Training Plan</b>			
<b>Task Number</b>	<b>Title</b>	<b>Training Location</b>	<b>Sustainment Training Frequency</b>
<b>Subject Area 3. Nuclear, Biological, and Chemical (NBC)</b>			
<b>031-503-1023</b>	Protect Yourself From Nuclear, Biological, and Chemical (NBC) Injury/Contamination When Changing Mission-Oriented Protective Posture (MOPP) Gear	UNIT	SA
<b>031-503-2001</b>	Identify Chemical Agents Using M256-Series Chemical Agent Detector Kit	UNIT	SA
<b>031-503-2023</b>	Measure Radiation Dose Rate and Total Dose	UNIT	SA
<b>031-503-3002</b>	Conduct Unmasking Procedures	UNIT	SA
<b>031-503-3004</b>	Supervise the Crossing of a Contaminated Area	UNIT	SA
<b>031-503-3005</b>	Submit an NBC 1 Report	UNIT	SA
<b>031-503-3008</b>	Implement Mission-Oriented Protective Posture (MOPP)	UNIT	SA
<b>031-503-3010</b>	Supervise the Employment of Nuclear, Biological, and Chemical (NBC) Markers	UNIT	AN

<b>Common Task Training Plan</b>			
<b>Task Number</b>	<b>Title</b>	<b>Training Location</b>	<b>Sustainment Training Frequency</b>
<b>031-503-4002</b>	Supervise Unit Preparation for a Nuclear, Biological, and Chemical (NBC) Attack	UNIT	AN
<b>031-506-1053</b>	Report NBC Information Using NBC 4 Report	UNIT	SA
<b>031-506-2061</b>	Conduct a Mask Fit Test	UNIT	QT
<b>Subject Area 4. Survive (Combat Techniques)</b>			
<b>061-283-6003</b>	Adjust Indirect Fire	UNIT	QT
<b>071-326-0608</b>	Use Visual Signaling Techniques	PLDC	SA
<b>071-326-5704</b>	Supervise Construction of a Fighting Position	PLDC	AN
<b>071-326-5705</b>	Establish an Observation Post	PLDC	AN
<b>Subject Area 5. Navigate</b>			
<b>071-329-1019</b>	Use a Map Overlay	UNIT	QT
<b>Subject Area 20. Casualty Reporting and Handling</b>			
<b>805C-PAD-2060</b>	Report Casualties	UNIT	SA
<b>Subject Area 21. Defense Measures</b>			
<b>071-430-0002</b>	Conduct a Defense by a Squad	PLDC	SA

<b>Common Task Training Plan</b>			
<b>Task Number</b>	<b>Title</b>	<b>Training Location</b>	<b>Sustainment Training Frequency</b>
<b>Subject Area 22. Unit Operations</b>			
<b>071-326-5502</b>	Issue a Fragmentary Order	PLDC	QT
<b>071-326-5503</b>	Issue a Warning Order	PLDC	QT
<b>551-88N-0002</b>	Prepare for Unit Move	UNIT	QT
<b>Subject Area 23. Security and Control</b>			
<b>301-371-1200</b>	Process Captured Materiel	UNIT	AN
<b>Subject Area 25. Equipment Checks</b>			
<b>091-CLT-4029</b>	Supervise Preventive Maintenance Checks and Services (PMCS)	PLDC	QT
<b>101-92Y-0003</b>	Enforce Compliance with Supply Discipline Procedures	PLDC	SA
<b>101-92Y-0004</b>	Enforce Property Accountability Policies	PLDC	SA
<b>101-92Y-0005</b>	Enforce Compliance with Property Accountability Policies	PLDC	SA
<b>101-92Y-0006</b>	Inspect Equipment for Accountability, Cleanliness, and Serviceability	UNIT	QT

<b>Common Task Training Plan</b>			
<b>Task Number</b>	<b>Title</b>	<b>Training Location</b>	<b>Sustainment Training Frequency</b>
<b>Subject Area 27. Risk Management</b>			
<b>850-001-2000</b>	Employ Accident Prevention Measures and Risk Management Process	PLDC	QT
<b>Subject Area 28. Administration/Management</b>			
<b>805C-PAD-2044</b>	Recommend Individual for Award	PLDC	QT
<b>805C-PAD-2145</b>	Counsel a Soldier on the Contents of a Noncommissioned Officer Evaluation Report and NCOER Checklist	PLDC	QT
<b>805C-PAD-2146</b>	Prepare the Rater's Portion of a Noncommissioned Officer Evaluation Report (NCOER)	PLDC	AN
<b>805C-PAD-2402</b>	Provide Input on Personnel Actions Affecting Subordinates	PLDC	QT
<b>805C-PAD-2407</b>	Recommend Disciplinary Action for a Soldier	PLDC	AN
<b>805C-PAD-2461</b>	Maintain Accountability of Personnel (Status Report)	UNIT	SA
<b>805C-PAD-2472</b>	Prepare a Duty Roster	UNIT	AN

<b>Common Task Training Plan</b>			
<i>Task Number</i>	<i>Title</i>	<i>Training Location</i>	<i>Sustainment Training Frequency</i>
<b>Skill Level 3</b>			
<b>Subject Area 1. Individual Conduct and Laws of War</b>			
<b>805C-PAD-3238</b>	Enforce the Equal Opportunity Program	BNCOC	QT
<b>Subject Area 4. Survive (Combat Techniques)</b>			
<b>052-192-4053</b>	Supervise Minefield Breaching Operations	UNIT	SA
<b>071-410-0012</b>	Conduct Occupation of an Assembly Area	BNCOC	SA
<b>071-420-0021</b>	Conduct a Movement to Contact by a Platoon	BNCOC	SA
<b>071-430-0028</b>	Consolidate a Unit	BNCOC	SA
<b>071-430-0029</b>	Reorganize a Unit	BNCOC	SA
<b>Subject Area 5. Navigate</b>			
<b>071-332-5000</b>	Prepare an Operation Overlay	BNCOC	QT
<b>Subject Area 19. Crowd Control</b>			
<b>191-378-4302</b>	Form Squad-Size Riot Control Formations	UNIT	AN
<b>Subject Area 21. Defense Measures</b>			
<b>052-195-3066</b>	Direct Construction of Nonexplosive Obstacles	UNIT	AN
<b>071-410-0019</b>	Control Organic Fires	UNIT	SA



<b>Common Task Training Plan</b>			
<b>Task Number</b>	<b>Title</b>	<b>Training Location</b>	<b>Sustainment Training Frequency</b>
<b>441-091-3000</b>	Supervise the Implementation of Air Defense Measures	UNIT	AN
<b>Subject Area 22. Unit Operations</b>			
<b>071-326-3013</b>	Conduct a Tactical Road March	BNCOC	QT
<b>071-326-5805</b>	Conduct a Route Reconnaissance Mission	UNIT	QT
<b>071-332-5021</b>	Prepare a Situation Map	UNIT	QT
<b>071-720-0015</b>	Conduct an Area Reconnaissance by a Platoon	UNIT	QT
<b>101-92Y-0002</b>	Plan Tactical Resupply Operations	BNCOC	SA
<b>301-371-1150</b>	Identify Intelligence and Electronic Warfare (IEW) Assets	BNCOC	AN
<b>551-88M-0001</b>	Lead a Convoy Serial/March Unit	UNIT	SA
<b>551-88N-0003</b>	Plan Unit Move	UNIT	SA
<b>Subject Area 23. Security and Control</b>			
<b>191-379-4407</b>	Plan Convoy Security Operations	UNIT	QT

<b>Common Task Training Plan</b>			
<b>Task Number</b>	<b>Title</b>	<b>Training Location</b>	<b>Sustainment Training Frequency</b>
<b>301-371-1052</b>	Protect Classified Information and Material	UNIT	AN
<b>805C-PAD-3594</b>	Store Classified Information and Materials	UNIT	AN
<b>Subject Area 24. Enemy Personnel</b>			
<b>191-379-4450</b>	Supervise Handling of Enemy Personnel and Equipment at Squad Level	UNIT	AN
<b>Subject Area 27. Risk Management</b>			
<b>850-001-3001</b>	Control Mission Safety Hazard	UNIT	QT
<b>Subject Area 28. Administration/Management</b>			
<b>805C-PAD-3147</b>	Prepare the Senior Rater's Portion of a Noncommissioned Officer Evaluation Report (NCOER)	UNIT	AN

<b>Common Task Training Plan</b>			
<b>Task Number</b>	<b>Title</b>	<b>Training Location</b>	<b>Sustainment Training Frequency</b>
<b>Skill Level 4</b>			
<b>Subject Area 2. First Aid</b>			
<b>081-831-1047</b>	Supervise the Implementation of Preventive Medicine Policies	UNIT	AN
<b>081-831-1055</b>	Ensure Unit Combat Lifesaver Requirements Are Met	UNIT	SA
<b>Subject Area 4. Survive (Combat Techniques)</b>			
<b>071-326-5775</b>	Coordinate with an Adjacent Platoon	ANCOC	QT
<b>101-CLT-0198</b>	Supervise Tactical Feeding Operation	UNIT	QT
<b>Subject Area 19. Crowd Control</b>			
<b>191-379-5400</b>	Form the Platoon into a Riot Control Formation	UNIT	SA
<b>Subject Area 21. Defense Measures</b>			
<b>071-430-0006</b>	Conduct a Defense by a Platoon	ANCOC	QT
<b>Subject Area 22. Unit Operations</b>			
<b>091-CLT-3009</b>	Supervise Maintenance Operations	ANCOC	QT
<b>101-92Y-0001</b>	Supervise Supply Activities	UNIT	QT

<b>Common Task Training Plan</b>			
<b>Task Number</b>	<b>Title</b>	<b>Training Location</b>	<b>Sustainment Training Frequency</b>
<b>151-357-0001</b>	Supervise CSS Functions During Platoon Operations	ANCOC	AN
<b>151-357-0002</b>	Coordinate Combat Service Support (CSS) Operations	ANCOC	AN
<b>159-200-2020</b>	Integrate Threat Capabilities into Mission Planning	ANCOC	QT
<b>181-101-4001</b>	Conduct a Search/Seizure	ANCOC	SA
<b>551-721-4326</b>	Perform Duties as Convoy Commander	UNIT	SA
<b>Subject Area 23. Security and Control</b>			
<b>191-379-4408</b>	Plan Security for a Command Post (CP)	UNIT	SA
<b>Subject Area 26. Crime Prevention</b>			
<b>191-379-4425</b>	Implement the Unit's Crime Prevention Program	UNIT	AN
<b>Subject Area 27. Risk Management</b>			
<b>850-001-4001</b>	Integrate Risk Management into Mission Plans	ANCOC	QT
<b>Subject Area 28. Administration/Management</b>			
<b>805C-PAD-4359</b>	Manage Soldier's Deployment Requirements	UNIT	SA

<b>Common Task Training Plan</b>			
<b>Task Number</b>	<b>Title</b>	<b>Training Location</b>	<b>Sustainment Training Frequency</b>
<b>805C-PAD-4550</b>	Prepare a Standing Operating Procedure (SOP)	ANCOC	SA
<b>805C-PAD-4597</b>	Integrate Newly Assigned Soldiers	UNIT	QT

**2-2. SUBJECT AREA CODES .**

Below is a list of subject areas contained in this STP. Table 2-1 shows the relationship of subject areas between this STP and STP 21-1-SMCT.

**Skill Level 2**

- 1 Individual Conduct and Laws of War
- 2 First Aid
- 3 Nuclear, Biological, and Chemical (NBC)
- 4 Survive (Combat Techniques)
- 5 Navigate
- 20 Casualty Reporting and Handling
- 21 Defense Measures
- 22 Unit Operations
- 23 Security and Control
- 25 Equipment Checks
- 27 Risk Management
- 28 Administration/Management

**Skill Level 3**

- 1 Individual Conduct and Laws of War
- 4 Survive (Combat Techniques)
- 5 Navigate
- 19 Crowd Control
- 21 Defense Measures

- 22 Unit Operations
- 23 Security and Control
- 24 Enemy Personnel
- 27 Risk Management
- 28 Administration/Management

**Skill Level 4**

- 2 First Aid
- 4 Survive (Combat Techniques)
- 19 Crowd Control
- 21 Defense Measures
- 22 Unit Operations
- 23 Security and Control
- 26 Crime Prevention
- 27 Risk Management
- 28 Administration/Management

Table 2-1. Subject Areas in the Soldiers Manuals of Common Tasks					
<b>Note.</b> Columns at right indicate subject areas included in each manual, by skill level.					
Subject Area		STP 21-1-SMCT	STP 21-24-SMCT		
		SL 1	SL 2	SL 3	SL 4
1	Individual Conduct and Laws of War	✳	✳	✳	
2	First Aid	✳	✳		✳
3	Nuclear, Biological, and Chemical (NBC)	✳	✳		
4	Survive (Combat Techniques)	✳	✳	✳	✳
5	Navigate	✳	✳	✳	
6	Communicate	✳			
7	See	✳			
8	Hand Grenades and Land Mines	✳			
9	M16-Series Rifle	✳			
10	M240B Machine Gun	✳			
11	M249 Machine Gun	✳			
12	M60 Machine Gun	✳			
13	MK19 Machine Gun	✳			
14	Caliber .50 M2 Machine Gun	✳			
15	M136 Launcher	✳			
16	M203 Grenade Launcher	✳			
17	M4 Carbine	✳			
18	9-mm Pistol	✳			
19	Crowd Control	✳		✳	✳
20	Casualty Reporting and Handling	✳	✳		
21	Defense Measures	✳	✳	✳	✳
22	Unit Operations		✳	✳	✳
23	Security and Control		✳	✳	✳
24	Enemy Personnel			✳	
25	Equipment Checks		✳		
26	Crime Prevention				✳
27	Risk Management		✳	✳	✳
28	Administration/Management		✳	✳	✳





Chapter 3  
Skill Levels 2, 3, and 4 Tasks

Skill Level 2

**SUBJECT AREA 1: INDIVIDUAL CONDUCT AND LAWS OF WAR**

Skill Level 2

**181-101-2023**

**Enforce the Uniform Code of Military Justice (UCMJ)**

**Conditions:** You are a noncommissioned officer (NCO) in a leadership position in the U.S. Army. You are responsible for understanding that disciplinary action against a soldier for misconduct is a command responsibility. You are responsible for understanding the military justice system, including the Uniform Code of Military Justice (UCMJ) and disciplinary options available to a commander. You are responsible for identifying potential violations of the UCMJ and expeditiously reporting them to the appropriate authorities for investigation and processing.

**Standards:** Understood that disciplinary action against a soldier for misconduct was a command responsibility. Understood the military justice system, including the Uniform Code of Military Justice (UCMJ) and the disciplinary options available to a commander. Identified potential violations of the UCMJ and expeditiously reported them to the appropriate authorities for investigation and processing.

**Performance Steps**

1. Describe how disciplinary action against a soldier is a command responsibility.
2. Identify who has authority to take disciplinary action against a soldier for misconduct.
3. Describe a soldier's responsibility to identify potential or actual violations of the Uniform Code of Military Justice (UCMJ) and expeditiously report these violations to the appropriate authorities for investigation and processing.
4. Describe a commander's responsibility to conduct a preliminary investigation into misconduct allegedly committed by a soldier under his command.
  - a. Describe the basis and procedures of a commander's inquiry.
  - b. Describe the basis and procedures of an AR 15-6 investigation.

**Performance Steps**

- c. Describe the requirement for the military police or Criminal Investigation Division (CID) to conduct a criminal investigation.
5. List the disciplinary options available to the commander.
- a. Describe how a commander can take no action at all or close a case.
- b. Describe how a commander can use administrative or nonpunitive measures.
- (1) List administrative or nonpunitive disciplinary measures available to a commander.
- (2) Describe why a commander would wish to use nonpunitive or administrative disciplinary measures rather than impose nonjudicial punishment or proceed to court-martial.
- (3) Describe how an NCO leader may be involved in the imposition of nonpunitive or administrative disciplinary measures (such as counseling or corrective training) to a subordinate soldier.
- c. Describe how a commander can use nonjudicial punishment.
- (1) Define nonjudicial punishment.
- (2) List the different types of nonjudicial punishment.
- (3) Describe nonjudicial punishment procedures.
- (4) Describe a soldier's legal rights during nonjudicial punishment procedures.
- (5) List the maximum punishment available under nonjudicial punishment.
- (6) Describe a soldier's appellate rights under nonjudicial punishment.
- d. Describe how a commander can use judicial punishment.
- (1) Define judicial punishment.
- (2) List the different types of court-martial in the military justice system.
- (3) Describe judicial or court-martial procedures.
- (4) Describe a soldier's legal rights during judicial or court-martial punishment.
- (5) List the maximum punishment available under judicial or court-martial punishment.
- (6) Describe a soldier's appellate rights under judicial or court-martial punishment.

---

**Performance Steps**

---

- 6.** List factors a commander should consider when determining what disciplinary option to pursue.
- a.** Describe whether a commander should consider the character and military service of the accused.
  - b.** Describe whether a commander should consider the nature and circumstances of the offense and the extent of the harm caused.
  - c.** Describe whether a commander should consider the needs of the Service and the probable effect of his or her decision on the command and the military community.
  - d.** Describe whether a commander should consider the disposition of similar offenses in the past and the general disciplinary trends within the command.
  - e.** Describe whether a commander should consider the appropriateness of the authorized punishment to the particular accused and offense.
  - f.** Describe whether a commander should determine whether he has jurisdiction over the accused and the offense.
  - g.** Describe whether a commander should consider the availability and admissibility of evidence against the accused.
  - h.** Describe whether a commander should consider the cooperation of the accused in the apprehension or conviction of others.
  - i.** Describe whether a commander should consider the possible improper motives of the accuser.
  - j.** Describe whether a commander should consider that the victim or others are reluctant to testify.
- 7.** Describe the permissibility of a commander discussing and gaining input from an NCO leader regarding which disciplinary option to pursue against a subordinate soldier within the unit.
- 8.** Describe the authority of an NCO to issue a lawful order to a subordinate soldier.
- a.** Describe the duty of a subordinate soldier to follow this order.
  - b.** Describe the potential adverse ramifications for a soldier violating this order.
  - c.** Describe the elements and maximum punishment available under Article 91, UCMJ.
- 

Skill Level 2

**Evaluation Preparation:**

*Setup:* Evaluate this task at the end of military justice training.

*Brief Soldier:* Tell the soldier that he will be evaluated on his ability to understand that disciplinary action against a soldier for misconduct is a command responsibility. Tell the soldier that he will also be evaluated on his ability to understand the military justice system, including the UCMJ; the disciplinary options available to a commander; and the ability to identify potential violations of the UCMJ and expeditiously report them to the appropriate authorities for investigation and processing.

Performance Measures	GO	NO GO
1. Described how disciplinary action against a soldier is a command responsibility.	—	—
2. Identified who has authority to take disciplinary action against a soldier for misconduct.	—	—
3. Described a soldier's responsibility to identify potential or actual violations of the UCMJ and expeditiously report these violations to the appropriate authorities for investigation and processing.	—	—
4. Described a commander's responsibility to conduct a preliminary investigation into misconduct allegedly committed by a soldier under his or her command.	—	—
a. Described the basis and procedures of a commander's inquiry.		
b. Described the basis and procedures of an AR 15-6 investigation.		
c. Described the requirement for the military police or CID to conduct a criminal investigation.		
5. Listed disciplinary options available to the commander.	—	—
a. Described how a commander can take no action at all or close a case.		
b. Described how a commander can use administrative or nonpunitive measures.		
(1) Listed administrative or nonpunitive disciplinary measures available to a commander.		
(2) Described why a commander would wish to use nonpunitive or administrative disciplinary measures rather than impose nonjudicial punishment or proceed to court-martial.		

Performance Measures	GO	NO GO
(3) Described how an NCO leader may be involved in the imposition of nonpunitive or administrative disciplinary measures, such as counseling or corrective training, to a subordinate soldier.		
c. Described how a commander can use nonjudicial punishment.		
(1) Defined nonjudicial punishment.		
(2) Listed the different types of nonjudicial punishment.		
(3) Described nonjudicial punishment procedures.		
(4) Described a soldier's legal rights during nonjudicial punishment procedures.		
(5) Listed the maximum punishment available under nonjudicial punishment.		
(6) Described a soldier's appellate rights under nonjudicial punishment.		
d. Described how a commander can use judicial punishment.		
(1) Defined judicial punishment.		
(2) Listed the different types of court-martial in the military justice system.		
(3) Described judicial or court-martial procedures.		
(4) Described a soldier's legal rights during judicial or court-martial punishment.		
(5) Listed the maximum punishment available under judicial or court-martial punishment.		
(6) Described a soldier's appellate rights under judicial or court-martial punishment.		
6. Listed factors a commander should consider when determining what disciplinary option to pursue.	—	—
a. Described whether a commander should consider the character and military service of the accused.		

Skill Level 2

Skill Level 2	Performance Measures	GO	NO GO
	b. Described whether a commander should consider the nature and circumstances of the offense and the extent of the harm caused.		
	c. Described whether a commander should consider the needs of the Service and the probable effect of his or her decision on the command and the military community.		
	d. Described whether a commander should consider the disposition of similar offenses in the past and the general disciplinary trends within the command.		
	e. Described whether a commander should consider the appropriateness of the authorized punishment to the particular accused and offense.		
	f. Described whether a commander should determine whether he has jurisdiction over the accused and the offense.		
	g. Described whether a commander should consider the availability and admissibility of evidence against the accused.		
	h. Described whether a commander should consider the cooperation of the accused in the apprehension or conviction of others.		
	i. Described whether a commander should consider the possible improper motives of the accuser.		
	j. Described whether a commander should consider that the victim or others are reluctant to testify.		
7. Described the permissibility of a commander discussing and gaining input from an NCO leader regarding which disciplinary option to pursue against a subordinate soldier within the unit.	—	—	
8. Described the authority of an NCO to issue a lawful order to a subordinate soldier.	—	—	
a. Described the duty of a subordinate soldier to follow this order.			
b. Described the potential adverse ramifications for a soldier violating this order.			
c. Described the elements and maximum punishments available under Article 91, UCMJ.			

**Evaluation Guidance:** Score the soldier GO if all performance measures are passed. Score the soldier NO GO if any performance measure is failed. If the soldier scores NO GO, show him what was done wrong and how to do it correctly.

---

## **181-105-2001**

### **Enforce the Law of War and the Geneva and Hague Conventions**

**Conditions:** You are a soldier in the U.S. Army. As a soldier, you are responsible for identifying, understanding, and complying with the provisions of the Law of War, including the Geneva and Hague conventions. You are also responsible for identifying and notifying the appropriate authorities of any suspected or known violations of the Law of War. The appropriate authorities, including your chain of command, must enforce the provisions of the Law of War, including the Geneva and Hague conventions.

**Standards:** Identified, understood, and complied with the Law of War. Identified problems or situations that violated the policies and took appropriate action, including notifying appropriate authorities, so expedient action could be taken to correct the problem or situation.

---

#### **Performance Steps**

1. Identify the key violations of the Law of War.
    - a. Define what is a Law of War violation.
    - b. Identify the two general types of war crimes.
    - c. Define what constitutes a grave breach and give examples .
    - d. Describe what obligations exist if there is a grave breach.
    - e. Define what constitutes an other than grave breach or a simple breach and give examples .
    - f. Describe what obligations exist if there is a simple breach.
  2. Describe the responsibilities of U.S. soldiers to obey the Law of War.
    - a. Describe how U.S. soldiers are bound to obey all the rules of the Customary Law of War and the Hague and Geneva Conventions .
    - b. Describe how U.S. soldiers may be court-martialed for violating these rules.
    - c. Describe how U.S. soldiers may also be prosecuted for committing a war crime.
  3. Describe the responsibilities of the commander in regard to violations of the Law of War.
- 

Skill Level 2

**Performance Steps**

- a. Describe how the legal responsibility for the commission of a war crime can be placed on the commander as well as the subordinate who actually commits the war crime.
- b. Describe the circumstances under which a commander may be prosecuted for the commission of a war crime.
4. Describe a criminal order and a soldier's responsibility toward a criminal order.
- a. Describe the applicability of a soldier asserting the defense of "obeying a superior order" for the commission of a war crime.
- b. Describe whether a subordinate soldier, who actually commits a war crime, is excused from prosecution if the commander is charged with the commission of the war crime.
- c. Describe the responsibility of a soldier to disobey any order that requires the soldier to commit criminal acts in violation of the Law of War.
- d. Describe the responsibility of a soldier to obey the rules of engagement and the potential consequences for violating the rules of engagement.
- e. Describe the responsibility of the soldier to ask a superior for clarification of an order presumed to be criminal or illegal.
5. Identify the key requirements in processing violations of the Law of War.
- a. Describe what actions are required when a Law of War violation is suspected.
- b. Describe what your combatant commander-in-chief's (CINC) guidance is.
- c. Describe the requirement to report suspected violations of the Law of War.
- d. Describe the obligations of the investigative team.
- (1) Describe who appoints the investigating officer(s).
- (2) Describe the qualifications of the investigating officer(s).
- (3) Describe the importance of timely collection of information/evidence.
- (4) Describe the Initial Report format.

**Evaluation Preparation:**

*Setup:* Evaluate this task at the end of Law of War training.



*Brief Soldier:* Tell the soldier that he will be evaluated on his ability to identify, understand, and comply with the Law of War, including the Geneva and Hague conventions. Tell the soldier that he will also be evaluated on his ability to identify problems or situations that violate the Law of War and take appropriate action, including notifying appropriate authorities of actual or suspected violations, so expedient action may be taken to correct the problem or situation.

Skill Level 2

Performance Measures	GO	NO GO
<b>1. Identified the key violations of the Law of War.</b>	—	—
<b>a.</b> Defined a Law of War violation.		
<b>b.</b> Identified the two general types of war crimes.		
<b>c.</b> Defined what constitutes a grave breach and gave examples .		
<b>d.</b> Described what obligations exist if there is a grave breach.		
<b>e.</b> Defined what constitutes an other than grave breach or a simple breach, and gave examples .		
<b>f.</b> Described what obligations exist if there is a simple breach.		
<b>2. Described the responsibilities of U.S. soldiers to obey the Law of War.</b>	—	—
<b>a.</b> Described how U.S. soldiers are bound to obey all the rules of the Customary Law of War and the Hague and Geneva Conventions.		
<b>b.</b> Described how U.S. soldiers may be court-martialed for violating these rules.		
<b>c.</b> Described how U.S. soldiers may also be prosecuted for committing a war crime.		
<b>3. Described the responsibilities of the commander in regard to violations of the Law of War.</b>	—	—
<b>a.</b> Described how the legal responsibility for the commission of a war crime can be placed on the commander as well as the subordinate who actually commits the war crime.		
<b>b.</b> Described the circumstances under which a commander may be prosecuted for the commission of a war crime.		

Skill Level 2	Performance Measures	GO	NO GO
	4. Described a criminal order and a soldier's responsibility toward a criminal order.	—	—
	a. Described the applicability of a soldier asserting the defense of "obeying a superior order" for the commission of a war crime.		
	b. Described whether a subordinate soldier, who actually commits a war crime, is excused from prosecution if the commander is charged with the commission of the war crime.		
	c. Described the responsibility of a soldier to disobey any order that requires the soldier to commit criminal acts in violation of the Law of War.		
	d. Described the responsibility of a soldier to obey the rules of engagement and the potential consequences for violating the rules of engagement.		
	e. Described the responsibility of the soldier to ask a superior for clarification of an order presumed to be criminal or illegal.		
	5. Identified the key requirements in processing violations of the Law of War.	—	—
	a. Described what actions are required when a Law of War violation is suspected.		
	b. Described what your combatant commander-in-chief's (CINC) guidance is.		
c. Described the requirement to report suspected violations of the Law of War.			
d. Described the obligations of the investigative team.			
(1) Described who appoints the investigating officer(s).			
(2) Described the qualifications for the investigating officer(s).			
(3) Described the importance of timely collection of information/evidence.			
(4) Described the initial report format.			

**Evaluation Guidance:** Score the soldier GO if all performance measures are passed. Score the soldier NO GO if any performance measure is failed. If the soldier scores NO GO, show him what was done wrong and how to do it correctly.

Skill Level 2

---

## 181-105-2002

### Conduct Combat Operations According to the Law of War

**Conditions:** You are a soldier in a deployed unit who has a mission that requires you and your subordinates to be actively involved in operations governed by the Law of War.

**Standards:** Conducted operations in accordance with the Law of War and employed actions to prevent violations of the Law of War.

---

#### Performance Steps

1. Identify the key elements of the Hague and Geneva conventions that pertain to combat operations.
  - a. Unlawful and lawful targets.
  - b. Noncombatants.
  - c. Lawful use of force.
  - d. Protected property—property dedicated to the humanities; structures and items of cultural or historical significance; and schools, orphanages, and other places dedicated to the use and benefit of children.
  - e. Protected medical transports and facilities.
  - f. Proper use of medical service symbols, a flag of truce, national emblems, and/or insignia or uniforms of an opposing force.
  - g. Define perfidy and treachery.
  - h. Proportionate use of force.
  - i. Weapons and actions that cause unnecessary suffering and harm.
  - j. Duties of the captor to prisoners of war, retained persons, and detainees.
  - k. Duties of combatants toward civilians and civilian property.
  - l. Rights, responsibilities, and discipline of prisoners of war.
  - m. War crimes constituting grave breaches.
  - n. State obligations when evidence of a war crime exists.
  - o. Requirements to report Law of War violations.
2. Employ actions to prevent violations of the Law of War.
  - a. Protect—

**Performance Steps**

- (1) Noncombatants/civilians.
- (2) Property.
- (3) Prisoners of war, retained persons, and detainees.
- (4) Medical transports and facilities.
- b. Prevent engagement of unlawful targets.
  - (1) Protective emblems.
  - (2) Noncombatants and protected property.
  - (3) Indiscriminate fire.
  - (4) Rules of engagement.
- c. List actions to prevent excessive use of force.
- d. List actions to prevent unauthorized use of medical service symbols, flags of truce, national emblems, and enemy uniform/insignia.
- e. List actions to prevent unnecessary destruction or seizure of property.
  - f. List actions to prevent unnecessary suffering and harm.
- g. List actions to enforce the rights and responsibilities of prisoners of war.
  - h. Describe the obligations of a military commander with respect to prevention, suppression, and prosecution of war crimes.
  - i. Describe the concept of command responsibility in relation to war crimes.
- j. List methods for reporting violations of the Law of War.

**Evaluation Preparation:**

*Setup:* Evaluate this task at the end of Law of War training.

*Brief Soldier:* Tell the soldier that he will be evaluated on his ability to conduct combat operations in accordance with the Law of War and employ actions to prevent violations of the Law of War.

Performance Measures	GO	NO GO
1. Employed actions that prevented Law of War violations and war crimes to protect—	___	___
a. Noncombatants and civilians.		
b. Property.		
c. Prisoners of war and detainees.		
d. Protected medical transports and facilities.		

Performance Measures	GO	NO GO
2. Employed actions that prevented Law of War violations and war crimes:	—	—
a. Engagement of unlawful targets.		
b. Excessive use of force.		
c. Unauthorized use of medical services symbol, flag of truce, national emblems, and enemy insignias and uniforms.		
d. Unnecessary suffering and harm .		
3. Employed actions that enforce the rights and responsibilities of prisoners of war.	—	—
4. Listed the duties of the captor to prisoners of war, retained persons, and detainees.	—	—
5. Listed the duties of combatants toward civilians and civilian property.	—	—
6. Listed the rights and responsibilities of prisoners of war.	—	—
7. Listed war crimes that constitute grave breaches.	—	—
8. Listed the State obligations that occur when evidence of a war crime exists.	—	—
9. Listed the requirement to report Law of War violations.	—	—
10. Listed the specific rules of engagement.	—	—
11. Listed the commander's primary responsibilities.	—	—

Skill Level 2

**Evaluation Guidance:** Score the soldier GO if all performance measures are passed. Score the soldier NO GO if any performance measure is failed. If the soldier scores NO GO, show him what was done wrong and how to do it correctly.

---

### 224-176-2426

#### Enforce Compliance with Media Ground Rules

**Conditions:** Given a copy of your command/installation's media ground rules in a field, MOUT, or garrison environment, enforce compliance with the rules.

**Standards:** Identified the steps for enforcing media ground rules.

**CAUTION**

Media ground rules may change between various command levels within garrison, field, and deployment environments.

**Performance Steps**

**Note:** Ground rules recognize the importance of media coverage of military operations and are not intended to prevent release of derogatory, embarrassing, or negative information. However, during operations, specific information on friendly troop movements, tactical deployments, and dispositions could jeopardize operational security and endanger lives.

**Note:** Commanders and public affairs practitioners will establish basic ground rules ensuring the free flow of information while safeguarding classified materials or operational plans.

1. Obtain area-specific ground rules from the local public affairs office or representative.
2. Define media ground rules. Media representatives are required to contact public affairs prior to conducting any media-related activities.
3. Determine if the media representative is aware of area ground rules, if not explain violations.
4. Be professional.
5. Inform the chain of command and public affairs representative if ground rules are violated.

**Evaluation Preparation:**

*Setup:* Provide soldier with a copy of the media ground rules. Obtain ground rules from the local PAO, chain of command or refer to FM 46-1. Have one soldier play the part of a media representative.

*Brief soldier:* Tell the soldier media representatives are in the area and want to interview soldiers for a print or broadcast story. Evaluate the soldier on his ability to enforce media ground rules.

Performance Measures	GO	NO GO
1. Ensured soldier knew where to obtain a copy of media ground rules.	___	___
2. Ensured soldier could define media ground rules.	___	___
3. Briefed media representative of violations to established ground rules.	___	___
4. Reported ground rule violations to chain of command or public affairs representative.	___	___

**Evaluation Guidance:** Score the soldier GO if 70 percent or more of the performance measures are passed and NO GO if less than 70 percent of the performance measures are passed. If the soldier scores NO GO on a

performance measure, show or tell him what was wrong and how to perform the measure correctly.

**References**

**Required**

AR 360-1

**Related**

FM 46-1



---

**331-202-1050**

**Enforce Compliance with the Code of Conduct**

**Conditions:** As the senior military person in a unit where you and members of your unit are placed in a survival/evasion/resistance/ escape situation. All members of your unit have completed Code of Conduct training during the pre-deployment training phase.

**Standards:** Demonstrated knowledge of the six articles of the Code of Conduct by establishing and sustaining a chain of command, good discipline, and a means of communications. Provided positive moral, ethical leadership and direction on how to survive, evade, resist, and escape in accordance with the guidelines established in the Code of Conduct.

---

**Performance Steps**

1. Demonstrated knowledge of Article I: I am an American fighting in the forces that guard my country and our way of life. I am prepared to give my life in their defense.

a. Explanation. The Code applies to all service members at all times, whether in active combat, in captivity, or in peacetime as a result of hostage situations and terrorist activities. Members of the Armed Forces have a duty to support U.S. interest and oppose U.S. enemies regardless of the circumstances.

(1) Medical personnel and chaplains are given special "retained status" by the 1949 Geneva Convention including the GPW. The GPW requires that medical personnel and chaplains be allowed to perform their professional duties while captured. However, the captors control the degree to which these duties can be performed. But, even while performing limited professional duties, medical personnel and chaplains are held accountable for all their actions.

(2) Recent experience has shown that captors have disregarded the GPW. All confined personnel have been subjected to the same coercive PW management practices. Therefore, all soldiers should be aware of the behavior standards of the Code and should receive training in its application.

(3) Past experience of captured Americans reveals that honorable survival of captivity requires that a member possess a high degree of

**Performance Steps**

dedication and motivation. Maintaining this qualities requires -

2. Demonstrated knowledge of Article II: I will never surrender of my own free will. If in command, I will never surrender the members of my command while they still have the means to resist.
3. Demonstrated knowledge of Article III: If I am captured, I will continue to resist by all means available. I will make every effort to escape and aid others to escape. I will accept neither parole nor special favors from the enemy.
4. Demonstrated knowledge of Article IV: If I become a prisoner of war, I will keep faith with my fellow prisoners. I will give no information or take part in any action that might be harmful to my comrades. If I am senior, I will take command. If not, I will obey the lawful orders of those appointed over me and will back them up in every way.
5. Demonstrated knowledge of Article V: When questioned, should I become a prisoner of war, I am required to give name, rank, service number, and date of birth. I will evade answering further questions to the utmost of my ability. I will make no oral or written statements disloyal to my country and its allies or harmful to their cause.
6. Demonstrated knowledge of Article VI: I will never forget that I am an American fighting for freedom, responsible for my actions, and dedicated to the principles that made my country free. I will trust in my God and in the United States of America.

**Evaluation Preparation:** Service member will participate in class discussions and respond to instructor's questions about the six articles of the Code of Conduct as articulated in FM 3-05.71, chapters 2 and 13. Soldiers must be able to write or orally recite the six articles of the Code of Conduct.

Performance Measures	GO	NO GO
Demonstrated knowledge of the six articles of the Code of Conduct by reciting or writing them.	___	___

**Evaluation Guidance:** Score the soldier GO if all performance measures are passed. Score the soldier NO GO if any performance measure is failed. If the soldier fails , show what was done wrong and how to do it correctly.

**References**

**Required**  
AR 350-30  
FM 3-05.71

**Related**  
DODD 1300.7



---

**805C-PAD-2503****Enforce Compliance with the Army's Equal Opportunity and Sexual Harassment Policies**

**Conditions:** You are a small-unit/section leader responsible for the supervision of personnel. Personnel include both male and female, and represent different races, colors, religions, and national origins. You have access to AR 600-20, FM 22-100, and the unit and Army Equal Opportunity and Sexual Harassment Policies.

**Standards:** Demonstrated personal behavior and leadership consistent with the Army's Equal Opportunity (EO) and Prevention of Sexual Harassment (POSH) policies. Enforced compliance with the Army's EO, POSH, and the Army's extremist activities policies.

---

**Performance Steps**

---

1. Act in accordance with the Army's EO and sexual harassment policies.
    - a. Demonstrate Army Values associated with EO.
      - (1) Display unquestionable loyalty.
      - (2) Follow your higher duty to the Army and the nation.
      - (3) Treat people as they should be treated.
      - (4) Live up to all the Army Values.
    - b. Conform to the Army's EO and sexual harassment policies by avoiding—
      - (1) Making racial or sexual comments and/or gestures.
      - (2) Making national origin or religious comments/jokes/slurs.
      - (3) Displaying racist or sexually offensive visual materials.
      - (4) Making unsolicited and unwelcome sexual contact with fellow soldiers.
      - (5) Stereotyping fellow soldiers or making assumptions about their cultural background, race, religion, or beliefs.
      - (6) Using profanity or sexually oriented language.
      - (7) Discounting the religious beliefs of fellow soldiers.
      - (8) Belonging to extremist organizations or participating in extremist activities.
    - c. Demonstrate leadership consistent with EO and sexual harassment policies.
      - (1) Treat subordinates with dignity and respect.
      - (2) Treat subordinates fairly and equally.
- 

Skill Level 2

**Performance Steps**

- (3) Recognize and respect subordinates' individual needs, aspirations and capabilities.
- (4) Avoid discriminating against subordinates based on race, color, national origin, gender, or religion.
- (5) Avoid using language that demeans, excludes, or offends subordinates.
2. Maintain your unit free from unlawful discrimination and sexual harassment.
- a. Ensure subordinates understand Army and unit EO and sexual harassment policies and procedures.
- (1) Ensure subordinates understand required standards of behavior.
- (2) Counsel subordinates on the legal and administrative repercussions of EO/sexual harassment violations.
- (3) Ensure subordinates understand recommended techniques for dealing with sexual harassment.
- (4) Ensure subordinates understand the EO and sexual harassment complaint process.
- (5) Ensure subordinates understand the Army policy on extremist activities and organizations.
- b. Make on-the-spot corrections of subordinates whose behaviors are contrary to Army EO and sexual harassment policies.
- (1) Correct soldiers using racist or sexually harassing nonverbal gestures.
- (2) Correct soldiers using racist or sexually harassing verbal comments.
- (3) Correct soldiers displaying racist or sexually harassing visual materials.
- (4) Avoid allowing intimidation, harassment, or reprisal against soldiers for making complaints.

**Evaluation Preparation:**

*Setup:* This task can be tested in an administrative or field environment. Give the soldier a scenario that provides sufficient information to evaluate their knowledge of the Army's EO and sexual harassment policies, prohibited acts, and actions that should be taken if a violation occurred.

*Brief Soldier:* Inform soldier that they will be tested on their knowledge of the Army's EO and sexual harassment policies, prohibited acts, and actions that should be taken if a violation occurs.

Performance Measures	GO	NO GO
1. Acted in accordance with the Army's EO and sexual harassment policies.	—	—
<b>a. Demonstrated Army Values associated with EO.</b>		
<b>(1)</b> Displayed unquestionable loyalty.		
<b>(2)</b> Followed your higher duty to the Army and the nation.		
<b>(3)</b> Treated people as they should be treated.		
<b>(4)</b> Lived up to all the Army Values.		
<b>b. Conformed to the Army's EO and sexual harassment policies.</b>		
<b>(1)</b> Avoided making racial or sexual comments and/or gestures.		
<b>(2)</b> Avoided making national origin or religious comments/jokes/slurs.		
<b>(3)</b> Avoided displaying racist or sexually offensive visual materials.		
<b>(4)</b> Avoided making unsolicited and unwelcome sexual contact with fellow soldiers.		
<b>(5)</b> Avoided stereotyping fellow soldiers or making assumptions about their cultural background, race, religion, or beliefs.		
<b>(6)</b> Avoided using profanity or sexually oriented language.		
<b>(7)</b> Avoided discounting the religious beliefs of fellow soldiers.		
<b>(8)</b> Avoided belonging to extremist organizations or participating in extremist activities.		
<b>c. Demonstrated leadership consistent with EO and sexual harassment policies.</b>		
<b>(1)</b> Treated subordinates with dignity and respect.		
<b>(2)</b> Treated subordinates fairly and equally.		
<b>(3)</b> Recognized and respected subordinates' individual needs, aspirations, and capabilities.		
<b>(4)</b> Avoided discriminating against subordinates based on race, color, national origin, gender, or religion.		

**Skill Level 2**

Skill Level 2	Performance Measures	GO	NO GO
	(5) Avoided using language that demeaned, excluded, or offended subordinates.		
	2. Maintained your unit free from unlawful discrimination and sexual harassment.	—	—
	a. Ensured subordinates understood Army and unit EO/sexual harassment policies and procedures.		
	(1) Ensured subordinates understood required standards of behavior.		
	(2) Counseled subordinates on the legal and administrative repercussions of EO/sexual harassment violations.		
	(3) Ensured subordinates understood recommended techniques for dealing with sexual harassment.		
	(4) Ensured subordinates understood the EO and sexual harassment complaint process.		
	(5) Ensured subordinates understood the Army policy on extremist activities and organizations.		
	b. Made on-the-spot corrections of subordinates whose behaviors were contrary to Army EO and sexual harassment policies.		
	(1) Corrected soldiers using racist or sexually harassing nonverbal gestures.		
	(2) Corrected soldiers using racist or sexually harassing verbal comments.		
	(3) Corrected soldiers displaying racist or sexually harassing visual materials.		
	(4) Avoided allowing intimidation, harassment, or reprisal against soldiers for making complaints.		

**Evaluation Guidance:** Score the soldier GO for each performance measure accomplished. Score the soldier NO GO for each performance measure not accomplished. Soldier must receive a GO on all performance measures to receive a GO for the task. If the soldier receives a NO GO, show him the performance measures he missed.

**References**

<b>Required</b>	<b>Related</b>
AR 600-13	

## References

### Required

AR 600-20  
DA Pam 350-20  
DODD 7050.6  
FM 22-100  
MCM2002  
TC 26-6

### Related

**SUBJECT AREA 2: FIRST AID**

Skill Level 2

## 081-831-0101

### Request Medical Evacuation

**Conditions:** You have a casualty requiring medical evacuation (MEDEVAC) and a patient pickup site. Necessary equipment and materials: operational communications equipment, MEDEVAC request format, a standard scale military map, a grid coordinate scale, and unit signal operation instructions (SOI).

**Standards:** Transmitted a MEDEVAC request, providing all necessary information within 25 seconds. Transmitted, as a minimum, line numbers 1 through 5 during the initial contact with the evacuation unit. Transmitted lines 6 through 9 while the aircraft or vehicle was en route, if not included during initial contact.

### Performance Steps

1. Collect all applicable information needed for the MEDEVAC request.
  - a. Determine the grid coordinates for the pickup site.
  - b. Obtain radio frequency, call sign, and suffix.
  - c. Obtain the number of patients and precedence.
  - d. Determine the type of special equipment required.
  - e. Determine the number and type (litter or ambulatory) of patients.
  - f. Determine the security of the pickup site.
  - g. Determine how the pickup site will be marked.
  - h. Determine patient nationality and status.
  - i. Obtain pickup site nuclear, biological, and chemical (NBC) contamination information normally obtained from the senior person or medic.

**Note.** NBC line 9 information is only included when contamination exists.

Skill Level 2

081-831-0101

3-21

**Performance Steps**

**2.** Record the gathered MEDEVAC information using the authorized brevity codes. (See table 081-831-0101-1.)

**Note.** Unless the MEDEVAC information is transmitted over secure communication systems it must be encrypted except as noted in step 3b(1).

**a.** Location of pickup site (line 1). (See STP 21-1-SMCT, Task 071-329-1006.)

**b.** Radio frequency, call sign, and suffix (line 2). (See STP 21-1-SMCT, Task 113-637-2001.)

**c.** Numbers of patients by precedence (line 3).

**d.** Special equipment required (line 4).

**e.** Number of patients by type (line 5).

**f.** Security of pickup site (line 6).

**g.** Method of marking pickup site (line 7).

**h.** Patient nationality and status (line 8).

**i.** NBC contamination (line 9).

**3.** Transmit the MEDEVAC request.

**a.** Contact the unit that controls the evacuation assets.

**(1)** Make proper contact with the intended receiver.

**(2)** Use effective call sign and frequency assignments from the SOI.

**(3)** Give the following in the clear "I HAVE A MEDEVAC REQUEST"; wait one to three seconds for response. If no response, repeat the statement.

**b.** Transmit the MEDEVAC information in the proper sequence.

**(1)** State all line item numbers in clear text. The call sign and suffix (if needed) in line 2 may be transmitted in the clear.

**Note.** Line numbers 1 through 5 must always be transmitted during the initial contact with the evacuation unit. Lines 6 through 9 may be transmitted while the aircraft or vehicle is en route.

**(2)** Follow the procedure provided in the explanation column of the MEDEVAC request format to transmit other required information.

**(3)** Pronounce letters and numbers in accordance with appropriate radiotelephone procedures.

**(4)** Take no longer than 25 seconds to transmit.

**(5)** End the transmission by stating "OVER."

**(6)** Keep the radio on and listen for additional instructions or contact from the evacuation unit.

Table 081-831-0101-1. MEDEVAC Authorized Brevity Codes					
Line	Item	Explanation	Where/ How Obtained	Who Normally Provides	Reason
1	Location of Pickup Site	Encrypt the grid coordinates of the pickup site. When using the DRYAD Numeral Cipher, the same "SET" line will be used to encrypt the grid zone letters and the coordinates. To preclude misunderstanding, a statement is made that grid zone letters are included in the message (unless unit SOP specifies its use at all times).	From Map	Unit Leader(s)	Required so evacuation vehicle knows where to pick up patient. Also, so the unit coordinating the evacuation mission can plan the route for the evacuation vehicle (if the evacuation vehicle must pick up from more than one location).
2	Radio Frequency, Call Sign, and Suffix	Encrypt the frequency of the radio at the pickup site, not a relay frequency. The call sign (and suffix if used) of person to be contacted at the pickup site may be transmitted in the clear.	From SOI	RTO	Required so evacuation vehicle can contact requesting unit while en route (obtain additional information or change in situation or directions).

**Skill Level 2**

Skill Level 2

**Table 081-831-0101-1. MEDEVAC Authorized Brevity Codes**

Line	Item	Explanation	Where/ How Obtained	Who Normally Provides	Reason
3	Number of Patients by Precedence	Report only applicable information and encrypt the brevity codes. A – urgent. B – Urgent-Surgical. C – Priority. D – Routine. E – Convenience.  If two or more categories must be reported in the same request, insert the word "BREAK" between each category.	From Evaluation of Patient(s)	Medic or Senior Person Present	Required by unit controlling the evacuation vehicles to assist in prioritizing missions
4	Special Equipment Required	Encrypt the applicable brevity codes. A – None. B – Hoist. C – Extraction equipment. D – Ventilator.	From Evaluation of Patient/ Situation	Medic or Senior Person Present	Required so equipment can be placed on board evacuation vehicle prior to the start of mission.
5	Number of Patients by Type	Report only applicable information and encrypt the brevity code. If requesting MEDEVAC for both types, insert the word "BREAK" between the litter entry and ambulatory entry. L+# of Patient – Litter A+# of Patient – Ambulatory (sitting)	From Evaluation of Patient(s)	Medic or Senior Person Present	Required so appropriate number of evacuation vehicles may be dispatched to pickup site. They should be configured to carry patients requiring evacuation.



Table 081-831-0101-1. MEDEVAC Authorized Brevity Codes					
Line	Item	Explanation	Where/ How Obtained	Who Normally Provides	Reason
6	Security of Pickup Site (Wartime)	N – No enemy troops in area. P – Possible enemy troops in area (approach with caution). E – Enemy troops in area (approach with caution). X – Enemy troops in area (armed escort required).	From Evaluation of Situation	Unit Leader	Required to assist the evacuation crew in assessing the situation and determining if assistance is required. More definitive guidance can be furnished the evacuation vehicle while it is en route (specific location or enemy to assist an aircraft in planning its approach).
6	Number and Type of Wound, Injury, or Illness (Peacetime)	Specific information regarding patient wounds by type (gunshot or shrapnel). Report serious bleeding, along with patient blood type, if known.	From Evaluation of Patient	Medic or Senior Person Present	Required to assist evacuation personnel in determining treatment and special equipment needed.
7	Method of Marking Pickup Site	Encrypt the brevity codes. A – Panels. B – Pyrotechnic signal. C – Smoke signal. D – None. E – Other.	Based on Situation and Availability of Materials	Medic or Senior Person Present	Required to assist the evacuation crew in identifying the specific location of the pickup. Note that the color of the panels or smoke should not be transmitted until the evacuation vehicle contacts the unit (just prior to its arrival). For security, the crew should identify the color and the unit should verify it.

**Skill Level 2**

Table 081-831-0101-1. MEDEVAC Authorized Brevity Codes					
Line	Item	Explanation	Where/ How Obtained	Who Normally Provides	Reason
8	Patient Nationality and Status	The number of patients in each category need not be transmitted. Encrypt only the applicable brevity codes. A – U.S. military. B – U.S. civilian. C – Non-U.S. military. D – Non-U.S. civilian. E – EPW	From Evaluation of Patient	Medic or Senior Person Present	Required to assist in planning for destination facilities and need for guards. Unit requesting support should ensure there is an English-speaking representative at the pickup site.
9	NBC Contamination (Wartime)	Include this line only when applicable. Encrypt the applicable brevity codes. N – Nuclear. B – Biological. C – Chemical.	From Situation	Medic or Senior Person Present	Required to assist in planning for the mission. (Determine which evacuation vehicle will accomplish the mission and when it will be accomplished.)
9	Terrain Description (Peacetime)	Include details of terrain features in and around proposed landing site. If possible, describe relationship of site to prominent terrain feature (lake, mountain, tower).	From Area Survey	Personnel at site	Required to allow evacuation personnel to assess route/avenue of approach into area. Of particular importance if hoist operation is required.

**Evaluation Preparation:**

*Setup:* Evaluate this task during a training exercise involving a MEDEVAC aircraft or vehicle, or simulate it by creating a scenario and providing the information as the soldier requests it. You or an assistant will act as the radio contact at the evacuation unit during "transmission" of the request. Give a copy of the MEDEVAC request format to the soldier.

*Brief Soldier:* Tell the soldier to prepare and transmit a MEDEVAC request. State that the communications net is secure.

Performance Measures	GO	NO GO
1. Collected all information needed for the MEDEVAC request line items 1 through 9.	—	—
2. Recorded the information using authorized brevity codes.	—	—
3. Transmitted the MEDEVAC request within 25 seconds.	—	—

Skill Level 2

**Evaluation Guidance:** Score the soldier GO if all performance measures are passed. Score the soldier NO GO if any performance measure is failed. If the soldier scores NO GO, show what was done wrong and how to do it correctly.

**References**

**Required**

**Related**

FM 8-10-6

---

## 081-831-1054

### Evacuate Casualties

**Conditions:** You are a soldier deployed to a unit in a forward area. There are casualties that must be evacuated to receive medical aid. The casualties have had self-aid or buddy-aid applied. A military vehicle (ground vehicle or rotary-wing aircraft) is available. You may have a litter and straps (or materials to improvise them) to secure the casualty and other soldiers available to assist in the evacuation.

**Standards:** Transported the casualties to medical aid or a pickup site using an appropriate carry or, if other soldiers are available, by litter. The litter was loaded onto a military vehicle (ground vehicle or rotary-wing aircraft) without dropping or causing further injury to the casualty.

---

#### Performance Steps

1. Request medical evacuation. (See Task 081-831-0101.)
  - a. Make contact.
  - b. Determine whether casualties must be moved or will be picked up at current location. If they must be moved, continue with step 2. If they will not be moved, continue to monitor communications and go to step 5.
2. Transport a casualty using the one and two man carries. (See STP 21-1-SMCT, Task 081-831-1046.)

**Note.** Perform these procedures when medical and combat lifesaver personnel are not available. As soon as medical personnel are available, assist them, as necessary, in treating and evacuating the casualties.

---

Skill Level 2

081-831-1054

3-27

**Performance Steps**

3. Move a casualty, if necessary, using a four-man litter squad.

**Note.** If military vehicles and litter materials are not available, continue with step 4.

**Note.** Four-man litter squad bearers should be designated with a number from 1 to 4. The litter bearer designated as #1 is the leader of the squad.

a. Prepare the litter.

(1) Open a standard litter.

(2) Lock the spreader bars at each end of the litter with your foot.

b. Prepare the casualty.

(1) Place the casualty onto the litter using the modified two-man arms carry or the modified two-man fore-and-aft carry.

(2) Secure the casualty to the litter with litter straps.

c. Lift the litter.

(1) Position one squad member at each litter handle with the litter squad leader at the casualty's right shoulder.

**Note.** The leader should be at the right shoulder to monitor the casualty's condition.

(2) On the preparatory command, "PREPARE TO LIFT," the four bearers kneel beside and grasp the litter handles.

(3) On the command, "LIFT," all bearers rise together.

(4) On the command, "FOUR MAN CARRY, MOVE," all bearers walk forward in unison.

(a) If the casualty does not have a fractured leg, carry the casualty feet first on level ground and head first when going up hill.

(b) If the casualty has a fractured leg, carry the casualty head first, except when going up hill.

(5) To change direction of movement, such as from feet first to head first, begin in a litter-post carry position. The front and back bearers release the litter and the middle bearers rotate the litter and themselves.

4. Load casualties onto a military vehicle.

a. Ground ambulance.

**Note.** Ground ambulances have medical specialists to take care of the casualties during evacuation. Follow any special instructions for loading, securing, or unloading casualties.

(1) Make sure each litter casualty is secured to his or her litter. (Use litter straps when available.)

(2) Load the most serious casualty last.

---

**Performance Steps**

---

(3) Load the casualty head first (head in the direction of travel) rather than feet first.

(4) Make sure each litter is secured to the vehicle.

**b. Air ambulance.**

**Note.** Air ambulances have medical specialists to take care of the casualties during evacuation. Follow any special instructions for loading, securing, or unloading casualties.

(1) Remain 50 yards from the helicopter until the litter squad is signaled to approach the aircraft.

(2) Approach the aircraft in full view of the aircraft crew, maintaining visual confirmation that the crew is aware of the approach of the litter party. Ensure that the aircrew can continue to visually distinguish friendly from enemy personnel at all times. Maintain a low silhouette when approaching the aircraft.

(3) Approach UH-60/UH-1 aircraft from the sides. Do not approach from the front or rear. If you must move to the opposite side of the aircraft, approach from the side to the skin of the aircraft. Then, hug the skin of the aircraft, and move around the front of the aircraft to the other side.

(4) Load the most seriously injured casualty last.

(5) Load the casualty who will occupy the upper birth first, then load the next litter casualty immediately under the first casualty.

**Note.** This is done to keep the casualty from accidentally falling on another casualty if his litter is dropped before it is secured.

(6) When casualties are placed lengthwise, position them with their heads toward the direction of travel.

(7) Make sure each litter casualty is secured to his or her litter.

(8) Make sure each litter is secured to the aircraft.

**c. Ground military vehicles.**

**Note.** Nonmedical military vehicles may be used to evacuate casualties when no medical evacuation vehicles are available. If medical personnel are present, follow their instructions for loading, securing, and unloading casualties.

(1) When loading casualties into the vehicle, load the most seriously injured casualty last.

(2) When a casualty is placed lengthwise, load the casualty with his or her head pointing forward, toward the direction of travel.

(3) Ensure each litter casualty is secured to the litter. (Use litter straps, if available.)

---

Skill Level 2

**Performance Steps**

(4) Secure each litter to the vehicle as it is loaded into place. Make sure each litter is secured.

(5) Watch the casualties closely for life-threatening conditions and provide first aid, as necessary. (See STP 21-1-SMCT, Task 081-831-1000.)

**Evaluation Preparation:**

*Setup:* Evaluate this task during a training exercise involving a MEDEVAC aircraft or vehicle, or simulate it by creating a scenario, and provide the equipment needed for the evaluation.

*Brief Soldier:* Tell the soldiers the scenario to include the end result desired.

Performance Measures	GO	NO GO
1. Requested medical evacuation (not measured). (See Task 081-831-0101.)	___	___
2. Transported a casualty using one- and two-man carries, if necessary (not measured). (See STP 21-1-SMCT, Task 081-831-1046.)	___	___
3. Moved a casualty using a four-man litter squad, if necessary.	___	___
a. Prepared the litter.		
b. Prepared the casualty.		
c. Lifted the litter.		
4. Loaded casualties onto a military vehicle.	___	___
a. Ground ambulance.		
b. Air ambulance.		
c. Ground military vehicles.		

**Evaluation Guidance:** Score the soldier GO if all the performance measures are passed. Score the soldier NO GO if any of the performance measures are failed. If the soldier scores NO GO, show what was done wrong and how to do it correctly.

**References**

**Required**  
STP 21-1-SMCT

**Related**  
FM 4-25.11  
FM 8-10-6

---

## 081-831-9000

### Implement Preventive Medicine Measures

**Conditions:** You are a unit leader. Your unit is deployed to the field. You have the equipment authorized by your table of organization and equipment (TOE), field sanitation equipment and supplies, and a field sanitation team (FST) for every unit subject to deployment in a field environment.

**Note.** Company aidmen (91W), organic or attached to deployed units, normally fulfill the requirement for the FST.

**Standards:** Briefed personnel on the three reasons soldiers are vulnerable to disease. Trained personnel on the seven major components of the medical threat to field forces. Trained soldiers on the seven individual preventive medicine measures necessary to prevent disease and nonbattle injuries. Taught the Army's tobacco use policies. Ensured selected unit personnel received field sanitation team training on the team's eight areas of responsibility.

---

#### Performance Steps

**Note.** Once FST personnel are selected and trained, they can be delegated the responsibility for training other members of the unit.

1. Brief personnel on the three reasons a soldier is vulnerable to disease.
  - a. Harshness of the environment such as deserts, jungles, and the Arctic.
  - b. Reduced natural defenses due to exposure and fatigue. Examples are—
    - (1) Climatic changes.
    - (2) Sleep deprivation.
    - (3) Irregular meals.
  - c. Breakdowns in basic sanitation, such as the lack of clean water and proper waste disposal.
2. Train personnel on the seven major components of the medical threat to field forces.
  - a. Heat. Types of heat injuries.
    - (1) Heat cramps.
    - (2) Heat exhaustion.
    - (3) Heatstroke — a medical emergency.
  - b. Cold. Types of cold injuries.
    - (1) Chilblain.

Skill Level 2

**Performance Steps**

- (2) Immersion foot.
- (3) Trench foot.
- (4) Frostbite.
- (5) General hypothermia.
- c. Arthropods (biting insects).
  - (1) Diseases transmitted directly by arthropods.
    - (a) Mosquitoes—malaria, yellow fever, dengue fever, and encephalitis.
    - (b) Some ticks, as well as mosquitoes—encephalitis.
    - (c) Sand flies—sand fly fever.
    - (d) Body lice—epidemic typhus.
    - (e) Hard ticks—Lyme disease.
  - (2) Diseases transmitted by insects associated with rodents.
    - (a) Fleas—plague and endemic typhus.
    - (b) Mites—scrub typhus.
- d. Diarrhea. Diarrheal disease is contracted from contaminated food and water.
  - (1) Waterborne diarrheal disease.
    - (a) Typhoid fever.
    - (b) Cholera.
    - (c) Traveler's diarrhea.
    - (d) Hepatitis A.
  - (2) Food-borne diarrheal diseases.
    - (a) Traveler's diarrhea.
    - (b) Cholera.
    - (c) Salmonellosis.
    - (d) Hepatitis.
- e. Non-NBC chemical hazards.
  - (1) Examples of non-NBC chemical hazards.
    - (a) Carbon monoxide.
    - (b) Hydrogen chloride.
    - (c) Bore/gun gases.
    - (d) Solvents, greases, insecticides, and oils.



---

**Performance Steps**

---

- (2) Harmful effects of non-NBC chemical hazards.
  - (a) Skin irritation.
  - (b) Asphyxiation (choke, suffocate).
  - (c) Central nervous system depression.
  - (d) Death.
- f. Noise hazards.
  - (1) Examples of noise hazards.
    - (a) Weapons.
    - (b) Aircraft.
    - (c) Most Army vehicles and generators.
  - (2) Harmful effects of hazardous noise exposures.
    - (a) Temporary loss of hearing—lasts minutes to hours.
    - (b) Permanent loss of hearing.
    - (c) Blast over pressure effects.
- g. Other medical threats to field forces.
  - (1) Skin disease—common in extremely dry or humid climates.
  - (2) Altitude sickness—locations above 9,000 feet.
  - (3) Harmful animals — poisonous reptiles, arthropods, and mollusks and coelenterates (such as jellyfishes and corals).
  - (4) Tobacco use.
  - (5) Poor medical threat intelligence.
- 3. Train personnel on the seven individual preventive medicine measures (PMM) necessary to prevent disease and nonbattle injury (DNBI).

**Note.** Once personnel have received the training on PMM, leaders should check periodically for application of PMM as appropriate for their situation.

  - a. Prevent heat injuries.
    - (1) Drink plenty of water.
    - (2) Observe work and/or rest cycles.
    - (3) Eat all meals to replace salt.
    - (4) Recognize the risk of mission-oriented protective posture (MOPP) for body armor and armored vehicles.
    - (5) Modify your uniform.
  - b. Prevent cold injuries.

Skill Level 2

**Performance Steps**

- (1) Drink plenty of water and warm nonalcoholic fluids.
  - (2) Do NOT sleep in a vehicle with the engine running or in an enclosed area where an open fire is burning.
  - (3) Wear your uniform properly.
    - (a) Wear clothing as the commander directs.
    - (b) Keep clothing clean and dry. (Avoid fuel spills.)
    - (c) Avoid overheating by removing excess clothing when possible.
    - (d) Wear clothing in loose layers. (Avoid tight-fitting clothing.)
  - (4) Avoid loss of body heat.
    - (a) Keep moving when possible. (Exercise big muscles, toes, feet, fingers, and hands.)
    - (b) Avoid standing directly on cold, wet ground.
    - (c) Avoid smoking. (Smoking decreases blood flow to the skin.)
    - (d) Eat all meals to maintain energy.
  - (5) Protect feet and hands by wearing gloves or mittens, changing socks frequently, and avoiding skin contact with snow, fuel, or bare metal.
  - (6) Use the buddy system to spot frostbite on exposed skin.
- c. Protect against biting insects.**
- (1) Use insect repellent according to label directions and precautions.
  - (2) Wear your uniform as the commander directs.
  - (3) Keep your uniform clean.
  - (4) Follow medical advice; take antimalarial pills when directed and use insect powder, cream, and/or shampoo when prescribed by medical personnel.
  - (5) Protect yourself at night.
    - (a) Use a bed net when sleeping.
    - (b) Use aerosol insecticide inside bed net.
- d. Protect against diarrhea.**
- (1) Follow water sanitation guidelines.
    - (a) Fill canteen with treated water, when possible.
    - (b) Treat water (when treated water is not available) with iodine tablets, chlorine ampules, or boil water for 5 to 10 minutes (if iodine or chlorine is not available). (Boiling water for only 15 seconds will help.)

---

**Performance Steps**

---

- (2)** Follow food sanitation guidelines.
    - (a)** Use approved food sources.
    - (b)** Wash your mess kit carefully, in a mess kit laundry and with treated water.
    - (c)** Wash hands after using the latrine and before touching food or food contact surfaces.
    - (d)** Bury waste or otherwise properly dispose of waste to prevent spread of germs by flies.
  - e.** Prevent injuries from non-NBC chemical hazards.
    - (1)** Prevent carbon monoxide poisoning by—
      - (a)** Running engines outside.
      - (b)** Using natural ventilation or tailpipe extension systems to dispose of exhaust fumes.
      - (c)** Never using engine exhaust for heat.
    - (2)** Prevent hydrogen chloride (and other propellant exhaust) injuries by—
      - (a)** Positioning yourself upwind of rocket systems.
      - (b)** Holding your breath (after the blast) until the cloud passes.
    - (3)** Prevent injuries from bore/gun gases (from conventional weapons).
      - (a)** Use on-board ventilation systems.
      - (b)** Keep the bore evacuator well maintained on large weapon systems.
    - (4)** Prevent injuries from solvents, greases, and oils (liquid chemicals).
      - (a)** Minimize worker exposure by substituting less harmful chemicals for toxic chemicals.
      - (b)** Use personal protective equipment and practice good personal hygiene.
      - (c)** Comply with replacement and medical surveillance physical examinations to detect early signs of occupational disease.
  - f.** Prevent noise hazard injuries.
    - (1)** Use protective devices (earplugs, ear canal caps, or earmuffs).
    - (2)** Use vehicle headgear such as helicopter crew helmets and armored vehicle crew helmets.
- 

Skill Level 2

**Performance Steps**

- (3) Keep hearing protection devices clean to avoid ear infections.
- (4) Avoid noise and/or limit the time in noise hazardous areas.
- g. Prevent other DNBI (individual PMM).
  - (1) Protect against skin disease.
    - (a) Protect skin from elements.
    - (b) Use sunscreen, if necessary.
    - (c) Keep skin as clean as possible.
  - (2) Protect against altitude sickness.
    - (a) Acclimatize to new elevations.
    - (b) Increase aerobic exercise prior to exposure.
    - (c) Follow medical advice.
  - (3) Avoid harmful animals.
    - (a) Avoid habitats of harmful animals.
    - (b) Do NOT attempt to capture or make pets of harmful animals.
  - (4) Refrain from tobacco use.
- 4. Explain the Army's tobacco use policies.
  - a. Effects of tobacco use.
  - b. Mission readiness.
  - c. Army policies.
    - (1) Army's Healthy #1 People 2000 Goal: reduce military smokers to 20 percent.
    - (2) Army's Healthy #2 People 2000 Goal: reduce smokeless tobacco use to 4 percent for the 12-to-24 year age group.
    - (3) Regulatory requirements under AR 600-63.
- 5. Ensure training of personnel as members of a field sanitation team (FST) is provided if appropriate.

**Note.** Training of FST members enables unit commanders to provide for limited control of insects, proper disinfection of water, and safe food supplies. Training of personnel as FST members will be provided by supporting medical resources.

  - a. FST members, when no organic medical personnel are available.
    - (1) Two soldiers are selected to receive FST training.
    - (2) One soldier must be an NCO.
    - (3) Neither will have less than six months of unit time remaining.

Skill Level 2

**Performance Steps**

(4) These soldiers should receive training from PM personnel in accordance with AR 40-5.

**Note.** All unit leaders are expected to perform FST tasks.

b. FST tasks and/or responsibilities. The unit FST performs the following tasks in the unit area:

- (1) Checks unit water supplies.
- (2) Inspects unit water containers and unit water trailers.
- (3) Inspects unit field food operations for application of PMM to prevent contamination.
- (4) Conducts limited control of insects.
- (5) Inspects unit waste disposal for compliance with accepted PMM.
- (6) Conducts limited control of rodents.
- (7) Provides training for individual PMM training in the unit.
- (8) Advises unit leaders on construction and maintenance of field waste disposal and personal hygiene devices.

**Evaluation Preparation:**

*Setup:* Evaluate each soldier individually during a field training exercise (FTX) or normal training session. Use the location, weather conditions, and duration of the FTX as the scenario to base your evaluation questions around. If the evaluation is conducted during normal training sessions, create a scenario as the basis for your evaluation questions.

*Brief Soldier:* Tell the soldier he will be evaluated on his ability to answer preventive medicine measure questions pertaining to the training scenario provided.

Performance Measures	GO	NO GO
1. Identified the three reasons soldiers are vulnerable to disease.	___	___
2. Identified the seven major components of the medical threat to field forces.	___	___
3. Identified preventive medicine measures used in the prevention of various diseases and nonbattle injuries.	___	___
4. Identified the Army's tobacco use policies.	___	___
5. Identified requirements for FST manning and training.	___	___

**Evaluation Guidance:** Score the soldier GO if all performance measures are passed. Score the soldier NO GO if any performance measure is failed. If the soldier scores NO GO, show what was done wrong and how to do it correctly.

#### References

##### Required

##### Related

AR 40-5  
AR 600-63  
FM 4-25.12  
FM 21-10

### SUBJECT AREA 3: NUCLEAR, BIOLOGICAL, AND CHEMICAL (NBC)

## 031-503-1023

### Protect Yourself from Nuclear, Biological, and Chemical Injury/Contamination When Changing Mission-Oriented Protective Posture Gear

**Conditions:** You are in MOPP 4 with load-bearing equipment (LBE). Your MOPP gear is contaminated. Your buddy is in MOPP 4 with LBE, and he is available to assist you with MOPP gear exchange. You have an uncontaminated set of chemical MOPP gear for yourself and your buddy and a personal decontaminating kit. For chemical and biological (CB) decontamination, you have one personal decontamination kit per person; one 50-pound drum of super tropical bleach (STB) dry mix; and a piece of plastic, a poncho, or similar material. For radiological decontamination, you have 5 gallons of water (if water is not available for radiological decontamination, brush, wipe, or shake off contamination); three pails (3-gallon capacity); one can of government issue (GI) soap or liquid detergent; two sponges; paper towels; and a piece of plastic, a poncho, or similar material.

**Standards:** Decontaminated individual gear and equipment without spreading contamination onto skin or undergarments. Set uncontaminated gear aside on an uncontaminated surface. Changed overgarments, overboots, and gloves without spreading contamination to the uncontaminated set of MOPP gear. Changed MOPP gear without yourself or your buddy becoming a casualty.

#### Performance Steps

**Note.** Both soldiers perform steps 1 and 2 at the same time.

---

**Performance Steps**

---

**Note.** If the environment is only CB contaminated, omit steps 2 and 4. If the environment is only radiologically contaminated, omit steps 1 and 3. If the environment is radiologically and CB contaminated, perform all steps.

1. Decontaminate your individual gear for CB contamination without assistance.

**Note.** If at any time during the technique you suspect you have spread contamination onto your skin or undergarments, decontaminate immediately with the personal decontaminating kit available; then proceed with the MOPP gear exchange.

- a. Remove your chemical protective helmet cover, and discard it.
  - b. Cover your gear with STB dry mix.
  - c. Brush or rub STB dry mix into the material, and shake off any excess STB.
  - d. Set your gear aside on an uncontaminated surface (plastic, poncho, or similar material).
2. Decontaminate your individual gear for radiological contamination, without assistance.

- a. Brush, wipe, or shake off dust or radiological contamination from your individual gear.
- b. Wash the equipment with warm, soapy water if available.
- c. Set the equipment aside to dry on an uncontaminated surface (plastic, poncho, or similar material).

**Note.** Do not reverse roles until steps 3 through 8 are completed.

3. Decontaminate your hood and mask for CB contamination.

- a. Buddy # 1—
    - (1) Loosens Buddy # 2's drawcord.
    - (2) Removes Buddy # 2's under-arm straps from under his arms.
    - (3) Moves Buddy # 2's straps over his shoulders.
    - (4) Reattaches Buddy # 2's straps to the Velcro<sup>R</sup> and hook-and-pile patches on the bottom of his hood.
  - b. Buddy # 1 decontaminates Buddy # 2's hood and exposed parts of his mask using the M291 decontamination kit.
    - (1) Buddy # 1 wipes Buddy # 2's mask eye lens outserts first.
    - (2) Buddy # 1 wipes Buddy # 2's entire mask from the top of the hood down.
  - c. Buddy # 1 repeats steps 3b(1) and (2) on his own hood and mask using the M291 decontamination kit.
-

**Performance Steps**

- d. Buddy # 1 decontaminates his own gloves with the personal decontaminating kit after Buddy # 2's mask is decontaminated.
4. Decontaminate your hood and mask for radiological contamination.
- Buddy # 1 dips a sponge in hot, soapy water and wipes Buddy # 2's mask and hood (and the canister and hose of the M42-, M43-, or M40-series protective masks).
  - Buddy # 1 rinses Buddy # 2's hood and mask with a sponge dipped in clean water.
  - Buddy # 1 dries Buddy # 2's hood and mask with paper towels or a rag.
  - Buddy # 1 wipes down his gloves.

**Note.** Cool, soapy water is not as effective for removing contamination, but it can be used if you scrub longer. If no water is available, the personal decontaminating kit may be used for CB decontamination.

5. Roll your hood.

**Note.** Leave the zipper closed.

- Buddy # 1 lifts Buddy # 2's hood straight up off his shoulders by grasping the straps.
- Buddy # 1 pulls Buddy # 2's hood over his head until most of the back of his head is exposed (the hood should not be completely over Buddy # 2's face).
- Buddy # 2 places his hand over the voice transmitter, if necessary, to prevent the mask seal from being broken.
- Buddy # 1 rolls Buddy # 2's hood tightly, starting at the chin and working around the mask without pulling it completely off the back of his head.

**Note.** Do not reverse roles. Go to the next step. Only Buddy # 2 will have his hood decontaminated and rolled at this time.

6. Remove your jacket.

- Buddy # 1—
  - Unties Buddy # 2's cord.
  - Unfastens Buddy # 2's snaps on the front of his jacket.
  - Unzips Buddy # 2's jacket.
  - Unsnaps Buddy # 2's snaps in the back of his jacket from his overgarment trousers.
- Buddy # 2 makes a fist as each sleeve is pulled off to prevent his gloves from coming off.



---

**Performance Steps**

---

c. Buddy # 1 pulls Buddy # 2's jacket off, one arm at a time, turning the jacket inside out.

d. Buddy # 1 places Buddy # 2's jacket on the ground nearby with the black side up.

**Note.** Buddy # 2 will use the jacket later as an uncontaminated surface to stand on while redressing.

7. Remove your trousers.

a. Buddy # 1 opens Buddy # 2's trouser cuffs, waist snap, zipper and, if necessary, waist tabs.

b. Buddy # 1 grasps Buddy # 2's trouser leg by the cuff.

c. Buddy # 2 pulls his legs from the trousers, one leg at a time.

8. Remove your overboots.

a. Buddy # 2 stands next to his jacket.

b. Buddy # 1 unties or cuts Buddy # 2's overboot strings.

c. Buddy # 1 pulls Buddy # 2's overboots off, one at a time.

d. Buddy # 2 steps onto his jacket as his overboots are removed.

9. Remove your rubber gloves. Buddy # 1 helps Buddy # 2 remove his rubber gloves so he does not touch the outside of the rubber gloves with his bare hands.

10. Put on an uncontaminated overgarment.

a. Buddy # 1 opens the package containing a new overgarment, without touching it.

b. Buddy # 2 removes the overgarment, one piece at a time, without touching the outside of the package.

(1) Buddy # 2 puts on the new trousers, leaving the cuffs open.

(2) Buddy # 2 puts on the jacket.

11. Put on the overboots.

a. Buddy # 1 opens the package containing the new overboots without touching them.

b. Buddy # 2 removes the overboots without touching the outside of the package.

c. Buddy # 2 puts the overboots on.

12. Put on the gloves.

a. Buddy # 1 opens the package containing the new chemical protective gloves without touching them.

---

Skill Level 2

**Performance Steps**

b. Buddy # 2 removes the chemical protective gloves without touching the outside of the package.

c. Buddy # 2 puts the gloves on.

13. Secure the hood.

a. Buddy # 1 decontaminates his chemical protective gloves with the personal decontaminating kit.

b. Buddy # 1 repositions Buddy # 2's hood as follows:

**Note.** Buddy # 1's gloves must be decontaminated before proceeding with this step.

(1) Buddy # 1 unrolls Buddy # 2's hood.

(2) Buddy # 1 reattaches Buddy # 2's straps.

c. Buddy # 2 checks all the zippers and ties on his hood and overgarment to ensure they are closed.

14. Repeat steps 3 through 13. Buddy # 1 and Buddy # 2 reverse the roles.

15. Secure the gear.

a. Buddy # 1 and Buddy # 2 place the new chemical protective cover on their helmet.

b. Buddy # 1 and Buddy # 2 put their individual gear back on.

c. Buddy # 1 checks the fit of Buddy # 2's gear.

d. Buddy # 2 checks the fit of Buddy # 1's gear.

16. Move to the assembly area.

**Evaluation Preparation:**

*Setup:* Evaluate this task during a field exercise or a normal training session. Soldiers must be in MOPP 4. Use the M291 decontamination kit.

*Brief Soldier:* Identify pairs, designating Buddy # 1 and Buddy # 2. Provide each soldier with one of the following three scenarios: the soldier has been exposed to CB contamination (the soldier can omit steps 2 and 4); the soldier has been exposed to radiological contamination (the soldier can omit steps 1 and 3); or the soldier has been exposed to radiological and chemical and/or biological contamination (the soldier must perform all steps).

Performance Measures	GO	NO GO
1. Decontaminated individual gear for CB contamination, without assistance.	—	—
2. Decontaminated individual gear for radiological contamination, without assistance.	—	—

Performance Measures	GO	NO GO
3. Decontaminated hood and mask for CB contamination.	—	—
4. Decontaminated hood and mask for radiological contamination.	—	—
5. Rolled hood.	—	—
6. Removed jacket.	—	—
7. Removed trousers.	—	—
8. Removed overboots.	—	—
9. Removed rubber gloves.	—	—
10. Put on an uncontaminated overgarment.	—	—
11. Put on overboots.	—	—
12. Put on gloves.	—	—
13. Secured hood.	—	—
14. Repeated steps 3 through 13. Buddy # 1 and Buddy # 2 reversed roles.	—	—
15. Secured gear.	—	—
16. Moved to assembly area.	—	—

Skill Level 2

**Evaluation Guidance:** Score the soldier GO if all performance measures are passed. Score the soldier NO GO if any performance measure is failed. If the soldier fails, show him how to do it correctly.

**References**

**Required**

FM 3-5

**Related**

---

**031-503-2001**

**Identify Chemical Agents Using M256-Series Chemical Agent Detector Kit**

**Conditions:** Given a tactical environment or a simulated chemically (nerve and blister) contaminated area and M256-series chemical agent detector kit,

protective mask, mission-oriented protection posture (MOPP) gear or chemical protective ensemble, watch, TM 3-6665-307-10, and FM 3-5.

**Standards:** Identified chemical agents using an M256-series chemical agent detector kit without becoming a casualty.

---

**Performance Steps**

---

1. Perform before-operation preventive maintenance checks and services (PMCS) according to TM 3-6665-307-10.
2. Prepare the kit for use.
  - a. Read all the instruction cards in the kit.
  - b. Remove one sampler detector from the kit, and read the instructions printed on the bag.

**WARNING**

Do not expose the sampler detector to heavy rain or other forms of water. Test results could be tainted.

Do not touch the sampler detector test spots. Dirt and oil from your gloves will cause test results to be tainted.

- c. Remove the sampler detector from the bag (save the bag and use the instructions printed on the outside). Discard the sampler detector if there are broken or missing ampules, missing spots, or crushed reagent channels, or if the blood agent test spot is pink.
3. Test for toxic-agent vapors.
  - a. Swing out the heater and remove and save the two heater pads (used for breaking glass ampules). Swing the heater back in. Keep the protective strips over the spots.
  - b. Remove the pull tab (marked 1) to expose the lewisite detecting tablet. Bend the tab (marked 2) over the lewisite detecting tablet, and rub the upper half of the tab until a mark is visible.

**WARNING**

Before breaking the glass ampules (except heater ampules), place one heater pad on each side of the sampler detector, covering the ampule to be broken. The pads will prevent pieces of glass from cutting your gloves and hands.

- c. Hold the sampler detector with the test spots and the arrow pointing up. Crush the four center ampules (marked 3).
    - d. Turn the sampler detector so the arrow points down. Use the heater pads to squeeze the ampules, forcing liquid through the formed channels into the test spots.
-

Skill Level 2

---

**Performance Steps**

---

e. Hold the sampler detector with the arrow pointed down and your thumb on the protective strip over the middle test spot.

(1) Swing the heater away from the blister test spot.

(2) Activate the first heater ampule (marked 4) by crushing one green ampule, swing the heater back over the test spot, and leave it in place for 2 minutes. Hold the sampler detector to one side to avoid the vapor. Do not use the heater pads to crush green ampules.

**WARNING**

Do not use the heater pads to crush the green ampules.

(3) Swing the heater and the protective strip away from the test spots.

**WARNING**

Do not hold the sampler detector in direct sunlight while exposing the test spots, because test results could be tainted.

f. Expose the test spots to air (shield them from direct sunlight) for 10 minutes. Lay the sampler detector down or hold it by the hinged protective strip.

g. Crush the second green ampule (marked 4) after 10 minutes and immediately swing the heater over the blister test spot. Swing the heater away from the test spot after 1 minute.

**WARNING**

Do not use the heater pads to crush the green ampules.

h. Hold the sampler detector with the arrow pointing down and the test spots exposed. Use the heater pads to crush the remaining ampules (marked 5). Wet the test spots by squeezing the ampules and forcing liquid onto them.

i. Bend the tab (marked 2) over the lewisite detecting tablet, and rub the bottom half of tab until a mark is visible.

j. Turn the sampler detector upside down, and compare the colors of the test spots (including the lewisite tab) with those shown on the sampler detector.

(1) Compare the blood agent (round) test spot after about 10 minutes exposure time.

(a) Yellow or orange sometimes occur when no agent is present.

---

**Performance Steps**

(b) Pink or blue must be present to indicate blood agents. Any combination of colors or a rainbow effect that includes pink or blue should be considered as a positive blood agent test.

(2) Compare the lewisite test after about 10 minutes exposure time. Look very closely; at low concentrations, the color change may be very slight.

**Note.** Blister agents (H and CX) develop color immediately after all ampules are broken.

(3) Wait 3 minutes for the nerve-agent test.

**NOTE.** Disregard any small blue or blue-green areas under the plastic rim of the nerve agent spot.

(a) M256: If a peach color develops, a positive nerve test is indicated.

(b) M256A1: If no color develops, a positive nerve test is indicated.

4. Report the results to your supervisor.

5. Dispose of the materials by one of the following methods:

a. Dispose of expended or unserviceable materials according to Federal, state, and local laws; military regulations and publications; host nation laws (if more restrictive than U.S. laws); and the local standing operating procedures (SOP). As a minimum, place used decontaminating materials in a sealed plastic bag and label it with the contents.

b. Dispose of contaminated hazardous waste materials according to FM 3-5.

6. Perform after-operation PMCS according to TM 3-6665-307-10.

a. Ensure M8 detector paper is present.

b. Ensure there are at least four sample-detectors in the kit.

**Evaluation Preparation:**

**Setup:** Evaluate this task during a field exercise or a tactical training session. The contaminated area should be set up with nerve and blister simulated agents. Use M256 training aid kits for training and evaluation purposes.

**Brief Soldier:** Tell the soldier he will be evaluated on his ability to perform operator checks of the chemical agent detector kit, to put the kit into operation using the correct sequence while in MOPP 4, and to identify agent(s) within the limitations of the kit.

Performance Measures	GO	NO GO
1. Performed before-operation PMCS according to TM 3-6665-307-10.	___	___
2. Prepared the kit for use.	___	___
3. Tested for toxic-agent vapors.	___	___
4. Reported the results to the supervisor.	___	___
5. Disposed of expended or unserviceable kits.	___	___
6. Disposed of hazardous waste materials.	___	___
7. Performed after-operation PMCS.	___	___

Skill Level 2

**Evaluation Guidance:** Score the soldier GO if all performance measures are passed. Score the soldier NO GO if any performance measure is failed. If the soldier fails, show him how to do it correctly.

**References**

**Required**

FM 3-5  
TM 3-6665-307-10

**Related**

---

**031-503-2023**

**Measure Radiation Dose Rate and Total Dose**

**Conditions:** Given a tactical situation where nuclear contamination has occurred and radiation monitoring has been directed in your unit area. You are provided with an individual team or squad; radiation, detection, indication, and computation (RADIAC) detection equipment (dosimeters must be of the same type); a nuclear, biological, and chemical (NBC) marking set; a watch; (a vehicle or an aircraft, depending on mission requirements); communications equipment; DA Form 2404, *Equipment Inspection and Maintenance Worksheet*, 1971-R, *Radiological Data Sheet-Monitoring or Point Technique*, and DA Form 1971-6-R, *Chemical/Biological Sample Documentation*; and with applicable technical manuals (TMs), technical bulletins (TBs), and standing operating procedures (SOPs). Given the supervisor's guidance on continuous or periodic monitoring, the use of direct or indirect technique, intervals between readings (for monitoring dose rates only), and communication and reporting procedures.

**Standards:** Performed operator preventive maintenance checks and services (PMCS) on equipment used. Reported and recorded accurate

Skill Level 2

031-503-2023

3-47

readings (+ 5 centigray [cGy]) to supervisor. Complied with the commander's operation exposure guidance and turn-back dose rate without overexposing personnel.

**Note.** There is no degradation to standards if this task is performed in MOPP 4.

---

**Performance Steps**

---

1. Perform PMCS on the RADIAC equipment.
    - a. Use TM 11-6665-232-12 for PMCS on the IM174 series RADIAC meter.
    - b. Use TM 11-6665-251-10 for PMCS on the AN/VDR-2 RADIAC set.
    - c. Use TM 11-6665-365-12&P for PMCS on the AN/UDR-13 RADIAC set.
    - d. Use TM 11-6665-214-10 for PMCS on the IM93 dosimeter.
    - e. Use TB Signal (Sig) 226-8 for PMCS the PP1578 RADIAC charger.
    - f. Use TM 11-6665-236-12 for PMCS on the AN/PDR-75 with DT-236 dosimeter.
  2. Measure the radiation dose rate.
    - a. Use TM 11-6665-232-12 for operation of the IM174-series RADIAC meter.
    - b. Use TM 11-6665-251-10 for operation of the AN/VDR-2 RADIAC meter.
    - c. Use TM 11-6665-365-12&P for operation of the AN/UDR-13 RADIAC meter.
    - d. Record the data on DA Form 1971-R.
    - e. Report the data to the supervisor.

**Note.** The data will be placed into an NBC 4 nuclear report by your supervisor or the unit NBC control party.

    - f. Conduct continuous or periodic monitoring (guidance received from supervisor).
    - g. Use the direct or indirect technique (guidance received from supervisor).
    - h. Take readings at proper intervals (guidance received from supervisor).
  3. Measure the total dose of radiation.
    - a. Use TM 11-6665-251-10 to measure the total dose with the AN/VDR-2 RADIAC set.
    - b. Use TM 11-6665-214-10 to measure the total dose with the IM93 dosimeter.
-



Skill Level 2

**Performance Steps**

**Note.** The DT-236 is worn on the wrist like a wristwatch, and measures cumulative doses of gamma and neutron radiation. It augments the IM93. The company AN/PDR-75 operator reads the DT-236. The company NBC control party records and processes this data.

- c. Use TM 11-6665-365-12&P to measure the total dose using the AN/UDR-13 RADIAC set.
- 4. Record the data on DA Form 1971-R (except for DT-236).
- 5. Report the data to supervisor (except for DT-236).

**Evaluation Preparation:**

*Setup:* Evaluate this task during a field exercise or a tactical training session. The AN/TDQ-T1 large-area RADIAC training set can be used to produce readings for RADIAC meters and RADIAC sets.

*Brief Soldier:* Tell the soldier that the test will consist of performing PMCS, preparing the equipment for use, monitoring a designated area, recording the total dose/dose rate, and reporting the results to the supervisor. The actual completion of DA Form 2404 and DA Form 1971-R is not degraded if this task is performed in MOPP 4.

Performance Measures	GO	NO GO
1. Performed PMCS on the RADIAC equipment.	___	___
2. Measured the radiation dose rate.	___	___
3. Measured the total dose of radiation.	___	___
4. Recorded the data on the appropriate form.	___	___
5. Reported the data to the supervisor.	___	___

**Evaluation Guidance:** Score the soldier GO if all performance measures are passed. Score the soldier NO GO if any performance measure is failed. If the soldier fails, show him how to do it correctly.

**References**

**Required**

- DA Form 1971-6-R
- DA Form 1971-R
- DA Form 2404
- TB Sig 226-8
- TM 11-6665-214-10
- TM 11-6665-232-12

**Related**

**References****Required**

TM 11-6665-236-12  
 TM 11-6665-251-10  
 TM 11-6665-365-12&P

**Related****031-503-3002****Conduct Unmasking Procedures**

**Conditions:** Given a tactical situation and a group of soldiers in mission-oriented protective posture (MOPP) 4, an M256A1 chemical agent detector kit or an M256A1 trainer kit, a chemical agent monitor (CAM), M8/M9 detector paper, an area where chemical agents have been used, and one of the following situations:

1. An M256A1 chemical agent detector kit is available.
2. An M256A1 is not available.

**Standards:** Conducted unmasking procedures without incurring casualties.

**Performance Steps**

**Note.** Before conducting unmasking procedures, make every effort to confirm the absence of chemical contamination. A CAM, an M256 chemical agent detector kit, and M8/M9 detector paper should be used along with a visual check of the area.

**Note.** The senior person present selects one or two soldiers to unmask after permission is received from higher headquarters.

1. Conduct unmasking procedures using an M256A1 detector kit.
  - a. Conduct unmasking procedures in the shade.
  - b. Use an M256A1 detector kit to test for chemical agents. Use M8 detector paper to check for possible liquid contamination. Continue unmasking procedures only if both tests are negative.
  - c. Direct the selected soldiers to unmask for 5 minutes and don, seal, and clear their masks.
  - d. Observe the soldiers for 10 minutes for chemical agent symptoms.
  - e. Direct all soldiers to unmask if no symptoms appear.
  - f. Check the soldiers for delayed symptoms. Have first aid treatment available.
  - g. Complete steps 1a through 1f in sequence.
2. Conduct unmasking procedures without using an M256A1 detector kit.
  - a. Conduct unmasking procedures in the shade.

Skill Level 2

---

**Performance Steps**

---

- b. Use M8 detector paper to check for possible liquid contamination. Continue unmasking procedures only if the test is negative.
  - c. Direct the selected soldiers to take a deep breath, break the seals of their masks (keeping their eyes open) for 15 seconds, and seal and clear their masks.
  - d. Observe the soldiers for 10 minutes for chemical agent symptoms.
  - e. Direct the soldiers to break the seals of their masks if no symptoms appear, take two or three breaths, and seal and clear their masks.
  - f. Observe the soldiers for 10 minutes for symptoms.
  - g. If no symptoms appear, direct the soldiers to unmask for 5 minutes and don, seal, and clear their masks.
  - h. Observe the soldiers for 10 minutes for symptoms.
  - i. If no symptoms appear, direct all soldiers to unmask.
  - j. Check the soldiers for delayed symptoms. Have first aid treatment available.
  - k. Complete steps 2a through 2j in sequence.
3. Report the absence of contamination in your area and the successful completion of unmasking procedures to higher headquarters .
- 

**Evaluation Preparation:**

*Setup:* Evaluate this task during a field exercise or during a tactical training session. The M256A1 trainer kit will be used for training and evaluation purposes.

*Brief Soldier:* Tell the soldier he will be evaluated on his ability to conduct unmasking procedures with and without the use of a chemical agent detector kit. The soldiers taking part in the process will act only as directed by the soldier conducting the unmasking exercise and will not be evaluated on their performance.

Performance Measures	GO	NO GO
1. Conducted unmasking procedures in sequence using an M256A1 detector kit.	—	—
2. Conducted unmasking procedures in sequence without using an M256A1 detector kit.	—	—
3. Reported the absence of contamination in the area and the completion of unmasking procedures to higher headquarters .	—	—

**Evaluation Guidance:** Score the soldier GO if all performance measures are passed. Score the soldier NO GO if any performance measure is failed. If the soldier fails, show him how to do it correctly.

#### References

##### Required

FM 3-4

TM 3-6665-307-10

##### Related

### 031-503-3004

#### Supervise the Crossing of a Contaminated Area

**Conditions:** You receive orders to cross a nuclear, biological, or chemical contaminated area. Given a unit with mission-oriented protection posture (MOPP) gear; organic decontamination equipment (such as M13 decontaminating apparatus portable (DAP) and individual decontaminating kits), chemical (such as M256 chemical agent detector kit, M8 chemical agent detector paper, and M9 chemical detector tape) and radiological (such as IM174-series radiation, detection, indication, and computation [RADIAC] meter, AN/UDR-13 and AN/VDR-2 RADIAC sets, and IM93 dosimeter) detection and/or warning devices; shielding material (such as sandbags); and a defined NBC contaminated area.

**Standards:** Supervised a unit crossing or passing through a nuclear, biological, or chemical contaminated area without producing additional casualties or spreading contamination.

#### Performance Steps

1. Supervise a unit crossing a nuclear contaminated area.
  - a. Before crossing—
    - (1) Provide shielding for personnel. Use vehicles if possible. Place sandbags on the floor and sides of all vehicles (within reason for nonarmored vehicles).
    - (2) Tell vehicle operators to close all doors, windows, hatches, and vents on their vehicles.
    - (3) Have soldiers cover all exposed skin by rolling down their sleeves and buttoning their collars. Ensure that they wear handkerchiefs or similar cloths over their noses and mouths to keep from breathing radioactive dirt or dust.
    - (4) Select the shortest possible route that would cause the least contamination and permit the fastest travel based on mission, enemy, terrain, troops, time available, and civilian considerations (METT-TC).

---

**Performance Steps**

---

- (5) Ensure that IM93 dosimeters are available and charged to zero.
- (6) Ensure that AN/UDR-13 and AN/VDR-2 RADIAC sets are available and operational.
- (7) Delay entry into the area as long as possible within the limits of the mission.
  - b. During crossing—
    - (1) Perform continuous monitoring.
    - (2) Have the monitors watch the dose rate on the AN/UDR-13 or AN/VDR-2 RADIAC set. Instruct them to keep you informed. Ensure that the commander's turn-back dose rate is not exceeded without approval.
    - (3) Have all personnel with dosimeters check them often to ensure that the commander's turn-back dose is not exceeded without approval.
    - (4) Move through the area as quickly as possible. Do not forget safety or security.
    - (5) Ensure that vehicles are far enough apart during movement to minimize dust. Consider the tactical situation, the command, and the control when spacing the vehicles.
  - c. After crossing—
    - (1) Have personnel check themselves and their equipment for contamination. Have everyone brush the dust from his or her clothing.
    - (2) Determine if decontamination is required.
- 2. Supervise a unit crossing a chemical contaminated area.
  - a. Before crossing—
    - (1) Select the shortest possible route that would cause the least contamination and allow the fastest travel based on METT-TC.
    - (2) Tell vehicle operators to close all doors, windows, hatches, and vents on their vehicles.
    - (3) Assume MOPP 4.
    - (4) Have soldiers attach M9 detector paper to their clothing and equipment.
  - b. During crossing—
    - (1) Ensure that vehicles are far enough apart during movement to minimize dust. Consider the tactical situation, the command, and the control when spacing vehicles.
    - (2) Move through the area as quickly as possible. Do not forget safety or security. Continuously monitor personnel for chemical agent symptoms, and give first aid as required.

Skill Level 2

**Performance Steps**

- (3) Ensure that soldiers avoid touching anything in the area if possible.
- (4) Monitor personnel closely for symptoms of heat stress, and minimize excessive heat buildup.
- c. After crossing—
  - (1) Continue to monitor soldiers for chemical agent symptoms, and give first aid as required.
  - (2) Have soldiers use detector paper to check themselves and their equipment for contamination.
  - (3) Have soldiers use their decontaminating kits to decontaminate any contaminated skin or personal equipment. Seek medical aid as required.
  - (4) Have vehicle operators use available decontaminating equipment to decontaminate their vehicles, if required.
- 3. Supervise a unit crossing a biological contaminated area.
  - a. Before crossing—
    - (1) Select the shortest possible route that would cause the least contamination and allow the fastest travel based on METT-TC.
    - (2) Tell vehicle operators to close all doors, windows, hatches, and vents on their vehicles.
    - (3) Assume the appropriate MOPP level, as required.
  - b. During crossing—
    - (1) Move through the area as quickly as possible. Do NOT forget safety or security.
    - (2) Ensure that personnel do NOT touch anything in the area that can be avoided.
    - (3) Ensure that vehicles are far enough apart during movement to minimize dust. Consider the tactical situation, the command, and the control when spacing vehicles.
  - c. After crossing—
    - (1) Decontaminate personnel and equipment by washing them thoroughly with hot, soapy water, if time and mission permit.
    - (2) Do as many of the steps as possible for the types of contamination present in the area.
    - (3) Seek medical aid if required.

**Evaluation Preparation:**

*Setup:* Evaluate this task during a field exercise or a normal training session. The contaminated area may have been marked with the appropriate

Skill Level 2

markers, or a diagram may have been prepared showing the boundary of the contaminated area, the soldier's present location, and the desired direction of travel. Gather the necessary equipment and personnel to conduct the movement. Obtain, for training purposes, fictitious commander's operational exposure guidance (OEG) on the turn-back dose and the turn-back dose rate.

**Note.** Before conducting this task, ensure that soldiers have been trained on the following tasks: 031-503-2020, 031-503-2001, 031-503-2013, 031-503-1037, 031-503-1013, and 031-503-2023.

**Brief Soldier:** Tell the soldier to supervise the movement of a unit through a nuclear, biologically, or chemically contaminated area by performing the appropriate measures before, during, and after the movement through the area. Give the soldier an illustration, showing the boundary of the contaminated area, the soldier's present location, and desired direction of travel through the contaminated area.

Performance Measures	GO	NO GO
1. Supervised a unit crossing a nuclear contaminated area.	___	___
2. Supervised a unit crossing a chemically contaminated area.	___	___
3. Supervised a unit crossing a biologically contaminated area.	___	___

**Evaluation Guidance:** Score the soldier GO if all performance measures are passed. Score the soldier NO GO if any performance measure is failed. If the soldier fails, show him how to do it correctly.

**References**

- Required**  
 FM 3-3  
 FM 3-4  
 FM 3-5

**Related**

---

**031-503-3005**  
**Submit an NBC 1 Report**

**Conditions:** A nuclear, biological, and chemical (NBC) attack has just occurred in your area. You are given a watch, a map, a compass, a protractor, a pencil, paper, and the NBC report format guide (Graphic Training Aid [GTA] 03-06-008) or DA Form 1971-7-R, *NBC-1 Observers Initial/Follow-Up Report*.

**Standards:** Submitted the NBC 1 report with the required information. Completed and submitted a spot report (SPOTREP) to give an immediate attack notification.

---

**Performance Steps**

---

1. React to an NBC attack or hazard.
  - a. React to a nuclear attack or hazard.
  - b. React to a chemical or biological attack or hazard.

**Note.** The purpose of the SPOTREP is to give immediate notification of the NBC attack.
2. Submit a SPOTREP immediately (use the size, activity, location, unit, time, and equipment [SALUTE] format if possible) for attack notification.
3. Submit an NBC 1 (observer's) report after gathering the available data.
  - a. Complete the required information as outlined in GTA 03-06-008, FM 3-3 (chemical or biological), or FM 3-3-1 (nuclear) to include—
    - (1) Line B: Location of observer (use grid coordinates or place name).
    - (2) Line D: Date-time group (DTG) of the attack (specify local or Zulu time).
    - (3) Line H: Type and height of burst (nuclear) or type of agent and persistency (chemical or biological).
    - (4) Line C: Direction of attack in mils or degrees from the observer; or  
Line F: Location of attack, grid coordinates, or place name.
  - b. Select the proper communication precedence.

**Note.** Flash reports should NOT be delayed for lack of information.

  - (1) Use flash precedence if this is the first attack of its type (the first nuclear attack, the first biological attack, or the first chemical attack). (Flash precedence is used to report the first use of NBC weapons against U.S. troops.)

**Note.** A flash precedence is used to report the first use of NBC weapons against U.S. troops.

  - (2) Use immediate precedence for all other attacks.

**Note.** Line L (nuclear) is measured 5 minutes after the attack, and Line M (nuclear) is measured 10 minutes after the attack. Submit the NBC 1 nuclear report after Line L or Line M is measured. The M256-series chemical agent detector kit takes 16 minutes to produce reliable results. Submit the NBC 1 Report after this test is done.



Skill Level 2

**Performance Steps**

c. Submit the NBC 1 report to the correct places.

**Note.** Units selected by the division level NBC center (NBCC) as designated observers (applies only to nuclear bursts) also submit the NBC 1 report directly to the division level NBCC. All units submit the NBC 1 report to their higher headquarters.

**Evaluation Preparation:**

*Setup:* Gather the items provided in the conditions statement. Develop a situation containing observer data. (This information may be written.) A different situation should be developed for each type of report.

*Brief Soldier:* Tell the soldier that the test will consist of submitting SPOTREPs and preparing and submitting NBC 1 reports. Give the necessary items to the soldier, including the data you developed. Tell the individual to give a warning and prepare reports of an NBC event.

Performance Measures	GO	NO GO
1. Reacted to an NBC attack or hazard.	___	___
2. Submitted a SPOTREP immediately for attack notification.	___	___
3. Submitted an NBC 1 report after gathering available data and completing the required information for the report according to GTA 03-06-008.	___	___

**Evaluation Guidance:** Score the soldier GO if all performance measures are passed. Score the soldier NO GO if any performance measure is failed. If the soldier fails, show him how to do it correctly.

**References**

**Required**

FM 3-3  
FM 3-3-1  
GTA 03-06-008

**Related**

DA Form 1971-2-R  
DA Form 1971-7-R

**031-503-3008**

**Implement Mission-Oriented Protective Posture**

**Conditions:** You are in a nuclear, biological, or chemical environment or are warned of a threat of a NBC hazard. Given two or more soldiers with MOPP gear, M8 and M9 detector paper, an M291 or M295 decontaminating kit, three nerve agent antidote autoinjectors, and a requirement to assume the appropriate MOPP level and check soldiers sleeping in MOPP 4.

**Standards:** Implemented MOPP and directed soldiers to assume the appropriate MOPP level based on MOPP guidance from the commander. Identified all deficiencies and took appropriate corrective action for soldiers sleeping in MOPP 4.

---

**Performance Steps**

---

1. Direct soldiers to put on MOPP gear and equipment for MOPP 1 through MOPP 4. (See STP 21-1-SMCT, Task 031-503-1015.)
    - a. Ensure the soldiers assume MOPP 1.
    - b. Ensure the soldiers assume MOPP 2.
    - c. Ensure the soldiers assume MOPP 3.
    - d. Ensure the soldiers assume MOPP 4.
  2. Check yourself and soldiers for proper wear of protective clothing.
    - a. Ensure all soldiers are wearing the appropriate clothing and equipment for the directed MOPP level.
    - b. Ensure protective masks are worn and sealed at MOPP 3 and MOPP 4.
    - c. Ensure protective clothing is worn properly.
  3. Check each sleeping soldier.
    - a. Observe soldier to ensure he is breathing.
      - (1) Try to awaken him, if he does not appear to be breathing,
      - (2) If the soldier cannot be awakened, perform task 081-831-1000, STP 21-1 SMCT.
    - b. Check soldier's mask for indicators of a broken seal.
      - (1) Awaken the soldier and have him reseal his mask, if the seal appears to be broken.
      - (2) Direct another soldier to observe him for nerve agent poisoning.
      - (3) Perform task 081-831-1044, STP 21-1-SMCT, if symptoms are observed.
    - c. Check soldier's protective clothing for problems.
      - (1) Fasten or adjust the protective clothing of the sleeping soldier if his skin is not exposed and no symptoms are observed.
      - (2) Awaken soldier and have him decontaminate using the M291, if his skin is exposed and appears to be contaminated with liquid. Have soldier adjust his protective clothing or conduct MOPP gear exchange, as appropriate.
      - (3) Perform task 081-831-1044, STP 21-1 SMCT, if skin is exposed and nerve agent symptoms are observed.
-

Skill Level 2

**Evaluation Preparation:**

*Setup:* Evaluate this task during a normal training session. Gather all necessary MOPP gear, and ensure that it is in good condition. Be prepared to direct a series of specific MOPP levels for the evaluated soldier to implement with the troops provided (such as MOPP 0 through 4 sequentially). Have the soldier explain the deficiencies he should look for and the corrective actions he should take for a soldier sleeping in MOPP 4.

*Brief Soldier:* Tell the soldier that the test will consist of identifying all deficiencies and taking appropriate corrective actions for a soldier sleeping in MOPP 4 and directing soldiers to assume the appropriate MOPP level based on the MOPP guidance from the commander.

Performance Measures	GO	NO GO
1. Directed soldiers to put on MOPP gear and equipment to assume MOPP 1 through 4.	___	___
2. Checked self and soldiers for proper wear of protective clothing.	___	___
3. Checked the sleeping soldier.	___	___

**Evaluation Guidance:** Score the soldier GO if all performance measures are passed. Score the soldier NO GO if any performance measure is failed. If the soldier fails, show him how to do it correctly.

**References**

**Required**

- FM 4-25.11
- FM 3-4
- TM 3-4240-279-10
- TM 10-8415-209-10

**Related**

---

**031-503-3010**

**Supervise the Employment of Nuclear, Biological, and Chemical Markers**

**Conditions:** You are in a tactical environment where NBC weapons have been used. The contamination has been located and identified in an area. You and your unit are at the appropriate mission-oriented protective posture (MOPP) level. You have NBC markers and a grease pencil or an NBC contamination marking set.

**Standards:** Supervised the employment of NBC markers. Ensured that the appropriate marker was selected, the required information was recorded on

the marker, and the marker was properly emplaced. There is no change in standards if this task is performed in MOPP 4.

Skill Level 2

---

**Performance Steps**

---

1. Supervise the employment of NBC markers for nuclear contamination.
    - a. Ensure that markers are placed at the location where a dose rate of one centigray per hour (cGy/hr) or more was measured.
    - b. Ensure that all information is printed on the front side of the marker so the word "ATOM" is facing toward you in an upright position. Information should include—
      - (1) The dose rate in cGy/hr.
      - (2) The date and time (local or Zulu, state which) of the detonation. (If the date and time are not known, print "UNKNOWN.")
      - (3) The date and time (local or Zulu, state which) of the reading.
    - c. Ensure that markers are positioned so they can be easily seen and the recorded information faces away from the area of contamination.
      - (1) Ensure that markers are attached to objects, such as trees or poles, so they will be easily visible from all probable routes through the contaminated area.
      - (2) Ensure that each marker is placed so the next one can be seen from the one previously emplaced.
  2. Supervise the employment of NBC markers for biological contamination.
    - a. Ensure that all information is printed on the front side of the marker so the word "BIO" is facing toward you in an upright position. Information should include—
      - (1) The type of agent detected. If unknown, print the word "UNKNOWN."
      - (2) The date and time (local or Zulu, state which) of detonation (place beneath the date of detection).
    - b. Ensure that markers are positioned so they can be easily seen and the recorded information faces away from the area of contamination.
      - (1) Ensure that markers are attached to objects (such as trees or poles) so they will be easily visible from all probable routes through the contaminated area.
      - (2) Ensure that each marker is placed so the next one can be seen from the one previously emplaced.
  3. Supervise the employment of NBC markers for chemical contamination.
-

Skill Level 2

---

**Performance Steps**

---

a. Ensure that all information is printed on the front side of the marker so the word "GAS" is facing toward you in an upright position. Information should include—

(1) The type of agent detected. If unknown, print the word "UNKNOWN."

(2) The date and time (local or Zulu, state which) of detonation (place beneath the type of agent detected).

b. Ensure that markers are positioned so they can be easily seen and the recorded information faces away from the area of contamination.

(1) Ensure that markers are attached to objects, such as trees or poles, so they will be easily visible from all probable routes through the contaminated area.

(2) Ensure that each marker is placed so the next one can be seen from the one previously emplaced.

---

**Evaluation Preparation:**

*Setup:* Use simulated agents to produce a contaminated environment for chemical and biological (CB) agents. When requiring a marker for nuclear contamination, tell the soldier the amount of radiation present.

*Brief Soldier:* Tell the soldier that the test will consist of ensuring that NBC markers are properly emplaced and all information is printed on the markers.

Performance Measures	GO	NO GO
1. Supervised the employment of NBC markers for nuclear contamination.	—	—
2. Supervised the employment of NBC markers for biological contamination.	—	—
3. Supervised the employment of NBC markers for chemical contamination.	—	—

**Evaluation Guidance:** Score the soldier GO if all performance measures are passed. Score the soldier NO GO if any performance measure is failed. If the soldier fails, show him how to do it correctly.

**References****Required**

FM 3-3

TM 3-9905-001-10

**Related**

**031-503-4002****Supervise Unit Preparation for a Nuclear, Biological, and Chemical Attack**

**Conditions:** You are given commander's guidance, a radio, pioneer tools (ax, shovel, mattock), chemical alarms, chemical agent detector kits, covering materials (plastic sheets, ponchos, or tarpaulins), and soldiers who have their mission-oriented protective posture (MOPP) gear.

**Standards:** Supervised unit preparation for a NBC attack. Prepared and protected materiel from becoming damaged, contaminated, or inoperable and unit personnel from becoming casualties. Standards are not degraded if performed in MOPP 4; however, because of the amount of physical work that must be done in this task, serious performance degradation may result if soldiers are in MOPP gear.

**Performance Steps**

1. Supervise unit preparation for a nuclear attack.
  - a. Individual protection.
    - (1) Ensure that personnel are sheltered in well-constructed fighting positions with overhead cover, bunkers, and/or armored vehicles.
    - (2) Ensure that personnel cover all exposed skin (roll sleeves down, button collars). A handkerchief or similar cloth may be worn over the nose and mouth to prevent inhalation of contaminated dust.
  - b. Position.
    - (1) Ensure that the terrain is used effectively to minimize the effects of an attack.
    - (2) Ensure that the type of available shelter selected (covered foxholes, field-expedient overhead cover, buildings, tents, and armored vehicles) provides the best protection from weapon effects.
  - c. Materiel.
    - (1) Ensure that supplies, equipment, and vehicles are dispersed and/or dug in as much as possible. Ensure that explosives, ammunition, and flammables (fuel and oil) have been dispersed and/or dug in. Cover them if possible.
    - (2) Ensure that existing cover provides protection and natural shielding for vehicles, supplies, and equipment from a nuclear explosion. Ensure that vans are parked so their air conditioner intakes are opposite the prevailing wind direction. Ensure that air conditioners are turned off and intakes are covered with nonporous materials (plastic sheets or ponchos).

---

**Performance Steps**

---

(3) Ensure that flammable debris is kept to a minimum. Ensure that small objects are secured to minimize the danger of casualties and damage from flying debris.

(4) Ensure that all food and water are tightly sealed in containers and secured under available cover.

(5) Ensure that all electronic equipment and radios are turned off, if not required for use.

(6) Ensure that power cables, antennas, and unused electronic equipment are disconnected and removed from power mounts.

(7) Ensure that communications and electronics equipment are placed inside bunkers or armored vehicles to enhance protection against an electromagnetic pulse (EMP).

d. Unit. Ensure that NBC equipment operators prepare the equipment for use.

2. Supervise unit preparation for a biological attack.

a. Individual protection.

(1) Coordinate with medical personnel for needed immunizations.

(2) Ensure soldiers practice good hygiene and field sanitation procedures.

(3) Ensure soldiers are in good physical condition (well rested, well fed, and healthy).

(4) Ensure soldiers button clothing and cover exposed skin or wear the appropriate MOPP level.

(5) Ensure soldiers check protective masks and individual equipment for serviceability.

(6) Coordinate with supply personnel for needed parts and equipment.

b. Position.

(1) Ensure the terrain is used effectively to minimize the effects of an attack.

(2) Ensure the type of available shelter selected (covered foxholes, field-expedient overhead cover, buildings, tents, and armored vehicles) provides the best protection from weapon effects.

c. Materiel.

(1) Ensure all food and water are tightly sealed in containers and secured under available cover.

---

Skill Level 2

**Performance Steps**

(2) Ensure unused supplies and equipment are covered to avoid surface contamination from an aerial spray attack.

(3) Ensure vans are parked so their air conditioner intakes are opposite the prevailing wind direction. Ensure air conditioners are turned off and intakes are covered with nonporous materials (plastic sheets or ponchos).

3. Supervise unit preparation for a chemical attack.

a. Individual protection.

(1) Ensure soldiers are in good physical condition (well rested, well fed, and healthy).

(2) Ensure soldiers check protective equipment for serviceability and coordinate with supply personnel for replacement parts and equipment.

(3) Ensure the appropriate MOPP level is assumed.

(4) Ensure individuals seek available overhead cover or use ponchos, plastic sheets, tarpaulins, and so forth to cover their positions.

(5) Ensure antidotes and decontaminating kits are serviceable and readily available.

b. Position.

(1) Ensure the terrain is used effectively to minimize the effects of an attack.

(2) Ensure the type of available shelter selected (covered foxholes, field-expedient overhead cover, buildings, tents, and armored vehicles) provides the best protection from weapon effects.

c. Materiel.

(1) Ensure all equipment, supplies, and vehicles are dispersed as much as possible. Ensure that these items are covered with nonporous materials (plastic sheets or ponchos). As a last resort, use dense foliage.

(2) Ensure vans are parked so their air conditioner intakes are opposite the prevailing wind direction. Ensure that air conditioners are turned off and intakes are covered with nonporous materials (plastic sheets or ponchos).

(3) Ensure unpackaged food is in sealed containers. Ensure soldiers open food only when they are ready to eat it, keep water in sealed containers, and cover items if possible.

d. Unit. Ensure operators of NBC equipment prepare the equipment for use.

**Evaluation Preparation:**



**Setup:** To evaluate this task, choose a site that allows the dispersing and/or digging in of vehicles, supplies, and equipment. You may decide to quiz the soldier on performance measures that are difficult to evaluate otherwise, such as individual preparation for a biological attack.

**Brief Soldier:** Tell the soldier he will be evaluated on his ability to supervise unit preparations for an NBC attack.

Performance Measures	GO	NO GO
1. Supervised unit preparation for a nuclear attack.	___	___
2. Supervised unit preparation for a biological attack.	___	___
3. Supervised unit preparation for a chemical attack.	___	___



**Evaluation Guidance:** Score the soldier GO if all performance measures are passed. Score the soldier NO GO if any performance measure is failed. If the soldier fails any performance measure, show him how to do it correctly.

**References**

**Required**

**Related**

FM 3-4

---

**031-506-1053**

**Report Nuclear, Biological and Chemical Information Using NBC 4 Report**

**Conditions:** You are in a nuclear, biological, or chemical contaminated tactical environment. Given a watch, a map, a compass, a protractor, a pencil, paper and the NBC report format guide (GTA 03-06-008 or DA Form 1971-10-R, *NBC 4-Radiation Dose Rate Measurements/Chemical/Biological Areas of Contamination*).

**Standards:** Reported NBC information using the NBC report. Completed NBC 4 reports with all heading information and mandatory line items (Q, R, and S for nuclear or H, Q, and S for chemical or biological). Included all other appropriate data, and ensured that each report was in the correct format. Disseminated completed NBC 4 reports to the proper authority.

---

**Performance Steps**

**Note.** Go to step 1 if it is a nuclear report. Go to step 2 if it is a chemical and biological (CB) report. Treat depleted uranium (DU) the same as a nuclear hazard.

1. Prepare an NBC 4 nuclear report.

**Note.** The mandatory information in an NBC 4 nuclear report is the location of the reading (line Q), the dose rate (line R), and the date-time group (DTG) of the

---

**Performance Steps**

reading (line S).

**a.** Report the heading information for the NBC 4 nuclear report.

- (1) FROM: Enter your unit identification.
- (2) TO: Enter the unit identification you are calling.
- (3) PRECEDENCE: Use "IMMEDIATE."
- (4) CLASSIFICATION: Usually sent unclassified.
- (5) DATE-TIME: Use eight digits (DDHHMM—two digits for the day, four digits to represent military time) plus "Zulu" or "LOCAL."
- (6) TYPE OF REPORT: Enter "NUCLEAR."
- (7) CATEGORY OF REPORT: Enter "INITIAL" if this is the first report on this attack you will submit; otherwise, enter "FOLLOW-UP."

**b.** Turn DA Form 1971-10-R to the reverse side.

- (1) Line A: Enter the strike serial number.
- (2) Line Q: Enter grid coordinates of the location of the reading (grid coordinates or place name, state actual or estimated).
- (3) Line R: Enter the dose rate in centigray per hour (cGy/hr).
- (4) Line S: Enter the DTG of the reading.

**Note.** The NBC 4 report can contain more than one reading. Repeat lines Q, R, and S, if necessary.

**c.** Go to step 4.

**2.** Prepare an NBC 4 CB report.

**Note.** The mandatory information in an NBC 4 CB report is the type of agent (line H), the location of the reading (line Q), and the DTG of the reading (line S).

**a.** Report the heading information for the NBC 4 CB report.

- (1) FROM: Enter your unit identification.
- (2) TO: Enter the unit identification you are calling.
- (3) PRECEDENCE: Use "IMMEDIATE."
- (4) CLASSIFICATION: Usually sent unclassified.
- (5) DATE-TIME: Use eight digits (DDHHMM—two digits for the day, four digits to represent military time) plus "Zulu" or "LOCAL."
- (6) TYPE OF REPORT: Enter "CHEMICAL" or "BIOLOGICAL."
- (7) CATEGORY OF REPORT: Enter "INITIAL" if this is the first report on this attack you will submit; otherwise, enter "FOLLOW-UP."

**b.** Use Section I on DA Form 1971-10-R.

- (1) Line A: Enter the strike serial number.

Skill Level 2

---

**Performance Steps**

---

- (2) Line H: Enter the type of agent.
  - (3) Line Q: Enter grid coordinates of the location of the reading (grid coordinates or place name, state actual or estimated).
  - (4) Line S: Enter the DTG of the reading.
- Note.** The NBC 4 report can contain more than one reading. Repeat lines Q, R, and S if necessary.
- c. Go to step 4.
3. Submit the completed NBC 4 report using any means possible.
- 

**Evaluation Preparation:**

*Setup:* Gather the items provided in the conditions statement. Develop a situation containing observer data. The information may be written and given to the soldier. Develop a different situation for each type of report.

*Brief Soldier:* Tell the soldier that the test will consist of preparing and submitting NBC 4 reports. Give him the necessary items, including the data you developed. Tell the individual to prepare and submit NBC 4 reports.

Performance Measures	GO	NO GO
1. Prepared an NBC 4 nuclear report.	___	___
2. Prepared an NBC 4 CB report.	___	___
3. Submitted the completed NBC report.	___	___

**Evaluation Guidance:** Score the soldier GO if all performance measures are passed. Score the soldier NO GO if any performance measure is failed. If the soldier fails any performance measure, show him how to do it correctly.

**References**

Required	Related
DA Form 1971-10-R	FM 3-3
GTA 03-06-008	FM 3-3-1

---

**031-506-2061****Conduct a Mask Fit Test**

**Conditions:** Given an M41 Protection Assessment Test System (PATS); M17-, M40-, M42- and M45- series protective masks; PATS operator manual; TC 3-41; and any of the following situations:

- 1. You are directed by the commander to conduct a mask fit test.

2. You have a soldier(s) who requires an initial issue, an annual verification, or a replacement mask issue.

3. This task will NOT be performed in MOPP 4.

**Standards:** Conducted a mask fit test. Performed all the steps in sequence to verify the fit of a protective mask to an individual's face.

---

**Performance Steps**

---

1. Prepare the mask for the fit test (M40-, M42-, and M45-series).

a. Attach the drink tube sampling adapter to the drink tube quick-disconnect coupling.

b. Have the soldier sit down for the fit test.

c. Have the soldier don the mask.

d. Instruct the soldier to blow as hard as possible several times into the internal drink tube mouthpiece to remove any trapped fluids or foreign matter. Ensure that the drink tube is clear so foreign matter will not be drawn into the protection assessment test instrument (PATI) and the PATI will be able to draw air from inside the mask.

**Note.** THIS IS A CRITICAL STEP.

e. Have the soldier adjust the face piece and tighten the head harness. Ensure that the face piece is properly fitted.

2. Prepare the mask for the fit test (M17-series).

a. Attach the drink tube sampling adapter to the drink tube quick-disconnect coupling.

b. Attach the drink valve retaining lever to hold the drink valve open.

c. Have the soldier sit down for the fit test.

d. Have the soldier don the mask.

e. Instruct the soldier to blow as hard as possible several times into the internal drink tube mouthpiece to remove any trapped fluids or foreign matter. Ensure that the drink tube is clear so foreign matter will not be drawn into the PATI and the PATI will be able to draw air from inside the mask.

**Note.** THIS IS A CRITICAL STEP.

f. Have the soldier remove the mask. Insert the sample tube extension into the internal drinking tube mouthpiece.

g. Remove the drink valve retaining lever from the drink valve lever.

---

---

## Performance Steps

---

### WARNING

Have the soldier close his eyes while putting the mask on to prevent the sample extension tube from touching and possibly injuring his eyes.

- h. Instruct the soldier to don the mask. Ensure that the sample extension tube is properly positioned.
  - i. Adjust the face piece, and tighten the head harness. Ensure that the face piece is properly fitted.
  - j. Attach the drink valve retaining lever so the drink valve is held in the open position for the duration of the fit test.
3. Conduct a mask fit test (M17-, M40-, M42-, and M45-series). (See the PATS operator's manual.)

**Note.** It is important that smoking not be permitted in the immediate area where the fit test is being conducted. The soldier should not smoke for at least 30 minutes before the test. To achieve proper results, the soldier should not talk during the test.

- a. Remove the high-efficiency particulate air (HEPA) filter from the twin tube assembly.
  - b. Attach the twin sample tube (marked "SAMPLE") to the sample port on the end of the drink tube sampling adapter.
  - c. Monitor the reading on the display with the PATI in the count mode and have the soldier remain still until an acceptable reading of 3.0 particles/cubic centimeters or lower is obtained.
  - d. Press the FIT TEST key on the keypad after obtaining an acceptable seal to bring the instrument into the standby fit test mode.
- Note.** Before continuing to the next step, brief the soldier on how to perform the exercises outlined in the operator's manual. The soldier should be instructed to breathe normally during all exercises except the deep breathing exercise.
- e. Verify the number of exercises is set to S by pressing the NUMBER OF EXERCISES key.
  - f. Press the START/STOP TEST key to begin the fit test. Instruct the soldier to perform the first exercise.
  - g. Have the soldier remove his mask after the test is complete, and PASS is indicated.
  - h. Remove all testing attachments from the soldier's mask.
  - i. Repeat the test if FAIL is indicated. (Repeat steps 3f and 3g.)

---

## Evaluation Preparation:

---

**Setup:** Ensure that the items required in the conditions section are available to the soldier. A soldier with a mask must be available.

**Brief Soldier:** Tell the soldier to conduct the mask fit test based on the type of protective mask issued.

**Note.** Performance measures will vary depending on type of mask being fitted (M17-, M40-, M42-, or M45-series).

Performance Measures	GO	NO GO
1. Prepared the mask for the fit test (M40-, M42-, and M45-series).	___	___
2. Prepared the mask for the fit test (M17-series).	___	___
3. Conducted a mask fit test (M17-, M40-, M42-, and M45-series).	___	___

**Evaluation Guidance:** Score the soldier GO if all performance measures are passed. Score the soldier NO GO if any performance measure is failed. If the soldier fails any performance measure show him how to do it correctly.

#### References

##### Required

TC 3-41

##### Related

TM 3-4240-279-10

TM 3-4240-279-20&P

### SUBJECT AREA 4: SURVIVE (COMBAT TECHNIQUES)

## 061-283-6003

### Adjust Indirect Fire

**Conditions:** Given a pair of binoculars, a radio, a compass, pencils, a coordinate scale, a map of the target area, a target to engage within the area, and grid location of friendly troops.

**Standards:** Determined the target location to within 250 meters of its actual location. The initial call for fire was made within 3 minutes after the target was identified. Adjustments were sent within 45 seconds after each round impacted. Observer entered the fire-for-effect phase using no more than six rounds (initial round plus five for adjustment). Fire for effect was within 50 meters of the target using successive bracketing procedures (or creeping fire if danger close).

#### Performance Steps

1. Locate the target within 250 meters of the actual target location.

**Performance Steps**

- a. Locate the target by grid coordinates .
- b. Determine the direction from your position to the target.
- c. Formulate a call for fire. Include the elements of the call for fire in sequence.
  - (1) Observer identification (your call sign).
  - (2) Warning order (adjust fire).
  - (3) Location of target.
  - (4) Description of the target (for example "INFANTRY PLATOON IN THE OPEN").
  - (5) Method of engagement (may be omitted if area fire is desired).
    - (a) If the target is within 600 meters of friendly troops, announce "DANGER CLOSE" to the fire direction center (FDC) in the initial call for fire, in the method of engagement phase.
    - (b) Use creeping procedures to adjust danger close fire. Range corrections should NOT exceed 100 meters.
    - (c) Initial target location is reported on the enemy side of the target.
  - (6) Method of fire control.

**Note.** The request for a fire mission would be similar to figure 061-283-6003-1.

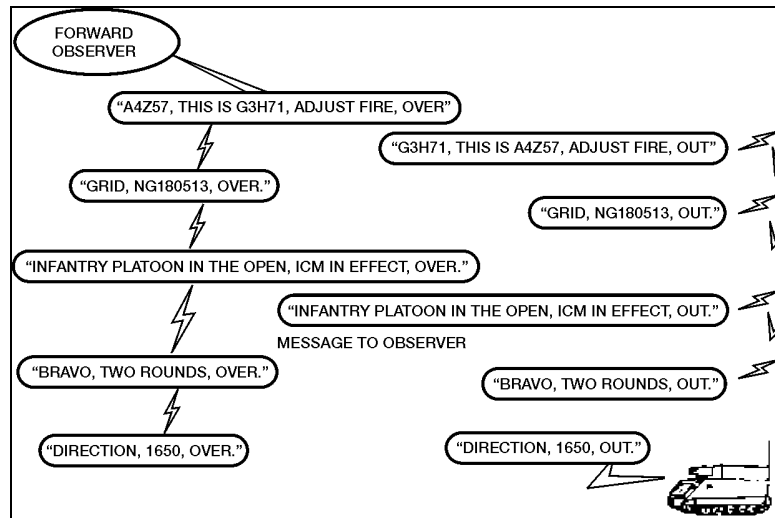

**Figure 061-283-6003-1. Initial Fire Request**

**Performance Steps**

2. Transmit the call for fire to the FDC within three minutes of target identification.

a. Conduct three transmissions.

(1) Send observer identification and warning order. Example: "A4Z57, THIS IS G3H71, ADJUST FIRE, OVER."

(2) Send target location. Example: "GRID NG180513, OVER."  
(Give the six-digit grid of the target, with the grid zone identifier, to within 250 meters of the actual target location.)

(3) Send target description, method of engagement, method of fire and control. Example: "INFANTRY IN THE OPEN, ICMIN EFFECT, OVER."

b. Give the direction to the target within 100 mils (M2 compass) or five degrees (lensatic compass) or give an accurate cardinal direction (no compass available) of the actual target location. This should be sent before the first correction, or with the first correction.

3. Adjust rounds to within 50 meters of the target, within 45 seconds of the impact of each adjusting round.

a. Spot each round when it impacts as right or left, over or short of your target.

b. Determine corrections for deviation left or right of the target.

**Note.** Measure deviation. Measure the horizontal angle in mils, using the reticle pattern in the binoculars or hand measurement of angular deviation. Estimate the range to the target and divide by 1,000. This is the observer-target (OT) factor. If the OT distance is 1,000 meters or greater, the OT factor is expressed to the nearest whole number. If the OT distance is less than 1,000 meters, the OT factor is expressed to the nearest 1/10th. For example, 800 = 0.8. Multiplying the OT factor by the deviation measured in mils produces deviation corrections in meters.

c. When the first range spotting is observed, make a range correction that would result in a range spotting in the opposite direction. For example, if the first round is short, add enough to get an over on the next round. This is called successive bracketing (figure 061-283-6003-2). Figure 061-283-6003-3 shows the impact of the initial round. The target is 2100 meters away. Since the round is beyond the target, you must drop. You estimate that the round is 250 meters beyond the target. Therefore, you must drop 400 meters to start successive bracketing procedures. The round impacted 50 mils left of the target. With an OT factor of 2, the round impacted 100 meters left. Your correction to the FDC is "RIGHT 100—DROP 400—OVER."



**Performance Steps**

**WARNING**

DO NOT BRACKET when DANGER CLOSE, it could result in friendly casualties, use the creeping fire procedure (all corrections are 100 meters or less).

Skill Level 2

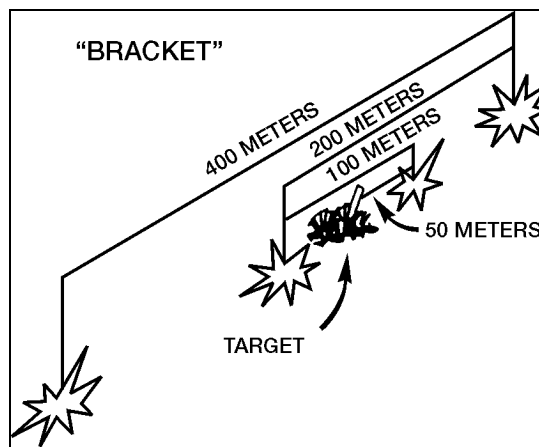

Figure 061-283-6003-2. Successive Bracketing

## Performance Steps

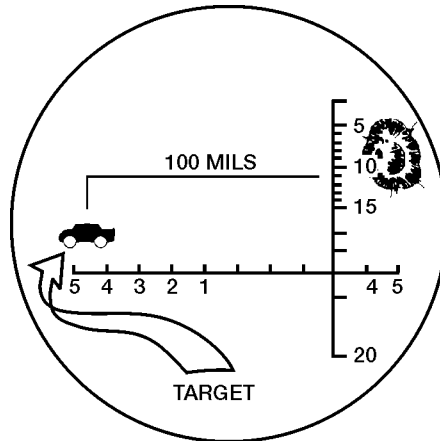

Figure 061-283-6003-3. Impact of Initial Round

d. Continue splitting the range bracket until a 100-meter bracket is split or range correct spotting is observed, maintaining deviation on line. (Figure 061-283-6003-4 and 061-283-6003-5 show the next adjustments).

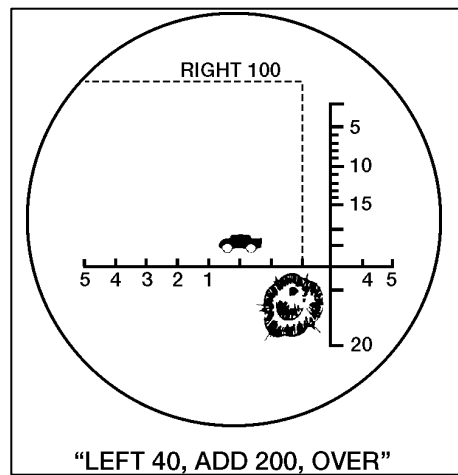
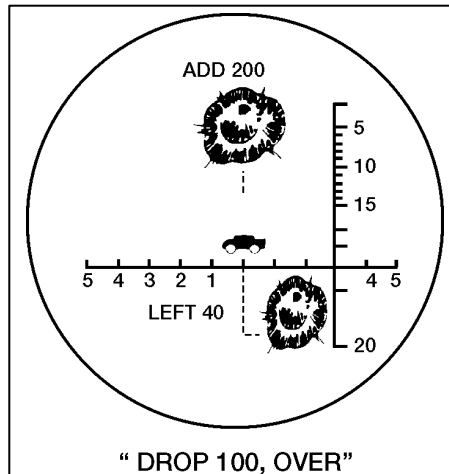

Figure 061-283-6003-4. Second Round

**Performance Steps**



**Figure 061-283-6003-5. Third Round**

**Skill Level 2**

### Performance Steps

e. Transmit corrections to the FDC in meters. The initial correction should bracket the target in range. The adjustment phase of a fire mission would resemble the example shown in figure 061-283-6003-6. Deviation correction should be made to keep the rounds on the observer target line.

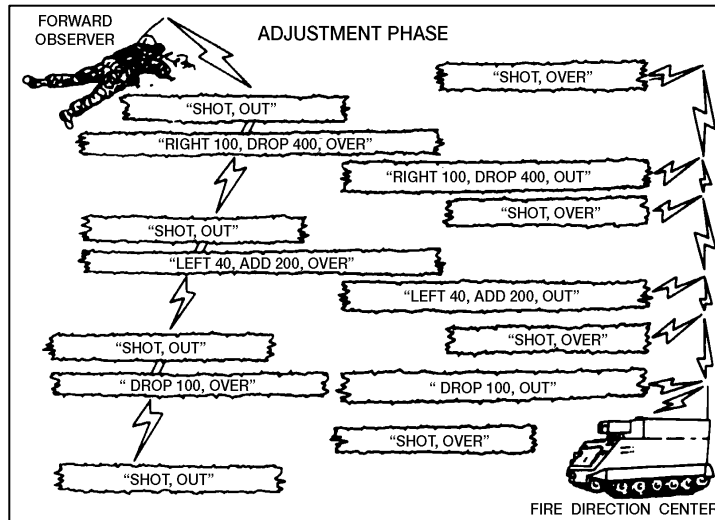

Figure 061-283-6003-6. Adjustment Phase

f. Use the following guide to establish a bracket. When the estimated round impact distance to the target is—

- (1) More than 400 meters, add or drop 800 meters.
- (2) More than 200 but less than 400 meters, add or drop 400 meters.
- (3) More than 100 but less than 200 meters, add or drop 200 meters.
- (4) Less than 100 meters, add or drop 100 meters.
- (5) Add or drop 50 meters and announce fire for effect.

4. Initiate fire for effect. When a 100-meter bracket is split or a range correct spotting is made, the fire-for-effect phase is entered (figure 061-283-6003-7). Figure 061-283-6003-8 shows a simulated pattern that might be observed in the fire-for-effect phase and the observed results of fire for effect are reported.

**Performance Steps**

**Skill Level 2**

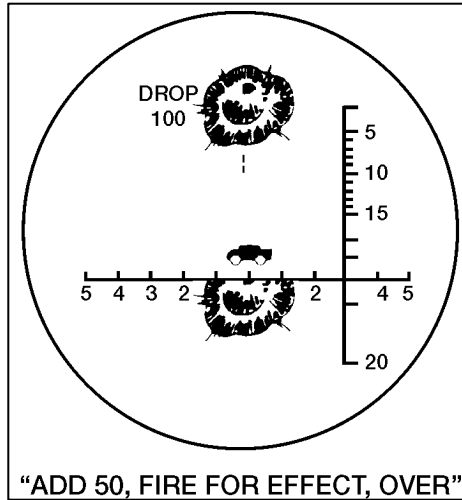

**Figure 061-283-6003-7. Fourth Round**

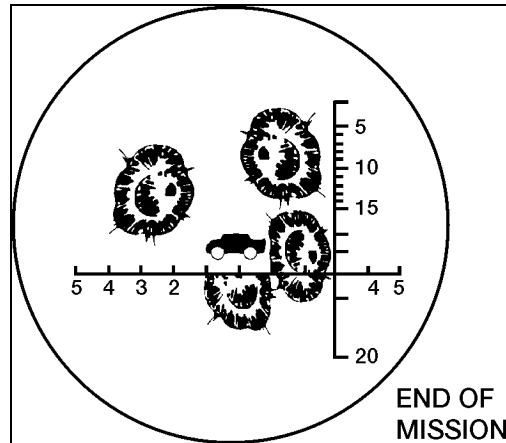

**Figure 061-283-6003-8. Fire for Effect Pattern**

5. Observe the results of fire for effect, transmit refinements (if necessary), and provide end of mission and surveillance (figure 061-283-6003-9).
  - a. Determine the effects on the target.

### Performance Steps

b. Give a brief description of what happened to the target. Example: "EOM, TARGET DESTROYED, ESTIMATE TWO CASUALTIES, OVER."

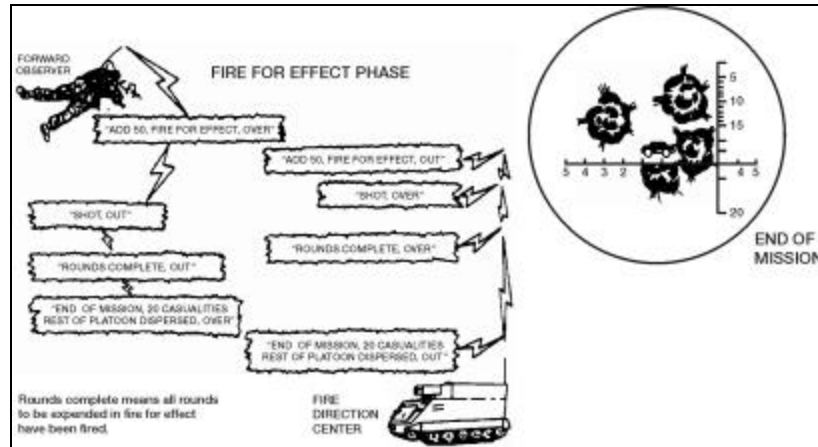

Figure 061-283-6003-9. End of Mission

### Evaluation Preparation:

**Setup:** Ensure that a target is readily identifiable to the soldier and the required equipment is present and operational. The evaluator must know the grid location, direction, and distance to the target that will be used.

**Brief Soldier:** Identify the target to the soldier. Tell the soldier he must enter the fire-for-effect phase using no more than six rounds (initial round plus five for adjustment). Fire for effect must be within 50 meters of the target, using successive bracketing procedures. The initial call for fire must be made within 3 minutes after the target has been identified. Adjustments must be sent within 45 seconds after each round impacts.

**Note.** Ensure that the soldier understands exactly what is expected of him, but do not help him in any way.

Performance Measures	GO	NO GO
1. Located the target to within 250 meters of the actual target location.	___	___
2. Transmitted the call for fire to the FDC within three minutes of target identification.	___	___
3. Adjusted rounds to within 50 meters of the target, within 45 seconds of the impact of each adjusting round.	___	___

Performance Measures	GO	NO GO
4. Entered the fire for effect phase when a 100-meter bracket was split, or when a range correct spotting was obtained.	—	—
5. Observed the results of fire for effect, transmitted refinements (if necessary), and provided end of mission and surveillance.	—	—

Skill Level 2

**Evaluation Guidance:** Score the soldier GO if all performance measures are passed. Score the soldier NO GO if any performance measure is failed. If the soldier fails any performance measure, show what was done wrong and how to do it correctly.

**References**

**Required**  
FM 3-90.30

**Related**

---

**071-326-0608**

**Use Visual Signaling Techniques**

**Conditions:** Given a requirement to use visual signals while mounted.

**Standards:** Gave the proper procedures for each required action.

---

**Performance Steps**

1. Ensure the soldiers you are signaling can see you.
2. Perform the visual signals for combat formations, battle drills, and movement techniques as outlined below:
  - a. Perform formation signals coil and herringbone (figures 071-326-0608-1 and 071-326-0608-2).

## Performance Steps

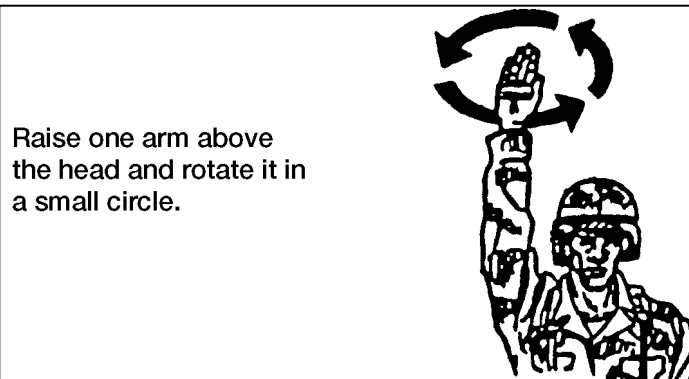

Figure 071-326-0608-1. Coil

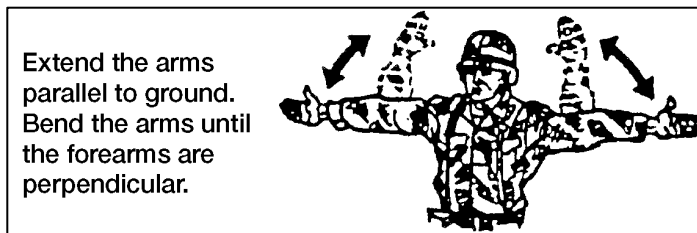

Figure 071-326-0608-2. Herringbone

b. Perform following drill signals: Contact left, contact right, action right, action left, action front (right, left, or rear), air attack, and nuclear, biological, or chemical attack (figures 071-326-0608-3 through 071-326-0608-9).

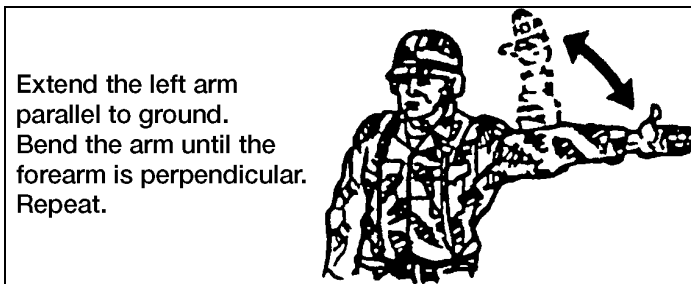

Figure 071-326-0608-3. Contact Left



---

**Performance Steps**

---

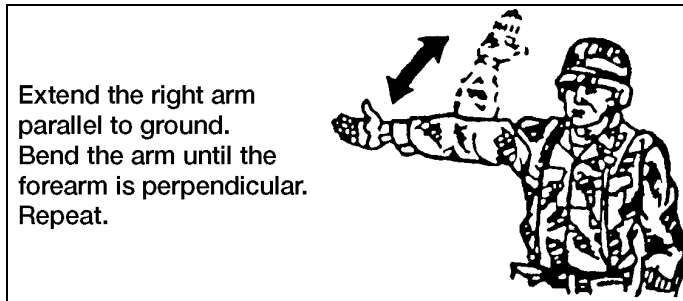

Figure 071-326-0608-4. Contact Right

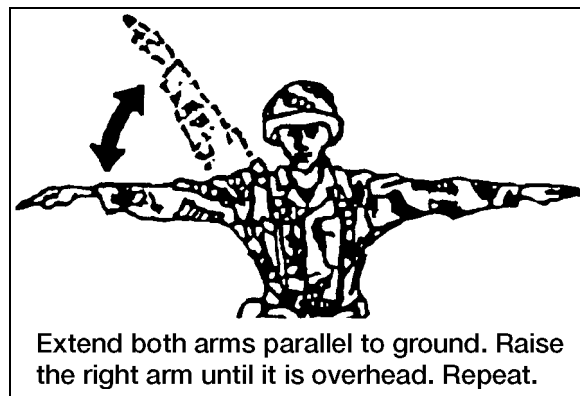
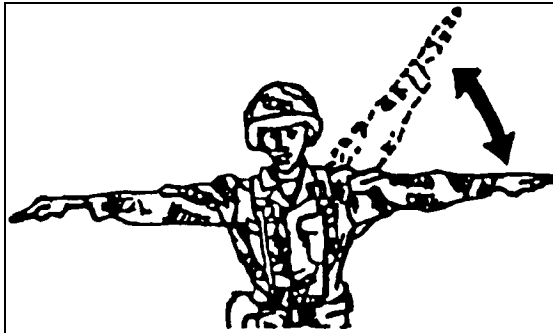

Figure 071-326-0608-5. Action Left

Skill Level 2

Performance Steps



Extend both arms parallel to ground. Raise the left arm until it is overhead. Repeat.

Figure 071-326-0608-6. Action Right

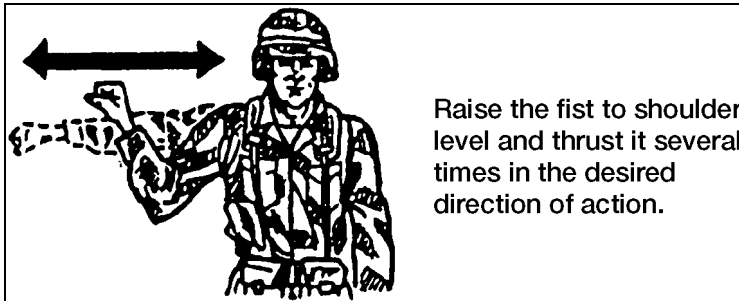

Raise the fist to shoulder level and thrust it several times in the desired direction of action.

Figure 071-326-0608-7. Action Front (Right, Left, or Rear), Fight on Foot, or Assault Fire (Dismounted Troops)

---

**Performance Steps**

---

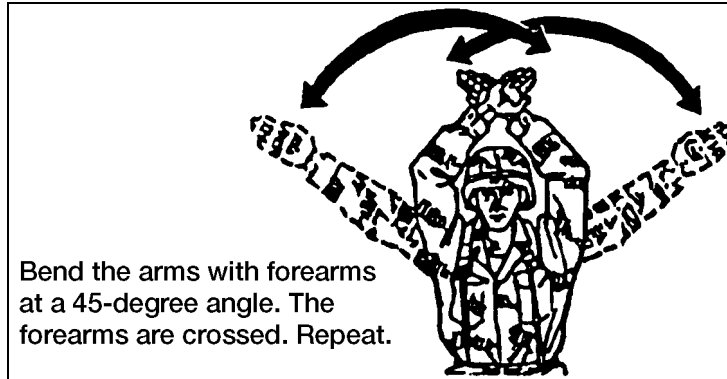

Figure 071-326-0608-8. Air Attack

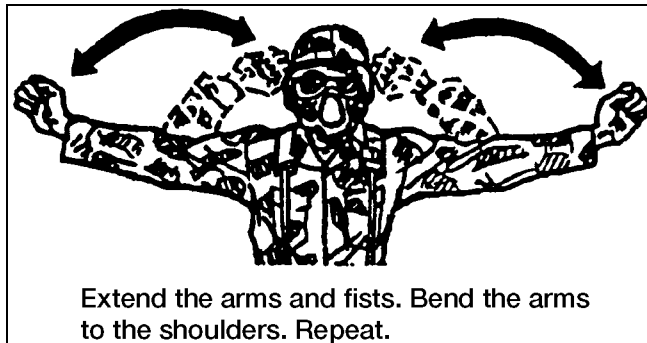

Figure 071-326-0608-9. Nuclear, Biological, Chemical Attack.

c. Perform movement technique signals: Traveling, traveling overwatch, and bounding overwatch (figures 071-326-0608-10 through 071-326-0608-12).

---

Skill Level 2

Performance Steps

Extend the arm overhead and swing it in a circle from the shoulder.



Figure 071-326-0608-10. Traveling

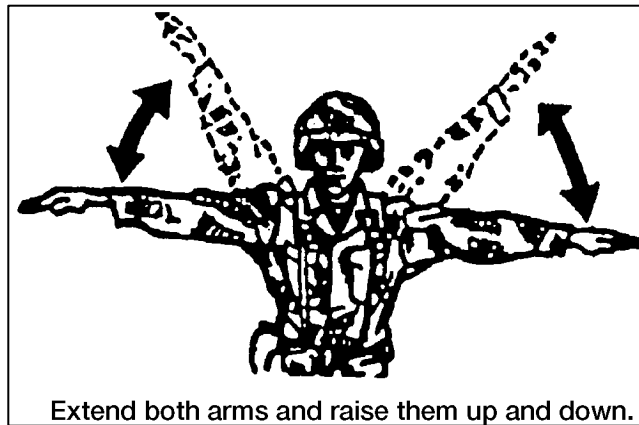

Extend both arms and raise them up and down.

Figure 071-326-0608-11. Traveling Overwatch

**Performance Steps**

Skill Level 2

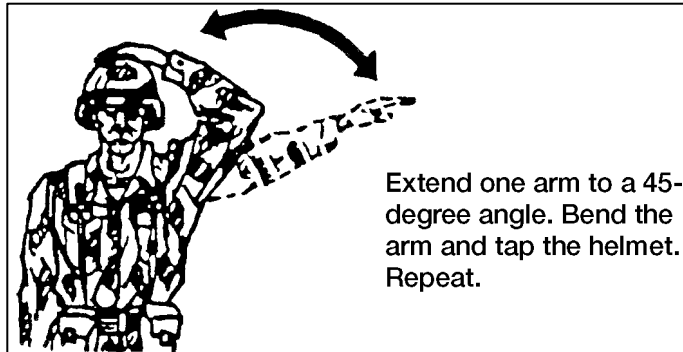

**Figure 071-326-0608-12. Bounding Overwatch, Cover My Move**

d. Perform vehicle signals: Move to the left, move to the right, move forward, attention, I am ready, or ready to move, are you ready, mount, disregard previous command, I do not understand, start engine or prepare to move, halt or stop, increase speed, advance, open up, close up, right or left turn, slow down, move in reverse, close distance between vehicles and stop, stop engines, dismount, neutral steer, stop, button up or unbutton, and message acknowledged (figures 071-326-0608-13 through 071-326-0608-36).

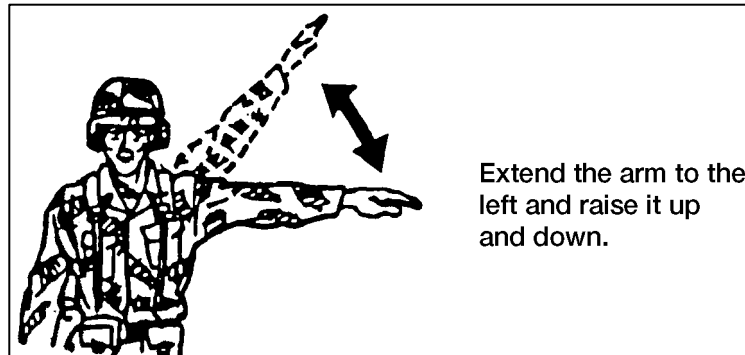

**Figure 071-326-0608-13. Move to Left**

Performance Steps

Extend the arm to the right and raise it up and down.

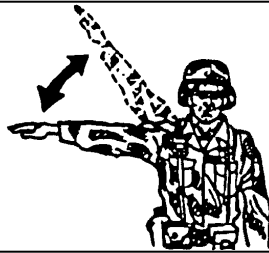

Figure 071-326-0608-14. Move to Right

Move the hands and forearms backward and forward, palms toward the chest.



Figure 071-326-0608-15. Move Forward

---

**Performance Steps**

---

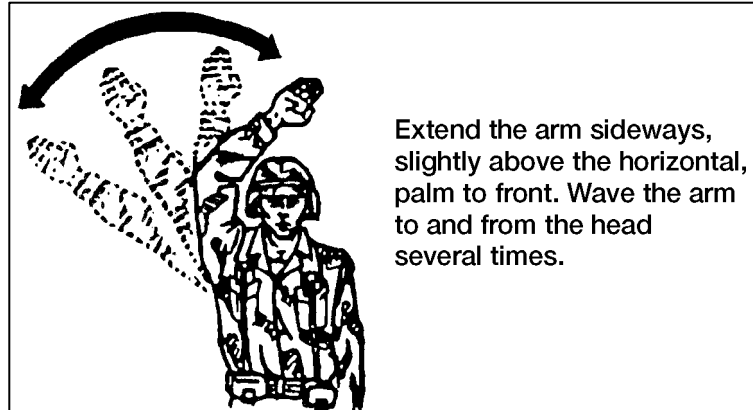

Figure 071-326-0608-16. Attention

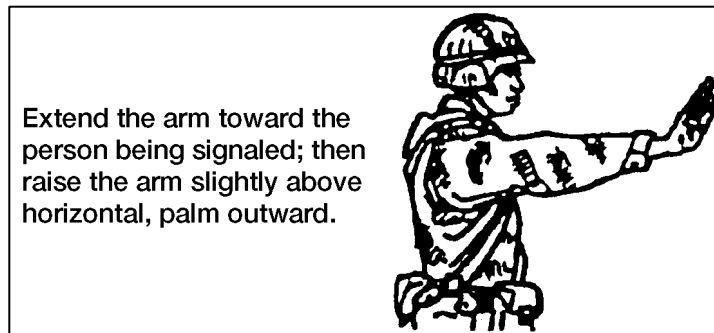

Figure 071-326-0608-17. I Am Ready, or Ready to Move, Are You Ready?

Skill Level 2

Performance Steps

Make two or three movements upward with the open hand, palm up.



Figure 071-326-0608-18. Mount

Raise both arms and cross wrists above the head, palms to the front.



Figure 071-326-0608-19. Disregard Previous Command or As You Were



**Performance Steps**

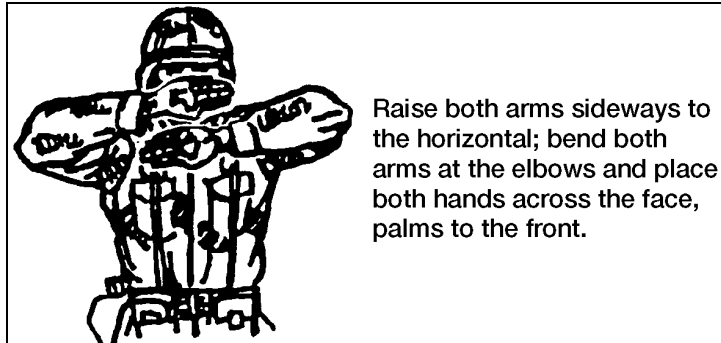

Figure 071-326-0608-20. I Do Not Understand

Skill Level 2

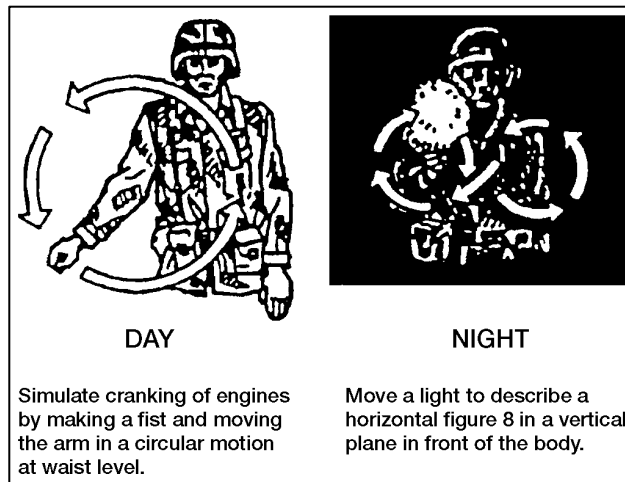

Figure 071-326-0608-21. Start Engine, or Prepare to Move

## Performance Steps



DAY

Raise the hand upward to the full extent of the arm, palm to the front. Hold that position until the signal is understood.

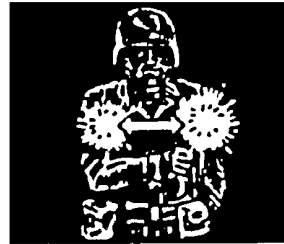

NIGHT

Move a light horizontally back and forth several times across the path of approaching traffic to stop vehicles. Use the same signal to stop engines.

Figure 071-326-0608-22. Halt, or Stop

**Note.** For alternate signal to stop vehicles, see figure 071-326-0608-34.



DAY

Raise the fist to shoulder level; thrust the fist upward to the full extent of the arm and back to shoulder level rapidly several times.

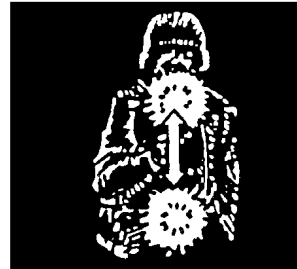

NIGHT

Move a light vertically several times in front of the body.

Figure 071-326-0608-23. Increase Speed

**Performance Steps**

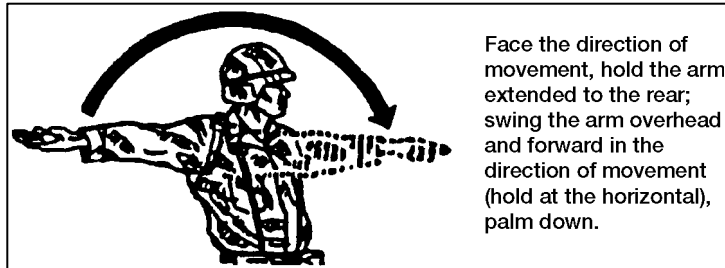

Figure 071-326-0608-24. Advance or Move Out

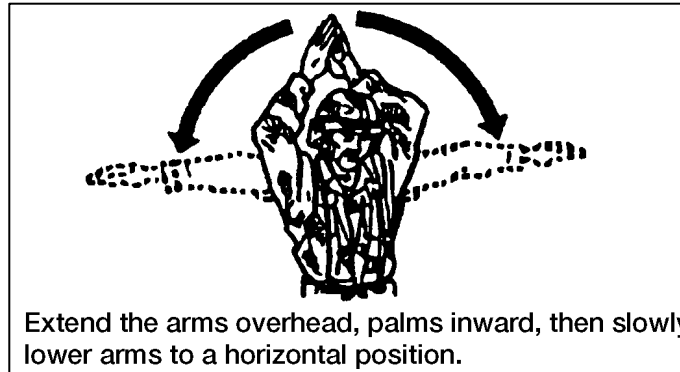

Figure 071-326-0608-25. Open Up

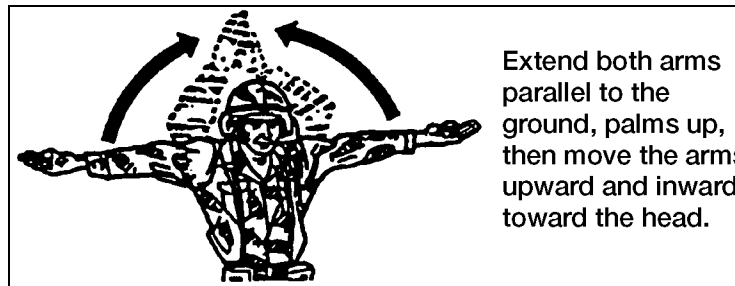

Figure 071-326-0608-26. Close Up

Skill Level 2

## Performance Steps

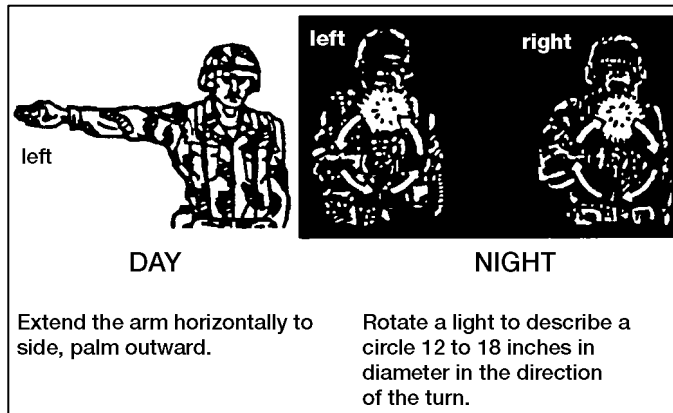

Figure 071-326-0608-27. Right or Left Turn

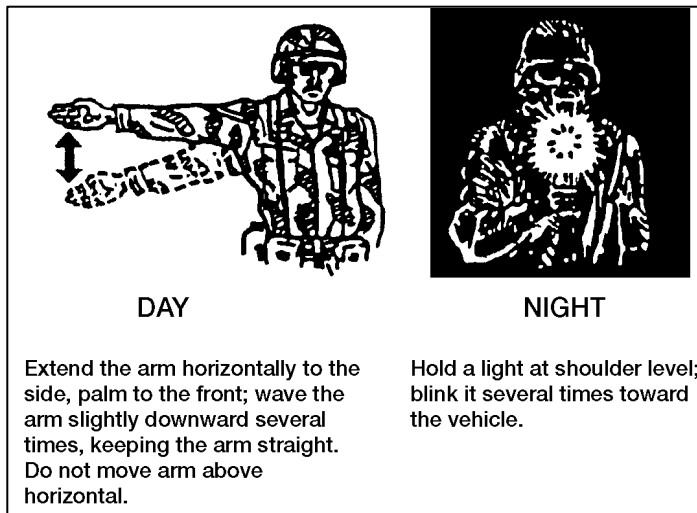
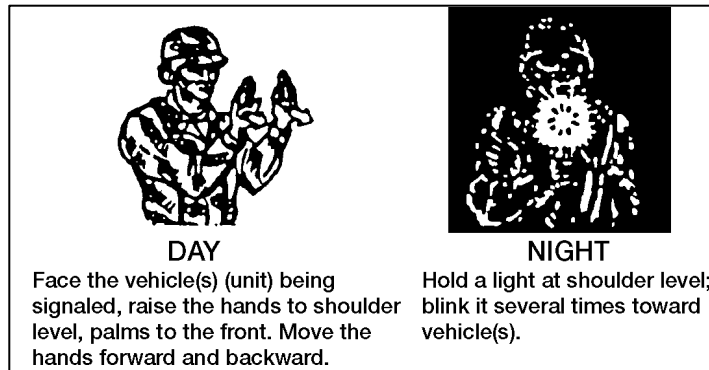
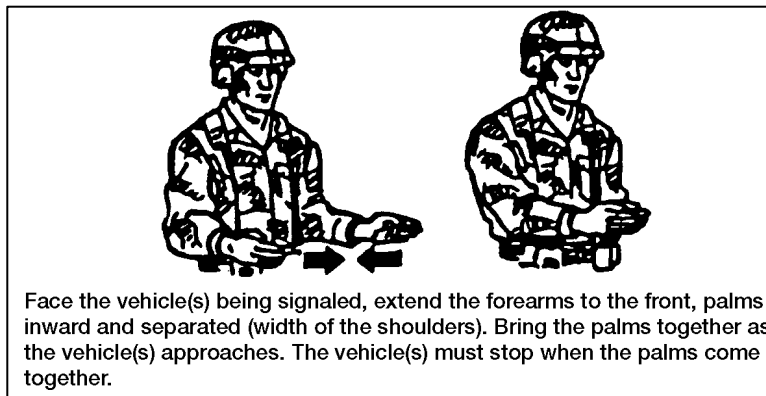

Figure 071-326-0608-28. Slow Down

**Performance Steps**



**Figure 071-326-0608-29. Move in Reverse (for Stationary Vehicles)**



**Figure 071-326-0608-30. Close Distance Between Vehicles and Stop**

Skill Level 2

Performance Steps

Extend the arm parallel to the ground, hand open, and move the arm across the body in a throat-cutting action.



Figure 071-326-0608-31. Stop Engines



Extend the arms, make two or three movements up and down, hands open toward ground.

Figure 071-326-0608-32. Dismount

**Performance Steps**

Skill Level 2

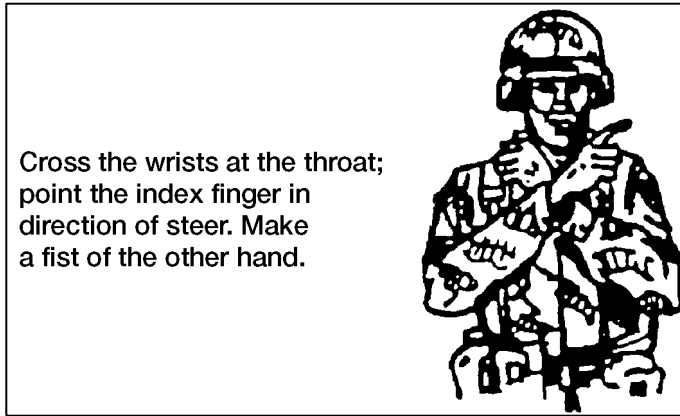

Figure 071-326-0608-33. Neutral Steer (Track Vehicles)

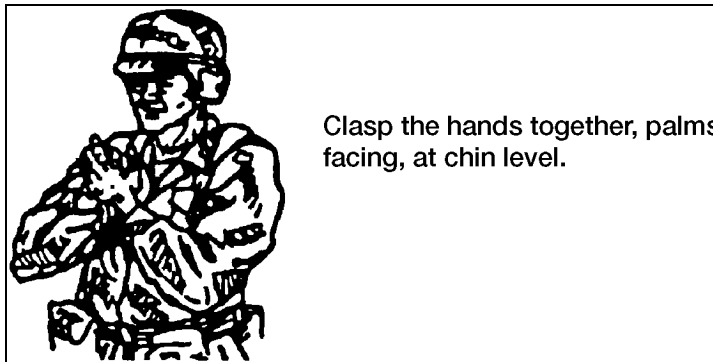

Figure 071-326-0608-34. Stop (Alternate Signal to Stop Track Vehicle)

**Note.** For an alternate signal to stop vehicles, see figure 071-326-0608-22.

## Performance Steps

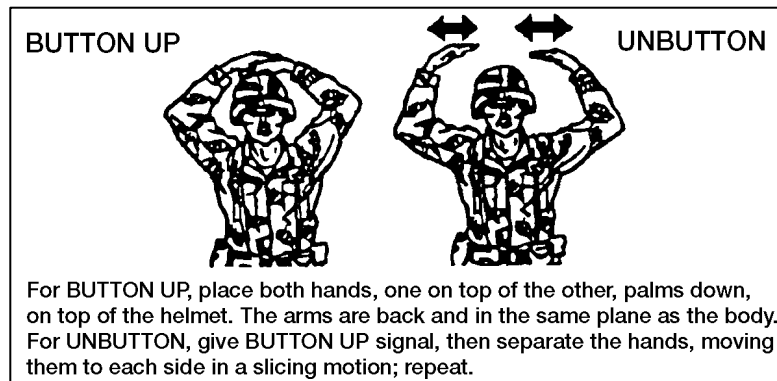

Figure 071-326-0608-35. Button Up or Unbutton

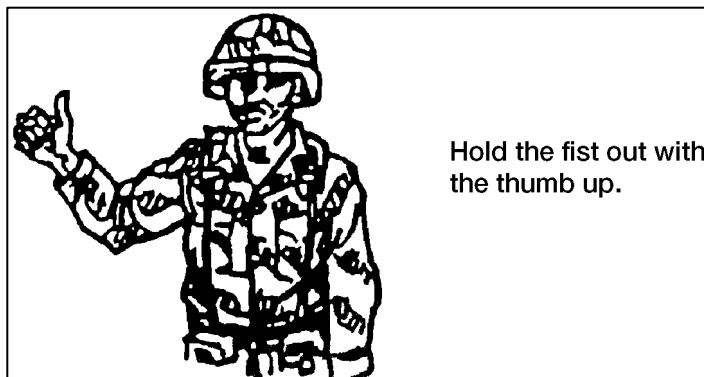

Figure 071-326-0608-36. Message Acknowledged

3. Perform flag signals: Single signal flag, mount, dismount, dismount and assault, assemble or close, move out and nuclear, biological or chemical hazard present (figures 071-326-0608-37 through 071-326-0608-43).

**Note.** When used alone, flag colors have the following meanings. Red—danger, or enemy in sight. Green—all clear, ready, or understood. Yellow—disregard, or vehicle out of action. During periods of poor visibility colored chemical lights or flashlights with colored filters may be substituted for flags.



Performance Steps

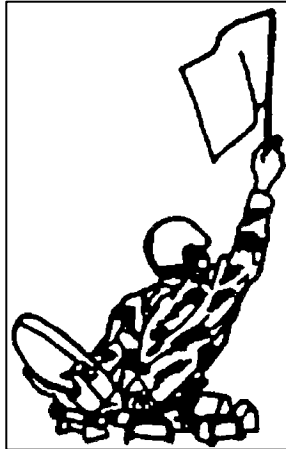

Figure 071-326-0608-37. Use a Single Signal Flag

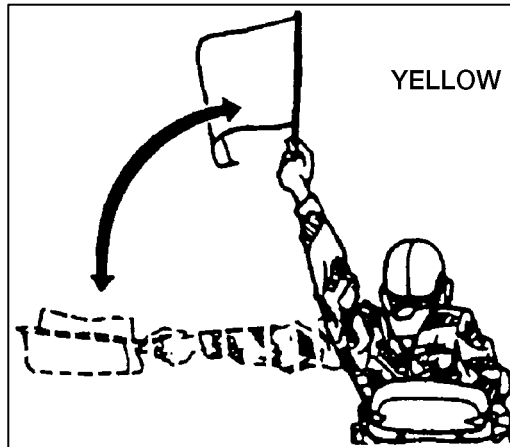

Figure 071-326-0608-38. Mount

Skill Level 2

Performance Steps

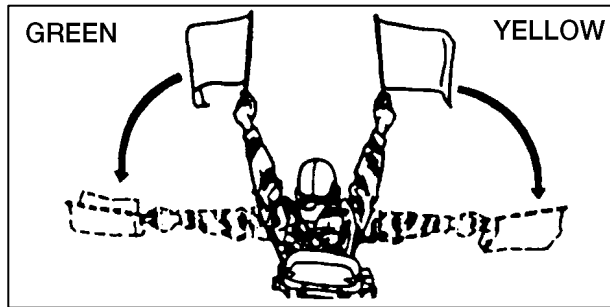

Figure 071-326-0608-39. Dismount

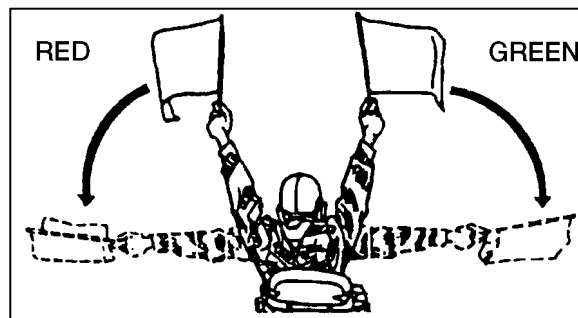

Figure 071-326-0608-40. Dismount and Assault

Performance Steps

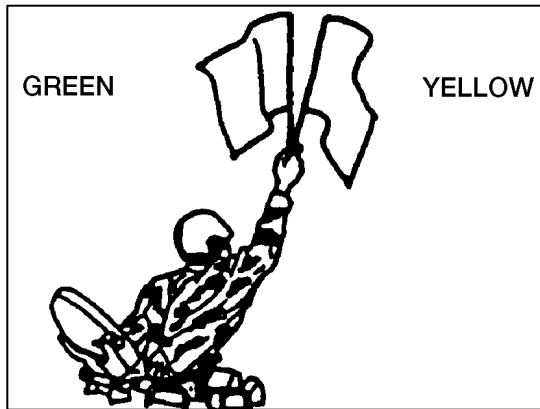

Figure 071-326-0608-41. Assemble or Close



Figure 071-326-0608-42. Move Out

Skill Level 2

Skill Level 2

**Performance Steps**

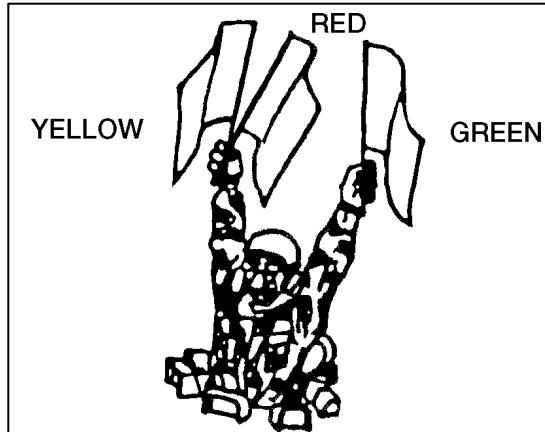

Figure 071-326-0608-43. Nuclear, Biological, Chemical Hazard Present

**Evaluation Preparation:**

*Setup:* At the test site, provide a set of vehicle signaling flags and flashlight. From the signals shown in the task, pick 10 to test.

*Brief Soldier:* Tell the soldier you will give the 10 signals and he must correctly execute each signal.

Performance Measures	GO	NO GO
1. Executed proper formation signals.	___	___
2. Executed proper drill signals.	___	___
3. Executed proper movement technique signals.	___	___
4. Executed proper signals to control vehicle drivers and crews.	___	___
5. Executed proper flag signals.	___	___

**Evaluation Guidance:** Score the soldier GO if all performance measures are passed. Score the soldier NO GO if any performance measure is failed. If the soldier fails any performance measure, show what was done wrong and how to do it correctly.

**References**

**Required**

**Related**

FM 7-7

3-100

071-326-0608

Skill Level 2

**References**

**Required**

**Related**

FM 17-95

FM 21-60



---

**071-326-5704**

**Supervise Construction of a Fighting Position**

**Conditions:** Given soldiers, TOE equipment, and a sector of responsibility.

**Standards:** Ensured that the initial preparation was accomplished for each fighting position and that the completed position provided cover, concealment, and fields of fire.

---

**Performance Steps**

1. Ensure that the construction of the individual fighting position generally follows the sequence below.
  2. Assign the location of the position and the sector of fire. The soldier constructing the position should emplace sector-of-fire stakes.
  3. Ensure the soldiers partially clear fields of fire within their sector and dig a hasty hole for minimum protection, being careful not to destroy natural camouflage around their positions. They should save sod, grass clumps, and so forth, for use as camouflage later.
  4. Ensure the soldiers dig a hole that is armpit deep. If they have a natural frontal parapet, the dirt from the hole should be carried away and camouflaged; if not, it should be used to make a frontal parapet.
  5. Ensure the soldiers get into the firing positions and check their fields of fire. They can now complete a clearing field of fire, clearing only what is absolutely necessary.
  6. Ensure the soldiers camouflage their positions using available materials (such as sod, grass clumps, foliage) blending the positions with the surrounding area. The camouflage should be checked from about 35 meters to the front; if the position can be spotted easily, more camouflage work is needed.
  7. Ensure the soldiers construct overhead cover after all of the above have been accomplished satisfactorily. They should use logs and planks, 4 to 6 inches thick, that will support at least 6 or 8 inches of dirt (logs and dirt should total 12 inches), and dig a cave-like area big enough to get under.
-

Skill Level 2

**Performance Steps**

8. Ensure the soldiers begin to improve their positions upon completion of the overhead cover. Items to check for include grenade sump, drainage trench, elbow holes, night firing stakes, range cards, and camouflage.

**Evaluation Preparation:**

*Setup:* At the site, assign each soldier an area of responsibility. Issue any required equipment or supplies needed to construct the fighting position.

*Brief Soldier:* Tell the soldier to supervise the construction of a fighting position with his soldiers, while being evaluated.

Performance Measures	GO	NO GO
1. Assigned sector of fire to each position.	___	___
2. Checked that initial position was completed first.	___	___
a. Sector-of-fire stakes were emplaced.		
b. Hasty hole for minimum protection was dug.		
c. Natural camouflage around position was preserved.		
3. Supervised completion of fighting position.	___	___
a. Position was at least armpit deep.		
b. Excess dirt from hole was carried away and hidden.		
c. Fields of fire were cleared only of minimum foliage.		
d. Position was camouflaged so it could not be seen 35 meters to the front.		
e. Overhead cover was at least 12 inches (with 4 to 6 inches of logs or planks and 6 to 8 inches of dirt).		
f. Grenade trenches were dug in position.		

**Evaluation Guidance:** Score the soldier GO if all performance measures are passed. Score the soldier NO GO if any performance measure is failed. If the soldier scores NO GO, show what was done wrong and how to do it correctly.

**References****Required**

FM 5-103

FM 7-8

**Related**

3-102

071-326-5704

Skill Level 2

**References**

**Required**

STP 21-1-SMCT

**Related**

---

**071-326-5705**

**Establish an Observation Post**

**Conditions:** Given a squad- or platoon-size element in a defensive position, a TA-312/PT field telephone and communication wire, or a radio, and a probable enemy avenue of approach.

**Standards:** Selected a location for an observation post (OP) that provided observation of the avenues of approach, was within small-arms range of the element, and offered adequate cover and concealment. Established communication between the OP and the platoon leader or squad leader.

---

**Performance Steps**

**Note.** OPs are generally established along probable avenues of approach to listen and observe and to provide early warning of enemy approach.

1. Select an OP.
  - a. The site selected for an OP should provide—
    - (1) Maximum observation of the desired area (specified by the platoon leader).
    - (2) Cover and concealment for the occupants of the OP.
    - (3) Concealed routes to and from the OP.
  - b. Observation is the best way to determine whether the above conditions exist at a site.
  - c. Usually, the best location for an OP is on or near the military crest of a hill. Topographical crests should be avoided because of the possibility of being skylined. It may be appropriate to establish the OP well down the forward slope when observation is restricted by the terrain (figure 071-326-5705-1).



## Performance Steps

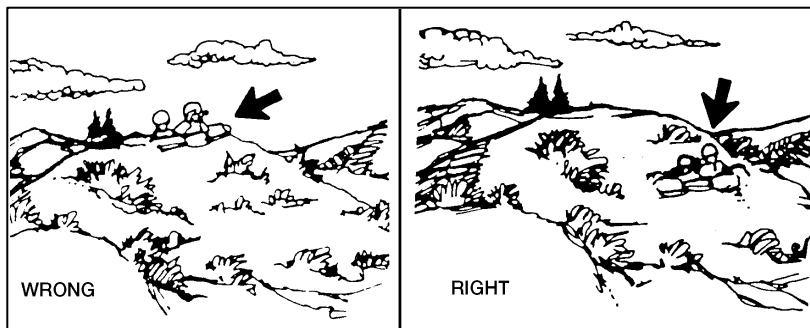

Figure 071-326-5705-1. OP Position

d. OPs should be within effective small-arms range of the unit establishing the OP, and should be supported by other supporting fire when possible.

2. Establish and operate an OP.

a. Wire is the primary means of communication with an OP and may be supplemented by radio. Wire and radio antennas should be carefully positioned and camouflaged to avoid detection by the enemy (figure 071-326-5705-2).

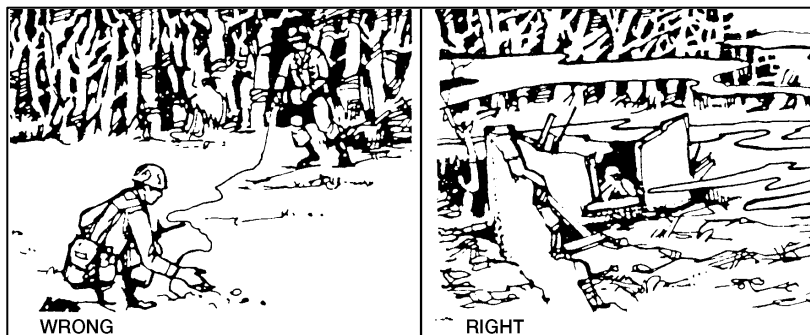

Figure 071-326-5705-2. Camouflage Communication Lines

b. Personnel going to and from the OP must move carefully so movement does not reveal the location to the enemy. Separate routes to and from the OP are established. Camouflage is most important. The OP should be camouflaged even when natural concealment is adequate.



Skill Level 2

**Performance Steps**

c. OPs are operated in reliefs. A minimum of two soldiers is necessary for each relief. One observes while the other records and reports observed information. The observer and recorder should switch duties every 20 to 30 minutes, because the visual efficiency of an observer decreases rapidly after that length of time.

3. Establish and operate an OP during limited visibility.

a. The enemy may use a different, more open avenue of approach during limited visibility conditions; therefore, an OP may have to be moved to another position to serve as an OP at night.

b. Limited visibility OPs are usually closer to defensive positions. Night vision devices may be given for use on the OP. The enemy deploys infiltrators against the defense at night, so a series of OPs, backed up by alert troops equipped with night vision devices and by snipers, can counter this infiltration.

c. OPs are operated in relief except when movement to and from positions would reveal their locations or endanger the personnel.

**Evaluation Preparation:**

*Setup:* In a field environment with terrain on which an OP can be established, provide the element leader with a TA-312/PT field telephone and communication wire, or a radio, and two personnel to act as the observer and the recorder.

*Brief Soldier:* Tell the soldier to establish an OP to observe an area (designated by the tester) forward or to the flanks of his element.

Performance Measures	GO	NO GO
1. Selected an area within small-arms range of the squad- or platoon-size element.	___	___
2. Selected a site that provided maximum observation of the desired area.	___	___
3. Established and operated an area that offered cover and concealment.	___	___
4. Ensured wire or radio communication was established.	___	___
5. Ensured that radio antenna, if used, was camouflaged.	___	___
6. Established several concealed routes to and from the observation post.	___	___
7. Ensured that the observation post was camouflaged.	___	___

Skill Level 2

Performance Measures	GO	NO GO
8. Placed a minimum of two personnel on the observation post.	—	—
9. Instructed observer and recorder to switch duties every 20 to 30 minutes.	—	—

**Evaluation Guidance:** Score the soldier GO if all performance measures are passed. Score the soldier NO GO if any performance measure is failed. If the soldier scores NO GO, show what was done wrong and how to do it correctly.

**References**

**Required**  
FM 7-8  
FM 21-75

**Related**

**SUBJECT AREA 5: NAVIGATE**

---

**071-329-1019**

**Use a Map Overlay**

**Conditions:** Given a military map and a company level map overlay.

**Standards:** Positioned overlay correctly on the map and identified all graphic symbols and information on the overlay.

---

**Performance Steps**

1. Obtain the map sheet(s) listed in the marginal information.
  2. Locate the grid intersections on the map that corresponds to the grid register marks in opposite corners of the overlay.
  3. Place the overlay on the map so the grid register marks fall exactly on top of the grid intersections (figure 071-329-1019-1).
-

**Performance Steps**

**Skill Level 2**

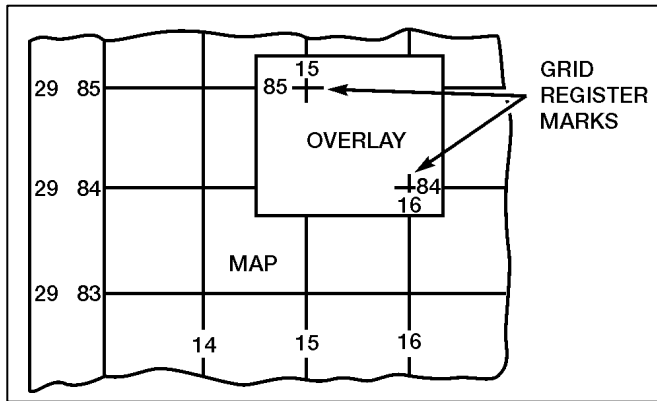

**Figure 071-329-1019-1. Registering the Overlay**

4. Locate the points and areas identified on the overlay.
  - a. Basic symbols (figure 071-329-1019-2).

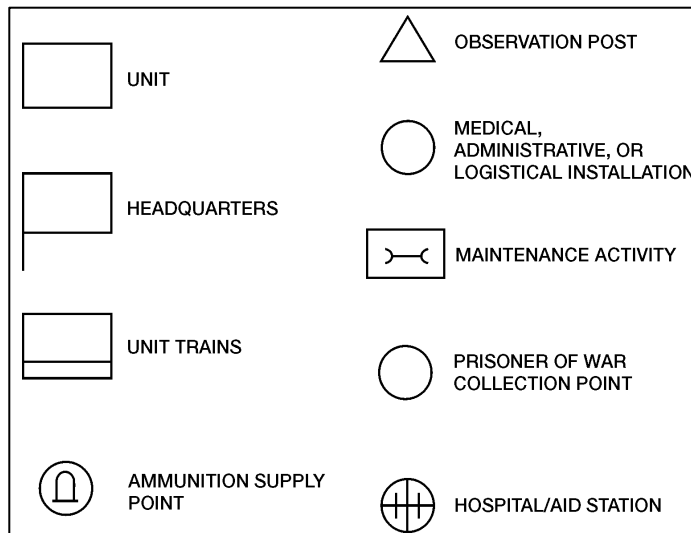

**Figure 071-329-1019-2. Basic Symbols**

- b. Development of a unit symbol (figure 071-329-1019-3).

## Performance Steps

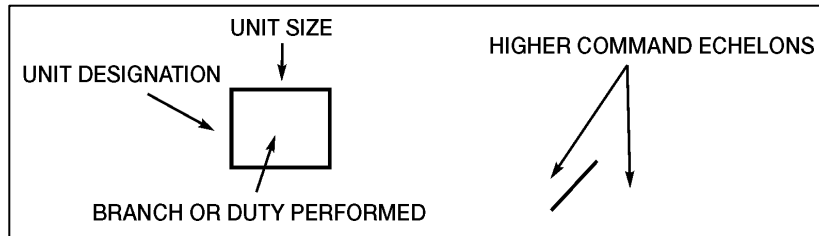

Figure 071-329-1019-3. Development of Unit Symbol

c. Unit-size symbols (figure 071-329-1019-4).

● SQUAD	COMPANY, BATTERY, OR TROOP	▢ TASK FORCE (BATTALION SIZE)
●● SECTION	▢ TEAM (COMPANY SIZE)	▣ REGIMENT OR GROUP
●●● PLATOON	▣ BATTALION OR SQUADRON	× BRIGADE

Figure 071-329-1019-4. Unit-Size Symbols

d. Branch symbols (figure 071-329-1019-5).

× INFANTRY	⊗ MECHANIZED INFANTRY	
◯ ARMOR	◊ ARMORED CAVALRY	▢ SUPPLY
● ARTILLERY	⚡ SIGNAL	⌋ MAINTENANCE
▢ ENGINEER	⊕ MEDICAL	⌒ AIRBORNE

Figure 071-329-1019-5. Branch Symbols

e. Enemy units are depicted in red or by double lines (figure 071-329-1019-6).

**Performance Steps**

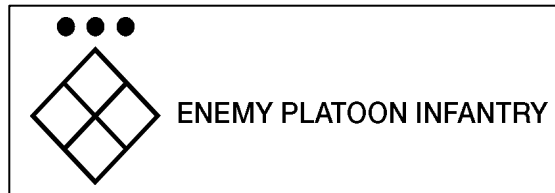

**Figure 071-329-1019-6. Enemy Unit**

f. The broken lines depict proposed or future locations (figure 071-329-1019-7).

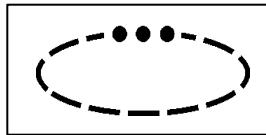
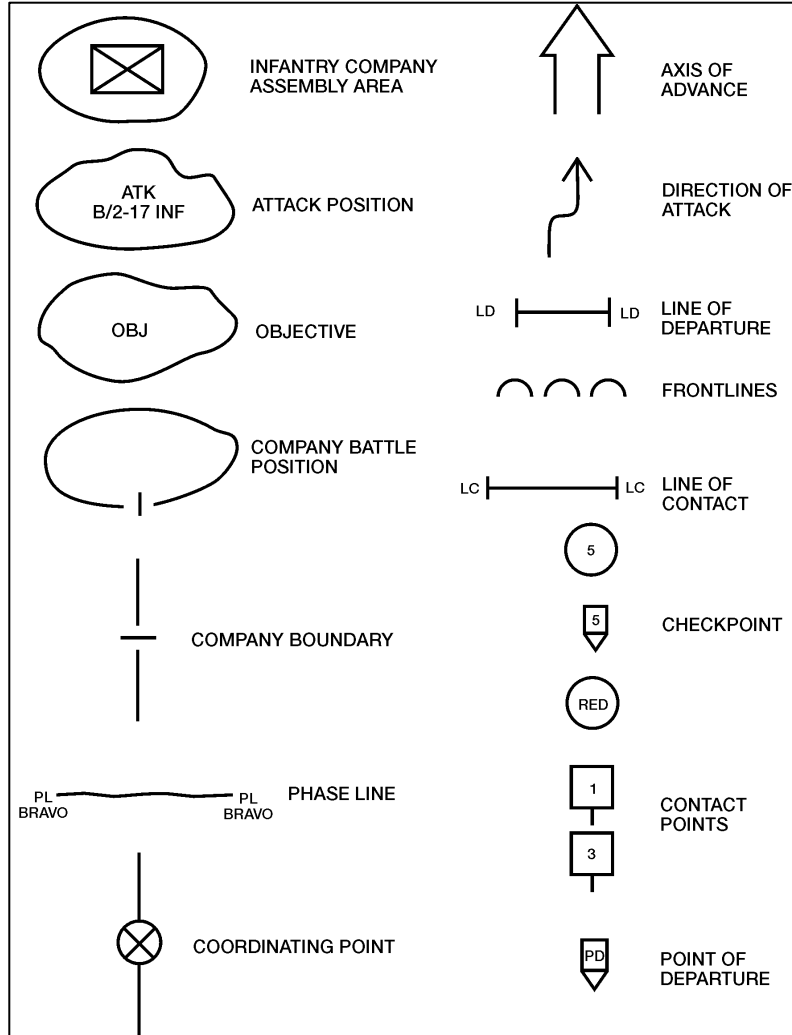

**Figure 071-329-1019-7. Proposed Unit Position**



**Performance Steps**

**g. Tactical control measures (figure 071-329-1019-8).**



**Figure 071-329-1019-8. Tactical Control Symbols**

**Performance Steps**

h. Weapon symbols (figure 071-329-1019-9).

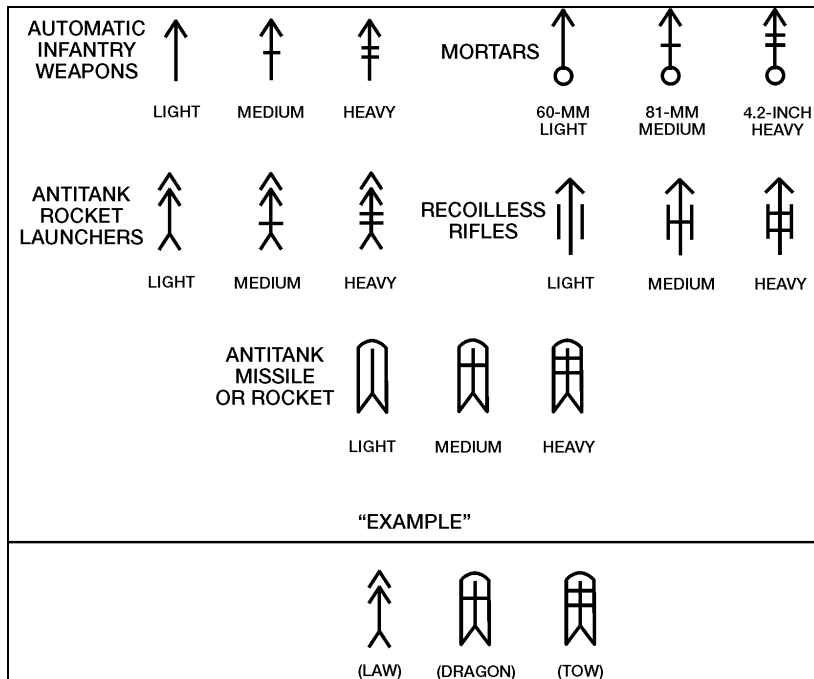

Skill Level 2

**Figure 071-329-1019-9. Weapon Symbols**

i. Armored vehicles (figure 071-329-1019-10).

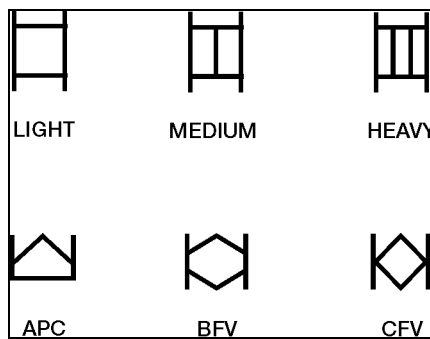

**Figure 071-329-1019-10. Armored Vehicle Symbols**

**Performance Steps**

j. Fortification and obstacles (figure 071-329-1019-11).

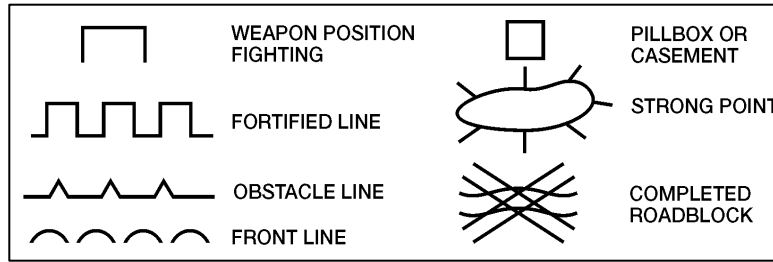
**Figure 071-329-1019-11. Fortification and Obstacle Symbols**

k. Wire (figure 071-329-1019-12).

WIRE OBSTACLES	
UNSPECIFIED	X X X X X X X X
SINGLE FENCE	X — X — X
DOUBLE FENCE	XX — XX — XX
DOUBLE APRON FENCE	<del>XXXXXXXXXX</del>
LOW WIRE FENCE	<u>XXXXXXXXXX</u>
HIGH WIRE FENCE	<u>XXXXXXXXXX</u>
SIGLE CONCERTINA	<u>00000000</u>
DOUBLE STRAND CONCERTINA	<u>00000000</u>
TRIPLE STRAND CONCERTINA	<u>00000000</u>
TRIP WIRE	— † —

**Figure 071-329-1019-12. Tactical Wire Symbols**

l. Mines (figure 071-329-1019-13).



**Performance Steps**





	MINE TYPE UNSPECIFIED		ANTITANK, BOOBY TRAPPED
	ANTIPERSONNEL		BOOBY TRAP
	ANTITANK		

Figure 071-329-1019-13. Mine Symbols

m. Indirect fire symbols (figure 071-329-1019-14).



	TARGET (W/NUMBER)
	RECTANGULAR TARGET
	FINAL PROTECTIVE FIRE (FPF)
	NUCLEAR TARGET

Figure 071-329-1019-14. Indirect Fire Symbols

**Evaluation Preparation:**

*Setup:* Provide a military map and a company level map overlay. Ask the soldier to identify information on the overlay from the performance measures.

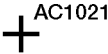
*Brief Soldier:* Tell the soldier he must be able to correctly place the overlay on the map and identify any graphic symbols or information on the overlay as requested.

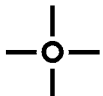
Performance Measures	GO	NO GO
1. Placed overlay grid register marks over grid intersections.	—	—
2. Identified marginal information.	—	—
3. Identified security classification.	—	—

Skill Level 2

<b>Skill Level 2</b>	<b>Performance Measures</b>	<b>GO</b>	<b>NO GO</b>					
	4. Identified graphic symbols.	_____	_____					
	<b>Evaluation Guidance:</b> Score the soldier GO if all performance measures are passed. Score the soldier NO GO if any performance measure is failed. If the soldier scores NO GO, show what was done wrong and how to do it correctly.							
	<b>References</b> <table style="width: 100%; border: none;"> <tr> <td style="width: 50%;"><b>Required</b></td> <td style="width: 50%; text-align: center;"><b>Related</b></td> </tr> <tr> <td>FM 3-25.26</td> <td></td> </tr> <tr> <td>FM 101-5-1</td> <td></td> </tr> </table>			<b>Required</b>	<b>Related</b>	FM 3-25.26		FM 101-5-1
<b>Required</b>	<b>Related</b>							
FM 3-25.26								
FM 101-5-1								
<b>SUBJECT AREA 20: CASUALTY REPORTING AND HANDLING</b>								

**805C-PAD-2060**

**Report Casualties**

**Conditions:** Given a casualty, DA Form 1155, DA Form 1156, a map, and a pen or pencil.

**Standards:** Recorded all known data elements accurately and legibly on DA Form 1156 and DA Form 1155, without error.

**Performance Steps**

1. Prepare DA Form 1156.
  - a. Leave the Control Number item blank.
  - b. Complete the Check Applicable Box item as it pertains to the casualty.
  - c. Complete item 1 with the casualty's last name, first name, and middle initial (to include Jr, Sr, III).
  - d. Complete item 2 with the casualty's complete Social Security number.
  - e. Complete item 3 with the casualty's rank.
  - f. Complete item 4 with the hour and date of incident to include the time zone.
  - g. Complete item 5 with the casualty's unit.
  - h. Complete item 6 with the geographical location (nearby town) and grid coordinates to include the 100,000-meter square grid coordinates, 2-letter designator, and nearest village or field trainers.

---

**Performance Steps**

---

i. Complete item 7 with a check in the appropriate box to enter the type of casualty (only medical personnel may enter a check in the lightly wounded or injured in action and seriously injured or injured in action boxes); check yes or no to indicate if the body was recovered; check yes or no to indicate if the body has been identified; enter the collection point to which the casualty is evacuated, if unknown indicate "unknown."

j. Complete item 8 with the witnesses who saw the incident or identified remains to include the name, grade, social security number, and unit(s) of witnesses.

k. Complete item 9 with the applicable remarks to include additional circumstances such as , religious ministrations performed, type of mission the unit was conducting, short synopsis of the incident.

l. Do not complete the first three boxes in item 10 but enter his or her unit, grade, Social Security number, date, and signature in item 10 as the person who prepared the report.

**2.** Prepare DA Form 1155.

a. Check the applicable box at the top of the form as it relates to the casualty witnessed.

b. Complete item 1 with the casualty's last name, first name, and middle name.

c. Leave item 2 blank.

d. Complete item 2a with the casualty's complete Social Security number

e. Complete item 3 with the casualty's rank.

f. Complete item 4, if appropriate, with the date of the casualty's death or the date when the casualty was last seen along with the time zone.

g. Complete item 5 with the casualty's unit.

h. Complete item 6 with the geographical location including the six-digit coordinate as well as the nearest town to the incident.

i. Complete item 7 only if name or Social Security number of the casualty is unknown or not positive. If they are unknown or not positive enter the estimated age, weight, height, hair color, eye color, race, home town, civilian occupation, nickname, spouse's name, children's name(s), (if applicable), other identifying marks (such as birthmarks or tattoos), and other persons who may have witnessed the incident or have further information.

---

Skill Level 2

Skill Level 2

**Performance Steps**

- j. Complete item 8 with a short, concise narrative of the circumstances regarding the incident and, if known, the cause of death or condition when last seen and how identified.
- k. Complete items 9 through 13 with the name, Social Security number, unit, date, and signature of the person making the statement.
- l. Submit form in accordance with local guidance.

**Evaluation Preparation:**

*Setup:* Provide soldier with DA Form 1155 and DA Form 1156, a map, pencil and paper. Give the soldier a scenario that provides all the information needed to accomplish the performance measures.

*Brief Soldier:* Tell the soldier that he will be evaluated on his ability to report casualties, by preparing DA Form 1155 and DA Form 1156.

Performance Measures	GO	NO GO
1. Prepared DA Form 1156.	___	___
a. Left the Control Number item blank.		
b. Completed the Check Applicable Box item as it pertained to the casualty.		
c. Completed item 1 with the casualty's last name, first name, and middle initial (to include Jr. Sr. III).		
d. Completed item 2 with the casualty's complete Social Security number.		
e. Completed item 3 with the casualty's rank.		
f. Completed item 4 with the hour and date of incident to include the time zone.		
g. Completed item 5 with the casualty's unit.		
h. Completed item 6 with the geographic location (nearby town) and grid coordinates to include the 100,000-meter square grid coordinates, 2-letter designator, and nearest village or field trainers.		

Performance Measures	GO	NO GO
i. Completed item 7 with a check in the appropriate box; entered the type of casualty (only medical personnel may enter a check in the lightly wounded or injured in action and seriously injured or injured in action boxes); checked yes or no to indicate if the body was recovered; checked yes or no to indicate if the body has been identified; entered the collection point to which the casualty was evacuated, if unknown indicated "unknown."		
j. Completed item 8 with the witnesses who saw the incident or identified remains to include the name, grade, Social Security number, and unit(s) of witnesses.		
k. Completed item 9 with the applicable remarks to include additional circumstances, such as religious ministrations performed, type of mission the unit was conducting, short synopsis of the incident.		
l. Did not complete the first three boxes in item 10 but entered his or her unit, grade, Social Security number, date, and signature in item 10 as the person who prepared the report.		
2. Prepared DA Form 1155.	___	___
a. Checked the applicable box at the top of the form as it related to the casualty witnessed.		
b. Completed item 1 with the casualty's last name, first name, and middle name.		
c. Left item 2 blank.		
d. Completed item 2a with the casualty's complete Social Security number.		
e. Completed item 3 with the casualty's rank.		
f. Completed item 4, if appropriate, with the date of the casualty's death or the date when the casualty was last seen along with the time zone.		
g. Completed item 5 with the casualty's unit.		
h. Completed item 6 with the geographic location including the six-digit coordinate as well as the nearest town to the incident.		

**Skill Level 2**

Skill Level 2	Performance Measures	GO	NO GO
	i. Completed item 7 only if name or Social Security number of the casualty is unknown or not positive. If they are unknown or not positive entered the estimated age, weight, height, hair color, eye color, race, home town, civilian occupation, nickname, spouse's name, children's name(s), (if applicable), other identifying marks (such as birthmarks or tattoos), and other persons who may have witnessed the incident or have further information.		
	j. Completed item 8 with a short, concise narrative of the circumstances regarding the incident and, if known, the cause of death or condition when last seen and how identified.		
	k. Completed items 9 through 13 with the name, Social Security number, unit, date, and signature of the person making the statement.		
	l. Submitted form in accordance with local guidance.		

**Evaluation Guidance:** Score the soldier GO on performance measures passed. Score the soldier NO GO on any performance measures failed. The soldier must score a GO on all of the performance measures to receive a GO on the task. If the soldier scores NO GO, show the soldier what was done wrong.

**References**

**Required**

DA Form 1155

DA Form 1156

**Related**

AR 600-8-1

**SUBJECT AREA 21: DEFENSE MEASURES**

**071-430-0002**

**Conduct a Defense by a Squad**

**Conditions:** Given a squad, a priority of work, and locations for the crew-served weapons designated by the platoon leader.

**Standards:** Accomplished preparation of a defensive position within the time specified in the platoon leader's order while maintaining security, camouflage, and concealment.

1. Designated fighting positions for squad members.

3-118

071-430-0002

Skill Level 2

2. Designated alternate and supplementary positions for squad members.
3. Ensured all squad members followed assigned priority of work.
4. Maintained security.
5. Continued work as rapidly as possible.
6. Maintained camouflage and concealment (to include noise, light, and litter discipline).
7. Constructed positions properly.

---

**Performance Steps**

---

1. Designate primary positions.
  - a. Ensure each position has cover, concealment, and good fields of fire. Position weapons so their fires overlap, mutually support one another, and can be integrated, so you can place heavy surprise fire on the enemy. Watch closely any routes that could provide the attacker cover and positions from which he can mass his fire on your position. Be sure your entire squad sector is covered so you can repel any assault.
  - b. Consider the number of men available, then position each one so he can support the men on his right and left. When the platoon's key weapons have been positioned, the men in the squad are positioned to protect those weapons from a dismounted assault. Each sector of fire must cross in front of another position at a point beyond hand grenade range. Site each fighting position using natural cover and concealment; then—
    - (1) Clear fields of fire to allow each man to do the job for which he is positioned. DO NOT OVER CLEAR.
    - (2) Build artificial cover, such as a parapet, if required.
    - (3) Hide everything.
  - c. Ensure that all enemy approaches into your squad sector are adequately covered by automatic weapons fire.
  - d. Before digging in, move to the front of the position to ensure that each fighting position has frontal cover from enemy fire and all positions are mutually supporting.

**Note.** A good fighting position should allow you to see and fire to the front when not receiving effective direct fire; however, if effective direct fire is received, the soldier can move behind frontal cover and fire to the oblique.
  - e. To position each weapon of a rifle squad, follow the procedures below.

Skill Level 2

**Performance Steps**

**(1)** Automatic riflemen. Identify dismounted avenues of approach, such as ravines, draws, and heavily wooded or brushy areas that are not covered with the machine gun. In areas covered by the machine gun, find out what dead space the machine gun has and cover it with automatic rifle fire, if possible. If there is no dead space, assign a sector that will interlock with and overlap the machine gun's sector and final protective fire.

**(2)** Grenadiers. Position grenade launchers to cover the dead space of the automatic weapon final protective fire. They must also be positioned to cover the entire squad sector.

**(3)** Riflemen. Position riflemen between the remaining positions to give continuous observation and fire throughout the squad sector. They provide mutual support between positions and identify targets for the squad and platoon key weapons (grenade launcher, squad automatic weapons, machine gun, and Dragons).

**(4)** Claym ore mines. Use these to cover any dead space that cannot be covered with 40-mm grenade launchers, and to supplement the fire of your riflemen.

**f.** Select a position from which you can control the fire of your squad. Use your weapon only when necessary to protect yourself, to direct fire, or to influence the action at a critical point. Position yourself slightly behind the squad so you can observe and contact your squad, or at least your team leaders. If your squad strength is reduced, or the terrain does not permit you to establish a position to the rear, man a forward position. In this case, you may have to construct a single position to be able to observe your squad sector. You must be able to maintain contact with your platoon and fire team leaders from whatever position you select. Look for covered routes that you can use to move to the positions of your team leaders and platoon leader.

**2.** Designate alternate positions.

**a.** Prepare alternate positions so they are ready for occupation by the squad when the primary positions are no longer defensible. The locations of alternate positions are highly dependent upon the terrain, cover and concealment, and existing enemy situation. They must be near enough to the primary positions so the squad can cover the same sectors of fire as from the primary positions, without sustaining excessive casualties. A soldier's alternate position may be to the flank or slightly to the rear of his primary position.

**b.** When selecting alternate positions, consider the following points:

**(1)** Do they allow the weapon(s) or element(s) to accomplish the same mission as from the primary positions?



---

**Performance Steps**

---

(2) Do they provide—

- (a) Observation of the primary sector of fire?
- (b) Cover and concealment?
- (c) Maximum use of natural and artificial obstacles?
- (d) Control of the key terrain in the squad sector?
- (e) Cover of the avenues of approach into the sector?
- (f) Cover and concealment of withdrawal?

c. Pick squad alternate positions based on the alternate positions of key weapons (M60 machine gun, M249 machine gun, and Dragon).

d. Depending on their priority, prepare alternate positions immediately after the completion of the primary positions. Construct communication trenches between primary and alternate positions as time and terrain permit. When supervising the preparation of alternate positions, ensure that they are sited and constructed to take maximum advantage of the natural defensive characteristics of the terrain and the capabilities of organic weapons.

3. Designate supplementary positions.

a. Orient supplementary positions, unlike alternate positions, in a different direction than the primary position normally, within 200 meters of the primary positions. As time and terrain permit, prepare communication trenches to provide covered routes between primary and supplementary positions.

b. When selecting supplementary positions, consider the following:

- (1) Do they allow the squad to defend as part of the platoon against enemy attack from the flank(s) and rear?
- (2) Do they cover the most dangerous avenues of approach, other than those into the primary positions?
- (3) Do they meet the same guidelines that apply to placement and construction of primary and alternate positions?

---

**Evaluation Preparation:**

*Setup:* Select an area in the field with varying terrain, cover, and concealment. Show the squad leader the squad's area of responsibility.

*Brief Soldier:* Tell the soldier that he is to select primary, alternate, and supplementary positions, in an area specified by the platoon leader, ensuring that the supplementary position is oriented in a different direction than the primary position.

Skill Level 2

Skill Level 2	Performance Measures	GO	NO GO
	1. Ensured the primary position met the following requirements:	—	—
	a. Used natural cover and concealment.		
	b. Ensured all fighting positions and weapon emplacements were mutually supporting.		
	c. Marked primary positions and informed squad members where fighting positions were constructed.		
	d. Supervised construction of the fighting positions.		
	2. Ensured the alternate position met the following requirements:	—	—
	a. Provided observation of the primary sector of fire.		
	b. Provided cover and concealment.		
	c. Provided use of natural and artificial obstacles.		
d. Provided cover of avenues of approach into the sector.			
e. Provided covered and concealed routes of withdrawal.			
3. Ensured the supplementary position provided for and met the following requirements:	—	—	
a. Allowed the squad to defend as part of the platoon against enemy attack from the flank(s) and rear.			
b. Provided observation of the primary sector of fire.			
c. Provided cover and concealment.			
d. Provided natural and artificial obstacles.			
e. Provided cover of avenues of approach into the sector.			
f. Provided covered and concealed routes for withdrawal.			
g. Covered dangerous avenues of approach other than those into the primary position.			
h. Provided the same guidelines in construction and placement of the supplementary position as in the alternate position.			

**Evaluation Guidance:** Score the soldier GO if all performance measures are passed. Score the soldier NO GO if any performance measure is failed. If the soldier scores NO GO, show the soldier what was done wrong and how to do it correctly.

**References**

**Required**

FM 7-7

FM 7-8

**Related**

**SUBJECT AREA 22: UNIT OPERATIONS**

Skill Level 2

---

**071-326-5502**

**Issue a Fragmentary Order**

**Conditions:** Given changes to original operation order (OPORD), and a requirement to develop and issue a fragmentary order (FRAGO). (See figure 071-326-5502-1.)

**Standards:** Developed and issued a clear and brief FRAGO based on changes in the mission or additional information. Issued the FRAGO in the standard OPORD format.

---

**Performance Steps**

**Note.** The FRAGO provides timely changes of existing orders to subordinate and supporting commanders while providing notification to higher and adjacent commands. A FRAGO is either oral or written and addresses only those parts of the original OPORD that have changed. The FRAGO differs from an OPORD only in the degree of detail provided.

1. Use standard military terminology.
  2. Issue the FRAGO in the same sequence as the OPORD. Use all five paragraph headings as shown in the following example.
-

## Performance Steps

FRAGMENTARY ORDER \_\_\_\_\_

References: (Mandatory) Reference the order being modified.

Time Zone Used Throughout the Order: (Optional)

1. SITUATION. (Mandatory) Include any changes to the existing order.
2. MISSION. (Mandatory) List the new mission.
3. EXECUTION.  
Intent: (Optional)
  - a. Concept of operations. (Mandatory)
  - b. Tasks to subordinate units. (Mandatory)
  - c. Coordinating instructions. (Mandatory) Include the statement, "Current overlay remains in effect" or "See change 1 to Annex C, Operations Overlay." Mark changes to control measures on overlay or issue a new overlay.
4. SERVICE SUPPORT. Include any changes to existing order or the statement, "No changes to OPORD \_\_\_\_."
5. COMMAND AND SIGNAL. Include any changes to existing order or the statement, "No changes to OPORD \_\_\_\_."

ACKNOWLEDGE: (Mandatory)

NAME (Commander's last name)  
RANK (Commander's rank)

Figure 071-326-5502-1. FRAGO Example

**Evaluation Preparation:**

*Setup:* At the test site, provide equipment as stated in conditions.

*Brief Soldier:* Tell the soldier to develop and issue a FRAGO that includes all changes to the original OPORD.

Performance Measures	GO	NO GO
1. Issued a FRAGO.	___	___
2. Used standard military terminology.	___	___
3. Included all changes to original OPORD.	___	___



**Evaluation Guidance:** Score the soldier GO if all performance measures are passed. Score the soldier NO GO if any performance measure is failed. If the soldier fails any performance measures, show what was done wrong and how to do it correctly.

**References**

**Required**

**Related**

FM 101-5

---

**071-326-5503**

**Issue a Warning Order**

**Conditions:** Given preliminary notice of an order or action that is to follow and a requirement to develop and issue a warning order (WARNO) to subordinates.

**Standards:** Developed a warning order and issued it to subordinate leaders within the time allotted. The order was issued so all subordinate leaders understood their missions and any coordinating instructions. Issued the warning order in the standard OPORD format.

---

**Performance Steps**

1. Precede the order with the words "WARNING ORDER."
  2. Use standard terminology.
  3. Issue the WARNO in the five-paragraph field order format.
    - a. Situation Paragraph.
      - (1) Enemy forces: Provide available information on disposition, composition, strength, capabilities, and most probable course of action.
      - (2) Friendly forces: Give available information concerning the missions of next higher and adjacent units.
-

**Performance Steps**

(3) Attachments and detachments: Give information concerning any units that have been attached or detached.

b. Mission Paragraph. The mission paragraph contains a clear, concise statement of the task to be accomplished and the purpose for doing it.

c. Execution Paragraph. Provide information about the operation, if available.

d. Service Support Paragraph. Provide all known instructions and arrangements supporting the operation.

e. Command and Signal Paragraph. Designate the succession of command if it differs from unit SOP.

**Note.** Warning orders involving movement should state the time of movement.

**Evaluation Preparation:**

*Setup:* At the test site, provide a platoon-level warning order. The warning order will be given orally to the soldier. The soldier will then be given 10 minutes to prepare his squad warning order.

*Brief Soldier:* Tell the soldier to extract from the platoon warning order all information that pertains to his squad. Tell him he will have 10 minutes to prepare the squad warning order. Tell him that he will present an oral squad warning order.

Performance Measures	GO	NO GO
1. Stated the words WARNING ORDER.	___	___
2. Used standard military terminology.	___	___
3. Issued the warning order in the five-paragraph field order format.	___	___
4. Gave all available information.	___	___

**Evaluation Guidance:** Score the soldier GO if all performance measures are passed. Score the soldier NO GO if any performance measure is failed. If the soldier fails any performance measures, show what was done wrong and how to do it correctly.

**References****Required****Related**

FM 101-5

## 551-88N-0002

### Prepare for Unit Move

**Conditions:** You have received a movement order directing your unit to conduct a move to the port of embarkation and deploy in support of an Army or Joint mission. You have access to the unit SOP and all unit movement directives.

**Standards:** Prepared the unit for movement using the necessary references (vehicle -10s) and equipment to deliver vehicles and equipment to arrive at the port of debarkation with no loss of vehicles or equipment (operational and ready for combat).

#### Performance Steps

1. Prepare vehicles and equipment for shipment.
2. Load vehicles with unit equipment.
3. Load containers (when applicable).
4. Prepare vehicle load cards.
5. Prepare equipment and supplies for shipment.
6. Build 463L pallets.
7. Load equipment and supplies into containers.
8. Prepare hazardous materials for shipment.

#### Evaluation Preparation:

Evaluate this task during a field training exercise or a unit training exercise. Inform the soldier that the evaluation is measured on the ability to perform all the functions listed.

Performance Measures	GO	NO GO
1. Prepared vehicles and equipment for shipment.	___	___
a. Cleaned equipment thoroughly, removing all dirt and oil.		
b. Inspected vehicle to ensure it is mechanically sound, free of leaks, drips, and other operational defects.		
c. Stenciled vehicles.		
d. Checked fuel levels.		
e. Inspected fuel cans for faulty lid gaskets, leaks, and other defects.		
f. Removed and secured sensitive and classified material.		

Skill Level 2

Skill Level 2	Performance Measures	GO	NO GO
	g. Removed and consolidated hazardous materials when practical.		
	h. Reduced vehicle length, height, and width.		
	i. Secured ignition keys to steering wheel with wire.		
	j. Secured rotating parts.		
	k. Ensured all vehicles and trailers were equipped with serviceable tiedown devices or shackles.		
	l. Protected radios and other electronic components on vehicles.		
	m. Boxed and/or stored on vehicle equipment (OVE).		
	n. Lowered cab assembly (only if required).		
	2. Loaded vehicles with unit equipment.	___	___
a. Maximized use of all cargo space.			
b. Did not exceed vehicle payload capacity.			
c. Protected against metal-to-metal contact.			
d. Protected load from weather damage.			
e. Securely restrained all loaded equipment.			
f. Weighed and documented the load on the load card.			
3. Loaded containers (when applicable).	___	___	
a. Prepared vehicles as described in step 1.			
b. Reduced vehicle fuel levels to 1/4 tank.			
c. Placed vehicles in gear with the handbrake set.			
d. Disconnected batteries and secured terminal cables to prevent arcing.			
e. Chocked or cradled vehicle wheels on all four sides to prevent lateral and lengthwise movement.			
f. Placarded container appropriately when enclosing vehicle with fuel in the tank.			
g. Documented container load and seal number (if applicable) on the packing list.			
4. Prepared vehicle load cards.	___	___	
a. Completed, in duplicate, FORSCOM Form 285-R.			



Performance Measures	GO	NO GO
<b>b.</b> Placed one copy of the vehicle load card in the driver side door pocket (or taped to the inside of the door) and provided one copy to the platoon sergeant or platoon leader.		
<b>5.</b> Prepared equipment and supplies for shipment.	___	___
<b>6.</b> Built 463L pallets.	___	___
<b>a.</b> Distributed large, heavy objects from the center of the pallet outwards to maintain center of balance (CB).		
<b>b.</b> Placed lighter and/or smaller items on top or beside the heavier objects.		
<b>c.</b> Placed containers right-side up with "special handling" labels facing out.		
<b>d.</b> Constructed load in a square or pyramid shape, whenever possible, to make load stable, easy to handle, and easier to secure on the pallet.		
<b>e.</b> Placed hazardous materials, approved for palletizing by the UMO, on the pallet with the label clearly visible and never buried or hidden.		
<b>f.</b> Placed plastic covers over the load.		
<b>g.</b> Placed nets over the plastic covers and adjusted to fit snugly to load.		
<b>7.</b> Loaded equipment and supplies into containers.	___	___
<b>a.</b> Inspected containers for defects. Rejected containers with holes, severe dents, faulty doors, damaged lifting points, or structural defects.		
<b>b.</b> Equalized weight distribution throughout the container.		
<b>c.</b> Placed heavy and wet material on the bottom and light and dry material on top.		
<b>d.</b> Kept the CB of the load, as near as possible, at the center of the container for air shipments. If this was not possible, marked the CB on the outside of the container.		
<b>e.</b> Stored items that could be damaged by water on dunnage off the floor.		

**Skill Level 2**

Skill Level 2	Performance Measures	GO	NO GO
	f. Placed packages containing liquid, or that posed a leak hazard, on a double layer of dunnage to reduce damage due to leakage.		
	g. Stowed hazardous material by the doors of the containers.		
	h. Blocked and braced spaces between the contents of the load and the container walls and container ceiling to prevent the load from shifting when moved or tilted.		
	i. Blocked and braced doors at least six inches back to prevent the load from falling out when the doors were opened.		
	j. Placed one copy of the packing list inside the container on the door and one copy on the outside of the container door. Three additional copies of the packing list should be provided to the Unit Movement Officer (UMO), who in turn will forward a copy each to the Installation Transportation Office (ITO) and the Transportation Terminal Battalion (TTB).		
	8. Prepared hazardous materials for shipment.	—	—
	a. Packed for shipment with equipment only those hazardous materials identified by the UMO.		
	b. Applied the required markings, proper shipping name, ID number, and UIC/SUN provided by the UMO.		
	c. Marked all oxygen and acetylene containers with the UIC/SUN.		
d. Drained and cleaned all five-gallon fuel cans, field cans, water heaters, gasoline lanterns, portable generators, blow torches, and similar equipment in which combustibles or fuel, other than diesel, were used or stored.			
e. Disconnected the batteries of non-self-propelled equipment, such as generators, and protect the terminal ends from arcing and from corrosion.			
f. Drained and placarded bulk fuel carriers.			
g. Removed all loose ammunition and explosives from all containers and vehicles.			

**Evaluation Guidance:** Score the soldier GO for the task if all performance measures are passed. Score the soldier a NO GO for the task if any

performance measures are failed. For all NO GO performance measures, demonstrate how they should be performed and allow the soldier to improve and correct their mistakes.

#### References

##### Required

##### Related

FM 4-01.011

TM 38-250

**SUBJECT AREA 23: SECURITY AND CONTROL**

Skill Level 2

### 301-371-1200

#### Process Captured Materiel

**Conditions:** This task can be performed in field and garrison locations under all conditions. Given captured enemy materiel consisting of a map, signal operation instructions, unidentified equipment, complete with reference manuals, captured enemy equipment tags, captured document tags, a sheet marked TECHDOC, blank spot reports, and unit SOP describing the processing and evacuation of captured enemy materiel.

**Standards:** Secured captured enemy materiel. Prepared a spot report on captured enemy materiel known or believed to be of intelligence value. Filled out and attached tag to the item of captured enemy materiel. Selected correct disposition procedure for each item of captured enemy materiel.

#### Performance Steps

1. Safeguard the CEM.
  - a. Categorize the CEM into—
    - (1) Captured enemy documents include any piece of recorded information, regardless of form, obtained from the enemy, which subsequently comes into the hands of a friendly force. CEDs can be U.S. or allied documents that were once in the hands of the enemy.
    - (2) Captured enemy equipment (CEE) includes all types of foreign materiel which may have military application found on an enemy prisoner of war (EPW) or on the battlefield.
  - b. Protect the CEM from looting, loss, misuse, recaptures or destruction by placing under guard at all stages during the intelligence exploitation process. Use the best method available to preserve the item in its original condition.
2. Prepare a spot report on all time-sensitive information.
  - a. Identify time-sensitive information. The TECHINT appendix to an

**Performance Steps**

intelligence annex will delineate time-sensitive technical items and reporting channels.

**Note.** Time-sensitive information includes any significant intelligence information with either military or technical application, to include enemy order of battle, enemy maps, overlays, operation orders, signals, codes, cryptographic materiel, new weapons or equipment on the battlefield, information critical to successfully accomplishing friendly courses of action, or information that indicates a significant change in the enemy's capabilities or intentions.

**b.** Submit a spot report to notify higher commands of the capture or identification of enemy materiel believed to answer intelligence requirements.

(1) Use S-A-L-U-T-E format to identify—

- (a) S – Size.
- (b) A – Activity.
- (c) L – Location.
- (d) U – Unit.
- (e) T – Time.
- (f) E – Equipment.

(2) Report time-sensitive items by the least IMMEDIATE precedence.

**3.** Tag each item of CEM.

**a.** Tag all CEM found on the battlefield with no known association to an EPW.

- (1) Use CEE Tag on each piece of equipment.
- (2) Use Captured Document Tag for each document.

**b.** Attach a sheet marked TECHDOC to flag the CED, if the CED is associated with a particular piece of CEM.

(1) List the precise location, time, circumstances of capture and a detailed description of the materiel, on the sheet marked TECHDOC.

(2) Treat all documents marked TECHDOC with the highest priority and forward them through the intelligence officer to the higher command until their value is determined.

**c.** Use special procedures for handling captured communication-encryption (C-E) equipment and documents marked TECHDOC.

- (1) Handle in close coordination with the communications staff.
- (2) Treat CEDs containing communications or cryptographic information as secret material.
- (3) Tag and evacuate through secure channels without delay.

---

**Performance Steps**

---

**d.** Use field expedient method when no preprinted tags are available. Ensure, as a minimum, to include the following information:

- (1)** Provide date and time of capture.
- (2)** Identify capturing unit and its designation.
- (3)** Explain circumstances of capture.
- (4)** Provide the identity of the CED or CEE captured.
- (5)** Identify the location where the document was captured, including the six or eight digit grid coordinate.

**e.** Tag without defacing the item.

- (1)** Ensure that all markings that appear on the materiel at the time of capture are preserved.
- (2)** Ensure that items are tagged so as not to damage or destroy the documents or equipment.
- (3)** Never write on the document itself.
- (4)** Put tag, without damaging the CED, in a waterproof bag.
- (5)** Attach tag to CEM so it will not come off.

**4.** Select the correct disposition procedure for each item of CEM.

**a.** Identify all time-sensitive captured enemy materiel to be evacuated to the S2, who will screen for intelligence or technical value, and evacuate to the rear for examination and exploitation. All enemy documents captured on the battlefield are sent immediately to the first intelligence staff officer in the chain. The S2/G2 routes all enemy documents to the nearest interrogation element for tactical exploitation. Interrogators screen the documents for immediate information and forward them to higher command, as required.

**(1)** Evacuate CEM with any technical documents found that relate to its design or operation. When the materiel cannot be evacuated, the documents should be identified with the materiel by attaching a sheet marked TECHDOC, and the following information:

- (a)** List the precise location, time, and circumstance of capture.
  - (b)** List a detailed description of the materiel.
  - (c)** Take photographs of the equipment and evacuate with the document.
  - (d)** Take photographs of the materiel, placing an object of known size such as a ruler near the materiel to provide a size reference.
  - (e)** Protect equipment that is too large to evacuate.
- 

Skill Level 2

Skill Level 2

**Performance Steps**

(f) Detail guards to safeguard the item until you receive further directions.

(g) Keep photos with TECHDOC and evacuate.

(2) Evacuate CEM through your chain of command to the S2, who will screen for intelligence or technical value, then evacuate to the rear for examination and exploitation.

b. Evacuate other CEM through similar logistic assets (for example route captured petroleum, oil, and lubricants [POL] through our POL points).

c. Protect the CEM that cannot be evacuated, until disposition instructions are received.

**Evaluation Preparation:**

*Setup:* Prepare samples of captured enemy documents. Prepare captured document tags for CEDs. Prepare captured enemy equipment tags for all unidentified equipment, complete with reference manuals. Provide a sheet marked TECHDOC, blank spot reports, and unit SOP.

*Brief Soldier:* Instruct the soldier to process and evacuate all CEDs and CEE using captured document tags, captured enemy equipment tags and a sheet marked TECHDOC, when necessary.

Performance Measures	GO	NO GO
1. Safeguarded each item.	___	___
a. Used best method available to preserve the item in its original condition.		
b. Protected the item from looting, loss, misuse, recapture or destruction by placing under guard at all stages during the intelligence exploitation process.		
2. Submitted a written or verbal spot report on time-sensitive information that included six of six S-A-L-U-T-E items identified correctly.	___	___
3. Completed the appropriate tag for each item.	___	___
a. Used captured enemy equipment or captured document tag for CEM found on the battlefield.		
b. Attached a sheet marked "TECHDOC" to any CED associated with a particular piece of CEM. The cover sheet should list the precise location, time, circumstances of capture, and a detailed description of the materiel. Took photos of the CEM with a size		

Performance Measures	GO	NO GO
reference, if possible, and kept with TECHDOC.		
c. Used field expedient method when no preprinted tags were available.		
d. Tagged without defacing the item.		
4. Selected the correct disposition procedure for each item.	—	—

Skill Level 2

**Evaluation Guidance:** Score the soldier GO if all performance measures are passed. Score the soldier NO GO if any performance measure is failed. If the soldier scores NO GO, show him what was done wrong and how to do it correctly.

**References**

**Required**

**Related**

- FM 3-19.40
- FM 34-52
- FM 34-54

**SUBJECT AREA 25: EQUIPMENT CHECKS**

**091-CLT-4029**

**Supervise Preventive Maintenance Checks and Services**

**Conditions:** In the field or in a motor pool environment, given proper equipment, appropriate technical manuals, supporting forms and documentation, tools, and personnel.

**Standards:** Ensured maintenance status of assigned equipment was reported and personnel were trained in the proper procedures for conducting preventive maintenance checks and services (PMCS) and in accordance with the appropriate references.

**Performance Steps**

1. Direct preventive maintenance checks and services.
  - a. Verify that all current and updated technical manuals and references are available or requisitioned for unit assigned equipment.
  - b. Verify that all tools, POL, personnel and other resources are available for PMCS.
  - c. Observe operators performing PMCS at prescribed intervals.
  - d. Review maintenance forms and reporting procedures for accuracy

Skill Level 2

**Performance Steps**

and completeness.

2. Report maintenance status of assigned equipment.
  - a. Verify that the operator has correctly identified and corrected, or recorded, faults on DA Form 5988-E, *Equipment Inspection Maintenance Worksheet* or DA Form 2404, *Equipment Inspection and Maintenance Worksheet*.
  - b. Confirm that not mission capable (NMC) faults are corrected before dispatch.
3. Train personnel in the proper procedures for conducting PMCS.
  - a. Enforce the commander's training program for operators of assigned equipment.
  - b. Lead collective training.
  - c. Verify that all operators are licensed for their equipment.
  - d. Verify that squad leaders/section chiefs/team leaders train team members.

<b>Performance Measures</b>	<b>GO</b>	<b>NO GO</b>
1. Verified that all current and updated technical manuals and references were available or requisitioned for unit's assigned equipment.	—	—
2. Verified that all tools, POL, personnel, and other resources were available for PMCS.	—	—
3. Enforced standing operating procedures in accordance with AR 750-1 and local policy.	—	—
4. Reduced training distractions.	—	—
5. Checked operator's DA Form 346 to confirm that operators were licensed.	—	—
6. Observed operators performing PMCS at prescribed intervals.	—	—
7. Compared PMCS process to the PMCS table in the appropriate technical reference.	—	—
8. Reviewed maintenance forms and reporting procedures for accuracy and completeness.	—	—
9. Corrected technical and administrative deficiencies on the spot and provided feedback for the operator/crew on correct procedures.	—	—



**Evaluation Guidance:** Score the soldier GO if all performance measures are passed. Score the soldier NO GO if any performance measure is failed. If the soldier fails any performance measure, show what was done wrong and how to do it correctly.

**References**

**Required**

- AR 600-55
- AR 750-1
- DA Pam 738-750
- DA Pam 750-1
- DA Pam 750-35
- TM 9-243

**Related**



---

**101-92Y-0003**

**Enforce Compliance with Supply Discipline Procedures**

**Conditions:** Given the requirement to ensure compliance with Command Supply Discipline Program (CSDP) by using existing assets to avoid duplication or fragmentation of effort and stewardship of resources. Given AR 710-2, AR 735-5, and local unit standing operating procedures (SOP).

**Standards:** Enforced the CSDP in accordance with AR 710-2 and AR 735-5.

---

**Performance Steps**

1. Initiate CSDP in accordance with AR 710-2, appendix B, and AR 735-5, paragraph 11-1.
  - a. Define CSDP.
    - (1) A compilation of existing regulatory requirements.
    - (2) A mandatory program.
    - (3) A program designed to simplify command, supervisory, and managerial responsibilities.
  - b. Develop CSDP to implement in unit.
    - (1) Provide the personal interest necessary to establish an effective CSDP.
    - (2) Identify the appropriate CSDP requirements listing from AR 710-2, appendix B.
    - (3) Review the requirements listing within the CSDP to become familiar with applicable regulatory requirements.

**Performance Steps**

- (4) Make adjustments to the requirements listing as dictated by the unit unique requirements/missions.
- (5) Incorporate local SOP requirements into the CSDP.
- c. Obtain parent-level inspection checklists.
  - d. Obtain parent-level evaluation schedule for your unit.
  - e. Report to the immediate higher headquarters any applicable requirements within the requirements listing or checklists that cannot be completed.
2. Execute the CSDP in accordance with AR 710-2 and AR 735-5.
- a. Perform routine duties using the CSDP.
  - b. Review past evaluations conducted by higher headquarters to determine if any discrepancies have not been corrected.
  - c. Perform general regulatory requirements.
  - d. Check property authorization documents.
  - e. Check requesting and receiving supplies.
  - f. Check disposition of property.
  - g. Check property responsibility.
  - h. Check organizational clothing and individual equipment (OCIE) and personal clothing.
  - i. Check management of loads.
  - j. Check prescribed load list (PLL).
  - k. Check inventories.
  - l. Check adjustments for lost, damaged, or destroyed property.
  - m. Check storage.
  - n. Check petroleum management.
  - o. Perform automated system checks.
3. Maintain the CSDP in accordance with AR 710-2 and AR 735-5.
- a. Develop measures to enforce supply discipline.
    - (1) Continue command emphasis on supply discipline by unit leadership.
    - (2) Provide training to unit personnel on supply requirements, procedures, and methods.
    - (3) Take administrative measures to account for lost, damaged, or destroyed property.
    - (4) Take disciplinary measures to deter and/or correct fraud,

---

**Performance Steps**

---

waste, negligent damage, and/or loss of government property.

- b. Update SOP and CSDP to align with changing unit requirements.
- c. Submit to the commander any systemic problems that cannot be resolved.

---

**Evaluation Preparation:** This task can be evaluated during routine unit operations.

*Brief Soldier:* Inform soldier that the evaluation is measured on the ability to perform the listed performance measures.

Performance Measures	GO	NO GO
1. Initiated the CSDP.	___	___
a. Defined the CSDP.		
b. Developed the CSDP to implement in the unit.		
c. Obtained parent level inspection checklist.		
d. Obtained parent level evaluation schedule for the unit.		
e. Reported to the immediate higher headquarters any applicable requirements within the requirements listing or checklists that cannot be completed.		
2. Executed the CSDP.	___	___
a. Performed routine duties using the CSDP.		
b. Reviewed past evaluations conducted by higher headquarters to determine if discrepancies had not been corrected.		
c. Performed general regulatory requirements.		
d. Checked property authorization documents.		
e. Checked requesting and receiving supplies.		
f. Checked disposition of property.		
g. Checked property responsibility.		
h. Checked OCIE and personal clothing.		
i. Checked management of loads.		
j. Checked PLL.		
k. Checked inventories.		
l. Checked adjustments for lost, damaged, or destroyed property.		

Skill Level 2

<b>Skill Level 2</b>	<b>Performance Measures</b>	<b>GO</b>	<b>NO GO</b>
	m. Checked storage.		
	n. Checked petroleum management.		
	o. Performed automated system checks.		
	3. Maintained the CSDP.	---	---
	a. Developed measures to enforce supply discipline.		
	b. Updated SOP and CSDP to align with changing unit requirements.		
	c. Submitted systemic problems that could not be resolved to the commander for resolution.		

**Evaluation Guidance:** Score the soldier GO if all performance measures are passed. Score the soldier NO GO if any performance measure is failed. If the soldier fails any performance measure, show what was done wrong and how to do it correctly.

**References**

**Required**

AR 710-2  
AR 735-5

**Related**

---

**101-92Y-0004**

**Enforce Property Accountability Policies**

**Conditions:** Given the requirement to enforce property accountability policies. Given the appropriate supply documentation; and appropriate publications and forms.

**Standards:** Ensured all property was accounted for in accordance with AR 25-400-2, AR 710-2, AR 735-5, DA Pam 25-30, and DA Pam 710-2-1.

**Performance Steps**

1. Review hand receipt/sub-hand receipts, temporary hand receipts, inventory list, and equipment receipts for accuracy in accordance with DA Pam 710-2-1.
  - a. Review manual hand receipt procedures.
    - (1) Review DA Form 2062, *Hand Receipt/Annex Number*, used as a hand receipt/sub-hand receipt.
      - (a) Verify change of primary hand receipt holder inventory was conducted and recorded.

3-140

101-92Y-0004

Skill Level 2

---

**Performance Steps**

---

- (b) Verify hand receipt holders are still assigned to unit.
  - (c) Verify all authorized equipment is listed on hand receipt.
  - (d) Determine if all authorized equipment is on hand or on request.
  - (e) Verify that all publication data is recorded in the item description block.
  - (f) Verify shortage annexes are on hand for shortages as a result of an inventory.
  - (g) Determine if the document number(s) are recorded on shortage annexes for due-ins.
  - (h) Verify component hand receipts are being used when required.
  - (i) Verify installation and organization property is not issued on the same hand receipt.
  - (j) Verify if change documents are on hand for transactions and adjustment documents.
  - (k) Determine if the hand receipt is being updated at least every six months based on the date of oldest change document.
  - (l) Verify that change documents for hand receipts are being destroyed after being posted.
  - (m) Verify items issued on component hand receipts are issued to the intended user.
  - (n) Determine if the unit is using temporary hand receipt procedures when issuing equipment for less than thirty days.
  - (o) Verify hand receipt is placed in the appropriate unit supply title.
- (2) Review DA Form 2062 used as component hand receipt.
- (a) Verify component hand receipt holder is still assigned to unit.
  - (b) Verify items issued on component hand receipt are being issued to intended user.
  - (c) Verify shortages are annotated on component hand receipt.
  - (d) Verify all authorized equipment is listed on component hand receipt.
  - (e) Verify all authorized equipment is on hand or on request.
- 

Skill Level 2

**Performance Steps**

- (f) Verify the document number(s) are recorded on component hand receipt to show due-ins.
- (g) Verify end item stock number is entered.
- (h) Verify end item description is entered.
- (i) Verify recorded publication data is correct.
- (j) Verify the quantity of end item is correct.
- (k) Verify change documents are on hand for transactions affecting the component hand receipt on hand balance.
- (l) Verify the component hand receipt is being updated at least every six months based on the date of oldest change document.
- (m) Verify that change documents for component hand receipts are destroyed after being posted.
- (n) Verify component hand receipts are placed in appropriate unit supply file.
- (o) Confirm signature, rank, and date.
- (3) Review DA Form 2062 used as a hand receipt annex.
  - (a) Verify the hand receipt/sub-hand receipt has a shortage annex annotated with any shortages that exist.
  - (b) Verify hand receipt holders are still assigned to unit.
  - (c) Verify that all shortages are listed on the shortage annex.
  - (d) Verify publication data is recorded in the item description block.
  - (e) Verify there is a valid due-in for all shortages on shortage annex.
  - (f) Verify the document number(s) are recorded on shortage annex for due-ins.
  - (g) Verify end item stock number is entered.
  - (h) Verify end item description is entered.
  - (i) Verify recorded publication data is correct.
  - (j) Verify the quantity of end item is correct.
  - (k) Verify item description of existing shortages.
  - (l) Verify change documents are on hand for transactions affecting the shortage annex.
  - (m) Verify the shortage annexes are updated at least every six months when hand receipts are updated.

---

**Performance Steps**

---

- (n) Verify person filling the position identified in the "From" block of DA Form 2062 is initialing shortages .
  - (o) Verify change documents are on hand for all transactions.
  - (p) Verify that change documents for shortage annexes are destroyed after being posted.
  - (q) Verify shortage annex is placed in the appropriate unit supply file.
  - (4) Review DA Form 2062 used as an inventory list.
    - (a) Verify unit is using the inventory list to account for property when assigning responsibility is impractical.
    - (b) Verify copy of inventory list is kept in area where the property is located and placed where it can be seen easily.
    - (c) Verify inventory of property is being conducted and recorded at least semi-annually.
    - (d) Verify unit SOP has instructions for using inventory list procedures.
    - (e) Ensure DA Form 2062 is filled out in accordance with DA Pam 710-2-1.
  - (5) Review DA Form 3749, equipment receipt used as a hand receipt.
    - (a) Verify equipment receipt is used to issue individual equipment to the same person for brief recurring periods.
    - (b) Ensure DA Form 3749 is filled out properly in accordance with DA Pam 710-2-1.
    - (c) Verify an equipment receipt is prepared for each soldier authorized to receipt property.
    - (d) Verify that equipment receipts are prepared and maintained correctly.
  - (6) Review DA Form 3161, *Request for Issue or Turn-In*, used as a temporary hand receipt.
    - (a) Determine if unit hand receipt holders are loaning equipment to another unit without approval of PBO.
    - (b) Verify temporary hand receipts are only used to loan equipment for thirty calendar days or less.
    - (c) Verify the original copy of temporary hand receipt is on hand.
- 

Skill Level 2

**Performance Steps**

- (d) Verify temporary hand receipts are being filed in date sequence.
  - (e) Ensure DA Form 3161 is filled out properly.
  - (f) Verify the temporary hand receipt file is being reviewed daily.
  - (g) Verify temporary hand receipts are destroyed upon return of property.
- b. Review automated hand receipts.**
- (1) Review Standard Property Book System-Redesigned (SPBS-R) hand receipt/property list.
    - (a) Verify the change of primary hand receipt holder inventory was conducted and recorded.
    - (b) Verify the signed copy of hand receipt is current.
    - (c) Verify all authorized equipment is listed on hand receipt.
    - (d) Verify all authorized equipment is on hand or on request.
    - (e) Verify shortage annexes are on hand for shortages as a result of an inventory.
    - (f) Verify the document number(s) are recorded on shortage annex for due-ins.
    - (g) Verify person filling the position identified in the "From" block of DA Form 2062 is initialing shortages.
    - (h) Verify component hand receipts are being used when required.
    - (i) Verify change documents are on hand for transactions and adjustment documents.
    - (j) Verify changes are being posted to work copy of hand receipts.
    - (k) Verify work copy against monthly hand receipt/property list for accuracy.
    - (l) Verify change documents are destroyed after posting to hand receipt.
    - (m) Determine if the SPBS-R monthly update is being downloaded to ULLS-S4.
    - (n) Verify cyclic and sensitive items inventories are being conducted and recorded.
    - (o) Determine if distribution instructions are on hand or have been requested for excess equipment.



---

**Performance Steps**

---

- (p) Verify hand receipt is placed in the appropriate unit supply file.
- (2) Review ULLS-S4 automated hand receipt.
- (a) Review property origin record.
- (b) Verify SPBS-R download is being performed to update primary hand receipt.
- (c) Determine if there is an imbalance report for equipment not assigned on the sub-hand receipt.
- (d) Verify all entries of the automated hand receipt are accurate.
2. Review posting of change documents and adjustment documents to hand receipt/sub-hand receipts in accordance with AR 710-2, DA Pam 710-2-1, and ULLS-S4 EM.
- a. Review manual, SPBS-R, and ULLS-S4 hand receipt procedures.
- (1) Determine if change documents are being maintained with hand receipt/sub-hand receipts.
- (2) Verify change documents are posted to hand receipt/sub-hand receipts prior to change of hand receipt/sub-hand receipt holder inventory.
- (3) Verify installation and organization equipment is not issued on same change document.
- (4) Verify change documents are posted to hand receipt/sub-hand receipt at least every six months.
- (5) Verify information being posted to hand receipt/sub-hand receipts is accurate.
- (a) Verify the quantity of item being posted to sub-hand receipt.
- (b) Verify national stock number of item being posted to hand receipt/sub-hand receipt.
- (c) Verify line item number of item being posted to hand receipt/sub-hand receipt.
- (d) Verify serial number of item being posted to hand receipt/sub-hand if required.
- (e) Verify the nomenclature of item being posted to hand receipt/sub-hand receipt.
- (f) Verify unit of issue of item being posted to hand receipt/sub-hand receipt.
- 

Skill Level 2

**Performance Steps**

- (g) Verify size of item being posted to hand receipt/sub-hand receipt if required.
- (6) Verify change documents are destroyed when hand receipt/sub-hand receipts are updated.
- (7) Verify hand receipts/sub-hand receipts are placed in the appropriate unit supply files.
- b. Review hand receipt filing procedures .
3. Prepare for inventory in accordance with DA Pam 710-2-1, chapter 9.
- a. Check with the commander for any special instructions.
- b. Verify that the current DA Pam 25-30 is used to conduct the inventory.
- c. Verify availability of facilities for laying out equipment.
- d. Verify the date, time, and location of inventory with all hand receipt holders.
- e. Identify personnel that will be assisting with the inventory.
- f. Notify the sub-hand receipt holders of when, where, and how the inventory will be conducted.
- g. Ensure hand receipt holders are in the unit that is assigned the property.
- h. Ensure all hand or subhand receipts and annexes with change documents are posted prior to inventory.
4. Conduct a physical inventory in accordance with DA Pam 710-2-1, chapter 9.
- a. Follow the commander's special instructions.
- b. Compare authorization documents, modified table of allowances (MTOE), table of distribution and allowances (TDA), or joint table of allowance (JTA) with the hand receipts.
- c. Review DA Pam 25-30, to ensure that the most current publications are used to conduct the inventory.
- d. Ensure the quantity agrees with quantity recorded on the hand receipt document.
- e. Ensure the items being inventoried belong to the unit.
- f. Visually count and verify serial numbers of each item being inventoried.
- g. Check the serial number when an item has a serial number.
- h. Check end item for completeness using the proper technical manual or supply catalog.

---

**Performance Steps**

---

- i. Make visual check of the condition of the item.
  - j. Validate maintenance and laundry requests.
  - k. Report discrepancies to the commander.
5. Perform post inventory procedures in accordance with DA Pam 710-2-1, chapter 9.
- a. Compare inventory results with authorization documents, hand receipts, property listings, or component listings to verify shortages.
  - b. Inform commander of inventory results.
  - c. Cross level and report excess property to accountable officer.
  - d. Prepare adjustment document(s) if required.
  - e. Process any adjustment document(s) as a result of inventory.
  - f. Ensure all hand receipts, property listings, or component listings, as required, are available.
- Note:** Upon completing a change of command inventory, the incoming and outgoing commanders will meet with the PBO for the change of property responsibility.
- g. Prepare a memorandum with results of inventory between outgoing and incoming commander, if required.
  - h. Provide a copy of memorandum of inventory results to higher headquarters, if required.
  - i. Place the inventory documents in the property record inspection and inventory report file, 710-2d.
  - j. Place copies of all adjustment documents in property book and supporting documents file, 710-2a.
  - k. File the inventory results in accordance with AR 25-400-2, appendix B.
  - l. Turn in overages as "found on installation property."
6. Verify the accuracy of adjustment documents in accordance with AR 735-5 and DA Pam 710-2-1.
- a. Review the DA Form 4697, *Report of Survey*, that is being processed.
    - (1) Verify that all entries on front (blocks 1 through 20) are completed.
    - (2) Verify accountable officer signature and document number is obtained.
    - (3) Verify the higher headquarters has assigned a survey number.
- 

Skill Level 2

**Performance Steps**

- (4) Verify adjustment(s) that are made to hand receipt/sub-hand receipt as applicable.
- (5) Verify a copy of DA Form 4697 is in the appropriate unit supply file in accordance with AR 25-400-2.
- (6) Verify that a memorandum of summary was prepared for the appointing/approving authority.
- (7) Determine if surveys are being forwarded to the approving authority in a timely manner.
- (8) Ensure that a survey officer has been appointed on orders.
- (9) Verify the survey officer has been provided a copy of DA Pam 735-5.
- (10) Verify the fair market value or depreciation value is being allowed.
- (11) Verify that surveys are being sent to Judge Advocate Generals (JAG) office for legal review.
- (12) Check to see if the survey officer's findings and recommendations are being reviewed prior to being presented to appointing/approving authority.
- (13) Verify that replacement item(s) were requested through supply channels.
- (14) Verify accountability of property was reestablished, if required.
- b. Review the DD Form 362, *Statement of Charges/Cash Collection Voucher*.**
- (1) Check the date prepared.
- (2) Verify all entries for correctness.
- (3) Obtain accountable officer's signature and document number.
- (4) Verify adjustment(s) that are made to hand receipt/sub-hand receipts as applicable.
- (5) Place copy of DD Form 362 in the appropriate unit supply file and dispose of in accordance with AR 25-400-2.
- (6) Verify replacement items were requested through supply channels.
- c. Review DA Form 4949, *Administrative Adjustment Report*.**
- (1) Check the date prepared.
- (2) Verify that all entries are correct.
- (3) Verify change of account requirements.

Skill Level 2

**Performance Steps**

- (4) Verify accountable officer has signed and annotated a document number.
- (5) Verify hand receipts/sub-hand receipts have been adjusted for all changes.
- (6) Verify a copy of DA Form 4949 is in the appropriate unit supply file in accordance with AR 25-400-2.
- 7. Complete final disposition of an adjustment document to obtain relief from responsibility for property in accordance with AR 735-5 and DA Pam 710-2-1.
  - a. Verify that final action was completed, as required, by the approving authority.
  - b. Verify that the individual(s) is notified of his or her rights regarding financial liability charges.
  - c. Verify that Finance has processed financial liability against the individual being charged.
  - d. Ensure the property book officer is provided a completed copy of final action on adjustment documents.
  - e. Remove suspense copy from unit suspense file, and file the approved copy in document support file in accordance with AR 25-400-2 and DA Pam 710-2-1.

Performance Measures	GO	NO GO
1. Reviewed hand receipt/sub-hand receipts, temporary hand receipts, inventory list, and equipment receipts for accuracy in accordance with DA Pam 710-2-1.	—	—
a. Reviewed manual hand receipt procedures.		
b. Reviewed automated hand receipts.		
2. Reviewed posting of change documents and adjustment documents to hand receipt/sub-hand receipts in accordance with AR 710-2, DA Pam 710-2-1, and ULLS-S4 EM.	—	—
a. Reviewed manual, SPBS-R, and ULLS-S4 hand receipt procedures.		
b. Reviewed hand receipt filing procedures.		
3. Prepared for inventory in accordance with DA Pam 710-2-1, chapter 9.	—	—

<b>Skill Level 2</b>	<b>Performance Measures</b>	<b>GO</b>	<b>NO GO</b>
	a. Checked with the commander for any special instructions.		
	b. Verified that the current DA Pam 25-30 was used to conduct the inventory.		
	c. Verified availability of facilities for laying out equipment.		
	d. Verified the date, time, and location of inventory with all hand receipt holders.		
	e. Identified personnel who would assist with the inventory.		
	f. Notified the sub-hand receipt holders of when, where, and how the inventory would be conducted.		
	g. Ensured hand receipt holders were in the unit that was assigned the property.		
	h. Made sure all hand or sub-hand receipts and annexes with change documents were posted to inventory.		
	<b>4. Conducted a physical inventory in accordance with DA Pam 710-2-1, chapter 9.</b>	—	—
	a. Followed the commander's special instructions.		
	b. Compared authorization documents, MTOE, TDA, or JTA with the hand receipts.		
	c. Reviewed DA Pam 25-30, to ensure that the most current publications were used to conduct the inventory.		
	d. Made sure the quantity agreed with quantity recorded on the hand receipt document.		
	e. Made sure the items being inventoried belong to the unit.		
	f. Visually counted and verified serial numbers of each item being inventoried.		
	g. Checked the serial number when an item had a serial number.		
	h. Checked end item for completeness using the proper technical manual or supply catalog.		
	i. Made visual check of the condition of the items.		
	j. Validated maintenance and laundry requests.		

Performance Measures	GO	NO GO
k. Reported discrepancies to the commander.		
5. Performed post inventory procedures in accordance with DA Pam 710-2-1, chapter 9.	—	—
a. Compared inventory results with authorization documents, hand receipts, property listings or component listings to verify shortages.		
b. Informed commander of inventory results.		
c. Cross leveled and reported excess property to accountable officer.		
d. Prepared adjustment document(s) if required.		
e. Processed any adjustment document(s) as a result of inventory.		
f. Ensured all hand receipts, property listings, or component listings, as required, were available.		
g. Ensured, upon completing a change of command inventory, the incoming and outgoing commander met with the PBO for the change of property responsibility.		
h. Prepared a memorandum with results of inventory between outgoing and incoming commander, if required.		
i. Provided a copy of memorandum of inventory results to higher headquarters, if required.		
j. Placed the inventory documents in the property record inspection and inventory report file, 710-2d.		
k. Placed copies of all adjustment documents in property book and supporting documents file, 710-2a.		
l. Filed the inventory results in accordance with AR 25-400-2, appendix B.		
m. Turned in overages as "found on installations property."		
6. Verified the accuracy of adjustment documents in accordance with AR 735-5 and DA PAM 710-2-1.	—	—
a. Reviewed the DA Form 4697, <i>Report of Survey</i> , that was being processed.		
b. Reviewed the DD Form 362, <i>Statement of Charges/Cash Collection Voucher</i> .		

Skill Level 2

<b>Skill Level 2</b>	<b>Performance Measures</b>	<b>GO</b>	<b>NO GO</b>
	c. Reviewed DA Form 4949, <i>Administrative Adjustment Report</i> .		
	7. Completed final disposition of an adjustment document to obtain relief from responsibility for property in accordance with AR 735-5 and DA Pam 710-2-1.	—	—
	a. Verified that final action was completed, as required, by the approving authority.		
	b. Verified that the individual(s) was notified of his or her rights regarding financial liability charges.		
	c. Verified that finance had processed financial liability against the individual charged.		
	d. Ensured the property book officer was provided a completed copy of final action on adjustment documents.		
	e. Removed suspense copy from unit suspense file, and filed the approved copy in document support file in accordance with AR 25-400-2 and DA Pam 710-2-1.		

**References**

**Required**

- AR 25-400-2
- AR 710-2
- AR 735-5
- DA Pam 25-30
- DA Pam 710-2-1

**Related**

---

**101-92Y-0005**

**Enforce Compliance with Property Accountability Policies**

**Conditions:** Given the property records, blank forms, appropriate supply publications, and the requirement to provide proper guidance and direction to subordinate unit personnel; ensure the security of all property of the command, whether in use or in storage; observe subordinates to ensure their activities contribute to the proper custody, care, use and safekeeping of all property within the command; enforce all security, safety, and accounting requirements; take administrative or disciplinary measures when necessary.

**Standards:** Enforced property administration in units and maintained property accountability in accordance with Army and DOD Regulations.

3-152

101-92Y-0005

Skill Level 2



---

**Performance Steps**

---

1. Determine the requirements to manage property administration.
  - a. Review the guidance to manage property administration in units in accordance with AR 710-2.
    - (1) Forward requests through command channels when regulatory guidance is not clear.
    - (2) Process deviation for supply policy requiring HQDA approval to Commander, U.S. Army Logistics Evaluation Agency, ATTN: LOEA-OS, New Cumberland, PA 17070-5007.
    - (3) Identify and report supply constraints to higher headquarters.
    - (4) Implement the Hazardous Materials Management Program.
  - b. Review administrative procedures as outlined in DA Pam 710-2 and local SOP to manage property administration.
2. Establish property administration in a unit.
  - a. Ensure personnel use the correct property authorization documents.
    - (1) Verify all pertinent property authorization documents (such as MTOE, TDA) are on hand.
    - (2) Verify all items that require property book accounting are on the property book.
    - (3) Ensure hand receipts are reconciled with the authorization allowances.
    - (4) Verify that the property book officer (PBO) accounts for organization and installation property separately.
    - (5) Verify commander or head of separate activity for which the property book is maintained appoints the PBO.
  - b. Ensure personnel maintain the automated property listings.
    - (1) Verify the automated hand receipt, ALV-151 is on hand to show acceptance of, and responsibility for, assigned property.
    - (2) Verify the hand receipt accuracy.
    - (3) Determine if assistance is needed by the commander to conduct required inventories by verifying accuracy of listings.
    - (4) Verify the preparation and maintenance of hand receipt procedures.
  - c. Ensure personnel prepare and maintain hand receipts using correct procedures.
    - (1) Verify that sub-hand receipt holders accept direct responsibility for property by signing a hand receipt.
    - (2) Verify that equipment is issued on hand receipt/sub-hand receipt.

Skill Level 2

**Performance Steps**

(3) Verify change documents are posted to hand/sub-hand receipt at least six months from the oldest change document.

(4) Verify temporary hand receipt properties are issued for less than 30 calendar days.

(5) Verify property issued for more than 30 calendar days are issued on a permanent hand receipt.

(6) Verify inventory listings are used when assigning individual responsibility is not practical.

(7) Verify that components of sets, kits, and outfits (SKOs) are controlled.

(8) Verify hand receipt shortage annexes are prepared when component shortages exist.

(9) Verify hand receipts are filed in appropriate unit supply files.

d. Ensure procedures for request and receipt of supplies and logistical services are followed.

(1) Verify that all authorized property, components and basic loads are on hand or on request.

(2) Verify commander or designated representative review all requests having an Urgency of Need designator "A" and "B" for priority abuse.

(3) Verify the use of end item codes (EIC) for requesting repair parts.

(4) Verify that requests for recoverables are preceded by a turn-in of an unserviceable like item.

(5) Verify the establishment and maintenance of document registers within the unit.

(6) Verify controls are in place to account for all VISA IMPAC purchases.

(7) Verify command requirement procedures are followed when a unit member is appointed as an ordering/contracting officer.

(8) Verify requests for DRMO property are processed through Supply Support Activity (SSA).

(9) Verify that delegation of authority documents are prepared to receipt for supplies and equipment.

(10) Report all discrepancies when supplies and equipment are received.

(11) Verify that document modifiers are submitted when a change is required.

---

**Performance Steps**

---

**(12)** Verify cancellation requests are submitted when requested items are no longer needed.

**(13)** Monitor the hazardous material program and provide guidance on the availability of materials.

**e.** Ensure supply personnel comply with policies in issuing, storing, turning in supplies and equipment.

**(1)** Issuing.

**(a)** Verify all property is issued and hand receipt accountability is maintained

**(b)** Verify hand receipts are used when property book or durable items are issued.

**(2)** Storage.

**(a)** Verify that adequate facilities and space is available for hand receipt holders to store the different classes of supplies.

**(b)** Verify that storage facilities meet physical security requirements to prevent loss.

**(c)** Verify that storage facilities meet the Occupational Safety and Health Administration (OSHA) Guidelines and local SOP.

**(d)** Verify that adequate material handling equipment (MHE) is on hand.

**(e)** Verify that storage facilities are properly marked with appropriate identifying symbols.

**(f)** Verify that materials are inspected and kept ready for use.

**(3)** Turn-ins.

**(a)** Verify that transferred property meets accountability and maintenance requirements.

**(b)** Verify turn-in action of excess property and associated components are initiated within 10 calendar days after effective date of authorization document change.

**(c)** Verify turn-in of unserviceable and not repairable property book items through the PBO.

**(d)** Verify the custodian handles the turn-in of unserviceable communication security (COMSEC) equipment.

**(e)** Verify turn-in of unserviceable repairable to supporting SSA.

**(f)** Validate component shortages of property for turn-in.

**(g)** Items "found on installation" that are not on accountable records must be turned in through PBO.

---

Skill Level 2

**Performance Steps**

- (h) Verify turn-in of residue and unexpended ammunition after completion of training.
- (i) Verify ammunition that is found is turned-in to the amnesty program.
- (j) Verify excess hazardous materials are turned-in to SSA.
- f. Establish and maintain document registers.
  - (1) Manual.
    - (a) Verify PBO has designated, by informal memorandum, those elements authorized to request expendable and durable supplies.
    - (b) Verify an informal memorandum, that specifies class of supply, Department of Defense Activity Address Code (DODAAC) and block of document serial numbers to be used by element is on hand.
    - (c) Verify document registers are prepared and maintained correctly.
    - (d) Verify supply status, status cards and/or listings are maintained for supplies due-in.
    - (e) Verify all transactions, such as cancellation, follow-up, modification, and receipt data is posted to document register.
    - (f) Verify document register is closed out and filed correctly.
  - (2) Automated.
    - (a) Verify PBO has designated, by informal memorandum those elements authorized to request expendable and durable supplies.
    - (b) Verify an informal memorandum that specifies class of supply, DODAAC and block of document serial numbers to be used by element is on hand.
    - (c) Verify document number parameter is set for classes of supply.
    - (d) Verify active and inactive document/transaction history listings are maintained correctly.
- g. Conduct reconciliation procedures with supply support activity.
  - (1) Verify reconciliation is accomplished on a monthly basis or in accordance with local standing operating procedures.
  - (2) Verify copy of reconciliation is on file.
- h. Establish supply and equipment inventory control functions.
  - (1) Verify elements that impact on acquisition, allocation, and disposal of materiel.
  - (2) Verify joint change of primary hand receipt holder is conducted.

---

**Performance Steps**

---

- (3) Verify all unit property is inventoried annually.
- (4) Verify inventory is conducted prior to receipt or turn-in of property.
- (5) Verify a change of custody of arms storage facility is conducted with results recorded on a hand receipt.
- (6) Verify sensitive item inventories are conducted and recorded.
- (7) Verify weapons and ammunition inventories are conducted and recorded.
- (8) Verify unit loads, basic loads, and operational loads are inventoried to verify authorized stockage levels.
- (9) Verify authorized stockage of the prescribed load list (PLL) is on hand or on request.
- (10) Verify inventories of OCIE is conducted:
  - (a) Soldiers departing or newly assigned.
  - (b) Soldiers placed on AWOL status, hospitalized, or emergency leave.
  - (c) Soldiers returning from a field exercise.
- i. Establish and maintain supply files.
  - (1) Verify unit files are on hand and maintained.
  - (2) Verify files are disposed of in accordance with AR 25-400-2.
- j. Supervise unit budget operations.
  - (1) Verify that qualified individuals are available to operate the Unit Level Logistics System S4 (ULLS-S4).
  - (2) Verify that the ULLS-S4 EM is on hand.
  - (3) Verify that security accesses for ULLS-S4 have been established.
  - (4) Verify that ULLS-S4 Parameter Files are established.
  - (5) Verify that property origin records have been established.
  - (6) Verify that Continuity Operation Procedures (COOP) for ULLS-S4 is being performed.
- 3. Maintain property administration in a unit by applying the Command Supply Discipline Program procedures.
  - a. Administrative action.
    - (1) Review the last evaluation to determine if past discrepancies were resolved.
    - (2) Establish suspense dates for corrective actions.
    - (3) Correct all findings using regulatory guidance.

Skill Level 2

**Performance Steps**

- (4) Brief commander on the findings at the completion of the evaluation.
- (5) Evaluate the supply operations by using command inspection checklist.
- (6) Determine if any discrepancies are repeat findings.
- (7) File evaluation results in the appropriate unit supply files.
- b. Train personnel.
  - (1) Verify that school trained supply personnel are assigned and working in their assigned positions.
  - (2) Conduct military occupational skill (MOS) training classes to validate skills.
  - (3) Recommend professional development through enrollment in Army correspondence courses.
- c. Re-inspect areas.
  - (1) Review the last evaluation and correct discrepancies found.
  - (2) Inform commander that corrective action has been taken.
  - (3) Forward results of corrective action to higher headquarters.
  - (4) Determine if any discrepancies are repeat findings.
  - (5) File evaluation results in the appropriate unit supply files.
- 4. Store Class I meal ready to eat (MRE) in accordance with DOD Regulation 4145.19.R-1 change 5, section V.
  - a. Prepare to store supplies.
    - (1) Review storage area layout to determine best location for storage.
    - (2) Verify storage area is clean and dry.
    - (3) Verify storage area is properly ventilated.
    - (4) Verify storage area temperature remains constant (between 70 and 80 degrees Fahrenheit).
    - (5) Verify the storage area can be secured.
    - (6) Obtain necessary supplies or equipment to store Class 1 MREs.
  - b. Store MREs using indoor/covered storage.
    - (1) Place wooden pallets on floor/ground.
    - (2) Stack MREs on the wooden pallets, leaving a space between each case (cross-stacking).
    - (3) Place each lot on a separate pallet using the cross-stacking method.

---

**Performance Steps**

---

- (4) Stack oldest date packs in front.
  - (5) Mark the lots and place the cases of MREs on the pallet where the date of the pack can be seen (location placard).
  - (6) Do not stack MREs near the ceiling or heater pipes where temperature is high.
  - c. Apply precautionary measures to avoid loss or damage to supplies.
    - (1) Place a fire extinguisher in the storage area.
    - (2) Place a mousetrap on each corner of the storage area. Report any signs of insect or rodent infestation to proper authority.
    - (3) Check MREs periodically for pilferage, spoilage, and lot expiration date.
  - 5. Store Class II expendable supplies in accordance with DOD Regulation 4145.19-R-1 chapter 3, section 3.
    - a. Prepare to store supplies.
      - (1) Review storage area layout to determine where items are to be stored.
      - (2) Verify the area is clean and dry.
      - (3) Verify that the area is well ventilated.
      - (4) Obtain necessary supplies and equipment needed to store Class II expendable supplies.
    - b. Store Class II expendable supplies.
      - (1) Store supplies most often requested in an easy to reach place.
      - (2) Store housekeeping supplies such as soap and toilet paper beneath issue counter.
      - (3) Store housekeeping supplies such as brooms in tool room or closet.
      - (4) Store nonflammable weapon maintenance materials such as rifle patches and repair parts in the arms room.
      - (5) Store other unit expendable supplies in designated areas using shelving, drawers, cabinets, or bins.
    - c. Apply precautionary measures to avoid loss or damage to supplies.
      - (1) Place a fire extinguisher in the storage area.
      - (2) Report any sign of insect or rodent infestation to proper authority.
      - (3) Check expendable supplies periodically to prevent waste and pilferage.
- 

Skill Level 2

**Performance Steps**

**6.** Store Class IIIP petroleum products in accordance with DOD Regulation 4145.19-R-1 chapter 5, section 7.

**a.** Prepare to store supplies.

**(1)** Store packaged fuels, lubricants, and greases in an area designated for storage of these items.

**(2)** Store in a building only if adequate dispersion and ventilation are obtained and the building meets the requirements of the current flammable liquid code.

**(3)** Place all packaged fuels, lubricants, and greases in a covered storage area, when possible.

**b.** Store Class IIIP petroleum products.

**(1)** Store the maximum quantity of products in limited space while maintaining fire control and providing ease and safety in handling.

**(2)** Store cans using the pyramidal stacking or vertical stacking methods.

**(3)** Stack cans on wooden pallets, at unit and organizational level using one or both methods, pyramidal or vertical.

**(4)** Verify that no containers are leaking.

**(5)** Store container with date of pack clearly in view.

**c.** Apply precautionary measures to avoid loss or damage to supplies or environment.

**(1)** Verify that package fuel does not drain into rivers or sewage systems.

**(2)** Verify uncased container exteriors are free of grease and oil before being placed in storage.

**(3)** Inspect stacks periodically for evidence of leakage, abnormal swelling or corrosion of containers, for stability of stacks, and to verify that product markings are legible.

**(4)** Place a fire extinguisher in the storage area.

**7.** Store Class IV expendable supplies in accordance with DOD Regulation 4145.19-R-1 chapter 5, section 5.

**a.** Prepare to store supplies.

**(1)** Store Class IV expendables in a covered storage area, when possible.

**(2)** Verify that the area is clean and dry.

**(3)** Verify that the area is well ventilated.

**(4)** Obtain dunnage and place in storage area, if needed.



---

**Performance Steps**

---

- (5) Store in an easily accessible location.
- b. Apply precautionary measures to avoid loss or damage to supplies.
  - (1) Inspect periodically to prevent waste, pilferage, or loss due to dry rot or mildew.
  - (2) Rotate stocks when appropriate.
  - (3) Place a fire extinguisher in the storage area.
- 8. Store Class V ammunition in the unit arms room, in accordance with AR 190-11 and DOD Regulation 4145.19-R-1.
  - a. Prepare to store supplies.
    - (1) Verify the storage room can be secured.
    - (2) Verify an unaccompanied "access control register" is posted on the outside of the door, in accordance with AR 190-11, chapter 4, paragraph 4-19.
    - (3) Affix signs announcing the presence of Intrusion Detection System (IDS) at eye level when applicable.
    - (4) Place a "RESTRICTED AREA" sign easily visible to people approaching the area.
    - (5) Place a "NO SMOKING" sign outside the door.
    - (6) Place a "FIRE SYMBOL #4" outside the storage room or building.
  - b. Place the ammunition on pallets.
    - (1) Separate by lot numbers.
    - (2) Arrange so free circulation of air beneath and throughout the stack is possible.
    - (3) Verify the stacks of ammunition are not closer than 18 inches from the roof and 3 inches off the floor.
    - (4) Level the dunnage (if required).
  - c. Apply precautionary measures to avoid loss or damage to supplies.
    - (1) Verify the boxes, cases, and other containers of ammunition are clean and dry before being stored.
    - (2) Verify that all cases are sealed.
    - (3) Position fire extinguishers within the distance prescribed for the type Class V ammunition/explosives stored.
- 9. Store paints, cylinders, and flammable supplies in accordance with DOD Regulation 4145.19-R-1, paragraph 5-404.
  - a. Prepare to store paint and flammable supplies in a covered storage area designated for "FLAMMABLE STORAGE."

Skill Level 2

**Performance Steps**

- (1) Place the total quantities of each within the storage area.
  - (2) Pallets or dunnage will be used to segregate containers in piles.
  - (3) Storage arrangements will comply with DOD Regulation 4145.19-R-1, table 5-5.
- b.** Prepare to store compressed gases (used for welding).
- (1) Identify cylinders by color code of noun in accordance with MIL STD-101.
  - (2) Tag or label all filled cylinders with stock numbers. One for the type gas and one for the cylinder.
  - (3) Tag empty cylinder with "MT" to designate "empty".
- c.** Comply with handling procedures for movement of cylinders.
- (1) Move cylinders by using a suitable hand truck.
  - (2) Move cylinders by tilting and rolling when suitable hand trucks are not available.
  - (3) Do not lift cylinder by the valve protection cap.
  - (4) Do not lift cylinder by the cranes or mechanical lifts unless fastened in proper containers, racks, and cradles.
  - (5) Do not lift cylinder with rope, chain slings, or electromagnets.
  - (6) Do not use cylinder as a roller, support or for any purpose other than for containing compressed gases.
- d.** Apply precautionary measures to avoid damage or loss to supplies.
- (1) Do not use open flame devices in the flammable storage area. No smoking rule will be rigidly enforced.
  - (2) Place fire extinguishers by required type in flammable storage area.
  - (3) Roll paint drums stored horizontally every 90 days.
- 10.** Determine method of obtaining relief from responsibility for "damaged property" in accordance with AR 735-5, paragraph 12-1c (5) and table 12-1.
- a.** Process a relief document for damaged organizational clothing and individual equipment (OCIE) when there is no negligence and item costs less than \$100 in accordance with AR 735-5, paragraph 14-25, b (2). Prepare a "damage memorandum" stating the cause of the damage for the unit commander's approval in accordance with AR 735-5, Paragraph 14-25.
- b.** Process a relief document for damaged property when there is no negligence and items cost less than \$200. Prepare a "damage memorandum" stating the cause of the damage for the unit commander's approval and attach it to the maintenance request or turn-in document.

---

**Performance Steps**

---

**c.** Process a relief document for damaged property when there is no negligence and the item costs more than \$200. Prepare a "damage memorandum" for the approving authority's designated representative; he will enter "concur" on the statement and include the signature of the approving authority or designated representative. In no case will the unit commander be a designated representative for reviewing damage statement when the cost for repair of the damage item is equal to or exceeds \$200.

**d.** Process a relief document for any item when a person admits liability and the amount is less than one month's pay, in accordance with AR 735-5 paragraph 14-25b (1). Prepare a statement of charges/cash collection voucher.

**e.** Process a relief document for any item when a person admits liability and the amount is less than one month's pay, in accordance with AR 735-5, paragraph 14-25, b (1) (b). Prepare and process a report of survey for the damaged property.

**f.** Process a relief document for any item when a person does not admit liability or negligence in accordance with AR 735-5, paragraph 13-2, a (1). Prepare and process a report of survey for the damaged property.

**11.** Determine method of relief from responsibility for "lost or destroyed property" in accordance with AR 735-5, chapter 12, paragraph 12-1, c (5), table 12-2; and AR 15-6, chapter 3 through 5; and AR 190-11, paragraph 2-9, page 5.

**a.** Process a relief document for any item (except sensitive items) when a person admits liability and the amount is less than one month's pay, in accordance with AR 735-5, paragraph 12-2c. Prepare a statement of charges/cash collection voucher.

**b.** Process a relief document for any lost or destroyed item that requires a Report of Survey (RS) or AR 15-6 investigation in accordance with AR 15-6, chapters 3 through 5.

**(1)** Prepare DA Form 4697 for sensitive items when an investigation is required under AR 15-6 for those items so designated in accordance with AR 190-11, appendix E.

**(2)** Prepare a DA Form 4697 when directed by higher authority or by DA directive in accordance with AR 735-5, chapter 13, paragraph 13-2 (8).

**(3)** Prepare a DA Form 4697 when the loss was discovered through inventory on a change of accountable officer and when individual does not make voluntary reimbursement to the government, in accordance with AR 735-5 paragraph 13-2, a (2).

---

Skill Level 2

**Performance Steps**

(4) Prepare a DA Form 4697 for household furnishings and damage of government family housing units when amount is more than one month's pay, in accordance with AR 735-5 paragraph 13-2, a (4).

(5) Prepare a DA Form 4697 for item when a person admits liability but the amount is more than one month's pay.

(6) Prepare a DA Form 4697 for item when negligence is suspected but person does not admit liability and when the person refuses to sign DD Form 362, in accordance with AR 735-5, table 12-2.

(7) Prepare a DA Form 4697 when bulk petroleum loss exceeds allowable loss and is over \$500 in accordance with AR 735-5 paragraph 13-2, a (5).

12. Determine method of obtaining relief from responsibility for "damaged, lost, or destroyed items under special situations" in accordance with AR 735-5, table 12-2; AR 710-2, paragraph 2-35, and AR 700-84, paragraph 5-4.

a. Process a relief document for bulk petroleum item when loss exceeds allowable loss and is less than \$500, in accordance with AR 735-5, paragraph 2-35.

(1) Perform causative research.

(2) File a copy of the report with the monthly bulk petroleum accounting summary report as a supporting document.

b. Process a relief document for hand tools authorized to a unit when liability is admitted in accordance with AR 735-5, paragraph 12-26. Prepare a DD Form 362.

c. Process a relief document for items lost in laundry in accordance with AR 735-5, table 12-2.

(1) Prepare DA Form 3078, *Personal Clothing Request*.

(2) Prepare a property issue slip listing the items lost.

(3) Prepare a monthly report of survey for all articles reissued or for credit given.

d. Process a DA Form 4697 for items lost resulting from fire, theft, or disaster in accordance with AR 735-5, table 12-19.

e. Process a memorandum for items destroyed because of infection. List items on the memorandum and identify the officer who directed destruction.

f. Process a memorandum for unsafe items due to age, (such as drugs, ammunition, parachutes, or chemicals) in accordance with AR 735-5, table 12-2.

(1) Prepare turn-in document in accordance with AR 710-2.

**Performance Steps**

(2) Use reference information on age published in Army supply bulletins or DA Form 4697.

g. Process a memorandum for abandoned items (such as combat contingency, or large scale field maneuvers) in accordance with AR 735-5, table 12-2. Prepare written orders to abandon, signed by the installation or division commander, to serve as a property adjustment voucher. If the commander declines to approve the order, prepare DA Form 4697.

h. Process a relief document for items abandoned for reasons of health, safety, expense, difficulty to maintain, or handling in accordance with AR 735-5, table 12-2. Submit an abandonment order to installation or division commander; then use it as a property adjustment voucher.

Skill Level 2

Performance Measures	GO	NO GO
1. Determined the requirements to manage property administration.	___	___
a. Reviewed guidance to manage property administration in units in accordance with AR 710-2.		
b. Reviewed administrative procedures as outlined in DA Pam 710-2 and local SOP to manage property administration.		
2. Established property administration in a unit.	___	___
a. Ensured personnel used the correct property authorization documents.		
b. Ensured personnel maintained the automated property listings.		
c. Ensured personnel prepared and maintained hand receipts using correct procedures.		
d. Ensured procedures for request and receipt of supplies and logistical services were followed.		
e. Ensured supply personnel complied with policies in issuing, storing, and turning in supplies and equipment.		
f. Established and maintained document registers.		
g. Conducted reconciliation procedures with supply support activity.		
h. Established supply and equipment inventory control functions.		

		<b>Performance Measures</b>	<b>GO</b>	<b>NO GO</b>
<b>Skill Level 2</b>		i. Established and maintained supply files.		
		j. Supervised unit budget operations.		
		3. Maintained property administration in a unit by applying the Command Supply Discipline Program procedures.	—	—
		a. Applied administrative action.		
		b. Trained personnel.		
		c. Re-inspected areas .		
		4. Stored Class I MRE in accordance with DODR 4145.19.R-1 chapter 5, section V.	—	—
		a. Prepared to store supplies.		
		b. Stored MREs using indoor/covered storage.		
		c. Took precautionary measures to avoid loss or damage to supplies.		
		5. Stored Class II expendable supplies in accordance with DOD Regulation 4145.19-R-1, chapter 3, section 3.	—	—
		a. Prepared to store supplies.		
		b. Stored Class II expendable supplies.		
		c. Took precautionary measures to avoid loss or damage to supplies.		
		6. Stored Class IIIP petroleum products in accordance with DODR 4145.19-R-1, chapter 5, section 7.	—	—
		a. Prepared to store supplies.		
		b. Stored Class IIIP petroleum products.		
		c. Took precautionary measures to avoid loss or damage to supplies or environment.		
		7. Stored Class IV expendable supplies in accordance with DODR 4145.19-R-1, chapter 5, section 5.	—	—
		a. Prepared to store supplies.		
		b. Took precautionary measures to avoid loss or damage to supplies.		
		8. Stored Class V ammunition in the unit arms room, in accordance with AR 190-11 and DODR 4145.19-R-1.	—	—
		a. Prepared to store supplies.		
		b. Placed the ammunition on pallets.		

<b>Performance Measures</b>	<b>GO</b>	<b>NO GO</b>
<b>c.</b> Took precautionary measures to avoid loss or damage to supplies.		
<b>9.</b> Stored paints, cylinders, and flammable supplies in accordance with DOD R 4145.19-R-1, paragraph 5-404.	—	—
<b>a.</b> Prepared to store paint and flammable supplies in a covered storage area designated for "FLAMMABLE STORAGE."		
<b>b.</b> Prepared to store compressed gases (used for welding).		
<b>c.</b> Followed handling procedures for movement of cylinders.		
<b>d.</b> Took precautionary measures to avoid damage or loss to supplies.		
<b>10.</b> Determined method of obtaining relief from responsibility for "damaged property" in accordance with AR 735-5, paragraph 12-1c (5) and table 12-1.	—	—
<b>a.</b> Processed a relief document for damaged organizational clothing and individual equipment (OCIE) when there was no negligence and item cost less than \$100 in accordance with AR 735-5, paragraph 14-25b(2). Prepared a "damage memorandum" stating the cause of the damage for the unit commander's approval in accordance with AR 735-5, paragraph 14-25, b (2).		
<b>b.</b> Processed a relief document for damaged property when there is no negligence and item (s) costs less than \$200. Prepared a "damage memorandum" stating the cause of the damage for the unit commander's approval and attached it to the maintenance request or turn-in document.		
<b>c.</b> Processed a relief document for damaged property when there was no negligence and the item cost more than \$200. Prepared a "damage memorandum" for the approving authority's designated representative; he entered "concur" on the statement and included the signature of the approving authority or designated representative. In no case was the unit commander a designated representative for reviewing damage statement when the cost for repair of the damage item was equal to or exceeded \$200.		

**Skill Level 2**

	<b>Performance Measures</b>	<b>GO</b>	<b>NO GO</b>
<b>Skill Level 2</b>	<p><b>d.</b> Processed a relief document for any item when a person admitted liability and the amount was less than one month's pay, in accordance with AR 735-5 paragraph 14-25b(1). Prepared a statement of charges/cash collection voucher.</p>		
	<p><b>e.</b> Processed a relief document for any item when a person admitted liability and the amount was more than one month's pay, in accordance with AR 735-5, paragraph 14-25b(1)(b). Prepared and processed a report of survey for the damaged property.</p>		
	<p><b>f.</b> Processed a relief document for any item when a person did not admit liability or negligence in accordance with AR 735-5, paragraph 13-2a (1). Prepared and processed a report of survey for the damaged property.</p>		
	<p><b>11.</b> Determined method of relief from responsibility for "lost or destroyed property" in accordance with AR 735-5, chapter 12, paragraph 12-1c(5), table 12-2; and AR 15-6, chapters 3 through 5; and AR 190-11, paragraph 2-9.</p>	—	—
	<p><b>a.</b> Processed a relief document for any item (except sensitive items) when a person admitted liability and the amount was less than one month's pay, in accordance with AR 735-5, paragraph 12-2c. Prepared a statement of charges/cash collection voucher.</p>		
	<p><b>b.</b> Processed a relief document for any lost or destroyed item that required a report of survey or AR 15-6 investigation in accordance with AR 15-6, chapters 3 through 5.</p>		
	<p><b>12.</b> Determined method of obtaining relief from responsibility for "damaged, lost or destroyed items under special situations" in accordance with AR 735-5, table 12-2, paragraph 2-35; and AR 700-84, paragraph 5-4.</p>	—	—
	<p><b>a.</b> Processed a relief document for bulk petroleum item when loss exceeded allowable loss and was less than \$500, in accordance with AR 735-5, paragraph 2-35.</p>		
	<p><b>b.</b> Processed a relief document for hand tools authorized to a unit when liability was admitted in accordance with AR 735-5, paragraph 12-26. Prepared</p>		



<b>Performance Measures</b>	<b>GO</b>	<b>NO GO</b>
a DD Form 362.		
<b>c.</b> Processed a relief document for items lost in laundry in accordance with AR 735-5 table 12-2.		
<b>d.</b> Processed a DA Form 4697 for items lost resulting from fire, theft or disaster in accordance with AR 735-5, table 12-2.		
<b>e.</b> Processed a memorandum for items destroyed because of infection. Listed items on the memorandum and identified the officer who directed destruction.		
<b>f.</b> Processed a memorandum for unsafe items due to age, (such as drugs, ammunition, parachutes, or chemicals) in accordance with AR 735-5, table 12-2.		
<b>g.</b> Processed a memorandum for abandoned items (such as combat contingency or large scale field maneuvers) in accordance with AR 735-5, table 12-2. Prepared written orders to abandon, signed by the installation or division commander, to serve as a property adjustment voucher. If the commander declined to approve the order, prepared DA Form 4697.		
<b>h.</b> Processed a relief document for items abandoned for reasons of health, safety, expense, difficulty to maintain or handling in accordance with AR 735-5, table 12-2. Submitted an abandonment order to installation or division commander; then used it as a property adjustment voucher.		

**Skill Level 2**

**References**

**Required**

- AR 190-11
- AR 25-400-2
- AR 710-2
- AR 735-5
- DA Pam 25-30
- DA Pam 710-2-1

**101-92Y-0006****Inspect Equipment for Accountability, Cleanliness, and Serviceability**

**Conditions:** Given the requirement to inspect equipment, a piece of equipment, DA Pam 25-30, and the appropriate supply publications and forms.

**Standards:** Ensured all equipment was inspected, and accounted for in accordance with AR 710-2, AR 735-5, DA PAM 710-2-1, and applicable equipment publications.

**Performance Steps**

1. Determine applicable publications.
  - a. Review DA Pam 25-30.
    - b. Ensure that the most current supply catalogs, component list, technical manuals, and other related publications are used during inventory/inspection.
2. Conduct inspection of equipment.
  - a. Accountability.
    - (1) Check end items for completeness.
    - (2) Use the proper technical manual or supply catalog to identify components.
    - (3) Make sure that component shortages are listed on hand receipt shortage annexes.
    - (4) Check the document register to make sure component shortages are on request.
    - (5) Make a list of component shortages that are not listed on hand receipt shortage annexes.
    - (6) Make a list of component overages.
    - (7) Check serial numbers.
    - (8) List serial number differences.
  - b. Serviceability.
    - (1) Conduct a visual check of the condition of the item.
    - (2) List any damaged property.
    - (3) Report damaged items.
3. Take corrective action.
  - a. Report differences pertaining to property book items to the PBO.
  - b. Report damaged equipment to unit maintenance personnel.

Performance Measures	GO	NO GO
1. Determined applicable publications.	___	___
a. Reviewed DA Pam 25-30.		
b. Ensured that the most current supply catalogs, component list, technical manuals, and other related publications were used during inventory/inspection.		
2. Conducted inspection of equipment.	___	___
a. Performed accountability inspection.		
b. Performed serviceability inspection.		
Performance Measures	GO	NO GO
3. Took corrective action.	___	___
a. Reported differences pertaining to property book items to the PBO.		
b. Reported damaged equipment to unit maintenance personnel.		

Skill Level 2

**References**

**Required**

- AR 710-2
- AR 735-5
- DA Pam 25-30
- DA Pam 710-2-1

**Related**

**SUBJECT AREA 27: RISK MANAGEMENT**

**850-001-2000**

**Employ Accident Prevention Measures and Risk Management Process**

**Conditions:** You are a small unit leader, given a mission or task, in a garrison or tactical environment.

**Standards:** Made an oral or written report that correctly identified the hazards associated with the mission or task, the level of risk for each identified hazard, and the initial overall level of risk.

**Performance Steps**

1. Identify the hazards.
  - a. List the hazards associated with the mission or task.

Skill Level 2

**Performance Steps**

- b. Determine what hazards need to be risk-managed.
2. Assess the hazards to determine their impact on the mission or task.
- a. Determine the level of risk for each hazard.
- b. Determine the initial overall level of risk for the mission or task.

**Evaluation Preparation:**

*Setup:* To evaluate this task you need an assigned mission or task, which may be an operation order (OPORD), fragmentary order (FRAGO), warning order, patrol order, training task, and so forth.

*Brief Soldier:* Tell the soldier to do a risk assessment for the assigned mission or task.

**Performance Measures**

	GO	NO GO
1. Identified all the hazards associated with the mission or task (a minimum of one, depending on the mission or task).	—	—
2. Determined the level of risk (E, H, M, L) for each hazard.	—	—
3. Determined the initial overall level of risk for the mission or task.	—	—

**Evaluation Guidance:** Score the soldier GO if all performance measures are passed. Score the soldier NO GO if any performance measure is failed. If the soldier fails any performance measure, show what was done wrong and how to do it correctly.

**References****Required**

FM 100-14

FM 101-5

**Related**

<b>SUBJECT AREA 28: ADMINISTRATION/MANAGEMENT</b>
---

**805C-PAD-2044****Recommend Individual for Award**

**Conditions:** Given opportunity to observe or evaluate performance of subordinates or to observe an act of an individual that warrants recognition, and access to AR 600-8-22, DA Form 638, *Recommendation for Award*, pen and/or computer with authorized software.

3-172

805C-PAD-2044

Skill Level 2

**Standards:** Prepared a DA Form 638 and included personal data, recommended award, and justification (achievement) entered in bullet format. Forwarded the DA Form 638 to the commander of the individual.

---

**Performance Steps**

---

1. Determine if soldier's performance or action merits an award.
  2. Determine the type of award merited.
    - a. Review authorized awards.
    - b. Compare performance or act against award criterion.
  3. Determine criteria for submitting award recommendations.
    - a. Identify time limitations for submitting awards.
    - b. Identify period of award.
    - c. Identify service vs achievement.
    - d. Identify duplication of awards.
    - e. Identify interim awards.
    - f. Identify rules for recognition upon retirement.
    - g. Identify approving authorities.
  4. Prepare the award recommendation, DA Form 638.
    - a. Complete personal data on soldier.
    - b. Specify type and level of award.
    - c. Enter period of award.
    - d. Enter supporting comments in block 20.
  5. Sign DA Form 638 in the appropriate block.
  6. Forward DA Form 638 to the commander of the individual.
- 

**Evaluation Preparation:**

*Setup:* To evaluate this task, gather the items listed in the conditions statement. Provide the soldier with sufficient information to prepare the personal data, type of award, and justification/achievement.

**Note.** If your command directs use of FormFlow or another forms software, have the computer and printer available.

*Brief Soldier:* Tell the soldier he will be evaluated on his ability to recommend an individual for an award.

Performance Measures	GO	NO GO
1. Determined if soldier's performance or action merits an award.	___	___
2. Determined the type award merited.	___	___



Skill Level 2	Performance Measures	GO	NO GO
	3. Determined criteria for submitting award recommendation.	___	___
	a. Identified time limitations for submitting awards.		
	b. Identified period of award.		
	c. Identified service vs . achievement.		
	d. Identified duplication of awards.		
	e. Identified interim awards.		
	f. Identified rules for recognition upon retirement.		
	g. Identified recommendation official.		
	h. Identified approving authorities.		
4. Prepared the award recommendation.	___	___	
a. Completed personal data on soldier.			
b. Specified type and level of award.			
c. Entered period of award.			
d. Entered supporting comments in block 20.			
5. Signed DA Form 638 in the appropriate block.	___	___	
6. Forwarded DA Form 638 to the commander of the individual.	___	___	

**Evaluation Guidance:** Score the soldier GO on performance measures passed. Score the soldier NO GO on any performance measure failed. The soldier must score a GO on all performance measures to receive a GO on the task. If the soldier scores NO GO, show the soldier what was done wrong.

**References**

- Required**  
 AR 600-8-22  
 DA Form 638  
 Software-FormFlow  
 Software-Office  
 Software-Windows

**Related**

---

## 805C-PAD-2145

### Counsel a Soldier on the Contents of a Noncommissioned Officer Evaluation Report and NCOER Checklist

**Conditions:** You are a section leader given soldiers, a mission statement or function manual, job descriptions, DA Form 2166-8, *Noncommissioned Officer Evaluation Report*, DA Form 2166-8-1, *Noncommissioned Officer Counseling Checklist*, and AR 623-205.

**Standards:** Conducted initial performance counseling within 30 days of the NCO's assignment, conducted quarterly performance counseling thereafter, or as performance warranted. Maintained counseling record on DA Form 2166-8-1.

---

#### Performance Steps

---

1. Determine type of counseling (such as initial, quarterly, or as required).
  2. Gather support material.
    - a. Gather forms required.
    - b. Determine duty descriptions.
    - c. Determine mission statement.
    - d. Obtain function manual.
    - e. Determine areas of special emphasis.
  3. Schedule counseling.
    - a. Allot time for soldier to prepare.
    - b. Select site.
    - c. Notify individual.
  4. Prepare for counseling.
    - a. Review DA Form 2166-8-1 and related documents.
    - b. Prepare counseling outline.
  5. Conduct counseling.
    - a. Provide individual assessment of his or her performance, if applicable.
    - b. Solicit input from individual.
    - c. Provide the meaning of each value/responsibility on DA Form 2166-8.
    - d. Provide specific examples of excellence.
    - e. Determine future counseling sessions.
    - f. Obtain rated NCO's initials.
- 

Skill Level 2

## Skill Level 2

**Evaluation Preparation:**

*Setup:* To evaluate this task, provide the soldier a DA Form 2166-8, DA Form 2166-8-1, personal data sheet, job description (duties clearly stated), rating scheme, a scenario that specifies special areas of emphasis, and AR 623-205. Have the soldier prepare the forms for an initial counseling to include personnel administrative data, listing of duty description, and special area of concern.

*Brief Soldier:* Tell the soldier he will be evaluated on his ability to conduct performance counseling on a noncommissioned officer evaluation report (NCOER). Have the soldier prepare the forms for an initial counseling to include personnel administrative data, listing of duty description, and special area of concern.

<b>Performance Measures</b>	<b>GO</b>	<b>NO GO</b>
1. Determined type of counseling.	___	___
2. Gathered support material.	___	___
a. Gathered forms required.		
b. Determined duty description.		
c. Determined mission statement.		
d. Obtained function manual.		
e. Determined areas of special emphasis .		
3. Scheduled counseling.	___	___
a. Allotted time for soldier to prepare.		
b. Selected site.		
c. Notified individual.		
4. Prepared for counseling.	___	___
a. Reviewed DA Form 2166-8-1 and related documents.		
b. Prepared counseling outline.		
5. Conducted counseling.	___	___
a. Provided individual assessment of his or her performance.		
b. Solicited input from individual.		
c. Provided the meaning of each value/responsibility on DA Form 2166-8.		
d. Provided specific examples of excellence.		



Performance Measures	GO	NO GO
e. Determined future counseling sessions.		
f. Obtained rated NCO's initials.		

**Evaluation Guidance:** Score the soldier GO on performance measures passed. Score the soldier NO GO on any performance measure failed. The soldier must score a GO on performance measures 2 and 4 to receive a GO on the task. If the soldier scores NO GO, show him what was wrong.

#### References

##### Required

AR 623-205

DA Form 2166-8-1

##### Related

FM 22-100

Skill Level 2

## 805C-PAD-2146

### Prepare the Rater's Portion of a Noncommissioned Officer Evaluation Report

**Conditions:** You are a section leader and must rate one of your subordinate NCOs. You are given DA Form 2166-8, DA Form 2166-8-1, AR 623-205, current rating scheme, paper, pen/pencil, and computer with authorized software.

**Standards:** Completed all elements of the rater's portion of the NCOER without error.

#### Performance Steps

1. Determine type of report.
2. Determine if eligible to render report.
3. Review Soldier's Counseling work sheet, DA Form 2166-8-1.
4. Verify Part I (Administrative Data) of DA Form 2166-8 (NCOER) with rated NCO.
  - a. Verify name.
  - b. Verify SSN.
  - c. Verify rank.
  - d. Verify date of rank.
  - e. Verify Primary Military Occupational Specialty Code (PMOSC).
  - f. Verify unit, organization, station, zip code or APO, major command.
  - g. Verify reason for submission.
  - h. Verify period covered.

**Performance Steps**

- i. Verify rated months.
  - j. Verify non-rated codes.
  - k. Verify number of enclosures.
5. Verify Part II (authentication) of NCOER with rated NCO.
  - a. Verify name of rater (include rater's AKO email address), SSN, rank, PMOSC/branch, organization, duty assignment.
  - b. Verify name of senior rater (include senior rater's AKO email address), SSN, rank, PMOSC/branch, organization, duty assignment.
  - c. Verify name of reviewer (include reviewer's AKO email address), SSN, rank, PMOSC/branch, organization, duty assignment.
6. Complete Part III (duty description) of NCOER.
  - a. Enter principal duty title.
  - b. Enter duty MOSC.
  - c. Enter daily duties and scope.
  - d. Enter areas of special emphasis.
  - e. Enter appointed duties.
  - f. Enter counseling dates from checklist/record.
7. Complete Part IV (values/NCO responsibilities) of NCOER.
  - a. Enter values.
  - b. Enter competence.
  - c. Enter physical fitness and military bearing.
  - d. Enter leadership.
  - e. Enter training.
  - f. Enter responsibility and accountability.
8. Complete Part V (overall performance and potential) of NCOER.
  - a. Enter an X in the appropriate block.
  - b. List up to three future duty positions .
9. Sign Part II of the NCOER.
10. Forward NCOER to senior rater.

**Evaluation Preparation:**

*Setup:* To evaluate this task, gather DA Form 2166-8, DA Form 2166-8-1, AR 623-205, current rating scheme, paper and pen/pencil, computer with authorized software and a printer. Give the soldier a scenario that provides all the information needed to complete the task performance steps.

*Brief Soldier:* Tell the soldiers he will be evaluated on his ability to prepare the rater's portion of an NCOER.



Performance Measures	GO	NO GO
1. Determined type of report.	—	—
2. Determined if eligible to render report.	—	—
3. Reviewed soldier's counseling worksheet DA Form 2166-8-1.	—	—
4. Verified Part I, Administrative Data, DA Form 2166-8 (NCOER) with rated NCO.	—	—
a. Verified name.		
b. Verified SSN.		
c. Verified rank.		
d. Verified date of rank.		
e. Verified PMOSC.		
f. Verified unit, organization, station, zip code or APO, major command.		
g. Verified reason for submission.		
h. Verified period covered.		
i. Verified rated months.		
j. Verified non-rated codes.		
k. Verified number of enclosures.		
5. Verified Part II, Authentication entries on NCOER with rated NCO.	—	—
a. Verified name of rater (included rater's AKO email address), SSN, rank, PMOSC/branch, organization, duty assignment.		
b. Verified name of senior rater (included senior rater's AKO email address), SSN, rank, PMOSC/branch, organization, duty assignment.		

Skill Level 2	Performance Measures	GO	NO GO
		c. Verified name of reviewer (included reviewer's AKO email address), SSN, rank, PMOSC/branch, organization, duty assignment.	
	6. Completed Part III, duty description, of NCOER.	___	___
	a. Entered principal duty title.		
	b. Entered duty MOSC.		
	c. Entered daily duties and scope.		
	d. Entered areas of special emphasis.		
	e. Entered appointed duties.		
	f. Entered counseling dates from checklist/record.		
	7. Completed Part IV, values/NCO responsibilities, of the NCOER.	___	___
	a. Entered values.		
	b. Entered competence.		
	c. Entered physical fitness and military bearing.		
	d. Entered leadership.		
	e. Entered training.		
	f. Entered responsibility and accountability.		
	8. Completed Part V, overall performance and potential of the NCOER.	___	___
	a. Entered an X in the appropriate block.		
	b. Listed up to three future duty positions.		
	9. Signed Part II of the NCOER.	___	___
	10. Forwarded NCOER to senior rater.	___	___

**Evaluation Guidance:** Score the soldier GO on performance measures passed. Score the soldier NO GO on any performance measure failed. The soldier must score a GO on all performance measures to receive a GO on the task. If the soldier scores NO GO, show him what was wrong.

**References**

- Required**  
 AR 623-205  
 DA Form 2166-8  
 DA Form 2166-8-1

**Related**

**References**

**Required**

Software-FormFlow  
Software-Office  
Software-Windows

**Related**



---

**805C-PAD-2402**

**Provide Input on Personnel Actions Affecting Subordinates**

**Conditions:** You are a squad/section leader and must assess your subordinates and make recommendations as to actions, qualifications, potential, and experience for pertinent personnel actions.

**Standards:** Determined soldier's eligibility and potential for promotion, assignments, education/training, and career. Counseled soldier on actions required to maintain or obtain eligibility for appropriate personnel action. Provided recommendation/input to commander on personnel action. Provided commander with any change in previous recommendation/input as required.

---

**Performance Steps**

1. Determine eligibility requirements for PV2 to SPC.
  - a. Assess eligibility and potential of assigned soldiers for promotion.
  - b. Counsel soldier on actions required to maintain or obtain promotion eligibility.
  - c. Submit recommendation/input through channels to the commander.
2. Determine availability of professional/educational programs or courses .
  - a. Determine eligibility requirements, training benefits, frequency, and how to schedule soldier for attendance.
  - b. Assess eligibility and potential of assigned soldiers for attendance at professional/educational training course/programs .
  - c. Counsel soldier on potential effects of attending professional/educational training courses/programs .
  - d. Counsel soldier on actions required to be recommended for attendance.
  - e. Submit recommendation/input through channels to the commander.
3. Determine assignment eligibility.

**Performance Steps**

- a. Determine eligibility requirements for reassignment or request for special assignment.
  - b. Assess eligibility and potential of assigned soldiers for reassignment/special assignment.
  - c. Counsel soldier on eligibility for the assignment and the effect the assignment could have on his career.
  - d. Submit recommendation/input through channels to the commander.
4. Determine soldier's career potential.
    - a. Assess soldier's current duty performance and potential for continued service.
    - b. Counsel soldier on actions required to maintain or obtain eligibility for continued service.
    - c. Counsel soldier on the possible long-term effects that poor performance could have on his or her personal benefits and future.
    - d. Submit recommendation/input through channels to the commander.
  5. Keep abreast of changes in assigned soldiers' eligibilities and potential.
    - a. Determine changes in requirements and effect of new policies and programs on assigned soldiers .
    - b. Inform soldiers when their performance has improved or fallen down.
    - c. Submit change to previous recommendation/input when warranted through channels to the commander.

**Evaluation Preparation:**

*Setup:* To evaluate this task, prepare a scenario that provides information on the soldier(s) affected and the specifics of the personnel action(s) involved. Have the soldier determine if the subordinate soldier meets eligibility requirements and has the potential for the personnel action, and prepare the recommendation for the commander.

*Brief Soldier:* Tell the soldier he will be evaluated on his ability to provide input on personnel actions (promotion, assignments, education/training, and career potential) affecting subordinate personnel.

Performance Measures	GO	NO GO
1. Determined eligibility requirements for PV2 to SPC.	___	___

<b>Performance Measures</b>	<b>GO</b>	<b>NO GO</b>
<b>a.</b> Assessed eligibility and potential of assigned soldiers for promotion .		
<b>b.</b> Counseled soldiers on actions required to maintain or obtain promotion eligibility.		
<b>c.</b> Submitted recommendation/input through channels to the commander.		
<b>2.</b> Determined availability of professional/educational programs or courses .	___	___
<b>a.</b> Determined eligibility requirements, training benefits, frequency, and how to schedule soldier for attendance .		
<b>b.</b> Assessed eligibility and potential of assigned soldiers for attendance at professional/educational training courses/programs .		
<b>c.</b> Counseled soldier on potential effects of attending professional/educational training courses/programs .		
<b>d.</b> Counseled soldier on actions required to be recommended for attendance.		
<b>e.</b> Submitted recommendation/input through channels to the commander.		
<b>3.</b> Determined assignment eligibility.	___	___
<b>a.</b> Determined eligibility requirements for reassignment or request for special assignment.		
<b>b.</b> Assessed eligibility and potential of assigned soldiers for reassignment/special assignment.		
<b>c.</b> Counseled soldiers on their eligibility for and the effect the assignment could have on their career.		
<b>d.</b> Submitted recommendation/input through channels to the commander.		
<b>4.</b> Determined soldier's career potential.	___	___
<b>a.</b> Assessed soldier's current duty performance and potential for continued service.		
<b>b.</b> Counseled soldiers on actions required to maintain or obtain eligibility for continued service.		

**Skill Level 2**

Skill Level 2	Performance Measures	GO	NO GO
	c. Counseled soldier on the possible long-term effects that poor performance could have on his personal benefits and future.		
	d. Submitted recommendation/input through channels to the commander.		
	5. Kept abreast of changes in assigned soldiers' eligibilities and potential.	—	—
	a. Determined changes in requirements and effect of new policies and programs on assigned soldiers		
	b. Informed soldiers when their performance has improved or fallen down.		
	c. Submitted change to previous recommendation/ input when warranted through channels to the commander.		

**Evaluation Guidance:** Score the soldier GO on performance measures passed. Score the soldier NO GO on any performance measures failed. The soldier must score a GO on all of the performance measures listed above to receive a GO on the task. If the soldier scores NO GO, show him what was wrong.

**805C-PAD-2407**  
**Recommend Disciplinary Action for a Soldier**

**Conditions:** You are a squad/section leader. One of your soldiers has committed an act that may require disciplinary action based on violation of standards, bad conduct, breach of discipline, or insubordination. Given a computer with appropriate software, printer, AR 25-50, AR 27-10, AR 600-8-2, AR 600-20, AR 601-280, AR 630-10 and AR 635-200.

**Standards:** Verified act occurred, determined if conduct was a violation, prepared and submitted recommendation.

**Performance Steps**

1. Verify that reported or observed act occurred.
  - a. Obtain written/sworn statements.
  - b. Obtain blotter reports/counseling statements.
2. Determine if conduct is in violation of standards, breach of discipline, or insubordination.
  - a. Gather all information.



Skill Level 2

**Performance Steps**

- b. Seek advice from legal representative (unit legal clerk or JAG officer).
- 3. Prepare recommendation in memorandum or as required by local directive.
- 4. Submit recommendation to higher authority.

**Evaluation Preparation:**

*Setup:* To evaluate this task, give the soldier a scenario that would provide enough information to accomplish the performance steps. Provide the soldier with access to a computer, a printer, and references.

*Brief Soldier:* Tell the soldier he will be evaluated on his ability to recommend disciplinary action for a soldier.

Performance Measures	GO	NO GO
1. Verified that reported or observed act occurred.	___	___
a. Obtained written/sworn statements.		
b. Obtained blotter reports/counseling statements.		
2. Determined if conduct was in violation of standards, breach of discipline, or insubordination.	___	___
a. Gathered all information.		
b. Sought advice from legal representative (unit legal clerk or JAG officer).		
3. Prepared and sent recommendation to higher authority for disciplinary action.	___	___

**Evaluation Guidance:** Score the soldier GO on performance measures passed. Score the soldier NO GO on any performance measures failed. The soldier must score a GO on performance measures 1 through 3 to receive a GO on the task. If the soldier scores NO GO, show him what was wrong.

**References**

**Required**

- AR 27-10
- AR 600-20
- AR 600-8-2
- AR 601-280
- AR 630-10
- AR 635-200

**Related**

- FM 22-100

**805C-PAD-2461****Maintain Accountability of Personnel (Status Report)**

**Conditions:** You are a squad/section leader. Given a squad/section roster and DA Form 5367-R, *Personnel Status Report*.

**Standards:** Status report accounted for all assigned/attached personnel.

**Performance Steps**

1. Verify the squad/section roster.
2. Prepare the personnel status report (DA Form 5367-R).
  - a. Enter the report number.
  - b. Enter the time the report was prepared.
  - c. Enter the unit.
  - d. Prepare the personnel daily summary.
    - (1) Enter the number of authorized personnel who are commissioned, warranted, and enlisted.
    - (2) Enter the number of assigned personnel who are commissioned, warranted, and enlisted.
    - (3) Enter the number of present for duty (PDY) who are commissioned, warranted, and enlisted.
    - (4) Enter the number of killed in action (KIA) who are commissioned, warranted and enlisted.
    - (5) Enter the number wounded in action (WIA) who are commissioned, warranted, and enlisted.
    - (6) Enter the number missing in action (MIA) who are commissioned, warranted, and enlisted.
    - (7) Enter the number of NONBAT LOSSES who are commissioned, warranted, and enlisted.
    - (8) Enter the number of total LOSSES who are commissioned, warranted, and enlisted.
    - (9) Enter the GAINS that are commissioned, warranted, and enlisted.
    - (10) Enter written comments in the remarks section.

**Evaluation Preparation:**

*Setup:* To evaluate this task, give the soldier a scenario that would require him to accomplish the performance measures. Provide the soldier a squad/section roster and DA Form 5346-R. The scenario should indicate changes in the status of assigned/attached soldiers. Have the soldier prepare a status report that accounts for all assigned/attached soldiers.

*Brief Soldier:* Tell the soldier he will be evaluated on his ability to maintain accountability of assigned/attached personnel.

Performance Measures	GO	NO GO
1. Verified the squad/section roster.	—	—
2. Prepared the personnel status report.	—	—
a. Entered the report number.		
b. Entered the time the report was prepared.		
c. Entered the unit.		
d. Entered the personnel daily summary.		
(1) Entered the number of authorized personnel who are commissioned, warranted, and enlisted.		
(2) Entered the number of assigned personnel who are commissioned, warranted, and enlisted.		
(3) Entered the number of PDY who are commissioned, warranted, and enlisted.		
(4) Entered the number of KIA who are commissioned, warranted, and enlisted.		
(5) Entered the number WIA who are commissioned, warranted, and enlisted.		
(6) Entered the number MIA who are commissioned, warranted, and enlisted.		
(7) Entered the number of NONBAT LOSSES who are commissioned, warranted, and enlisted.		
(8) Entered the number of total LOSSES who are commissioned, warranted, and enlisted.		
(9) Entered the GAINS who are commissioned, warranted, and enlisted.		
(10) Entered written comments in the remarks section.		

Skill Level 2

**Evaluation Guidance:** Score the soldier GO on performance measures passed. Score the soldier NO GO on any performance measures failed. The soldier must score a GO on all of the performance measures listed above to receive a GO on the task. If the soldier scores NO GO, show him what was wrong.

**References****Required**

AR 600-8-101  
DA Form 5367-R

**Related**

---

**805C-PAD-2472****Prepare a Duty Roster**

**Conditions:** You are a squad/section leader. Given requirements to provide soldiers to perform additional duties on a recurring basis, DA Form 6, *Duty Roster*, and AR 220-45.

**Standards:** Prepared a DA Form 6 for each duty requirement, listed all eligible soldiers, posted only days on which a detail was required.

---

**Performance Steps**

1. Determine the requirements of the duty.
  - a. Determine the period of the duty.
  - b. Determine the nature of the duty performed.
2. Determine personnel eligible.
  - a. Determine grade of individuals eligible for duty.
  - b. Determine special skills needed.
3. Prepare DA Form 6.
  - a. Prepare a separate form for each recurring duty.
  - b. Complete administrative data.
    - (1) Enter duty title.
    - (2) Enter start date.
    - (3) Enter month/day performed.
  - c. Enter soldiers eligible to perform duty.
  - d. Post numbers for day detail, as required.
4. Select soldier(s) for duty.
  - a. Notify individual.
  - b. Post duty roster.

---

**Evaluation Preparation:**

*Setup:* To evaluate this task, give the soldier a scenario that would require the individual to prepare a duty roster, post numbers, and select individual to perform duty. Provide soldier with a section roster, DA Form 6, pencil, and AR 220-45.

*Brief Soldier:* Tell the soldier he will be evaluated on his ability to prepare a duty roster.

Performance Measures	GO	NO GO
1. Determined the requirements of the duty.	___	___
a. Determined the period of the duty.		
b. Determined the nature of the duty performed.		
2. Determined personnel eligible.	___	___
a. Determined grade of individuals eligible for duty.		
b. Determined special skills needed.		
3. Prepared DA Form 6.	___	___
a. Prepared a separate form for each recurring duty.		
b. Completed administrative data.		
(1) Entered duty title.		
(2) Entered start date.		
(3) Entered month/day performed.		
c. Entered soldiers eligible to perform duty.		
d. Posted numbers .		
4. Selected soldier(s) for duty.	___	___
a. Notified individual concerned.		
b. Posted duty roster.		



**Evaluation Guidance:** Score the soldier GO on performance measures passed. Score the soldier NO GO on any performance measures failed. The soldier must score a GO on performance measures 1 to 3 to receive a GO on the task. If the soldier scores NO GO, show him what was wrong.

**References**

**Required**

AR 220-45

DA Form 6

**Related**

Skill Level 3

**SUBJECT AREA 1: INDIVIDUAL CONDUCT AND LAWS OF WAR**

**805C-PAD-3238**

**Enforce the Equal Opportunity Program**

**Conditions:** You are a unit/section leader responsible for the supervision of personnel. Personnel include both males and females and represent different races, colors, religions, and national origins. You have access to AR 27-10, AR 600-13, AR 600-20, DA Pam 350-20, DA Pam 600-26, DA Pam 600-75, DODD 7050.6, Manual for Courts Martial, and the Army and unit equal opportunity (EO) and sexual harassment policies.

**Standards:** Demonstrated personal behavior and leadership consistent with the EO and sexual harassment policies. Enforced compliance with the Army EO, sexual harassment, and the Army extremist activities policies.

**Performance Steps**

1. Act in accordance with the Army's EO and sexual harassment policies.
- a. Demonstrate Army Values associated with EO.
    - (1) Display unquestionable loyalty.
    - (2) Follow your higher duty to the Army and the nation.
    - (3) Treat people as they should be treated.
    - (4) Live up to all the Army Values.
  - b. Conform to the Army's EO and sexual harassment policies by avoiding—
    - (1) Making racial or sexual comments and/or gestures.
    - (2) Making national origin or religious comments/jokes/slurs.
    - (3) Displaying racist or sexually offensive visual materials.
    - (4) Making unsolicited and unwelcome sexual contact with fellow soldiers.
    - (5) Stereotyping fellow soldiers or making assumptions about their cultural background, race, religion, or beliefs.
    - (6) Using profanity or sexually oriented language.
    - (7) Discounting the religious beliefs of fellow soldiers.
    - (8) Belonging to extremist organizations or participating in extremist activities.
  - c. Demonstrate leadership consistent with EO and sexual harassment

Skill Level 3

---

**Performance Steps**

---

policies.

- (1) Treat subordinates with dignity and respect.
  - (2) Treat subordinates fairly and equally.
  - (3) Recognize and respect subordinates' individual needs, aspirations, and capabilities.
  - (4) Avoid discriminating against subordinates based on race, color, national origin, gender, or religion.
  - (5) Avoid using language that demeans, excludes, or offends subordinates.
2. Promote EO and interpersonal harmony within the unit.
  - a. Conduct assessments of the EO climate within the unit.
  - b. Promote interaction among soldiers of different races and genders.
  - c. Ensure subordinates respect the cultural background of fellow soldiers.
  - d. Ensure subordinates communicate openly and honestly with each other.
  - e. Consider support for EO when making recommendations for assignment, promotions, awards, and reenlistment of soldiers.
  - f. Ensure subordinates understand Army and unit EO and sexual harassment policies and procedures.
    - (1) Ensure subordinates understand required standards of behavior.
    - (2) Counsel subordinates on legal and administrative repercussions of EO/sexual harassment violations.
    - (3) Ensure subordinates understand recommended techniques for dealing with sexual harassment.
    - (4) Ensure subordinates understand the EO and sexual harassment complaint process.
    - (5) Ensure subordinates know the identities and roles of the unit EO representative and EO advisor.
    - (6) Ensure subordinates understand the Army policy on extremist activities and organizations.
    - (7) Ensure subordinate leaders understand their responsibilities for enforcing EO and sexual harassment policies.
3. Promptly resolve EO and sexual harassment violations.
  - a. Make on-the-spot corrections of subordinates whose behaviors are contrary to Army EO and sexual harassment policies.
    - (1) Correct soldiers using racist or sexually harassing nonverbal

Skill Level 3

---

**Performance Steps**

---

gestures.

(2) Correct soldiers making racist or sexually harassing verbal comments.

(3) Correct soldiers displaying racist or sexually harassing visual materials.

b. Act promptly to resolve EO and sexual harassment violations/incidents.

(1) Conduct an evaluation of the violation/incident.

(2) Take prompt and effective action to preclude recurrence.

(3) Counsel soldiers who commit EO violations or who sexually harass.

(4) Inform the chain of command.

(5) Conduct follow-up assessment.

c. Assist in resolving formal EO and sexual harassment complaints within required timelines.

(1) Provide all required information to investigating personnel within established timelines.

(2) Implement required corrective actions and monitor results.

(3) Avoid allowing intimidation, harassment, or reprisal against soldiers for making complaints.

(4) Assist follow-up assessments of corrective actions.

---

**Evaluation Preparation:**

*Setup:* This task can be tested in an administrative or field environment. Give the soldier a scenario that provides sufficient information to evaluate his or her knowledge of the Army's EO and sexual harassment policies, prohibited acts, and actions that should be taken if a violation occurs.

*Brief Soldier:* Inform soldier that he will be tested on his knowledge of the Army's EO and sexual harassment policies, prohibited acts, and actions that should be taken if a violation occurred.

Performance Measures	GO	NO GO
1. Acted in accordance with the Army's EO and sexual harassment policies.	—	—
a. Demonstrated Army Values associated with EO.		
(1) Displayed unquestionable loyalty.		
(2) Followed higher duty to the Army and the nation.		

Skill Level 3



Performance Measures	GO	NO GO
(3) Treated people as they should be treated.		
(4) Lived up to all the Army Values.		
<b>b.</b> Conformed to the Army's EO and sexual harassment policies.		
(1) Avoided making racial or sexual comments and/or gestures.		
(2) Avoided making national origin or religious comments/jokes/slurs.		
(3) Avoided displaying racist or sexually offensive visual materials.		
(4) Avoided making unsolicited and unwelcomed sexual contact with fellow soldiers.		
(5) Avoided stereotyping fellow soldiers or making assumptions about their cultural background, race, religion, or beliefs.		
(6) Avoided using profanity or sexually oriented language.		
(7) Avoided discounting the religious beliefs of fellow soldiers.		
(8) Avoided belonging to extremist organizations or participating in extremist activities.		
<b>c.</b> Demonstrated leadership consistent with EO and sexual harassment policies.		
(1) Treated subordinates with dignity and respect.		
(2) Treated subordinates fairly and equally.		
(3) Recognized and respected subordinates' individual needs, aspirations, and capabilities.		
(4) Avoided discriminating against subordinates based on race, color, national origin, gender, or religion.		
(5) Avoided using language that demeaned, excluded, or offended subordinates.		
<b>2.</b> Promoted EO and interpersonal harmony within the unit.	—	—
<b>a.</b> Conducted assessments of the EO climate within the unit.		
<b>b.</b> Promoted interaction among soldiers of different		

Skill Level 3

Performance Measures	GO	NO GO
aces and genders.		
c. Considered support for EO when making recommendations for assignment, promotion, award, and reenlistment of soldiers.		
d. Ensured subordinates understood Army and unit EO and sexual harassment policies and procedures.		
e. Ensured subordinate leaders understood their responsibilities for enforcing EO and sexual harassment policies.		
3. Promptly resolved EO and sexual harassment violations.	—	—
a. Made on-the-spot corrections of subordinates whose behaviors were contrary to Army EO and sexual harassment policies.		
b. Acted promptly to resolve EO and sexual harassment violations/incidents.		
(1) Conducted an evaluation of the violation/incident.		
(2) Took prompt and effective action to preclude recurrence.		
(3) Counseled soldiers who committed EO violations or who sexually harassed.		
(4) Informed the chain of command.		
(5) Conducted follow-up assessment.		
c. Assisted in resolving formal EO and sexual harassment complaints within required timelines.		
d. Avoided allowing intimidation, harassment, or reprisal against those making complaints.		

Skill Level 3

**Evaluation Guidance:** Score the soldier GO for each performance measure accomplished. Score the soldier NO GO for each performance measure not accomplished. Soldier must receive a GO on all performance measures to receive a GO for the task. If the soldier receives a NO GO, show him the performance measures he missed.

**References**

**Required**  
AR 600-13  
AR 600-20

**Related**

3-194

805C-PAD-3238

Skill Level 3

**References**

**Required**

DA Pam 350-20  
DA Pam 600-26  
DODD 7050.6  
MCM2002

**Related**

**SUBJECT AREA 4: SURVIVE (COMBAT TECHNIQUES)**

**052-192-4053**

**Supervise Minefield Breaching Operations**

**Conditions:** You are a soldier, given FM 3-34.2, a combat engineer platoon, organic equipment, explosives, and an operation order (OPORD) with detailed obstacle intelligence (OBSTINTEL) requiring your platoon to conduct breaching operations.

**Standards:** Supervised minefield breaching operations. Created a safe lane through the minefield so the maneuver force could maintain its momentum without causing mine casualties to personnel and equipment.

**Performance Steps**

1. Conduct troop-leading procedures.
  - a. Receive the mission.
    - (1) Obtain the number of breach lanes required.
    - (2) Obtain security, suppression, obscuration, and assault plans for the minefield breach.
    - (3) Conduct a back brief to the commander and request the required resources.
  - b. Issue the platoon warning order (WO).
  - c. Make a tentative plan.
    - (1) Use OBSTINTEL and the mission analysis to develop a scheme of reduction.
    - (2) Task-organize the platoon.
    - (3) Develop subunit instructions for the breaching, marking, and security elements.
    - (4) Integrate maneuver unit suppression, security, and obscuration support into the plan.
  - d. Initiate movement.

Skill Level 3

Skill Level 3

052-192-4053

3-195

---

**Performance Steps**

---

- e. Conduct a reconnaissance.
    - (1) Identify the minefield size and composition.
    - (2) Identify breach locations.
  - f. Complete the plan. Adjust the plan based on the information obtained during reconnaissance.
  - g. Issue the platoon OPORD.
    - (1) Brief the five-paragraph OPORD.
    - (2) Assign breaching, marking, and security tasks to subunits based on the scheme of reduction.
  - h. Supervise the plan.
    - (1) Supervise precombat inspections.
    - (2) Supervise rehearsals.
2. Supervise actions at the breach site.

**Note.** Breaching elements are normally located with the lead elements of the maneuver units. Usually, an engineer squad instead of an entire platoon performs in-stride breaches. In such cases, the platoon sergeant should supervise the most critical breach site, if possible.

- a. Coordinate with the maneuver element for suppression, security, and obscuration.
- b. Ensure that the platoon breaches the number of lanes specified in the OPORD.

**Note.** Breach lanes for personnel are one meter wide and breach lanes for vehicles are four meters wide.

- c. Ensure that the breach lanes are free of mines.
- d. Ensure that the breach lanes are marked according to FM 3-34.2.
- e. Notify the maneuver commander when the breach lanes are safe for traffic.

---

**Evaluation Preparation:**

*Setup:* Provide the soldier with the items listed in the conditions.

*Brief Soldier:* Tell the noncommissioned officer (NCO) to perform a minefield breaching operation.

Performance Measures	GO	NO GO
1. Conducted troop-leading procedures.	___	___
2. Supervised actions at the breach site.	___	___

Skill Level 3

**Evaluation Guidance:** Score the soldier GO if all performance measures are passed. Score the soldier NO GO if any performance measure is failed. If the soldier fails any performance measure, show him how to do it correctly.

**References**

<b>Required</b>	<b>Related</b>
FM 3-34.2	FM 5-10
	FM 5-100
	FM 20-32

---

**071-410-0012**  
**Conduct Occupation of an Assembly Area**

**Conditions:** You are a platoon-size unit leader, given a company commander's order to occupy a specific sector of a company assembly area and a map of the operational area.

**Standards:** Moved unit to the location specified in the company order. Ensured preparation of the assigned sector was completed in the time specified in the order. Positioned elements, weapons, and observation posts in a manner that supported the company plan for occupation of the assembly area.

---

**Performance Steps**

1. Conduct preparation for occupation of the assembly area (AA).
  - a. Perform the required troop-leading procedures (a series of eight interrelated, overlapping processes that are often accomplished concurrently and do not follow a rigid sequence). Use the procedures as outlined, if only in abbreviated form, to ensure that nothing is left out of planning and preparation and that soldiers understand the mission and prepare adequately.
    - (1) Receive the mission and the company OPORD.
    - (2) Issue the warning order to subordinate leaders. Include location, special equipment required, and the earliest time for movement.
    - (3) Make a tentative plan for moving to the position and preparing the position based on the estimate of the situation and an analysis of METT-TC. Your plan must support the company plan for occupation of the AA.
    - (4) Start necessary movement. Movement may need to begin while you are still planning. This step could occur at any time during the troop-leading procedures.
    - (5) Reconnoiter the position and the route(s) to it. This may not be

Skill Level 3

---

**Performance Steps**

---

possible due to the situation. As a minimum, conduct a map reconnaissance to confirm or deny assumptions made during the estimate of the situation.

(6) Complete the plan.

(7) Issue the order to subordinate leaders. Use the standard OPORD format. As a minimum, the order should include—

(a) Situation.

(b) Mission and purpose for occupation of the AA.

(c) Each squad position (left, right, center) in the platoon sector.

(d) Security plan (passwords, observation posts, percent of personnel on alert).

(e) Times for movement or occupation of the AA.

(f) Other pertinent information such as location of the command post, waste disposal, and environmental hazards.

(8) Supervise continuously.

b. Make necessary coordination with elements that will be attached or adjacent to your position in the AA.

c. Provide platoon representatives for company quartering party as required. Instruct them to perform the following tasks or other tasks, as required.

(1) Reconnoiter the AA to ensure it is clear of enemy.

(2) Establish initial security.

(3) Select initial positions for all platoon elements.

(4) Identify, clear, or mark obstacles in the platoon sector of the AA.

2. Direct platoon movement to designated platoon release point. Use appropriate movement techniques based on the terrain and the situation.

3. Prepare your sector of the AA in accordance with the company plan.

a. Link up with guides and move the platoon to its initial position.

b. Establish and maintain local security.

c. Assign squad sectors. Ensure sectors are mutually supporting and that all gaps are covered by fire and observation.

d. Designate observation post(s) locations and the elements responsible for establishing and maintaining them.

e. Ensure communication is established within the platoon and company.

---

Skill Level 3

---

**Performance Steps**

---

- f. Submit timely progress reports to company headquarters.
- g. Establish and enforce priority of work. The following is an example of work priority and may vary based on unit SOP, mission, or METT-TC.
  - (1) Position vehicles, crew-served weapons, and chemical-agent alarms, and designate PDF, FPL, and FPF.
  - (2) Construct fighting position.
  - (3) Set up wire communications.
  - (4) Prepare range cards.
  - (5) Distribute ammunition, rations, water, supplies, and special equipment.
  - (6) Conduct preventive maintenance checks and services on equipment.
  - (7) Inspect personnel and equipment.
  - (8) Rehearse critical aspects of the upcoming mission.
  - (9) Test small arms (if situation permits).
  - (10) Conduct personal hygiene and field sanitation.
  - (11) Institute a rest plan.
- h. Coordinate with adjacent units and others, as required.
  - (1) Coordinate for security patrols (if applicable).
  - (2) Establish responsibility for overlapping enemy avenues of approach between adjacent units.
  - (3) Ensure there are no gaps between elements.
  - (4) Exchange information on OP locations and unit signals.
  - (5) Coordinate for local counterattacks.
  - (6) Complete and forward a copy of the platoon sector sketch to company headquarters.

Skill Level 3

---

**Evaluation Preparation:**

*Setup:* This task should be evaluated during a field training exercise. Otherwise, assign an assembly area to be occupied and a quartering party that has accomplished its tasks according to the company and platoon SOP.

*Brief Soldier:* Issue an OPORD for an operation requiring the occupation of an assembly area.

Performance Measures	GO	NO GO
1. Conducted preparations for occupation of the AA.	___	___

Performance Measures	GO	NO GO
2. Directed platoon movement to designated release point. Used appropriate movement technique based on terrain and situation.	—	—
3. Prepared assigned sector of AA in accordance with company plan.	—	—

**Evaluation Guidance:** Score the soldier GO if all performance measures are passed. Score the soldier NO GO if any performance measure is failed. If the soldier fails any performance measure, show what was done wrong and how to do it correctly.

#### References

##### Required

##### Related

FM 7-7  
FM 3-21.71  
FM 7-8

Skill Level 3

### 071-420-0021

#### Conduct a Movement to Contact by a Platoon

**Conditions:** Given a platoon, and a mission requiring movement to contact, in a combat environment.

#### Standards:

1. Developed a plan that included objectives, routes, key terrain, fire support, formations, and other required control measures.
2. Included in the preparations the cleaning and test firing of weapons, maintenance of vehicles and equipment, and the resupply of ammunition or needed equipment.
3. Made contact with the threat with the smallest possible element. Developed the situation by controlling movement and fires. Submitted situation reports as required.

#### Performance Steps

1. Receive and analyze the mission.

**Note.** A warning order should be issued to provide subordinates as much preparation time as possible.

2. Make a tentative plan.
3. Start preparations.
4. Conduct reconnaissance.

3-200

071-420-0021

Skill Level 3



---

**Performance Steps**

---

5. Finalize the plan.

**Note.** Preparation continues as the plan develops. New information is incorporated into preparations. The OPORD is issued at the time and place specified in the warning order.

6. Continue preparations.

7. Request supplies.

8. Receive supplies.

9. Conduct rehearsals.

10. Conduct final inspection.

11. Control movement.

12. Control fires.

13. Report the contact to the company.

---

**Evaluation Preparation:**

*Setup:* At the test site, provide an area in which a movement to contact can be conducted. Test this task during a platoon or larger tactical exercise.

*Brief Soldier:* Tell the soldier that he is the leader of a platoon conducting a movement to contact and that he must react properly to enemy fire.

Performance Measures	GO	NO GO
1. Received and analyzed the mission.	___	___
2. Made a tentative plan.	___	___
3. Started the preparations.	___	___
4. Conducted the reconnaissance.	___	___
5. Finalized the plan.	___	___
6. Continued preparations.	___	___
7. Requested supplies.	___	___
8. Received supplies.	___	___
9. Conducted rehearsals.	___	___
10. Conducted final inspection.	___	___
11. Controlled movement.	___	___

Skill Level 3

Performance Measures	GO	NO GO
12. Controlled fires.	___	___
13. Reported contact to the company.	___	___

**Evaluation Guidance:** Score the soldier GO if all performance measures are passed. Score the soldier NO GO if any performance measure is failed. If the soldier fails any performance measure, show what was done wrong and how to do it correctly.

#### References

##### Required

##### Related

FM 7-7  
FM 3-21.71  
FM 7-8

Skill Level 3

### 071-430-0028 Consolidate a Unit

**Conditions:** Given a squad leader with a squad or platoon sergeant with a platoon or acting platoon leader defending as part of a larger unit. The unit has just repelled an enemy assault.

**Standards:** Consolidated the unit (squad or platoon) in the defense following enemy contact.

#### Performance Steps

Once enemy resistance on the objective has ceased, the squad or platoon must quickly take the following steps to consolidate and prepare to defend against a counterattack:

1. Reestablish security if the observation post (OP) withdrew back to the defensive position, send them back out. If the OP did not return, they must be accounted for and returned.
2. Use snipers (if available) for targets of opportunity. They may be employed with the OP or at a vantage point on or behind the defensive positions.
3. Restore camouflage and improve fighting positions. Do not over-camouflage positions. If it was not found during the first assault, chances are it will not be found during the next counterattack.
4. Reestablish communications to higher headquarters and throughout the platoon and squad. Check wires to ensure it does not break during the attack. Change pyrotechnic signals for the enemy may have learned what they represent.

3-202

071-430-0028

Skill Level 3

---

**Performance Steps**

---

5. Replace obstacles, mines, and early warning devices (conduct only if the enemy withdraws far enough and time permits). This is a risky action, especially if the enemy has snipers. Soldiers must use caution when moving about. Request smoke to conceal their movement or have them wait until limited visibility.

6. Reposition fighting and weapons positions. If the squad or platoon has just repelled an attack, the enemy may have found some of the positions. Reposition those that have been compromised.

7. Reassign sectors of fire to ensure that all gaps caused by the evacuation of casualties are covered and that the firing positions remain mutually supporting.

8. Implement alert and sleep plans once all of the above have been accomplished and is feasible to the situation.

---

**Evaluation Preparation:**

*Setup:* Provide a squad or platoon in an established defensive position, simulated casualties, simulated EPWs, simulated destroyed crew-served weapons, blank ammunition, and a communication network.

*Brief Soldier:* Tell the soldier this task should be conducted and evaluated in a realistic field environment using a realistic combat scenario.

Performance Measures	GO	NO GO
1. Reestablished security throughout the squad and platoon's sector.	___	___
2. Used snipers (if available).	___	___
3. Restored camouflage and improved positions.	___	___
4. Reestablished communications.	___	___
5. Replaced obstacles, mines, and early warning devices.	___	___
6. Repositioned fighting and weapon positions.	___	___
7. Reassigned sectors of fire for the squad and platoon.	___	___
8. Implemented sleep and alert plans (if feasible).	___	___

**Evaluation Guidance:** Score the soldier GO if all performance measures are passed. Score the soldier NO GO if any performance measure is failed. If the soldier scores NO GO, show what was done wrong and how to do it correctly.

Skill Level 3

---

**References****Required**

FM 7-8

**Related**

FM 3-21.71

FM 7-7

FM 7-10

FM 23-90

---

**071-430-0029****Reorganize a Unit**

**Conditions:** Given a squad leader with squad, or platoon sergeant with platoon, or mortar section sergeant, or acting platoon leader defending as part of a larger unit; your element has just repelled an enemy assault.

**Standards:** Reorganized the unit (squad, platoon, or mortar section) in the defense following enemy contact.

---

**Performance Steps**

Skill Level 3

1. The platoon leader must plan the required reorganization of the platoon while defending (either deliberate or hasty). He must include his plan in the order to the squad leaders. The plan must be tentative and flexible and may be changed as the situation evolves. The leader's plan must be complete and as detailed as possible.
  2. Reorganize a unit:
    - a. Reestablish the chain of command; fill all key positions from the remaining element members and ensure the new chain of command is disseminated down to the last member of your element.
    - b. Evacuate the dead and seriously wounded according to your casualty evacuation plan. Ensure all positions and sectors remain mutually supporting. Check all sectors of fire after all casualties are evacuated to ensure all sectors are covered. If necessary, shift positions or reassign sectors to cover any gaps in your sector.
    - c. Redistribute or resupply ammunition, weapons, and fuel. Ensure the squad leaders pass out additional ammunition (if available), or divide the remainder equally throughout the squad or platoon. Conduct a quick inventory and submit a supply request to higher headquarters if necessary.
    - d. Ensure all enemy prisoners of war (EPWs), enemy material, and enemy information are collected, reported, and evacuated (if possible).
    - e. Ensure all crew-served weapons are manned and positioned on likely avenues of approach.
- 

3-204

071-430-0029

Skill Level 3

---

**Performance Steps**

---

- f. Issue to higher headquarters, a LACE report to include:
    - (1) L - Liquid, how much water each soldier has left (canteens per).
    - (2) A - Ammunition, how much ammunition does the squad or platoon have per man (after redistribution).
    - (3) C - Casualties, how many casualties did the squad or platoon encounter.
    - (4) E - Equipment, how much special equipment does the squad and platoon have remaining.
  - 3. For mortar section—
    - a. Reestablish section communications.
    - b. Reestablish the FDC.
- 

**Evaluation Preparation:**

*Setup:* Provide a squad or platoon in an established defensive position, simulated casualties, simulated EPWs, simulated destroyed crew-served weapons, blank ammunition, and a communication network.

*Brief Soldier:* Tell the soldier this task should be conducted and evaluated in a realistic field environment using a realistic combat scenario.

Performance Measures	GO	NO GO
1. Reestablished and disseminated the chain of command.	___	___
2. Evacuated the dead and seriously wounded.	___	___
3. Ensured all positions remained mutually supporting.	___	___
4. Checked sectors of fire.	___	___
5. Redistributed or resupplied ammunition, weapons, and fuel if needed.	___	___
6. Ensured squad leaders and platoon sergeants passed out additional ammunition if available.	___	___
7. Ensured all EPWs were reported and evacuated ASAP.	___	___
8. Ensured all crew-served weapons were manned.	___	___
9. Issued a LACE report to higher headquarters.	___	___
10. Reestablished section communications (mortar section).	___	___

Skill Level 3

Performance Measures	GO	NO GO
11. Reestablished the FDC (mortar section).	___	___

**Evaluation Guidance:** Score the soldier GO if all performance measures are passed. Score the soldier NO GO if any performance measure is failed. If the soldier scores NO GO, show what was done wrong and how to do it correctly.

**References**

Required	Related
FM 7-8	FM 3-21.71
	FM 7-7
	FM 7-10
	FM 23-90

**SUBJECT AREA 5: NAVIGATE**

Skill Level 3

**071-332-5000**  
**Prepare an Operation Overlay**

**Conditions:** Given a complete copy of the operation order (OPORD) that your unit is to execute, a commander's or a battalion operations officer's (S3) guidance (to include time available for preparation), overlay paper, tape, a map of the operational area, colored pencils (red, black, blue, green, and yellow), a No. 2 pencil, a coordinate scale, and FM 101-5-1.

**Standards:** Within the specified time, identified the overlay by map reference data, effective date, and purpose. The overlay contained classification markings and downgrading instructions, if applicable and distribution instructions and authentication, if distributed separately. Prepared overlay in accordance with overlay techniques outlined in FM 101-5-1, with boundaries and unit locations plotted to within 50 meters, and tactics and fire support measures to within 25 meters.

**Performance Steps**

**Note.** Overlay techniques involve the use of military symbols to portray, in a condensed form, the plans, orders, and information concerning a military operation.

1. Register the overlay.
  - a. Orient the overlay material over the map area to the annotated portion and temporarily attach it to the map with the tape.

---

### Performance Steps

---

- b. Trace the grid intersections nearest the opposite corners of the overlay and label each with the proper grid coordinates.
2. Plot new detail. Use colored pencils or markers in standard colors, when available, to plot any detail (FM 101-5-1); otherwise, plot the activity you wish to show with a pen or pencil that makes a lasting mark without cutting the overlay. Use standard military symbols where possible. When the author invents nonstandard symbols, they must be identified on the edge of the overlay. Show only that detail with which the document is directly concerned. Standard colors are—
- a. Blue or black. Friendly units, installations, equipment, and activities.
  - b. Red. Enemy installations, equipment, and activities.
  - c. Yellow. Any areas of chemical, biological or radiological contamination.
  - d. Green. Any man-made obstacle.
- Note.** If only one color is available, enemy symbols are depicted with double lines.
3. Mark the overlay classification. The classification of the overlay is dependent upon classification of the order used to prepare the overlay. Mark the top and bottom of the overlay with the classification.
4. Recognize overlay techniques.
- a. Use solid and broken lines. When the location of a unit or installation or coordinating detail (for example, line of departure or boundary) is in effect and will continue, or is made effective by the order prepared, the appropriate symbol is shown by solid lines. The symbol indicating any proposed or future location, or coordinating detail to become effective later, is shown by broken lines.
  - b. Boundaries.
    - (1) Boundaries show areas of tactical responsibility. In the offense, these are referred to as zones of action. In the defense and retrograde, they are referred to as sectors of responsibility. When described orally, lateral boundaries are described from rear to front in the offense and from front to rear in the defense and retrograde.
    - (2) Rear boundaries are used when the area of responsibility for forward units must be precisely defined. When a rear boundary is not delineated, the rear limit of a unit area of responsibility is determined by visualizing a rear boundary drawn generally parallel to the front, preferably along a natural terrain feature, and connecting at the rearward limit of the unit lateral boundaries.
- 

Skill Level 3

**Performance Steps**

(3) If a rear boundary is shown, the size indication along the boundary corresponds to the low unit. Arm or branch is shown when required to prevent confusion (figure 071-332-5000-1).

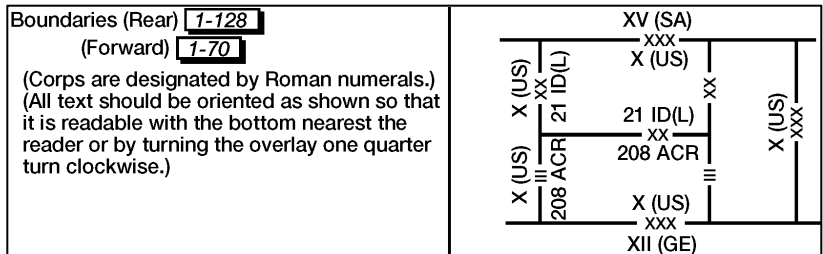

**Figure 071-332-5000-1. Rear Boundary**

(4) Desirably, boundaries are drawn along terrain features easily recognizable on the ground, and are situated, if possible, so the key terrain features, avenues of approach, and river are wholly inclusive of the one unit. They are shown by a solid line if currently in effect or made effective by the order prepared. Their use is based on the techniques and tactics peculiar to the type of tactical operation in which they are used.

(5) Future or proposed boundaries are shown by a broken line and labeled to indicate the effective time, if appropriate (figure 071-332-5000-2).



**Figure 3-071-332-5000-2. Proposed Boundary**

(6) A symbol is placed on the boundary to show size and designation of the highest units that share the boundary.

(7) If the units are of unequal size, the symbols of the higher unit are shown and the designation of the lower is given completely to show its size. The boundary between the 52d Infantry Division and the 230th Infantry Brigade (separate) is shown in figure 071-332-5000-3.

Skill Level 3



---

**Performance Steps**

---

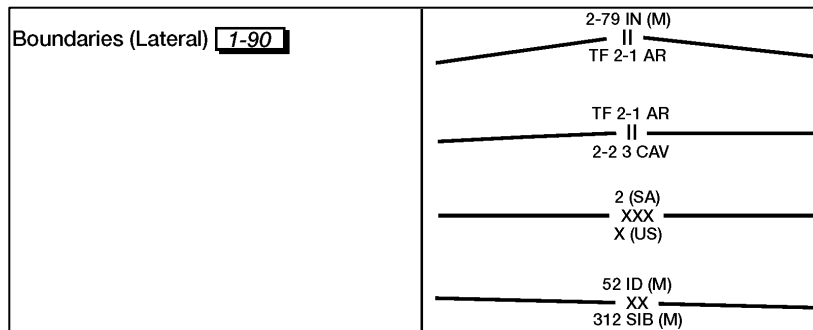

**Figure 071-332-5000-3. Lateral Boundary**

**(8)** On overlays or sketches accompanying written or oral orders that specify task organization, unit designation on battalion boundaries indicate the numerical designation. If the battalion is organized into a task force, the letters "TF" precedes the numerical designation. A unit symbol is identified as task force by placing the symbol (||) over the unit size designation (||). Company boundaries are labeled with the appropriate letter unless the company is organized into a team. In the latter case, the boundary is labeled with the abbreviation "TM" and the letter designation or a code name. On other boundaries, only the unit designation needed for clarity is required. Branch designations may be added when necessary for clarity. When unequal-size units have a boundary in common, the designation of the smaller unit is spelled out.

**c. Axis of advance.**

**(1)** An axis of advance arrow should extend only as far as this form of control is essential to the overall plan. Normally, it is shown from the line of departure (LD) to the objective following an avenue of approach. It indicates that the commander may maneuver his forces and place them freely to either side of the axis to avoid obstacles, engage the enemy, or bypass enemy forces that could not threaten his security or jeopardize the accomplishment of his mission. The commander ensures that such deviation does not interfere with adjacent units, that his unit remains oriented on the objective, and that the location and size of the bypassed enemy forces are reported to higher headquarters. Boundaries may be assigned as an additional control measure when using the axis of advance, if the situation so dictates.

**(2)** An axis of advance is shown below, identified by a code. It could be identified by a unit designation (figure 071-332-5000-4).

**Skill Level 3**

**Performance Steps**

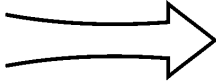
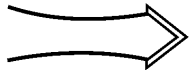
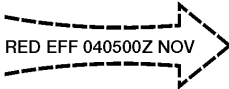
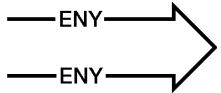
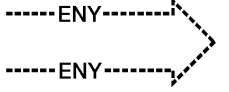
Friendly Ground Axis of Supporting <b>1-147</b>	
Friendly Ground Axis of Main Attack <b>1-94</b>	
Friendly Ground Axis on Order with Date and Time (if known) Effective	
Enemy Confirmed	
Enemy Templated	

**Figure 071-332-5000-4. Axis of Advance**

(3) To differentiate between a ground axis of advance and an air assault of a advance, a twist is placed in the shaft of the open arrow, symbolic of a propeller (figure 071-332-5000-5).

Skill Level 3

**Performance Steps**

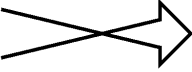
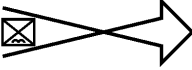
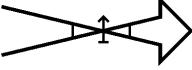
<p>Axis of Advance <b>7-14</b>          (The tip of the arrow should touch the objective or limit of the movement.)</p> <p>Friendly Aviation</p>	
<p>Friendly Airborne</p>	
<p>Friendly Attack Helicopter</p>	

**Figure 071-332-5000-5. Air Assault Axis of Advance**

d. Direction of attack arrows. This control measure is used when the commander desires to specify the direction in which the center of mass of a subordinate unit must move in an attack to ensure the accomplishment of a closely coordinated plan of maneuver (for example, in a night attack or counterattack). A direction of attack arrow should extend from the line of departure to the objective and is not labeled (figure 071-332-5000-6).

**Skill Level 3**

**Performance Steps**

Direction of Attack <b>1-53</b> (The tip of the arrow should touch the objective or limit of the movement.) Friendly Aviation	
Friendly Aviation Planned or On Order	
Enemy Known/Confirmed Aviation	
Templated Enemy Aviation	
Enemy Confirmed/Known Ground	
Templated Enemy Ground	
Friendly Direction of Supporting Attack <b>1-147</b>	
Friendly Planned or On Order	

**Figure 071-332-5000-6. Direction of Attack Arrow**

- (1) The arrow should be used only where necessary because it restricts the maneuver of the subordinate unit.
- (2) When a unit is directed to seize successive objectives with its main attack along a certain line, either one arrow extending through the objectives to the final objective or a series of arrows connecting the objectives may be used.
- (3) The double arrowhead is used to distinguish the main attack for the command as a whole (figure 071-332-5000-7).

Skill Level 3

---

**Performance Steps**

---



**Figure 071-332-5000-7. Arrowhead Indicating the Main Attack**

e. Graphic portrayal of units assigned a security mission.

(1) To show the general location of a unit with a security mission, arrows generally indicate the terrain over which the unit operates and the farthest extension of its mission (figure 071-332-5000-8).

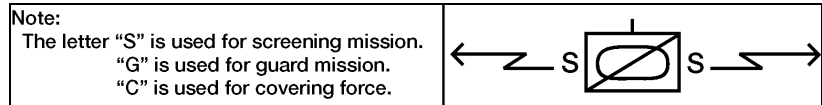

**Figure 071-332-5000-8. Unit With Security Mission**

(2) The primary security mission normally is shown on an operation overlay; however, a secondary or proposed mission is not shown.

f. Graphic portrayal of supply routes.

(1) The main supply route (MSR) is the route(s) designated within an area of operations upon which the bulk of traffic flows in support of military operations. The route is labeled MSR and assigned a code name.

**Note.** The term MSR is not used below division level.

(a) In the defense, the division extends the MSR forward to the brigade trains. The brigade's supply route (SR) extends from the battalion trains to a point at the rear of the forward company defense sectors.





(b) In the offense, the proposed SR may be shown forward to the objective or as far as the battalion supply officer (S4) can visualize the combat service support for the operation. Forward of the LD, it is shown as a broken line.

(2) The symbols to show the division (offensive action) are shown in figure 071-332-5000-9.

---

Skill Level 3

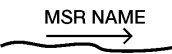
**Performance Steps**

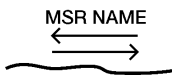

Supply Routes <b>1-95</b> Main Supply Route	
Alternate Supply Route <b>1-8</b>	
One-way Traffic	
Alternating Traffic	
Two-way Traffic	

**Figure 071-332-5000-9. Division Main Supply Route**

(3) Combat service support facilities are shown on the operation overlay or their location disseminated by the S4, as appropriate.

**g.** Portrayal of a unit location.

(1) To show the location of a unit on an overlay, the symbol should be drawn so its center corresponds with the coordinates at which the unit is located (figure 071-332-5000-10).

A solid line symbol represents a present or actual location.	
A broken line symbol indicates a future or projected location.	

**Figure 071-332-5000-10. Location of a Unit**

(2) To show the location of a training area, observation posts, or logistical activity, the center of the symbol also should correspond with the coordinates at which the element is located. The illustration shown is the location of an observation post (figure 071-332-5000-11).

Skill Level 3

**Performance Steps**

Observation Post/Outpost <b>1-112</b>	
---------------------------------------	---

**Figure 071-332-5000-11. Location of an Observation Post**

(3) The offset technique is used for clarity when space precludes normal placement of symbols. Offset staffs may be "bent" as required. The offset staff is dashed for future or proposed locations. Offset staffs extend vertically from the bottom center of the symbol (except for command posts [CP]). The end of the offset staff indicates exact locations of CPs and aid stations and the center of mass for other units or installations. The staff for a CP symbol is always on the left edge (figure 071-332-5000-12).

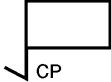
Basic symbols other than the headquarters symbols (for example, points) may be placed on a staff which is extended or bent. The end of the staff indicates the precise location.	
Since the headquarters symbol already includes a staff, this staff may be extended or bent. The end of the staff, or extension (if used), indicates the exact location of the headquarters.	

**Figure 071-332-5000-12. Offset Technique**

**(4) Location of units.**

(a) The locations of attacking units normally are indicated by boundaries (and CP symbols, when the locations of the CPs are known) or by unit symbols.

(b) The location of the reserve is indicated by an assembly area symbol and by a CP or unit symbol.

(c) Reserve units of a force assigned defense position or battle position normally are shown by a line enclosing the area occupied or to be occupied—in other words, a "goose egg." These positions may be numbered or lettered for convenient reference. An occupied and unoccupied company assembly area (reserve location) is shown in figure 071-332-5000-13. An occupied and unoccupied reserve company battle position is shown in figure 071-332-5000-14.

Skill Level 3

**Performance Steps**

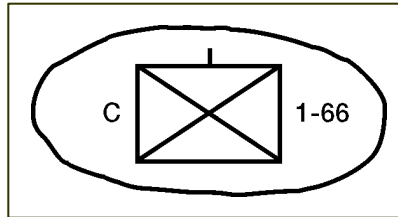

**Figure 071-332-5000-13. Occupied and Unoccupied Company Assembly Area (Reserve Location)**

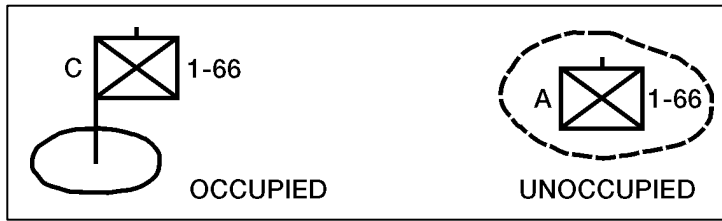

**Figure 071-332-5000-14. Occupied and Unoccupied Reserve Company Battle Position**

**h. Objective(s).**

(1) Each objective is identified by the abbreviation "OBJ" and a number, letter, or name designation (figure 071-332-5000-15).

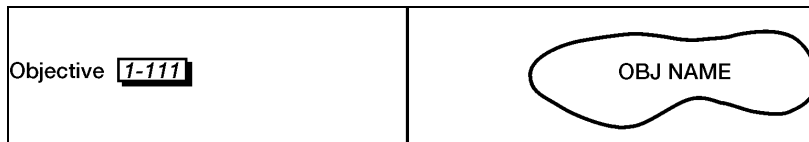

**Figure 071-332-5000-15. Objective**

(2) An objective assigned by higher headquarters may be given entirely to one subordinate unit or may be divided. If divided, the objective may be shown graphically as separate objectives and numbered accordingly, or may be divided into two objectives by a boundary line.

**i. Pinch out a unit.**

Skill Level 3



---

**Performance Steps**

---

(1) This type operation is indicated by drawing the boundary across the front of the unit, usually along a well-defined terrain feature such as a stream, ridge, or highway.

(2) The following example indicates that Company A will be pinched out after seizing OBJ 1; Company B will seize OBJ 2 and continue the attack to seize OBJ 3 (figure 071-332-5000-16).

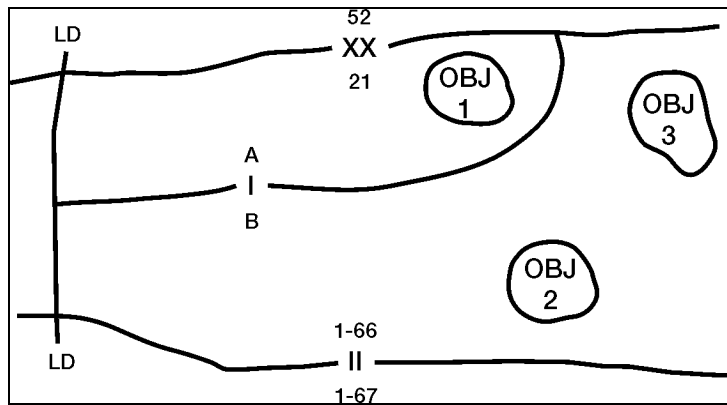

Figure 071-332-5000-16. Pinching Out a Unit

j. Defensive battlefield. The defensive battlefield is organized into the covering force area and the main battle area (MBA) (figure 071-332-5000-17).

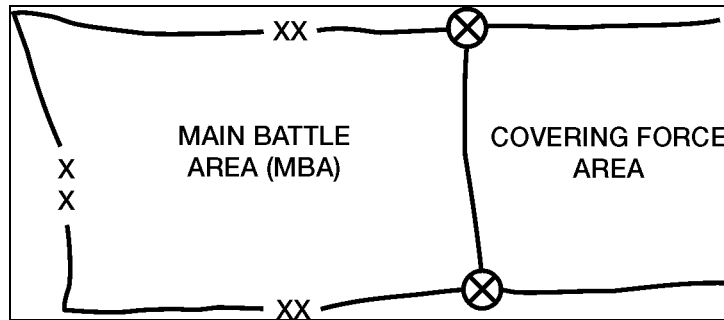

Figure 071-332-5000-17. Organizing the Defensive Battlefield

Skill Level 3

---

**Performance Steps**

---

k. Defended areas. If an area is occupied and the defense of the area is prepared, a line (including the size symbol of the defending unit) encloses the area, and the closed side of the symbol is oriented toward the most likely enemy threat. If desired, the military symbols of the unit may be entered in the center of the enclosed area. A defensive area for 2d Platoon, C Company, 1st Battalion, 6th Infantry, and a proposed defensive area for B Company, 3d Battalion, 52d Infantry, are shown in figure 071-332-5000-18.

Skill Level 3

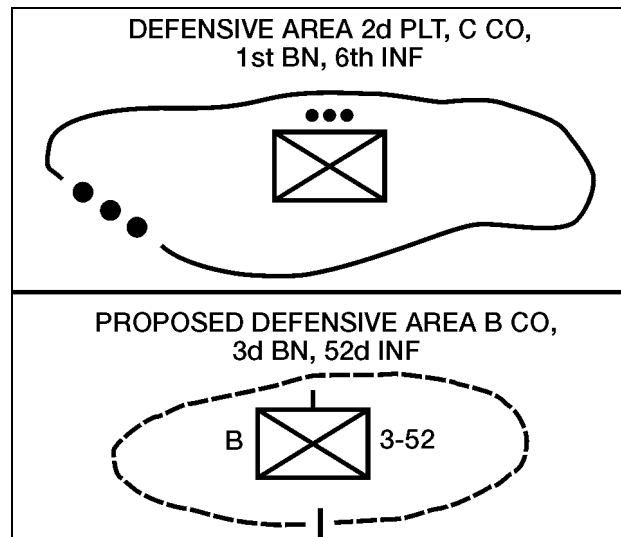

Figure 071-332-5000-18. Defensive Area

I. Control measures.

(1) Line of departure (LD). The LD is a control measure to coordinate the advance of an attacking unit (figure 071-332-5000-19). The LD should be—

- (a) Clearly defined on the ground and on the map.
  - (b) Approximately perpendicular to the direction of the attack.
  - (c) Under control of friendly units.
  - (d) Marked on both ends.
-

**Performance Steps**

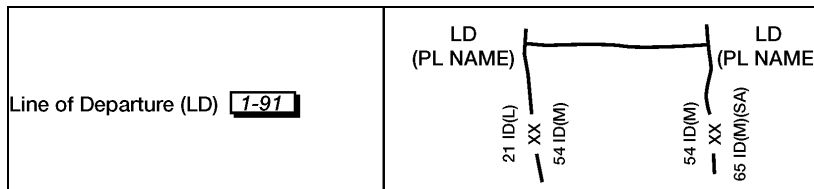

**Figure 071-332-5000-19. Line of Departure**

**(2)** Line of contact (LC) (figure 071-332-5000-20).

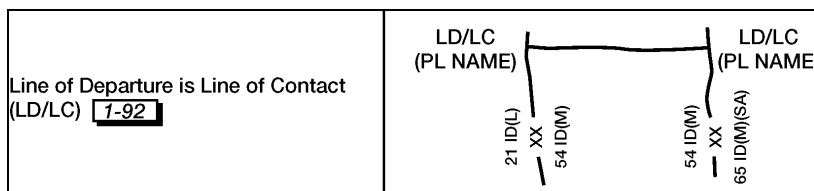

**Figure 071-332-5000-20. Line of Contact**

- (a)** When units are in contact with the enemy, the frontline is shown as a series of arcs, and the ends of the arced line are labeled "LC."
- (b)** If the LC is used as an LD, it is marked LD/LC.
- (c)** If the LC is not used, the LD is shown by a solid line marked LD.

**(3)** Phase line (PLs). PLs are used to control the progress of units for reference in issuing orders or receiving reports. They should be easily recognized terrain features, normally perpendicular to the direction of advance. A PL is also used to control fires and unit movement and even to limit the advance of attacking elements. Units report their arrival at, or clearance of, a PL, but they do not halt unless ordered to do so. A PL is drawn as a solid line with the letters PL at each end of the line or, where appropriate, to allow easy identification. A PL is identified further by a number, a letter, or code name (which can be phonetic letters, colors, flowers, cars, or any other code system) under or beside the PL abbreviation (figure 071-332-5000-21).

**Skill Level 3**

**Performance Steps**

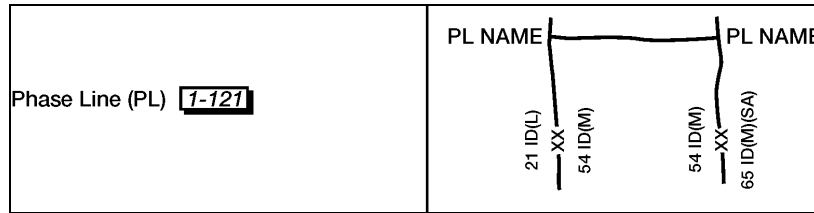

**Figure 071-332-5000-21. Phase Line**

**(4) Initial delay position (IDP).** An IDP is where a delaying action begins, trading space for time. The delay sector is defined by boundaries. The initial and all subsequent delay positions can be related to a time-phased forward edge of the battle area (FEBA). The initial and subsequent delay positions are specified, and PLs may be used to report the progress of the battle. The enemy is held forward of delay lines until the specified time or until permission is granted to withdraw. The initial and successive delay positions are shown on boundaries by coordination points with a solid line between them. Although most IDPs are given a code name, they may have a number, letter, or a variety of code names. The letter abbreviation (IDP) can be to the flank of the coordination symbol (when at the flank, it is in parentheses) or on the line itself. Its time phase is indicated as a date-time group having a two-digit day and a four-digit hour, both connected. The month indicator can be a three-letter type or spelled out, depending upon the desires of the commander. The letters IDP should be placed in parentheses between the line code name, letter, or number and the date-time group (figure 071-332-5000-22).

Skill Level 3

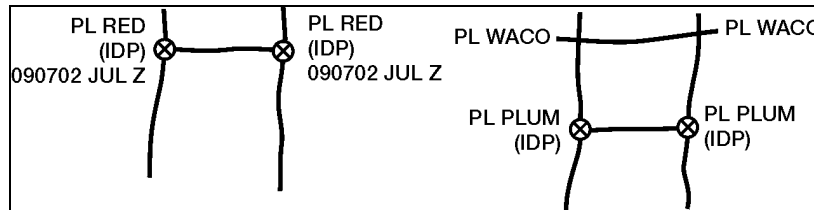

**Figure 071-332-5000-22. Initial Delay Position**

**(5) Delay lines (DLs).** These indicate where a succeeding delay position is located. Delay positions (other than initial) are drawn the same, except that the letter abbreviation is along the line, and none are placed to the flanks at the coordinating points.

**(6) Coordinating points.**

---

**Performance Steps**

---

(a) Coordinating points are designated on boundaries as specific points for coordination of fires and maneuver between adjacent units. They are indicated when a boundary crosses the FEBA and should be indicated when the boundary crosses the covering force. Coordinating points are also used where DLs and internal boundaries intersect.

(b) Coordinating points should be located at some terrain feature easily recognizable both on the ground and on a map. Their location on a boundary indicates the general trace of the FEBA, covering force, or DL as visualized by the commander who designates them.

(c) The symbol for a coordinating point is shown by a circle with an "X" centered in it (figure 071-332-5000-23). The symbol is labeled as appropriate.

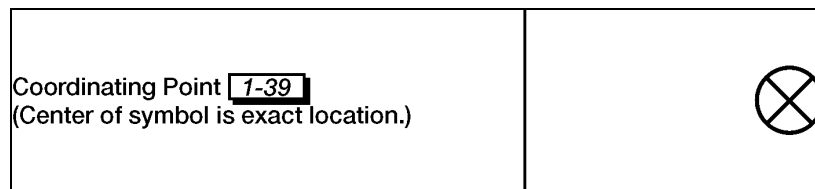

Figure 071-332-5000-23. Coordinating Point

(7) Checkpoints. Checkpoints are shown graphically by a number, letter, or code word inside an upright rectangle with a pointed bottom (figure 071-332-5000-24). They are easily recognizable terrain features or objects, such as crossroads, churches, lone buildings, stream junctions, hills, bridges, and railroad crossings. They may be selected throughout the area of operation. By reference to these points, the subordinate commander may rapidly and accurately report his location; or the higher commander may designate objectives, boundaries, assembly areas, phase lines, and so forth, to his subordinate commanders.

---



---

**Performance Steps**

---

Checkpoint (CKP) <b>1-25</b> (Bottom point or an extension is exact location.)	
---	---

**Figure 071-332-5000-24. Checkpoint**

**(8)** Contact points. Contact points, shown graphically by squares with a staff extending from the bottom center, are designated at the units to make physical contact. Contact points may also be used to delineate areas of responsibility in specific localities when boundaries are obviously unsuitable, such as between elements of a flank guard (figure 071-332-5000-25).

Skill Level 3

Contact Point <b>1-37</b>	
---------------------------	--

**Figure 071-332-5000-25. Contact Point**

**(9)** Passage points (PP). A passage point, shown similar to a checkpoint with the letters PP and the number or letter designation of the passage point within the symbol, is designated along the LD or the FEBA of the unit being passed through. The PPs will be located where the commander desires subordinate units to actually pass.

---

---

### Performance Steps

---

**(10)** Linkup points. A linkup point should be an easily identifiable point on the ground and map that is used to facilitate the joining, connecting, or reconnecting of elements of a unit or units. They are used when two or more Army elements are to join each other, when Army and sister service elements are to join each other, and when Army or sister service and allied elements are to join each other. The linkup is an operation in itself and is conducted as part of an airborne or airmobile operation, an attack to assist in the breakout of an airborne or airmobile operation, an attack to assist in the breakout of an encircled force, or an attack to join an infiltrating force. The battalion may participate in a linkup as part of a larger force, or it may conduct a linkup. The symbol for linkup points is similar to a checkpoint with a dot in the center. A number, the name, or code name is placed near the symbol in such a manner as to ensure it is referring to the symbol (figure 071-332-5000-26).



**Figure 071-332-5000-26. Linkup Point**

**(11)** Points of departure (PDs). These normally are shown along the LD for night attacks. They are shown similar to a checkpoint containing the abbreviation “PD” and a letter or number within the symbol. The point of the arrow is at the bottom of its location.

### Evaluation Preparation:

*Setup:* Provide the soldier with all the material and equipment listed in the conditions statement.

*Brief Soldier:* Tell the soldier he is to prepare an overlay for the operation indicated in the OPORD.

Performance Measures	GO	NO GO
1. Placed registering marks in opposite corners of the overlay.	—	—
2. Marked information using standard military symbols.	—	—
3. Indicated enemy installations, equipment, or activities with either the color RED or with double-lined symbols.	—	—

Skill Level 3

Performance Measures	GO	NO GO
4. Indicated future locations or coordinating detail with broken-line symbols.	—	—
5. Placed symbols indicating size on a boundary to indicate the highest unit sharing the boundary.	—	—
6. Extended the axis of advance arrow from the line of departure to the objective.	—	—
7. Labeled the route of march arrows with a code name or unit designation.	—	—
8. Labeled the MSR and assigned a code name.	—	—
9. Ensured the center of a unit symbol corresponded to the coordinates of the unit.	—	—

**Evaluation Guidance:** Score the soldier GO if all performance measures are passed. Score the soldier NO GO if any performance measure is failed. If the soldier scores NO GO, show what was done wrong and how to do it correctly.

**References**

**Required**  
 FM 3-90.2  
 FM 101-5-1

**Related**

**SUBJECT AREA 19: CROWD CONTROL**

**191-378-4302**

**Form Squad-Size Riot Control Formations**

**Conditions:** Given a riot control situation and a squad of soldiers fully equipped with riot control gear, FM 19-15, and STP 19-95B1-SM.

**Standards:** Selected the best formation to control or disperse the crowd. Correctly formed the squad into the formation selected. Reassembled the squad from the formation after the crowd had been controlled or dispersed.

**Performance Steps**

**Note.** Any size squad, platoon, or large unit can be employed and a crowd control formation can be adapted to fit the unit organization. A leader should be able to employ a unit sized to fit the circumstances.

1. Prepare the squad for formation.

Skill Level 3



---

**Performance Steps**

---

- a. Form the squad in a single column behind you, with the base member directly behind you and the assistant squad leader at the end.
- b. Direct squad members to count off from front to rear with yourself as number one and the base member as number two.

**Note.** The purpose for counting off is so each squad member has a number and will know where his position will be in each type of formation.

2. Direct the squad in forming a squad line (figure 191-378-4302-1).

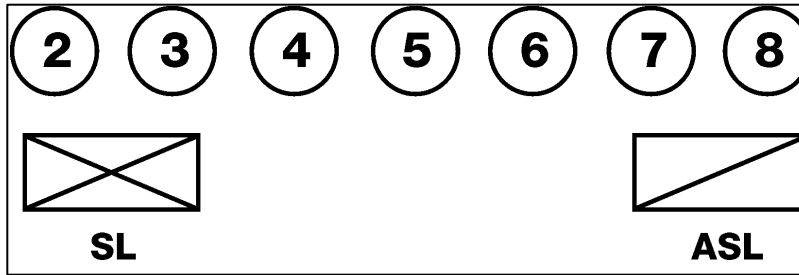

**Figure 191-378-4302-1. Squad Line Formation with Squad Leader and Assistant Squad Leader**

**Note.** As an offensive formation, this formation is used to push or drive crowds straight back across an open area or up a city street. As a defensive formation, it is used to hold a rioting group in place or to deny them access to restricted streets or areas.

- a. Face the squad and give the command, "Squad as skirmishers ....." Simultaneously, give hand signals with the command by raising your arms straight out, horizontal to the shoulders, hands extended, palms down.
  - b. Point to where you want the squad to assemble and complete the command, "Move." (Make sure the base member moves to where you pointed and the rest of the squad forms up according to their number.)
  - c. Take your position behind the formation.
3. Direct the squad in forming a squad echelon, right or left (figure 191-378-4302-2).
- 

Skill Level 3

---

**Performance Steps**

---

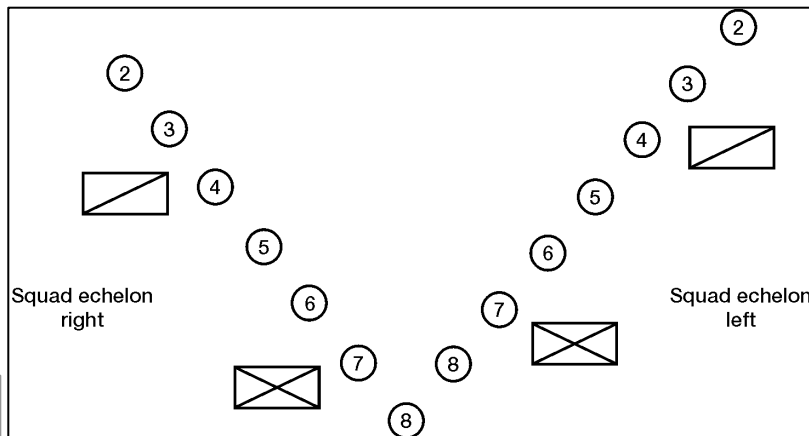

**Figure 191-378-4302-2. Squad Echelon, Right and Left**

**Note.** This formation is used offensively to turn groups in either open or built-up areas and to move crowds away from buildings, fences, or walls.

**a.** Face the squad and give the command, "Squad echelon right (or left)." Simultaneously, give hand and arm signals by extending one arm 45 degrees above the horizon and the other arm 45 degrees below the horizon, arms and hands extended. (When facing the squad, the upper arm shows the direction of the echelon.)

**b.** Point to where the squad should assemble and complete the command, "Move." (The base member will move to where you pointed. The rest of the squad will align themselves on the base member, one pace behind the member in front and one pace to the right or left, depending on the echelon.)

**c.** Position yourself behind the formation.

**4.** Direct the squad in forming a squad wedge (figure 191-378-4302-3).

---

Skill Level 3

---

**Performance Steps**

---

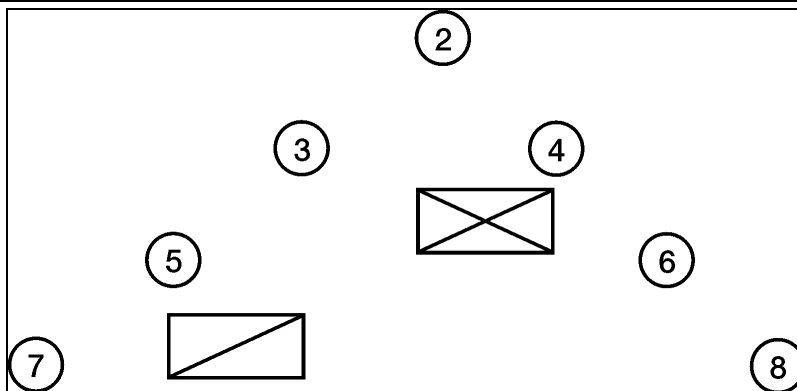

**Figure 191-378-4302-3. Squad Wedge**

**Note.** This formation is used as an offensive formation to penetrate or to split crowds.

- a. Face the squad and give the command, "Squad wedge." Simultaneously, give hand and arm signals in conjunction with the command. (Extend both arms down and to the sides at an angle of 45 degrees below the horizon, arms and hands extended, palms down.)
  - b. Point to where the squad will assemble and complete the command, "Move." (The base member will move to where you pointed. The odd numbered members align themselves behind the base member, one pace to the left and one pace to the rear of the preceding member. Even numbered personnel will do the same except to the right.)
- 5.** Tell the squad members which weapon positions to use. Each position has a specific use and is discussed below.

**Skill Level 3**

---

**Performance Steps**

---

- a. Safe port. Use when making a show of force (figure 191-378-4302-4).

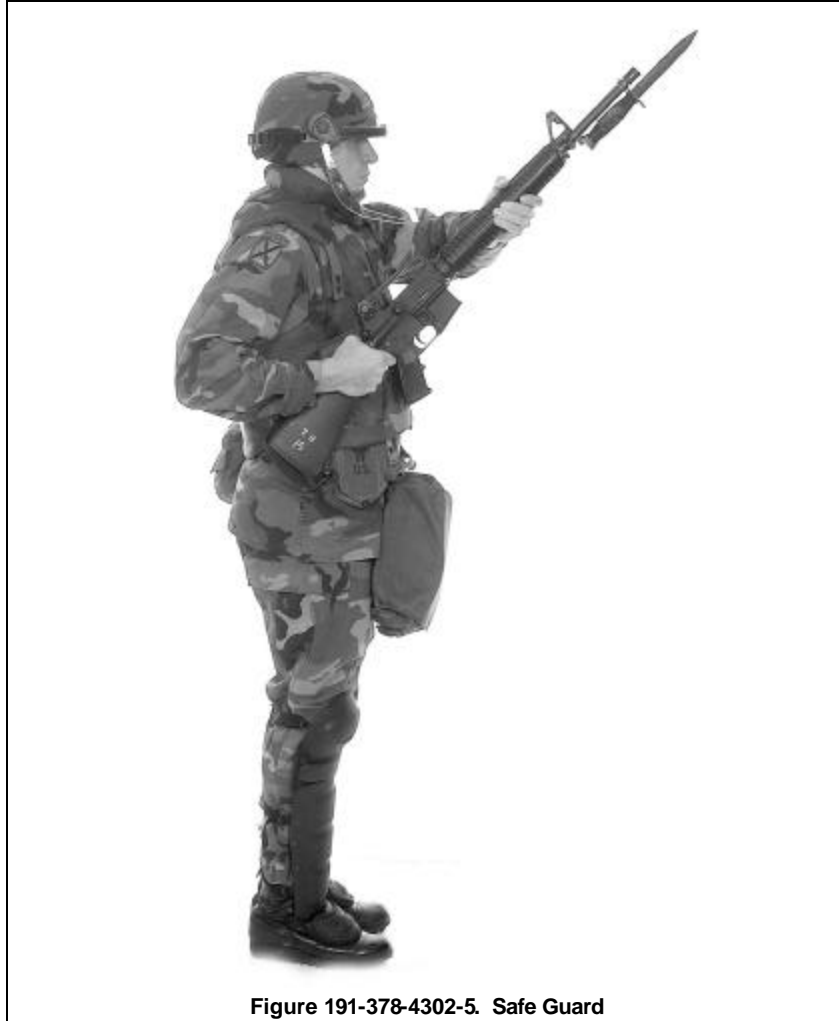

Figure 191-378-4302-4. Safe Port

- b. Safe guard. Use for semi-readiness (figure 191-378-4302-5).
- 

Skill Level 3

**Performance Steps**

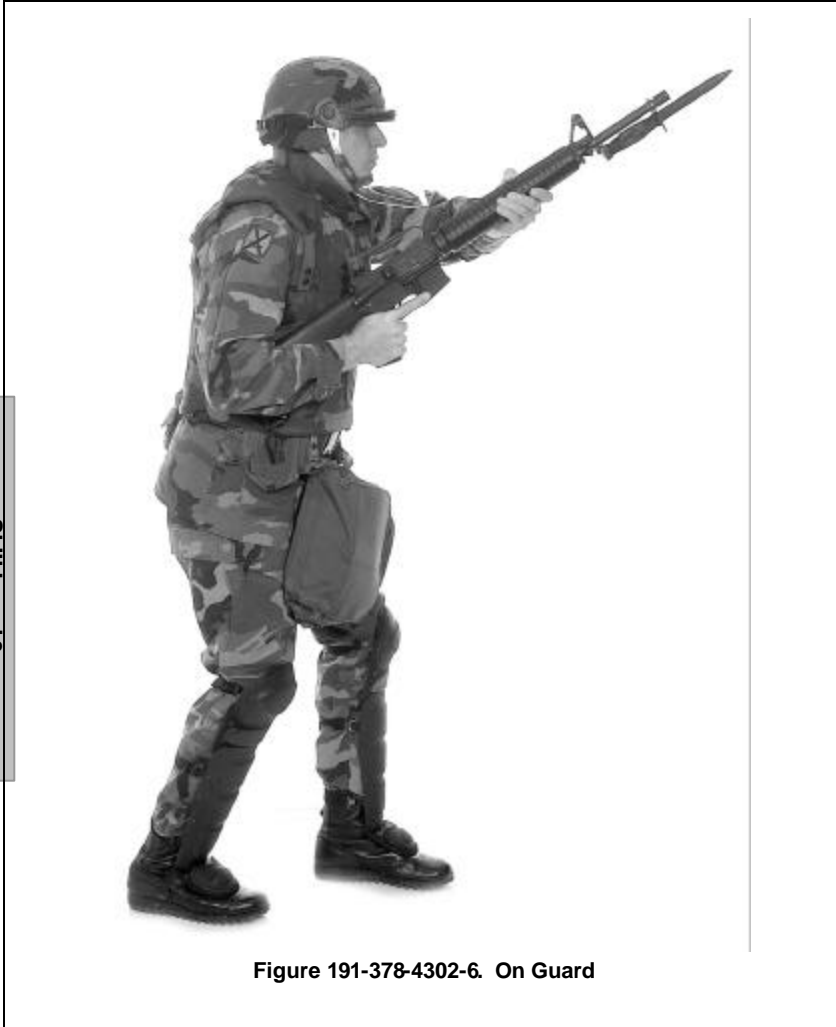

**Figure 191-378-4302-5. Safe Guard**

**c.** On guard. Use for complete readiness and when troops are in contact with a group showing any kind of resistance or hesitance to withdraw (figure 191-378-4302-6).

**Skill Level 3**

**Performance Steps**



**Figure 191-378-4302-6. On Guard**

**6. Reassemble the squad.**

**Skill Level 3**

---

**Performance Steps**

---

a. Take a position a sufficient distance to the rear of the squad and command, "Squad assemble." Simultaneously, raise your right hand in the air and make a circular motion. (The squad members who hear the command automatically come to the safe-port position. The base member faces the squad leader. The other squad members face toward the base member.)

b. Point to the place you want the squad to assemble and give the command of execution "Move." (The base member double-times to the designated spot, and the other members of the squad follow the base member. The squad forms in a column behind the base member and waits for further instruction.)

---

Performance Measures	GO	NO GO
1. Prepared the squad for formation.	___	___
2. Directed the squad in forming a squad line.	___	___
3. Directed the squad in forming a squad echelon, right and left.	___	___
4. Directed the squad in forming a squad wedge.	___	___
5. Told the squad members which weapon positions to use.	___	___
6. Reassembled the squad.	___	___

Skill Level 3

**Evaluation Guidance:** Score the soldier GO if all performance measures are passed. Score the soldier NO GO if any performance measure is failed. If the soldier fails any performance measure, show him how to do it correctly.

**References****Required**

FM 19-15

STP 19-95B1-SM

**Related**

**SUBJECT AREA 21: DEFENSE MEASURES**

**052-195-3066**

**Direct Construction of Nonexplosive Obstacles**

**Conditions:** Given a mission directive, logistical support for the type of nonexplosive obstacle, squad personnel, organic equipment, and FM 5-34.

**Standards:** Directed the construction of obstacles that were tied to existing or reinforced obstacles to block, channel, or delay the enemy according to the mission brief or intent.

**Performance Steps**

1. Analyze mission requirements using the mission, enemy, terrain, troops, time available, and civilian considerations (METT-TC) factors. Consider the following—

- a. Manpower available.
- b. Material available.
- c. Time available.
- d. Type of transportation.
- e. Site selection (take advantage of existing obstacles).
- f. Type of obstacle to be constructed.

2. Direct the construction of wire obstacles.

**Note.** When using U-shaped pickets to construct obstacles, ensure the U faces the enemy.

- a. Direct the construction of a double-apron 4- and 2-pace fence.

Ensure—

- (1) The fence centerline is laid.
- (2) The long pickets are spaced at 3-meter (4-pace) intervals.
- (3) The anchor pickets are spaced at 1.5-meter (2-pace) intervals each way from the centerline and midway between the long pickets.
- (4) All 12 wires are installed. Ensure work is done from the enemy side to the friendly side (figure 052-195-3066-1).

Skill Level 3



## Performance Steps

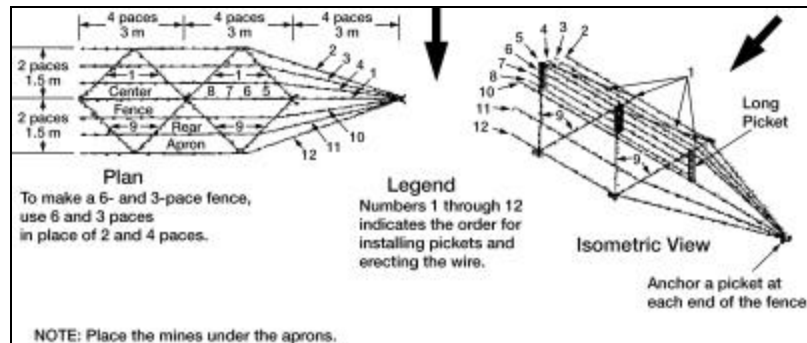

Figure 052-195-3066-1. Double-Apron Fence

**Note.** Ensure the soldier is not cut off between the enemy and the fence.

(5) The wire is tied at the beginning and end of each roll of barbed wire, as a minimum.

(6) The wires are properly secured and tight.

b. Direct the construction of a triple-standard concertina fence.

(1) Ensure work is done from the enemy side to the friendly side.

(2) Direct the installation of an anchor picket (short picket) at each end of the front and back row (2 paces).

(3) Ensure long pickets are spaced at 3.8-meter (5-pace) intervals (stagger the back row) (figure 052-195-3066-2).

Skill Level 3

**Performance Steps**

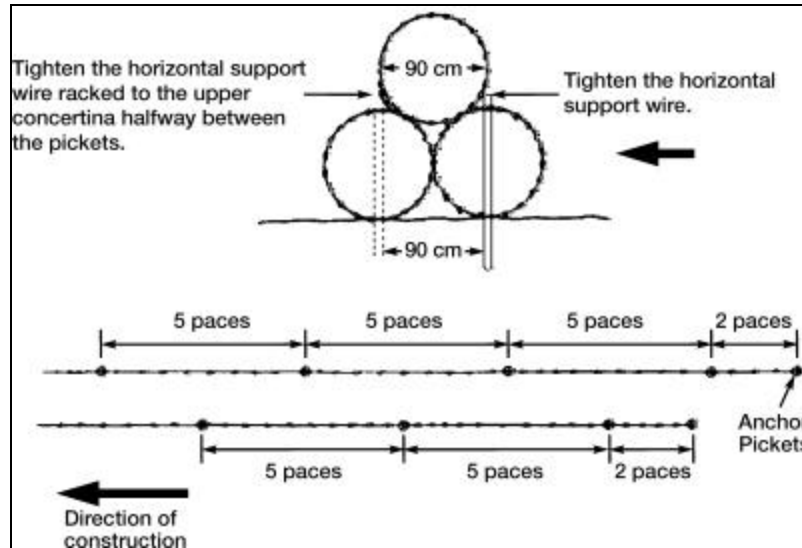
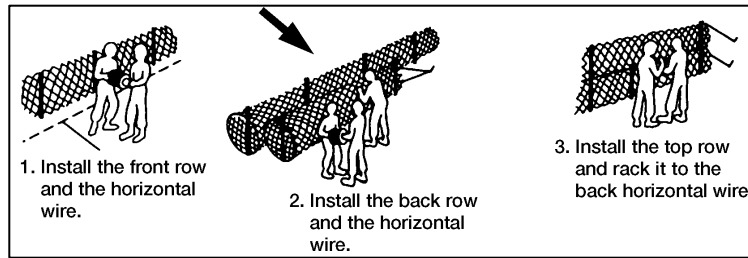

**Figure 052-195-3066-2. Triple-Standard Concertina Fence**

**Note.** Install the pickets in such a manner that the lower notch of the long picket is 4 inches above the ground.

(4) Direct the installation of concertina wire. Ensure—

(a) A roll of concertina is placed at the third picket in the front row and at every fourth picket thereafter (figure 052-195-3066-3).



**Figure 052-195-3066-3. Install Concertina and Horizontal Wire**

(b) The bottom row (concertina wire) is secured with the horizontal wire (barbed wire) (figure 052-195-3066-4).

Skill Level 3

---

**Performance Steps**

---

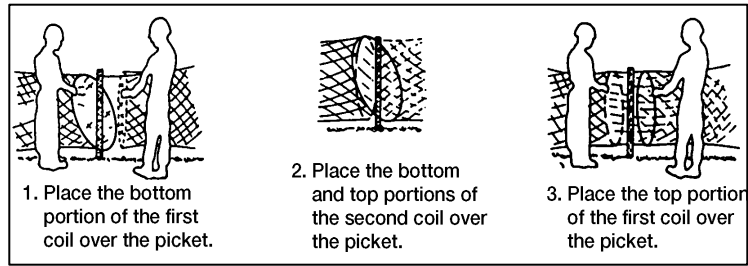

**Figure 052-195-3066-4. Join Concertina Wire**

(c) The back row (friendly side) is begun once the first team has cleared the head of the fence.

(5) Direct the installation of the remaining row of concertina wire on top of the first two rows and fasten it securely.

(6) Ensure the concertina wire is properly tied and all horizontal wire is properly installed.

c. Direct the construction of a four-strand cattle fence.

(1) Ensure an anchor picket (short picket) is installed at each end of the fence.

(2) Ensure the long pickets are installed 3 meters apart (figure 052-195-3066-5).

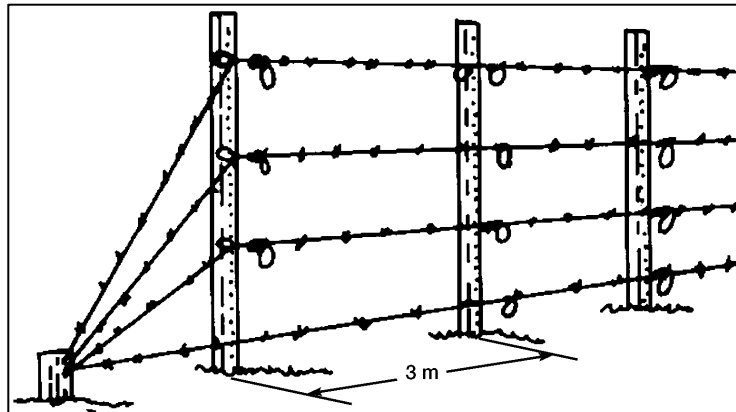

**Figure 052-195-3066-5. Four-Strand Cattle Fence**

(3) Direct the installation of the barbed wire. Ensure—

---

Skill Level 3

---

**Performance Steps**

---

(a) The reel of barbed wire is rolled out. Ensure that a row of barbed wire is used per strand.

(b) The wire is tied from the bottom strand and that it is worked upward to the top strand.

(4) Ensure the wire is taut and tied correctly.

d. Direct the construction of a knife rest.

(1) Ensure that a knife rest is prepared 3 to 5 meters long (figure 052-195-3066-6). Ensure—

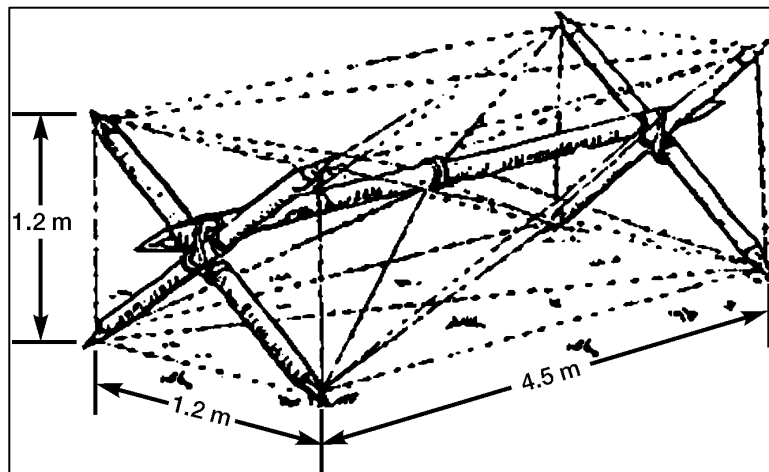

Figure 052-195-3066-6. Knife Rest

(a) The end poles (1.2 meters in height and width) are lashed to form two Xs.

(b) The center pole is lashed to the two Xs.

(c) Barbed wire is used to complete the knife rest.

(2) Ensure the knife rest is secured to the ground.

e. Direct the construction of an 11-row obstacle out of concertina wire.

(1) Ensure long pickets are installed at 3.8-meter (5-pace) intervals for 11 rows (figure 052-195-3066-7).

---

Skill Level 3

---

## Performance Steps

---

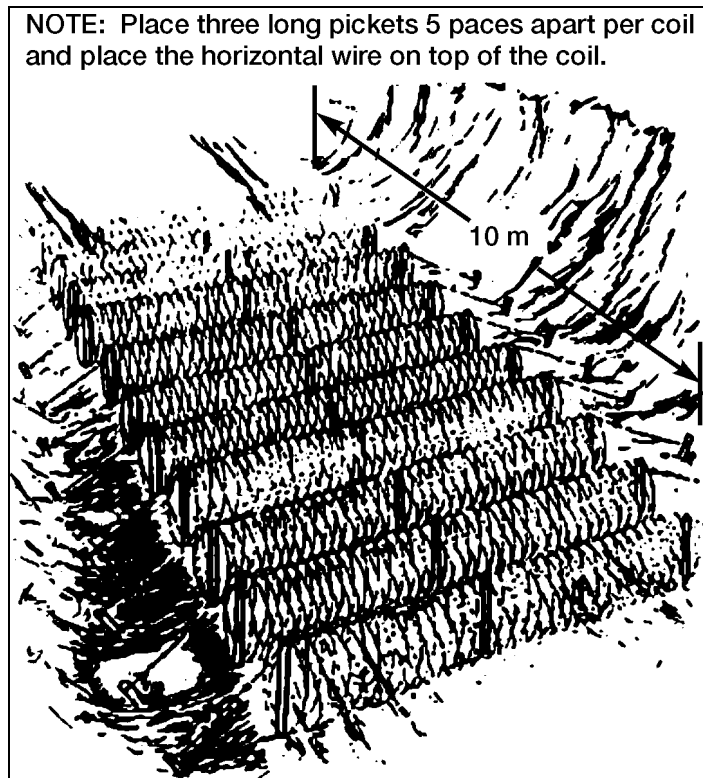

Figure 052-195-3066-7. Eleven-Row Obstacle

- (2) Direct the placement of concertina wire over the long pickets.
  - (3) Ensure the horizontal wire (barbed wire) is anchored to the anchor stakes 1.5 meters (2 paces) from each end of the concertina rows.
  - (4) Ensure the horizontal wire is secured over the concertina wire.
  - (5) Ensure that a log 20 centimeters in diameter is placed between the fifth and sixth row.
  - (6) Ensure the obstacle is no less than 10 meters deep.
3. Direct the construction of log obstacles.

**Note.** When constructing a log crib, use only logs with a 20-centimeter diameter minimum.

Skill Level 3

---

**Performance Steps**

---

- a. Direct the construction of a triangular log crib (figure 052-195-3066-8). Ensure—

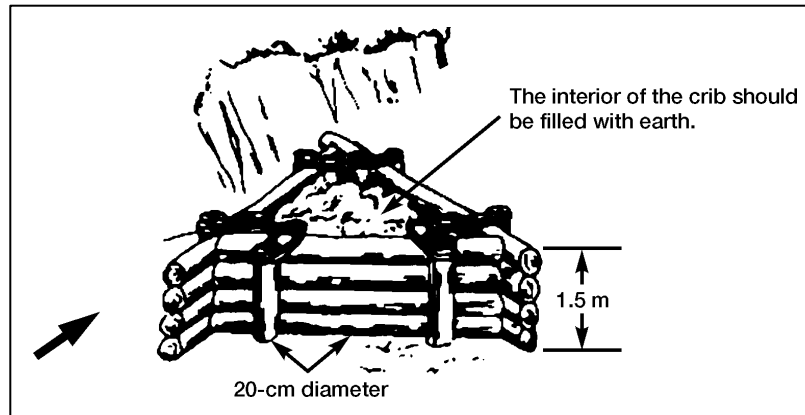

**Figure 052-195-3066-8. Triangular Log Crib**

- (1) The vertical postholes are marked and dug 1.5 meters deep. Ensure one corner of the log crib is facing toward the enemy and four 3-meter posts are used per wall.
- (2) The 12 horizontal logs (four per wall) are cut to roadway width.
- (3) The vertical logs are emplaced and tamped into place.
- (4) The horizontal logs are emplaced and posts are lashed together with wire.
- (5) The interior of the crib is filled with earth material taken from the enemy side of the obstacle.
- b. Direct the construction of a rectangular log crib (figure 052-195-3066-9 and table 052-195-3066-1). Ensure—

Skill Level 3

**Performance Steps**

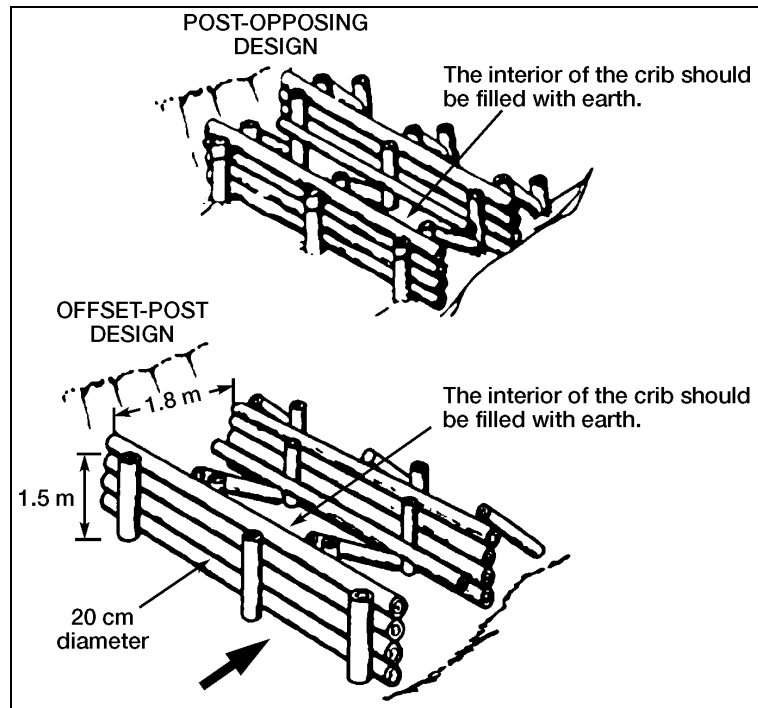

Figure 052-195-3066-9. Rectangular Log Crib

Skill Level 3

Table 052-195-3066-1. Post Requirements (Post Opposing/Offset Post Designs)								
Posts	Road Width (m)							
	1.8	2.1 to 3.6	3.9 to 5.4	5.8 to 7.3	7.6 to 9.1	9.4 to 10.9	11.3 to 12.8	13.1 to 14.6
<b>Long 3</b>	8	12	16	20	24	28	32	36
<b>Short 2.1</b>	2	3	4	5	6	7	8	9
<b>Braces 2.1</b>	4	6	8	10	12	14	16	18

**Note.** A rectangular log crib can be emplaced with the post opposing design or the offset-post design.

---

**Performance Steps**

---

(1) The vertical postholes are dug and marked 1.5 meters deep. Use table 052-195-3066-1 for post requirements.

(2) The horizontal logs (four per wall) are cut to the roadway width.

(3) The vertical logs are emplaced 1.8 meters apart and tamped into place.

(4) The horizontal logs are emplaced and posts, logs, and braces are lashed with wire.

(5) The interior of the crib is filled with earth material taken from the enemy side of the obstacle.

c. Direct the construction of a log hurdle obstacle (figure 052-195-3066-10). Ensure—

---

Skill Level 3



**Performance Steps**

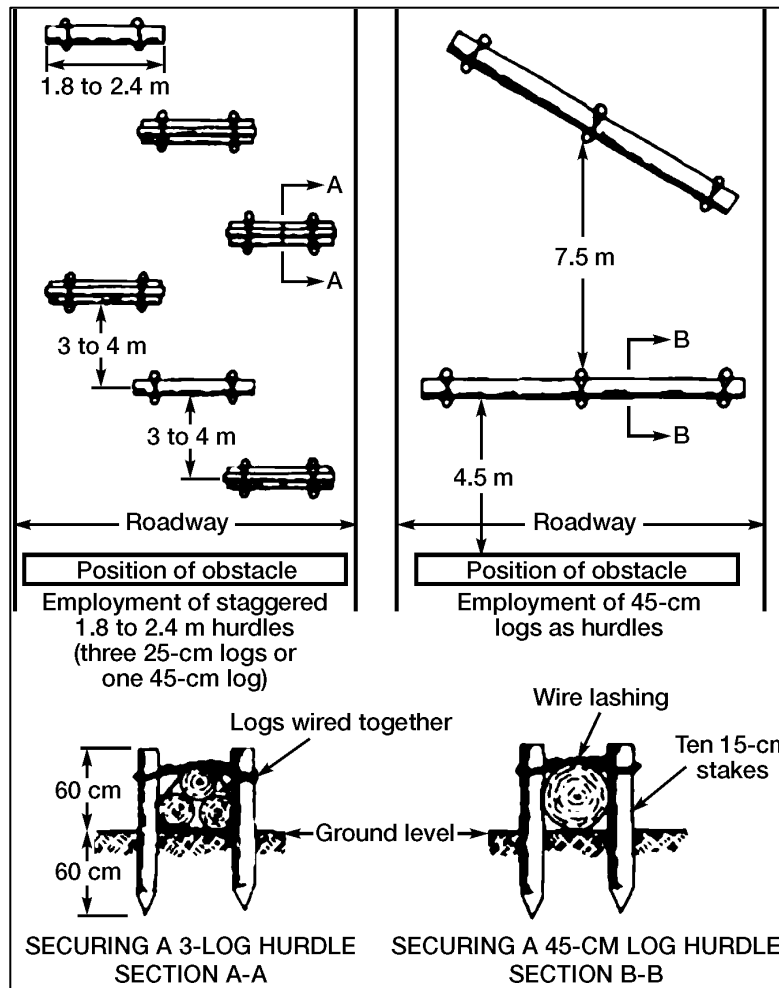

Skill Level 3

**Figure 052-195-3066-10. Log Hurdles**

**Note.** Select a site where the log hurdles cannot be readily bypassed. Hurdles are constructed on the steepest part of a slope.

- (1) Logs are cut 1.8 to 2.4 meters long.

---

**Performance Steps**

---

(2) Three logs 25 centimeters in diameter or one log 45 centimeters in diameter are used.

(3) Logs are staked firmly in place. Ensure stakes are no more than 1.5 meters apart.

(4) The log poles are lashed to the stakes with wire.

(5) The securing stakes are buried a minimum of 60 centimeters in the ground with 60 centimeters remaining above ground.

d. Direct the construction of a log post obstacle (figure 052-195-3066-11). Ensure—

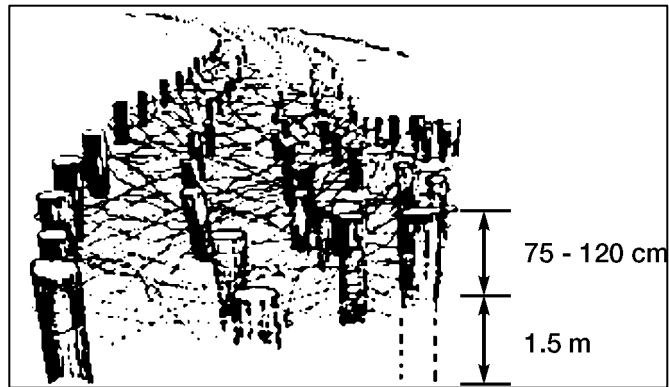

Figure 052-195-3066-11. Log Post Obstacle

(1) A minimum of four rows of posts are emplaced.

(2) Posts are cut in varying lengths from 2 to 3 meters.

**Note.** The diameter of the timber is 40 centimeters minimum.

(3) Postholes are dug 1.5 meters underground.

(4) Posts are emplaced at irregular distances of 1 to 2 meters and at irregular heights of 75- to 120-centimeters above ground. Ensure posts are buried vertically or at a slight angle toward the enemy.

(5) The barbed wire is attached to posts in an irregular pattern.

4. Direct the construction of tank ditch obstacles (figure 052-195-3066-12).

---

Skill Level 3

Performance Steps

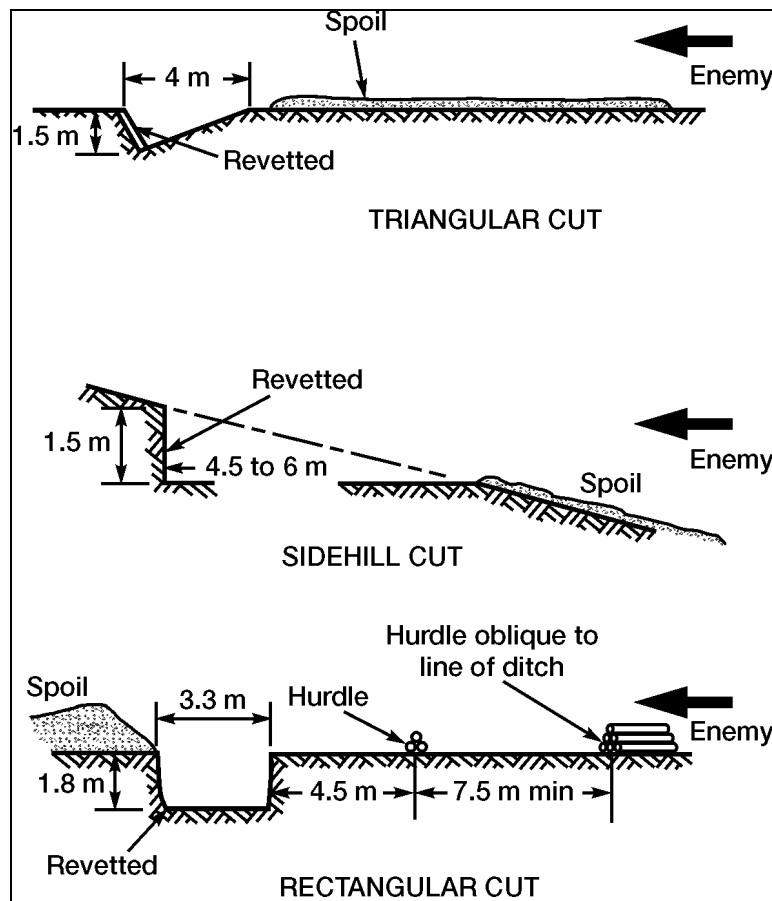

Skill Level 3

Figure 052-195-3066-12. Tank Ditches

a. Direct the construction of a rectangular tank ditch obstacle.  
Ensure—

(1) The T-push method is used with a dozer/dozer, dozer/loader, dozer/armored combat earthmover (ACE), ACE/ACE, or ACE/loader team configuration.

(2) The tandem method is used with a scraper/scraper, scraper/ACE, or a scraper/dozer team configuration.

---

**Performance Steps**

---

- (3) The ditch is dug a minimum of 1.5 meters deep and 3.3 meters wide.
- (4) The berm is placed on the friendly side of the ditch.
- b. Direct the construction a triangular tank ditch obstacle. Ensure—
  - (1) The T-push method is used with a dozer/dozer, dozer/loader, dozer/ACE, ACE/ACE, or ACE/loader team configuration.
  - (2) The ditch is dug a minimum of 1.5 meters deep and 4 meters wide.
  - (3) The spoil is spread on the enemy side of the ditch.
- c. Direct the construction a sidehill-cut tank ditch obstacle. Ensure—
  - (1) The T-push method is used with a dozer/dozer, dozer/loader, dozer/ACE, ACE/ACE, or ACE/loader team configuration.
  - (2) The one-dozer or ACE method is used.
  - (3) The tank ditch is cut a minimum of 1.5 meters deep and 4.5 to 6 meters wide.
  - (4) The spoil is spread on the enemy side of the ditch.
- 5. Direct the construction of barrier obstacles.
  - a. Ensure barrier materials are obtained. Barrier materials include—
    - (1) Steel hedgehogs and tetrahedrons (figure 052-195-3066-13).

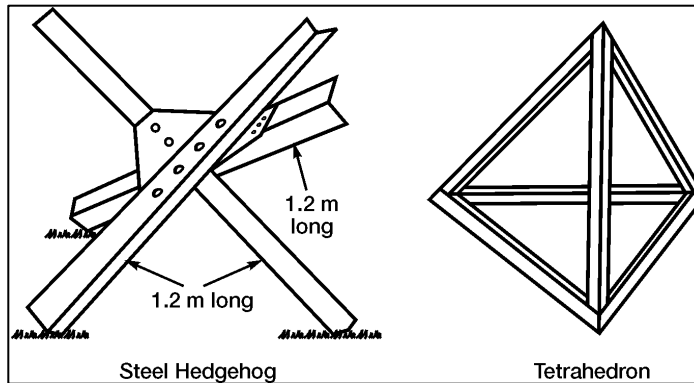
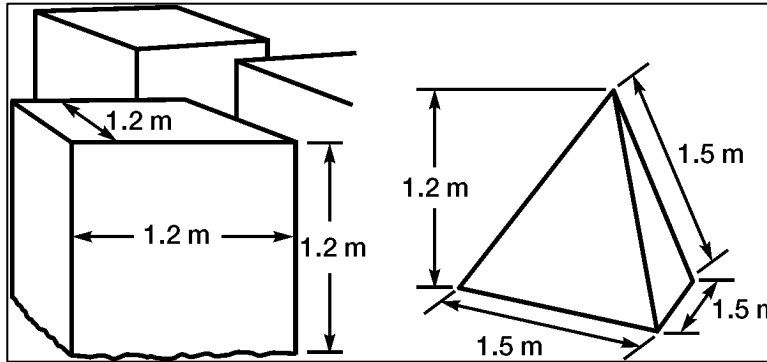

Figure 052-195-3066-13. Steel Hedgehog and Tetrahedron

- (2) Concrete cubes and tetrahedrons (figure 052-195-3066-14).

Skill Level 3

**Performance Steps**



**Figure 052-195-3066-14. Concrete Cubes and Tetrahedron**

**(3) Jersey barriers (figure 052-195-3066-15).**

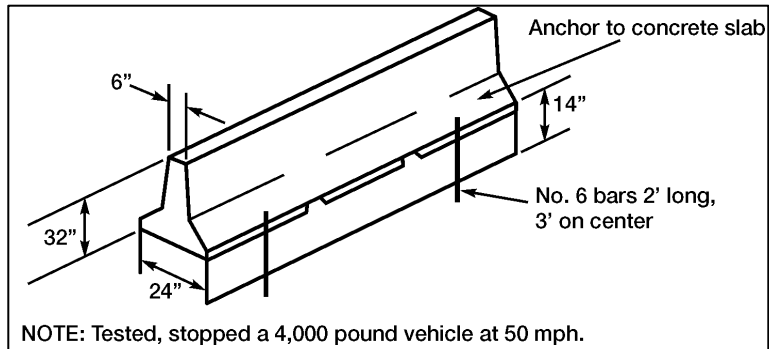

**NOTE: Tested, stopped a 4,000 pound vehicle at 50 mph.**

**Figure 052-195-3066-15. Jersey Barrier**

**b. Ensure barrier materials (figure 052-195-3066-16) are emplaced.**

**Skill Level 3**

**Performance Steps**

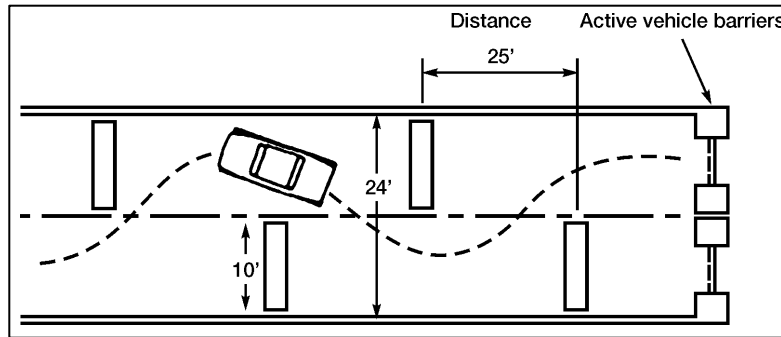

**Figure 052-195-3066-16. Concrete Obstacle Placement**

**Note.** The distance between barriers will vary depending on the type of traffic expected (cars, trucks, or semitrailers).

**Evaluation Preparation:**

*Setup:* Provide the soldier with the items listed in the conditions. Provide him with a mission brief describing the type of obstacle to be emplaced.

*Brief Soldier:* Tell the soldier to direct the construction of the obstacle according to the mission brief.

Skill Level 3

Performance Measures	GO	NO GO
1. Analyzed mission requirements using the METT-TC factors.	___	___
2. Directed the construction of wire obstacles.	___	___
3. Directed the construction of log obstacles.	___	___
4. Directed the construction of tank ditch obstacles.	___	___
5. Directed the construction of barrier obstacles.	___	___

**Evaluation Guidance:** Score the soldier GO if all performance measures are passed. Score the soldier NO GO if any performance measure is failed. If the soldier fails any performance measure, show him how to do it correctly.

**References**

Required	Related
FM 5-34	FM 5-102

---

## 071-410-0019

### Control Organic Fires

**Conditions:** Given a unit equipped with TOE weapons, attached fire support elements (machine gun teams, antitank teams, TOW squad, BFV), an area of responsibility, and the requirement to regulate the fire of all weapon systems assigned or attached to your unit.

**Standards:** Assigned sectors of fire for each individual and crew-served weapon; issued a priority of target engagement appropriate for each weapon system; informed all personnel of current rules of engagement (ROE); and implemented procedures to engage threat targets in your area of responsibility in a timely manner, with the appropriate weapon system, and without causing injury or death to friendly personnel.

---

#### Performance Steps

##### WARNING

Soldiers may be killed or injured when firing weapons. Minimum firing distances, backblast areas, and weapon-specific regulations must be strictly followed.

1. Implement procedures to apply the following principles of fire control:
  - a. Avoid target overkill; keep in mind ammunition conservation.
  - b. Use each weapon in its intended role.
  - c. Concentrate on engaging targets that offer a high probability of a kill.
  - d. Concentrate on engaging long-range targets first.
  - e. Destroy targets that pose the greatest threat first.
2. Use fire control methods to—
  - a. Maximize the effects of the weapons on the target.
  - b. Achieve mutual support.
  - c. Provide coverage of assigned area of responsibility.
  - d. Ensure soldiers' safety from friendly fire.
3. Use the following methods to coordinate and regulate fire.
  - a. Assign sectors of fire. Assign an area for each crew-served weapon, team, or unit to cover by fire. Targets in each assigned sector are the responsibility of the individual(s) assigned to cover the area with fire.

Skill Level 3

---

**Performance Steps**

---

**b.** Assign priority of fires. Tell each soldier, according to weapon assignment, what to fire at, when, and why. This ensures each weapon is used in the role for which it is best suited. (For example, Dragon gunners engage light armored vehicles; BFV gunners engage tanks with the TOW and BMPs with the 25-mm; riflemen engage dismounted personnel out to 400 meters.)

**c.** Use target reference points (TRPs). Designate recognizable points on the ground (natural or manmade) to use as reference points when identifying sectors of fire or targets, or to control supporting fires.

**d.** Assign final protective fire areas. Assign final protective lines (FPL) or principal direction of fire (PDF) for machine guns and other automatic crew-served weapons, ground- or carrier-mounted (MK 19, BFV coaxial, 25-mm, and so on).

**4.** Use any of the following techniques to communicate when to start, shift, or cease fire.

**a.** Prearranged signals. Use visual or sound signals (pyrotechnics, whistles, horns, detonation of a device, or firing of a weapon), or set a specific time.

**b.** Arm-and-hand signals. Use standard signals when feasible. Remember, personnel must see arm-and-hand signals in order to respond.

**c.** Fire by example. Initiate firing at, or in the direction of, the intended target and have the unit or specific weapon system follow your example.

**d.** Fire commands. Some elements of fire commands may be omitted. If any element is omitted, ensure the unit or crew thoroughly understands the command. Every fire command should contain the target description and execution element as a minimum. (See tables 071-410-0019-1 and 071-410-0019-2 for examples of fire command elements.)

---

Skill Level 3



**Performance Steps**

Table 071-410-0019-1. Examples of Fire Command Elements				
<i>Elements</i>	<i>TOW Squad</i>	<i>Antitank Team</i>	<i>Crew-Served Weapon</i>	<i>Units</i>
1. Alert	Fire Mission or Squad	Fire Mission Gun # 1	Fire Mission Gun # 3	Fire Mission, A team, 1 <sup>st</sup> squad, etc.
2. Description (direction optional)	Tank	PC	Truck with Troops	Troops
2A. Direction (if used)	Front, 11 o'clock (clock method)	Right Front, 2 o'clock (clock method)	Left of Lone Pine Tree (TRP method)	Center of Sector
3. Range (in meters)	1,000	600	400	200
4. Method of Fire	Frontal, Depth, or Crossfire (situation dependent)	Single, Pair, Volley, or Sequence (situation dependent)	Sustained, Search, or Traverse, or Combination (situation dependent)	Sustained, or Until Target is Defeated
4A. Type Missile	TOW 2 TOW 2A	Dragon AT-4		
5. Execution	Fire, or At My Command	Fire, or At My Command	Fire, or At My Command	Fire, or At My Command
6. Closing	Cease Tracking or Cease Tracking, Out of Action	Cease Tracking or Cease Tracking, Out of Action	Cease Fire	Cease Fire

**Skill Level 3**

**Performance Steps**

Table 071-410-0019-2. Examples of fire command elements for a BFV

Elements	Gunnery Techniques	
	Battlesight	Precision
1. Alert	Gunner	Gunner
2. Weapon/Ammunition	Battlesight	SABOT HE Coax Missile
3. Description	Tank, Chopper, Truck, Troops, PC	PC, Truck, Troops, Tank
4. Direction (optional)	Shift Right (Left), TRP-1 (TRP method) or 2 o'clock (clock method)	Shift Right (Left) TRP-1 (TRP method) or 2 o'clock (clock method)
5. Range (in meters)		
Gunner ID*	Identified	600 Identified
6. Execution	Fire, or At My Command	Fire, or At My Command
Gunner's response	On the way	On the way
7. Closing	Cease Fire	Cease Fire
*If the BFV gunner cannot identify the target, the Bradley commander (BC) engages the target from his position. The BC announces "From my position, on the way." "Fire" is not announced.		

Skill Level 3

**(1)** Use fire commands to direct the fires of units or key weapons and to place a specific type fire on certain targets. Fire commands for some weapon systems may vary in form because of weapon characteristics. They should identify who is to fire, the direction of fire, type of ammunition, type of target, range, and when to fire.

**(2)** Correct errors in fire commands by stating "CORRECTION," correcting the element in error, then repeating all elements following the corrected element.

**(3)** Use subsequent fire commands to adjust for range or new targets. For example, shift left (or right) up (or down) and designate new target. For subsequent fire commands for a Bradley, use shift left (or right) PC and up (or down) half or full target frame.

---

**Performance Steps**

---

(4) Develop standing operating procedures (SOPs) and drills for certain actions and commands to make fire control more effective.

**CAUTION**

Dispose of all belt links and spent brass in accordance with unit SOP.

---

**Evaluation Preparation:**

*Setup:* This task should be evaluated during a field training exercise on a live-fire range. Otherwise, assign a defensive position to a fire team, and designate team and individual sectors of fire. Provide appropriate ammunition for the weapons assigned. Target areas should represent various types of targets, such as an enemy column formation, a line formation, or a linear target with depth.

*Brief Soldier:* Tell the soldier to have his team engage the various targets and to use the appropriate weapons on the targets.

Performance Measures	GO	NO GO
1. Assigned individual sectors of fire.	___	___
2. Issued a fire command to engage a target.	___	___
3. Issued subsequent fire commands, as necessary.	___	___
4. Gave the arm-and-hand signals to control fires.	___	___
5. Used unit SOP to engage a target. (Graded only if unit has an SOP for team/squad fire.)	___	___
6. Used appropriate weapon(s) on target.	___	___

Skill Level 3

**Evaluation Guidance:** Score the soldier GO if all performance measures are passed. Score the soldier NO GO if any performance measure is failed. If the soldier fails any performance measure, show what was done wrong and how to do it correctly.

**References****Required****Related**

AR 385-63

FM 21-75

FM 23-1

FM 23-14

---

## 441-091-3000

### Supervise the Implementation of Air Defense Measures

**Conditions:** You are a leader in a tactical combat situation. Given the concept of operations from your higher headquarters, employ your direct fire weapons as an effective method of defense against attacking enemy aircraft. You will use this method in conjunction with passive air defense techniques and will provide effective air defense protection with or without specific supporting air defense (AD) assets.

**Standards:** Established and directed unit air defense posture. Ensured 100 percent use of available passive defense measures. Planned for employment of all available individual and crew-served weapons capable of being directed against enemy air threats. Ensured hostile targets engaged were destroyed, neutralized, or suppressed.

---

#### Performance Steps

- Skill Level 3**
1. Prepare and brief unit personnel on each of the following battle data and information:
    - a. Air dimension of the intelligence preparation of the battlefield (IPB) process. (Includes the portion of the IPB process that provides intelligence data.)
      - (1) Threat overview.
      - (2) Estimate hostile air strength.
    - b. Terrain analysis. (Briefs analysis data for friendly elements.)
      - (1) Observation and fields of fire.
      - (2) Air avenues of approach. Air routes of an attacking force.
  2. Brief the rules of engagement (ROE). Rules of engagement are the positive and procedural management directives. Specify the circumstances and limitations under which your unit initiates or continues a combat engagement.
    - a. Right of self-defense. When under attack, the right of self-defense takes precedence over any other established rules and procedures that normally govern engagements.
    - b. Hostile criteria. Specify which detected targets and under what circumstances they are considered hostile.
    - c. Air defense warning (ADW). (Provide status of air defense conditions.)
      - (1) ADW Red. Attack by hostile aircraft or missiles is imminent or in progress.
      - (2) ADW Yellow. Attack by hostile aircraft or missiles are probable.

---

**Performance Steps**

---

(3) ADW White. Attack by hostile aircraft or missiles are improbable.

d. Weapon control status (WCS). Describe the relative degree in effect under which the fires of air defense systems are managed:

(1) Weapons Free. Fire at any aircraft not positively identified as friendly.

(2) Weapons Tight. Fire only at aircraft positively identified as hostile.

(3) Weapons Hold. Do not fire except in self-defense or in response to a formal order.

e. Local air defense warning (LADW). Provide the LADW status:

(1) Dynamite. Air platforms are inbound or are attacking; response is immediate.

(2) Lookout. Air platforms are in the area of interest, but are not threatening, or they are inbound with time to react.

(3) Snowman. No air platforms pose a threat at this time.

f. Method of receiving directed early warning with or without an Air and Missile Defense Officer (AMDO):

(1) AMDO disseminates local air defense warning on supported unit net. ("Dynamite! Dynamite! Four Hinds heading East at Phase Line Blue.")

(2) Without an AMDO, the unit may monitor the early warning net.

3. Establish air attack warning systems and include search and scan techniques.

a. Establish visual warnings (hand signal, flag).

b. Establish audible warnings (vehicle, horn, whistle, siren, and voice).

c. Position air watch sentries in the unit's area of operation.

d. Position air guards in a convoy.

e. Apply search and scan techniques.

4. Enforce passive air defense measures.

**Note.** Passive air defense measures are all measures, other than active defense, taken to minimize the effects of the hostile air action. Passive defense measures are of two types: attack avoidance and damage, limiting measures that include the use of protective cover, concealment, camouflage, and deception.

a. Attack avoidance measures. Include concealment, camouflage, and deception.

(1) Use available concealment (hiding, blending, and disguising).

---

Skill Level 3

---

**Performance Steps**

---

- (2) Use natural and manmade materials for camouflage effectively.
- b. Damage limiting measures (dispersion, protective construction, and use of cover).
  - (1) Use dispersion, protective construction, and cover effectively.
  - (2) Select position(s) that cannot be seen from the air.
- 5. Direct engagement of hostile air targets using combined arms for air defense procedures.
  - a. Volume and mass fire.
  - b. For correct leads, use football field lengths.
  - c. Aiming points for helicopters, fixed-wing aircraft, cruise missiles and unmanned aerial vehicles (UAV).
  - d. Firing positions for small arms. Select and use natural and manmade positions.
  - e. Aircraft engagement techniques for missile systems.

**Evaluation Preparation:** Evaluate this task during a field exercise, during improved moving target simulator (IMTS) training, or as part of lane training. Provide the soldier with the mission and concept of operations, maps, and overlays for air intelligence preparation of the battlefield (IPB) development and employment of assets. Ensure sufficient equipment is available for passive air defense measure implementation. Provide live air or drone aircraft for target detection, identification, and engagement.

**Note.** If live air, IMTS, or drone aircraft are not available, aircraft recognition can be performed using aircraft recognition cards or other multimedia techniques.

*Brief Soldier:* Tell the soldier that he is to plan for and employ all available assets capable of being directed against enemy air threats, fully implement passive air defense measures (in the offense or defense), communicate air defense warnings and weapons control status, and destroy, neutralize, or suppress all enemy air threats.

<b>Performance Measures</b>	<u>GO</u>	<u>NO GO</u>
1. Prepared and briefed unit personnel on the following battle data and information.	—	—
a. Air dimension of the IPB process. Included the portion of the IPB process that provides intelligence data.		
(1) Threat overview.		
(2) Estimated hostile air strength.		
b. Terrain analysis.		

<b>Performance Measures</b>	<b>GO</b>	<b>NO GO</b>
(1) Observation and fields of fire.		
(2) Air avenues of approach; air routes of an attacking force.		
2. Briefed ROE to unit personnel specifying the circumstances and limitations under which the unit would initiate or continue a combat engagement.	—	—
a. Right of self-defense. When under attack, the right of self-defense took precedence over any other established rules and procedures that normally govern engagements.		
b. Hostile target criteria specifying which targets, when detected, were friendly or hostile.		
c. ADW in effect.		
d. WCS in effect.		
e. LADW in effect.		
f. Methods of disseminating early warning information and data.		
3. Directed establishment of an air attack warning system.	—	—
a. Established visual warnings.		
b. Established audible warnings.		
c. Positioned air watch sentries.		
d. Performed search and scan procedures.		
4. Enforced passive air defense measures using:	—	—
a. Attack-avoidance measures.		
(1) Used concealment principles.		
(2) Used available concealment.		
(3) Used natural and manmade materials for camouflage effectively.		
b. Damage limiting measures.		
(1) Selected positions with natural covering.		
(2) Used dispersion, protective construction, and cover effectively.		
5. Directed engagements of hostile aircraft using combined air defense procedures.	—	—

Skill Level 3

Performance Measures	GO	NO GO
a. Applied proper engagement procedures.		
(1) Volume and massing fire.		
(2) Football field technique.		
(3) Ensured proper aiming points were used for flight directions of hostile aircraft.		
b. Applied firing positions for small arms.		
c. Applied aircraft engagement techniques for missile systems.		

**Evaluation Guidance:** Score the soldier GO if he passes all performance measures. Score the soldier NO GO if he fails any performance measures. If the soldier fails any performance measures, explain and or show him what was done wrong and how to perform the measures correctly.

#### References

##### Required

##### Related

FM 5-103  
 FM 20-3  
 FM 34-130  
 FM 44-8  
 FM 44-80  
 FM 44-100

Skill Level 3

#### SUBJECT AREA 22: UNIT OPERATIONS

### 071-326-3013

#### Conduct a Tactical Road March

**Conditions:** You are an acting platoon sergeant/platoon leader given a platoon with TOE weapons, personnel, equipment, operational vehicles with BII, a 1:50,000 military map of the road march area, a warning order, and an overlay of your route. You are under radio listening silence until detected or engaged or when a SPOTREP/STATREP must be sent.

**Standards:** Within the time allowed in your warning order, planned, organized, and conducted a tactical road march from one point to an assembly area, and secured the assembly area.



---

### Performance Steps

---

1. Control actions in assembly area.
  - a. Ensure quartering party NCO guides section/platoon into area.
  - b. Clear section/platoon release point quickly.
  - c. Ensure one man for each vehicle mans weapon, monitors radio, and observes vehicle sector.
  - d. Set up OPs.
  - e. Check primary positions and sectors; adjust if necessary.
  - f. Camouflage positions.
  - g. Start rest plan.
  - h. Ensure range cards are prepared.
  - i. Locate troop command post.
  - j. Coordinate with flank elements.
  - k. Select and prepare alternate positions.
  - l. Prepare the platoon fire plan, brief the vehicles commanders , and send a copy of the plan to troop commander.
  - m. Ensure maintenance is performed.
  - n. Check personnel and equipment status; report to platoon leader/team/troop commander.
  - o. Resupply.
  - p. Check security.
2. Plan sequence for a tactical road march.
  - a. Prepare and issue your warning order.
  - b. Prepare an estimate of the situation.
  - c. Organize and dispatch reconnaissance and quartering parties in accordance with unit SOP.
  - d. Prepare detailed movement plans.
    - (1) Organize the march.
    - (2) Review reconnaissance information.
  - e. Prepare and issue the complete march order.
3. Issue the march order. The order includes —
  - a. Destination (map).
  - b. Route of march (map).
  - c. Location of start point (SP), critical points, and release point (map).
  - d. Start point time.

Skill Level 3

---

**Performance Steps**

---

- e. March interval (in meters).
  - f. March speed.
  - g. Catch-up speed.
  - h. Time to leave present position.
  - i. Order of march.
4. Organize the march.
- a. Ensure that march columns, regardless of size, are composed of three elements: head, main body, and trail.
    - (1) The head is the first vehicle of the column and normally sets the pace.
    - (2) The main body is made up of the major elements of column serials and march units.
    - (3) The trail party follows the march column and includes personnel and equipment needed for emergency vehicle repair and recovery, medical aid and evaluation, and unscheduled refueling.
  - b. Ensure that vehicle commanders assign sectors of observation so there is 360-degree observation around their vehicles. Each vehicle commander must designate an airguard to provide air security.
5. Control the march.
- a. Follow the route specified in the warning order.
  - b. Enter the route of march at the SP.
  - c. Adjust the march at critical points if movement is slow or difficult or where vehicles may lose their way.
  - d. Release sections to their mission responsibilities.
  - e. Ensure march speed and catch-up speeds are specified in the warning order.
  - f. Maintain the order of march. This includes order of squads in the column and vehicles in the section.
  - g. Maintain the march interval.
  - h. Close the column intervals during periods of limited visibility.
  - i. Open the column during periods of good visibility.
6. Control actions at halts.
- a. Establish security off-road (when possible).
  - b. Man weapons and radio on each vehicle; ensure each vehicle sector is observed.
  - c. Maintain air guard.
- 

Skill Level 3

---

**Performance Steps**

---

- d. Dismount OP if visibility is poor.
  - e. Post guides to help other traffic pass.
  - f. Determine cause of halt (if unscheduled).
  - g. Eliminate cause of halt.
  - h. Report status to platoon leader/troop commander.
  - i. Perform maintenance at scheduled halts.
- 

**Evaluation Preparation:**

*Setup:* At the test site, provide all equipment and materials given in the task conditions statement, and the opportunity to issue a warning order. The task is performed along the specified route within the time allowed in your warning order. This task is performed as part of field training exercises.

*Brief Soldier:* You are required to conduct a tactical road march using the equipment stated in the task conditions statement and route specified in your warning order.

Performance Measures	GO	NO GO
1. Conducted each step in the planning sequence for a tactical road march.	—	—
2. Ensured all actions in the assembly area were performed.	—	—
3. Issued the march order in its entirety.	—	—
4. Identified two of the three elements of the march columns.	—	—
5. Organized the march.	—	—
6. Ensured all actions at halts were performed.	—	—

Skill Level 3

**Evaluation Guidance:** Score the soldier GO if all performance measures are passed. Score the soldier NO GO if any performance measure is failed. If the soldier scores NO GO, show what was done wrong and how to do it correctly.

**References****Required**

FM 7-7  
FM 17-95  
FM 3-21.71  
FM 7-8

**Related****Skill Level 3****071-326-3013****3-259**

---

## 071-326-5805

### Conduct a Route Reconnaissance Mission

**Conditions:** Given a platoon, a 1:50,000 map of the area of operation, and a mission to conduct a route reconnaissance.

**Standards:** Planned and conducted a route reconnaissance well enough to—

1. Organize the platoon to conduct the reconnaissance mission.
2. Use movement techniques appropriate for the likelihood of enemy contact.
3. Obtain necessary information concerning the conditions, obstacles, critical terrain features, and enemy along the assigned route.

---

#### Performance Steps

1. Plan the reconnaissance. Receive the order.
  - a. Issue a warning order.
  - b. Gather information and prepare an operations order based on the factors of METT-TC.
  - c. Ensure the plan is as detailed as possible and include the exact information to be obtained, the time by which the information is to be reported, where the information is to be reported, where the information is to be sought, action to be taken upon enemy contact, and when the mission is to be executed. Essential details include:
    - (1) Pertinent information on the enemy, friendly troops, and the area of operations.
    - (2) Proposed plans of higher commands, to include anticipated traffic flow along the route and types of vehicles to be employed.
    - (3) When, where and how information is to be reported.
    - (4) Time of departure.
    - (5) Appropriate control measures.
    - (6) Action to be taken when the mission is completed.
    - (7) Special equipment requirements.
    - (8) Terrain considerations. Existing routes and their physical characteristics:
      - (a) Gradients of slope and radii of curvature.
      - (b) Bridges.
      - (c) Vehicular fording, ferrying, and swimming sites.
      - (d) Tunnels, under passes, and similar obstructions to traffic flow.

Skill Level 3

---

**Performance Steps**

---

(e) Artificial obstacles, such as areas of chemical, biological, and radiological contamination, roadblocks, craters, and minefields.

(f) Rock falls and slide areas.

(g) Drainage.

(h) Other natural or manmade features, such as wooded and built-up areas, that may affect movement.

2. Supervise the preparation of the route reconnaissance. Ensure soldiers—

a. Maintain equipment to vehicles and weapons.

b. Conduct inspections.

c. Conduct rehearsals.

d. Issue the order.

e. Ensure rest plan is followed.

3. Control the route reconnaissance.

a. Ensure reconnaissance commence from the flanks or rear when no reconnoitering areas along the route that is likely to be defended by enemy detachments, such as bridge approaches, defiles, or buildup areas. Detailed observation preceded actual reconnaissance, and approach routes were checked for mines, booby traps, and signs of ambush.

b. Ensure when time is available, dismounted personnel are sent forward first, covered by the remaining elements of the unit. The number of dismounted personnel sent forward depends on the size of objective and on available approaches, cover, and concealment. If the dismounted patrols find that the near edge of the area is clear, the remainder of the unit moves quickly forward. The dismounted patrols then continue the reconnaissance, over watch and follow closely by the remainder of the unit.

---

Skill Level 3

---

**Performance Steps**

---

c. When conducting a mounted reconnaissance, part of the unit remained mounted and moves forward cautiously but rapidly, over watched by the remaining mounted elements. If the near edge of the area is clear, the over watching elements move forward quickly and the advance continues.

**4. Reconnaissance by fire.**

a. Reconnaissance by fire is accomplished by firing on likely or suspected enemy positions in an attempt to remove camouflage and to cause the enemy to disclose his presence by movement or return fire. During reconnaissance by fire, positions being reconnoitered must be observed continuously so enemy activity can be quickly and definitely located.

b. Reconnaissance by fire may be employed by route reconnaissance teams as a security measure when time is critical and the loss of surprise is not essential.

c. If the enemy returns the fire, the situation is further developed. If the fire is not returned, reconnaissance continues. However, caution should be exercised, for reconnaissance by fire often fails to disclose the presence of a well-disciplined enemy.

---

**Evaluation Preparation:**

*Setup:* At the test site, provide all personnel, equipment, and material given in the task condition statement.

*Brief Soldier:* Tell the soldier that he is to plan and conduct a route reconnaissance using proper movement techniques for the likelihood of enemy contact, gather information about enemy forces along the assigned route, and critical terrain features.

Performance Measures	GO	NO GO
1. Planned reconnaissance based on the intelligence requirement.	___	___
2. Issued the plan for the mission.	___	___
3. Conducted hasty or deliberate reconnaissance based on time available and detail requirements.	___	___
4. Used reconnaissance by fire when permitted by the tactical situation.	___	___
5. Avoided decisive engagement with enemy forces.	___	___
6. Used proper movement techniques during the route reconnaissance.	___	___

Skill Level 3

Performance Measures	GO	NO GO
7. Reported all items of military significance.	___	___

**Evaluation Guidance:** Score the soldier GO if all performance measures are passed. Score the soldier NO GO if any performance measure is failed. If the soldier scores NO GO, show the soldier what was done wrong and how to do it correctly.

**References**

**Required**

- FM 3-21.71
- FM 5-170
- FM 7-7
- FM 7-8
- FM 7-20
- FM 17-95
- FM 3-90.1

**Related**

---

**071-332-5021**

**Prepare a Situation Map**

**Conditions:** Given the tactical situation, in a combat environment.

**Standards:** Included the following elements on the situation map:

1. Military symbols (must be in accordance with FM 101-5-1).
2. Enemy situation (must be depicted in red or with double lines).
3. Control measures.
4. Location of the command post and/or command group.
5. Location of all maneuver elements.
6. Location of reserves.

---

**Performance Steps**

1. Depict the control measures.
  2. Depict the command post and/or the command group location.
  3. Depict the location of the maneuver elements.
  4. Depict the location of the reserve.
  5. Determine the classification.
- 



**Evaluation Preparation:**

*Setup:* At the test site, provide a copy of the operation order, map board, map, marking pens, overlay paper, coordinate scale, unit SOP, and FM 101-5-1.

*Brief Soldier:* Tell the soldier that he must prepare a situation map. The situation map must be prepared in accordance with FM 101-5-1 and the unit SOP.

Performance Measures	GO	NO GO
1. Depicted the control measures.	___	___
2. Depicted command post and/or command group location.	___	___
3. Depicted the location of the maneuver elements.	___	___
4. Depicted the location of the reserve.	___	___
5. Determined classification.	___	___

**Evaluation Guidance:** Score the soldier GO if all performance measures are passed. Score the soldier NO GO if any performance measure is failed. If the soldier fails any performance measure, show what was done wrong and how to do it correctly.

**References**

**Required**

**Related**

FM 101-5  
FM 101-5-1

Skill Level 3

---

**071-720-0015**

**Conduct an Area Reconnaissance by a Platoon**

**Conditions:** Given a 1:50,000 map, a lensatic compass, and a mission to conduct an area reconnaissance within a specified time.

**Standards:** Satisfactorily performed the following within the time specified by the commander:

1. Organized the platoon into the command, reconnaissance, and security elements needed to accomplish the mission.
2. Conducted a reconnaissance using the surveillance or vantage-point method.
3. Obtained and reported information about the terrain and enemy within the specified area.

3-264

071-720-0015

Skill Level 3



4. Entered and left the target area without being detected by the enemy.

---

**Performance Steps**

---

**1.** Estimate the situation. When the reconnaissance mission is received, develop an estimate of the situation. Base the estimate on current intelligence about the enemy in the vicinity of the target area, and on the capabilities of the unit. While planning for the mission, have the unit prepare for the mission also. Tailor the organization to best support the mission. The reconnaissance element of a platoon will normally be no larger than a squad.

**2.** Plan details. Develop the overall plan with a consideration of the following factors:

**a.** Use Intelligence. All reconnaissance operations must be based on the best information available as to actual conditions in the objective area.

**b.** Use deceptive measures. The success of reconnaissance operations is determined, to a large extent, on deception measures and on undetected infiltration and exfiltration.

**c.** Use the smallest unit possible to accomplish the mission. This decreases the possibility of enemy detection. Though only a small element reconnoiters, the parent unit must be large enough to provide security or support if the reconnaissance is detected or an enemy force engages the element.

**d.** Remain undetected. The unit uses stealth, camouflage, concealment, and sound and light discipline. These techniques allow the unit to take advantage of periods of limited visibility to avoid contact and to get near, or on, the objective.

**e.** Use surveillance, target acquisition, and night observation (STANO) devices. The unit makes use of STANO devices to help it move and gain information about the enemy. Based on intelligence reports, consideration must be given to the enemy's detection devices. When the enemy may have detection devices, passive devices should be used to decrease the probability of enemy detection.

**f.** Rehearse. After intelligence has been analyzed, the plan developed, special items of equipment procured and issued, and the troops briefed, the unit rehearses the plan. This rehearsal is a key factor that enhances the probability of the success of the operation. Rehearsals are as detailed as time allows and include dry runs and briefings with repetition and questioning as needed to ensure understanding of the plan. Contingency plans are also rehearsed. To ensure that the contingency plans are understood, the reconnaissance members must repeat them.

---

Skill Level 3

---

**Performance Steps**

---

**g.** Minimize audio and electronic communications. Constraints on communication depend on enemy detection abilities and on how time sensitive the information obtained from the enemy is. There may be instances where the importance of the information requires an immediate report. The unit's existence could be threatened. Often, a one-time radio contact during the mission is necessary.

**h.** Inspect. The planning phase of the operation includes at least one inspection of all members of the reconnaissance force, to include their equipment. Only essential equipment, identified by the platoon leader as equipment required for mission accomplishment, is carried. Special equipment must be closely inspected and safeguarded to ensure it functions during the mission. Extra personnel and equipment assigned to the unit must also be carefully inspected and monitored prior to and during the operation. Any shortcomings found in personnel or equipment are corrected before the operation begins. Thorough inspections and supervision of personnel and equipment before the operation reduce the probabilities of compromise or failure.

**3.** Assign subordinate missions. Regardless of the types of reconnaissance, units are normally assigned one of the three subordinate missions: Command and control, reconnaissance of the objective, or security of the force.

**a.** Command and control. The commander of the unit conducting a reconnaissance normally requires a small command group to assist in communicating with higher headquarters, subordinate elements, and supporting forces, and to coordinate and control supporting elements, fire support, and air or water transport for the operation. For small operations, this group may consist of only the commander and a radio operator. For larger operations, the commander may require intelligence, logistics, and fire support elements, with adequate communication personnel for sustained 24-hour operations. The command group is always kept as small as possible.

---

Skill Level 3

---

### Performance Steps

---

**b.** Reconnaissance of the objective. The element with the reconnaissance mission approaches the target using stealth and concealment. All plans and applicable contingencies are conducted with the major effort made toward obtaining the information required while remaining undetected. The reconnaissance element must skillfully avoid all known and discovered enemy sensing devices; therefore, patience is important. Passive STANO devices will be used to observe activities at the objective. Information received about the target may be transmitted back to the appropriate headquarters by electronic means as it is observed. Or, the reconnaissance personnel may withdraw from the target and disseminate information by other means. The reconnaissance site should be sterilized before withdrawal. Withdrawal from the area must be as skillful, patient, and precise as was the movement into it.

**c.** Security of the force. The reconnaissance element(s) with this mission must provide the commander sufficient warning of the location and movement of enemy forces to permit the parent force to take evasive action or, when this is not possible, to provide covering fires that permit withdrawal of the reconnaissance element. Only if warnings are timely and information is accurate does the commander have the time and space to react. It is also the only way that, if the reconnaissance element is detected, the commander can arrange to give it sufficient over watching suppressive fires or time to evade and withdraw safely.

**4.** Conduct an area reconnaissance and obtain information about a specific location and the area immediately around it (for example, road junctions, hills, bridges, enemy positions). Designate the location of the objective by either grid coordinates or a map overlay with a boundary line drawn around the area.

**a.** Once given an area reconnaissance mission, the platoon moves to the appointed area in the shortest possible time. This normally involves traveling along existing roads and, of course, using the appropriate movement techniques. During this movement to an area, the platoon reports and bypasses enemy opposition unless ordered to do otherwise.

**b.** When the platoon reaches its area, it halts and sets up an objective rallying point (ORP). Once the ORP has been set up, the objective can be reconnoitered in one of two ways :

---

Skill Level 3

---

**Performance Steps**

---

(1) When the terrain permits the security element to move to a position to over watch the reconnaissance element, the leader may decide to have small reconnaissance teams move to each surveillance point or vantage point around the objective instead of having the entire element move as a unit from point to point. After the objective has been reconnoitered, the elements return to the ORP and information is issued. The patrol then returns to friendly lines.

(2) When the terrain does not allow the platoon to secure the objective area, the platoon leaves a security element at the ORP and uses reconnaissance and security (R&S) teams to reconnoiter the objective. These teams move to different surveillance points or vantage points, from which they reconnoiter the objective. Once the objective has been reconnoitered, the R&S team returns to the ORP, shares the information, and returns to friendly lines.

---

**Evaluation Preparation:**

*Setup:* At the test site, provide all equipment and material given in the task conditions statement.

*Brief Soldier:* Tell the soldier he is to organize and conduct an area reconnaissance using the surveillance or vantage point method. Obtain and report any information about the terrain and enemy within the specified area. Tell the soldier he is to complete the mission within the time specified by the commander. Tell the soldier you will act as the battalion intelligence officer (S2) to provide answers to any questions he may ask.

Performance Measures	GO	NO GO
1. Established a plan of action based on the mission and the enemy situation.	___	___
2. Conducted a reconnaissance.	___	___
3. Conducted deceptive measures during infiltration and exfiltration.	___	___
4. Used smallest unit required to conduct the reconnaissance.	___	___
5. Applied stealth, camouflage, and concealment techniques along with noise and light discipline to avoid detection.	___	___
6. Conducted pre-mission inspection and rehearsal.	___	___
7. Used the correct size command and control group for the mission.	___	___

Skill Level 3

Performance Measures	GO	NO GO
8. Used correct movement techniques during the mission.	___	___
9. Used correct security techniques during the mission.	___	___

**Evaluation Guidance:** Score the soldier GO if all performance measures are passed. Score the soldier NO GO if any performance measure is failed. If the soldier scores NO GO, show the soldier what was done wrong and how to do it correctly.

**References**

**Required**

- FM 3-21.71
- FM 7-7
- FM 7-8

**Related**

---

**101-92Y-0002**  
**Plan Tactical Re-Supply Operations**

**Conditions:** Given a higher headquarters operation plan/order (OPLAN/OPORD), service support plan/order and the requirement to analyze the order/plan determine the anticipated ammunition, supply and service requirements; receive, consolidate and forward all logistical reports; select appropriate supply technique to support the plan/order; distribute and cross level supplies based on commander's priorities. Given troop list, equipment density list, FM 101-5, FM 101-10-1/2, common tables of allowance (CTA) 50-900, 50-909, 50-970 or Operations Logistics Planner software, and local unit standing operating procedures (SOP).

**Standards:** Developed a service support plan/order for tactical resupply operations in accordance with FM 101-5.

---

**Performance Steps**

1. Review the higher headquarters OPLAN/OPORD.
    - a. Review task organization for troop units.
    - b. Review the situation requirements for the operation.
    - c. Review the mission paragraph for combat service support implications and requirements.
    - d. Review the execution paragraph and concept of operation.
    - e. Review the coordinating instructions subparagraph.
    - f. Review the service support paragraph.
- 

Skill Level 3

---

**Performance Steps**

---

- (1) Identify availability of specific classes of supply that might impact on the mission.
- (2) Determine supply point locations.
- (3) Identify medical evacuation and hospitalization requirements to include procedures to be used for chemical casualties.
- (4) Identify transportation capabilities, requirements, and shortages.
- (5) Identify maintenance capabilities, requirements, and location of facilities, collection points, and priority of maintenance for combat systems.
- (6) Identify the personnel services available and location of sites.
- (7) Identify the field services available and location of sites.
- (8) Identify civilian labor and host nation support available.
- g. Identify command and signal requirements for logistics planning applications.
- h. Review the acknowledgment of the OPLAN/OPORD.
2. Determine requirements for all classes of supply and transportation.
  - a. Prepare a logistics support forecast for all classes of supplies.
    - (1) Determine unit personnel strength and replacement data for actual or estimated combat losses.
    - (2) Determine the equipment on hand quantity.
      - (a) Estimate combat losses.
      - (b) Estimate equipment replenishment.
  - b. Compute the Class I requirements based on assigned personnel strength and mission.
    - (1) Compute the Class I requirements based on type of rations, climatic conditions, terrain, combat intensity, and weather.
    - (2) Determine rations by type to support the mission.
    - (3) Compute the resupply for Class I based on consumption rate.
    - (4) Determine storage space requirements for Class I.
    - (5) Determine transportation requirements necessary to move the Class I.
    - (6) Identify transportation shortfall for moving Class I.
  - c. Compute Class II requirements based on the basis of issue allowances in the common table of allowances.

Skill Level 3

---

**Performance Steps**

---

**d.** Compute Class III bulk fuel and packaged products requirements based on equipment on hand.

**(1)** Compute the Class III bulk fuel requirements based on the type equipment on hand in the unit.

**(a)** Compute the mobile gasoline (MOGAS) requirements based on the equipment on hand.

**(b)** Compute the diesel requirements based on the equipment on hand.

**(c)** Compute the JP 8 fuel requirements based on the multi-fuel equipment on hand.

**(d)** Compute the kerosene requirements based on the type of heaters on hand.

**(e)** Compute the aviation gasoline (JP 8) requirements based on the type aircraft on hand.

**(f)** Determine transportation requirements to move Class III bulk fuel.

**(g)** Identify transportation shortfall for moving Class III bulk fuel.

**(h)** Determine storage requirements for Class III bulk fuel.

**(2)** Compute the Class III packaged products requirements based on the type of equipment on hand.

**(a)** Verify quantity on hand.

**(b)** Determine transportation requirements to move Class III package products.

**(c)** Identify transportation shortfall for moving Class III package products.

**(d)** Determine storage requirements for Class III package products.

**e.** Compute Class IV requirements based on the mission needs, local unit SOP and allowances in the common table of allowances.

**(1)** Verify quantity on hand.

**(2)** Determine storage requirements for Class IV.

**(3)** Determine transportation requirements necessary to move Class IV.

**(4)** Identify transportation shortfall for moving Class IV.

---

Skill Level 3

---

**Performance Steps**

---

f. Compute the Class V requirements based on the required supply rate (RSR) for the type of mission, and the type and number of weapons on hand for one day.

(1) Determine the Class V required to support the mission.

(2) Identify the procedures to request for emergency ordnance detachment (EOD) support.

(3) Determine the storage space required for Class V requirements.

(4) Determine transportation requirements necessary to move Class V.

(5) Determine if a transportation shortfall exists.

g. Compute the Class VI requirements based on personnel assigned or attached.

(1) Compute the number of health and comfort packs (type II) required based on the number of females assigned.

(2) Compute the number of health and comfort packs (type I) required based on the total number of personnel assigned.

(3) Determine the storage space required for the health and comfort packs.

(4) Determine transportation requirements necessary to move Class VI.

(5) Determine if transportation shortfall exists.

h. Determine the Class VII major end item requirements and command controlled items.

(1) Compute the Class VII major end items resupply based on battle loss reports.

(2) Verify the weapon systems status (WESS) report for battle loss.

(3) Plan for allocation of replacement ready-to-fight weapon systems to units to support the mission.

(4) Plan for issue of ready-to-fight weapon systems plus crews.

(5) Determine number of ready weapon systems available for issue.

i. Determine the Class VIII requirements.

(1) Compute the Class VIII requirements based on the number of pounds per man per day.

(2) Verify quantity of Class VIII items on hand.

---

Skill Level 3



---

**Performance Steps**

---

- (3) Coordinate storage requirements for Class VIII items with medical personnel.
- (4) Determine transportation requirements to move Class VIII.
- (5) Identify transportation shortfall for moving Class VIII.
- j. Compute the Class IX requirements based on demand history.
  - (1) Determine storage requirements for Class IX.
  - (2) Determine transportation requirements necessary to move Class IX.
  - (3) Identify transportation shortfall for moving Class IX.
- k. Determine the requirement for miscellaneous items that are not one of the 10 supply classes (captured material and salvage material).
- l. Determine the methods of resupply for specific classes of supplies.
  - (1) Identify the method of supply.
    - (a) Establish amount and mix requirement for logistics packages (LOGPACs) based on situations.
    - (b) Determine the transportation requirements to move LOGPACs.
    - (c) Coordinate supply of LOGPACs.
      - Coordinate the service station resupply point.
      - Coordinate the tailgating resupply point.
      - Coordinate LOGPAC return instructions.
  - (2) Coordinate the on hand, due in and cached resupply of Class I, III, IV and V.
  - (3) Determine the need for cross leveling of supplies internally.
  - (4) Coordinate emergency resupply from the combat trains.
  - (5) Coordinate the distribution method for supplies.
    - (a) Identify supply point distribution location.
    - (b) Identify unit distribution location.
    - (c) Identify refuel on the move locations for Class III bulk fuel.
  - (6) Identify the types of loads required to support combat operations.
  - (7) Determine storage requirements for resupply of Class I, III, IV and V.
  - (8) Determine transportation requirements necessary for resupply for Class I, IV and V.

Skill Level 3

---

**Performance Steps**

---

- m. Identify organic transportation capabilities.
  - n. Identify the type of transportation required.
  - o. Identify transportation shortfalls.
  - p. Request additional transportation support.
  - q. Identify the traffic controls that may be necessary to the operation.
  - r. Post the main supply route (MSR) and alternate supply route (ASR) to the supply point locations on the service support plan overlay.
  - s. Post the drop zone (DZ) and landing zone (LZ) to the supply points locations on the service support plan overlay.
  - t. Prepare the service support paragraph to the service support plan.
- 3. Determine requirements for water and field services.**
- a. Compute water requirements based on assigned personnel, unit equipment, and services to be provided.
    - (1) Determine the water requirements for drinking water.
    - (2) Determine the water requirements for personal hygiene.
    - (3) Determine the water requirements for meal preparation and kitchen sanitation.
    - (4) Determine the water requirements to operate shower and laundry site.
    - (5) Determine water requirements for medical services and medical facilities.
  - b. Determine water requirements for maintenance and care of equipment.
  - c. Determine water requirements for other support requirements.
    - (1) Determine water requirements for engineer construction support.
    - (2) Determine water requirements for nuclear, biological, chemical (NBC) conditions and mission-oriented protective posture (MOPP) 3 and 4.
    - (3) Determine water requirements for NBC decontamination procedures.
  - d. Determine the locations for mortuary affairs, showers, laundry services, and fabric repair.
  - e. Post water and services graphics information to service support matrix and overlay.
  - f. Prepare the service paragraph to the service support plan.
- 

Skill Level 3

---

**Performance Steps**

---

4. Determine labor requirements.
  - a. Determine civilian and enemy prisoner of war (EPW) labor capabilities.
  - b. Allocate and set priorities for available labor.
  - c. Determine transportation requirements to move the labor force.
  - d. Identify transportation shortfalls.
5. Determine maintenance requirements.
  - a. Verify the priority of maintenance support for air, ground, and watercraft.
  - b. Verify the support maintenance facilities and salvage collection points for equipment.
  - c. Identify the controlled exchange, and cannibalization points.
  - d. Verify the maintenance evacuation procedures.
  - e. Identify maintenance capability shortfalls.
  - f. Post maintenance, controlled exchange, and cannibalization points to service support matrix and overlay.
  - g. Prepare the maintenance paragraph to the service support plan.
6. Determine requirements for medical evacuation and hospitalization.
  - a. Identify the medical evacuation policy/procedure.
  - b. Identify treatment and hospitalization facilities.
  - c. Identify other services information for all other combat health support matters.
    - (1) Identify the dental facilities and locations.
    - (2) Identify preventative medicine support and facilities location.
    - (3) Identify the health service logistics support and facilities location.
    - (4) Identify the combat stress control support and facilities location.
    - (5) Identify the veterinary support facilities and location.
  - d. Identify the procedures used for chemical casualties.
  - e. Determine the transportation requirements necessary to return troops to duty.
  - f. Post hospital locations and information to service support matrix and overlay.
  - g. Prepare the medical evacuation and hospitalization paragraph to the service support plan.

Skill Level 3

---

**Performance Steps**

---

7. Determine personnel services requirements.
    - a. Identify personnel services support (PSS) requirements.
      - (1) Identify the installation location and operating hours if applicable.
      - (2) Identify the personnel service support operating units and area served.
      - (3) Identify the personnel rotation criteria.
      - (4) Identify the unit responsibility for movement or administration of personnel.
    - b. Identify maintenance of unit strength requirements.
      - (1) Identify instructions for submission of strength reports.
      - (2) Identify instructions for replacement of personnel.
    - c. Identify casualty operations requirements.
      - (1) Identify instructions for recording casualty information.
      - (2) Identify instructions for reporting casualty information.
      - (3) Identify instructions for verifying casualty information.
      - (4) Identify instructions for processing casualty information.
    - d. Identify personnel management requirements.
      - (1) Identify instructions for military personnel.
      - (2) Identify instructions for civilian personnel.
      - (3) Identify instructions for EPW's, civilian interns/detainees.
    - e. Identify discipline, law and order requirements.
    - f. Identify headquarters management requirements.
    - g. Identify miscellaneous personnel administrative matters.
    - h. Post locations and information to service support matrix and overlay.
    - i. Prepare the personnel services paragraph to the service support plan.
  8. Identify foreign/host nation support concepts.
    - a. Identify plans for forecasted support.
    - b. Identify plans for unforecasted support.
    - c. Post foreign/host nation support information to service support matrix overlay.
  9. Identify coordinating instructions.
- 

Skill Level 3

---

**Performance Steps**

---

- a. Identify boundaries needed for combat service support (CSS) purposes.
  - b. Identify protection measures for CSS units or installations.
    - (1) Identify which units will provide protection based on threat level.
    - (2) Identify which CSS units or installations will receive protection.
  - c. Identify special reports not included in previous paragraphs.
  - d. Identify other CSS matters not included in previous paragraphs.
  - e. Identify time and/or conditions under which the plan is to be executed.
  - f. Post coordinating instructions to service support matrix and overlay.
- 

**Evaluation Preparation:** This task can be evaluated during routine unit operations.

*Brief Soldier:* Inform soldier that the evaluation is measured on the ability to perform the listed performance measures.

Performance Measures	GO	NO GO
1. Reviewed the higher headquarters OPLAN/OPORD.	—	—
a. Reviewed task organization for troop units.		
b. Reviewed the situation requirements for the operation.		
c. Reviewed the mission paragraph for CSS implications and requirements.		
d. Reviewed the execution paragraph and concept of operation.		
e. Reviewed the coordinating instructions subparagraph.		
f. Reviewed the service support paragraph.		
g. Identified command and signal requirements for logistics planning applications.		
h. Reviewed the acknowledgement of the OPLAN/OPORD.		
2. Determined requirements for all classes of supply and transportation.	—	—

Skill Level 3

Performance Measures	GO	NO GO
a. Prepared a logistics support forecast for all classes of supplies.		
b. Computed the Class I requirements based on assigned personnel strength and mission.		
c. Computed Class II requirements based on the basis of issue allowances in the common table of allowances.		
d. Computed Class III bulk fuel and packaged products requirements based on equipment on hand.		
e. Computed Class IV requirements based on the mission needs, local unit SOP, and allowances in the common table of allowances.		
f. Computed the Class V requirements based on the RSR for the type of mission, and the type and number of weapons on hand for one day.		
g. Computed the Class VI requirements based on personnel assigned or attached.		
h. Determined the Class VII major end item requirements and command controlled items.		
i. Determined the Class VII requirements.		
j. Computed the Class IX requirements based on demand history.		
k. Determined the requirement for miscellaneous items that are not one of the 10 supply classes (captured material and salvage material).		
l. Determined the methods of resupply for specific classes of supplies.		
m. Identified organic transportation capabilities.		
n. Identified transportation shortfalls by nodes.		
o. Identified the type of transportation required.		
p. Requested additional transportation support.		
q. Identified the traffic controls that may be necessary to the operation.		
r. Posted the MSR and ASR to the supply point locations on the service support plan overlay.		
s. Prepared the logistics annex (service support) to OPORD.		

Skill Level 3

3-278

101-92Y-0002

Skill Level 3

<b>Performance Measures</b>	<b>GO</b>	<b>NO GO</b>
<b>3. Determined requirement for water and field services.</b>	—	—
<b>a.</b> Computed water requirements based on assigned personnel, unit equipment, and services to be provided.		
<b>b.</b> Determined water requirements for maintenance and care of equipment.		
<b>c.</b> Determined water requirements for other support requirements.		
<b>d.</b> Determined the water requirements for mortuary affairs.		
<b>e.</b> Posted water and services graphics information to service support matrix and overlay.		
<b>f.</b> Prepared the service paragraph to the service support plan.		
<b>4. Determined labor requirements.</b>	—	—
<b>a.</b> Determined civilian and EPW labor capabilities.		
<b>b.</b> Allocated and set priorities for available labor.		
<b>c.</b> Determined transportation requirements to move the labor force.		
<b>5. Determined maintenance requirements.</b>	—	—
<b>a.</b> Verified the priority of maintenance support for air, ground, and watercraft.		
<b>b.</b> Verified the support maintenance, facilities and salvage collection points for equipment.		
<b>c.</b> Identified the controlled exchange, and cannibalization point.		
<b>d.</b> Verified the maintenance evacuation procedures.		
<b>e.</b> Identified maintenance capability shortfalls.		
<b>f.</b> Posted maintenance, controlled exchange, and cannibalization points to service support matrix and overlay.		
<b>g.</b> Prepared the maintenance paragraph to the service support plan.		

**Skill Level 3**

Performance Measures	GO	NO GO
<b>6.</b> Determined requirements for medical evacuation and hospitalization.	___	___
<b>a.</b> Identified the medical evacuation policy.		
<b>b.</b> Identified treatment and hospitalization procedures.		
<b>c.</b> Identified other services information for all other combat health support matters.		
<b>d.</b> Identified the procedures used for chemical casualties.		
<b>e.</b> Determined the transportation requirements necessary to return troops to duty.		
<b>f.</b> Posted hospital locations and information to service support matrix overlay.		
<b>g.</b> Prepared the medical evacuation and hospitalization paragraph to the service support plan.		
<b>7.</b> Determined personnel services requirements.	___	___
<b>a.</b> Identified PSS requirements.		
<b>b.</b> Posted location and information to service support matrix and overlay.		
<b>c.</b> Prepared the personnel services paragraph to the service support plan.		
<b>8.</b> Identified foreign/host nation support concepts.	___	___
<b>a.</b> Identified plans for forecasted support.		
<b>b.</b> Identified plans for unforecasted support.		
<b>c.</b> Posted foreign/host nation support information to service support matrix and overlay.		
<b>9.</b> Identified coordinating instructions.	___	___
<b>a.</b> Identified boundaries needed for CSS purposes.		
<b>b.</b> Identified protection measures for CSS units or installations.		
<b>c.</b> Identified special reports not included in previous paragraphs.		
<b>d.</b> Identified other CSS matters not included in previous paragraphs.		

Skill Level 3



Performance Measures	GO	NO GO
e. Identified time and/or conditions under which the plan was to be executed.		
f. Posted coordinating instructions to service support matrix and overlay.		

**Evaluation Guidance:** Score the soldier GO if all performance measures are passed. Score the soldier NO GO if any performance measure is failed. If the soldier scores NO GO, show the soldier what was done wrong and how to do it correctly.

#### References

##### Required

CTA 50-900  
CTA 50-909  
CTA 50-970  
FM 101-5

##### Related

AR 710-2  
DA Pam 710-2-1  
FM 10-27-4  
FM 100-10  
FM 101-5-1

Skill Level 3

### 301-371-1150

#### Identify Intelligence and Electronic Warfare (IEW) Assets

**Conditions:** Given the OPLAN, operational overlay, current enemy situation and a map of the area.

**Standards:** Identified the types of intelligence and electronic warfare (IEW) support available and how they were integrated into the combined arms team.

#### Performance Steps

1. Identify the four major tasks that make up the IEW mission.
  - a. Situation development.
  - b. Target development.
  - c. Electronic warfare (EW).
  - d. Counterintelligence (CI).
2. Determine the role of situation development.
  - a. Locate enemy forces.
  - b. Determine enemy capabilities, vulnerabilities, and intentions.
  - c. Identify the enemy main effort.

Skill Level 3

301-371-1150

3-281

---

**Performance Steps**

---

d. Determine how weather and terrain will affect friendly and enemy operations.

e. Detect opportunities to exploit enemy weaknesses and seize or retain the initiative.

3. Determine the role of target development.

a. Provide combat information.

b. Provide targeting data.

c. Correlate target information.

4. Determine the role of EW.

a. Define EW.

(1) EW is the means through which commanders protect their own electronic systems while attacking those of the enemy.

(2) EW exploits, disrupts, and deceives enemy command and control while protecting friendly use of communications and non-communications systems.

(3) On the battlefield, EW is divided into two categories: offensive and defensive.

b. Define electronic attack (EA).

(1) Offensive EW is referred to as EA.

(2) EA is the transmission of electronic jamming signals that disrupt the enemy's communications and other signal emitter systems. It also transmits false communications that deceive enemy forces through their own information collection systems.

(3) EW assets are targeted in much the same way as artillery and other weapon systems.

(4) EA includes jamming and deception.

c. Define electronic warfare support (ES).

(1) Enemy sources of radiated electromagnetic energy are searched for, located, and identified through a process called ES.

(2) ES focuses on the immediate requirements of the tactical commander.

(3) ES includes the efforts to search, identify, intercept, and locate electronic emitters.

d. Define electronic protection (EP).

(1) Defensive EW seeks to protect friendly use of the electromagnetic spectrum by employing EP.

---

Skill Level 3

---

### Performance Steps

---

(2) EP is the actions taken to protect friendly command, control, and communication (C3) from enemy collection and disruption efforts.

(3) EP is planned around the commander's mission and concept of operations, and is the responsibility of the operations officer (G3/S3). Based on the mission, those communications and electronic systems that must be protected are identified and their vulnerability to enemy EA is assessed. The operation of these systems is then planned and monitored to ensure that the times, frequencies, duration, and location of their emissions provide the greatest possible security from enemy collection and disruption efforts.

**Note.** FM 34-10 and FM 34-25 have not been updated to reflect current IEW terminology. These manuals refer to electronic attack (EA) as electronic countermeasures (ECM), electronic warfare support (ES) as electronic warfare support measures (ESM) and electronic protection (EP) as electronic counter-countermeasures (ECCM).

5. Determine the role of counterintelligence (CI).
  - a. Counters the hostile intelligence threat.
  - b. Safeguards the command from surprise.
  - c. Deceives the enemy.
  - d. Counters enemy sabotage, subversion, and terrorism.
6. Identify the major intelligence disciplines.
  - a. Human intelligence (HUMINT) includes all information derived through human sources not accessible to other collection assets. HUMINT employs overt, covert, and clandestine operations to achieve worldwide collection objectives.
  - b. Imagery intelligence (IMINT). IMINT can be obtained from land, sea, air, and space platforms (radar, photographic, infrared, and electro-optic imagery).
  - c. Signals intelligence (SIGINT) is the products resulting from the collection, evaluation, analysis, integration, and interpretation of information derived from intercepted electromagnetic emissions.
  - d. Measurement and signature intelligence (MASINT) is scientific and technical intelligence obtained by quantitative and qualitative analysis of data derived from technical sensors for the purpose of identifying any distinctive features associated with the source, emitter, or sender and to facilitate subsequent identification or measurement.
7. Recognize how IEW supports the battlefield commander.
  - a. Collect information on enemy forces.
  - b. Provide targeting data to fire and maneuver elements.

Skill Level 3

---

**Performance Steps**

---

c. Evaluate, analyze, integrate, and interpret collected information to produce intelligence.

d. Disseminate the intelligence product to the appropriate users.

e. Conduct EW operations.

f. Support operations security (OPSEC) and deception.

8. Identify the staff responsibilities for IEW.

a. The G2 coordinates the intelligence effort. He identifies intelligence requirements based on the commander's guidance and concept of the operation.

b. The G3 has staff responsibility for planning and directing the jamming and deception operations of the command. He directs EA actions needed to support planned and ongoing operations. He identifies, in coordination with the G2, ES requirements to support EW.

c. The military intelligence (MI) unit commander manages the MI assets to accomplish the assigned EW missions. He exercises command and control (C2) over all organic and attached MI elements and operational control (OPCON) over supporting MI assets.

9. Identify how IEW is integrated into the combined arms team.

a. Division tactical operations center support element (DTCOSE) augments the G2 and G3. Part of this element, the electronic warfare section (EWS), is the principle mission manager for EA. The EWS is also involved with the fire support element in the targeting process.

b. The analysis and control element (ACE), formerly referred to as the technical control and analysis element (TCAE), is part of the MI battalion tactical operations center (TOC) and is the asset manager for all ES and EA missions tasked to the MI battalion.

c. Intelligence and electronic warfare support element (IEWSE) is attached to the maneuver brigade TOC from the MI battalion. This element serves as an interface between MI assets in the brigade area and the brigade S2 and S3.

d. The G2, G3, fire support officer and communications -electronics (CE) officer coordinate and direct IEW operations. They obtain the information required to answer the commander's requirements concerning both enemy forces and friendly vulnerabilities. They integrate EA with maneuver and fire and plan and coordinate OPSEC measures and defensive EP measures to protect from enemy intelligence collections operations.

---

Skill Level 3

**Evaluation Preparation:**

*Setup:* Provide the soldier with the materials listed in the conditions statement.

*Brief Soldier:* Tell the soldier to identify the types of EW support available and how they are incorporated into the combined arms team.

Performance Measures	GO	NO GO
1. Identified the four major tasks that make up the IEW mission.	___	___
2. Determined the role of situation development.	___	___
3. Determined the role of target development.	___	___
4. Determined the role of EW to include—	___	___
a. Defined EW.		
b. Defined EA.		
c. Defined ES.		
d. Defined EP.		
5. Determined the role of CI.	___	___
6. Identified the major intelligence disciplines.	___	___
7. Recognized how IEW supports the battlefield commander.	___	___
8. Identified the staff responsibilities for IEW to include—	___	___
a. Responsibilities of the G2.		
b. Responsibilities of the G3.		
c. Responsibilities of the MI unit commander.		
9. Identified how IEW is integrated into the combined arms team to include—	___	___
a. The MI support elements that assist in IEW operations.		
b. The principal personnel that coordinate and direct IEW operations.		

Skill Level 3

**Evaluation Guidance:** Failure to achieve a GO for this task will result in retraining of the failed areas and retesting. A second NO GO will result in retraining of the entire task and retesting.

**References**

**Required**

**Related**

- FM 34-3
- FM 34-1
- FM 34-10
- FM 34-25

---

**551-88M-0001**

**Lead a Convoy Serial/March Unit**

**Conditions:** You are a platoon leader or platoon sergeant in a field or garrison environment and have received an order directing your unit to conduct a motor transport convoy. You have access to the unit SOP, maps, and all applicable movement directives.

**Standards:** Planned and conducted a motor transport convoy over a designated route that enabled the convoy to reach the SP and RP at the times prescribed in the convoy clearance. The convoy arrived safely at its destination with minimum loss or damage to vehicles, equipment, physical surroundings, or personnel.

---

**Performance Steps**

1. Determine mission requirements.
2. Conduct route reconnaissance.
3. Prepare strip map.
4. Request convoy clearance (administrative).
5. Request convoy clearance (tactical).
6. Plan convoy organization and control.
7. Prepare movement order.
8. Prepare drivers.
9. Schedule and prepare convoy briefing.
10. Supervise before operations PMCS.
11. Ensure pre-departure steps.
12. Enforce correct driving procedures .
13. Instruct drivers.
14. Perform RP checks.

---

**Evaluation Preparation:** Evaluate this task during a field training exercise or a unit training exercise.

Skill Level 3

*Brief Soldier:* Inform the soldier that the evaluation is measured on the ability to perform all the functions listed.

<b>Performance Measures</b>	<b>GO</b>	<b>NO GO</b>
1. Collected warning order and area maps.	___	___
2. Gathered SOP and reference directives.	___	___
3. Reviewed unit load plans.	___	___
4. Evaluated environmental impact.	___	___
5. Selected primary and alternate routes.	___	___
6. Identified halts.	___	___
7. Identified route restrictions.	___	___
8. Prepared and distributed the strip map.	___	___
9. Coordinated submission of DD Form 1265 (administrative).	___	___
10. Coordinated for oversize or overweight vehicles (administrative).	___	___
11. Coordinated with battalion S3 (tactical).	___	___
12. Appointed and instructed trail party.	___	___
13. Coordinated support requirements.	___	___
14. Planned for special mission requirements.	___	___
15. Planned for placement of troop carrying vehicles.	___	___
16. Divided the convoy into march units/serials.	___	___
17. Planned gap time between serials.	___	___
18. Determined position of march unit and serial commanders.	___	___
19. Obtained civilian police assistance (when possible).	___	___
20. Assigned radios.	___	___
21. Prepared and issued the movement order.	___	___

**Skill Level 3**

<b>Performance Measures</b>	<b>GO</b>	<b>NO GO</b>
22. Ensured drivers possess valid driving permits.	___	___
23. Ensured adequate rest periods.	___	___
24. Scheduled for combat inspections.	___	___
25. Scheduled, prepared, and conducted convoy briefing covering—	___	___
a. The situation.		
b. The mission.		
c. Execution.		
d. Administration and logistics.		
e. Command and signal.		
f. Safety.		
26. Checked air hose couplings.	___	___
27. Checked oil and lubrication levels.	___	___
28. Checked cooling systems.	___	___
29. Checked brakes.	___	___
30. Checked tires.	___	___
31. Checked line up of vehicles.	___	___
32. Checked vehicle markings.	___	___
33. Selected pacesetter.	___	___
34. Conducted operations weapons check.	___	___
35. Ensured sandbags were installed.	___	___
36. Ensured cargo was secured.	___	___
37. Briefed drivers on rules of the road.	___	___
38. Signaled to start engines.	___	___
39. Signaled to move out.	___	___
40. Enforced proper driving procedures.	___	___

Skill Level 3



Performance Measures	GO	NO GO
41. Informed drivers of details at halts.	___	___
42. Had drivers inspect their vehicles and loads.	___	___
43. Ensured operational checks by drivers.	___	___
44. Checked load security.	___	___
45. Ensured policing of areas after stops.	___	___
46. Dismissed drivers.	___	___

**Evaluation Guidance:** Score the soldier GO if all performance measures are passed. Score the soldier NO GO if any performance measure is failed. If the soldier scores NO GO, show what was done wrong and how to do it correctly.

**References**

**Required**

FM 21-60  
 FM 55-15  
 FM 55-30  
 FM 101-5

**Related**

TM 9-2320-273-10  
 TM 9-2320-279-10-1  
 TM 9-2320-279-10-2  
 TM 9-2320-280-10  
 TM 9-2320-283-10  
 TM 9-2320-289-10  
 TM 9-2320-360-10  
 TM 9-2320-361-10  
 TM 9-2320-364-10  
 TM 9-2320-365-10  
 TM 9-2320-366-10-1  
 TM 9-2320-366-10-2

Skill Level 3

---

**551-88N-0003**

**Plan Unit Move**

**Conditions:** Given a command directive to plan for your unit to conduct a move to port of embarkation to deploy in support of an Army or joint OPLAN. You have access to the unit SOP and all unit movement directives.

**Standards:** Planned a unit movement using the necessary references (vehicle -10s) and equipment to deliver vehicles and equipment to arrive safely at the port of debarkation with no loss of vehicles, equipment, or personnel.

**Performance Steps**

1. Identify what needs to be moved.
2. Identify what needs to accompany troops.
3. Identify what needs to be moved by air.
4. Identify hazardous, sensitive, and classified material/equipment.
5. Identify bulk cargo.
6. Develop vehicle load plans.

**Evaluation Preparation:**

*Setup:* Evaluate this task during a field training exercise or a unit training exercise.

*Brief Soldier:* Inform the soldier that the evaluation is measured on the ability to perform all the functions listed.

Skill Level 3

Performance Measures	GO	NO GO
1. Identified what needed to be moved.	___	___
a. Determined number of deploying personnel.		
b. Determined deploying vehicles and equipment.		
c. Determined basic load.		
2. Identified what needed to accompany troops.	___	___
a. Identified Yellow TAT.		
b. Identified Red TAT.		
c. Identified equipment not to accompany troops.		
3. Identified what needed to be moved by air.	___	___
a. Established liaison with UMO.		
b. Determined advance party personnel.		
c. Determined supercargo personnel.		
4. Identified hazardous, sensitive, and classified equipment and material.	___	___
a. Identified TAT ammunition quantities.		
b. Determined upload of ammunition for armored vehicles.		

Performance Measures	GO	NO GO
c. Determined securable hatches.		
d. Determined palletized load for armored vehicles.		
e. Determined tiedown cargo requirements.		
f. Determined fuel reduction requirements.		
5. Identified bulk cargo.	___	___
a. Determined packing list distribution.		
b. Determined BBPCT requirements.		
6. Developed vehicle load plans.	___	___
a. Planned for load capacity.		
b. Determined commercial transportation requirements.		

**Evaluation Guidance:** Score the soldier a GO for the task if all performance measures are passed. Score the soldier a NO GO for the task if any performance measure is failed. For all NO GO performances, demonstrate how the performance should be performed and allow the soldier remediation.

**References**

**Required**

- FM 4-01.011
- FM 55-1
- FM 100-17
- FM 101-5
- TB 55-46-1

**Related**

Skill Level 3

**SUBJECT AREA 23: SECURITY AND CONTROL**

**191-379-4407**

**Plan Convoy Security Operations**

**Conditions:** You are given an operation order (OPORD), a combat load, a map of the area, a compass, a protractor, communications equipment, signal operating instructions (SOI), security personnel, and special orders, if required.

**Standards:** Developed a plan that included all required considerations for the specific mission, coordinated with appropriate units for required support, ensured that necessary equipment and supplies were available and operational, and prepared briefings for the security personnel on the mission and assigned specific duties. Ensured that 360-degree security was maintained from the point of origin to destination when escorting special weapons.

---

### Performance Steps

---

1. Receive the OPORD.

**Note.** Follow all steps in troop-leading procedures. When carrying special weapons or ammunition, ensure that you obtain the special orders concerning this cargo, that you understand them, and that they cover any situations not covered in the OPORD.

2. Coordinate with the host nation security personnel.
3. Consult all sources of information, especially the engineers and the highway traffic division (HTD), to obtain as much information as possible.
4. Reconnoiter the convoy route to identify the following:
  - a. Likely trouble spots and ambush sites.
  - b. Possible locations for traffic control posts (TCPs) and/or checkpoints.
  - c. Route conditions.
  - d. Location of friendly units in the area.
5. Coordinate with the convoy commander to determine—
  - a. Actions to be taken if enemy contact is made by—
    - (1) A sniper.
    - (2) An ambush with the road blocked.
    - (3) An ambush with the road not blocked.
    - (4) An air attack.
    - (5) An artillery attack.

**Note.** Based on the mission and/or the type of cargo, the reaction to an enemy attack may vary. See STP 19B1-SM, Task 191-376-4110. When carrying special weapons or ammunition, ensure that procedures are covered in the special orders on exactly how to react to enemy contact.

- b. Protective measures for mines and booby traps.
- c. Convoy organizations to include the location of—
  - (1) Critical cargo vehicles.
  - (2) Control vehicles.
  - (3) Armored vehicles and automatic weapons.

Skill Level 3

---

### Performance Steps

---

**Note.** Armored vehicles and automatic weapons are positioned within the convoy so they are mutually supporting.

**(4)** Maintenance and recovery vehicles.

**Note.** The convoy commander and/or unit maintenance officer or noncommissioned officer (NCO) will decide whether to repair, recover, or destroy vehicles.

- d. Primary and backup frequencies.
- e. Emergency communications procedures.
- f. The timetable for movements (especially for serials and march units).
- g. Coordination points (assembly area for everyone).
- h. Start and release points.
- i. Security measures to be used at halts and rest stops. The location of the halts should be—
  - (1) In a relatively secure area.
  - (2) Off the roadway where there is some natural cover and concealment.
  - (3) Under the surveillance of a security force.
  - (4) Where there is an unobstructed view for 200 meters at each end of the convoy (no curves, hills, and so forth).
  - (5) In an area that is large enough to maintain convoy interval.
  - (6) Where local civilians can be kept away from the convoy.
  - (7) In an area that is not heavily populated.
  - (8) Where there are host nation police present (if applicable).

**Note.** When carrying special weapons or ammunition, additional procedures covering the establishment of an exclusion area and the enforcement of the "two-man rule" must be covered and written in the special orders, ensuring 360-degree security is maintained on the special weapons. If security cannot be maintained, instructions on how and when to disable the weapons must be included.

- j. The time and place that military police (MP) support begins and ends.
- k. Expected changes in the routes.
- l. Road conditions.
- m. Supporting fires to include artillery support, engineer support (for minesweeping of the route), gunship support, and host nation police support, if applicable.
- n. Primary and alternate routes.

Skill Level 3



**Evaluation Preparation:**

*Setup:* Schedule a field training exercise that will require the squad leader to plan convoy security operations.

*Brief Soldier:* Tell the squad leader being evaluated that he must develop an accurate and concise plan for convoy security operations.

Performance Measures	GO	NO GO
1. Received the OPORD.	—	—
<b>Note:</b> Followed all steps in troop-leading procedures.		
2. Coordinated with the host nation security personnel.	—	—
3. Consulted all sources of information, especially the engineers and the HTD, to obtain as much information as possible.	—	—
4. Reconnoitered the convoy route and identified the following:	—	—
a. Likely trouble spots and ambush sites.		
b. Possible locations for TCPs and/or checkpoints.		
c. Route conditions.		
d. Location of friendly units in the area.		
5. Coordinated with the convoy commander to determine—	—	—
<b>Note.</b> Ensured 360-degree security was maintained from the point of origin to destination when escorting special weapons.		
a. Actions to be taken if enemy contact was made.		
b. Protective measures for mines and booby traps.		
c. Convoy organizations.		
d. Primary and backup frequencies.		
e. Emergency communications procedures.		
f. The timetable for movements (especially for serials and march units).		
g. Coordination points (assembly area for everyone).		
h. Start and release points.		
i. Security measures to be used at halts and rest stops.		

Skill Level 3

Performance Measures	GO	NO GO
j. The time and place that MP support begins and ends.		
k. Expected changes in the routes.		
l. Road conditions.		
m. Supporting fires to include artillery support, engineer support (for minesweeping of the route), gunship support, and host nation support, if applicable.		
n. Primary and alternate routes.		
o. The location where MP vehicles and personnel would be positioned in the convoy.		
p. The method of escort for the convoy.		
6. Briefed personnel on the mission, enemy situation, and specific individual duties to be performed.	—	—
7. Coordinated with friendly units (in the area where the convoy would pass) to identify—	—	—
a. The support the friendly units could provide.		
b. What restrictions applied for the use of indirect fire?		
8. Coordinated with artillery units.	—	—
9. Coordinated with helicopter and/or Air Force units for gunship support.	—	—
10. Inspected equipment.	—	—

Skill Level 3

**Evaluation Guidance:** Score the soldier GO if all performance measures are passed. Score the soldier NO GO if any performance measure is failed. If the soldier fails any performance measure, show him how to do it correctly.

**References**

**Required**  
 FM 3-19.1  
 FM 3-19.4

**Related**  
 FM 3-19.30  
 FM 7-10  
 FM 19-25



---

## 301-371-1052

### Protect Classified Information and Material

**Conditions:** This task can be performed in field and garrison locations under all conditions. Given classified documents and/or material, AR 380-5, local SOP, SF 700, *Security Container Information*, SF 702, *Security Container Check Sheet*, SF 703, *Top Secret Cover Sheet*, SF 704, *Secret Cover Sheet*, SF 705, *Confidential Cover Sheet*, DA Form 3964, *Classified Documents Accountability Record*, office equipment, and supplies.

**Standards:** Safeguarded classified information and material to prevent unauthorized disclosure 100 percent of the time.

---

#### Performance Steps

---

1. Identify classified material.

**Note.** Information is any knowledge that can be communicated or documentary material, regardless of its physical form or characteristics, that is owned by, produced by or for, or is under the control of the U.S. Government. Unauthorized disclosure is a communication or physical transfer of classified information to an unauthorized recipient.

a. List the security classification levels.

(1) Confidential: Information that, if disclosed to unauthorized persons, could reasonably be expected to cause damage to the national security.

(2) Secret: Information that, if disclosed to unauthorized persons, could reasonably be expected to cause serious damage to the national security.

(3) Top Secret: Information that, if disclosed to unauthorized persons, could reasonably be expected to cause exceptionally grave damage to the national security.

b. Define original and derivative classifications.

(1) Original classification—an initial determination that information requires, in the interest of national security, protection against unauthorized disclosure.

(2) Derivative classification—the incorporating, paraphrasing, restating, or generating in new form information that is already classified, and marking the newly developed material consistent with the classification markings that apply to the source information.

2. Locate and read the declassification and downgrading instructions, which appear on a classified document. Define declassification and downgrading.

a. Declassification—the authorized change in the status of information

---

Skill Level 3

---

**Performance Steps**

---

from classified information to unclassified information.

(1) At the time of original classification, the original classification authority shall attempt to establish a specific date or event for declassification.

**Note.** Information that already has been declassified and released to the public cannot be reclassified.

(2) If a specific date or event for declassification cannot be determined, then information shall be marked for declassification 10 years from date of the original decision.

(3) The original classification authority may extend the duration of classification for a successive period, not to exceed 10 years at a time.

(4) At the time of original classification, the original classification authority may exempt for declassification within 10 years specific information that the unauthorized disclosure could reasonably be expected to cause damage to the national security.

(5) Information shall be declassified as soon as it no longer meets the standards for classification.

b. Downgrading—a determination by a declassification authority that information classified and safeguarded at a specific level shall be classified and safeguarded at a lower level.

3. Review information for required identification and markings.

**Note.** Classification markings will be in letters larger than those used in the rest of the text.

a. Check the document for required markings:

(1) Ensure the overall classification of the document is marked, stamped, or affixed permanently—

- (a) On the top and bottom of the outside front cover,
- (b) On the title page,
- (c) On the first page,
- (d) On the outside of the back cover.

(2) Each interior page, except those left blank, will be marked on the top and bottom according to content, to include unclassified.

(3) Each section, part, paragraph, or similar portion of a classified document will be marked to show the level of classification of the information contained by showing the appropriate classification symbol.

---

Skill Level 3

---

**Performance Steps**

---

(4) Charts, maps, and drawings will bear the appropriate classification markings for the legend, title, or scale block. The higher of these markings shall be inscribed at the top and bottom of each such document.

(5) Photographs, films (including negatives), recordings, and their containers will be marked with the specific level of the information contained within.

(6) Information used to simulate classified or unclassified material or documents will be marked clearly to indicate the actual unclassified status of the information (for example SECRET for Training Purposes Only).

b. Examine all classified documents for completeness; ensure no parts or pages are missing.

c. Ensure the following appears on the face of all classified information:

(1) The overall classification of the document should be stamped top and bottom.

(2) The identity, by name or personal identifier, and position of the original classification authority.

(3) The agency and office of origin.

(4) Declassification instructions.

(5) Reason for classification.

4. Protect classified information through restricted access.

a. Define access—the ability or opportunity to gain knowledge of classified information. Access is based on—

(1) Security clearance. Ensure that personal security clearance is equal to, or exceeds, the classification level of the material required to perform official duties.

(2) Need-to-know. Ensure that a determination has been made by an authorized holder of classified information that the prospective recipient requires access to specific information to perform or assist in a lawful and authorized government function.

**Note.** No one has a right to have access to classified information solely by virtue of rank or position.

b. Prevent unauthorized persons from gaining access to classified material.

(1) Keep all classified documents under constant observation when removed from storage.

---

Skill Level 3

---

**Performance Steps**

---

(2) Keep all documents face down or covered when not in use.

(3) Place one of the following cover sheets on all classified material:

(a) SF 705 for Confidential information.

(b) SF 704 for Secret information.

(c) SF 703 for Top Secret information.

c. Define Special Access Program—a program established for a specific class of classified information that imposes safeguarding and access requirements that exceed those normally required for information at the same classification level.

5. Safeguard classified information and material.

a. Use proper precautions to protect classified information and material:

(1) Safeguard classified information when temporarily departing the work area.

(2) Prevent display of classified information in public places.

(3) Use the following procedures when working papers containing classified information are created:

(a) Date the document.

(b) Mark the document with the words "working papers."

(c) Mark each page, top and bottom, according to the content classification.

(d) Bring working papers under control as a finished document when—

(i) Retained more than 90 days from date of origin.

(ii) Released outside the originator's agency.

(iii) Transmitted electrically or electronically.

(iv) Filed permanently.

(v) Papers contain top secret information.

6. Comply with security regulations when discussing classified information.

a. Do not discuss classified and/or sensitive information on an unsecured telephone.

b. Use the following procedures when presenting a classified briefing:

(1) Ensure that the briefing area has been cleared to the highest level of material to be discussed.

---

Skill Level 3

---

**Performance Steps**

---

(2) Check the attendance roster to ensure all personnel are cleared and have a need-to-know.

(3) Establish a sign-in roster at the main entrance to the briefing area and control access at all other entrances.

(4) Ensure that all training aids are marked with security classification according to their content.

(5) Inform the audience of the security classification of the briefing and the policy concerning note taking at the beginning of the briefing.

(6) Repeat the security classification at the end of the briefing.

c. Ensure that automated information systems, including networks and telecommunications systems, that collect, create, communicate, compute, disseminate, process, or store classified information must have controls that—

(1) Prevent access by unauthorized persons.

(2) Ensure the integrity of the information.

7. Protect classified information during transport.

a. Do not remove classified information from official premises without proper authorizations.

b. Protect classified information when transporting outside of a secured area.

(1) Address classified information to an official government activity or DOD contractor with a facility clearance and not to an individual.

(2) Pack classified information in such a manner that the text will not be in contact with the inner envelope or container.

(3) Attach or enclose a receipt, DA Form 3964, in the inner envelope or container for all SECRET and TOP SECRET information. CONFIDENTIAL information requires a receipt only if the originator deems it necessary.

(4) Double wrap classified information in opaque envelopes or similar wrappings.

(a) Mark the inner envelope with the overall classification of the contents, and any special instructions.

(b) Mark the inner and outer envelope with the complete sender's and receiver's address.

(c) Do not mark the outer envelope with any indications of the contents or the classification.

(d) Do not display classified material in public places while transporting.

Skill Level 3

---

**Performance Steps**

---

(e) Do not store classified material in any detachable storage compartment, such as automobile trailers or luggage racks while transporting.

8. Protect classified information during transmission.

a. Transmit classified information and material according to the security classification level, as specified in AR 380-5. Transmit classified material by—

- (1) Approved courier services.
- (2) U.S. military personnel.
- (3) Government employees.
- (4) DOD contractors.
- (5) U.S. Postal Service.
- (6) Electronic transmission over secure lines using encryption.

b. Ensure the appropriate contracting officer has authorized transmission in writing.

c. Ensure TOP SECRET and SECRET classified information remain in constant custody and protection of the courier at all times.

9. Safeguard classified material when in storage.

a. Store classified information under conditions adequate to prevent unauthorized access.

b. Store typewriter ribbons, computer disks, notes, and similar materials that are classified or used to process classified information, in a locked GSA approved security container, when not under the personal control and observation of an authorized person.

c. Follow correct procedures when locking material in a GSA approved security container:

(1) Complete SF 702 correctly, with the proper date, time, and initials.

(2) Turn the "OPEN/CLOSED" sign on the front of the security container to the "CLOSED" position.

(3) Ensure that another person checks the container to make sure it is locked and initials the SF 702.

10. Use the following procedures when discovering an open or unattended security container.

a. Keep the container or area under guard or surveillance.

---

Skill Level 3

---

**Performance Steps**

---

**b.** Notify one of the persons listed on Part 1 of SF 700 attached to the inside of the security container drawer. If one of these individuals cannot be contacted, the duty officer, security manager, or other appropriate official will be notified.

**11.** Report possible compromise of classified information. List individual responsibilities in cases of suspected compromise:

**a.** Any person having knowledge of the loss or possible compromise of classified information will immediately report it to their security manager, S2, or commanding officer (CO).

**b.** Any person who discovers classified information out of proper control will take custody of the information, safeguard it, and immediately report to their security manager, S2, or CO.

**c.** The security manager, S2, or CO will initiate a preliminary inquiry to determine the circumstances surrounding the loss or possible compromise of classified information and establish one of the following:

**(1)** The loss or compromise of classified information did not occur.

**(2)** The loss or compromise did occur but the compromise reasonably could not be expected to cause damage to the national security.

**(3)** The loss or compromise of classified information did occur and that the compromise reasonably could be expected to cause damage to the national security.

**d.** The security manager or S2 will report the circumstances of the compromise to the appropriate authority:

**(1)** HQDA (DAMI-CIS) when dealing with SECRET and TOP SECRET information.

**(2)** Commander when dealing with CONFIDENTIAL information.

**e.** A further investigation may be initiated if warranted.

**12.** Use proper procedures when destroying classified information.

**a.** Destroy classified information in a way sufficient to preclude recognition or reconstruction.

**(1)** Destroy classified information by burning, melting, chemical decomposition, pulping, pulverizing, cross-cut shredding, or mutilation.

**(2)** Burning is the preferred method of destroying classified information.

**b.** Complete DA Form 3964, *Record of Destruction*, for TOP SECRET information. Records shall be dated and signed at the time of destruction.

---

Skill Level 3

**Evaluation Preparation:**

*Setup:* Provide the soldier with the materials listed in the CONDITIONS statement.

*Brief Soldier:* Tell the soldier to protect the classified material.

**Note to the trainer.** If this task is to be evaluated during training, prepare and provide the soldier material that is classified "FOR TRAINING PURPOSES ONLY." Ensure that the material is marked to this effect. The soldier must receive a GO on all items to receive a GO on this task.

Performance Measures	GO	NO GO
1. Identified classification of classified material.	___	___
2. Located and read the declassification and downgrading instructions.	___	___
3. Marked documents with all required identification and markings, or corrected incorrect markings.	___	___
4. Restricted access to classified information:	___	___
a. Determined the requirement for access before releasing classified material to other persons:		
(1) Determined the need-to-know.		
(2) Determined security clearance.		
b. Prevented unauthorized persons from gaining access to classified material.		
(1) Kept all classified documents under constant observation when removed from storage.		
(2) Kept documents face down or covered when not in use.		
(3) Took appropriate measures when uncleared personnel entered the work area.		
5. Placed appropriate cover sheets on classified material.	___	___
6. Safeguarded classified information and material.	___	___
a. Safeguarded classified information when temporarily departing the work area.		
b. Prevented display of classified information in public places.		
c. Used correct procedures when creating classified working papers.		

Skill Level 3



Performance Measures	GO	NO GO
7. Complied with security regulations when discussing classified information.	___	___
a. Refrained from classified and/or sensitive information on an unsecured telephone.		
b. Used correct security procedures when presenting a classified briefing.		
c. Used proper controls when using automated information systems.		
8. Protected classified information during transport.	___	___
9. Identified reference delineating correct transmission procedures.	___	___
10. Locked classified material in an appropriate security container, when not in use.	___	___
a. Locked and/or checked security container.		
b. Initialed and dated SF 702.		
c. Turned sign to "CLOSED" position.		
11. Took appropriate action upon discovery of possible compromise of classified information.	___	___
12. Completed DA Form 3964, and determined best destruction method for documents of various classifications.	___	___
a. Listed three methods of destruction.		
b. Identified the two standards of destruction.		

Skill Level 3

**Evaluation Guidance:** Score the soldier GO if all performance measures are passed. Score the soldier NO GO if any performance measure is failed. If the soldier scores NO GO, show what was done wrong and how to do it correctly.

**References**

**Required**

**Related**

AR 380-5

---

**805C-PAD-3594**

**Store Classified Information and Materials**

**Conditions:** You are a squad/section leader. Given classified material, storage containers, and AR 380-5.

**Skill Level 3**

**805C-PAD-3594**

**3-305**

**Standards:** Classified information and materials were placed in appropriate storage containers.

---

**Performance Steps**

---

1. Determine storage and safekeeping requirements.
  - a. Determine security containers .
  - b. Determine locks .
  - c. Determine access authorizations .
2. Maintain physical security.
  - a. Establish responsibility for securing and controlling classified area.
  - b. Establish records for recording security of classified materials.
  - c. Train section personnel on security requirements for classified materials.

---

**Evaluation Preparation:**

*Setup:* To evaluate this task give a scenario that would require soldier to perform the performance measures. This will require simulated containers, locks, DA Form 702, a list of section personnel with varying security clearances, documents marked with various levels of security classification (marked "classified for training purposes only"), format for security check assignment, and classified document covers.

*Brief Soldier:* Tell the soldier he will be evaluated on his ability to select the appropriate container for each document concerned and indicate who would have access to which container.

Performance Measures	GO	NO GO
1. Determined storage and safekeeping requirements.	___	___
a. Determined proper security containers .		
b. Determined proper locks .		
c. Determined who had access authorization.		
2. Maintained physical security.	___	___
a. Established responsibility for securing and controlling classified area.		
b. Established records for recording security of classified materials.		
c. Trained section personnel on security requirements for classified materials.		

**Evaluation Guidance:** Score the soldier GO on performance measures passed. Score the soldier NO GO on any performance measures failed. The

Skill Level 3

soldier must score a GO on all of the performance measures to receive a GO on the task. If the soldier scores NO GO, show him what was wrong.

#### References

##### Required

AR 380-5

##### Related

### SUBJECT AREA 24: ENEMY PERSONNEL

## 191-379-4450

### Supervise Handling of Enemy Personnel and Equipment at Squad Level

**Conditions:** You are a squad leader in a field environment, given a squad of soldiers, DD Form 2745, and enemy prisoners of war (EPWs) with equipment and weapons.

**Standards:** Ensured soldiers searched, segregated, silenced, speeded, safeguarded, and tagged (5 Ss and T) EPWs according to FM 3-19.40.

#### Performance Steps

1. Search captives.

a. Thoroughly search each captive and confiscate any weapons, ammunition, military equipment, and items with intelligence value and record on DD Form 2745.

**Note.** Any weapons or ammunition that are impractical to retain should be destroyed in place after recording what the items were.

b. Allow captives to keep personal property (except items that could be used as weapons or that could have intelligence value) of nominal or sentimental value, such as wedding rings. Personal property also includes chemical protective equipment (if in a chemical environment or a potential chemical environment), helmets, and identification cards. Allow the EPW/civilian internee (CI) to retain his own rations in the early stages of captivity.

**Note.** Conduct same gender searches when possible; however, this may not always be possible due to speed and security considerations. Therefore, mixed gender searches must be performed in a respectful manner using all possible measures to prevent any action that could be interpreted as sexual molestation or assault. The squad leader must carefully control soldiers doing mixed gender searches to prevent allegations of sexual misconduct. This does not mean the search will not be thorough, as the safety of you and your soldiers comes first.

2. Segregate captives.

Skill Level 3

Skill Level 3

191-379-4450

3-307

---

**Performance Steps**

---

- a. Segregate by rank (officers, noncommissioned officers [NCOs], or enlisted), sex (male and female), civilian and military and, when possible, nationalities and/or ideologies.
  - b. Segregate captives who surrendered willingly or who deserted from those who resisted capture.
  - c. Segregate captives who cannot be readily identified as belonging to one of the above listed groups.
  - d. Segregate captives who do not provide the information needed to make a correct classification, until their status can be determined.
3. Ensure that each captive has DD Form 2745.
- a. Ensure that the form contains the following:
    - (1) Date and time of the capture.
    - (2) Grid coordinates of the capture.
    - (3) Capturing unit.
    - (4) Circumstances of the capture.
  - b. Use either DD Form 2745 or a locally produced three-part form. Figure 191-379-4450-1 shows what the form looks like. Instructions for the use of this form are on the reverse side of the form.
    - (1) Place part A of the form on the captive and instruct him not to remove or alter it.
    - (2) Place part C of the form on the bag or bundle of property taken from the captive.
    - (3) Maintain part B of the form, as you are the capturing unit.
- 

Skill Level 3

Performance Steps

<p align="center"><b>ENEMY PRISONER OF WAR (EPW) CAPTURE TAG (PART A)</b></p> <p align="center">For use of this form, see AR 190-8. The proponent agency is DCSOPS.</p> <p align="center"><b>Attach this part of tag to EPW. (Do not remove from EPW.)</b></p> <ol style="list-style-type: none"> <li><b>Search</b> - For weapons, military documents, or special equipment.</li> <li><b>Silence</b> - Prohibit talking among EPWs for ease of control.</li> <li><b>Segregate</b> - By rank, sex, and nationality.</li> <li><b>Safeguard</b> - To prevent harm or escape.</li> <li><b>Speed</b> - Evacuate from the combat zone.</li> <li><b>Tag</b> - Prisoners and documents or special equipment.</li> </ol> <p align="center"><small>DD FORM 2745 (BACK), MAY 98</small></p>	<table border="1"> <tr> <td>1. DATE AND TIME OF CAPTURE</td> <td>2. SERIAL NO.</td> <td align="right"><b>A</b></td> </tr> <tr> <td>3. NAME</td> <td colspan="2">4. DATE OF BIRTH</td> </tr> <tr> <td>5. RANK</td> <td colspan="2">6. SERVICE NO.</td> </tr> <tr> <td>7. UNIT OF EPW</td> <td colspan="2">8. CAPTURING UNIT</td> </tr> <tr> <td colspan="3">9. LOCATION OF CAPTURE (Grid coordinates)</td> </tr> <tr> <td>10. CIRCUMSTANCES OF CAPTURE</td> <td>11. PHYSICAL CON- DITION OF EPW</td> <td>12. WEAPONS, EQUIP- MENT, DOCUMENTS</td> </tr> </table> <p align="center"><small>DD FORM 2745, MAY 98</small>      <small>REPLACES DA FORM 5976, JAN 91, USABLE UNTIL EXHAUSTED.</small></p>	1. DATE AND TIME OF CAPTURE	2. SERIAL NO.	<b>A</b>	3. NAME	4. DATE OF BIRTH		5. RANK	6. SERVICE NO.		7. UNIT OF EPW	8. CAPTURING UNIT		9. LOCATION OF CAPTURE (Grid coordinates)			10. CIRCUMSTANCES OF CAPTURE	11. PHYSICAL CON- DITION OF EPW	12. WEAPONS, EQUIP- MENT, DOCUMENTS
1. DATE AND TIME OF CAPTURE	2. SERIAL NO.	<b>A</b>																	
3. NAME	4. DATE OF BIRTH																		
5. RANK	6. SERVICE NO.																		
7. UNIT OF EPW	8. CAPTURING UNIT																		
9. LOCATION OF CAPTURE (Grid coordinates)																			
10. CIRCUMSTANCES OF CAPTURE	11. PHYSICAL CON- DITION OF EPW	12. WEAPONS, EQUIP- MENT, DOCUMENTS																	
<p align="center"><b>UNIT RECORD CARD (PART B)</b></p> <p align="center">Forward to Unit. (Capturing unit retains for records.)</p> <p align="center">Use string, wire, or other durable material to attach the appropriate section of this form to the EPW's equipment or property.</p> <p align="center"><small>DD FORM 2745 (BACK), MAY 98</small></p>	<table border="1"> <tr> <td>1. DATE AND TIME OF CAPTURE</td> <td>2. SERIAL NO.</td> <td align="right"><b>B</b></td> </tr> <tr> <td>3. NAME</td> <td colspan="2">4. DATE OF BIRTH</td> </tr> <tr> <td>5. RANK</td> <td colspan="2">6. SERVICE NO.</td> </tr> <tr> <td>7. UNIT OF EPW</td> <td colspan="2">8. CAPTURING UNIT</td> </tr> <tr> <td colspan="3">9. LOCATION OF CAPTURE (Grid coordinates)</td> </tr> <tr> <td>10. CIRCUMSTANCES OF CAPTURE</td> <td>11. PHYSICAL CON- DITION OF EPW</td> <td>12. WEAPONS, EQUIP- MENT, DOCUMENTS</td> </tr> </table> <p align="center"><small>DD FORM 2745, MAY 98</small>      <small>REPLACES DA FORM 5976, JAN 91, USABLE UNTIL EXHAUSTED.</small></p>	1. DATE AND TIME OF CAPTURE	2. SERIAL NO.	<b>B</b>	3. NAME	4. DATE OF BIRTH		5. RANK	6. SERVICE NO.		7. UNIT OF EPW	8. CAPTURING UNIT		9. LOCATION OF CAPTURE (Grid coordinates)			10. CIRCUMSTANCES OF CAPTURE	11. PHYSICAL CON- DITION OF EPW	12. WEAPONS, EQUIP- MENT, DOCUMENTS
1. DATE AND TIME OF CAPTURE	2. SERIAL NO.	<b>B</b>																	
3. NAME	4. DATE OF BIRTH																		
5. RANK	6. SERVICE NO.																		
7. UNIT OF EPW	8. CAPTURING UNIT																		
9. LOCATION OF CAPTURE (Grid coordinates)																			
10. CIRCUMSTANCES OF CAPTURE	11. PHYSICAL CON- DITION OF EPW	12. WEAPONS, EQUIP- MENT, DOCUMENTS																	
<p align="center"><b>DOCUMENT/SPECIAL EQUIPMENT WEAPONS CARD (PART C)</b></p> <p align="center">Attach this part of tag to property taken. (Do not remove from property.)</p> <p align="center">As a minimum, the tag must include the following information:</p> <p>Item 1. Date and time of capture (YYYYMMDD). Item 8. Capturing unit. Item 9. Place of capture (grid coordinates). Item 10. Circumstances of capture (how the EPW was captured).</p> <p align="center"><small>DD FORM 2745 (BACK), MAY 98</small></p>	<table border="1"> <tr> <td>1. DATE AND TIME OF CAPTURE</td> <td>2. SERIAL NO.</td> <td align="right"><b>C</b></td> </tr> <tr> <td>3. NAME</td> <td colspan="2">4. DATE OF BIRTH</td> </tr> <tr> <td>5. RANK</td> <td colspan="2">6. SERVICE NO.</td> </tr> <tr> <td>7. UNIT OF EPW</td> <td colspan="2">8. CAPTURING UNIT</td> </tr> <tr> <td colspan="3">9. LOCATION OF CAPTURE (Grid coordinates)</td> </tr> <tr> <td colspan="3">10. DESCRIPTION OF WEAPONS, SPECIAL EQUIPMENT, DOCUMENTS</td> </tr> </table> <p align="center"><small>DD FORM 2745, MAY 98</small>      <small>REPLACES DA FORM 5976, JAN 91, USABLE UNTIL EXHAUSTED.</small></p>	1. DATE AND TIME OF CAPTURE	2. SERIAL NO.	<b>C</b>	3. NAME	4. DATE OF BIRTH		5. RANK	6. SERVICE NO.		7. UNIT OF EPW	8. CAPTURING UNIT		9. LOCATION OF CAPTURE (Grid coordinates)			10. DESCRIPTION OF WEAPONS, SPECIAL EQUIPMENT, DOCUMENTS		
1. DATE AND TIME OF CAPTURE	2. SERIAL NO.	<b>C</b>																	
3. NAME	4. DATE OF BIRTH																		
5. RANK	6. SERVICE NO.																		
7. UNIT OF EPW	8. CAPTURING UNIT																		
9. LOCATION OF CAPTURE (Grid coordinates)																			
10. DESCRIPTION OF WEAPONS, SPECIAL EQUIPMENT, DOCUMENTS																			

Figure 191-379-4450-1. Sample of DD Form 2745

4. Report the acquisition of captives through your chain of command.
5. Safeguard each captive until they are released to the military police (MP).
6. Evacuate captives to the rear and turn them over to the MP as soon as possible. Do not delay evacuation to obtain name, rank, service number, or date of birth.
  - a. Ensure that you receive receipts from the MP for the captives transferred to them.

Skill Level 3

---

**Performance Steps**

---

b. Give items taken from the captives (for security and/or intelligence reasons) to the MP, ensuring that each item is tagged by the MP to identify the owner.

---

**Evaluation Preparation:**

*Setup:* Position soldiers to perform the mission. Have one or more soldiers to act as EPWs. Provide weapons and equipment for the role players.

*Brief Soldier:* Tell the squad leader to instruct the soldiers on what they are to do and have the soldiers actually perform the steps necessary to complete the task. Tell the captive that he needs to follow instructions. Tell the soldiers acting as the squad not to continue to the next step until they are told to do so by the squad leader.

Performance Measures	GO	NO GO
1. Searched captives.	___	___
2. Segregated captives.	___	___
3. Ensured that each captive had DD Form 2745.	___	___
4. Reported the acquisition of captives through the chain of command.	___	___
5. Safeguarded each captive until they were released to the MP.	___	___
6. Evacuated captives to the rear and turned them over to the MP as soon as possible.	___	___

Skill Level 3

**Evaluation Guidance:** Score the soldier GO if all performance measures are passed. Score the soldier NO GO if any performance measure is failed. If the soldier fails any performance measure, show him how to do it correctly.

**References****Required**

AR 190-8  
DD Form 2745  
FM 3-19.40  
STANAG 2044

**Related**

**SUBJECT AREA 27: RISK MANAGEMENT**

**850-001-3001**

**Control Mission Safety Hazard**

**Conditions:** As a company level senior leader, in a garrison or tactical environment, given a subordinate who has received a mission or task.

**Standards:** Verified that a risk assessment had been conducted, controls had been developed and properly implemented, the overall risk level for the mission or task was acceptable, and that the controls were effectively monitored.

**Performance Steps**

1. Verify a risk assessment has been conducted.
  - a. Ensure that all hazards associated with the mission or task have been identified.
  - b. Ensure the level of risk for each hazard was correctly estimated.
2. Verify controls have been developed and properly implemented.
  - a. Ensure appropriate controls have been developed.
  - b. Ensure the residual risk for each hazard and the overall residual risk for the mission or task is acceptable.
  - c. Ensure controls have been properly implemented.
3. Verify how the controls will be monitored.
  - a. Verify the technique for monitoring the controls.
  - b. Verify how well the controls and the risk management process worked.

**Evaluation Preparation:**

*Setup:* To evaluate this task, you will need a completed risk assessment for a mission task. It will be necessary to develop a short OPORD or FRAGO with a scenario for a commonly used combat operation (such as a road march, move to contact) that contains a minimum of one hazard. Develop a complete written risk assessment to represent an assessment, which a subordinate has performed. The risk assessment must include the level of risk, the controls, the residual risk for each hazard, and the overall residual risk for the mission.

*Brief Soldier:* Tell the soldier you are going to evaluate him on his ability to supervise the implementation of the risk management process.

Skill Level 3

Performance Measures	GO	NO GO
1. Verified that all the hazards associated with the mission or task (a minimum of one, depending on the mission or task) had been identified.	—	—
2. Verified the level of risk for each hazard was correctly estimated.	—	—
3. Verified the controls for each hazard.	—	—
4. Verified the residual risk for each hazard and the overall residual risk for the mission or task was acceptable.	—	—
5. Verified methods for implementing the controls.	—	—
6. Verified controls were effective.	—	—

**Evaluation Guidance:** Score the soldier GO if all performance measures are passed. Score the soldier NO GO if any performance measure is failed. If the soldier fails any performance measure, show what was done wrong and how to do it correctly.

**References**

Required	Related
FM 100-14	
FM 101-5	

**SUBJECT AREA 28: ADMINISTRATION/MANAGEMENT**

**805C-PAD-3147**

**Prepare the Senior Rater's Portion of a Noncommissioned Officer Evaluation Report (NCOER)**

**Conditions:** You are a supervisor and must senior rate one of your subordinate NCOs. You are given a partially completed DA Form 2166-8, AR 623-205, paper, and pen/pencil.

**Standards:** All elements of the senior rater portion of the NCOER were completed with comments entered in bullet style, and justification entered where required.

**Performance Steps**

1. Determine if eligible to render report.
2. Verify rater has completed all entries and comments.

3-312

805C-PAD-3147

Skill Level 3

Skill Level 3



---

**Performance Steps**

---

**Note.** Refer to AR 623-205 for actions required if these were not completed.

- a. Return NCOER to rater if all entries and comments are not completed.
  - b. Return NCOER to rater if entries are incorrectly completed.
3. Enter Ratings:
- a. Enter bullet comments in Block Ve, if senior rater qualifications are met.
    - (1) Enter bullet comments addressing marginal ratings in Part Va.
    - (2) Enter bullet comments addressing fair or poor ratings in Part Vc.
    - (3) Enter comments focusing on potential, performance, and/or rater evaluation.
  - b. Enter "senior rater does not meet minimum qualifications" in Block Ve if applicable.
  - c. Enter overall performance evaluation in Block Vc if senior rater qualifications met.
  - d. Enter overall potential for promotion and retention in Block Vd if senior rater qualifications are met.
- 4. Sign the NCOER in Part II, Block b.
  - 5. Obtain rated NCO's signature in Part II, Block c.
  - 6. Forward NCOER to reviewer.
- 

**Evaluation Preparation:**

*Setup:* To evaluate this task provide the soldier with a partially completed DA Form 2166-8, AR 623-205, pencil, and paper. Give a scenario that would require a soldier to ensure that all of the rater's entries are correct and provide enough information about individuals to allow for ratings.

*Brief Soldier:* Tell the soldier that he will be evaluated on his ability to prepare the senior rater's portion of a Noncommissioned Officer Evaluation Report (NCOER)

Performance Measures	GO	NO GO
1. Determined if eligible to render report.	___	___
2. Verified rater completed all entries and comments. <i>Note.</i> Referred to AR 623-205 for actions required if these were not completed.	___	___
a. Returned NCOER to rater if all entries and comments were not completed.		

Skill Level 3

Performance Measures	GO	NO GO
b. Returned NCOER to rater if entries were incorrectly completed.		
3. Entered ratings —	—	—
a. Entered bullet comments in Block Ve if senior rater qualifications were met.		
(1) Entered bullet comments addressing marginal ratings in Part Va.		
(2) Entered bullet comments addressing fair or poor ratings in Part Vc.		
(3) Entered comments focusing on potential, performance, and/or rater evaluation.		
b. Entered "senior rater does not meet minimum qualifications" in Block Ve if applicable.		
c. Entered overall performance evaluation in Block Vc if senior rater qualifications were met.		
d. Entered overall potential for promotion and retention in Block Vd if senior rater qualifications were met.		
4. Signed Part II, Block b.	—	—
5. Acquired rated soldier's signature in Part II, Block c.	—	—
6. Forwarded NCOER to reviewer.	—	—

Skill Level 3

**Evaluation Guidance:** Score the soldier GO on performance measures passed. Score the soldier NO GO on any performance measures failed. The soldier must score a GO on performance measures 1 to 4 to receive a GO on the task. If the soldier scores NO GO, show him what was wrong.

**References**

**Required**

AR 623-205  
DA Form 2166-8

**Related**

Software-FormFlow  
Software-Office  
Software-Windows

Skill Level 4

SUBJECT AREA 2: FIRST AID

**081-831-1047**

**Supervise the Implementation of Preventive Medicine Policies**

**Conditions:** You are a leader in a unit performing a mission in a field environment. You are responsible to ensure personnel employ preventive medicine measures (PMMs) to protect themselves from disease and nonbattle injuries.

**Standards:** Ensured soldiers applied PMMs, as appropriate, to protect against cold, heat, biting insects, diarrhea and dysentery, hearing loss, skin infections, sexually transmitted diseases (STD), acquired immunodeficiency syndrome (AIDS), and foot problems. Ensured soldiers practiced good oral hygiene and properly disposed of waste. Ensured that the Army tobacco use policies were applied.

**Performance Steps**

1. Ensure proper preventive medicine measures (PMM) are followed for protection against cold injuries.

a. Wear layers of loose clothing.

**Note.** Minimize sweating. When clothing becomes wet or dirty, it loses its ability to provide warmth.

(1) Remove layers of clothing before doing strenuous work.

**WARNING**

Do not remove protective clothing in a chemical environment.

(2) Replace layers of clothing when your strenuous work is completed.

(3) Launder clothing regularly.

b. Exercise to increase blood circulation.

(1) Tighten and relax arm and leg muscles, fingers, and toes.

(2) Use hands to massage and warm the face.

**WARNING**

Physical and mental weariness contribute to inactivity, reduced heat, and increased chance for cold injury.

(3) Refrain from smoking. Smoking decreases blood flow to the skin.

Skill Level 4

---

### Performance Steps

---

c. Change socks.

(1) Put on dry socks during rest breaks to reduce the risk of frostbite and trench foot.

**WARNING**

Severe frostbite and trench foot can result in the loss of hands or feet.

(2) Put damp socks inside your shirt around your waist to dry.

d. Prevent dehydration.

(1) Drink sufficient fluids (potable water, juices, and warm nonalcoholic beverages).

**Note.** Drinking a sufficient amount of potable water in cold weather is as important as it is in hot weather. In cold weather, you may not realize that your body is losing fluids and salt. Sweat evaporates rapidly or is absorbed so completely by the layers of clothing that it is seldom visible on the skin.

(2) Rest when possible.

e. Pair with a buddy.

(1) Remind each other to do warming exercises often.

(2) Watch for signs of cold injury such as frostbite, trench foot, and hypothermia.

2. Ensure proper PMMs are followed for protection against heat injuries .

a. Drink sufficient amounts of water.

**Note.** Your body needs a minimum amount of water for cooling, waste elimination, and metabolism. Any attempt to train the body to use less water can be harmful and may lead to heat injuries.

---

Skill Level 4

3-316

081-831-1047

Skill Level 4

**Performance Steps**

(1) Use the fluid replacement policy for warm weather table as a guide (see tables 081-831-1047-1 and 081-831-1047-2).

Table 081-831-1047-1. *Fluid Replacement Policy for Warm Weather (Average Acclimated Soldier Wearing BDU, Hot Weather)							
		Easy Work		Moderate Work		Hard Work	
Heat Category	WBGT Index, °F	Work/ Rest	Water Intake, Qt/Hr	Work/ Rest	Water Intake, Qt/Hr	Work/ Rest	Water Intake, Qt/Hr
1*	78 – 81.9	NL	½	NL	¾	40/20 min	¾
2 (green)	82 – 84.9	NL	½	50/10 min	¾	30/30 min	1
3 (yellow)	85 – 87.9	NL	¾	40/20 min	¾	30/30	1
4 (red)	88 – 89.9	NL	¾	30/30 min	¾	20/40 min	1
5** (black)	>90	50/10 min	1	20/40 min	1	10/50	1

**CAUTION**  
Hourly Fluid Intake Should Not Exceed 1½ Quarts. Daily Fluid Intake Should Not Exceed 12 Quarts.

\*The work/rest times and fluid replacement volumes will sustain performance and hydration for at least 4 hours of work in the specified heat category. Individual water needs will vary ± ¼ quart per hour.  
 \*NL = no limit to work time per hour. Rest means minimal physical activity (sitting or standing) and should be accomplished in shade if possible.  
 \*Wearing body armor adds 5° F to WBGT Index.  
 Wearing ALL MOPP overgarments adds 10° F to WBGT Index.  
 \*\*Suspend physical training and strenuous activity. If an operational (nontraining) mission requires strenuous activity, enforce water intake to minimize expected heat injuries.



**Performance Steps**

Table 081-831-1047-2. Examples of Categories of Work		
<i>Easy Work</i>	<i>Moderate Work</i>	<i>Hard Work</i>
<ul style="list-style-type: none"> <li>• Weapon maintenance.</li> <li>• Walking on hard surface at 2.5 mph, ≤ 30-pound load.</li> <li>• Manual of arms.</li> <li>• Marksmanship training.</li> <li>• Drill and ceremony.</li> </ul>	<ul style="list-style-type: none"> <li>• Walking on loose sand at 2.5 mph, no load.</li> <li>• Walking on hard surface at 3.5 mph, &lt; 40-pound load.</li> <li>• Calisthenics.</li> <li>• Patrolling.</li> <li>• Individual movement techniques, i.e. low crawl, high crawl.</li> <li>• Defensive position construction.</li> <li>• Field assaults.</li> </ul>	<ul style="list-style-type: none"> <li>• Walking on loose sand at 2.5 mph with load.</li> <li>• Walking on hard surface at 3.5 mph, ≥ 40-pound load.</li> </ul>

(2) Drink extra water before combat operations.

(3) Maintain excess water in your system for strength and alertness.

(4) Protect yourself from dehydration and heat injuries associated with wearing full chemical protective gear.

b. Rest whenever possible.

(1) Take rest breaks in accordance with the heat condition table as the tactical situation permits.

(2) Use rest breaks to drink water and to cool off.

c. Eat meals.

(1) Eat regular meals daily to replace salt lost through heavy sweating.

(2) Eat something at each meal, even if you are not hungry.

**Note.** Usually, eating field rations or liberal salting of the garrison diet will provide enough salt. Excess intake of salt should be avoided.

d. Protect yourself from exposure.

(1) Wear uniform properly.

(2) Provide shade whenever possible.

(3) Use barrier creams and lotions.

3. Ensure proper PMMs are followed for protection against biting insects.

Skill Level 4

---

**Performance Steps**

---

**a.** Apply extended-duration repellent lotion—

**Note.** Extended-duration repellent lotion is a preparation that can be used on the skin.

- (1) On exposed skin except the eyes, lips, and sensitive skin.
- (2) Two inches under edges of battle dress uniform (BDU).
- (3) Keep away from flame or excessive heat.
- (4) Wipe hands after application.

**Note.** Repeat the above application every 6 hours during strenuous activity and soon after any activity that washes away the repellent (such as stream crossings).

**Note.** Do not wear after-shave lotion or cologne in the field; they attract biting or stinging arthropods (insects).

**b.** Apply permethrin aerosol clothing repellent.

- (1) Use only on fabric.
- (2) Do not apply to skin.
- (3) Do not treat BDUs while being worn.
- (4) Treat outside of BDU, insect head net, and mosquito bed net.
- (5) Do not treat underwear or inside the cap.
- (6) Avoid breathing vapors.
- (7) Dry clothing (BDUs) thoroughly prior to wearing.

**c.** Wear uniform properly.

- (1) Tuck pant legs into boots, roll sleeves down, and close collar.
- (2) Wear uniform loosely.
- (3) Check clothing frequently.
- (4) Use buddy system to check areas of body not easily seen during self-examination.

**d.** Take malaria pills to protect against malaria parasites. (Use in the manner prescribed for your unit.)

**e.** Clean and inspect yourself.

- (1) Wash yourself daily or as often as the tactical situation permits.
- (2) Use the buddy system to check each other for ticks and for arthropod bites. (If ticks are found attached or if insect bites are found, seek medical attention.)

(3) Use insecticide powder, cream, or shampoo when prescribed by medical personnel.

**f.** Clean and inspect your clothing.A vertical rectangular box with a light gray background and a thin black border. The text "Skill Level 4" is written vertically in a bold, black, sans-serif font.

---

**Performance Steps**

---

- (1) Wash your uniform to remove arthropods and their eggs.
- (2) Use available military laundry service or scrub your clothing yourself with soap and water.
- g. Use your bed net when sleeping.
  - (1) Suspend bed net above sleeping area.
  - (2) Tuck edges of bed net under the sleeping pad or bag.
  - (3) Treat the bed net with permethrin aerosol clothing repellent.
  - (4) Spray interior space with resmethrin.
  - (5) Avoid breathing vapors.
  - (6) Do not use permethrin clothing repellent or resmethrin on skin.

4. Ensure proper PMMs are followed for protection against diarrhea and dysentery.

- a. Identify the indications of diarrhea and dysentery.

**Note.** Diarrhea is an intestinal disorder characterized by abnormally frequent and watery bowel movements.

**Note.** Dysentery is an infectious disease characterized by stomach pain and diarrhea with passage of mucus and blood.

- b. Purify your drinking water if treated water is not available.

**Note.** Before using iodine tablets, check them for physical change. If they are old, they can lose their disinfecting ability. Tablets that are not uniformly steel gray or that are stuck together or crumbled should not be used.

- (1) Fill your canteen with the cleanest, clearest water available.
- (2) Add iodine tablets.
  - (a) Add two tablets to a one-quart canteen of water.
  - (b) Double the amount of tablets if a two-quart canteen is used.
- (3) Replace the cap.
- (4) Wait five minutes for the tablets to dissolve.
- (5) Shake the canteen to mix the contents.
- (6) Disinfect the canteen cap threads.
  - (a) Loosen the cap.
  - (b) Tip the canteen over and squeeze to allow leakage around the canteen threads.
  - (c) Turn the canteen right side up.
  - (d) Tighten the cap.
- (7) Wait 30 additional minutes before drinking.

Skill Level 4



---

**Performance Steps**

---

- c. Obtain food and drink from an approved source.
  - (1) Obtain food, drink, and ice only from medically approved sources.

**Note.** Do not obtain food, drink, and ice from vendors unless they have been approved by medical personnel.

  - (2) Obtain food from the dining facility when possible.
- d. Wash your hands for at least 30 seconds —
  - (1) After using the latrine.
  - (2) Before touching eating utensils or food.
  - (3) After eating.
  - (4) After smoking.
- e. Dispose of food waste properly.
  - (1) Use covered container to keep out pests and to prevent breeding of flies.
  - (2) Use plastic bags in the event you have dumpster-type receptacles and regular waste pick-up.
  - (3) Bury in the event you are in the field and do not have waste pick-up or other disposal methods available.

**Note.** Before burying any waste, obtain prior approval by contacting either the logistics or the preventive medicine section.
- 5. Ensure proper PMMs are followed for protection against hearing loss.
  - a. Wear protective devices such as earplugs, ear canal caps, or earmuffs.
  - b. Wear vehicle headgear such as helicopter crew helmets and armored vehicle crew helmets.
  - c. Keep hearing protection devices clean to avoid ear infections.
  - d. Avoid noise and/or limit the time in noise hazardous areas.
- 6. Ensure proper PMMs are followed to prevent skin infections.
  - a. Bathe frequently. Take a full bath at least once every week. If showers or baths are not available, use a washcloth daily to wash—
    - (1) Your genital area.
    - (2) Your armpits.
    - (3) Your feet.
    - (4) Other areas where you sweat or that become wet (between thighs or [for females] under breasts).
  - b. Keep skin dry.

Skill Level 4

---

**Performance Steps**

---

(1) Use foot powder on your feet (especially if you have had fungal infections in the past).

(2) Use talcum powder in areas where wetness is a problem. (Cornstarch may be used as a substitute for talcum powder.)

c. Change to clean clothing after a full bath.

(1) Wear loose-fitting uniforms to allow for better ventilation and blood circulation.

(2) Wear proper clothing.

**Note.** Do not wear nylon or silk-type undergarments. Cotton undergarments allow more evaporation of moisture.

d. Shave facial hair often enough to be clean shaven (males only) to allow a tight fit of the protective mask.

7. Ensure proper PMMs are followed for care for the feet.

a. Before movement.

(1) Wear the proper type of footgear, correctly fitted and broken in.

(2) Wear clean socks that are free of holes or knotty darns.

(3) Use foot powder and clean socks.

(4) Treat and protect blisters, pressure spots, and infections before movement.

b. During movement.

(1) Keep feet as dry as possible.

(2) Change socks (if possible) for dry ones when they become damp or wet.

(3) Dry socks by putting them inside your shirt around your waist.

(4) Relieve tender pressure spots on the feet by adjusting gear.

(5) Dust the feet with foot powder once or twice daily.

c. Inspect feet at rest periods.

(1) Wash feet during the noon break if possible.

(2) Raise feet while resting to help reduce congestion and swelling.

d. Take care of blisters.

(1) Wash the blister and the surrounding area with soap and water.

(2) Seek medical treatment for painful blisters or signs of infection such as redness, throbbing, and drainage.

8. Ensure soldiers practice good oral hygiene.

a. Brush your teeth after every meal if possible.

---

Skill Level 4

---

**Performance Steps**

---

- b. Use dental floss at least once a day.
  - c. Rinse your mouth with potable water after brushing and flossing.
9. Ensure soldiers are informed about protection against STD.

- a. Use a prophylactic (condom).

**Note.** Individuals should use a condom during sexual intercourse when there is a possibility of acquiring an infection.

- b. Urinate immediately after intercourse.
- c. Wash well with soap and water.

**Note.** Females should not douche unless directed to do so by medical personnel.

10. Ensure soldiers are informed about protection against AIDS.

**Note.** AIDS is contagious in the same way as STDs are contagious. Infection can result from a sexual relationship with an infected person. Sexual contact is not the only way to contract AIDS but is a major contributor.

- a. Prevent sexual transmission—know your partner.

- (1) Avoid having sex with multiple partners.

- (2) Avoid having sex with persons who might be carriers of the AIDS virus (high-risk groups include homosexual and bisexual persons and intravenous drug users).

- b. Prevent transmission through shared needles or syringes—do not inject illicit drugs.

**Note.** There is presently no cure for AIDS and no vaccine to prevent AIDS.

11. Ensure proper PMMs are followed for disposal of waste.

- a. For human waste—

- (1) Use unit latrine.

- (2) Use cat-hole latrine.

- (a) Use only on the march.

- (b) Cover immediately after use.

- (3) Use a straddle trench for 1 to 3 day bivouac.

- b. For other waste—

- (1) Bury—less than one week in the field.

- (2) Incinerate—longer than one week in the field.

12. Apply Army tobacco use policies.

- a. Long term and immediate adverse effects of tobacco use.

- (1) Leading preventable cause underlying death in the United States is tobacco use.

Skill Level 4

---

**Performance Steps**

---

- (2) Heart disease, cancer, emphysema, stroke.
  - b. Tobacco use in the military.
    - (1) Decreases readiness, night vision, hand-eye coordination, and stamina.
    - (2) Increases cold weather injuries and number of injuries.
    - (3) Leads to addiction.
  - c. Army tobacco use policy.
    - (1) AR 600-63.
    - (2) Smoking is not permitted in DA-space except in designated areas.
    - (3) Healthy People 2000 priorities —
      - (a) Reduce military smokers to 20 percent.
      - (b) Reduce smokeless tobacco use to 4 percent for age groups between 12 and 24.
  - d. Sources to help soldiers become tobacco-free.
    - (1) Medical professionals.
    - (2) Local preventive medicine service.
    - (3) American Cancer Society.
    - (4) Nicotine gum, nicotine patches.
    - (5) Family and unit support.
13. Identify division PM section missions to support field forces.
- a. Identify breakdowns in PMM (individual and leader/unit).
  - b. Inform commanders on specific measures to repair the breakdowns.
  - c. Provide technical assistance for training the unit FSTs.
  - d. Monitor training of individual and unit PMM.
  - e. Perform limited sanitation and vector control work.
14. Identify corps-level PM missions to support field forces.
- a. Corps PM detachments.
    - (1) Provide PM support to deployed forces in the corps/COMMZ in a direct support role or a general support role.
    - (2) Transport organic personnel and equipment with logistical support from a unit in the geographic area.
    - (3) Perform area and aerial spraying missions, medical detachment, PM (ENTO) only.
- 

Skill Level 4

---

**Performance Steps**

---

b. Armored cavalry regiment (ACR). Provide the same type of support to the regiment as the division PM section provides to the division.

c. Separate brigades (separate infantry brigade [SIB] and heavy separate brigade [HSB]). Provide the same type of support to the SIB/HSB that the division PM section provides to the division.

d. Civil affairs (CA) units. Provide support for displaced persons, refugees, and evacuees. Re-establish essential public health services.

---

**Evaluation Preparation:**

*Setup:* Evaluate this task during a field training exercise (FTX) or during a normal training session. If the evaluation is conducted during an FTX, the environmental and physical conditions at the FTX will be used as the scenario for which PMM policies are implemented. If the evaluation is done during a normal training session, create the scenario to include environmental and physical conditions.

*Brief Soldier:* Tell the soldier he will be evaluated on his ability to supervise/ensure appropriate preventive medicine policies are followed. The soldier will respond to appropriate performance measures.

Performance Measures	GO	NO GO
1. Ensured soldiers protected against cold.	___	___
2. Ensured soldiers protected against heat.	___	___
3. Ensured soldiers protected against biting insects.	___	___
4. Ensured soldiers protected against diarrhea and dysentery.	___	___
5. Ensured soldiers protected against hearing loss.	___	___
6. Ensured soldiers protected against skin infections.	___	___
7. Ensured soldiers provided care for the feet.	___	___
8. Ensured soldiers practiced good oral hygiene.	___	___
9. Ensured soldiers understood PMM to protect against sexually transmitted diseases.	___	___
10. Ensured soldiers understood PMM to protect against AIDS.	___	___
11. Ensured soldiers disposed of waste properly.	___	___

Skill Level 4

Performance Measures	GO	NO GO
12. Applied the Army's policies on tobacco use.	—	—
13. Identified division and corps level PMs and their mission.	—	—

**Evaluation Guidance:** Score the soldier GO if all performance measures are passed. Score the soldier NO GO if any performance measure is failed. If the soldier scores NO GO, show what was done wrong and how to do it correctly.

**References**

**Required**

**Related**

- AR 40-5
- AR 600-63
- FM 4-25.11
- FM 21-10

---

**081-831-1055**

**Ensure Unit Combat Lifesaver Requirements Are Met**

**Conditions:** You are an NCO appointed as the combat lifesaver program coordinator. The combat lifesaver correspondence course is going to be used for the unit training.

**Note.** The combat lifesaver program coordinator will be the medical NCO, if one is assigned.

**Standards:** Conducted the combat lifesaver program in accordance with AR 350-1, paragraph 4-12 and subcourse IS0826.

---

**Performance Steps**

1. Research information on the combat lifesaver program.
    - a. Read AR 350-1, paragraph 4-12. The address to access the AR is—  
[http://www.usapa.army.mil/pdffiles/r350\\_1.pdf](http://www.usapa.army.mil/pdffiles/r350_1.pdf)
    - b. Read AMEDDC&S information about the combat lifesaver program and course options. The program is downloadable from the following address—<http://www.cs.amedd.army.mil/clsp>
    - c. Read DA Pam 350-59, Combat Lifesaver Section, section VIII. The address to access the Pam is—  
<http://www.usapa.army.mil/pdffiles/p350-59.pdf>
- 

Skill Level 4

---

## Performance Steps

---

**2.** Determine the number of personnel who need to be trained. Check local unit personnel training records to determine the number of qualified combat lifesavers and distribution of the CLs by squad. (See step 9, Ensure combat lifesavers maintain proficiency.)

**Note.** There should be at least one combat lifesaver per squad, crew, or equivalent-size unit.

**Note.** If there are too few soldiers to be trained, check other units in the area about combining students for the course. There is the possibility you may have too many students requiring more frequent classes until the required number are trained.

**Note.** Recommend that all qualified combat lifesavers notify the combat lifesaver coordinator as soon as a new assignment notification is received. This will allow the coordinator to schedule training of replacement combat lifesavers. A list could be generated by S-1 PAC that shows personnel PCS/ETS and CL status.

**3.** Contact the appropriate staff surgeon combat lifesaver program supervisor at corps/division/brigades and separate brigade-size units. The coordination should be accomplished prior to the start of training.

**Note.** A phone call, e-mail, or memorandum giving notification of intent to conduct a course is normally sufficient. In real life the PAs at the Bn level are aware of the training for local units and the Bn senior medical NCO will probably run the course.

**4.** Identify and appoint a qualified Instructor and assistants as applicable.

**a.** Estimate the number of instructors/assistants required.

**Note.** The surgeon combat lifesaver supervisor or an experienced CL instructor should be able to give you an idea of the student to teacher ratio. Also, if you can obtain a copy of the lesson plans in IS0826, you can determine the number of instructors and assistants required for each lesson.

**b.** If a qualified instructor is not available from the unit being trained, request training instructor support from the next higher command surgeon or local medical treatment facility.

**Note.** The primary instructor will be at least a senior medical NCO and either hold primary 91W, 18D or be a licensed paramedic (state or national), registered nurse, physician assistant, or physician. The instructor for the intravenous infusion lesson must be an expert in administering IVs and qualified to handle emergencies that could arise when students practice initiating IVs. (This can be a senior 91W, 18D, LPN, EMT-1 or P, RN, PA or MD.) For the IV portion, the student/instructor ratio needs to be two students per instructor.

**5.** Enroll selected unit personnel in the combat lifesaver training course at least eight weeks before group instruction begins.

**Note.** Tell the soldiers they can receive eight promotion points for successful completion of the combat lifesaver course.

---

Skill Level 4

---

**Performance Steps**

---

a. Cover letter signed by battalion commander or a lieutenant colonel or higher (see example).

**EXAMPLE OF A COVER LETTER  
(LETTERHEAD)**

ABCD-EFG-H (XXX)

Date

MEMORANDUM FOR Commander, U.S. Army Training Support Center,  
ATTN: ATIC-DLS, Fort Eustis, Virginia 23628-001.

SUBJECT: Enrollment of Students and Instructor in Combat Lifesaver Course

1. Request enrollment of the instructor and students as indicated in the Combat Lifesaver Course.
2. Please code student enrollment applications as indicated on the student roster.
3. Send all printed materials in care of Group Leader SFC Robert B. James, 1<sup>st</sup> Battalion, 509<sup>th</sup> Infantry, APO NY 09168.

For the commander

JOHN J. JONES  
Lieutenant Colonel, Infantry  
Commanding

- 2 Encl
1. DA Form 145
  2. Student roster

Skill Level 4

---

3-328

081-831-1055

Skill Level 4



---

**Performance Steps**

---

**b.** Complete one DA Form 145 enrolling the primary instructor in IS0826 (<http://www.usapa.army.mil/forms/>).

**(1)** Include a list of assistant instructors, if any.

**(2)** Provide the instructor and assistant instructors retirement year ending date (RYE) if applicable Army National Guard (ARNG) and U.S. Army Reserve (USAR).

**(3)** The "student" address on DA Form 145 is the primary instructor's address. All subcourse materials will be sent to the primary instructor.

**(4)** Attach a student roster (see table 081-831-1055-1) with the DA Form 145. List the name, rank, social security number, and unit of each student. For ARNG or USAR, include the retirement year ending (RYE) date.

Table 081-831-1055-1. Example of a Student Roster				
<i>The following students are to be enrolled in the Combat Lifesaver Course</i>				
<b>SSN</b>	<b>Name</b>	<b>Component Code</b>	<b>Branch</b>	<b>Rank</b>
111-11-1111	Ames, Adam A	10		SGT
222-22-2222	Baker, Bruce B	9		CPL
333-33-3333	Clay, Charles C	3		CPL
444-44-4444	Dough, David D	3		SGT
555-55-5555	Edwards, Earnest E	3		CPL
666-66-6666	Frost, Frank F	3		PFC
777-77-7777	Gains, Gary G	3		CPL
888-88-8888	Haines, Harold H	3		CPL
999-99-9999	Kelly, Keith K	3		CPL
111-22-3333	Locke, Larry L	3		CPL
444-55-6666	Manne, Morris M	3		SGT
777-88-9999	Nay, Ned N	3		SGT
111-00-1111	Peach, Paul P	3		CPL
222-23-4444	Ray, Ralph R	3		SSG
999-88-7777	Smith, Stanley S	2	QM	1LT

**(5)** Have the DA Form 145 signed by a responsible official who has the authority to requisition or acquire the necessary medical equipment and supplies in support of the training.

**6.** Obtain equipment and supplies.

**Skill Level 4**

---

**Performance Steps**

---

a. Course equipment and supplies (see table 081-831-1055-2). Items such as intravenous infusion (IV) trainers may need to be purchased. (Check with local medical treatment facilities first.) You can also check with your local Training/Visual Information Support Center (T/VISC) concerning these items.

---



Skill Level 4

3-330

081-831-1055

Skill Level 4

**Performance Steps**

Table 081-831-1055-2. Combat Lifesaver Program Proposed List of Course Supplies for Six Students	
The following items and quantities are required to train six combat lifesaver students	
#2 Lead pencils	1 box for written test and notes
Dressing, field	12
Cravat	12
Gloves, latex surgical/exam	12 pair, assorted sizes 7-8½
Chucks, or equivalent	12 (to absorb fluids and protect table surfaces)
Catheter, Intravenous	18 (21) 20 or 22 gauge; 18 gauge for practice
Container, sharps	1 (for needles)
Plastic trash bags	3 for non-medical waste
Bag, plastic, red HAZMA T	1 for bio waste
IV Moulage, arm strap-on	3 for IV practice
IV administration set	8
Band, elastic	6 (constricting band for IV administration)
Fluid, IV	8 normal saline, Ringer's, or D5W (500 or 1000 ml)
Tape, ½ inch	1 roll
Tape, 1 inch	1 roll
Bandage, adhesive	1 box (Band-Aids)
Capsule, ammonia inhalant	5 (1 box)
Sponge, gauze, 2" x 2"	1 box (24s)
Sponge, gauze, 4" x 4"	1 box (24s)
Pad, povidone-iodine	1 box (24s)
Pad, alcohol	1 box (24s)
Oropharyngeal Airway	3 (different sizes)
Splint, SAM	3
Splint, basewood	4
Training MA RK I antidote kit and CANA	1 (obtained through Training and Audiovisual Support Center (TASC); unit should request)
Combat lifesaver aid bag	1 complete for demonstration
Blanket, OD, wool	1 (for improvised litter task; a poncho may be used)
Poles, tent	2 (the poles are for the improvised litter)
Litter, folding; 3 straps	1 (a litter is desirable for a hands-on exercise)

**Skill Level 4**

---

**Performance Steps**

---

**Note.** Include equipment for the buddy -aid tasks, IS0824, even though it may not be taught in a group. The equipment will be used for the performance evaluation.

**Note.** Plan on enough materials to allow for practice and retests. Your instructor, the staff surgeon combat lifesaver supervisor, or previous instructors of the CL course may be able to give you an idea of how much extra to have on hand.

**Note.** The combat lifesaver program is a continuous ongoing program and requires continuous equipment and material support for the already qualified CLs. Be sure to maintain contact with your supply source to ensure your CL supplies are programmed into the system.

**b.** Resupply of Class VIII supplies for combat lifesaver bags during garrison operations:

**(1)** Request Class VIII resupply through assigned medical personnel.

**(2)** Request Class VIII supplies through the appropriate division, brigade or regimental medical supply office (MSO) when medical personnel are not assigned. For the latest CL bag content list go to: <http://www.armymedicine.army.mil/usamma>

**(3)** Request Class VIII support from the installation medical supply activity (IMSA), normally the MSO of the medical department activity (MEDDAC) or U.S. Army Medical Center (MEDCEN) if a nondivisional unit.

**c.** Resupply, during field operations, is accomplished in the same manner as during garrison operations with two exceptions.

**(1)** Nondivisional units obtain resupply support from the nearest medical unit available.

**(2)** Emergency resupply is provided to all units by the nearest medical unit capable of doing so.

**Note.** Field medical units maintain stocks of medical material with which to effect resupply of combat lifesaver aid bags during field operations.

**7.** Reserve facilities. The facilities should allow the students to clearly see the demonstrations and provide plenty of room for student practice. Make sure there are enough tables and chairs available for the number of students participating.

**8.** Inform instructor, assistant instructors, and students:

**a.** Instructor and assistant instructors.

**Note.** If you are not the medical instructor, the arrangements and documentation should be provided to the primary instructor.

**(1)** Provide a copy of CL memorandum with all attachments.

---

Skill Level 4

---

**Performance Steps**

---

(2) Remind instructor and assistant instructors of target start date for the class and location (such as building, room).

(3) Inform the instructor that administrative information, suggested course schedule, and lesson plans are in IS0826, *Combat Lifesaver Instructor Manual*.

(4) Inform the primary instructor that all student and instructor materials shipped from the Army Institute for Professional Development (AIPD) will be sent to the instructor's address. The instructor is responsible to verify the shipment is complete and to distribute the subcourses to the students.

(a) Distribute IS0824 at least two weeks before written and performance examinations.

(b) Distribute IS0825 at least two weeks before attending class.

**Note.** If classes on IS0825 immediately follow testing on IS0824, then distribute both subcourses at the same time. If possible, provide soldiers a field dressing and two muslin bandages at the time of distribution for practice. Do not give the examination booklets or response sheets to the soldiers.

(5) Inform the course coordinator that the day-to-day administration and conducting of the class is his responsibility once the course materials have been received. (The course coordinator may or may not be the primary instructor.)

b. Inform the soldiers of their selection, start date and location.

9. Ensure combat lifesavers maintain proficiency.

a. Conduct annual (12 month) recertification.

(1) Determine the number of CLs requiring recertification by reviewing local unit training records.

(2) Designate instructor(s). Unit instructors accomplish CL recertification. If no instructors are in the unit, recommend coordinating recertification with the primary instructor for the Combat Lifesaver Course.

(a) Obtain evaluations and lessons. Combat lifesaver recertification tasks are designated in the IS0826 under "Recertification Testing." Use designated CL performance tests and specified lessons available in IS0826; they may be reproduced as needed. Only the most critical, life-saving tasks are designated for recertification requirements.

(b) Obtain equipment needed for recertification (see table 081-831-1055-3.)

---

Skill Level 4

**Performance Steps**

Table 081-831-1055-3. Combat Lifesaver Recertification Performance Examination Equipment and Supplies		
<i>Equipment</i>	<i>NSN</i>	<i>Quantity</i>
IV fluid bag (500 ml)	6505 01 372 3425	2 bags
IV Injection set	6515 01 472 1863	2 sets
Catheter and needle IV unit (18 ga)	6515 01 315 6227	2 units
Tube drain 1 x 18" can be used as constricting band	6515 01 188 5316	
Povidine-iodine impregnated cotton pads	6510 01 010 0307	
Pad isopropyl alcohol	6510 00 786 3736	
Timepiece with second hand. (*If the time can be seen by both CL and evaluator)		*1 2
Manikin suitable for administering modified abdominal thrusts, finger sweeps, and mouth-to-mouth resuscitation	6910 01 206 0312	
Field dressing		
Materials for pressure dressing wad, pressure dressing bandage, tourniquet band and securing materials (4 muslin bandages, for example).		
Rigid object (stick) for tourniquet		
Padding for tourniquet		
Pack, log, or other object to elevate a leg.		

(c) Reserve a training facility (classroom) or area.

(d) Schedule CLs for the recertification.

(e) Make an entry on the combat lifesaver's local training record indicating the date he passed the recertification examination.

b. Ensure combat lifesavers are allowed to practice their skills to maintain proficiency during home station training activities (to include FTXs) and during deployment for training.

**Evaluation Preparation:**

*Setup:* None.

*Brief Soldier:* Tell the soldier that he will be asked to state the steps of ensuring the unit combat lifesaver requirements are met.

Skill Level 4

Performance Measures	GO	NO GO
1. Researched information on the Combat Lifesaver Program.	—	—
2. Determined the number of personnel who need to be trained.	—	—
3. Contacted the appropriate staff surgeon combat lifesaver program supervisor at corps/division/brigade and separate brigade-size units.	—	—
4. Identified and appointed a qualified instructor and assistants as applicable.	—	—
5. Enrolled selected unit personnel in the Combat Lifesaver Training Course at least eight weeks before group instruction began.	—	—
6. Obtained equipment and supplies.	—	—
7. Reserved facilities.	—	—
8. Informed instructor, assistant instructors, and students.	—	—
9. Ensured combat lifesavers maintained proficiency.	—	—

**Evaluation Guidance:** Score the soldier GO if all performance measures are passed. Score the soldier NO GO if any performance measure is failed. If the soldier scores NO GO, show what was done wrong and how to do it correctly.

**References**

**Required**

**Related**

AR 350-1

DA Pam 350-59

IS0826

**SUBJECT AREA 4: SURVIVE (COMBAT TECHNIQUES)**

**071-326-5775**

**Coordinate with an Adjacent Platoon**

**Conditions:** Given a platoon-size element with two adjacent platoon-size elements.

Skill Level 4

Skill Level 4

071-326-5775

3-335

**Standards:** Coordinated with the adjacent platoon-size elements for offensive and defensive operations to ensure mutually supporting positions, fires, and signals.

---

**Performance Steps**

---

1. Coordinate with adjacent elements. After receiving an order for an offensive or defensive operation and during the planning phase, consider coordination with adjacent elements. If you receive the order while all other platoon-size element leaders are present, take that opportunity to coordinate as much as possible to avoid delays later in the operation. While many of the details that must be coordinated will vary with the situation, always coordinate essential items.
2. Coordinate in the offense. In the offense, coordinate—
  - a. Lateral distance between all attacking elements.
  - b. Movement routes, to ensure that mutual support by fire or maneuver can be maintained between the lead elements.
  - c. Visual signals, such as arm -and-hand signals and pyrotechnics.
  - d. Radio call signs.
3. Coordinate in the defense. In the defense, coordinate to ensure that there are no gaps, and that fires interlock and are mutually supporting. Information coordinated includes —
  - a. Location of positions (primary, alternate, and supplementary).
  - b. Dead space between units.
  - c. Location of observation posts (OPs).
  - d. Signals.
  - e. Patrols and ambushes (size, type, time of departure and return, and routes).
  - f. Location and types of obstacles.
  - g. Boundaries.
  - h. Control measures.
4. Allocate final protective fire. If a mortar or artillery final protective fire is allocated to the platoon-size elements, coordinate it with the fire support team (FIST) forward observer (FO) and integrate it into the fire plan for the element.

Skill Level 4

---

**Evaluation Preparation:**

*Setup:* In the defense, provide a field location with varying terrain, two adjacent element leaders, and the last fighting position for each of the flanking elements. In the offensive, provide a field location with varying terrain, and two element leaders from adjacent platoons.



*Brief Soldier:* Tell the soldier that he is the center platoon leader and must coordinate with both adjacent element leaders.

Performance Measures	GO	NO GO
1. Coordinated with adjacent element leaders for offensive operations.	—	—
a. Lateral distance between attaching elements.		
b. Movement routes.		
c. Visual signals.		
d. Radio call signs.		
e. Boundaries.		
f. Control measures.		
2. Coordinated with adjacent leaders for defensive operations.	—	—
a. Location of primary position.		
b. Location of alternate position.		
c. Location of supplementary position.		
d. Dead space between units.		
e. Location of OPs.		
f. Signals.		
g. Patrols and ambushes.		
h. Locations and types of constructed obstacles.		
i. Boundaries.		
j. Control measures.		

**Evaluation Guidance:** Score the soldier GO if all performance measures are passed. Score the soldier NO GO if any performance measure is failed. If the soldier scores NO GO, show what was done wrong and how to do it correctly.

**References**

**Required**

FM 3-21.71  
 FM 7-7  
 FM 7-8  
 FM 3-90.1

**Related**

Skill Level 4

---

## 101-CLT-0198

### Supervise Tactical Feeding Operation

**Conditions:** As a supervisor in a field environment, given AR 30-22, FM 10-23, FM 21-10, FM 4-25.12, STP 21-24-SMCT, TB Med 530, the unit commander has directed you to supervise the field feeding mission.

**Standards:** Supervised personnel in a tactical environment at a field kitchen site and set realistic and attainable goals. Clearly delegated tasks and evaluated performance. Completed all performance measures accurately to ensure that the feeding mission was completed on time.

---

#### Performance Steps

---

1. Ensure soldiers receive three quality meals each day.
  - a. Review the field menu for possible changes.
  - b. Plan to modify the menu using the appropriate forms and procedures.
  - c. Provide the essential nutrients by meeting the requirements of the basic food guide pyramid.
    - (1) A variety of foods.
    - (2) Reduced portion size.
    - (3) Foods drained of excess fat and oil.
    - (4) Baked items when fried foods are offered.
    - (5) Meats trimmed of excess fat.
    - (6) Fresh fruits.
  - d. Plan calories and portion sizes using field-feeding procedures based on operational plans.
2. Ensure feeding site is camouflaged.
  - a. Determine the best available site for the field kitchen operations.
  - b. Select an area that provides good natural cover.
  - c. Erect camouflage net to supplement whatever natural concealment is available.
  - d. Use natural concealment or camouflage net to cover vehicles and field kitchen equipment.
  - e. Plan to place serving line and mess kit laundry line with maximum protection from the enemy by using natural concealment or camouflage net.
3. Keep soldiers disbursed during feeding operations.
  - a. Select an area for operation that provides good natural concealment.
  - b. Select an area that has enough space to prevent crowding.
  - c. Place mess kit laundry line 50 feet (15 meters) from the field kitchen.

Skill Level 4

3-338

101-CLT-0198

Skill Level 4

---

**Performance Steps**

---

- d. Establish and monitor the setup of serving lines during feeding time based on location, enemy activity, unit mission, weather, and visibility.
  - e. Apply one of the following serving-line concepts based on terrain, enemy activity, weather, visibility, and field kitchen equipment being used.
    - (1) One-way staggered.
    - (2) One-way straight.
    - (3) U-shaped (MKT).
    - (4) Two serving lines (MKT).
4. Enforce preventive medicine standards.
- a. Consult with the veterinary officer on food products that are suspected of being contaminated.
    - (1) Inspect for contaminated subsistence.
      - (a) Check canned foods for swellers, leaks, or springers.
      - (b) Check meat, poultry, and seafood for abnormal odor or color.
    - (2) Isolate subsistence, which may be contaminated, so it is not prepared and served.
    - (3) Request a veterinary officer inspect food products that may be contaminated.
    - (4) Request information on how to dispose of food products that are unfit for human consumption.
  - b. Consult with the veterinary officer on the shelf life of food products.
    - (1) Request that officer inspect subsistence when expiration date has expired.
    - (2) Request that officer inspect canned goods that have outward signs of deterioration.
  - c. Obtain certificate of unfitness from the veterinary officer when subsistence is damaged or destroyed and when condemnation loss or report of survey is being completed.
    - (1) Prepare DA Form 3161, *Request for Issue or Turn-in*, for the disposition of unfit items (prepare separate DA Forms 3161 for perishable and semi-perishable subsistence items).
    - (2) Ensure that veterinary or medical personnel, the TISO, and a witness each sign the proper statement on DA Form 3161 stating that the items listed have been inspected and are unfit for human consumption.
    - (3) Ensure that items having no potential sale value are disposed of properly.
    - (4) If using an automated system, enter and process items according

Skill Level 4

---

**Performance Steps**

---

to their disposition.

d. Coordinate with the veterinary officer on problems associated with sanitation, pest control, and the environmental condition of the field site.

(1) Coordinate in assessing the adequacy of food service sanitation practices.

(2) Ask for technical guidance and assist in presentation of food service sanitation training for non-supervisory personnel.

5. Schedule meal times to fit operational plans.

a. Coordinate with the unit commander for unit mission data.

(1) Review previously prepared SOPs, if available.

(2) Determine the regulatory guidelines.

(3) Examine work schedule and equipment layout.

(4) Evaluate current procedures to ensure they are effective.

(5) Verify that procedures to be used are within regulatory guidelines.

(6) Select the procedures to be used.

(7) Provide further guidance based on the unit mission, as needed.

b. Coordinate operation standards with the food advisor.

c. Coordinate with the food service officer.

d. Plan and develop the SOP.

(1) Draft the SOP.

(2) Finalize the SOP.

e. Coordinate with the ration breakdown point and the TISA for requesting and issuing schedules and available menus.

f. Coordinate with the S-4 for supply requirements.

g. Organize the equipment based on the unit mission.

h. Inform the operating team of coordination accomplished.

i. Implement the action plan, using the advanced party to set up the field feeding operation.

---

Skill Level 4

Performance Measures	GO	NO GO
1. Ensured soldiers received three quality meals each day.	—	—
2. Ensured feeding site was camouflaged.	—	—
3. Kept soldiers disbursed during feeding operations.	—	—

Performance Measures	GO	NO GO
4. Enforced preventive medicine standards.	___	___
5. Scheduled meal times to fit operational plans.	___	___

**Evaluation Guidance:** Score the soldier GO if all performance measures are passed. Score the soldier NO GO if any performance measure is failed. If the soldier scores NO GO, show him what was done wrong and how to do it correctly.

**References**

**Required**

- AR 30-22
- FM 4-25.12
- FM 10-23
- FM 21-10
- STP 21-24-SMCT
- TB Med 530

**Related**

**SUBJECT AREA 19: CROWD CONTROL**

**191-379-5400**

**Form the Platoon into a Riot Control Formation**

**Conditions:** Given a mission to conduct riot control formations and a platoon of soldiers fully equipped with riot control gear.

**Standards:** Issued the correct commands and made on-the-spot corrections to ensure that the platoon correctly executed and formed into one of the following three formations:

1. Platoon line, platoon line with one squad in general support, platoon line with one squad in lateral support, and platoon line with one squad in close support.
2. Platoon echelon, right (or left); platoon echelon, right (or left) with one squad in general support; platoon echelon, right (or left) with one squad in lateral support; and platoon echelon, right (or left) with one squad in close support.
3. Platoon wedge, platoon wedge with one squad in general support, platoon wedge with one squad in lateral support, and platoon wedge with one squad in close support.

Reassembled the platoon from a riot control formation.

**Skill Level 4**

**Skill Level 4**

**191-379-5400**

**3-341**

**Performance Steps**

**Note.** The platoon formation is selected depending on the crowd structure and temperament. Any size squad, platoon, or larger unit may be employed, and a crowd control formation can be adapted to fit the unit organization. For these formations, such as the four-squad platoon, see FM 19-15, chapter 8.

1. Form the platoon in a platoon line (figure 191-379-5400-1).

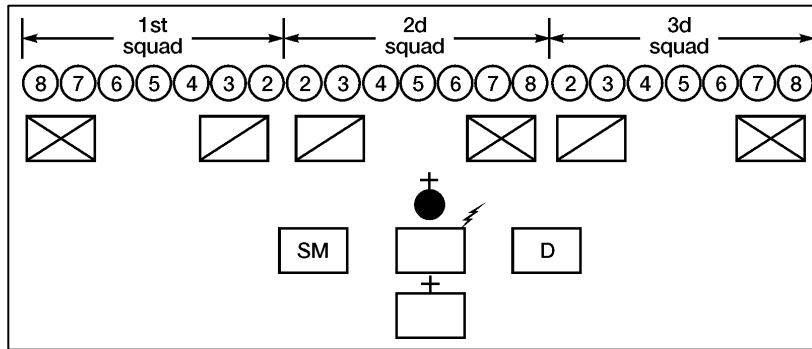

**Figure 191-379-5400-1. Platoon Line**

- a. Give the preparatory command, "Platoon as skirmishers," while simultaneously using hand and arm signals. (Raise both arms straight out to the side, arms and hands extended, palms down.)
- b. Give the execution command, "Move," and at the same time, point to the place where you want the formation. Ensure that the following occur:
  - (1) Squad leaders of first and second squads must give the command, "Follow me," while the leader of the third squad gives the command, "Stand fast."
  - (2) Ensure that the number two member of the second squad is the base member for the formation. The rest of the second squad forms a line to the right of the base member. The first squad forms a line to the left.
  - (3) Ensure that the squad leader of the third squad commands, "Follow me," after the first and second squads have assumed their positions.
  - (4) Ensure that the third squad forms a line to the right of the second squad.

**Note.** All squads dress on the second squad.

2. Form the platoon in a platoon line with one squad in general support.

- a. Form the platoon line with one squad in general support in a column of twos (figure 191-379-5400-2).

Skill Level 4

Performance Steps

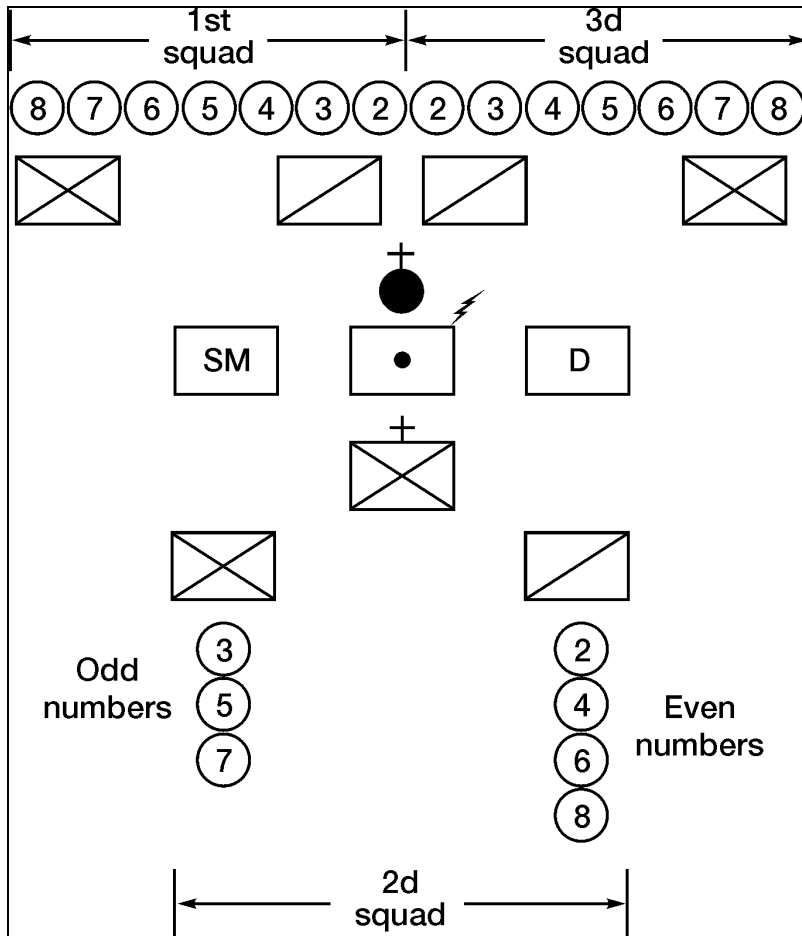

Figure 191-379-5400-2. Platoon Line with One Squad in General Support in a Column of Twos

- (1) Give the command, "Platoon as skirmishers, second support in a column of twos."
- (2) Ensure that the leaders of the first and third squads command, "Follow me," and that the leader of the second squad commands, "Stand fast."

Skill Level 4

**Performance Steps**

**(3)** Give the command; "Move," and point to the place where you want the formation. The first and third squads move forward to their appointed place (the number 2 member of the first squad is the base member for the formation). The second squad, at the command of its squad leader, executes a column of twos to the right.

**b.** Form the platoon in a platoon line with one squad in support in a single column (figure 191-379-5400-3). The support squad, usually the second squad, may also be formed in a single column. The command is, "Platoon as skirmishers, second in support, move." The first and third squads execute the formation, while the second squad remains in column formation.



3-344

191-379-5400

Skill Level 4





**Performance Steps**

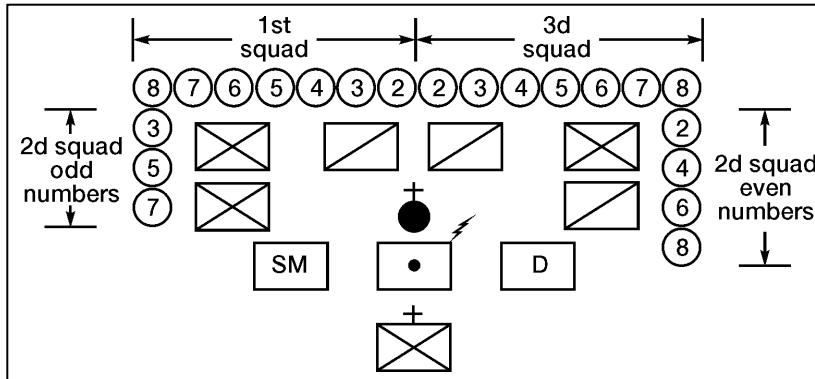

**Figure 191-379-5400-4. Platoon Line with One Squad in Lateral Support**

- a. Give the command, "Platoon as skirmishers, second squad in lateral support."
  - b. Give the command, "Move," and point to the place where you want the formation.
  - c. Ensure that after the first squad forms a line to the left of the base member, the third squad forms a line to the right of the base member. After the line has been formed, the squad leader for the second squad commands, "Odd numbered soldiers, follow me," and the assistant squad leader commands, "Even numbered soldiers, follow me." The odd numbered soldiers move out to the left and form a column behind the last soldier in the third squad. The even numbered soldiers move out to the right and form a column behind the last soldier in the first squad.
4. Form the platoon in a platoon line with one squad in close support (figure 191-379-5400-5).

Skill Level 4

Performance Steps

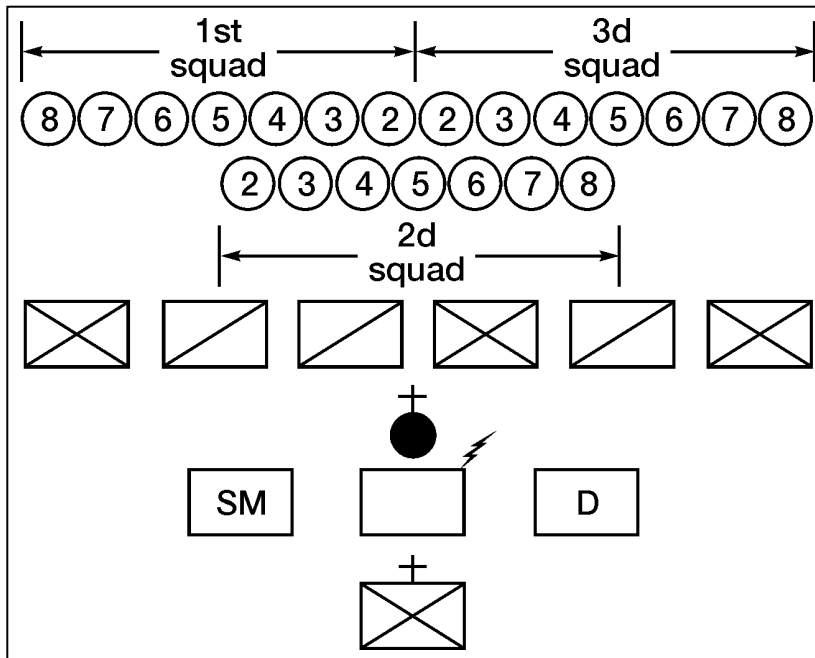

Figure 191-379-5400-5. Platoon Line with One Squad in Close Support

- a. Give the command, "Platoon as skirmishers, second in close support." The first and third squads will execute a line as in step 1.
  - b. Ensure that the leaders of the second squad command, "Stand fast."
  - c. Ensure that after the first and third squads move to the appointed place and execute the line, the second squad executes a similar line to the rear of the leading line. The second squad forms to the right of its base soldier. The second squad can be shifted to the right or left to support any segment of the formation.
- Note.** Make sure the second squad closes and covers the intervals between the elements in the leading line.
5. Form the platoon in a platoon echelon right (or left) (figure 191-379-5400-6).

Skill Level 4

Performance Steps

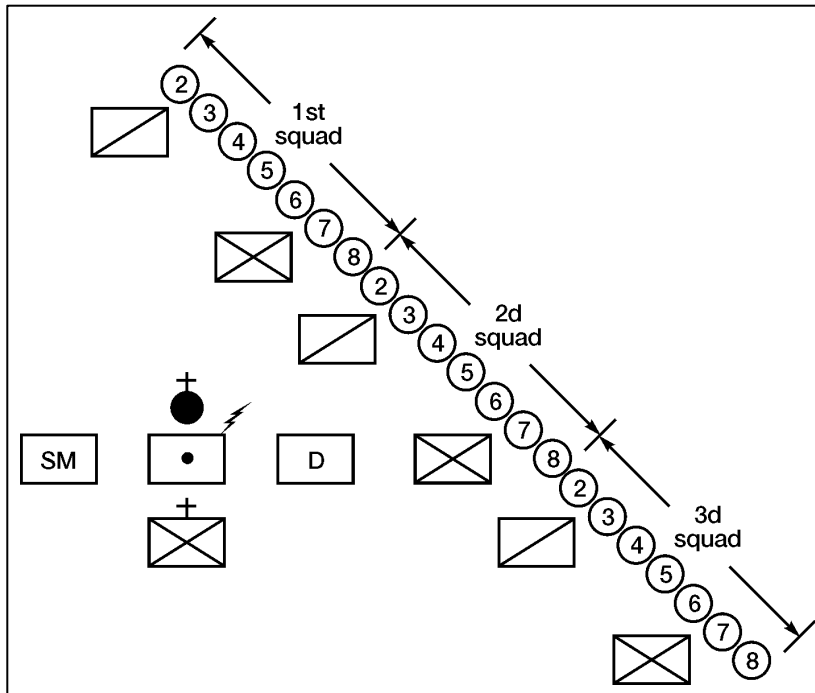

Figure 191-379-5400-6. Platoon Echelon, Right

- a. Give the command, "Platoon echelon, right (or left)."
- b. Give the command, "Move," and point to where you want the formation.
- c. Give hand signals with the voice commands. Extend one arm 45 degrees above and the other 45 degrees below the horizon, arms and hands extended. (When facing the platoon, the upper arm indicates the direction of the echelon.)
- d. Ensure that the first squad leader commands, "Follow me," and the squad executes an echelon right.
- e. Ensure that the second and third squad leaders command, "Stand fast."
- f. Ensure that as each squad clears the column, the next squad moves to extend the echelon formed by the preceding squad.

Skill Level 4

**Performance Steps**

**Note.** For an echelon left, the third squad executes echelon left with the rest of the squads following.

**6.** Form the platoon in a platoon echelon, right (or left) with one support squad in general support the same as with the line (figure 191-379-5400-7).

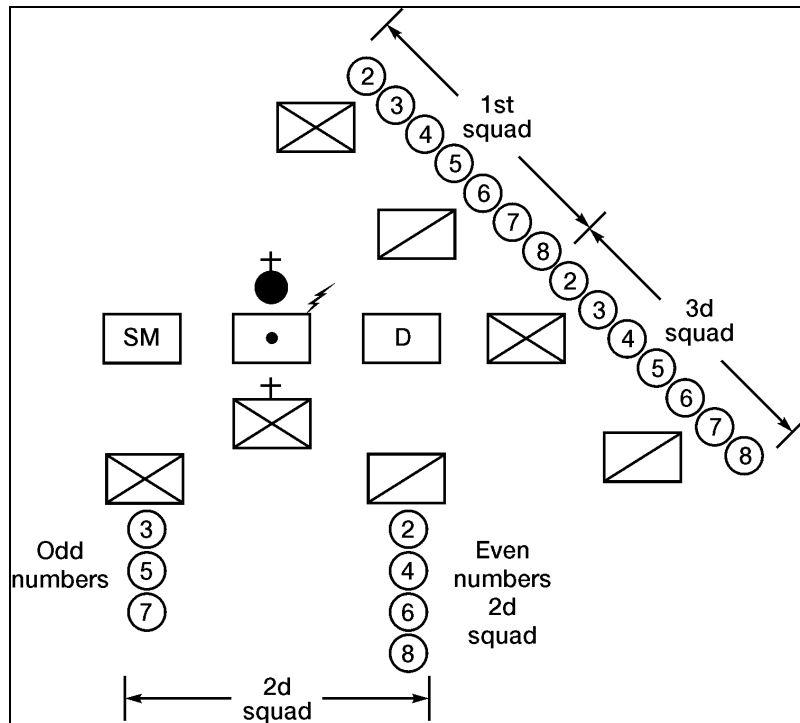

**Figure 191-379-5400-7. Platoon Echelon, Right with One Squad in General Support**

- a. Give the command, "Platoon echelon, right (or left), second squad in general support."
- b. Give the command, "Move," and point to the place where you want the formation.
- c. Give hand signals with the voice commands. Extend one arm 45 degrees above and the other 45 degrees below the horizon, arms and hands extended. (When facing the platoon, the upper arm indicates the direction of the echelon.)

**Skill Level 4**

**Performance Steps**

d. Ensure that the first squad leader commands, "Follow me," and that the squad executes an echelon right (or left).

e. Ensure that the second and third squad leaders command, "Stand fast."

f. Ensure that as the first squad clears the column, the third squad moves to extend the echelon formed by the first squad. The second squad, at the command of its squad leader, executes a column of twos to the right (or left).

7. Form the platoon in a platoon echelon, right (or left) with one support squad in lateral support the same as with the line (figure 191-379-5400-8).

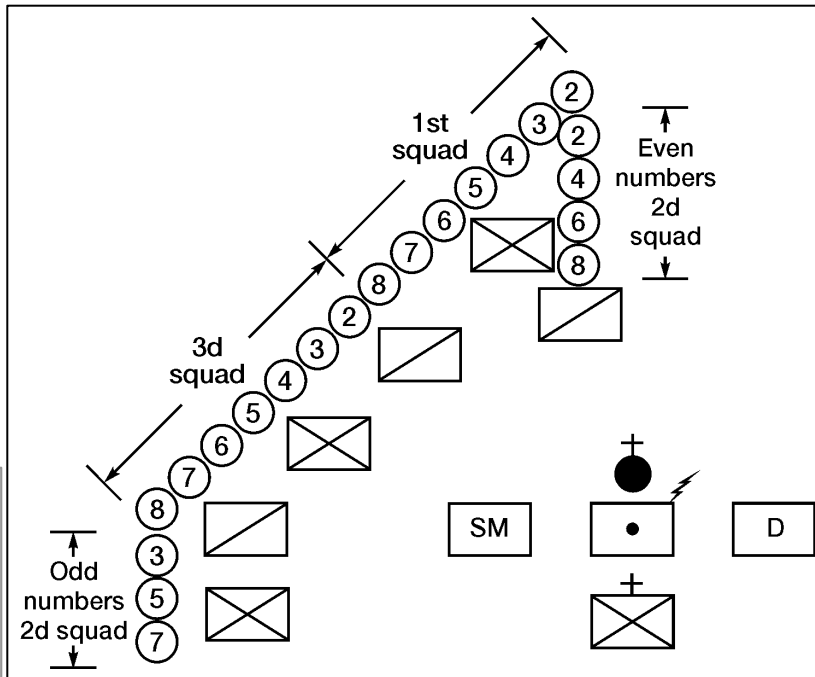

**Figure 191-379-5400-8. Platoon Echelon, Left with One Squad in Lateral Support**

a. Give the command, "Platoon echelon, right (or left), second squad in lateral support."

**Performance Steps**

**b.** Give the command, "Move," and point to the place where you want the formation.

**c.** Give hand signals with the voice commands. Extend one arm 45 degrees above and the other 45 degrees below the horizon, arms and hands extended. (When facing the platoon, the upper arm indicates the direction of the echelon.)

**d.** Ensure that the first squad leader commands, "Follow me," and that the squad executes an echelon right (or left).

**e.** Ensure that the second and third squad leaders command, "Stand fast."

**f.** Ensure that as the first squad clears the column, the third squad moves to extend the echelon formed by the first squad. After the echelon has formed, the squad leader for the second squad commands, "Odd numbered soldiers, follow me," and the assistant squad leader commands, "Even numbered soldiers, follow me." The odd numbered soldiers move out to the right (or left) and form a column behind the last soldier in the third squad. The even numbered soldiers move out to the left (or right) and form a column behind the first soldier in the first squad.

**8.** Form the platoon in a platoon echelon, right (or left) with one support squad in close support the same as with the line (figure 191-379-5400-9).



**Skill Level 4**

**191-379-5400**

**3-351**

**Performance Steps**

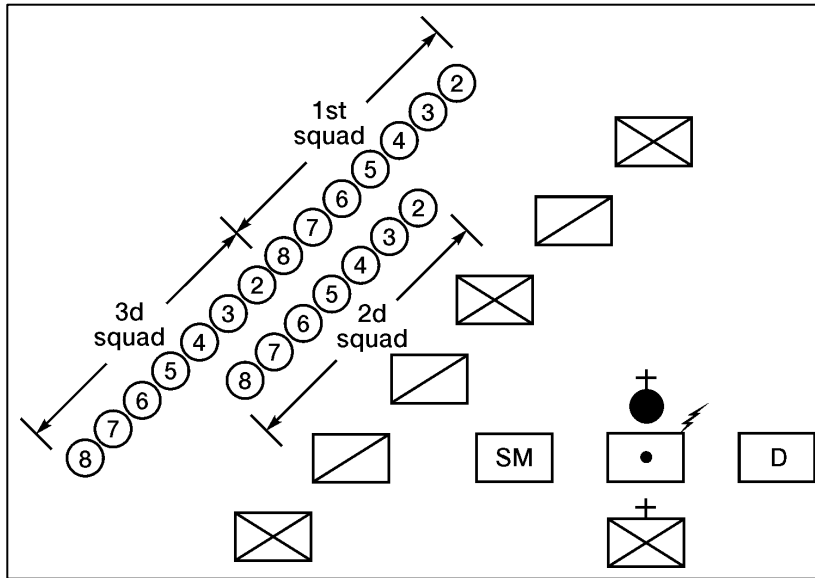

**Figure 191-379-5400-9. Platoon Echelon, Left with One Squad in Close Support**

- a. Give the command, "Platoon echelon, right (or left), second squad in close support."
- b. Give the command, "Move," and point to the place where you want the formation.
- c. Give hand signals with the voice commands. Extend one arm 45 degrees above and the other 45 degrees below the horizon, arms and hands extended. (When facing the platoon, the upper arm indicates the direction of the echelon.)
- d. Ensure that the first squad leader commands, "Follow me," and that the squad executes an echelon right (or left).
- e. Ensure that the second and third squad leaders command, "Stand fast."
- f. Ensure that as the first squad clears the column, the third squad moves to extend the echelon formed by the first squad. After the echelon has formed, the second squad executes a similar echelon to the rear of the leading echelon. The second squad will form to the right (or left) of its base soldier. The second squad can be shifted to the right or left to support any segment of the formation.

Skill Level 4



**Performance Steps**

9. Form the platoon in a platoon wedge (figure 191-379-5400-10).

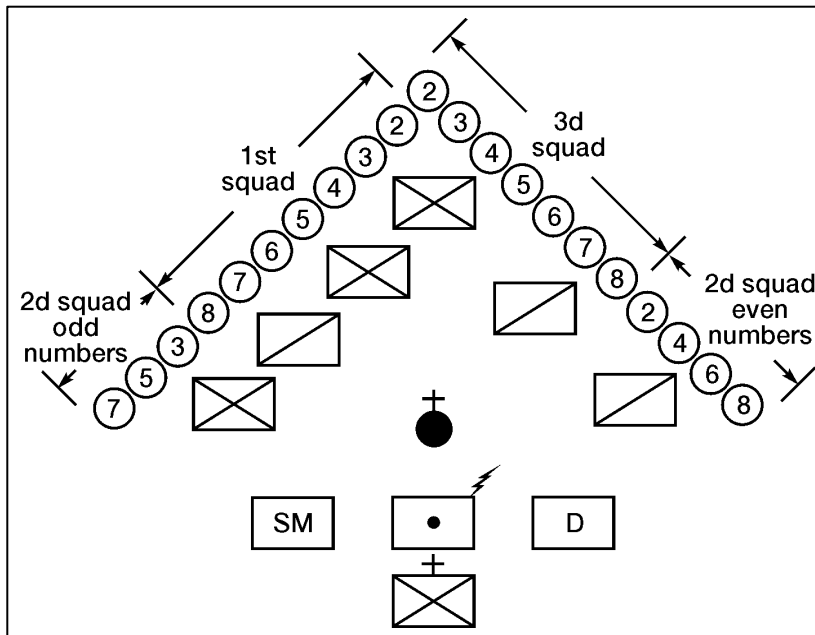

**Figure 191-379-5400-10. Platoon Wedge**

- Give the command, "Platoon wedge," followed by the command, "Move." Give hand signals with the commands. Extend both arms down to the sides at an angle of 45 degrees below the horizon, palms down and towards the body. Then point to where you want the formation as you give the command of execution.
- Ensure that the first and third squad leaders command, "Follow me," while the second squad leader commands, "Stand fast."
- Ensure that the first and third squads move to the front and, when the last element of the squads have cleared the front of the second squad, the second squad leader commands, "Follow me." The squad moves to the left and right respectively.
- Ensure that the third squad executes an echelon right off the number 2 member (the base member) and the first squad executes an echelon left.

**Skill Level 4**

**Performance Steps**

e. Ensure that the odd-numbered soldiers of the second squad form an echelon left on the rear element of the first squad and the even-numbered soldiers form an echelon right on the rear element of the third squad.

10. Form the platoon in a platoon wedge with one squad in general support in a column of twos (figure 191-379-5400-11).

---

Skill Level 4

3-354

191-379-5400

Skill Level 4

Performance Steps

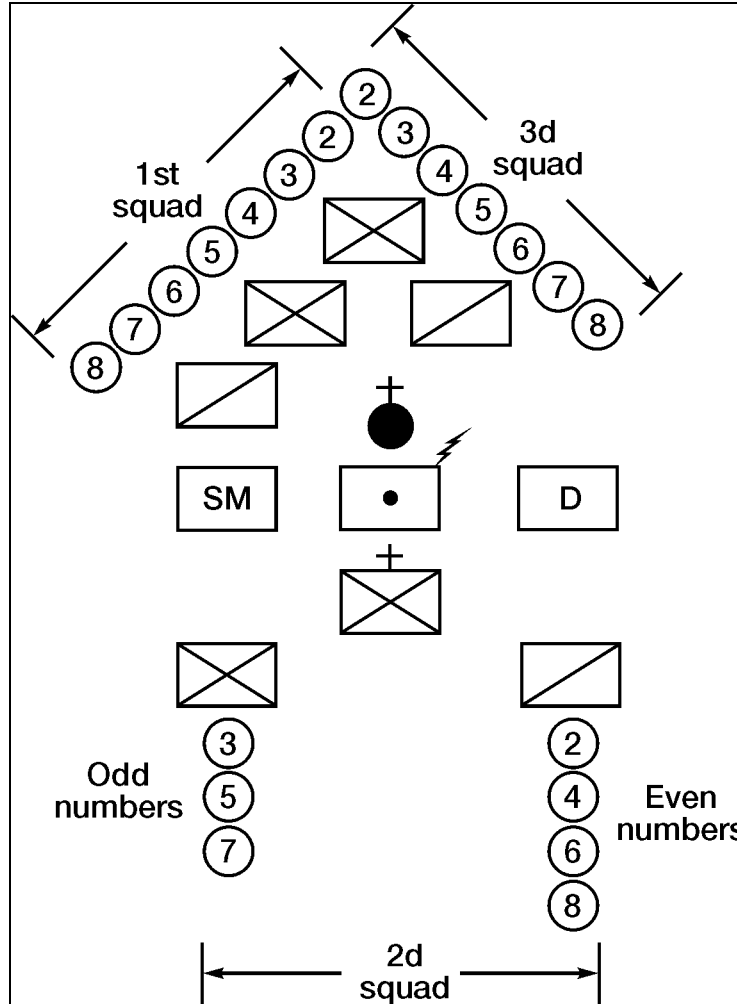

Figure 191-379-5400-11. Platoon Wedge with One Squad in General Support in a Column of Twos

a. Give the command, "Platoon wedge, second squad in support in a column of twos, move."

Skill Level 4

**Performance Steps**

**b.** Ensure that the first and third squads execute the wedge and the second squad, at the command of its squad leader, executes a column of twos to the right.

**Note.** The support squad, usually the second squad, may also be formed in a single column. The command for this would be, "Platoon wedge, second in support, move." The first and third squads execute the formation, while the second squad remains in column formation.

**11.** Form the platoon in a platoon wedge with one squad in lateral support (figure 191-379-5400-12).

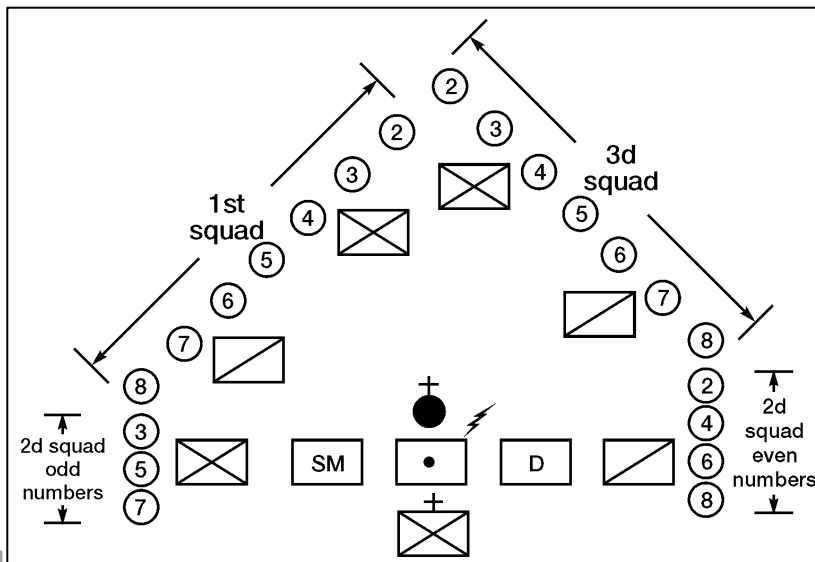

**Figure 191-379-5400-12. Platoon Wedge with One Squad in Lateral Support**

**a.** Give the command, "Platoon wedge, second squad in lateral support, move." The first and third squads execute the wedge, while the second squad stands fast.

**b.** Ensure that after the wedge has been formed, the squad leader for the second squad commands, "Odd-numbered soldiers, follow me," and the assistant squad leader commands, "Even-numbered soldiers, follow me." The odd-numbered soldiers move out to the left and form a column behind the last soldier in the third squad. The even-numbered soldiers move out to the right and form a column behind the last soldier in the first squad.

Skill Level 4

**Performance Steps**

c. Give the command, "Second squad, lateral support, move," to move the second squad from general support to lateral support.

d. Give the command, "Second squad, extend the wedge, move," to have the second squad join the wedge from either general support or lateral support. The second squad leader and the assistant squad leader command, "Follow me," and move out to the left and right, respectively, to extend the wedge on the first and third squads.

12. Form the platoon in a platoon wedge with one squad in close support (figure 191-379-5400-13).

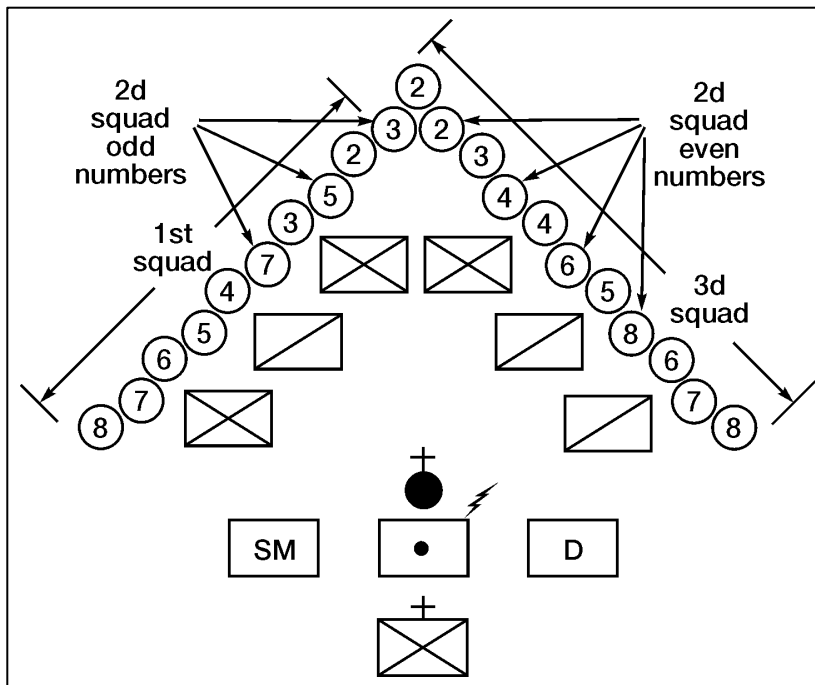

**Figure 191-379-5400-13. Platoon Wedge with One Squad in Close Support**

a. Give the command, "Platoon wedge, second squad in close support, move."

b. Ensure that the first and third squads execute a wedge. The second squad executes a squad wedge behind, and centered on, the leading wedge.

Skill Level 4

**Performance Steps**

c. Ensure that the members in the supporting wedge cover the intervals between members in the leading wedge.

**13. Reassemble the platoon from a formation.**

a. Move to the rear of the platoon where you want the platoon members to assemble and give the command, "Platoon assemble, move," while making a circular motion above your head with your right hand.

b. Ensure that the number two members (base member) of each squad do an about face and all other squad members do a facing movement toward their number two member.

c. Ensure that the platoon comes to port arms upon hearing the command, "Platoon assemble."

d. Ensure that upon the command, "Move," the second squad leader commands, "Follow me." The first and third squad leaders command, "Stand fast."

e. Ensure that as the second squad clears the formation, the first and third squad leaders command, "Follow me." The first and third squads follow, moving at double time, and dress to the right of the third squad until the platoon is fully formed.

Performance Measures	GO	NO GO
1. Formed the platoon in a platoon line.	—	—
2. Formed the platoon in a platoon line with one squad in general support.	—	—
3. Formed the platoon in a platoon line with one squad in lateral support.	—	—
4. Formed the platoon in a platoon line with one squad in close support.	—	—
5. Formed the platoon in a platoon echelon right (or left).	—	—
6. Formed the platoon in a platoon echelon right (or left) with one support squad in general support the same as with the line.	—	—
7. Formed the platoon in a platoon echelon right (or left) with one support squad in lateral support the same as with the line.	—	—
8. Formed the platoon in a platoon echelon right (or left) with one support squad in close support the same as with the line.	—	—

Skill Level 4

Performance Measures	GO	NO GO
9. Formed the platoon in a platoon wedge.	___	___
10. Formed the platoon in a platoon wedge with one squad in general support in a column of twos.	___	___
11. Formed the platoon in a platoon wedge with one squad in lateral support.	___	___
12. Formed the platoon in a platoon wedge with one squad in close support.	___	___
13. Reassembled the platoon from a formation.	___	___

**Evaluation Guidance:** Score the soldier GO if all performance measures are passed. Score the soldier NO GO if any performance measure is failed. If the soldier fails any performance measure, show him how to do it correctly.

**References**

**Required**  
FM 19-15

**Related**

**SUBJECT AREA 21: DEFENSE MEASURES**

**071-430-0006**

**Conduct a Defense by a Platoon**

**Conditions:** Given a specified area to defend, a platoon with table of organization and equipment (TOE) equipment, and a requirement to defend that area.

**Standards:** The threat was engaged in accordance with the defensive plan, fires were controlled, terrain was retained, and the threat was destroyed or repelled.

**Performance Steps**

1. Analyze the mission.
  - a. You are given a mission to defend by the company commander. It is either an operations order (OPORD) or a warning order.
  - b. Identify both specified tasks and implied tasks.
  - c. Make an estimate of the situation using the factors of mission, enemy, terrain, troops, and time available (METT-TC).
2. Issue a warning order to the squad leaders. The warning order should include the mission, time, place for issuing the OPORD, and any special instructions needed to start preparation for the mission.

Skill Level 4

---

### Performance Steps

---

3. Make a tentative plan.
  4. Conduct a reconnaissance.
    - a. As a minimum, make a map reconnaissance.
    - b. If at all possible, conduct a ground reconnaissance.
    - c. Evaluate the terrain based on how the available observation, fields of fire, cover and concealment, obstacles, key terrain, and avenues of approach best support your mission and the commander's intent.
    - d. Request that the squad leaders, radiotelephone operator, and forward observers accompany the platoon leader on the reconnaissance. You may need to take along some additional security depending on the tactical situation.
  5. Start necessary movement or preparations. The platoon sergeant should:
    - a. Initiate orders to prepare for any necessary movement and prepare for the defense as soon as the warning order is issued.
    - b. Request and draw ammunition rations, water, and any special equipment required.
    - c. Accomplish any needed maintenance.
    - d. Perform any movement required.
    - e. Accomplish this during the time you and your reconnaissance party are conducting the reconnaissance.
  6. Complete the plan.
    - a. The plan is completed or revised based on continuing analysis and completion of the reconnaissance.
    - b. As a minimum, the plan should provide for—
      - (1) The deployment of squads.
      - (2) The deployment of key weapons.
      - (3) The use of indirect fire.
      - (4) The use of mines and obstacles.
      - (5) The establishment of security measures.
      - (6) The selection and operation of command and observation posts.
  7. Occupy the position.
    - a. Establish local security. Locate observation posts to make maximum use of long-range observations.
- 

Skill Level 4



---

**Performance Steps**

---

- b.** Position key weapons. Ensure machine guns cover infantry avenues of approach, have primary and secondary sectors of fire, and provide as much grazing fire as possible, and are assigned either a final protective line (FPL) or a principal direction of fire. Ensure Javelins or Dragons cover armor avenues of approach, have primary and secondary sectors of fire, are positioned to engage targets from the flank, and are mutually supporting.
  - c.** Clear fields of fire. Ensure each fighting position clears its field of fire to engage the advancing enemy without exposing friendly positions. Range cards are prepared for each machine gun and Dragon.
  - d.** Ensure positions have overlapping sectors of fire.
  - e.** Improve fighting positions, as time is available. Improving overhead cover, aiming and limiting stakes, and camouflage are on-going activities.
  - f.** Select and improve alternate and supplementary positions. Improve them, as time is available.
- 8.** Emplace early warning devices. Platoon early warning system is used, if available. Trip flares are set out. Improvised early warning devices can be used, such as noisemakers, trip wire grenades, or other explosives.
- 9.** Emplace hasty minefields and other obstacles. These should be covered by observation and fire.
- 10.** Establish communication systems. Depend on radio as little as possible. Wire networks should be established down to each squad and up to the company command post (CP).
- 11.** Stockpile ammunition, water, food, and other supplies. Ensure that any materiel is protected from direct fire and is provided overhead protection.
- 12.** Engage the enemy at maximum range. When the enemy appears in the platoon sector, he is engaged with supporting direct and indirect fires. As he comes within the range of your organic weapons, you direct your gunners to start engaging the enemy.
- a.** When the enemy encounters your minefields and obstacles, use all friendly fires to break up the enemy formations.
  - b.** If the enemy is able to start an assault, repel or destroy him by calling for final protective fires (FPF) of small arms and machine guns, and FPF from mortars and artillery.
- 

Skill Level 4

**Evaluation Preparation:**

*Setup:* Select an area in the field large enough for a platoon defensive position, including primary, alternate, and supplementary positions.

*Brief Soldier:* Tell the soldier his platoon's sector of responsibility and that he is the acting platoon leader. Issue an OPORD (from the company commander) for a defense of the position.

Performance Measures	GO	NO GO
1. Analyzed the mission.	___	___
2. Issued a warning order.	___	___
3. Made a tentative plan.	___	___
4. Conducted a reconnaissance.	___	___
5. Caused necessary movement and preparation to be initiated.	___	___
6. Completed the plan and issued the order.	___	___
7. Occupied the position.	___	___
a. Established local security.		
b. Positioned key weapons.		
c. Ensured fields of fire were cleared.		
d. Ensured overlapping sectors of fire.		
e. Selected alternate and supplementary positions.		
8. Ensured early warning devices were installed.	___	___
9. Ensured hasty protective minefields and other obstacles were constructed.	___	___
10. Established communication systems, wire and radio.	___	___
11. Requested ammunition, food, water, and other supplies for stockpiling.	___	___
12. Engaged the enemy at maximum ranges.	___	___
a. Covered obstacles with fire.		
b. Called for FPL and FPF.		

Skill Level 4

**Evaluation Guidance:** Score the soldier GO if all performance measures are passed. Score the soldier NO GO if any performance measure is failed. If the soldier scores NO GO, show what was done wrong and how to do it correctly.

**References**

Required	Related
FM 3-21.71	
FM 7-7	
FM 7-8	
FM 3-90.1	

**SUBJECT AREA 22: UNIT OPERATIONS**

**091-CLT-3009**

**Supervise Maintenance Operations**

**Conditions:** In a field or garrison environment, given maintenance personnel, equipment, maintenance facility/site, SOPs, and applicable references.

**Standards:** Established and maintained an effective maintenance shop operation in accordance with SOPs and applicable references.

**Performance Steps**

1. Ensure unit maintenance procedures are in accordance with AR 750-1, DA Pam 750-35 and local major Army command (MACOM) policies.
  - a. Review unit standing operating procedures (SOP) for maintenance.
  - b. Inform unit personnel of changes in policy and new policy that impacts unit SOP.
2. Provide technical assistance to unit maintenance activities.
  - a. Inspect unit maintenance operations .
  - b. Identify shortcomings .
  - c. Make recommendations for corrective action.
  - d. Provide training in maintenance procedures.
3. Provide maintenance management to units.
  - a. Review reports (MCRS and ULLS-G).
  - b. Coordinate with higher level maintenance activities .
  - c. Direct cross-leveling of maintenance assets/workload.

Skill Level 4

**Performance Steps**

**d. Prioritize maintenance efforts of units.**

Performance Measures	GO	NO GO
1. Reviewed unit SOP as scheduled.	—	—
2. Compared unit SOP against standards set in DA Pam 750-35.	—	—
3. Completed regular inspection of unit operations.	—	—
4. Compared unit operations against standards in AR 750-1, DA Pam 738-750, and DA Pam 750-35.	—	—
5. Inspected environmental protection practices for compliance.	—	—
6. Reviewed safety program practices for compliance with AR 385-55.	—	—
7. Recorded and submitted deficiencies to proper personnel for correction.	—	—
8. Recorded training needs.	—	—
9. Coordinated with appropriate personnel to provide needed training.	—	—
10. Reviewed MCSR for accuracy and compliance with standards in AR 700-138 and applicable user's manual.	—	—
11. Coordinated with appropriate maintenance level to correct maintenance discrepancies.	—	—
12. Coordinated with TRADOC and AMC to ensure that emerging issues were addressed appropriately at the unit.	—	—

**Evaluation Guidance:** Score the soldier GO if all performance measures are passed. Score the soldier NO GO if any performance measure is failed. If the soldier fails any performance measure, show him what was done wrong and how to do it correctly.

**References**

**Required**  
 AR 190-51  
 AR 385-10  
 AR 385-40

**Related**

Skill Level 4

3-364

091-CLT-3009

Skill Level 4

**References**

**Required**

- AR 385-55
- AR 600-55
- AR 700-4
- AR 700-138
- AR 710-2
- AR 725-50
- AR 735-5
- AR 735-11-1
- AR 750-43
- DA Pam 25-30
- DA Pam 710-2-2
- DA Pam 738-750
- DA Pam 750-1
- DA Pam 750-35
- FM 4-30.3 (FM 9-43-1)

**Related**

---

**101-92Y-0001**

**Supervise Supply Activities**

**Conditions:** You are assigned to an organization with the duty to supervise a supply activity in a field or garrison environment. Given the various types of supply functions, you have full access to all supply reports, references, equipment and logistical automated systems. A logistician specializing in the supply field will be present to assist you.

**Standards:** Attained and maintained 100 percent accountability of all supplies, equipment, and supply records assigned to your activity. Ensured all organizational supply needs were met in the correct quantities, at the appropriate place and time.

---

**Performance Steps**

1. Verify supply activity operations are in accordance with the governing regulations.
  - a. Review the appropriate regulations governing the specific supply functions being performed.
    - (1) Determine which regulations and forms are essential to perform specific supply functions.



---

**Skill Level 4**

**101-92Y-0001**

**3-365**

---

**Performance Steps**

---

(2) Review all policy letters, commander guidance, and standing operating procedures (SOP) pertaining to the activity operations.

(3) Make a list of critical supply functions and areas of concentration that can jeopardize the mission.

b. Evaluate the performance of the supply activity operations.

(1) Review the historic reports and documents generated from the activity.

(2) Identify areas where the supply functions are substandard operations.

(3) Meet with key personnel and set up internal controls to correct substandard procedures.

(4) Design internal SOPs based on the governing regulations, and indoctrinate the commander's guidance.

2. Identify the areas of responsibility and accountability.

a. Establish the chain of command.

(1) Identify the key personnel in your supply activity.

(2) Identify the responsibilities of your position.

(3) Identify the responsibilities of your subordinates.

(4) Identify property and equipment for which you are responsible.

b. Establish property and equipment accountability.

(1) Conduct a 100-percent physical inventory of all supplies and equipment for which you are responsible.

(2) Report all identified shortages and overages through command supply channels.

(3) Ensure appropriate methods of relief are applied.

(4) Ensure that all property and equipment is properly distributed (sub-hand receipt) down to the user level.

(5) Update and maintain your hand receipt/sub-hand receipt as necessary.

c. Establish an active physical security program for the areas for which you are responsible.

(1) Arms room and sensitive item.

(2) Supply room and OCIE.

(3) Storage area.

(4) NBC.

d. Steward resources.

Skill Level 4

---

**Performance Steps**

---

- (1) Review expendable requisitions.
  - (2) Review the GSA/SSSC requisitions.
3. Develop the supply activity portion of the unit SOP.
  - a. Collect pertinent data concerning the administrative and technical procedures of your activity.
  - b. Incorporate the following areas into your SOP:
    - (1) Commander's training guidance.
    - (2) Reporting procedures/situation reporting procedures (SITREP).
    - (3) Chain of Command.
    - (4) Environmental hazards.
    - (5) Safety program.
    - (6) Physical security program.
  - c. Develop a detailed plan on how you will implement the following:
    - (1) Command supply discipline program (CSDP).
    - (2) Internal control system.
    - (3) Cyclic inventories.
  - d. Enforce safety standards and regulations.
    - (1) Appoint safety officer to coordinate with the unit safety officer, write the safety portion of the activity SOP, and ensure the administration of the unit safety program.
    - (2) Verify that the safety SOP is publicized and posted in your activity area.
    - (3) Verify soldiers are trained on and practice the safety standards.
  - e. Conduct risk management.
    - (1) Ensure supply activity members adhere to all safety and occupational health standards applicable to routine operations.
    - (2) Incorporate risk management techniques into all activity operations.
      - (a) Identify hazard.
      - (b) Assess risk.
      - (c) Determine controls.
      - (d) Make decisions.
      - (e) Supervise and evaluate.
4. Supervise supply activity operations.
  - a. Determine required reports.
    - (1) Determine what reoccurring reports your activity must generate.

Skill Level 4

---

**Performance Steps**

---

(2) Determine what automated/status reports are required of you and at what frequency.

(3) Determine what input to the unit status reporting is required from your activity.

(4) Determine the interval required to conduct inventories .

b. Randomly review supply documents leaving your activity for correctness and completeness.

(1) UND codes on requisitions.

(2) Document register for discrepancies.

(3) Turn-in documents.

(4) Training ammunition requests.

(5) Reconciliation validation reports.

(6) Cancellation requests.

(7) Receipt documents.

c. Consult with the supply subject matter experts at regular intervals.

(1) Obtain information on how the functional areas supply operations are conducted.

(2) Disseminate information and identify areas of concern that need to be elevated to the next higher level.

(3) Follow up as necessary to assure improved productivity.

(4) Keep your commander informed about the productivity of the activity.

---

**Evaluation Preparation:**

*Setup:* This task can be evaluated during routine unit operations.

*Brief Soldier:* Inform soldier that the evaluation is measured on the ability to perform the listed performance measures.

Performance Measures	GO	NO GO
1. Used the proper procedures to access the DA Pam 25-30 CD ROM to identify blank forms and needed publications, and gather most recent information on available publications .	—	—
2. Checked property book accounting (manual and automated) in accordance with DA Pam 710-2-1 chapter 4, section I.	—	—

Skill Level 4

3-368

101-92Y-0001

Skill Level 4



Performance Measures	GO	NO GO
3. Checked for accuracy and completion of hand receipts, sub-hand receipts, hand-receipt annexes and component listings in accordance with AR 710-2 and DA Pam 710-2-1, chapters 5, 6, and 9.	—	—
4. Coordinated issuing, storing and turn in of supplies and equipment in accordance with DA Pam 710-2-1, chapters 3 and 5.	—	—
5. Coordinated requisitioning and receipt of supplies and logistical services in accordance with DA Pam 710-2-1, chapter 2.	—	—
6. Verified that all 10-percent, quarterly, semi-annual, and annual inventories were performed in accordance with DA Pam 710-2-1, chapter 9.	—	—
7. Verified that corrective actions were taken to rectify discrepancies in accordance with AR 735-5, chapters 12 and 13, and DA Pam 710-2-1, chapter 9, section II, and chapter 4.	—	—
8. Determined if equipment was reportable in accordance with DA Pam 738-750.	—	—
9. Coordinated the processing of required supply operations reports in accordance with DA Pam 710-2, chapters 2 and 3.	—	—
10. Conducted random checks of supply documents leaving your activity in accordance with AR 710-2, appendix B, and AR 735-5, chapter 11.	—	—

**Evaluation Guidance:** Score the soldier GO if all performance measures are passed. Score the soldier NO GO if any performance measure is failed. If the soldier scores NO GO on any performance measure, show him what was done wrong and how to do it correctly.

#### References

Required	Related
AR 700-84	AR 190-11
AR 710-2	AR 190-13
AR 735-5	AR 220-1
DA Pam 25-30	AR 30-22
DA Pam 710-2-1	AR 385-10
DA Pam 710-2-2	AR 725-50



---

## References

### Required

DA Pam 738-750

### Related

DA Pam 385-1

FM 100-15

FM 10-1

FM 10-27-3

FM 10-15

FM 10-23

FM 10-23-1

FM 10-27-4

---

## 151-357-0001

### Supervise CSS Functions During Platoon Operations

**Conditions:** You are a platoon leader/sergeant of a platoon operating in a field environment with the responsibility of supervising CSS operations relating to your platoon.

**Standards:** Ensured the proper accountability of personnel, the control of the platoon health procedures, the verification of financial readiness, the control of supply accountability and LOGPAC procedures, and the control of the platoon's movement. Task was performed in accordance with current doctrine and unit SOP.

---

### Performance Steps

1. Account for personnel.
  - a. Verify status report.
  - b. Review DA Form 1155 and DA Form 1156, *Casualty Feeder Report*.
2. Control the platoon's health procedures.
  - a. Verify evacuation procedures.
  - b. Identify major components of the medical threat.
  - c. Identify preventive medicine measures to prevent the threat.
  - d. Identify requirement and responsibility for the FST.
  - e. Identify combat lifesaver.
3. Verify platoon's financial readiness.
4. Control platoon's classes of supplies.
  - a. Identify resource requirement.
  - b. Control accountability.

Skill Level 4

3-370

151-357-0001

Skill Level 4

---

**Performance Steps**

---

5. Direct platoon's LOGPAC operation.
    - a. Ensure that the proper log report was submitted to the company.
    - b. Verify the commander's intent for resupply operations .
  6. Control the platoon movement plan.
    - a. Prepare platoon movement plan.
    - b. Verify route surveillance.
    - c. Ensure that vehicles are fully fueled.
    - d. Check for operational readiness of vehicles .
- 

Performance Measures	GO	NO GO
1. Obtained squad personnel status report and completed DA Form 1155 and DA Form 1156 from the squad leaders.	—	—
2. Processed and consolidated the information provided by squad leaders to prepare a platoon strength report.	—	—
3. Recorded situation reports (SITREPS) and other personnel information.	—	—
4. Updated the battle roster.	—	—
5. Forwarded the platoon strength and completed DA Form 1155 and DA Form 1156 to the company command post.	—	—
6. Verified that personnel were aware how to—	—	—
a. Collect all information needed for the MEDEVAC request.		
b. Record MEDEVAC information using authorized brevity codes.		
c. Contact the medical unit that controls evacuation.		
d. State the purpose of the message in clear text.		
e. Transmit the MEDEVAC request information.		
7. Supervised the movement of the casualty.	—	—
8. Verified that there was a combat lifesaver in your platoon.	—	—

**Skill Level 4**

<b>Performance Measures</b>	<b>GO</b>	<b>NO GO</b>
<b>9.</b> Coordinated with medical personnel to ensure platoon had properly trained personnel.	—	—
<b>10.</b> Supervised the actions of the combat lifesaver.	—	—
<b>11.</b> Verified platoon basic pay and entitlements.	—	—
<b>12.</b> Verified accuracy of platoon LES.	—	—
<b>13.</b> Conducted predelayment review of platoon financial readiness.	—	—
<b>14.</b> Inspected availability and accuracy of unit SOP. Included storage requirements, methods, facilities, and responsibility.	—	—
<b>15.</b> Inspected location, storage method, material conditions, and general appearance of storage areas.	—	—
<b>a.</b> For weapons and sensitive items, included accountability, environmental control, physical security and access considerations.		
<b>b.</b> For ammunition and explosives, included accountability, environmental control, physical security and access considerations.		
<b>c.</b> For petroleum, oils , and lubricants and flammable liquids, same as above.		
<b>16.</b> Verified accuracy of logistics report submitted to the company.	—	—
<b>17.</b> Ensured the platoon rotated for supplies, mail, rations, and refilled or exchanged water cans.	—	—
<b>18.</b> Verified the rearming and refueling of the platoon.	—	—
<b>19.</b> Ensured all platoon wounded in action (WIA), killed in action (KIA), and enemy prisoners of war (EPW) were present at the resupply point for transport to the rear.	—	—
<b>20.</b> Verified KIA were separated from WIA and EPWs.	—	—
<b>21.</b> Verified vehicles needing unit level or higher maintenance stopped in maintenance holding area.	—	—
<b>22.</b> Ensured a precombat inspection was done after resupply operation was complete.	—	—

Skill Level 4

Performance Measures	GO	NO GO
23. Coordinated with company on movement orders.	___	___
24. Verified route.	___	___
25. Conducted pre-combat inspection on assigned vehicles and equipment.	___	___

**Evaluation Guidance:** Score the soldier GO if all performance measures are passed. Score the soldier NO GO if any performance measure is failed. If the soldier scores NO GO, show him what was done wrong and how to do it correctly.

**References**

**Required**

- FM 8-10-6
- FM 10-27-4
- FM 21-10
- FM 55-30
- FM 100-10
- TC 21-7

**Related**

---

**151-357-0002**

**Coordinate Combat Service Support (CSS) Operations**

**Conditions:** You are assigned the position of support operations NCO and are responsible for supervising CSS operations in a Force XXI and AOE organization.

**Standards:** Prioritized support requirements, identified logistical capabilities (including medical), determined logistical planning considerations, and listed the roles and responsibilities of assigned personnel. These duties were performed in accordance with established directives, current doctrine, and local SOP and applied to Force XXI and AOE.

**Performance Steps**

1. Become familiar with CSS missions and organization in AOE and Force XXI units.
  - a. Identify functional responsibilities of CSS staff.
  - b. List basic elements for CSS support planning.
  - c. Recognize the primary support capabilities of a DISCOM corps support group.



---

**Performance Steps**

---

2. Describe the responsibilities of the support operations NCO in managing all classes of supplies.
    - a. Identify external support requirements.
    - b. Assess internal support assets required to accomplish customer support.
    - c. Prioritize support based on commander's guidance (SOP, policies, customer needs, and supporting units capabilities).
    - d. Provide input for external support SOP.
    - e. Plan future support operations.
    - f. Manage internal support mission.
    - g. Conduct logistics planning.
    - h. Plan all supply, maintenance, and supply service operations.
  3. Discern CSS structure for Force XXI and AOE division, corps, and theater levels.
    - a. Sequence the supply flow from depot to foxhole.
    - b. List responsibilities of personnel.
    - c. Apply support operations.
- 

Performance Measures	GO	NO GO
1. Listed staff session capabilities, mission, and responsibilities.	—	—
a. Verified support capabilities of internal staff.		
b. Verified support capabilities on next higher echelon.		
c. Coordinated efforts based on known functions and capabilities.		
d. Evaluated sustainment capabilities of support operations procedures.		
e. Reviewed the accuracy of unit SOP.		
2. Ensured that staff employed the sustainment imperatives of anticipation, integration, continuity, responsiveness, and improvisation.	—	—
a. Anticipated placement of Classes I, II, III, IIIIP, IV, V, VI, VIII, IX, water, and other support.		
b. Ensured METT-TC were always considered.		

Skill Level 4

<b>Performance Measures</b>	<b>GO</b>	<b>NO GO</b>
<b>c.</b> Verified that operations were supported at every stage of planning and execution.		
<b>d.</b> Tailored configured load based on priority, customer, and mission responsiveness to changing tactical situations.		
<b>e.</b> Participated in internal and external exercises designed to measure responsiveness to changing tactical situations.		
<b>f.</b> Identified staff counterpart at DISCOM or corps support group support operations section.		
<b>g.</b> Prepared required reports for submission to support operations officer and higher headquarters.		
<b>h.</b> Identified internal support requirements to all battalion staff sections .		
<b>i.</b> Tracked command-directed critical supplies and equipment.		
<b>3.</b> Reviewed logistics reports from subordinate units.	—	—
<b>a.</b> Prepared consolidated report for support operations staff.		
<b>b.</b> Updated critical equipment list.		
<b>c.</b> Verified the accuracy of logistics reports.		
<b>d.</b> Maintained customer density lists.		
<b>e.</b> Maintained asset visibility.		
<b>4.</b> Verified support requirements for Classes I, II, III, IIIIP, IV, V, VI, VII, VIII, and IX.	—	—
<b>a.</b> Identified current location of storage and support facilities.		
<b>b.</b> Obtained projected location of storage and support facilities.		
<b>c.</b> Maintained visibility of all stockage levels.		
<b>d.</b> Assisted in conducting authorized stockage list (ASL) review board.		
<b>e.</b> Served as subject matter expert (SME) and evaluator of subordinate unit inspections or assistance visits.		
<b>f.</b> Coordinated field service support.		

**Skill Level 4**

Performance Measures	GO	NO GO
<b>5. Coordinated movement requirements .</b>	___	___
<b>a.</b> Selected most appropriate model based on commander's priorities .		
<b>b.</b> Provided (based on METT-TC) input in creating multifunctional modular support packages for deployment operations .		
<b>c.</b> Assessed internal lift capabilities.		
<b>d.</b> Requested external support assets.		
<b>e.</b> Conducted terrain analysis.		
<b>6. Coordinated with appropriate medical support units.</b>	___	___
<b>a.</b> Identified appropriate POCs.		
<b>b.</b> Assisted in coordinating medical support for battalion.		

**Evaluation Guidance:** Score the soldier GO if all performance measures are passed. Score the soldier NO GO if any performance measure is failed. If the soldier scores NO GO, show him what was done wrong and how to do it correctly.

**References**

Required	Related
DA Pam 710-2-2	
FM 63-2	
FM 63-2-1	
FM 63-20	
FM 63-20-1	
FM 63-21	
FM 63-21-1	
FM 63-23-2	
FM 100-10	

---

**159-200-2020**  
**Integrate Threat Capabilities into Mission Planning.**

**Conditions:** You are assigned to a battalion staff in the operations (S3) or intelligence (S2) section. Your battalion is tasked to plan and conduct a field operation based on a brigade operations order. You have access to the

3-376

159-200-2020

Skill Level 4

Skill Level 4



brigade operations order, the brigade intelligence estimate, and the battalion commander's initial guidance. You have access to tactical C4I systems.

**Standards:** Correctly identified global threats to the United States and its forces. Correctly identified threat capabilities for the specific tactical and operational situation. Integrated threat capabilities into all courses of action (COA) analysis and mission planning.

---

**Performance Steps**

---

1. Identify global threats.
    - a. Identify global trends.
    - b. Characterize the global threat environment.
    - c. Recognize competitors to U.S. interests.
    - d. Recognize asymmetrical threat methods and actions.
  2. Determine threat capabilities.
    - a. Evaluate Intelligence estimate from higher headquarters .
    - b. Recognize available database sources of threat information.
    - c. Access Interlink or Interlink-S sources of regional information.
    - d. Access MIDB.
    - e. Access unclassified Internet (www) sources of regional information.
  3. Apply threat capabilities to COA analysis and mission planning.
    - a. Wargame most likely threat COA against friendly plans and incorporate into mission plans .
    - b. Wargame most dangerous threat COA against friendly plans and incorporate into mission plans.
    - c. Identify potential vulnerabilities to friendly plans and incorporate into mission plans.
- 

**Evaluation Preparation:**

*Setup:* Provide the sddier with the materials listed in the conditions statement and a copy of the performance measures. The performance of this task could be evaluated during a training exercise.

*Brief Soldier:* Tell soldier that he will be evaluated on correctly passing all the performance measures.

Performance Measures	GO	NO GO
1. Identified four major global trends and their effect on the operational environment.	—	—
2. Described the global threat environment. Described how it is different from that of the Cold War era.	—	—



Performance Measures	GO	NO GO
3. Described asymmetrical methods. Explained the difference between asymmetrical and conventional military methods.	—	—
4. Located the intelligence estimate within an operations order.	—	—
5. Derived applicable information from higher headquarters intelligence estimate.	—	—
6. Identified four available databases containing threat information.	—	—
7. Retrieved regional and threat-specific information from Interlink or Interlink-S.	—	—
8. Retrieved regional and threat-specific information from unclassified Internet sources.	—	—
9. Identified the most likely threat COA and the most dangerous threat COA.	—	—
10. Identified at least one potential vulnerability in the friendly plan.	—	—
11. Incorporated threat findings in all mission planning.	—	—

**Evaluation Guidance:** Score the soldier GO if all performance measures are passed. Score the soldier NO GO if any performance measure is failed. If the soldier scores NO GO, show the soldier what was done wrong and how to do it correctly.

**References**

**Required**

**Related**

FM 34-130

---

**181-101-4001**  
**Conduct a Search/Seizure**

**Conditions:** You are a soldier in the U.S. Army. As a soldier, you are responsible for identifying and understanding protections of the 4th Amendment of the U.S. Constitution against unreasonable searches and seizures and its application in the U.S. Army. You must also identify and understand who is permitted to authorize a search; the search's legal basis, purpose, and scope; and permissible exceptions to the 4th Amendment. Additionally, you must identify and understand the differences between an inspection and a search.

3-378

181-101-4001

Skill Level 4

Skill Level 4

**Standards:** Identified and understood the protections of the 4th Amendment of the U.S. Constitution against unreasonable searches and seizures and its application in the U.S. Army. Identified and understood who was permitted to authorize a search; the search's legal basis, purpose, and scope; and permissible exceptions to the 4th Amendment. Identified and understood the differences between an inspection and a search.

---

**Performance Steps**

---

1. List the authority for search and seizure.
  - a. Describe the 4th Amendment to the U.S. Constitution's protection against unreasonable searches and seizures.
  - b. Describe the 4th Amendment to the U.S. Constitution's applicability to U.S. Army soldiers.
  - c. Describe the necessity for the 4th Amendment to the U.S. Constitution to apply differently to soldiers and civilians.
  - d. Describe the 4th Amendment to the U.S. Constitution's requirement that a search or seizure be based on probable cause and a "warrant" or "authorization" in the armed forces.
2. Identify the requirements for conducting a search or seizure.
  - a. Describe the requirement for the commander to first determine whether probable cause exists and define what constitutes probable cause to search.
  - b. Describe the totality of the circumstances test used to evaluate whether probable cause exists.
3. Describe which person(s) have the authority to authorize a search.
  - a. Describe where this authority is derived.
  - b. Describe whether this authority can be further delegated.
  - c. Describe why it might be preferable to have a military magistrate or military judge authorize a search instead of the commander.
  - d. Describe the requirement for a commander to have authority over the place to be searched in order to authorize a search of that place.
  - e. Describe whether a commander has authority to authorize a search of a soldier's off-post quarters or personal property in the continental United States (CONUS).
4. Describe the procedures required to obtain an authorization to search.
5. Describe the scope of an authorized search.
6. Describe the requirement for the commander to be neutral and detached.
7. Describe exceptions to the 4th Amendment.
  - a. Describe various types of searches that are exceptions to the 4th

Skill Level 4

---

**Performance Steps**

---

Amendment.

(1) Describe the necessity for the suspect to have a reasonable expectation of privacy in the area searched.

(2) Describe the 4th Amendment's application to the search of Government property.

(3) Describe the 4th Amendment's application to items in "open view."

b. Describe a consent search.

(1) Describe whether command authorization is required with a consent search.

(2) Describe whether probable cause is required with a consent search.

(3) Describe the requirement for the consent to be voluntary or freely given.

(4) Describe the applicability of the totality of the circumstances test to a consent search.

(5) Describe how the consent may be partial or limited and the restrictions this places on the search.

(6) Describe withdrawal of consent and its effect on continuation of the search.

c. Describe search incident to apprehension.

(1) Describe the legitimate reasons for such a search.

(2) Describe the scope or parameters of such a search.

d. Describe search under exigent circumstances.

(1) Define what constitutes exigent circumstances.

(2) Describe the legitimate reasons for conducting a search under exigent circumstances.

(3) Describe whether a search authorization is required for search under exigent circumstances.

e. Describe the requirement and importance of maintaining a proper chain of custody.

8. Describe inspection procedures.

a. Define inspection.

b. Describe the primary purpose test of inspection.

c. Describe the scope of inspection.

d. Describe whether the 4th Amendment restricts a commander's authority to order an administrative inspection.

---

Skill Level 4

3-380

181-101-4001

Skill Level 4

---

**Performance Steps**

---

- e. Describe the relationship between a "search" and an "inspection."
- f. Describe the subterfuge rule regarding an "inspection."
- g. Describe health and welfare Inspection.
  - (1) Describe the primary purpose and scope of health and welfare inspection.
  - (2) Describe whether the use of drug detection dogs during health and welfare inspection is permissible.
- h. Describe the permissibility of a commander conducting an inspection or "lock-down" for lost weapons or ammunition.
- i. Describe the permissibility of a gate inspection.
- j. Describe the admissibility of evidence at trial obtained through an illegal search or inspection.
- k. Describe the authority of a commander to conduct an inventory of a soldier's property.
  - (1) List the circumstances under which an inventory is required.
  - (2) Describe whether contraband discovered during inventory may be seized and used as evidence in a criminal prosecution.

---

**Evaluation Preparation:**

*Setup:* Evaluate this task at the end of military justice training on conducting searches and seizures.

*Brief Soldier:* Tell the soldier that he will be evaluated on his ability to identify and understand protections of the 4th Amendment of the U.S. Constitution against unreasonable searches and seizures and its application in the U.S. Army. Tell the soldier that he will also be evaluated on his ability to identify and understand who is permitted to authorize a search; the search's legal basis, purpose, and scope; and permissible exceptions to the 4th Amendment. Tell the soldier that he will also be evaluated on his ability to identify and understand the differences between an inspection and a search.

Performance Measures	GO	NO GO
1. Listed the authority for search and seizure.	___	___
a. Described the 4th Amendment's protection against unreasonable searches and seizures .		
b. Described the 4th Amendment's applicability to U.S. Army soldiers.		
c. Described the necessity for the 4th Amendment to apply differently to soldiers and civilians.		

Skill Level 4

Performance Measures	GO	NO GO
d. Described the 4th Amendment requirement that a search or seizure be based on probable cause and a "warrant" or "authorization" in the armed forces.		
2. Identified the requirements for conducting a search or seizure.	—	—
a. Described the requirement for the commander to first determine whether probable cause existed and defined what constitutes probable cause to search.		
b. Described the totality of the circumstances test used to evaluate whether probable cause existed.		
3. Described which person(s) have the authority to authorize a search.		
a. Described where this authority is derived.	—	—
b. Described whether this authority can be further delegated.		
c. Described why it might be preferable to have a military magistrate or military judge authorize a search instead of the commander.		
d. Described the requirement for a commander to have authority over the place to be searched in order to authorize a search of that place.		
e. Described whether a commander has authority to authorize a search of a soldier's off-post quarters or personal property in the continental United States (CONUS).		
4. Described the procedures required to obtain an authorization to search.	—	—
5. Described the scope of an authorized search.	—	—
6. Described the requirement for the commander to be neutral and detached.	—	—
7. Described exceptions to the 4th Amendment.	—	—
a. Described various types of searches that are exceptions to the 4th Amendment.		
(1) Described the necessity for the suspect to have a reasonable expectation of privacy in the area searched.		

Skill Level 4

Performance Measures	GO	NO GO
(2) Described the 4th Amendment application to the search of Government property.		
(3) Described the 4th Amendment application to items in "open view."		
<b>b.</b> Described a consent search.		
(1) Described whether command authorization is required with a consent search.		
(2) Described whether probable cause is required with a consent search.		
(3) Described the requirement for the consent to be voluntary or freely given.		
(4) Described the applicability of the totality of the circumstances test to a consent search.		
(5) Described how the consent may be partial or limited and the restrictions this places on the search.		
(6) Described withdrawal of consent and its effect on continuation of the search.		
<b>c.</b> Described search incident to apprehension.		
(1) Described the legitimate reasons for such a search.		
(2) Described the scope or parameters of such a search.		
<b>d.</b> Described search under exigent circumstances.		
(1) Defined what constitutes exigent circumstances.		
(2) Described the legitimate reasons for conducting search under exigent circumstances.		
(3) Described whether a search authorization is required for a search under exigent circumstances.		
<b>e.</b> Described the requirement and importance of maintaining a proper chain of custody.		
<b>8.</b> Described inspection procedures.	—	—
<b>a.</b> Defined inspection.		
<b>b.</b> Described the primary purpose test of inspection.		
<b>c.</b> Described the scope of inspection.		

Skill Level 4

Performance Measures	GO	NO GO
d. Described whether the 4th Amendment restricts a commander's authority to order an administrative inspection.		
e. Described the relationship between a "search" and an "inspection."		
f. Described the subterfuge rule regarding inspection.		
g. Described health and welfare inspection.		
(1) Described the primary purpose and scope of a health and welfare inspection.		
(2) Described whether the use of drug detection dogs during a health and welfare inspection is permissible.		
h. Described the permissibility of a commander conducting an inspection or "lock-down" for lost weapons or ammunition.		
i. Described the permissibility of a gate inspection.		
j. Described the admissibility of evidence at trial obtained through an illegal search or inspection.		
k. Described the authority of a commander to conduct an inventory of a soldier's property.		
(1) Listed the circumstances under which an inventory is required.		
(2) Described whether contraband discovered during an Inventory may be seized and used as evidence in a criminal prosecution.		

**Evaluation Guidance:** Score the soldier GO if all performance measures are passed. Score the soldier NO GO if any performance measure is failed. If the soldier scores NO GO, show him what was done wrong and how to do it correctly.

### 551-721-4326

#### Perform Duties as Convoy Commander

**Conditions:** You are required to perform duties as a convoy commander. Given an alert notification of a convoy move, AR 55-162, a specified number of vehicles, personnel, convoy commander's briefing, and the task to command a convoy.

Skill Level 4

3-384

551-721-4326

Skill Level 4



**Standards:** Ensured that personnel were briefed on convoy operations; there were ample vehicles and personnel to transport cargo; all support elements were informed of the date and time of the convoy; all orders were brief and to the point; proper reconnaissance was carried out; and vehicles were correctly lined up according to cargo, size, and use.

---

**Performance Steps**

---

1. Start initial planning steps.
  - a. Alert unit operation.
  - b. Review operation order.
    - (1) Determine the number of vehicles needed.
    - (2) Break columns down into manageable groups of 20 vehicles or less.
      - (3) Determine requirements needed for given situation.
      - (4) Divide march column in three parts: head, main body, and trail.
        - (a) Head—the first task vehicle or pacesetter.
        - (b) Main Body—troop carrying, equipment and/or supply vehicles.
          - (c) Trail—wrecker, maintenance and medical support vehicles/teams. Trail officer/noncommissioned officer is responsible for maintenance and medical support.
  2. Schedule convoy commander's briefing with the battalion operations officer (S3).
    - a. Determine which unit will provide security.
    - b. Find out who will be the security elements commander.
    - c. Discuss any topic not covered or not clear.
    - d. Discuss the threat to include target acquisition and intelligence that may impact on convoy success.
  3. Commander's briefing.
    - a. Take notes.
    - b. Update maps, if appropriate.
  4. Prepare convoy commander's checklist. Items supervisors and drivers need to be briefed—
    - (a) Rules of the road.
    - (b) Traffic laws or regulations.
    - (c) Speed limits.
    - (d) Time and distance gaps.
    - (e) Routing plans.

Skill Level 4

---

**Performance Steps**

---

- (f) Schedules.
- (g) March discipline.
- 5. Map reconnaissance.
  - a. Select tentative check points or confirm already established checkpoints.
  - b. Contact those units whose combat areas they will be passing through, and find out about trouble areas and ambush sites.
- 6. Ground reconnaissance.
  - a. Select sites for scheduled halts, mess, and refueling that will safely accommodate convoy personnel and equipment.
  - b. Select release point.
  - c. Identify problem areas along the route.
  - d. Select a bypass or alternate route.
- 7. Review the reconnaissance map and make a final selection.
- 8. Give a copy of the map marked with all convoy information to the battalion S3.
  - a. Request convoy clearance from the battalion S3.
  - b. Request copy of movement graphs from the battalion S3.
- 9. Coordinate to obtain artillery support with the artillery unit.
  - a. Use information from the security officer or obtained by route reconnaissance to plan fire support.
  - b. Determine the type of ammunition to be fired under various conditions.
  - c. Determine the number of rounds to be fired at given targets.
  - d. Determine the types of targets that warrant fire missions.
- 10. Mark on the map the range limitations of each artillery unit.
- 11. Plan/coordinate with the escort and security elements (military police units) for convoy security.
  - a. Maintain noise and light discipline.
  - b. Maintain front, flank, and rear security.
  - c. Conduct security measures during halts.
  - d. Request air cover (as required).
  - e. Request fire support (as required).
  - f. Maintain convoy communication.
- 12. Direct the placement of guides and signs along the convoy route.

Skill Level 4

---

**Performance Steps**

---

a. The authority in charge of movement has responsibility for placing guides and signs.

b. Guides and signs can be used to direct the convoy.

13. Brief/issue work assignments to subordinate elements.

14. Direct the operation section to prepare strip maps and/or overlays (as required).

15. Prepare for vehicle movement.

a. Perform vehicle preventive maintenance checks and services (PMCS).

(1) Perform before operation PMCS using the appropriate -10 level manual.

(2) Check for and have items repaired, filled, or adjusted as needed.

b. Mark vehicles for the convoy move.

(1) Place a "Convoy Follows" sign on the first task vehicle, below the windshield in a conspicuous location.

(2) Place a "Convoy Ahead" sign on the rear of the last task vehicle.

(3) Identify the lead vehicle with a 12- by 18-inch blue flag on the left (driver's) side.

(4) Identify the convoy commander and the serial commander with a 12- by 18-inch black and white (divided diagonally) flag on the left (driver's) side.

(5) Identify the last vehicle with a 12- by 18-inch green flag on the left (driver's) side.

(6) Identify vehicles with a convoy identification number.

(7) Ensure that all vehicles are marked in accordance with AR 55-162.

c. Establish convoy communications.

(1) Radio is the best means of communication during convoy.

(2) Remember radio signals can be intercepted.

d. Load cargo and equipment onto vehicles/trailers or semitrailers (as required).

e. Assemble inspection area.

(1) Ensure the area is large enough to accommodate vehicles.

(2) Ensure that the maintenance team in the assembly area inspects vehicles.

Skill Level 4

---

**Performance Steps**

---

(3) Ensure that all personnel and equipment are inspected in the assembly area.

16. Prepare the convoy briefing on the following—
  - a. Rules of the road.
  - b. Traffic laws or regulations.
  - c. Speed limits.
  - d. Time and distance gaps.
  - e. Routing plans.
  - f. Schedules.
  - g. March discipline.
17. Hand out strip maps and brief convoy personnel.
18. Give signal/order to start engines.
19. Give signal/order to move out.
20. Maintain organizational control by—
  - a. Monitoring communication.
  - b. Maintaining communication with subordinate element commanders.
  - c. Making on-the-spot corrections.
  - d. Informing subordinate element commanders of control infractions and ordering them to take corrective actions.
21. Direct at-halt activities, monitor activities in progress, and make on-the-spot corrections.
22. Give signal/order to reform and start engines.
23. Give signal/order to move out.
24. Direct the off-loading of cargo/equipment at the release point, as required.
25. Inform higher headquarters of the convoy status.
26. Inform fire support unit(s) of the convoy status.
27. Evaluate task performance, noting personnel—
  - a. To be acknowledged for outstanding work performance.
  - b. To be acknowledged for substandard work performance and/or scheduled for training.
28. Prepare convoy command's report and give a copy to higher headquarters.

Skill Level 4

---

**Evaluation Preparation:**

---

3-388

551-721-4326

Skill Level 4

*Setup:* Evaluate this task during a field training exercise or normal training session. Provide the soldier with the items listed in the conditions statement.

*Brief Soldier:* Tell the soldier he will be evaluated on his ability to properly perform duties as a convoy commander.

Performance Measures	GO	NO GO
1. Started initial planning steps.	___	___
a. Alerted unit operation.		
b. Reviewed operation order.		
2. Scheduled convoy commander's briefing with the battalion S3 officer.	___	___
3. Attended convoy commander's briefing, took notes, and updated maps.	___	___
4. Prepared convoy commander's checklist.	___	___
5. Conducted a map reconnaissance to select and mark routes/sites not dictated by higher headquarters.	___	___
6. Conducted a ground reconnaissance if time permitted and noted on the map clearances of overhead structures/obstacles; load classifications; speed limits; and rest, mess, and refueling sites that would safely accommodate convoy personnel and equipment.	___	___
7. Reviewed reconnaissance map and made final selection of primary and alternate routes, and rest, mess, and refueling areas.	___	___
8. Gave a copy of the map with all convoy information marked on it to the battalion S3 and requested a clearance if not already initiated. Also requested that the move be plotted and a copy of the movement graph be issued.	___	___
9. Coordinated to obtain artillery support with artillery unit.	___	___
10. Marked on the map the range limitations of each artillery unit.	___	___
11. Planned/coordinated with the escort and security elements (military police units), security fire support, air support, and convoy communications needs.	___	___
12. Directed the placement of guides and signs along the convoy route.	___	___

Skill Level 4

Performance Measures	GO	NO GO
13. Issued work assignments to subordinate element commanders and briefed them on performance standards required.	—	—
14. Directed the operation section to prepare strip maps and/or overlays (as required).	—	—
15. Prepared for vehicle movement.	—	—
a. Performed vehicle PMCS.		
b. Marked vehicles for convoy move.		
(1) Placed "Convoy Follows" sign on the first task vehicle, below the windshield in a conspicuous location.		
(2) Placed "Convoy Ahead" on the rear of the last task vehicle.		
(3) Identified the lead vehicle with a 12- by 18- inch blue flag on the left (driver's) side.		
(4) Identified convoy commander and serial commander with a 12- by 18-inch black and white (divided diagonally) flag on the left (driver's) side.		
(5) Identified the last vehicle with a 12- by 18- inch green flag on the left (driver's) side.		
(6) Identified vehicles with convoy identification number.		
(7) Ensured that all vehicles were marked in accordance with AR 65-162.		
c. Established convoy communications.		
d. Loaded cargo and equipment onto vehicles/ trailers or semitrailers (as required).		
e. Assembled inspection area.		
(1) Ensured that the maintenance team in the assembly area inspected vehicles .		
(2) Ensured that all personnel and equipment were inspected in the assembly area.		
16. Prepared the convoy briefing.	—	—
17. Handed out strip maps and briefed convoy personnel on the situation, mission, execution, administration and logistics, and safety.	—	—

Skill Level 4

3-390

551-721-4326

Skill Level 4

Performance Measures	GO	NO GO
18. Gave signal/order to start engines.	___	___
19. Gave signal/order to move out.	___	___
20. Maintained organizational control by—	___	___
a. Monitoring communication.		
b. Maintaining communication with subordinate element commanders.		
c. Making on-the-spot corrections.		
d. Informing subordinate commanders of control infractions and ordering them to take corrective actions.		
21. Directed at-halt activities, monitored activities in progress, and made on-the-spot corrections.	___	___
22. Gave signal/order to reform and start engines.	___	___
23. Gave signal/order to move out.	___	___
24. Directed the off-loading of cargo/equipment at release point, as required.	___	___
25. Informed higher headquarters of the convoy status.	___	___
26. Informed fire support unit(s) of the convoy status.	___	___
27. Evaluated task performance, noting personnel—	___	___
a. To be acknowledged for outstanding work performance.		
b. To be acknowledged for substandard work performance and/or scheduled for training.		
28. Prepared convoy commander's report and gave a copy to higher headquarters.	___	___

**Evaluation Guidance:** Score the soldier GO if all performance measures are passed. Score the soldier NO GO if any performance measure is failed. If the soldier fails, show him what was done wrong and how to do it correctly.

Skill Level 4

SUBJECT AREA 23: SECURITY AND CONTROL

**191-379-4408**

**Plan Security for a Command Post (CP)**

**Conditions:** You are a military police (MP) platoon sergeant and your platoon has been given a mission to provide security for a CP. You will have orders; information on the size and layout of the CP (massed or dispersed); information on mission, enemy, terrain, troops, time available, and civilian considerations (METT-TC); and access to the provost marshal (PM) and headquarters personnel.

**Standards:** Developed a security plan that included all required elements to detect the enemy and to defend the CP before the enemy could move within direct-fire range.

**Performance Steps**

1. Determine the number of personnel available to conduct CP security to include augmented personnel (for example, corps assets and the division band). Consider METT-TC and the CP size and layout.

**Note.** For dispersed CPs, MP security is concentrated toward providing early warning through screening operations. For massed CPs, the type of MP security provided depends on the presence or absence of augmentation. Only when a CP is massed can the MP provide close-in security through augmentation from corps assets.

2. Identify personnel to secure critical facilities within the CP.

**Note.** Critical facilities within the CP requiring security and controlled access include the tactical operations center, the war room, the communications center, the facilities for special intelligence, and the commander's quarters.

3. Conduct reconnaissance of the routes to the CP and areas around it.

4. Plan the best method and/or mix of forces for security, varying between massed and dispersed CPs, to include static posts, traffic control posts (TCPs), listening posts (LPs), observation posts (OPs), access control, mobile patrols, and quick-response forces (both organic and augmenting).

5. Determine the number of personnel required to provide close-in security for the commander within the area of operations.

6. Determine the amount of Class IX barrier materials needed.

7. Request the barrier materials through the appropriate channels.

8. Obtain an access list (of personnel authorized in the CP) from the PM or headquarters personnel.

Skill Level 4



---

**Performance Steps**

---

9. Prepare plans for the internal security of the CP. Coordinate directly with the existing security forces, access control personnel, Headquarters personnel, and the PM, as appropriate.
  10. Plan for security of tactical CPs when established and when in transit.
  11. Prepare a standing operating procedure (SOP) and/or special orders detailing duties, responsibilities, and procedures to be used to provide security to the CP.
  12. Brief all soldiers included in the CP security on the tactical situation and the defensive plans.
- 

**Evaluation Preparation:**

*Setup:* This task may be evaluated in the field or in a classroom environment. Provide the soldier with information on the size and layout of the CP (massed or dispersed), a map of the area, and METT-TC. The evaluator will act as PM and headquarters personnel and answer any questions the soldier may have for which information has not been provided.

Performance Measures	GO	NO GO
1. Determined the number of personnel available to conduct CP security to include augmented personnel.	—	—
2. Identified personnel to secure critical facilities within the CP.	—	—
3. Conducted reconnaissance of the routes to the CP and areas around it.	—	—
4. Planned the best method and/or mix of forces for security varying between massed and dispersed CPs to include static posts, TCPs, LPs, OPs, access control, mobile patrols, and quick-response forces (both organic and augmenting).	—	—
5. Determined the number of personnel required to provide close-in security for the commander within the area of operations.	—	—
6. Determined the amount of Class IX barrier materials needed.	—	—
7. Requested the barrier materials through the appropriate channels.	—	—
8. Obtained an access list (of personnel authorized in the CP) from the PM or headquarters personnel.	—	—

**Skill Level 4**

Performance Measures	GO	NO GO
9. Prepared plans for the internal security of the CP. Coordinated directly with the existing security forces, access control personnel, headquarters personnel, and the PM, as appropriate.	—	—
10. Planned for security of tactical CPs when established and when in transit.	—	—
11. Prepared an SOP and/or special orders detailing duties, responsibilities, and procedures to be used to provide security to the CP.	—	—
12. Briefed all soldiers included in the CP security on the tactical situation and the defensive plans.	—	—

**Evaluation Guidance:** Score the soldier GO if all performance measures are passed. Score the soldier NO GO if any performance measure is failed. If the soldier fails any performance measure, show him how to do it correctly.

**References**

**Required**  
FM 3-19.4

**Related**

**SUBJECT AREA 26: CRIME PREVENTION**

**191-379-4425**

**Implement the Unit's Crime Prevention Program**

**Conditions:** You are given the unit crime prevention standing operating procedures (SOP), the results of the last organizational inspection program (OIP), a copy of the installation's crime prevention program, and FM 3-19.30.

**Standards:** Implemented the unit crime prevention program in accordance with the unit SOP and the installation crime prevention program.

**Performance Steps**

1. Review the unit crime prevention SOP and the installation's crime prevention program to identify unique unit/installation needs and requirements.
2. Review the results of the unit's last OIP for deficiencies identified during the last inspection.
3. Conduct crime prevention surveys in accordance with the unit crime prevention SOP.

Skill Level 4

3-394

191-379-4425

Skill Level 4

---

**Performance Steps**

---

4. Ensure that unit equipment is marked in accordance with Army regulations and command guidance.  
**Note.** Equipment markings vary greatly depending on the type of equipment assigned to the unit. Check unit SOPs, technical manuals, and/or Army regulations to determine the correct procedures for marking unit equipment.
  5. Brief unit soldiers on "Operation ID" to include the following:
    - a. Methods of identifying personal property.
    - b. Recording personal property
    - c. Identification numbering.
    - d. Standard Army numbering system.
  6. Attend the battalion or brigade crime prevention working groups as required by the SOP and/or the installation crime prevention program.
  7. Conduct crime prevention briefings to unit personnel as required by the unit SOP and/or the installation crime prevention program.
- 

Performance Measures	GO	NO GO
1. Reviewed the unit crime prevention SOP and the installation crime prevention program to identify unique unit/installation needs and requirements.	—	—
2. Reviewed the results of the unit's last OIP for deficiencies identified during the last inspection.	—	—
3. Conducted crime prevention surveys in accordance with the unit crime prevention SOP.	—	—
4. Ensured that unit equipment was marked in accordance with Army regulations and command guidance.	—	—
5. Briefed unit soldiers on "Operation ID."	—	—
6. Attended the battalion or brigade crime prevention working groups as required by the SOP and/or the installation crime prevention program.	—	—
7. Conducted crime prevention briefings to unit personnel as required by the unit SOP and/or the installation crime prevention program.	—	—

Skill Level 4

**References**

**Required**

FM 3-19.30

**Related**

**SUBJECT AREA 27: RISK MANAGEMENT**

**850-001-4001**

**Integrate Risk Management into Mission Plans**

**Conditions:** You are a small unit leader. Given a mission or task, in a garrison or tactical environment, access to FM 100-14, and a risk management worksheet.

**Standards:** Completed all sections of the risk management worksheet.

**Performance Steps**

1. Conduct a risk assessment.
  - a. Identify the hazards associated with the mission or task.
  - b. Assess the hazards to determine their impact on the mission or task.
2. Develop controls.
  - a. Develop one or more controls that will eliminate the hazard or reduce the risk.
  - b. Determine the residual risk for each hazard and the overall residual risk for the mission or task.
  - c. Decide who is authorized to accept the risk.
3. Identify ways to implement the controls
  - a. Decide how controls will be put into effect.
  - b. Coordinate and communicate control measures up and down the chain-of-command.
4. Identify how to supervise and evaluate the controls.
  - a. Determine how each control will be monitored.
  - b. Evaluate the effectiveness of each control.

**Evaluation Preparation:**

*Setup:* To evaluate this task you need an assigned mission or task that may be in the form of an operations order (OPORD), fragmentary order (FRAGO), warning order, patrol order, training task, and so forth. The soldier will apply the risk management process to the assigned mission task.

*Brief Soldier:* Tell the soldier you are going to evaluate him on his ability to apply the risk management process.

Skill Level 4

3-396

850-001-4001

Skill Level 4

Performance Measures	GO	NO GO
1. Identified all the hazards associated with the mission or task (a minimum of one, depending on the mission or task).	—	—
2. Determined the level of risk (E, H, M, L) for each hazard.	—	—
3. Developed at least one control for each hazard.	—	—
4. Determined the residual risk for each hazard.	—	—
5. Determined how controls will be implemented.	—	—
6. Determined the overall residual risk for the mission or task.	—	—

**Evaluation Guidance:** Score the soldier GO if all performance measures are passed. Score the soldier NO GO if any performance measure is failed. If the soldier scores NO GO, show him what was done wrong and how to do it correctly.

**References**

**Required**

FM 100-14

**Related**

FM 101-5

**SUBJECT AREA 28: ADMINISTRATION/MANAGEMENT**

**805C-PAD-4359**

**Manage Soldier's Deployment Requirements**

**Conditions:** Given a requirement to prepare a section for deployment, access to FM 3-0, FM 55-65, FM 100-17, and AR 600-8-104, standard office supplies, equipment, assigned personnel, and transportation and local directives.

**Standards:** Performed initial deployment activities to include verification of section/platoon roster, recall/alert roster, individual SRP packets and load plan.

**Performance Steps**

1. Perform initial deployment activities.
  - a. Review soldier readiness processing (SRP) packets to identify deployable and non-deployable soldiers.
  - b. Review sections recall procedures.

Skill Level 4

Skill Level 4

805C-PAD-4359

3-397

---

**Performance Steps**

---

c. Identify any special items of clothing or equipment the section needs, based on climate, location, or local SOP.

d. Keep soldiers informed:

- (1) Determine mission.
- (2) Determine unit movement plans.
- (3) Determine requirements for advance party personnel.
- (4) Determine individual/unit equipment layout.
- (5) Determine security guidance to include OPSEC and subversion and espionage directed against the Army (SAEDA).

e. Determine equipment status.

- (1) Ensure equipment and vehicle requirements based on the AOC, such as camouflaging.
- (2) Ensure requirements to retrieve equipment and maintenance.
- (3) Ensure requirement to retrieve loaned equipment.

f. Determine records requirements.

- (1) Ensure records needed to operate effectively and efficiently at the new location accompany the unit.
- (2) Determine local requirement.

g. Determine procedures for station property.

- (1) Ensure all TOE equipment is accounted for properly with the appropriate property book officers.
- (2) Prepare a hand receipt or annex for station property.
- (3) Turn in excess POL and PLL.
- (4) Turn in or transfer fixed facilities to a non-deploying unit.
- (5) Cancel outstanding requisitions or give a ship-to address to the servicing supply support activity (SSA).

2. Prepare equipment for deployment:

a. Maintain current equipment inventory.

b. Maintain current load plans. Ensure that these plans are based on real-world contingencies and include both programmed and immediate considerations.

- (1) Ensure load plans include current MTOE equipment.
- (2) Adjust load plans as MTOE equipment changes.
- (3) Adjust load plans for the type of transportation to be utilized.
- (4) Adjust load plans for mission requirements and location

Skill Level 4

---

**Performance Steps**

---

considerations.

- (5) Maintain current visual equipment loading layout.
  - c. Perform regular and preventive maintenance checks and services (PMCS).
  - d. Obtain packing/loading materials.
  - e. Load equipment, supplies, and personnel for movement.
- 

**Evaluation Preparation:**

*Setup:* This task can be performed in an administrative environment. Soldiers should be informed to bring the section/platoon personnel roster, recall/alert roster, SRP packets, and load plan. At the test site verify that these files and documents have been properly prepared and are accurate and current.

*Brief Soldier:* Inform the soldier that he is being evaluated on his ability to manage soldier deployment requirements.

Performance Measures	GO	NO GO
1. Performed initial deployment activities:	___	___
a. Reviewed soldier readiness processing (SRP) packets to identify deployable and non-deployable soldiers.		
b. Reviewed and tested section recall procedures.		
c. Identified special items of clothing or equipment the section needs, based on climate, location, or local SOP.		
d. Kept soldiers informed:		
(1) Determined mission.		
(2) Determined unit movement plans.		
(3) Determined requirements for advance party, personnel.		
(4) Determined individual/unit equipment layout.		
(5) Determined security guidance to include OPSEC and subversion and espionage directed against the Army (SAEDA).		
e. Determined equipment status.		
(1) Ensured equipment and vehicle requirements based on the AOC, such as camouflaging.		

Skill Level 4

Performance Measures	GO	NO GO
(2) Ensured requirements to retrieve equipment and maintenance.		
(3) Ensured requirement to retrieve loaned equipment.		
f. Determined record requirements.		
(1) Ensured records needed to operate effectively and efficiently at the new location accompanied the unit.		
(2) Determined local requirement.		
g. Determined procedures for station property.		
(1) Ensured all TOE equipment was accounted for properly with the appropriate property book officers.		
(2) Prepared a hand receipt or annex for station property.		
(3) Turned in excess POL and PLL.		
(4) Turned in or transferred fixed facilities to a non-deploying unit.		
(5) Counseled outstanding requisitions or gave a ship-to address to the servicing supply support activity (SSA).		
2. Prepared equipment for deployment:	—	—
a. Maintained current equipment inventory.		
b. Maintained current load plans. Ensured these plans were based on real word contingencies and included both programmed and immediate considerations.		
(1) Ensured load plans included current MTOE equipment.		
(2) Adjusted load plans as MTOE equipment changed.		
(3) Adjusted load plans for the type of transportation to be utilized.		
(4) Adjusted load plans for mission requirements and location considerations.		
(5) Maintained current visual equipment loading layout.		

Skill Level 4



Performance Measures	GO	NO GO
c. Performed regular and preventive maintenance checks and services (PMCS)		
d. Obtained packing/loading material.		
e. Loaded equipment, supplies, and personnel for movement.		

**Evaluation Guidance:** Score the soldier GO on performance measures passed. Score the soldier NO GO on any performance measure failed. The soldier must score a GO on all performance measures specified in the evaluation preparation to receive a GO on the task. If the soldier scores NO GO, show the soldier what was wrong.

#### References

##### Required

AR 600-8-104  
FM 4-01.011  
FM 100-17

##### Related

FM 3-0

## 805C-PAD-4550

### Prepare a Standing Operating Procedure (SOP)

**Conditions:** Given a requirement to prepare an SOP to standardize routine or recurring actions or functions, appropriate operational references or local policy guidance, access to AR 25-50 and AR 380-5, computer with authorized software, and office supplies.

**Standards:** SOP identified purpose, distribution, and references, and was in proper format. SOP had proper security classification marks applied (if applicable) and was properly authenticated.

#### Performance Steps

1. Determine purpose.
  - a. Determine requirement for action/function.
  - b. Analyze intended outcome.
2. Determine audience/distribution.
  - a. Identify level of application.
  - b. Identify units, section, and personnel involved.
3. Determine references for content.
4. Select content for SOP.
5. Prepare SOP.

Skill Level 4

Skill Level 4

805C-PAD-4550

3-401

---

**Performance Steps**

---

6. Determine security classification requirements.
  7. Apply the proper security classification marking.
  8. Determine coordination requirement for approval.
  9. Coordinate SOP.
  10. Use proper format for the SOP.
  11. Distribute SOP for coordination.
  12. Review coordination comments.
  13. Prepare final.
    - a. Incorporate the coordination comments.
    - b. Coordinate final review.
  14. Obtain authentication.
  15. Determine reproduction requirements.
  16. Distribute SOP as required by local procedures.
- 

**Evaluation Preparation:**

*Setup:* To evaluate this task, gather the items listed in the conditions statement. Give the soldier a scenario that would provide all information necessary to perform the performance measures to include topic references. Have computer and printer or pencil and paper for soldiers to prepare SOP.

Performance Measures	GO	NO GO
1. Determined purpose.	___	___
a. Determined requirement for action/function.		
b. Analyzed intended outcome.		
2. Determined the audience/distribution.	___	___
a. Identified level of application.		
b. Identified units, section, and personnel involved.		
3. Determined references for content.	___	___
4. Selected content for SOP.	___	___
5. Prepared the SOP.	___	___
6. Determined security classification marking.	___	___
7. Applied the proper security classification marking.	___	___

Skill Level 4

Performance Measures	GO	NO GO
8. Determined coordination requirement for approval.	___	___
9. Coordinated SOP.	___	___
10. Used the proper format for the SOP.	___	___
11. Distributed SOP for coordination.	___	___
12. Reviewed coordination comments.	___	___
13. Prepared final.	___	___
a. Incorporated the coordination comments.		
b. Coordinated final review.		
14. Obtained authentication.	___	___
15. Determined reproduction requirement.	___	___
16. Distributed SOP as required by local procedures.	___	___

**Evaluation Guidance:** Score the soldier GO on performance measures passed. Score the soldier NO GO on any performance measures failed. The soldier must score a GO on 80 percent of the performance measures to receive a GO on the task. If the soldier scores NO GO, show him what was done wrong and how to do it correctly.

#### References

##### Required

AR 25-50

AR 380-5

FM 101-5

Software-Office

Software-Windows

##### Related

### 805C-PAD-4597

#### Integrate Newly Assigned Soldiers

**Conditions:** Given a section/platoon, newly assigned soldiers, and local policy.

**Standards:** Established personnel accountability. Provided soldiers with health and welfare items, initial area orientations, and special orders (if

Skill Level 4

Skill Level 4

805C-PAD-4597

3-403

required.) Verified soldier qualification, assigned soldiers to duty positions, informed commander, and conducted initial counseling.

---

**Performance Steps**

---

1. Receive new soldiers .
    - a. Establish accountability.
    - b. Provide health and welfare items.
    - c. Provide initial required area orientations and special orders .
  2. Verify soldiers' qualifications and equipment.
  3. Determine duty assignments .
    - a. Notify commander.
    - b. Notify soldiers .
  4. Provide initial counseling.
  5. Update personnel accountability.
- 

**Evaluation Preparation:**

*Setup:* Provide soldier with a scenario with sufficient information to accomplish performance steps. Provide soldier with a section/platoon battle roster that indicates MOS, grades and filled/vacant positions, paper and pencils. Scenario should provide local requirements for personnel accounting, health and welfare items, and area orientations. Have the soldier list the actions/items he would do or provide to integrate newly assigned soldiers.

*Brief Soldier:* Inform the soldier that he will be tested on his ability to receive and integrate new soldiers into the section/platoon. Tell the soldier he will list the actions/items necessary to properly integrate newly assigned soldiers.

Performance Measures	GO	NO GO
1. Received new soldiers .	___	___
a. Established accountability.		
b. Provided health and welfare items.		
c. Provided initial area orientations and special orders .		
2. Verified soldiers' qualifications and equipment.	___	___
3. Determined duty assignments .	___	___
a. Notified commander.		
b. Notified soldiers .		

Skill Level 4

Performance Measures	GO	NO GO
c. Provided initial counseling.		
4. Updated personnel accountability.	___	___

**Evaluation Guidance:** Score the soldier GO if all performance measures are passed. Score the soldier NO GO if any performance measure is failed. Soldier must score GO on all performance measures to receive a GO. If the soldier scores NO GO, show what was done wrong and how to do it correctly.

**References**

**Required**

**Related**

AR 600-8-101

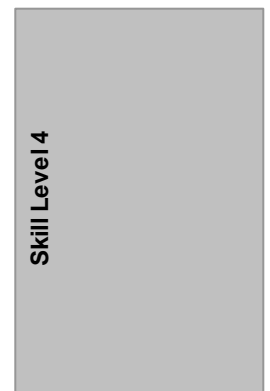

Skill Level 4

805C-PAD-4597

3-405



**Appendix A**

**Proponent School or Agency Codes**

The first three digits of the task number identify the proponent school or agency responsible for the task. Record any comments or questions regarding the task summaries contained in this manual on a DA Form 2028 (*Recommended Changes to Publications and Blank Forms*) and send it to the proponent school with an information copy to: Commander, U.S. Army Training Support Center, ATTN: ATIC-ITSC-CM, Fort Eustis, VA 23604-5166.

<b>Table A-1. Proponent School or Agency Codes</b>	
<b>School Code</b>	<b>Command</b>
MANSCEN CM <b>031</b> EN <b>052</b> MP <b>191</b>	MANSCEN, Directorate of Training Development U.S. Army Engineer Center and Fort Leonard Wood 320 Engineer Loop, Suite 220 Fort Leonard Wood, MO 65473-8929
FA <b>061</b>	Commandant, USA Field Artillery School ATTN: ATSF-DOTD Fort Sill, OK 73503-5600
IN <b>071</b>	Commandant, U.S. Army Infantry School ATTN: ATSH-OTDD Fort Benning, GA 31905-5700
AHS <b>081</b>	USAAHS, Dean, AHS ATTN: MCCS-HTI Fort Sam Houston, TX 78234-6122
TRADOC DCSINT <b>159</b>	Commander, HQ TRADOC ATTN: ATIN-ZA 33 Ingalls Rd. Fort Monroe, VA 23651-1067
JAG <b>181</b>	Commandant, Judge Advocate General School ATTN: JAGS-TDD 600 Massie Road Charlottesville, VA 22903-1781

<b>Table A-1. Proponent School or Agency Codes</b>	
<b>School Code</b>	<b>Command</b>
APAC <b>224</b>	Director, Army Public Affairs Center 6 ACR Road, Bldg 8607 ATTN: SAPA-PA Fort Meade, MD 20755-5650
MI <b>301</b>	Commander, USA Intelligence Center & Fort Huachuca ATTN: ATZS-FDR-TA Fort Huachuca, AZ 85613-6000
JFK <b>331</b>	Commander USA John F. Kennedy Special Warfare Center and School ATTN: AOJK-DT-DMO Fort Bragg, NC 28310-5000
AD <b>441</b>	Commandant, U.S. Army Air Defense Artillery School ATTN: ATSA-DT 2 Sheridan Road Fort Bliss, TX 79916-3802
CASCOM <b>091</b> <b>101</b> <b>151</b> <b>551</b>	U.S. Army Combined Arms Support Command (CASCOM) Training Directorate USACASCOM, ATTN: ATCL-A 401 First St., Suite 227 Fort Lee, VA 23801-1511
SSI <b>805C</b>	Commander, USA Soldier Support Institute ATTN: ATSG-TD-HRD Fort Jackson, SC 29207-7065
TRADOC Safety Office <b>850</b>	Commander, HQ USA Training and Doctrine Command, Safety Office, Bldg 5 ATTN: ATCS-S Fort Monroe, VA 23651-5000



## Appendix B

### GUIDE TO FORMS

This appendix contains a list of forms pertinent to SMCT and CTT evaluations and administration. In the electronic, online version of this manual, hot links will, where indicated, provide downloadable and reproducible copies of the forms. The user can also visit the CTT site in the Reimer Digital Library where access to the **CTT Manual** and **CTT Notice** (Bulletin) provide additional helpful information and links. Some of these forms may be available in your unit.

**DA Form 5164-R** (*Hands On Evaluation*), used by CTT scorer to record GO/NO GO for each performance measure in a given task. Refer to the CTT Manual for the current FY (in the Reimer Digital Library) for links to DA Forms 5164-R that are overprinted with the performance measures for each task on the current CTT.

**CTT Performance Sheet** used by the CTT scorer to compile all GO/NO GO scores to produce an overall GO or NO GO for the soldier's common task test. As with the Hands On Evaluation form above, the CTT Performance Sheet is different for each FY; it is overprinted with the tasks from the current CTT and linked from the CTT Manual (in the Reimer Digital Library) for the current FY.

**DA Form 5165-R** (*Field Expedient Squad Book*), used to record task proficiency for groups of soldiers in a squad. This squad book should be especially beneficial for recording training results gathered during MTP, field exercises, or individual training sessions. Once training is completed, trainers may transfer information from DA Form 5165-R to the leader book (FM 25-101).

**CTT Roll Up for SL 1-2 and SL 3-4**, used by trainers and administrators to record performances for larger, unit-size groups of soldiers. This form is a good means of seeing and reporting an overall ratio of soldiers passing the CTT to the total of those tested.

**DA Form 2028** (*Recommended Changes to Publications and Blank Forms*), used by soldiers and trainers to record any comments or questions regarding the task summaries contained in this manual. Use the task proponent address for the appropriate proponent code given in appendix A (first three digits of the task number).



## Glossary

<b>AA</b>	assembly area
<b>ACE</b>	analysis and control element; armored combat earthmover
<b>AD</b>	air defense
<b>ADW</b>	air defense warning
<b>AIDS</b>	acquired immunodeficiency syndrome
<b>AIPD</b>	Army Institute for Professional Development
<b>AIT</b>	advanced individual training
<b>alt</b>	altitude, alternate
<b>AMC</b>	air mission commander
<b>AMDO</b>	air and missile defense officer
<b>ANCOC</b>	Advanced NCO Course
<b>AO</b>	area of operations
<b>AOC</b>	air operations center
<b>ARC</b>	armored cavalry regiment
<b>ARNG</b>	Army National Guard
<b>ASL</b>	authorized stockage list
<b>ASR</b>	alternate supply route
<b>BCT</b>	basic combat training
<b>BDU</b>	battle dress uniform
<b>BFV</b>	Bradley fighting vehicle
<b>bn</b>	battalion
<b>BNCOC</b>	Basic NCO Course
<b>C2</b>	command and control
<b>C3</b>	command, control, and communications
<b>C4I</b>	command, control, communications, computers, and intelligence
<b>CA</b>	civil affairs
<b>CAM</b>	chemical agent monitor

<b>CB</b>	center of balance; chemical and biological
<b>C-E</b>	communicaton-encryption
<b>CED</b>	captured enemy document
<b>CEE</b>	captured enemy equipment
<b>CEM</b>	captured enemy material
<b>cGy</b>	centigray
<b>cGy/hr</b>	centigray per hour
<b>CH</b>	chaplain
<b>chem</b>	chemical
<b>CI</b>	counterintelligence; civilian internee
<b>CID</b>	Criminal Investigation Division
<b>CINC</b>	commander in chief
<b>CL</b>	combat lifesaver
<b>CM</b>	centimeter(s)
<b>CO</b>	commanding officer
<b>COA</b>	course of action
<b>COMMZ</b>	communications zone
<b>COMSEC</b>	communications security
<b>CONUS</b>	continental United States
<b>COOP</b>	continuity operations procedures
<b>CP</b>	command post
<b>CSDP</b>	Command Supply Discipline Program
<b>CSS</b>	combat service support
<b>CTT</b>	common task test
<b>DAP</b>	decontamination apparatus, portable
<b>DISCOM</b>	division support command
<b>div</b>	division
<b>DL</b>	delay lines
<b>DNBI</b>	diseases and nonbattle injury
<b>DOD</b>	Department of Defense
<b>DTG</b>	date-time group
<b>DTOCSE</b>	division tactical operations center support element
<b>DU</b>	depleted uranium

**Glossary-2**

<b>DZ</b>	drop zone
<b>EA</b>	electronic attack
<b>ECM</b>	electronic countermeasures
<b>EIC</b>	end item codes
<b>EMP</b>	electromagnetic pulse
<b>EMT</b>	emergency medical treatment/emergency medical technician
<b>EO</b>	Equal Opportunity
<b>EOD</b>	emergency ordnance detachment
<b>EOM</b>	end of mission
<b>EP</b>	electronic protection
<b>EPW</b>	enemy prisoner of war
<b>ES</b>	electronic warfare support
<b>ESM</b>	electronic warfare support measures
<b>EW</b>	electronic warfare
<b>EWS</b>	electronic warfare section
<b>F</b>	Fahrenheit
<b>FDC</b>	fire direction center
<b>FEBA</b>	forward edge of the battle area
<b>FIST</b>	fire support team
<b>FM</b>	field manual
<b>FO</b>	forward observer
<b>FORSCOM</b>	Forces Command
<b>FPF</b>	final protective fire
<b>FPL</b>	final protective line
<b>FRAGO</b>	fragmentary order
<b>FST</b>	field sanitation team
<b>FTX</b>	field training exercise
<b>G2</b>	Assistant Chief of Staff, Intelligence
<b>G3</b>	Assistant Chief of Staff, Operations
<b>GI</b>	government issue
<b>GTA</b>	graphic training aid
<b>HEPA</b>	high-efficiency particulate air
<b>HQ</b>	headquarters

<b>HSB</b>	heavy support battalion/heavy separate brigade (depends on use)
<b>HTD</b>	highway traffic division
<b>HUMINT</b>	human intelligence
<b>IAW</b>	in accordance with
<b>ICM</b>	improved conventional munitions
<b>IDP</b>	initial delay position
<b>IEW</b>	intelligence and electronic warfare
<b>IEWSE</b>	intelligence and electronic warfare support element
<b>IG</b>	inspector general
<b>IMINT</b>	imagery intelligence
<b>inf</b>	infantry
<b>IPB</b>	intelligence preparation of the battlefield
<b>ITO</b>	installation transportation office
<b>IV</b>	intravenous
<b>JAG</b>	Judge Advocate General
<b>JP</b>	joint publication
<b>JTA</b>	joint table of allowances
<b>KIA</b>	killed in action
<b>lb</b>	pound
<b>LADW</b>	local air defense warning
<b>LBE</b>	load-bearing equipment
<b>LC</b>	line of contact
<b>LD</b>	line of departure
<b>LES</b>	leave and earnings statement
<b>LET</b>	light equipment transporter
<b>LOC</b>	lines of communications
<b>LOGPAC</b>	logistics package
<b>LPN</b>	licensed practical nurse
<b>LZ</b>	landing zone
<b>MACOM</b>	major Army command
<b>MASINT</b>	measurement and signature intelligence
<b>MBA</b>	main battle area
<b>MD</b>	medical doctor

**Glossary-4**

<b>MEDCEN</b>	medical center
<b>MEDDAC</b>	medical department activity
<b>MEDEVAC</b>	medical evacuation
<b>METT-T</b>	mission, enemy, terrain, troops, and time available (Army); mission, enemy, terrain and weather, troops and support available, and time available (USMC)
<b>METT-TC</b>	mission, enemy, terrain, troops, time available, and civilian considerations
<b>MHE</b>	materials handling equipment
<b>MI</b>	military intelligence
<b>mm</b>	millimeter
<b>MOPP</b>	mission-oriented protective posture
<b>MOSC</b>	military occupational specialty code
<b>MOUT</b>	military operations on urbanized terrain
<b>MP</b>	military police
<b>MPA</b>	mission planning agent; manpower authorization; maritime patrol aircraft
<b>MPH</b>	miles per hour
<b>MRE</b>	meal, ready to eat
<b>MSO</b>	medical supply officer
<b>MSR</b>	main supply route
<b>MTOE</b>	modified table of allowances
<b>NBC</b>	nuclear, biological, and chemical
<b>NBC 1 report</b>	nuclear, biological, and chemical initial report
<b>NBC 4 report</b>	nuclear, biological, and chemical monitoring/surveying results
<b>NBCC</b>	nuclear, biological, and chemical center
<b>NCO</b>	noncommissioned officer
<b>NCOER</b>	noncommissioned officer evaluation report
<b>obj</b>	objective
<b>OBSTINTEL</b>	obstacle intelligence
<b>OCIE</b>	organizational clothing and individual equipment
<b>OEG</b>	operational exposure guidance
<b>OP</b>	observation post

<b>OPCON</b>	operational control
<b>OPLAN</b>	operation plan
<b>OPORD</b>	operation order
<b>OPSEC</b>	operations security
<b>ORP</b>	objective rallying point
<b>OSHA</b>	Occupational Safety and Health Administration
<b>OSUT</b>	one Station unit training
<b>OVE</b>	on vehicle equipment
<b>PA</b>	public affairs; physician assistant
<b>PAC</b>	personnel and administration center
<b>PAO</b>	Public Affairs Office, public affairs operations
<b>PATI</b>	protection assessment test instrument
<b>PATS</b>	protection assessment test system
<b>PBO</b>	property book officer
<b>PCS</b>	permanent change of station
<b>PD</b>	point of departure
<b>PDF</b>	principal direction of fire
<b>PDY</b>	present for duty
<b>PL</b>	phase line
<b>PLDC</b>	Primary Leadership Development Course
<b>PLL</b>	prescribed load list
<b>PM</b>	provost marshal; preventive maintenance
<b>PMCS</b>	preventive maintenance checks and services
<b>PMM</b>	preventive medicine measures
<b>PMOSC</b>	Primary Military Occupational Specialty Code
<b>POL</b>	petroleum, oils, and lubricants
<b>POSH</b>	prevention of sexual harassment
<b>PP</b>	passage point
<b>PS</b>	personnel services
<b>PSS</b>	personnel service support
<b>pub</b>	publication
<b>PW</b>	prisoner of war
<b>RADIAC</b>	radiation, detection, indication, and computation.



<b>RN</b>	registered nurse
<b>ROE</b>	rules of engagement
<b>RP</b>	release point
<b>R&amp;S</b>	reconnaissance and security
<b>RSR</b>	required supply rate
<b>RYE</b>	retirement year ending
<b>S2</b>	battalion intelligence officer
<b>SAEDA</b>	subversion and espionage directed against the Army
<b>SALUTE</b>	size, activity, location, unit, time, and equipment
<b>SIB</b>	separate infantry brigade
<b>SD</b>	self-development training
<b>sig</b>	signal
<b>SIGINT</b>	signals intelligence
<b>SITREP</b>	situation report
<b>SKO</b>	sets, kits, and outfits
<b>SL</b>	skill level; squad leader
<b>SM</b>	soldier's manuals; selected marksman
<b>SMCT</b>	soldier's manual of common tasks
<b>SME</b>	subject matter expert
<b>SO</b>	special operations
<b>SOI</b>	signal operating instructions
<b>SOP</b>	standing operating procedures
<b>SP</b>	start point
<b>SPBS-R</b>	Standard Property Book System-Redesigned
<b>SPOTREP</b>	spot report
<b>SSA</b>	supply support activity
<b>STB</b>	super tropical bleach
<b>STD</b>	sexually transmitted disease
<b>STP</b>	soldier's training publication
<b>SUN</b>	shipment unit number
<b>T/VISC</b>	Training/Visual Information Support Center
<b>TASC</b>	Training and Audiovisual Support Center
<b>TB</b>	Technical Bulletin

<b>TC</b>	training circular
<b>TCAE</b>	technical control and analysis element
<b>TCP</b>	traffic control post
<b>TDA</b>	table of distribution and allowances
<b>TECHINT</b>	technical intelligence
<b>TF</b>	task force
<b>tm</b>	team
<b>TOC</b>	tactical operations center
<b>TOE</b>	table of organization and equipment
<b>TRADOC</b>	United States Army Training and Doctrine Command
<b>trans</b>	transportation
<b>TRP</b>	target reference point
<b>TS</b>	top secret
<b>TTB</b>	transportation terminal battalion
<b>UAV</b>	unmanned aerial vehicle
<b>UCMJ</b>	Uniform Code of Military Justice
<b>UIC</b>	unit identification code
<b>ULLS-G</b>	unit level logistics system-ground
<b>ULLS-S4</b>	unit level logistics system-S4
<b>UMO</b>	unit movement officer
<b>U.S.</b>	United States
<b>USAR</b>	U.S. Army Reserve
<b>WARNO</b>	warning order
<b>WCS</b>	weapons control status
<b>WESS</b>	weapons systems status
<b>WIA</b>	wounded in action
<b>WO</b>	warning order
<b>Z</b>	Zulu Time

**evacuation (JP 1-02)**

1. The process of moving any person who is wounded, injured, or ill to and/or between medical treatment facilities. 2. The clearance of personnel, animals, or materiel from a given locality. 3. The controlled process of collecting, classifying, and shipping unserviceable or abandoned material, United States and foreign, to appropriate reclamation, maintenance, technical intelligence, or disposal facilities. (Army) - 1. The ordered or authorized departure of noncombatants from a specific area by the Department of State, Department of Defense, or appropriate military commander. This refers to the movement from one area to another in the same or different countries. The evacuation is caused by unusual or emergency circumstances and applies equally to command or noncommand-sponsored family members. 2. A combat service support function that involves the movement of recovered material, personnel, casualties, bodies, prisoners of war, and so forth, from a forward collection point along a main supply route to a rearward, usually higher unit, exchange point, or facility. (See also collection point and medical evacuation (MEDEVAC).) See FMs 1-111, 1-112, 7-10, 7-20, 7-30, 8-10-6, 17-95, 17-100, 71-123, 100-5, and 100-15.

**pace**

A full 30-inch step as used when marching (1.3 paces = 1 meter).

**vulnerability analysis**

The second phase in the hazards analysis process. This phase assesses the areas potentially affected by the release of a hazardous material, including on and off the installation; includes gathering information on the extent of the vulnerable zone, conditions that influence the zone, size and type of population within the zone, missions and critical systems that may be impacted, property that might be damaged, and the environment that might be affected.



## References

### REQUIRED PUBLICATIONS

Required publications are sources that users must read to understand or comply with this publication.

#### ARMY REGULATIONS

- AR 25-50, *Preparing and Managing Correspondence*, 3 June 2002.
- AR 25-400-2, *The Modern Army Recordkeeping System (MARKS)*, 1 October 2000.
- AR 27-10, *Military Justice*, 6 September 2002.
- AR 30-22, *The Army Food Program*, 30 August 2002.
- AR 190-8, *Enemy Prisoners of War, Retained Personnel, Civilian Internees and Other Detainees* (OPNAVINST 3461.6; AFJI 31-304; MCO 3461.1), 1 October 1997.
- AR 190-11, *Physical Security of Arms, Ammunition and Explosives*, 30 September 1993.
- AR 190-13, *The Army Physical Security Program*, 30 September 1993.
- AR 190-45, *Law Enforcement Reporting*, 20 October 2000.
- AR 190-51, *Security of Unclassified Army Property (Sensitive and Nonsensitive)*, 30 September 1993.
- AR 220-45, *Duty Rosters*, 15 November 1975.
- AR 350-30, *Code of Conduct Survival, Evasion, Resistance and Escape (SERE) Training*, 10 December 1985.
- AR 360-1, *The Army Public Affairs Program*, 15 September 2000.
- AR 380-5, *Department of the Army Information Security Program*, 29 September 2000.
- AR 385-10, *The Army Safety Program*, 23 May 1988.
- AR 385-40, *Accident Reporting and Records*, 1 November 1994.
- AR 385-55, *Prevention of Motor Vehicle Accidents*, 12 March 1987.
- AR 525-13, *Antiterrorism*, 4 January 2002.
- AR 600-8-2, *Suspension of Favorable Personnel Actions (FLAGS)*, 30 October 1987.
- AR 600-8-22, *Military Awards*, 25 February 1995.

AR 600-8-101, *Personnel Processing (In-and-Out and Mobilization Processing)*, 12 December 1989.

AR 600-8-104, *Military Personnel Information Management/Records*, 27 April 1992.

AR 600-13, *Army Policy for the Assignment of Female Soldiers*, 27 March 1992.

AR 600-20, *Army Command Policy*, 13 May 2002.

AR 600-55, *The Army Driver and Operator Standardization Program (Selection, Training, Testing, and Licensing)*, 31 December 1993.

AR 601-280, *Army Retention Program*, 31 March 1999.

AR 623-205, *Noncommissioned Officer Evaluation Reporting System*, 15 May 2002.

AR 630-10, *Absence Without Leave, Desertion, and Administration of Personnel Involved in Civilian Court Proceedings*, 31 August 2001.

AR 635-200, *Enlisted Personnel*, 1 November 2000.

AR 700-4, *Logistics Assistance*, 20 August 2002.

AR 700-84, *Issue and Sale of Personal Clothing*, 15 May 1983.

AR 700-138, *Army Logistics Readiness and Sustainability*, 16 September 1997.

AR 710-2, *Inventory Management Supply Policy Below the Wholesale Level*, 31 October 1997.

AR 725-50, *Requisition, Receipt, and Issue System*, 15 November 1995.

AR 735-5, *Policies and Procedures for Property Accountability*, 10 June 2002.

AR 750-1, *Army Materiel Maintenance Policy and Retail Maintenance Operations*, 1 August 1994.

AR 750-43, *Army Test, Measurement and Diagnostic Equipment Program*, 28 November 1997.

#### **DEPARTMENT OF ARMY FORMS**

DA Form 6, *Duty Roster*

DA Form 638, *Recommendation for Award*

DA Form 1155, *Witness Statement on Individual*

DA Form 1156, *Casualty Feeder Report*

DA Form 1971-R, *Radiological Data Sheet- Monitoring or Point Technique*

DA Form 1971-6-R, *Chemical/Biological Specimen Documentation*

DA Form 1971-10-R, *NBC 4 Radiation Dose Rate Measurements/Chemical/Biological Areas of Contamination*

#### **References-2**

DA Form 2166-8, *Noncommissioned Officer Evaluation Report*  
DA Form 2166-8-1, *Noncommissioned Officer Counseling Checklist/Record*  
DA Form 2404, *Equipment Inspection and Maintenance Worksheet*  
DA Form 2823, *Sworn Statement*  
DA Form 3881, *Rights Warning Procedure/Waiver Certificate*  
DA Form 3946, *Military Police Traffic Accident Report*  
DA Form 3975, *Military Police Report*  
DA Form 4002, *Evidence/Property Tag*  
DA Form 4137, *Evidence/Property Custody Document*  
DA Form 5367-R, *Personnel Status Report*

**DEPARTMENT OF ARMY PAMPHLETS**

DA Pam 25-30, *Consolidated Index of Army Publications and Blank Forms*, 1 January 2003.  
DA Pam 350-20, *Unit Equal Opportunity Training Guide*, 30 August 1993.  
DA Pam 385-1, *Small Unit Safety/Officer/NCO Guide*, 29 November 2001.  
DA Pam 600-26, *The Department of the Army Affirmative Action Plan*, 30 August 1993.  
DA Pam 710-2-1, *Using Unit Supply System (Manual Procedures) (Standalone Pub)*, 31 December 1997.  
DA Pam 710-2-2, *Supply Support Activity Supply System: Manual Procedures*, 30 September 1998.  
DA Pam 738-750, *Functional Users Manual for the Army Maintenance Management System (TAMMS)*, 1 August 1994.  
DA Pam 750-1, *Leader's Unit Level Maintenance Handbook*, 15 February 1994.  
DA Pam 750-35, *Guide for Motor Pool Operations*, 1 August 1994.

**DEPARTMENT OF DEFENSE FORMS**

DD Form 1408, *Armed Forces Traffic Ticket*  
DD Form 1805, *United States District Court Violation Notice*  
DD Form 1920, *Alcoholic Influence Report*

**DEPARTMENT OF DEFENSE PUBLICATIONS**

DODD 7050.6, *Military Whistleblower Protection*, 23 June 2000

## **FIELD MANUALS**

- FM 3-05.71(FM 21-78), *(C) Resistance and Escape (U)*, 7 September 2001.
- FM 3-09.21 ( FM 6-20-1), *Tactics, Techniques and Procedures for the Field Artillery Battalion* 22 March 2001
- FM 3-3, *Chemical and Biological Contamination Avoidance*, 16 November 1992.
- FM 3-4, *NBC Protection*, 29 May 1992.
- FM 3-5, *NBC Decontamination*, 28 July 2000.
- FM 3-19.1 (FM 19-1), *Military Police Operations*, 22 March 2001.
- FM 3-19.4 (FM 19-4), *Military Police Leaders' Handbook*, 4 March 2002.
- FM 3-19.30 (FM 19-30), *Physical Security*, 8 January 2001.
- FM 3-19.40 (FM 19-40), *Military Police Internment/Resettlement Operations*, 1 August 2001.
- FM 3-21.71 (FM 7-7J), *Mechanized Infantry Platoon and Squad (Bradley)*, 20 August 2002.
- FM 3-25.26 (FM 21-26), *Map Reading and Land Navigation*, 20 July 2001.
- FM 3-34.2 (FM 5-101 and FM 90-13-1), *Combined-Arms Breaching Operations*, 31 August 2000.
- FM 3-90.1 (FM 71-1), *Tank and Mechanized Infantry Company Team*, 9 December 2002.
- FM 3-90.2 (FM 71-2), *The Tank and Mechanized Infantry Battalion Task Force*, 11 June 2003.
- FM 4-01.011 (FM 55-65 and FM 55-9), *Unit Movement Operations*, 31 October 2002.
- FM 4-25.11 (FM 21-11), *First Aid*, 23 December 2002.
- FM 4-25.12 (FM 21-10-1), *Unit Field Sanitation Team*, 25 January 2002.
- FM 4-30.3 (FM 9-43-1), *Maintenance Operations and Procedures*, 1 September 2000.
- FM 5-34, *Engineer Field Data*, 30 August 1999. (Will be revised as FM 3-34.310).
- FM 5-103, *Survivability*, 10 June 1985. (Will be revised as FM 3-34.112).
- FM 5-170 (FM 5-36), *Engineer Reconnaissance*, 5 May 1998. (Will be revised as FM 3-34.212).
- FM 6-30, *Tactics, Techniques, and Procedures for Observed Fire*, 16 July 1991. (Will be revised as FM 3-09.3).

## **References-4**



FM 7-7, *The Mechanized Infantry Platoon and Squad (APC)*, 15 March 1985. (Will be revised as FM 3-21.7).

FM 7-8, *Infantry Rifle Platoon and Squad*, 22 April 1992. (Will be revised as FM 3-21.8).

FM 7-20, *The Infantry Battalion*, 6 April 1992. (Will be revised as FM 3-21.20).

FM 7-22.7, *The Army Noncommissioned Officer Guide*, 23 December 2002.

FM 8-10-6, *Medical Evacuation in a Theater of Operations, Tactics, Techniques and Procedures*, 14 April 2000. (Will be revised as FM 4-02.2).

FM 10-23, *Basic Doctrine for Army Field Feeding and Class I Operations Management*, 18 April 1996. (Will be revised as FM 4-20.2).

FM 10-27-4, *Organizational Supply and Services for Unit Leaders*, 14 April 2000. (Will be revised as FM 4-20.05).

FM 17-95, *Cavalry Operations*, 24 December 1996. (Will be revised as FM 3-20.95).

FM 19-15, *Civil Disturbances*, 25 November 1985. (Will be revised as FM 3-19.15).

FM 19-20, *Law Enforcement Investigations*, 25 November 1985. (Will be revised as FM 3-19.20).

FM 19-25, *Military Police Traffic Operations*, 30 September 1977. (Will be revised as FM 3-19.25).

FM 21-10, *Field Hygiene and Sanitation*, 21 June 2000. (Will be revised as FM 4-25.10).

FM 21-60, *Visual Signals*, 30 September 1987. (Will be revised as FM 3-12.60).

FM 21-75, *Combat Skills of the Soldier*, 3 August 1984. (Will be revised as FM 3-21.75).

FM 22-100, *Army Leadership*, 31 August 1999. (Will be revised as FM 6-22).

FM 25-101, *Battle Focused Training*, 30 September 1990. (Will be revised as FM 7-1).

FM 55-1, *Transportation Operations*, 3 October 1995. (Will be revised as FM 4-01).

FM 55-15, *Transportation Reference Data*, 27 October 1997. (Will be revised as FM 4-01.15).

FM 55-30, *Army Motor Transport Units and Operations*, 27 June 1997. (Will be revised as FM 4-01.40).

FM 63-2, *Division Support Command, Armored, Infantry, and Mechanized Infantry Divisions*, 20 May 1991. (Will be revised as FM 4-93.2).

FM 63-2-1, *Division Support Command Light Infantry, Airborne, and Air Assault Divisions*, 16 November 1992. (Will be revised as FM 4-93.25).

FM 63-20, *Forward Support Battalion*, 26 February 1990. (Will be revised as FM 4-93.20).

FM 63-21, *Main Support Battalion*, 7 August 1990. (Will be revised as FM 4-93.21).

FM 63-21-1, *Tactics, Techniques, and Procedures for the Division Support Battalion (Digitized)*. (Will be revised as FM 4-93.51).

FM 63-23-2, *Tactics, Techniques, and Procedures for the Division Aviation Support Battalion (Digitized)*

FM 100-10, *Combat Service Support*, 3 October 1995. (Will be revised as FM 4-0).

FM 100-14, *Risk Management*, 23 April 1998. (Will be revised as FM 5-19).

FM 100-17, *Mobilization, Deployment, Redeployment, Demobilization*, 28 October 1992. (Will be revised as FM 3-35).

FM 101-5, *Staff Organization and Operations*, 31 May 1997. (Will be revised as FM 5-0).

FM 101-5-1, *Operational Terms and Graphics*, 30 September 1997. (Will be revised as FM 1-02).

#### **GRAPHIC TRAINING AIDS**

GTA 03-06-008, *NBC Warning and Reporting System*, 1 August 1996.

#### **OTHER PRODUCT TYPES**

CTA 50-900, *Clothing and Individual Equipment*, 1 September 1994.

CTA 50-909, *Field and Garrison Furnishings and Equipment*, 1 August 1993.

CTA 50-970, *Expendable/Durable Items (Except: Medical, Class V, Repair Parts and Heraldic Items)*, 21 September 1990.

DD Form 2745, *Enemy Prisoner of War (EPW) Capture Tag*

MCM 2002, *Manual for Courts-Martial, United States*, 2002 Edition, 21 June 2002.

STANAG 2044, *Procedures for Dealing with Prisoners of War (PW)*.

### **SOLDIER TRAINING PUBLICATIONS**

STP 19-95B1-SM, *Soldier's Manual for MOS 95B, Military Police Skill Level 1*, (EMO) 6 August 2002.

STP 21-1-SMCT, *Soldier's Manual of Common Tasks Skill Level 1*, 31 August 2003.

### **TECHNICAL BULLETINS**

TB Med 530, *Occupational and Environmental Health Food Service Sanitation*, 28 November 1991.

TB Sig 226-8, *Chargers, RADIAC Detector PP-1578/PD AND PP-1578A/PD*, 6 October 1982.

TB 55-46-1, *Standard Characteristics (Dimensions, Weight, and Cube) for Transportability of Military Vehicles and Other Outsize/Overweight Equipment (In Toe Line Item Number Sequence)*, 1 January 2002.

### **TECHNICAL MANUALS**

TM 3-4240-279-10, *Operator's Manual for Mask, Chemical-Biological: Field*, ABC- M17, M17A1, M17A, 5 October 1987.

TM 3-6665-307-10, *Operator's Manual for Chemical Agent Detector Kit, M256 and M256A1*, 1 September 1985.

TM 3-9905-001-10, *Operator's Manual for Marking Set, Contamination: Nuclear, Biological, Chemical (NBC)*, 23 August 1982.

TM 9-243, *Use and Care of Hand Tools and Measuring Tools*, 12 December 1983.

TM 10-8415-209-10, *Operator's Manual for Individual Chemical Protective Clothing*, 31 March 1993.

TM 11-6665-214-10, *Operator's Manual for RADIACMETERS, IM-9E/PD, IM-93/UD AND IM-147/PD*, 1 August 1986.

TM 11-6665-232-12, *Operator's and Organizational Maintenance Manual for RADIACMETERS, IM-174A/PD and IM-174B/ PD*, 1 October 1987.

TM 11-6665-251-10, *Operator's Manual for RADIAC Set AN/VDR*, 1 March 1988.

TM 11-6665-365-12&P, *Operator's and Unit Maintenance Manual (Including Repair Parts and Special Tools List) for RADIAC Set AN/PDR-77*, 28 February 1995.

### **TRAINING CIRCULARS**

TC 3-41, *Protection Assessment Test System (PATS)*, 14 January 1995.

TC 21-7, *Personal Financial Readiness and Deployability Handbook*, 17 November 1997.

TC 26-6, *Commander's Equal Opportunity Handbook*, 14 October 1994.

#### **RELATED PUBLICATIONS**

Related publications are sources of additional information. They are not required in order to understand this publication.

#### **ARMY CORRESPONDENCE COURSE PROGRAM SUBCOURSES**

IS0826, *Combat Lifesaver Instructor Manual*.

#### **ARMY REGULATIONS**

AR 40-5, *Preventive Medicine*, 15 October 1990.

AR 190-22, *Searches, Seizures and Disposition of Property*, 1 January 1983.

AR 220-1, *Unit Status Reporting*, 30 November 2001.

AR 350-1, *Army Training and Education*, 9 April 2003.

AR 385-63, *Policies and Procedures for Firing Ammunition for Training, Target Practice and Combat*, 15 October 1983.

AR 600-8-1, *Army Casualty Operations/Assistance/Insurance*, 20 October 1994.

AR 600-63, *Army Health Promotion*, 17 November 1987.

#### **DEPARTMENT OF ARMY FORMS**

DA Form 1971-2-R, *Chemical Data Sheet - Monitoring or Survey*

#### **DEPARTMENT OF ARMY PAMPHLETS**

DA Pam 350-59, *Army Correspondence Course Program Catalog*, 1 October 2002.

DA Pam 385-1, *Small Unit Safety Officer/NCO Guide*, 29 November 2001.

#### **DEPARTMENT OF DEFENSE PUBLICATIONS**

DODD 1300.7, *Training and Education to Support the Code of Conduct*, 8 December 2000.

#### **FIELD MANUALS**

FM 3-0, *Operations*, 14 June 2001.

FM 3-3-1, *Nuclear Contamination Avoidance*, 9 September 1994.

FM 3-22.68 (FM 23-14), *M249 Light Machine Gun in the Automatic Rifle Role*, 31 January 2003.

FM 5-10, *Combat Engineer Platoon*, 3 October 1995. (Will be revised as FM 3-34.220).

#### **References-8**

FM 5-100, *Engineer Operations*, 27 February 1996. (Will be revised as FM 3-34).

FM 5-102, *Countermobility*, 14 March 1985. (Will be revised as FM 3-34.1).

FM 7-10, *The Infantry Rifle Company*, 14 December 1990. (Will be revised as FM 3-21.10).

FM 10-1, *Quartermaster Principles*, 11 August 1994. (Will be revised as FM 4-20).

FM 10-15, *Basic Doctrine Manual For Supply And Storage*, 12 December 1990. (Will be revised as FM 4-20.06).

FM 10-23-1, *Commander's Guide to Food Service Operations*, 17 March 1992. (Will be revised as FM 4-20.51).

FM 10-27-3, *Tactics, Techniques and Procedures for Quartermaster Headquarters*, 30 October 1990. (Will be revised as FM 4-20.04).

FM 19-25, *Military Police Traffic Operations*, 30 September 1977. (Will be revised as FM 3-19.25).

FM 20-3, *Camouflage, Concealment, and Decoys*, 30 August 1999. (Will be revised as FM 3-58.1).

FM 20-32, *Mine/Countermine Operations*, 29 May 1998. (Will be revised as FM 3-34.32).

FM 23-1, *Bradley Gunnery*, 18 March 1996. (Will be revised as FM 3-22.1).

FM 23-90, *Mortars*, 1 March 2000. (Will be revised as FM 3-22.90).

FM 34-1, *Intelligence and Electronic Warfare Operations*, 27 September 1994. (Will be revised as FM 2-0).

FM 34-3, *Intelligence Analysis*, 15 March 1990. (Will be revised as FM 2-33.4).

FM 34-10, *Division Intelligence and Electronics Warfare Operations*, 25 November 1986. (Will be revised as FM 2-19.3).

FM 34-25, *Corps Intelligence and Electronic Warfare Operations*, 30 September 1987. (Will be revised as FM 2-19.2).

FM 34-52, *Intelligence Interrogation*, 28 September 1992. (Will be revised as FM 2-22.3).

FM 34-54, *Technical Intelligence*, 30 January 1998. (Will be revised as FM 2-22.4).

FM 34-130, *Intelligence Preparation of the Battlefield*, 8 July 1994. (Will be revised as FM 2-01.3).

FM 44-8, *Combined Arms for the Air Defense*, 1 June 1999. (Will be revised as FM 3-01.8).

- FM 44-80, *Visual Aircraft Recognition*, 30 September 1996. (Will be revised as FM 3-01.80).
- FM 44-100, *U.S. Army Air and Missile Defense Operations*, 15 June 2000. (Will be revised as FM 3-01).
- FM 46-1, *Public Affairs Operations*, 30 May 1997.
- FM 100-15, *Corps Operations*, 29 October 1996. (Will be revised as FM 3-92).

#### **TECHNICAL MANUALS**

- TM 3-4240-279-20&P, *Unit Maintenance Manual (Including Repair Parts and Special Tools List) for Mask, Chemical-Biological; Field, ABC-M17, M17A1, M17A2*, 5 October 1987.
- TM 9-2320-273-10, *Truck Tractor, Line Haul, 50,000 GVWR, 6X4, M915; Light Equipment Transporter (LET), 56,000 GVWR, 6X6, W/Winch, M916; Medium Equipment Transporter (MET) 75,000 GVWR, 8x6 W/Winch, M920; Truck Chassis, 75,000 GVWR, 8x6 for 20-ton Dump Truck, M917; 56,000 GVWR, 6x6 for Bituminous Distributor Truck, M918, 75,000 GVWR, 8x6 for Concrete Mobile Mixer Truck, M919*, 15 May 1980.
- TM 9-2320-279-10-1, *Operator's Manual for M977 Series 8X8 Heavy Expanded, MOBILITY Tactical Trucks (HEMTT), Truck, Cargo, with Winch, M977 Truck, Cargo, etc.*, 21 November 1986.
- TM 9-2320-279-10-2, *Operator's Manual for M977 Series, 8X8 Heavy Expanded Mobility Tactical Trucks (HEMTT) Truck, Cargo, with Winch, M977 (2320-01-097-0260) Truck, Cargo, without Winch, etc.*, 15 June 1987.
- TM 9-2320-280-10, *Operator's Manual for Truck, Utility: Cargo/Troop Carrier, 1-1/4 TON, 4X4, M998 (NSN 2320-01-107-7155) (EIC: BBD); M998A1 (2320-01-371-9577) (EIC:BBN); Truck, Utility: Cargo etc.*, 31 January 1996.
- TM 9-2320-283-10, *Operator's Manual for Truck Tractor, Line Haul; 50,000 GVWR, 6X4, M915A1 (NSN 2320-01-125-2640)*, 27 June 1983.
- TM 9-2320-289-10, *Operator's Manual for Truck, Cargo, Tactical, 1-1/4 Ton, 4X4, M1008 (NSN 2320-01-123-6827) Truck, Cargo, Tactical, 1-1/4 Ton, 4X4, M1008A1 (2320-01-123-2671) Truck, Utility, Tactical 3/4 Ton etc.*, 4 July 1986.
- TM 9-2320-360-10, *Operator's Manual for Truck, Tractor, M1070, 8X8, Heavy Equipment Transporter (HET) (NSN 2320-01-318-9902)*, 31 March 1994.

#### **References-10**

- TM 9-2320-361-10, *Operator's Manual for 2-1/2-TON, 6X6, M44A2 Series Truck (Multifuel); Truck, Cargo: 2-1/2-Ton, 6X6, M35A2, M35A2C, M36A2, Truck, Tank, Fuel: 2-1/2-TON, 6X6, M49A2C; Truck, Tank, etc.*, 15 December 1988.
- TM 9-2320-364-10, *Operator's Manual for Truck, Tractor, M1074 and M1075 Palletized Load System (PLS) (NSN 2320-01-304-2277) (2320-01-304-2278)*, 1 August 1999.
- TM 9-2320-365-10, *Operator's Instructions for M1078 Series, 2-1/2 Ton, 4X4 Light Medium Tactical Vehicles (LMTV) Truck, Cargo, LMTV, M1078 W/WN (NSN 2320-01-360-1898), etc.*, 17 June 1998.
- TM 9-2320-366-10-1, *Operator's Instructions Manual for M1083 Series, 5-Ton, 6X6, Medium Tactical Vehicles (MTV) Volume 1 of 2 Truck, Cargo, MTV, M1083 w/Wn (NSN 2320-01-360-1895)(EIC:BT3) w/o Wn (2320-01-354-3386)(EIC:BR2) Truck, Cargo, MTV w/MATL HDLG EQPT (MHE), etc.*, 15 September 1998.
- TM 9-2320-366-10-2, *Operator's Instructions Manual for M1083 Series, 5-Ton, 6X6, Medium Tactical Vehicles (MTV) Volume 2 of 2 Truck, Cargo, MTV, M1083 w/Wn (NSN 2320-01-360-1895)(EIC:BT3) w/o Wn (2320-01-354-3386)(EIC:BR2) Truck, Cargo, MTV w/MATL HDLG EQPT (MHE) etc.*, 15 September 1998.
- TM 11-6665-236-12, *Operator's and Unit Maintenance Manual for RADIAC Set, AN/PDR-75*, 1 June 1995.
- TM 38-250, *Preparing Hazardous Materials for Military Air Shipments (AFMAN 24-204; NAVSUP PUB 505; MCO P4030.19H; DLAI 4145.3)*, 12 December 2001.





**STP 21-24-SMCT  
31 AUGUST 2003**

By Order of the Secretary of the Army:

**PETER J. SCHOOMAKER**  
General, United States Army  
Chief of Staff

Official:

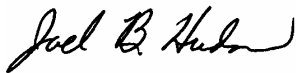

**JOEL B. HUDSON**  
Administrative Assistant to the  
Secretary of the Army  
0320901

DISTRIBUTION:

*Active Army, Army National Guard, and US Army Reserve:* Distribute in accordance with the initial distribution number IDN 11 4379, requirements for STP 21-24-SMCT.

Skill Level 2



Skill Level 3



Skill Level 4



PIN: 065276-000