

SolidWorks Optimization

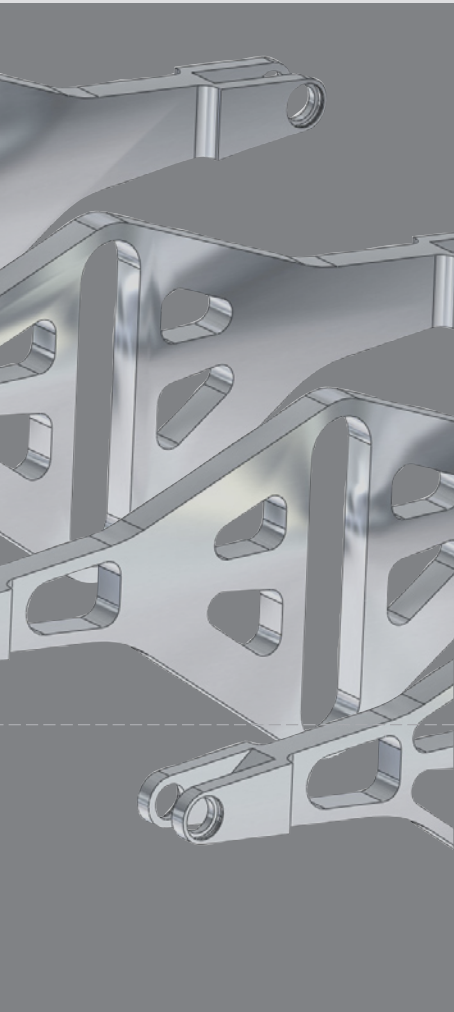
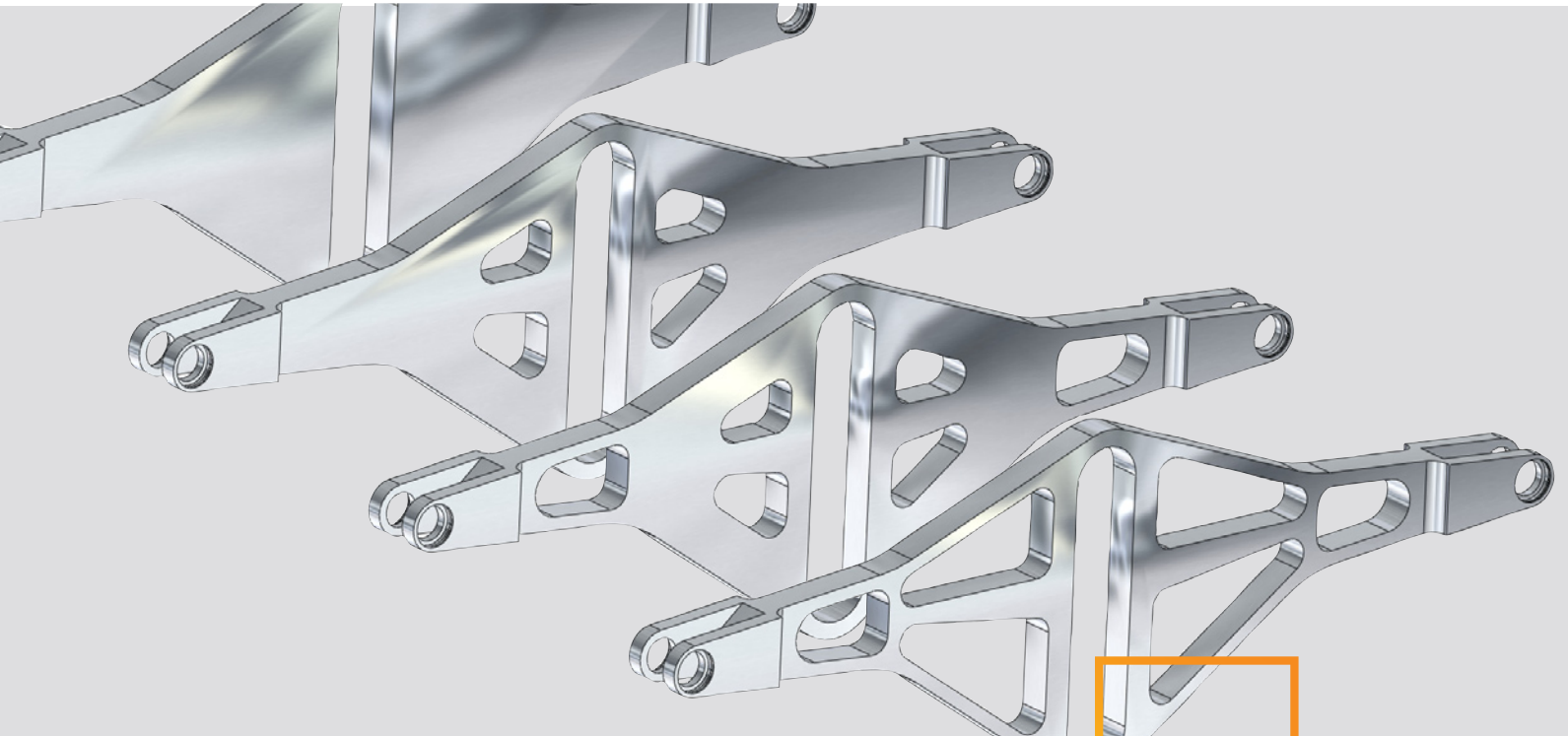

SUMMARY

Optimization is the calculation of weight, stress, cost, deflection, natural frequencies, and temperature factors, which are dependent on variables such as dimensions, loads and restraints, materials, and manufacturing requirements. The challenge is that we seldom know these inputs at the early stages of the design process.

This paper reviews some key concepts in optimization, tools now available for FEA-driven optimization, and then focuses on how design engineers can get the most out of optimization in their day-to-day work.

Design optimization can increase the value of a product by improving its performance within its operating environment.

Introduction to optimization

Over the past decade, design engineers have learned to use and trust such computer-aided engineering (CAE) tools as finite element analysis (FEA), computational fluid dynamics (CFD), and motion simulation as important aids to producing better designs faster. They know that such tools help them design parts, assemblies, and products that will withstand the toughest service likely to befall them.

However, products designed to meet “worst case scenarios” may not be the best designs for their real life environments. To meet safety and strength requirements, they may be overengineered and too heavy for their purposes, or excessively difficult and costly to manufacture. Design engineers who want to get closer to designing the best and most profitable products for their functions need to take the next CAE step in product development—optimization.

Optimization for design engineers

Design optimization can increase the value of a product by improving its performance within its operating environment, and by reducing the cost of producing it by reducing the amount of material used to make it.

The design engineer is, by definition, on the forefront of product development. Today, such an engineer is already familiar with design analysis—and that means he or she already has at hand the basic knowledge required for performing optimization, and only needs optimization tools to take the next step.

By employing optimization, the design engineer will increase his knowledge of his product's behavior and improve upon the design, while adhering to the data obtained from previously completed analyses.

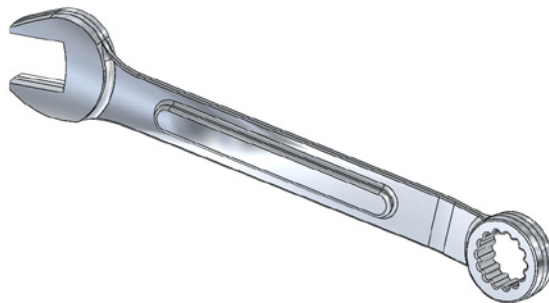

FIGURE 1:
OPEN END WRENCH FOR OPTIMIZATION

Building blocks of optimization

The process of optimization has three major components:

- Objective
- Constraints
- Variables

At its simplest, the optimized design should either maximize or minimize the objective by changing the variables while keeping critical responses within defined constraints.

Objective

The objective is the purpose for which optimization is being performed. For example, if a company's research shows that it will gain a competitive advantage by producing the lightest or least expensive product, then minimizing weight or cost becomes the objective of the optimization. Such a case is called single objective optimization.

Engineers frequently have to deal with multiobjective optimizations. These, however, can call for greater resources than may be available on a daily basis. If the design engineer can refine his problem definition to a single objective—or one objective at a time—the optimization process becomes easier.

In the majority of cases, engineers who work with structural responses have weight minimization as an objective. In fluid flow applications, the most common objectives are minimizing pressure drop and turbulent energy, or maximizing velocity.

If the design engineer can refine his problem definition to a single objective—or one objective at a time—the optimization process becomes easier.

Constraints

Constraints bring reality into optimization. The cantilevered beam example shown in Figure 2 is a case in point. If the optimization problem were set up as an unconstrained weight minimization study, the optimization program would immediately choose the minimum material condition allowed by the dimensional variables. In the real world, however, most parts have such other operational requirements as strength or stiffness. Thus it is important for the engineer to choose constraints that define the acceptable behavior of the part within its system. The constraints he chooses are typically those allowable in a single static, frequency, or thermal analysis.

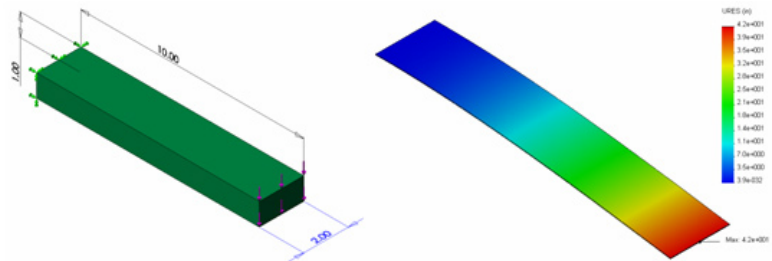

FIGURE 2:
MINIMUM WEIGHT BEAM MAY DEFLECT EXCESSIVELY.

Design variables

In an optimization study, the engineer needs to be able to change the design parameters if he hopes to find the best of several possible design configurations. Those parameters are the design variables. They may be dimensions, or the number of instances in a pattern, or material properties, or loads, spring stiffness—or any other aspect of a design that may have a detectable “best” value or consideration.

Variables can be continuous—meaning that the variable can have any value between a specified minimum and maximum. Most dimensional variables fall into the continuous category.

If the engineer selects too many variables, or too few, the effectiveness of the analysis can be hampered.

They can also be discrete—meaning that the variable has a defined set of possible values. The simplest form of discrete variable is an on-off or yes-no variable. For example, the presence or lack of a weld or fastener fits into the discrete variable category. Other examples include the instances of a pattern. Or, for instance, a pulley or wheel may have any whole number of spokes—but not 3.2 or 4.7.

Sheet-metal gages provide an example of a variable that may fall into either category. Generally, the gage thickness has predefined values, but it's a common practice to specify thickness as a continuous variable and then round up or down to the nearest gage thickness.

The selection of variables is a very important step in setting up an optimization study. If the engineer selects too many variables, or too few, the effectiveness of the analysis can be hampered. Too many variables, or too large a range for them, may make it difficult for the program to determine the most appropriate configuration of the design—especially when considering relative minima and maxima. On the other hand, if the designer provides too few variables, or too narrow a range for them, the success of the study may be unnecessarily limited.

The most reliable method for selecting variables properly lies in performing initial sensitivity studies on the various possibilities—a process that will be discussed in the next section.

Tools for product optimization

FEA-driven optimization represents a growing research field in engineering. Although many programs and techniques are available for performing it, trade studies, sensitivity studies, and shape optimization are the most commonly used today. The two most frequently used methods of shape optimization are gradient search and design of experiments (DoE). The latter is based on response surface calculations, and results in “robust” solutions—that is, effective in the broadest range of possible service conditions over the life of the product.

Trade studies

Trade studies are iterative explorations of alternative design configurations. For example, the design engineer can add a rib or remove one to learn the resulting impact on performance.

Trade studies can be highly valuable for fast evaluation of multiple options, to determine which, if any, of the possible changes to a part might have the most impact. Because the number of combinations of features can be unlimited, it's important to record the iterations and their corresponding response to avoid duplication or loss. Users of SolidWorks® have an excellent tool for managing trade study iterations in the Configurations utility.

Once the possible changes have been qualified, and some shown as worthy of more study, the designer can employ a sensitivity study to investigate the variability of the relevant dimensions or design features.

Sensitivity studies

A sensitivity study systematically evaluates the change in response to input variations. The results of such studies are typically shown in plots and graphs that indicate the magnitude of the parameter being changed on the X axis, and the response to the change on the Y axis. Figure 3 shows an example of this output. A large variation in response to the input range indicates high sensitivity. Low variation in response indicates insensitivity. Such studies help to show the engineer the features that warrant further study.

The two most frequently used methods of shape optimization are gradient search and design of experiments (DoE).

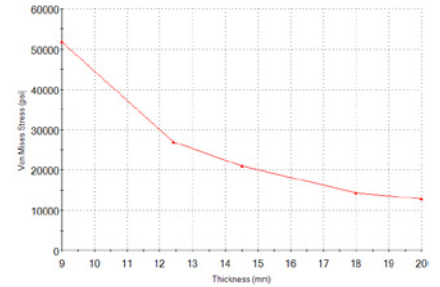
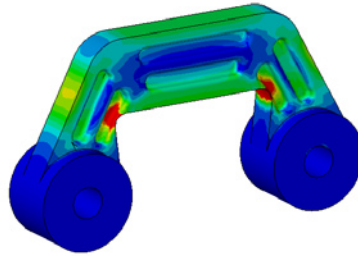

FIGURE 3:
PARAMETER SENSITIVITY STUDY—STRESS VS. THICKNESS

In addition, sensitivity studies can point the engineer to the most significant parameters as well as the range of values having the most impact on the objective. An FEA-based optimization program can complete such a study by solving the problem with a series of values for a specific parameter, and then plotting the objective and constrained responses.

Figure 4 shows the input form for setting up such a sensitivity study with SolidWorks Simulation, using the Design Scenarios functionality in the program. This automated method divides each parameter range under consideration into equal divisions, by indicating the dimensional values to be studied. After solving the model at each dimension, the program generates response plots, such as those shown in Figure 4.

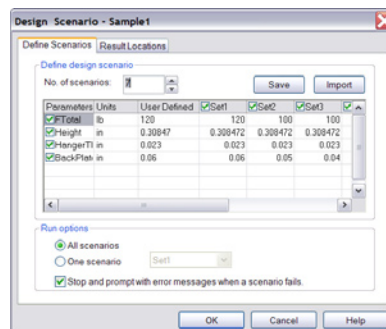
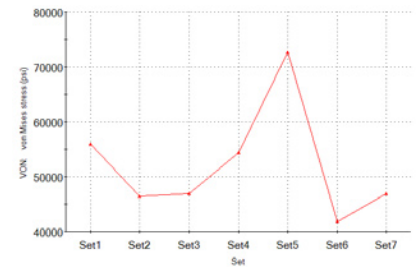
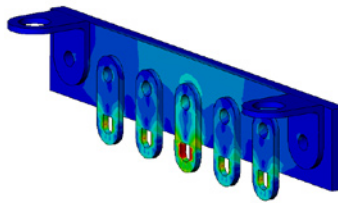

FIGURE 4:
SETUP FOR MULTIPARAMETER
SENSITIVITY STUDY USING DESIGN
SCENARIOS

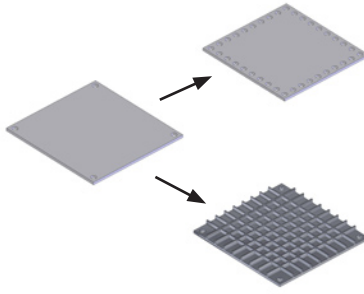

FIGURE 5:
A ROBUST OPTIMIZATION
ALGORITHM CAN DETERMINE
OPTIMAL DESIGN DIRECTION.

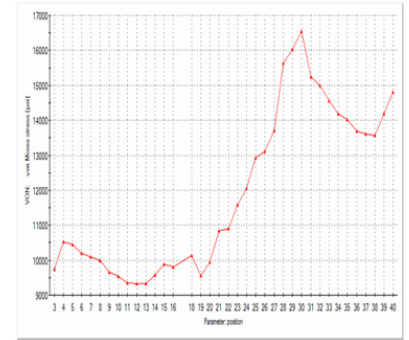

FIGURE 6:
SENSITIVITY PLOT WITH MULTIPLE
MINIMA

Sensitivity studies can point the engineer to the most significant parameters as well as the range of values having the most impact on the objective.

Optimization with SolidWorks

SolidWorks Simulation uses a DoE-based optimization method. To run a problem, the engineer provides the maximum and minimum values of his dimensional design variables, and then chooses a “Standard” or “High Quality” optimization. The Standard approach works on the assumption that the objective response curve between the limit values is linear, and calculates only the response at these values. The High Quality optimization takes into account the possibility of a second order response between the limits, and evaluates a middle value as well as the extremes. Figure 7 shows automatic design iterations performed for an automotive suspension as the size of three fillets is varied. In this case, design constraint is not to exceed the yield strength of the material under static loading.

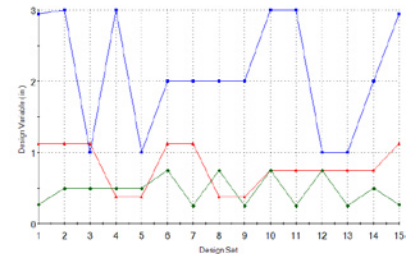
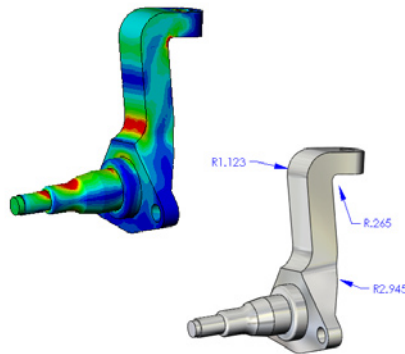

FIGURE 7:
OPTIMIZATION OF SPINDLE SHAPE
WITH VARIABLE FILLET RADII

The SolidWorks Simulation optimization study produces a single value representing an optimal configuration for each variable. To get the greatest degree of accuracy with this method, the engineer should refine the range of values for each variable and run a second optimization or a sensitivity study. By doing so, the optimization program will give him fast and effective insights into improving his product and reaching an optimal design.

The engineer who undertakes optimization will get the best value out of the technology by performing optimization in the early stages of the design process.

The best time for optimization runs

The engineer who undertakes optimization will get the best value out of the technology by performing optimization in the early stages of the design process. As a design progresses, it tends to become more and more complex, and changes become more difficult to evaluate and implement.

At the conceptual stage of a design, the engineer can use optimization to make sure the base design has the right materials, wall thickness, stiffening features, fastening methods, and the like. Studies have shown that 80 percent of a product's cost is defined in the first 20 percent of the design process. To make sure a competitive product performs as desired, it's worthwhile to explore optimal configurations at the earliest stages of product development.

Despite the importance of performing optimization early in the design cycle, it has a place later in the design process as well, where the engineer can use it to help fix problems or improve individual features.

The CAD and analysis connection for optimization

Everything discussed above refers to FEA-driven optimization—and very often FEA is dependent upon the CAD program in which the design has been created. The CAD system is very important to optimization as well, because the method of creating models, dimensioning schemes, and embedded relationships affects the designer's ability to explore design alternatives.

As the engineer creates his models, he should consider dimensioning that allows features that have previously benefited from optimization to be modified without causing any model rebuild errors.

For optimization, planning is critical. A designer may discover benefits in creating a CAD model to be used exclusively for optimization, and then use the information gathered from the process to complete a CAD model for detailing and production. The complexity of the part and of the structure should guide him in choosing the features to study.

Getting the most out of optimization

Engineers planning to use optimization as a tool for improving designs and products need to clear their minds of any preconceived ideas of what constitutes "optimal." Much more can be derived by letting the optimization program provide insight, and then by understanding the various implications of the data.

The open-minded designer may find that the optimization tools offer several possible solutions to the problem, solutions that need to be considered in light of manufacturing needs and efficiencies to obtain the best and most profitable product at the end of the day.

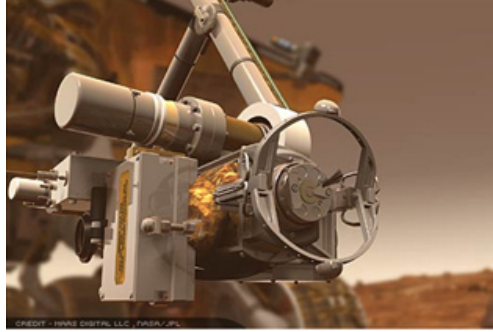

FIGURE 8:
ROBOTIC ARM FOR NASA'S MARS EXPLORATION ROVER (MER) MISSION

Engineers planning to use optimization as a tool for improving designs and products need to clear their minds of any preconceived ideas of what constitutes “optimal.”

Success with optimization

Alliance Space Systems

Alliance Space Systems, Inc. (ASI), Pasadena, California, designs and manufactures mechanical systems, robotics, structures, and mechanisms for spacecraft and scientific instruments. Most notably, ASI created the robot arms used on the highly successful *Spirit* and *Opportunity* rovers developed by NASA for the Mars Exploration Rover (MER) mission.

ASI used integrated SolidWorks Simulation software to test and optimize the design of parts and assemblies. “We were searching for every gram of weight, every millimeter of space,” says Brett Lindenfeld, director of engineering at ASI. “Because our analysts had used SolidWorks Simulation for stress and thermal analysis, they were able to backstop our designers and collaborate efficiently to optimize the design. The team was able to reduce the mass of the robotic arm by 20 percent, the automotive equivalent of the space needed for a car engine and transmission, while keeping rework to less than one percent. We were fast but still produced a higher quality, more innovative design.”

Kadant Johnson

Kadant Johnson (formerly The Johnson Corporation), Three Rivers, Michigan, designs and manufactures advanced process control systems, rotary joints, syphon and heating systems, and related components for fluid and heat transfer equipment used in process industries. Alan Ives, director of product development, and his team were challenged to optimize the design of a rotary joint and syphon assembly used in the dryer section of high-speed papermaking machines. Refining an already solid design using hand calculations and existing FEA software would have been too time-consuming to undertake. The team needed a new engineering solution to save time and gain greater return on the design investment.

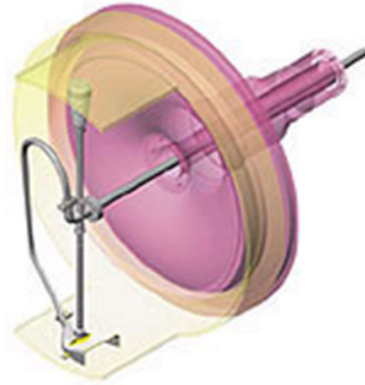

FIGURE 9:
SYPHON ASSEMBLIES WERE OPTIMIZED AT THE JOHNSON CORPORATION.

The company used SolidWorks Simulation to analyze and optimize each of the component parts, and tracked more concepts in a reasonable amount of time, and with fewer design iterations. The result was a stronger, more durable, and lighter assembly developed in a fraction of the normal development time. "We found SolidWorks Simulation to be a very robust package. It helped us achieve all of our design objectives, on schedule," Ives relates. They achieved a 40 percent to 50 percent weight reduction on each of three projects and were able to correlate the predicted response to physical testing. "That reduction is a direct result of using SolidWorks to optimize the design," he adds.

Conclusion

Design optimization can increase the value of a product by improving its performance within its operating environment, and by reducing the cost of producing it by reducing the amount of material used to make it. By employing optimization, the design engineer will increase his knowledge of his product's behavior and improve upon the design.