

High
Efficiency
Solutions.

CAREL

Solutions for air humidification and evaporative cooling

[carel.com](https://www.carel.com)

Control Solutions and Humidification Systems for HVAC/R



high efficiency solutions

Can protecting the environment be reconciled with our industrialised society? Yes, today this is possible.

Indeed, this is the concept of sustainable development: improving the quality of the life, without overloading the supporting ecosystems that it depends on, now made possible by progresses in technology.

While until recently sustainable development was simply a desire, a cost and an obligation defined by legislators so as to bequeath a healthy planet to future generations, today it is the only plausible choice. Changing public awareness continues to focus on the more worthy companies, rewarding these with higher sales. A need has thus become an opportunity, a chance not to be missed to unite the need to develop products and services that save energy with the possibility to effectively reduce environmental impact.

To encourage sustainable development, many activities are underway as concerns both the environmental policies of individual nations and international organisations (above all the European Union), and specific research and development work.

Today, then, solutions to combat global warming and pollution, to live a sustainable existence, to make our cities more liveable and our factories more efficient and virtuous all exist: the technology is here.



CAREL has always developed and promoted evolved control systems, proposing innovative solutions in the HVAC/R sector. These are our "high efficiency solutions", a clear response for environmental protection through optimised and integrated control systems, capable of bringing significant energy savings and consequently reducing environmental impact. These are new solutions for the market, yet the choices made are still in line with our tradition: we have always invested in R&D, right since we first started business, and we continued to do so despite the global recession.

These cutting-edge control solutions are now available, and their full potential is ready to be exploited, to achieve an effective competitive advantage on the world scene and be rewarded by the market.

Using CAREL "high efficiency solutions" today means doing something concrete to contribute to protecting the environment. It means looking to the future with confidence.

Humidify... ...cool while saving

Humidification for comfort and industrial processes

Air humidity is an important parameter for personal comfort in residential and commercial environments; the right level of air humidity guarantees a sense of well-being and productivity in the workplace. In industrial processes, air humidity control is needed to ensure process stability, product quality and quite often compliance with standards in force. CAREL products respond to the needs of residential, commercial and industrial applications, with special focus on running costs and energy consumption. Other important features of CAREL solutions for air humidification are simple use and installation, and reliability to ensure continuous service.

Energy savings: evaporative cooling

Air can be effectively cooled by exploiting the evaporation of water atomised into very fine droplets: the change in state, from liquid to vapour, absorbs energy from the air, which is consequently cooled. Evaporation of 100 kg/h of water absorbs 69 kW of heat from the air, for power consumption of less than 1 kW!. In an air handling unit, the supply air can be evaporatively cooled and humidified (direct evaporative cooling, DEC). Alternatively, if the outside air humidity is already high, the exhaust air can be cooled by several degrees without limits in terms of humidity, as it is discharged by the AHU; this cooling capacity, using a heat exchanger, can be used to cool the incoming fresh air with an efficiency that depends on the heat recovery unit used, yet easily exceeds 50%! (indirect evaporative cooling, IEC). All this means lower unit energy consumption and smaller dimensions and capacity of the cooling coil and chiller.

To develop these sophisticated solutions, CAREL has fitted a complete and modern air handling unit in its research centre, to optimise performance in all operating conditions and hence offer customers solutions that are together efficient, complete and easy to use.



-30%

With our innovative solutions, we can guarantee considerable energy savings for cooling air in AHUs.

Applications	7
offices	9
industry and process	13
datacenters - evaporative humidification and cooling	17
hospitals and operating theatres	21
steam bath	25
Isothermal humidification	29
Immersed electrode humidifiers	31
Heater humidifiers	39
Gas-fired humidifiers	43
Centralised steam distributors	47
Accessories	51
Adiabatic humidification	53
Pressurised water humidifiers	55
Compressed air and water atomisers	61
Ultrasound humidifiers	65
Centrifugal humidifiers	69
Evaporative cooling	73
Atomisers - evaporative cooling	75
Water treatment systems	83
Water treatment	85
Sensors and protection devices	89
Sensors and protection devices	91

Applications





offices

The right level of humidity in rooms affects the level of comfort perceived by people and reduces the risk of respiratory illnesses. Humidification is generally required during the winter period, as heating systems "dry" the air, causing dry throat, chapped skin and lips and sore eyes.

Comfort depends on the relative humidity: in winter, even if there is fog outside (100% relative humidity), the building heating systems increase the temperature of the air to a comfortable level, around 20 °C. In this way, the relative humidity decreases to values even as low as 10-30%, which are perceived as dry air. Consequently the skin on the hands cracks and the same occurs on the lips. As well as being an unpleasant sensation, the nose and throat are "dry", thus favouring the typical illnesses of the winter period.

The best comfort level is obtained when humidity is controlled and maintained between values of 40 and 60% relative humidity. For this reason the humidification system is made up

of a humidity generator with controller connected to at least one room air humidity probe.

The dry air in the winter increases dust present in the air deriving from carpets and curtains and particles of skin that people lose. This causes problems for people with allergies or asthma, which can be reduced by a correct level of humidity in the air.

If you consider the effect of low humidity on objects, there are many examples. Low humidity causes breakage and cracks in wooden, paper and textile objects. Objects such as books, paintings on wood, canvas and paper, valuable wooden furniture can be badly preserved or even damaged by low relative humidity. Moreover, cracks may appear in parquet.

Low humidity affects the temperature perceived. In summer, perspiration cools the skin and makes the temperature perceived lower than it actually is. In heated environments during the winter months, dry air favours the evaporation of

water from the skin and therefore a lower temperature is perceived; consequently the thermostat is increased by 1-2°C in order to obtain a comfortable temperature.

Comfort and production
thanks to excellent humidity.
Well-being, health and office
objects are protected.



humiFog
"Pressurised water
humidifiers" p. 55



humiSteam
"Immersed electrode
humidifiers" p. 31



compactSteam
"Immersed electrode
humidifiers" p. 31

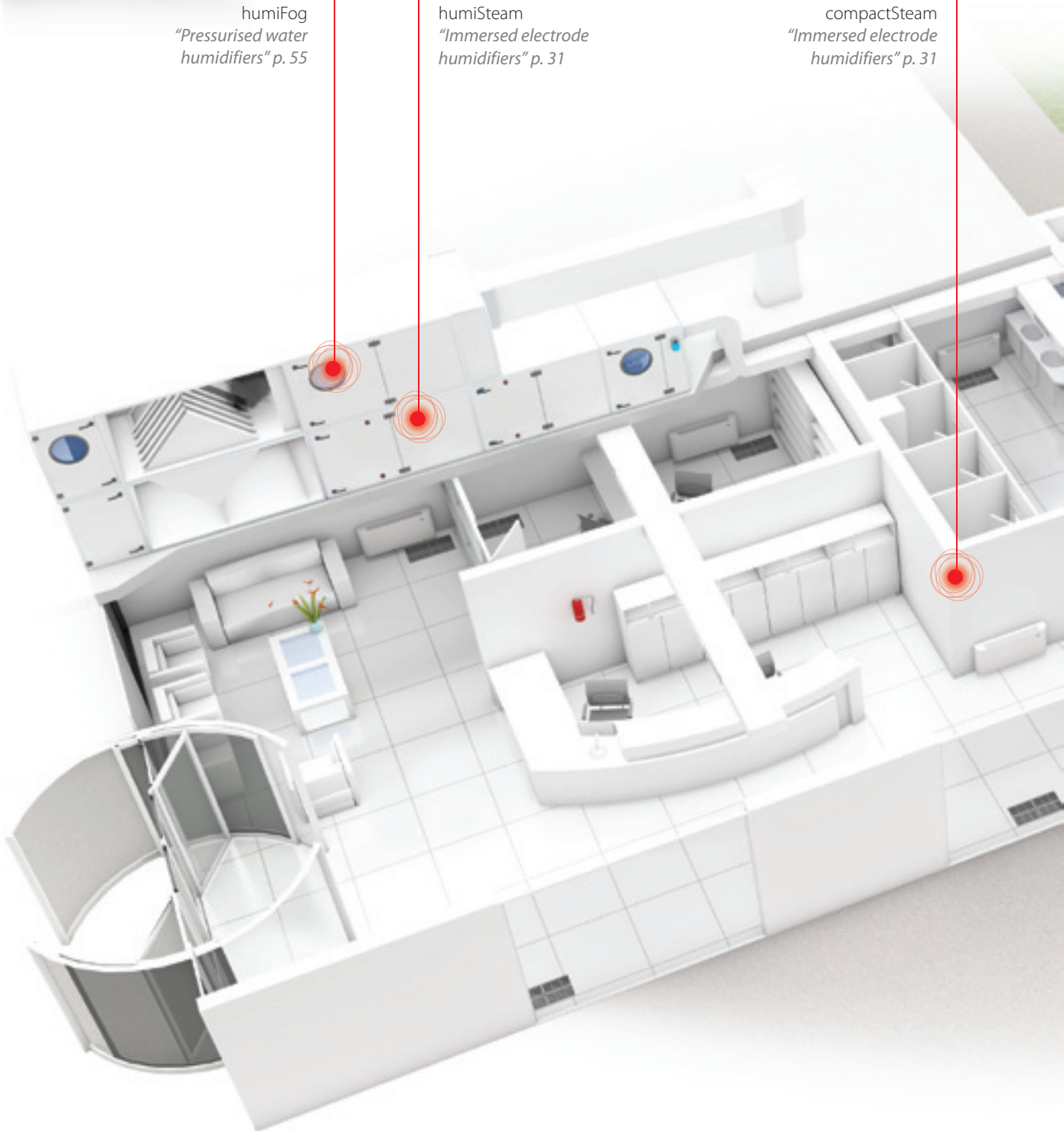



humiSonic
"Ultrasound humidifiers" p. 65

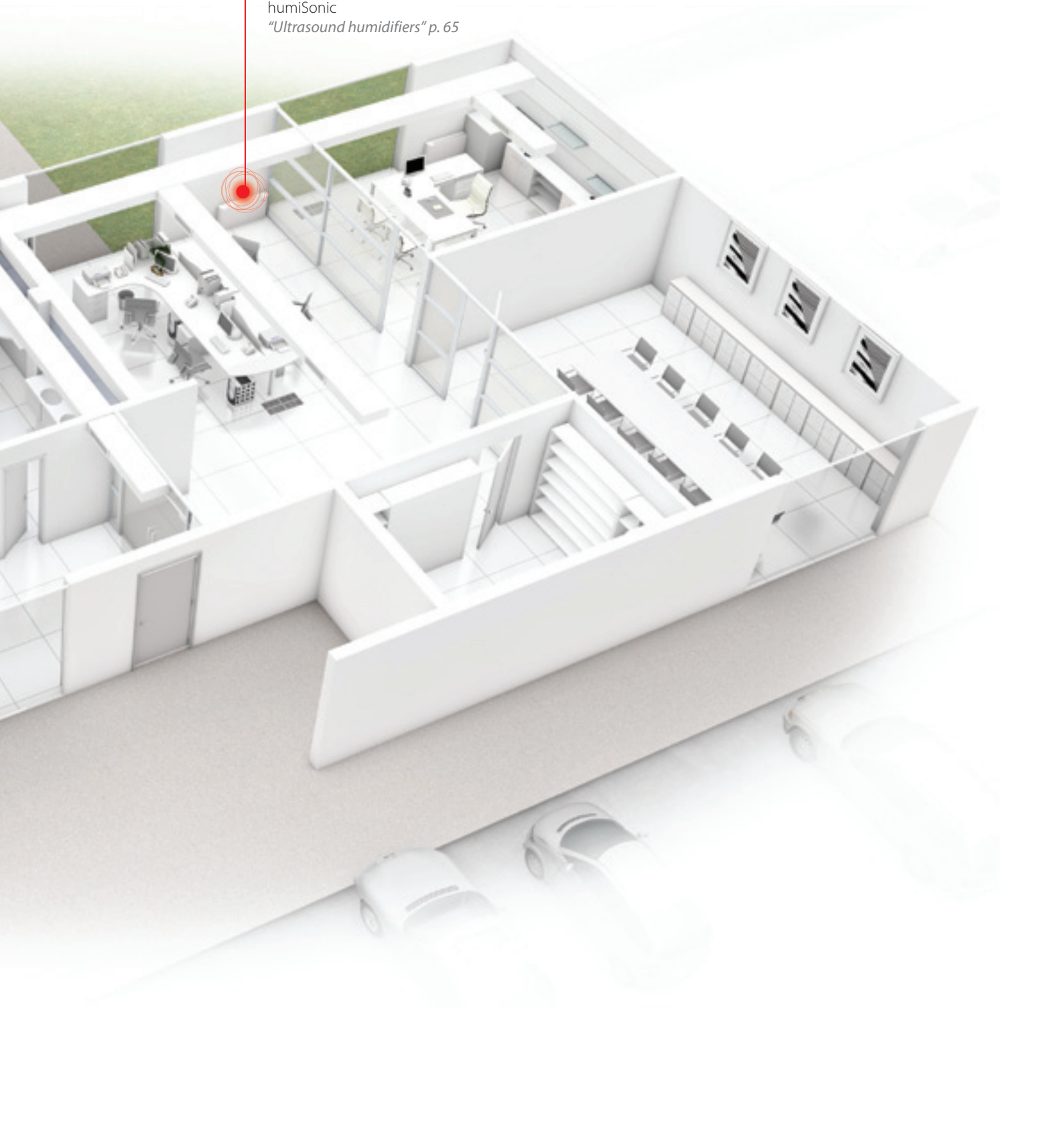



Maximum comfort with steam humidification

Steam generator humidifiers use an external energy source, electricity or gas, to take water to boiling point, thus producing steam. The choice of the type of energy depends on availability, cost and the investment necessary. The humidifier can use mains water; a solution that minimises the cost of the system but which requires periodical maintenance in order to remove the mineral salts that accumulate or, more simply, to replace the cylinders (humidifiers with electrode technology). Alternatively, demineralised water is used (except for electrode technology) so as to minimise system shutdown periods and maintenance costs. The steam produced by boiling is easily injected inside the air handling unit, requiring a small space for complete absorption. The space required can be reduced using latest generation products such as the ultimateSAM, fitted with nozzles that evenly distribute “dry” steam only. Alternatively, humidification can be applied directly in the environment with steam distributors fitted with fans, a simple method often used in existing systems, even in residential environments, with products such as compactSteam.



Comfort and energy saving with adiabatic humidifiers

Adiabatic humidifiers atomise (spray) very fine droplets of water, which are absorbed naturally by the air. Not producing steam, their characteristic principle is very low power consumption compared to “steam” humidifiers. These can also be used in the summer to cool the air: to give an example, using 1 kW of electricity it is possible to atomise up to 100 l/h into very small droplets that “absorb” 70 kW of heat from the air. These evaporative cooling systems are increasingly used in air handling units in order to cool with very low electrical energy consumption, with technical solutions used for dry and wet climates. Adiabatic humidifiers are also available for applications in fan coils (with ultrasound technology), on the wall or in false ceilings, representing a flexible solution also in existing installations.



Humidification system control

The control of the humidification systems and evaporative cooling systems is of fundamental importance. Using humidity and temperature probes, the integrated controller adjusts the capacity of the humidifier to reach the humidity set-point, without exceeding with humidification in AHU (humidity limit probe), in proportion to the flow of air handled (proportional signs), only when ventilation is running (flow switch inlet) and with temperature limits /temperature limit probe). The humidifiers must be easy to integrate into air-conditioning unit and AHU control systems, in a way to contribute with the optimisation of system performance. Connectivity and availability of communication protocols acquire increasingly more importance.



Humidifier hygiene

Humidification systems must contribute to the comfort of environments by only introducing hygienically safe moisture into the air. For this reason, isothermal humidifiers are available, which produce steam internally via the boiling of water, thus obtaining intrinsic hygienic safety. Adiabatic humidifiers obtain a very high hygiene level by using demineralised water, compatible materials (stainless steel, quality plastics used for food-stuffs) and operations such as automatic

periodical washing cycles. Thanks to all this, hygienically safe “humidity” is generated without the need to use very expensive and pollutant biocide additives, as attested by the certification obtained with respect to the VDI6022 standard “Hygienic standards for ventilation and air conditioning systems, offices and assembly rooms”.

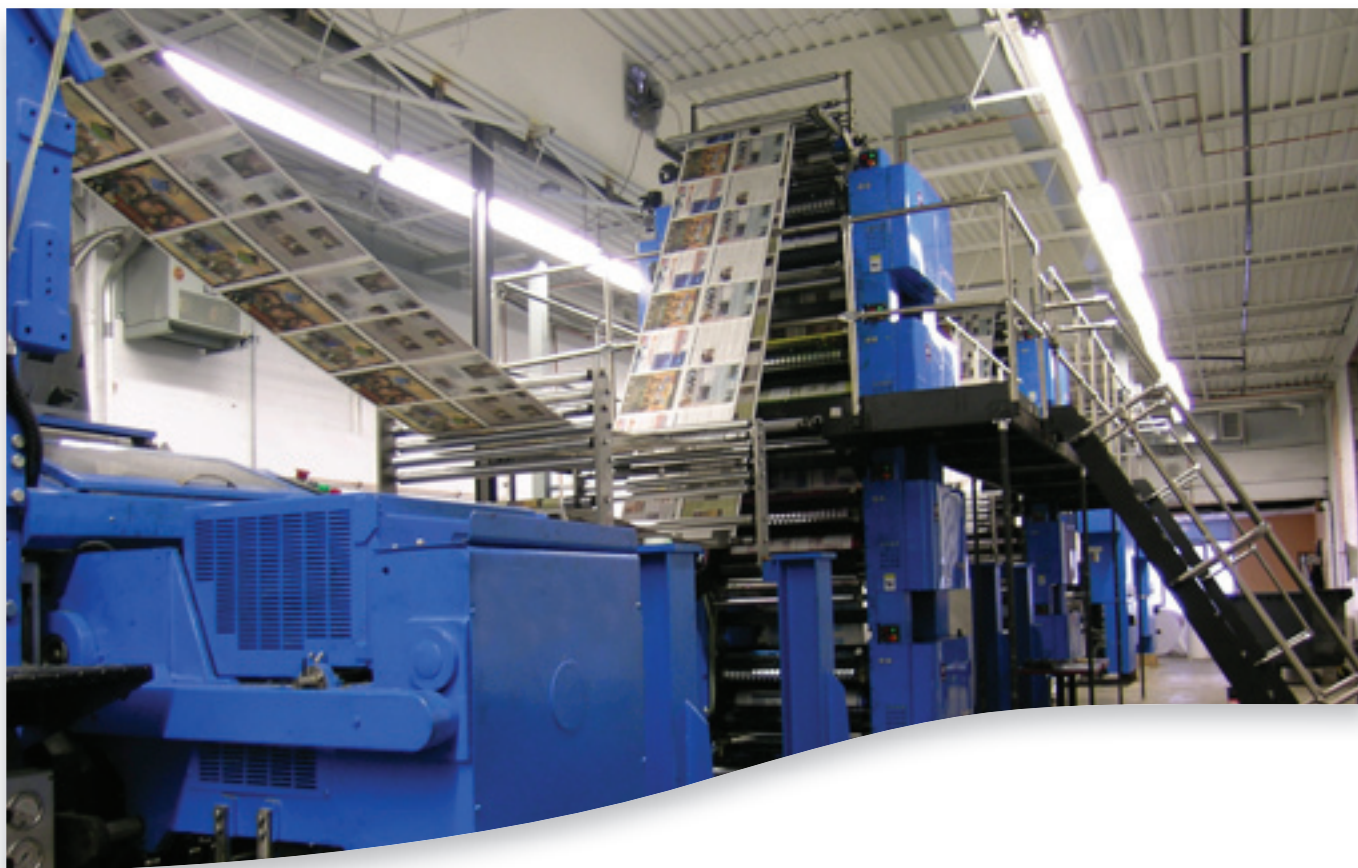

industry and process

What is humidity?

Humidity is nothing more than airborne water vapour.

Relative humidity is the percentage of water in the air at any given temperature (e.g. 50% RH at 20 °C) with respect to the maximum quantity that the air can hold at that temperature (100% RH at 20°C). The need to humidify the air usually occurs in winter months, when the outside air is cold and humid, for instance -5°C, 90% RH, and is heated in industrial environments at 20°C with a relative humidity that is lowered to 15% RH. As a result, the air can seem "dry". Even an air-conditioning system or a refrigeration system can "dry" the air, in that they work by cooling the air until it is below dew point, removing humidity (dehumidification). In both cases, where the result is dry air, a phenomenon occurs whereby a balance is created between air humidity and the objects within that environment, which tend to lose moisture content to evaporation.

There are well-known effects on materials:

- dimensional and qualitative variations on hygroscopic materials made of plant fibres such as paper, fabric, wood, etc.;
- weight loss and aesthetic deterioration

of fresh produce such as fruits and vegetables stored or displayed on counters;

- the presence of static electricity results in occurrences of discharges and electrostatic attachment;
- decrease of physical well-being and comfort of personnel, drying of the body's respiratory tracts that increases vulnerability to typical seasonal wintertime illnesses.

Adiabatic humidifiers atomise water into very fine particles that spontaneously evaporate into the air absorbing heat and thereby cooling the air. In factories that produce a lot of heat, such as steel mills, an adiabatic cooling system increases the comfort of workers and therefore their level of concentration, lowering the rate of errors and raising productivity.

Humidifying systems must contribute to a healthy environment by introducing only hygienically safe moisture into the air. For this purpose, there are steam and adiabatic humidifiers available that use materials and devices to produce "humidity" safe enough as to obtain certificates such as the well-

known VDI6022 "Hygienic standards for ventilation and air-conditioning systems, offices and assembly rooms".

Productivity, quality and energy savings in production and storage processes thanks to humidity control.

An increasingly important standard in industrial production.

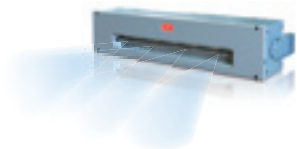

Ventilated distributors
"Pressurised water humidifiers" p. 55



humiFog multizone
"Pressurised water humidifiers" p. 55



WTS
"Water treatment" p. 85

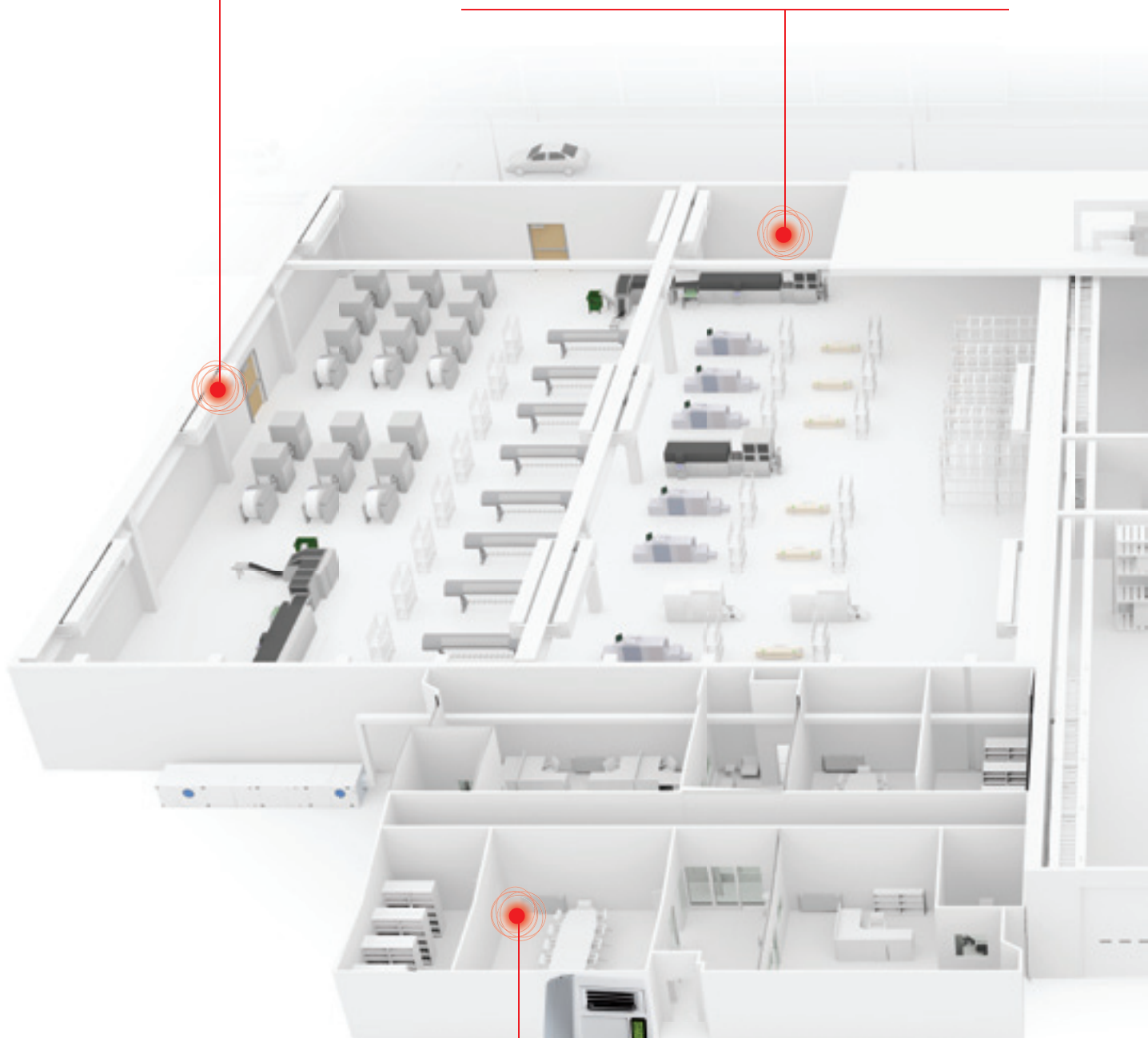

humiSonic
"Ultrasound humidifiers" p. 65



compactSteam
"Immersed electrode humidifiers" p. 31



optiMist
"Atomisers -
evaporative cooling"
p. 75



ChillBooster
"Atomisers - evaporative
cooling" p. 75



mc multizone
"Compressed air and
wateratomisers" p.61



humiDisk
"Centrifugal humidifiers" p. 69

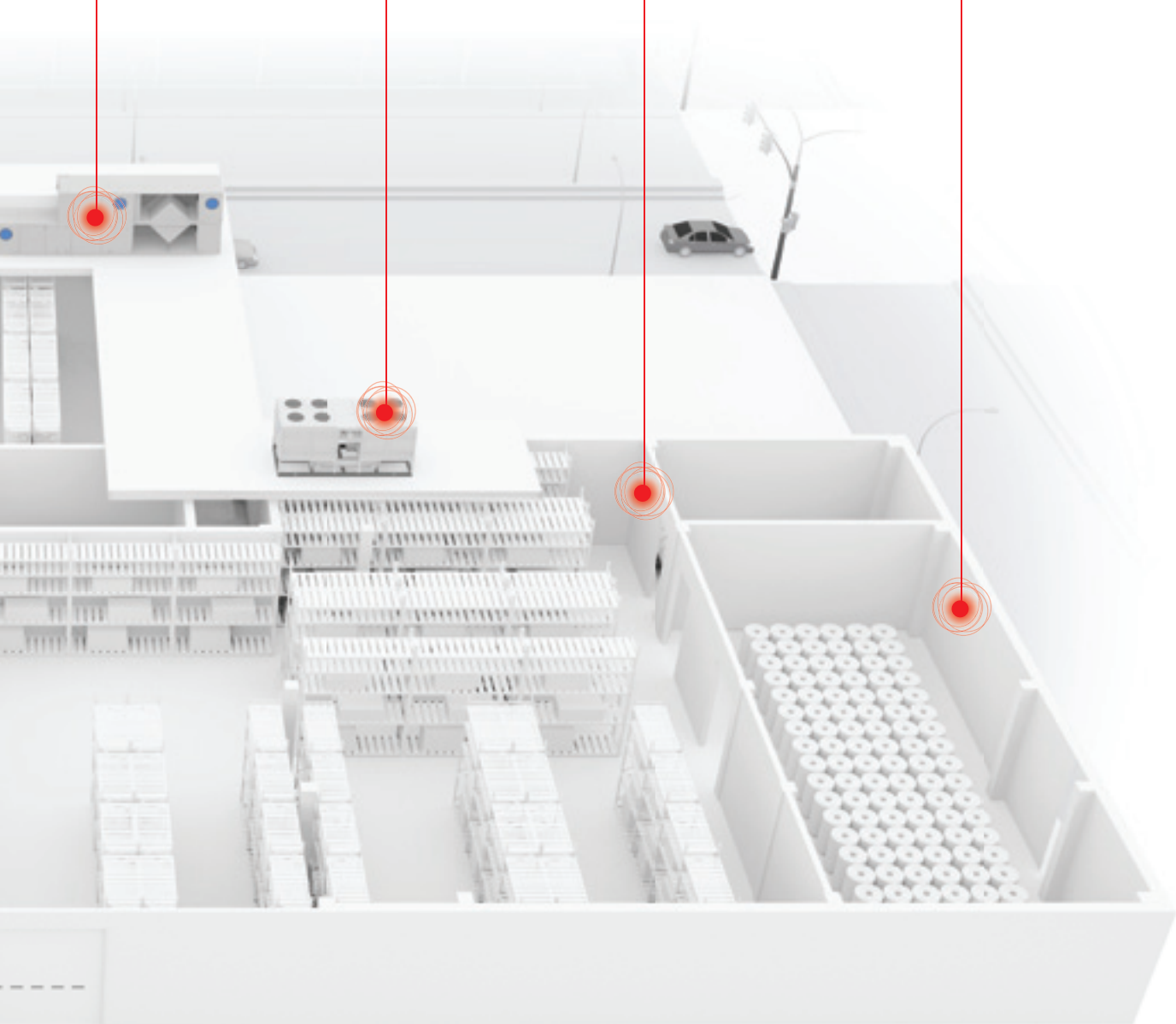

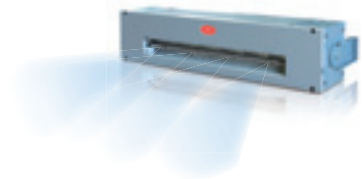

Quality and productivity for the printing industry

Paper is made from plant fibres (cellulose) and is a hygroscopic material: during the cold season, because the heat generated by machinery and by the heating system dries the air, the moisture content in paper decreases, producing changes in the size and in the technical characteristics of the paper. The length of a sheet of paper varies between 0.1 and 0.2% if the humidity varies in a 10% RH range: in a standard 16 page sheet in A4 format the change can be upwards of 2 mm! In ideal conditions, for paper storage and printing, relative humidity should be maintained between 50% and 60%.

A humidity control system:

- reduces printing misalignments due to dimensional changes in the paper;
- limits breaks and tears of the paper during automatic feed;
- avoids undulation and wrinkling;
- minimises electrostatic discharges and electrostatic attachment;
- optimises ink absorption.

Humidifying and Energy savings

The printing industry uses notable levels of humidification because the processing and storage plants are large, and often have high loads to manage. Adiabatic humidification is an excellent solution to obtain a correct and stable level of air humidity and to absorb sensible heat generated by process machinery. For instance, 100 kg/h of atomised water absorbs approximately 70 kW of heat while consuming only 1 kW of electricity: an advantageous humidifying system that uses a renewable resource: water.

A solution for every application

Humidification in the printing industry is obtained with electric or gas-fired steam generators, which move the air flow into the air handling unit or directly into the factory with blowers located inside the processing space. Adiabatic humidification and evaporative cooling are obtained by installing a rack with nozzles inside the air handling unit, with nozzles distributed in the area being air-conditioned, often located around the printing machinery where the need for humidification is at its highest. For small plants there are centrifugal adiabatic wall humidifiers available that are easy to install.

Humidification and evaporative cooling

These have remarkable advantages in many industrial applications in terms of product quality, productivity, energy savings and operating costs.

Cold rooms, food industry

Humidification systems compensate for the humidity that is condensed in refrigerating system evaporators; if this did not happen, the air would dry out rapidly causing a deterioration of the products and loss in weight.

Tobacco industry

Dry air causes the tobacco leaves to shrink with a consequent loss in weight and increase in fragility. This leads to cracks in the leaves that are used to produce tobacco, cigars, cigarettes and causes obstructions during the paper feed into the machinery.

Ageing of wine

Wine producers have always incurred significant losses in their barrel cellars due to low air humidity levels which favour the evaporation of wine through the wood of the barrels. A humidity level of 80% RH, or higher, lowers losses due to spontaneous evaporation.

Microelectronics and pharmaceutical cleanrooms

Relative humidity is one of the fundamental criteria for the operating conditions of a cleanroom with very strict tolerance limits, often $\pm 1\%$ RH; this affects the risk of electrostatic discharge, the speed of chemical reactions, capillary action, etc.

Paint and varnish rooms

The automotive and aeronautical industries use water-based varnishes that require strict control over ambient temperature-humidity conditions.

Special humidifiers with silicon-free certification are available to avoid fish-eye defects.

Museums, art galleries, archives

Correct ambient stability is essential to preserve works of art and objects over time. If canvases were to change dimensions over time due to variations in relative humidity, paintings would be irreversibly ruined, as would books, wooden works or art, paintings on wooden surfaces, etc.

Textiles industry

The right humidity level minimises breaks in thread as well as dust produced as a result of chafing, eliminates static electricity and adhesion and therefore increases the productivity of the machinery.



datacenters - evaporative humidification and cooling

The need to humidify datacenters is due to the possibility that the accumulation of static electricity can damage the electronic components in the computers when discharged. The risk is much greater when the air is "dry", i.e. low humidity. The physical explanation of the phenomena is that levels of humidity exceeding 40% produce a very fine film of liquid on surfaces, which is invisible to the naked eye, but which discharges any electrostatic charges produced to earth and thus prevents the accumulation of the electrostatic charges, which can be dangerous. Moreover, the liquid film reduces friction due to rubbing and therefore the generation of electrostatic charges.

Low humidity levels are frequent in datacenters due to the generation of heat by the electronic equipment, which have several kW power per square metre of floor plan. By heating the air the relative humidity decreases, thus increasing the generation of static electricity.

There are various types of datacenters, which are characterised by their size and also the configuration of the air-conditioning system. The most traditional are systems with server positioned in

the centre of the environment and air-conditioning units positioned around the perimeter (Close Control Units - CCU), while the under-floor and the plenum or false ceiling are exploited for the air flow. In layouts with hot aisle and cold aisle, the servers are aligned in a way that they take in cold air from the cold aisle, heat it and then introduce it into the hot aisle. Air conditioning units are installed (in row cooling mode) at regular intervals along the series of servers for cooling. These take in the air from the hot aisle, cool it down and then introduce it into the cold aisle. The air-conditioning units can be direct expansion type, with outdoor condensing units, or water type with remote chiller unit. Datacenters are also appearing that make maximum use of the potential for freecooling, where necessary enhanced by a direct and indirect evaporative pre-cooling unit. Modular datacenters have recently been developed with containers that enclose the freecooling system, evaporative freecooling system, "mechanical" air-conditioning unit and the space that houses the server.

Humidity control minimises the risk of electrostatic discharges, thus guaranteeing service continuity. Evaporative cooling maximises energy saving in large datacenters.



Optimist
"Atomisers - evaporative cooling" p. 75



ChillBooster
"Atomisers - evaporative cooling" p. 75



KUE
"Immersed electrode humidifiers" p. 31

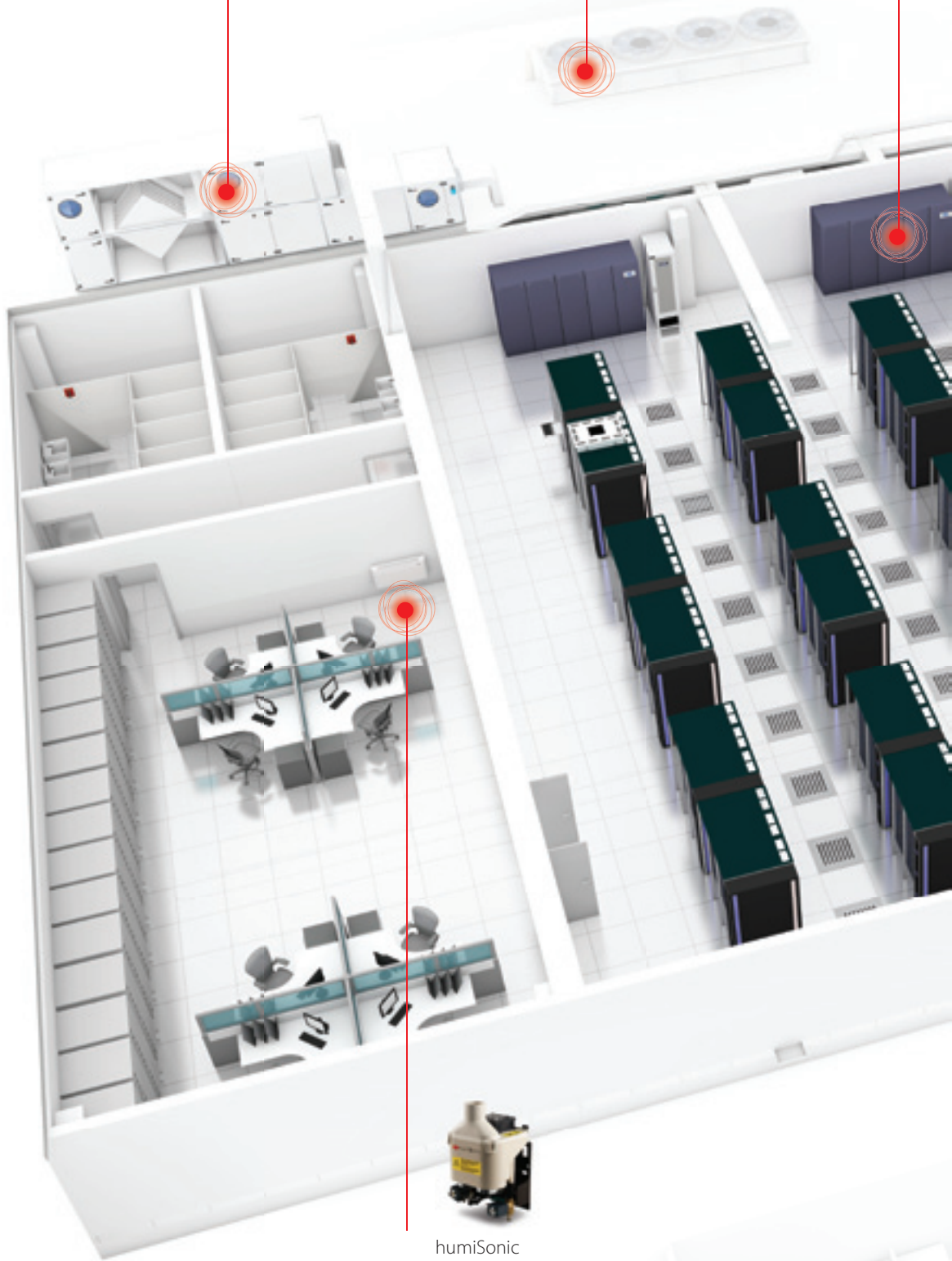

humiSonic
"Ultrasound humidifiers" p. 65



humiSonic
"Ultrasound
humidifiers" p. 65

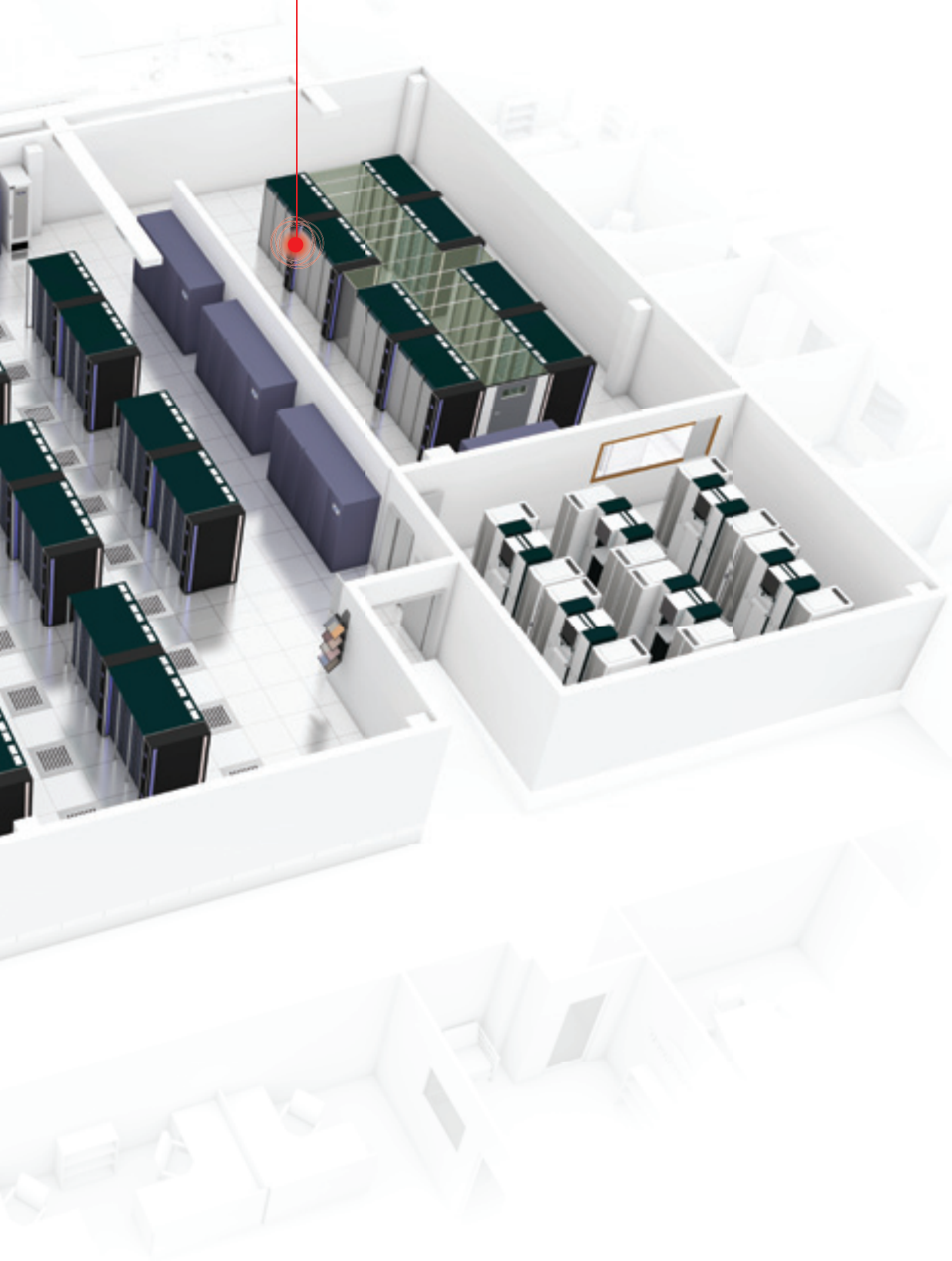

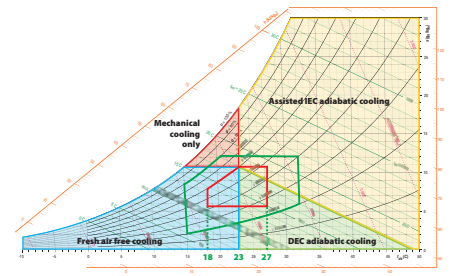
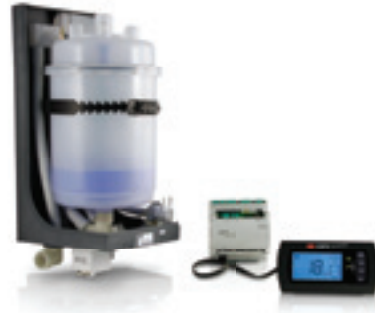

Evaporative humidification and cooling

Adiabatic humidifiers are used increasingly for evaporative cooling in datacenters. Most of the energy consumed in datacenters is due to the air-conditioning systems for the removal of the heat generated. The tendency for saving energy contributes to the diffusion of simple freecooling systems and those with evaporative cooling. In fact, considering that by atomising 100 l/h of water, a cooling capacity of 70kW is obtained for power consumption of 1kW, it can be understood immediately how advantageous this technology is. The maximum humidity limit in datacenters is normally high, up to 80% R.H. making evaporative systems an effective and efficient solution for energy saving and therefore for the reduction of running costs. Heat exchangers can also be profitably used. These allow development of freecooling systems with indirect cooling with the advantage of not having to introduce outside air into the room.

One solution for all applications

The datacenter humidification systems are introduced inside the room conditioning systems (CCU). These are typically immersed electrode units for the production of steam, which is rapidly absorbed by the air, even in very small spaces. In systems with air handling units, the humidifier is installed in an appropriate section and, if an atomising appliance, it is also used to obtain efficient evaporative cooling. Humidifiers and evaporative coolers are more increasingly used in containers/shelters for modular datacenters and telecom applications. Wall systems can be used in datacenters for local control of humidity: steam generator humidifiers are available with spray blowers and adiabatic ultrasound humidifiers, which humidify and cool the air.

Control and efficiency

The datacenters are divided into classes with much stricter limits allowed for the temperature and humidity the more critical the equipment contained and the continuity of the service requested. In all cases, control of the humidifiers and their integration with the air-conditioning system is essential in order to generate the amount of steam requested using just water and the minimum amount of energy. Efficiency is maximised by the further integration of direct and indirect freecooling systems enhanced by evaporative cooling.



hospitals and operating theatres

Low air humidity affects both health and well being of people. During the wintertime, the air inside buildings is heated to a temperature of 20-25°C with the consequence that relative humidity decreases to values of 10-30%, which is perceived as dry air, even if there is fog outside. The dry air favours the evaporation of water from the skin, which cracks and causes dryness of the throat and nose and the respiratory tract etc. favouring the onset of typical winter illnesses.

It is for this reason that air-conditioning systems that control both temperature and humidity of the air are used in hospital wards; the latter being maintained not too low but also not too high. To prevent propagation and proliferation of biological contaminants, the humidity should ideally be kept between 40% to 60%R.H.

Accurate control of the humidity also contributes to protecting the electronic equipment from electrostatic discharges, making the hospital safer for staff and visitors and protecting the health of the patient at the same time. Dry air in the winter increases the dust in the air deriving from pieces of material and particles of

skin that people lose. This causes problems for persons with allergies or asthma, which can be reduced by a correct level of humidity in the air.

According to European Directive 2002/91/EC, EN ISO 13790:2008, EN 13779:2008 VDI 6022, DIN 1946-4, Italian Presidential Decree dated 14 January 1997, UNI11425 (just to mention a few) ventilation and air-conditioning systems in operating theatres must ensure ideal temperature-humidity conditions for the work of doctors, also considering the patient's needs. The humidification systems must be designed in a way not to contribute to the production and spread of contaminants, be easy to access, clean and control. Emphasis is given to continuity of service, in particular in operating theatres: humidifiers are used that guarantee operating continuity and "do not stop" for maintenance.

Accurate humidity control is therefore not only an accessory, but a legal requirement.

Health, well-being,
safety and conformity
to standards with
humidification of the
departments and operating
theatres.



ChillBooster
"Atomisers - evaporative
cooling" p. 75



heaterSteam
"Heater humidifiers" p. 39



ultimateSAM
"Centralised steam
distributors" p. 47





humiFog
"Pressurised water
humidifiers" p. 55



heaterSteam
"Heaterhumidifiers" p.39



ir33+
ir33+ range for commercial
refrigeration





Guaranteed hygiene with steam humidification

The isothermal humidification process consists in the introduction of steam, generated by boiling water, into the environment. The steam can be generated locally, making use of electricity or gas. The choice of the source of energy depends on availability, both of the system and peak power requested and also the cost. The type of water to be used must not be underestimated: mains drinking water is surely suitable, but it leads to periodic humidifier shutdown for maintenance. This essentially consists in the removal of mineral salts that have accumulated during boiling. Using demineralised water means maintenance is minimised and operating continuity is guaranteed; it is however more expensive. The steam generator humidifiers guarantee maximum hygiene safety because the temperature of the steam ensures it contains no potentially noxious microorganisms. For this reason, it is good practice to use the steam humidifier in operating theatres, as well as it being explicitly requested by Law in some countries such as Austria.



Humidification and energy saving

During the adiabatic humidification process, water is atomised into very small droplets, which are introduced into the air where they evaporate spontaneously, thus humidifying it. The heat necessary for vaporisation is not supplied by external sources, but rather by the air itself, which is cooled. The power required by adiabatic humidifiers is therefore rather modest and lower than for isothermal units: a reduction in running costs is obtained, along with the necessary power installed. On the other hand, the adiabatic humidification must be generated with hygienically safe systems, i.e. using demineralised water, construction materials and techniques that do not favour stagnation and proliferation of bacteria. Moreover, they must be easy to maintain, clean and inspect. All of these features can be found in humiFog, which has obtained VDI6022 certification, "Hygienic standards for ventilation and air-conditioning systems, offices and assembly rooms" and DIN1946 certification. For this reason its use in hospitals is increasing. In Italy, refer to "Guidelines for the definition of technical preventive maintenance protocols on air-conditioning systems" - Official Gazette no. 256 dated 3 November 2006, which essentially implements VDI6022



Steam humidification efficiency

In hospital applications, humidification is often obtained by making use of centralised steam, which is distributed through pressurised pipes to be used in many ways in hospital activities, including sterilisation. The ultimate SAM is a humidification system that makes use of a source of clean steam, at atmospheric pressure or pressurised, and evenly distributes it into the flow of the air handling unit in order to favour absorption in a short distance. Energy and water savings are obtained thanks to air pocket insulation of the steam distributors: steam condensation is minimised and therefore also the waste of energy and water. Steam humidification is good practice in hospital applications, in particular in operating theatres as it is inherently safe.



ir33+

Range of electronic controllers for stand-alone refrigeration units, natural evolution of the ir33 range. These technologically advanced and user-friendly products have been designed with particular attention to detail and energy saving as well as guaranteeing quality regarding hospital preservation, ir33+ is intuitive for the user, aesthetically pleasant and also guarantees notable energy saving. Particular attention has been paid to the user interface that is now in line with the most modern electronic instruments.

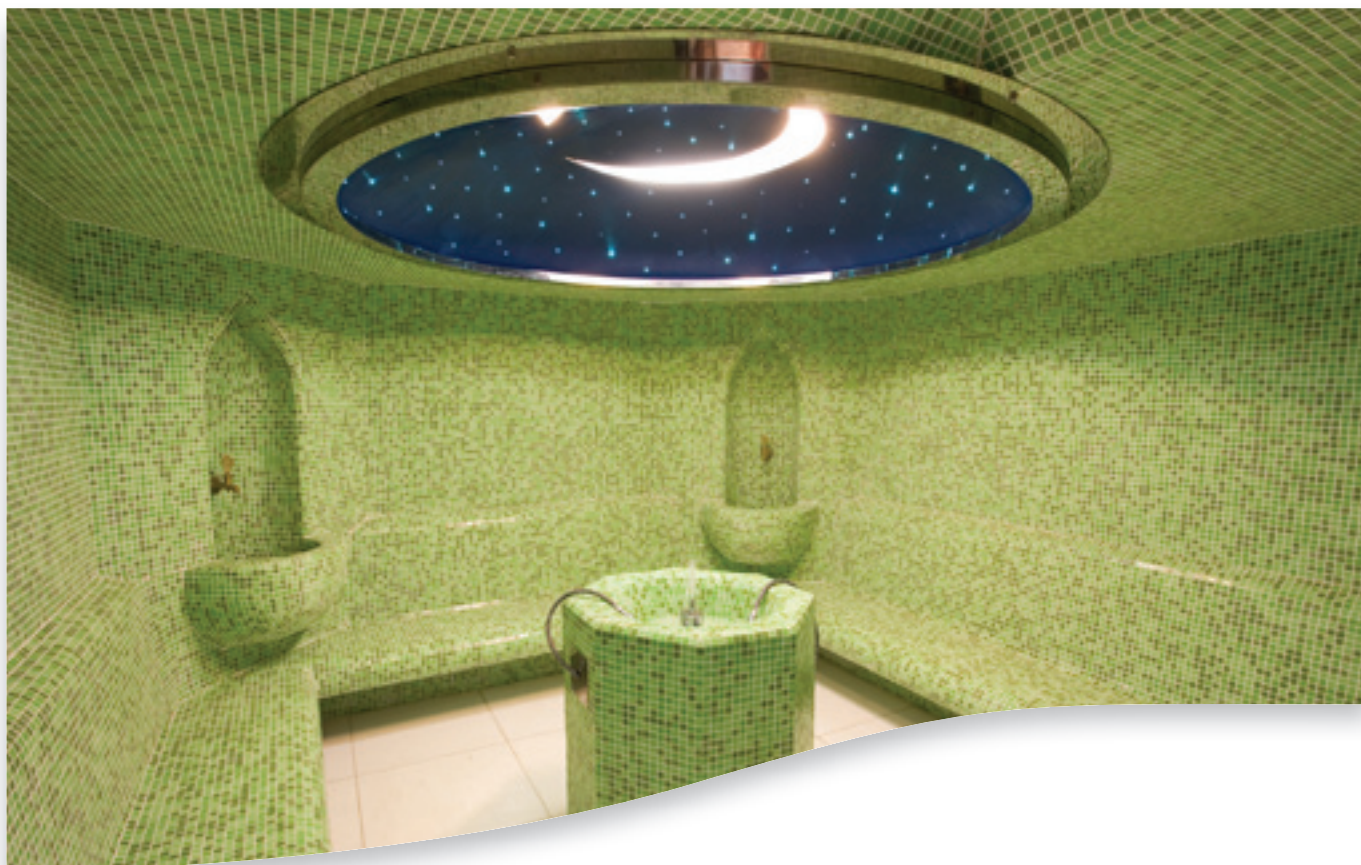

steam bath

The steam bath uses steam for purification treatments of the body through transpiration of the skin. The use of the steam bath, or hammam as it is called traditionally by the Moroccans, has been used since the times of the Ancient Greeks and Egyptians and, due to its purification properties and benefits, is also used today. The treatment takes place in a room with 100% R.H., which produces a mist with stratified temperature from 20-25°C at floor level up to 40-45°C at head height. With respect to the dry environment of the sauna, perspiration is less intense, but considering that the stay inside is longer, the amount of sweat transpired at the end of the treatment is clearly higher. The steam bath has several beneficial effects:

- thanks to natural perspiration, the skin is cleaned and purified deeply;
- it is excellent for the respiratory tracts;
- it favours vasodilatation and the circulation of the blood;
- it has a toning, relaxing effect that contributes to reducing everyday stress.

The applications are divided by dimension and use of the steam bath, from home to commercial/professional use, i.e. wellness centres, spas, gyms, hotels etc.

Steam humidifiers are the heart of steam baths: steam generators for creating ideal humidity and temperature conditions for the treatment desired. The humidifiers are used to generate steam and raise the temperature, maintaining it between 40 and 45°C with 100% relative humidity. The type of water available for the steam generator affects the periodical maintenance of the appliance: normal mains water leaves deposits of mineral salts during boiling, which must be periodically removed and which also cause unit shutdown. Even though the use of demineralised water is more expensive, the saline deposits are minimised thus greatly reducing unit shutdown periods for maintenance.

Essences, for example eucalyptus, are often added to the steam to further enhance the sensation of well-being during the session.

A natural purification treatment for psychophysical well-being:

- purification of the skin;
- simulation of blood circulation;
- relaxation from stress.



humiSteam Wellness
"Sensors and protection devices" p. 91



Active temperature/humidity probes
"Sensors and protection devices" p. 91



Steam nozzles
"Accessories" p. 51

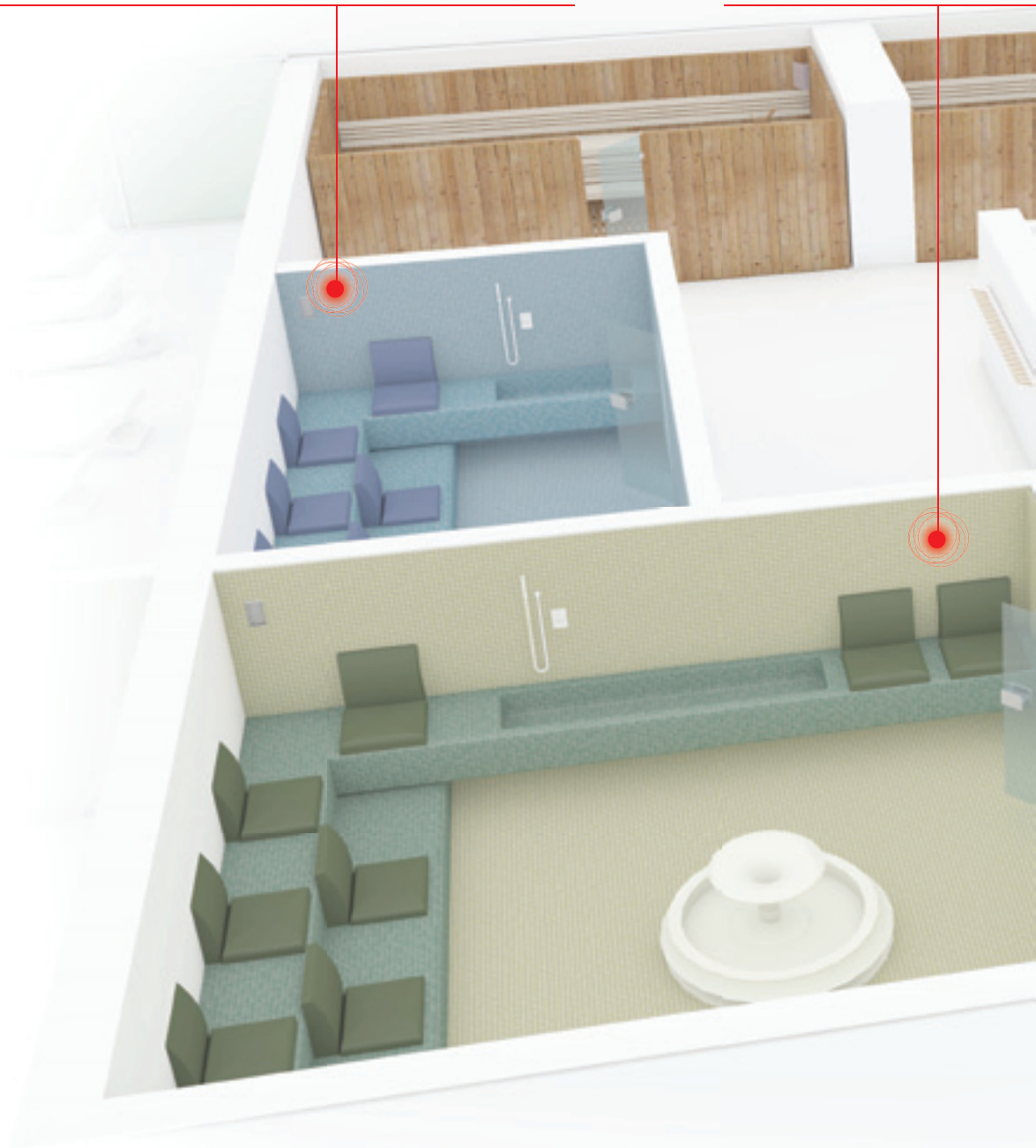



gaSteam
"Gas-fired humidifiers" p.43



UE "W" control
"Sensors and protection
devices" p. 91



humiSonic
"Ultrasound humidifiers" p. 65

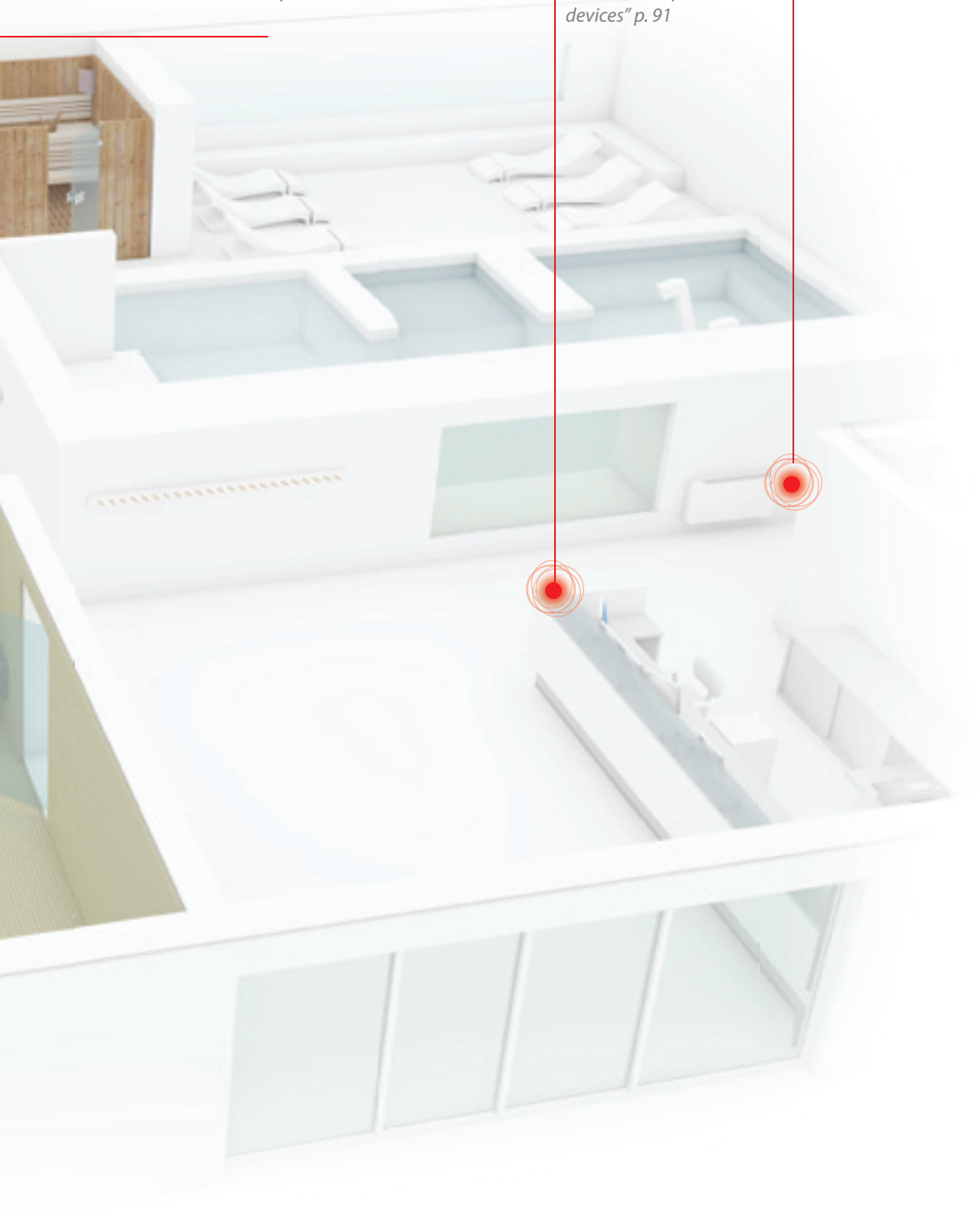



The ideal solution: humiSteam wellness

The humiSteam Wellness steam generator is a complete system developed especially to satisfy typical requirements of a steam bath application:

- steam generator with immersed electrode technology,
- steam bath temperature control;
- use of normal mains water and cleanable or easily replaceable cylinders;
- daily and weekly operating time periods with different temperature set points;
- management of 3 actuators for the distribution of essences and 1 for the "cleaning and disinfecting" cycle.
- management of 2 fans and light inside the cabin.

Moreover, the display-keypad unit can be separated from the humidifier and connected at a distance in order to facilitate use in the various applications, even for non-expert users.

Low maintenance steam bath: heaterSteam model "T"

heaterSteam, electric heater steam generator, is used in steam bath applications when humidifier maintenance is to be limited by using demineralised water instead of mains water. By minimising the deposits of mineral salts and the lime scale, unit shutdown for maintenance is also limited. Maintenance consists mainly in cleaning the heating elements, which are also available with a non-stick treatment. heaterSteam is more tolerant to the features of the supply water also if they change over time or according to the place of installation. The simple and reliable steam generator solution for steam baths.

Well-being and savings: gaSteam

Medium/large sized steam baths are often fitted with gaSteam steam generator humidifiers: the steam is produced thanks to the combustion of gas which, through a highly efficient heat exchanger, heats the water up to boiling point. gaSteam is generally supplied with demineralised water, thus minimising the deposits deriving from boiling and thus limiting the operations for cleaning the heat exchanger and guaranteeing running continuity; the latter is fundamental when used in a wellness centre, spas and hotels. Gas often represents a source of energy that is widely available at a much lower cost than electricity, so much so that in these cases gaSteam is the ideal solution for medium and large steam baths, whether they be for residential or commercial applications.

- 1 cleaning and disinfecting control
- 2 essence control
- 3 light control
- 4 fan control
- 5 remote control display
- 6 clock programming function

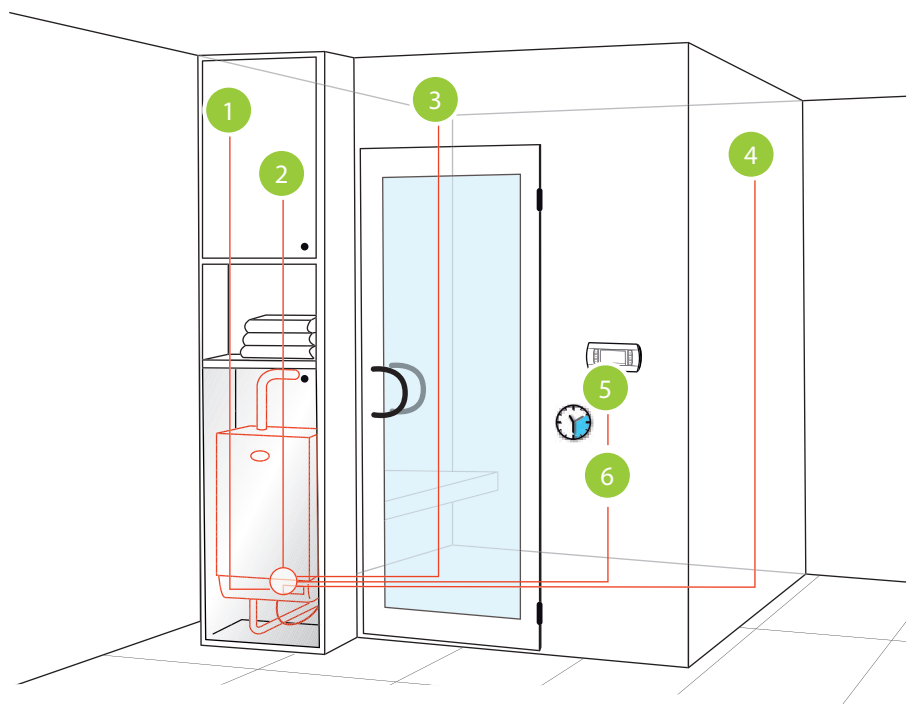

Isothermal humidification





Immersed electrode humidifiers

The operation of immersed electrode humidifiers is based on a very simple physical principle.

As common drinking water contains a certain quantity of dissolved mineral salts, and is consequently slightly conductive, applying a voltage to metal electrodes immersed in the water creates an electric current that heats the water until producing steam (Joule effect).

The quantity of steam produced is proportional to the electric current, which is in turn proportional to the water level.

This electric current is measured by a current transformer: by varying the level of water using a drain solenoid valve and due to the evaporation process, the current, and consequently steam production, can be modulated.

As the steam produced does not carry mineral salts, the salt concentration in the water and therefore the conductivity increases, and has to be periodically diluted by draining part of it using the drain pump and replacing it with new water.

In addition, lime scale is deposited over time and covers part of the cylinder, which must be replaced or cleaned.

Compared to electric heater or gas-fired humidifiers, immersed electrode humidifiers:

- are less expensive to purchase;
- operate with drinking water (not completely demineralised or softened);
- require periodical replacement (or cleaning) of the cylinder;
- feature modulation suitable for comfort or industrial applications, without extreme requirements.

CAREL has been manufacturing immersed electrode humidifiers since the 1970s and can draw benefit from its know-how in the field of electronic controllers: precision control, reliable electronics and sophisticated and complete control software.

The CAREL solutions for immersed electrode humidifiers are humiSteam and compactSteam.



humiSteam

UE*

humiSteam is suitable for installation in civil environments, offices, hospitals, industrial facilities, and steam baths. humiSteam is designed for installation in rooms, using the steam blower, and for installation in air ducts, using the new range of linear steam distributors. humiSteam works on mains water with a conductivity between 75 and 1250 $\mu\text{s}/\text{cm}$, and its control software automatically adjusts operation according to the characteristics of the water, so as to optimise operating life without maintenance.

The range of humiSteam humidifiers includes the following models

- humiSteam Xplus (X), suitable for all types of applications that require independent control with humidity probe, range from 1.5 to 130 kg/h;
- humiSteam basic (Y), ideal for applications in which the humidity is controlled by an external device, such as a BMS or a humidistat, with range from 1.5 to 65 kg/h;
- humiSteam "Wellness"(W) for steam baths, which features the same control electronics as the Xplus model.

Main pluses of this product:

- ease of use: all humiSteam models feature a large, simple and user-friendly alphanumeric LCD;
- reliability: all humiSteam models feature power connections that mean no tools are required when changing the cylinder, meaning more overheating due to less accurate maintenance;
- performance: the software makes the humidifier much faster to start and respond to variations in humidity demand. In addition, specific hygiene and safety functions are available (for example, the antifoam system), as well as a specific function for use with "problematical" water;
- connectivity: both the humiSteam Xplus (X) and humiSteam basic (Y) models offer the Modbus® RS485 connection as standard; in addition, the Xplus

high-end controller (deriving from the CAREL pCO family programmable controllers) includes a series of optional communication protocols and several advanced functions, such the possibility to program operation and set points according to daily and weekly time bands, event history (recording events and alarms with date and time) and the possibility of remote diagnostics via a GSM connection.

Advantages

- AFS system (Anti Foaming System): detects foam to prevent droplets of water being carried by the steam;
- cylinders with galvanised electrodes and anti-scale filter on the bottom; openable and fireproof cylinders are also available;
- steam production with continuous modulation from 20% to maximum rated output (from 10% for 90 and 130 kg/h models);
- built-in conductivity sensor and control software to optimise energy efficiency and operating life, with constant performance over the life of the cylinder.

Controllers

Three different types of controller are available.

"Basic"(Y) (1.5 to 65 kg/h)

Steam production is controlled by an external humidistat in ON/OFF mode (voltage-free contact) or by an external controller proportionally to demand (0 to 10 V, 2 to 10 V, 0 to 20 mA, 4 to 20 mA; fitted with RS485 interface using Modbus® protocol

"Xplus" (X) (1.5 to 130 kg/h)

Built-in controller based on pHc (technology pCO) with pGD:

- ON/OFF by external humidistat;
- proportional to an external signal (0 to 1 V, 0 to 10 V, 2 to 10 V, 0 to 20 mA, 4 to 20 mA);
- modulating based on an external signal from BMS or room humidity probe with configurable set point, plus a limit probe in the duct, where required;
- modulating based on the set point and temperature probe reading or signal from a BMS (Wellness model);

Other important features include:

- definition of daily and weekly time bands;
- connectivity via various types of LAN (e.g.: Modbus®, BACnet™, LON®);
- alarm log management;
- remote diagnostics via GSM (optional).

W controller

Same as the Xplus but for steam baths:

- definition of different temperature set points for different time bands;
- management of essences (3) and a "sanitation" cycle;
- management of fans (inside and exhaust) and inside light.

Features	UE001*	UE003*	UE005*	UE008	UE009*	UE010*	UE015*	UE018*	UE025*	UE035*	UE045*	UE065*	UE090*	UE130*	
General															
Rated steam production (kg/h)	1.5	3	5	8	9	10	15	18	25	35	45	65	90	130	
Power consumption (kW)	1.12	2.25	3.75	6.00	6.75	7.50	11.25	13.5	18.75	26.25	33.75	48.75	67.5	97.5	
Power supply (other voltages upon request) • 200, 208-230 Vac -15/10%, 50/60 Hz single-phase • 200, 208, 230 Vac -15/10%, 50/60 Hz three-phase • 400, 460, 575 Vac -15/10%, 50/60 Hz, three-phase	●	● ● ●	● ● ●	● ●	●	● ●	● ●	●	● ●	● ●	● ●	●	●	●	
Steam connection (mm)	Ø 22/30		Ø 30					Ø 40			Ø 2x40		Ø 4x40		
Outlet pressure limits (Pa)	-600 to 1500		-600 to 1300		-600 to 1350			-600 to 2000							
Number of cylinders	1					1							2		
Operating conditions	1T40 °C, 10 to 90% rH non-condensing					1T40 °C, 10 to 90% rH non-condensing									
Storage conditions	-10T70 °C, 5 to 95% rH non-condensing					-10T70 °C, 5 to 95% rH non-condensing									
Degree of protection	IP20					IP20									
Water fill															
Connection	3/4"G male					3/4"G male									
Temperature limits (°C)	1T40					1T40									
Water pressure limits (MPa - bar)	0.1 to 0.8 - 1 to 8					0.1 to 0.8 - 1 to 8									
Instant flow-rate (l/m)	0.6	0.6	0.6	1.1	0.6	1.1	1.1	1.1	5.85	5.85	5.85	7	14	14	
Total hardness (°fH) (*)	10 to -40					10 to 40									
Conductivity limits (µS/cm) (*)	75 to 1250					75 to 1250									
Water drain															
Connection	Ø 40					Ø 40									
Temperature (°C)	≤100					≤100									
Instant flow-rate (l/m)	7								22.5		45				
Blower															
Number	1										2				
Type	VSDU0A*								VRDXL*						
Power supply (Vac)	24								230						
Rated power (W)	37								35						
Rated air flow-rate (m3/h)	192								650						
Network															
Built-in network connection	UEX* and UEY*: Modbus®														
Optional network connections	UEX* and UEW*: RS485, BACnet™, LON®, Ethernet®, RS232 + GSM (optional)														
Controller	UEY* / UEX* / UEW*												UEX*		

● standard

Dimensions in mm (inches) and weights in kg (lbs)

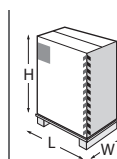
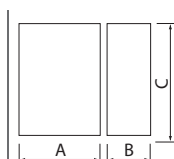

Model	AxBxC	weight	LxWxH	weight
UE001 to UE018	365x275x712 (14.37x10.83x28.03)	17 (37.48)	500x400x850 (19.68x15.75x33.46)	20 (44.09)
UE025 to UE045	545x375x815 (21.46x14.76x32.09)	34 (74.95)	665x465x875 (26.18x18.31x34.45)	39 (85.98)
UE065	635x465x890 (25x18.31x35.04)	44 (97)	750x600x940 (29.53x23.62x37.01)	51 (112.43)
UE090 to UE130	1150x465x890 (45.27x18.31x35.04)	70 to 74 (154.32 to 163.14)	1270x600x940 (50x23.62x37.01)	77 to 81 (169.75 to 178.57)

Unit code

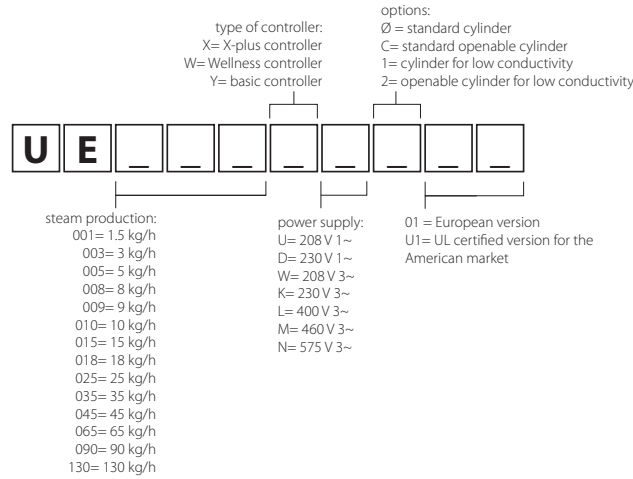

NB: not all the combinations of codes are available

OVERVIEW DRAWING humiSteam Y-X-W

room applications

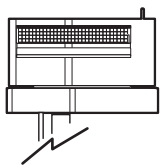

VSDU0A0001 & VRDXL0000: steam blower
VSDBAS0001: remote installation support for VSDU0A

duct applications

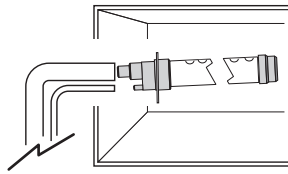

DP*: linear steam distributor (inlet Ø 22 mm, Ø 30 mm, Ø 40 mm)

steam bath applications

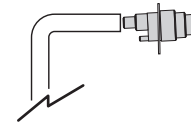

SDP*: plastic nozzle up to 18 kg/h steam

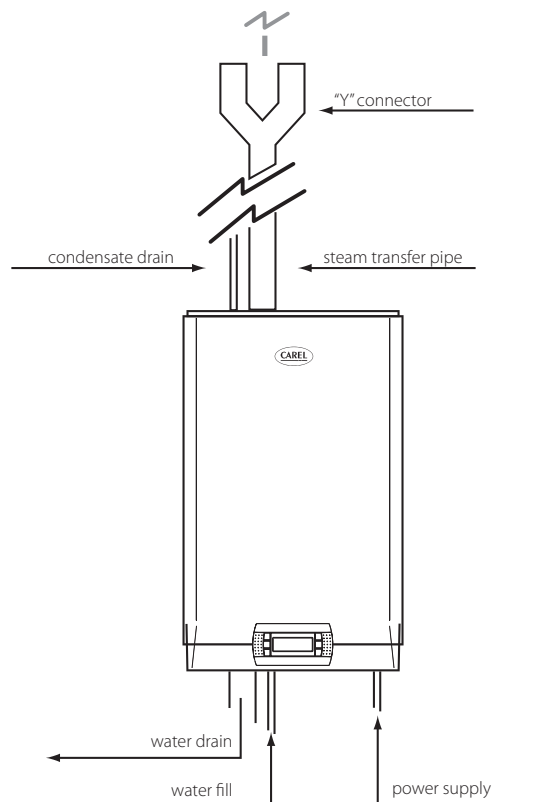

Probes



DPW*: temperature and humidity probe for civil environments



DPP*: temperature and humidity probe for industrial environments



ASET*: temperature and humidity probe for steam baths

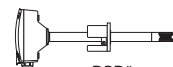

DPD*: temperature and humidity probe for ducts



NTC*: temperature probe for UEW



Cylinders

BL*

All CAREL immersed electrode humidifiers feature sophisticated control software that automatically adapts the operating parameters to the characteristics of the water; nonetheless, the optimum balance between cylinder life, variation in steam production and speed of response depending on the type of water and power supply can only be achieved by changing the shape and the position of the electrodes. For this reason, CAREL immersed electrode humidifiers today feature the widest choice of cylinders, with specific electrodes for water with conductivity between 75 $\mu\text{S}/\text{cm}$ and 1250 $\mu\text{S}/\text{cm}$, for capacities between 1 and 65 kg/h, and for power supply voltages between 208 V and 575 V.

All humiSteam cylinders feature galvanised electrodes and are fitted with filters to avoid formation of lime scale at the bottom, consequently preventing blockage of the drain.

Openable cylinders

The new humidifiers can be fitted with "disposable" cylinders made from non-flammable polypropylene, class HB according to UL94, or alternatively openable and therefore cleanable cylinders, made from class V0 plastic (UL94 standard).

The openable cylinders feature quick click-on closing, with a rubber gasket to ensure perfect water-tightness between the two parts of the cylinder.

Cylinders: quick snap-on connection

The snap-on connectors (A: click onto the specially shaped terminal on the electrodes) ensure:

- higher reliability, avoiding the risk of overheating due to incorrect tightening of the nuts when replacing the cylinder,
- quicker cylinder replacement times, as the connections can be made in just a few seconds, with no tools required.

For backward-compatibility with units

already installed in the field, two adapter kits are available, made up of snap-on connector, gasket and fastening screw that will initially be distributed together with spare cylinders (B):

- 98C615P004 quick connector adapter for eyelet lugs, 5 mm pin (BL0*1* and BL0*R*);
- 98C615P005 quick connector adapter for eyelet lugs, 6 mm pin (BL0*2*, BL0*3*, BL0*4*).



A



B

Disposable cylinder selection tables

humiSteam: single-phase 230 Vac (220 to 240 V)

	water conductivity		
	low	medium	high
Capacity kg/h	75/350 µS/cm	350/750 µS/cm	750/1250 µS/cm
1, 3 ridotto	BLOSRE00H2	BLOS RF00H2	
1, 3	BLOS1E00H2	BLOS1F00H2	
5	BLOS2E00H2	BLOS2E00H2	
9	BLOS3E00H2	BLOS3F00H2	

humiSteam: single-phase 208 Vac

	water conductivity		
	low	medium	high
Capacity kg/h	75/350 µS/cm	350/750 µS/cm	750/1250 µS/cm
1, 3 ridotto	BLOSRE00H2	BLOS RF00H2	
1, 3	BLOS1E00H2	BLOS1F00H2	
5	BLOS2E00H2	BLOS2E00H2	
9	BLOS3E00H2	BLOS3F00H2	

humiSteam: three-phase 460 V

	water conductivity		
	low	medium	high
Capacity kg/h	75/350 µS/cm	350/750 µS/cm	750/1250 µS/cm
3	BL0T1B00H2	BL0T1D00H2	
5, 8	BL0T2C00H2	BL0T2D00H2	
10, 15, 18	BL0T3C00H2	BL0T3D00H2	
25	BL0T4D00H2 (*)		
35, 45, 90, (2x)	BL0T4C00H2	BL0T4D00H2 (*)	
65, 130 (2x)	BL0T5C00H0	BL0T5D00H0	

humiSteam: three-phase 400 Vac (380 to 415 V)

	water conductivity		
	low	medium	high
Capacity kg/h	75/350 µS/cm	350/750 µS/cm	750/1250 µS/cm
3	BL0T1A00H2	BL0T1C00H2	BL0T1D00H2
5, 8	BL0T2B00H2	BL0T2C00H2	BL0T2D00H2
10, 15, 18	BL0T3B00H2	BL0T3C00H2	BL0T3D00H2
25, 35	BL0T4C00H2	BL0T4D00H2 (*)	
45, 90 (2x)	BL0T4B00H2	BL0T4C00H2 (*)	
65, 130 (2x)	BL0T5B00H0	BL0T5C00H0	

humiSteam: three-phase 208 and 230 V

	water conductivity		
	low	medium	high
Capacity kg/h	75/350 µS/cm	350/750 µS/cm	750/1250 µS/cm
3	BL0T1A00H2	BL0T1B00H2	
5, 8	BL0T2A00H2	BL0T2A00H2	
10, 15	BL0T3A00H2	BL0T3A00H2	
25	BL0T4B00H2	BL0T4C00H2 (*)	
35	BL0T4B00H2 (*)		
45	BL0T5A00H0	BL0T5A00H0 (BL0TSB00H0 e 230 V)	

humiSteam: three-phase 575 V

	water conductivity		
	low	medium	high
Capacity kg/h	75/350 µS/cm	350/750 µS/cm	750/1250 µS/cm
5, 8	BL0T2C00H2	BL0T2D00H2	
10, 15, 18	BL0T3C00H2	BL0T3D00H2	
25, 35, 45, 90 (2x)	BL0T4D00H2 (*)		
65, 130 (2x)	BL0T5D00H0		

Openable cylinder selection tables

humiSteam: three-phase 400 V (from 380 a 415 V)

	water conductivity		
	low	medium	high
Capacity kg/h	75/350 µS/cm	350/750 µS/cm	750/1250 µS/cm
3	BLCT1A00W2	BLCT1C00W2	BLCT1D00W2
5, 8	BLCT2B00W2	BLCT2C00W2	BLCT2D00W2
10, 15, 18	BLCT3B00W2	BLCT3C00W2	BLCT3D00W2
25, 35	BLCT4C00W2	BLCT4D00W2	
45, 90 (2x)	BLCT4B00W2	BLCT4C00W2	
65, 130 (2x)	BLCT5B00W0	BLCT5C00W0	

humiSteam: single-phase 230 V (from 220 a 240 V)

	water conductivity		
	low	medium	high
Capacity kg/h	75/350 µS/cm	350/750 µS/cm	750/1250 µS/cm
1, 3	BLCS1E00W2	BLCS1F00W2	
5	BLCS2E00W2	BLCS2F00W2	
9	BLCS3E00W2	BLCS3F00W2	

(*) for models UE 25, 35, 45 kg/h manufactured until October 2003 or with serial number less than 501,000, use the Y connector.

(**) as well as the voltages shown here, openable cylinders are available for the following voltages: 208 V single-phase, 230 V three-phase, 460 V three-phase, 575 V three-phase.

Important: on models UEH and UEP fitted with cylinders featuring an electrical bridge between two or more electrodes, the new snap-on data connectors cannot be used, as it is not possible to connect more than one cable to the same pin. On these units the spare cylinders retain the threaded pins and the same part numbers must be purchased. The following models of cylinder are affected: BLOS2F00H0, BLC52F00W0, BLOS2E00H0, BLC52E00W0, BL0T2B00H0, BLCT2B00W0, BL0T2A00H1, BLCT2A00W1, BL0T3B00H0, BLCT3B00W0, BL0T3A00H1 and BLCT3A00W1.



compactSteam

CH*

compactSteam is the CAREL proposal for the humidification of prestigious residential environments, professional offices or small and medium retail premises.

compactSteam is an immersed electrode humidifier, with following main features:

- elegant and discrete design, ideal for installation in any environment;
- built-in steam distributor, with adjustable louvers and very silent operation;
- large graphic LCD for straightforward understanding;
- market-leading functionality, safety and user friendliness;
- models from 1.6 to 5.4 kg/h;
- electrical and water connections can be completely concealed from view, and drain water temperature never exceeds 60 °C. In addition, if no humidification is required for more than 3 consecutive days, the water is automatically drained for maximum hygiene.

A version without built-in distributor is also available, for steam distribution in the duct, as well as a remote blower, which allows steam to be distributed in a different room from where the humidifier is installed.

Other features

- maximum capacity selectable in steps of 5%;
- 0 to 10 V proportional control and modulation from 20 to 100%;
- automatic management of water concentration and foam;
- remote enabling signal input and alarm relay;
- cylinder operating hour counter, resettable.

Control

The sophisticated microprocessor controller automatically manages all the functions of the unit, and includes a self-diagnostic system with simple and straightforward indications, both numeric and using icons, on the large LCD.

The controller includes an ON/OFF and proportional 0 to 10 V input, a remote enabling input, an alarm relay, an input for a flow sensor and a 24 V power supply output. Steam production is modulated continuously from 20% to maximum capacity, and water level is controlled by a solenoid fill valve and a drain pump.

The built-in fan is only on when steam is being produced, and is stopped with a delay to prevent condensation.

Room humidity control is managed by an external humidistat, for example Clima; this is powered by compactSteam and can manage the unit proportionally, for even more precise and comfortable humidity control.

compactSteam is available with or without steam blower, with capacities from 1.6 to 5.4 kg/h.

Dimensions in mm (inches) and weights in kg (lbs)

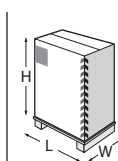
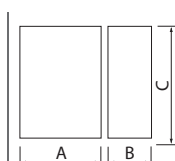

Model	AxBxC	weight	LxWxH	weight
CH001*	341x204x600 (13.42x8.03x23.62)	8 (17.64)	520x380x740 (20.47x14.96x29.13)	10 (22.05)
CH002*	341x204x600 (13.42x8.03x23.62)	8 (17.64)	520x380x740 (20.47x14.96x29.13)	10 (22.05)
CH003*	341x204x600 (13.42x8.03x23.62)	8 (17.64)	520x380x740 (20.47x14.96x29.13)	10 (22.05)
CH005*	341x204x600 (13.42x8.03x23.62)	8 (17.64)	520x380x740 (20.47x14.96x29.13)	10 (22.05)

Unit code

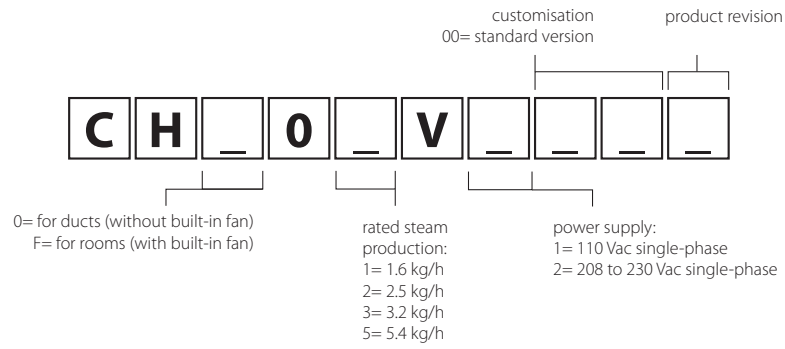

OVERVIEW DRAWING compactSteam

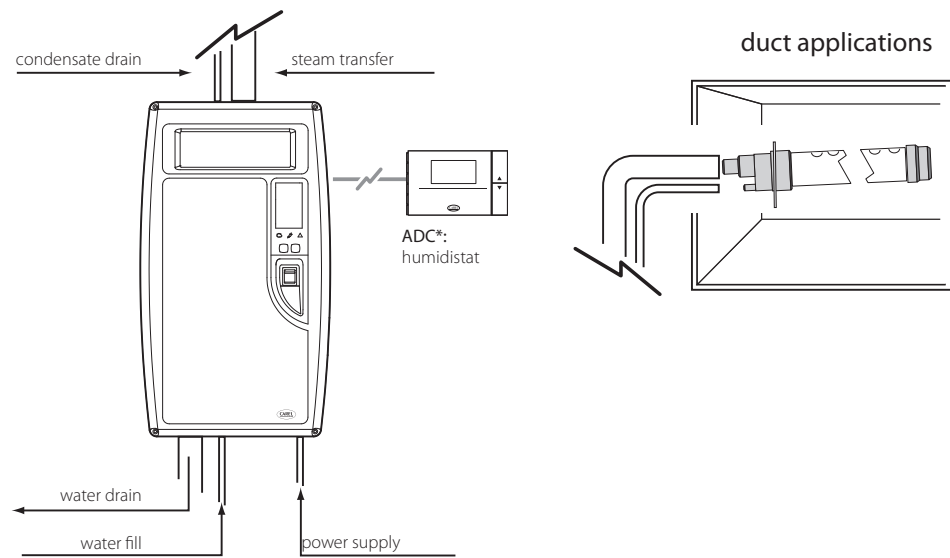



Heater humidifiers

Immersed heater humidification is becoming increasingly required in work specifications where:

- humidity must be controlled precisely (museums, laboratories, clean rooms);
- water quality is not constant or is problematic (for example, aboard ships);
- periodical maintenance needs to be minimised (using demineralised water).

Immersed heater humidifiers, unlike immersed electrode units, can operate on demineralised water, as they do not exploit the electrical conductivity of the water.

Periodical maintenance can therefore be greatly reduced, due to the minimum formation of lime scale.

Weighing against this, the resistive elements must always be completely immersed in the water, to avoid overheating, unlike the situation with electrodes, in which the water level is adjusted to modulate the flow-rate of steam.

The operation of an immersed heater humidifier then requires water level sensors to ensure complete immersion of the electrodes, as well as components (solid state relays) that adjust the amount of heat transferred to the water so as to precisely modulate steam flow-rate.

These characteristics make the heater units more complex than their counterparts with electrodes, yet independent of the characteristics of the water, and with much more precise modulation of the flow-rate. In addition, as heater humidifiers are intrinsically subject to overheating, the quality of design and the presence of safety systems are essential to ensure reliable service over time.

The CAREL solution in this market segment offers the maximum in constructional quality and performance, meaning excellent reliability over time and extreme precision of control for the more critical applications.



heaterSteam

UR*

The range of heaterSteam immersed heater humidifiers includes models producing from 2 to 60 kg/h of steam, and can operate on drinking water or demineralised water, which practically eliminates the need for maintenance. heaterSteam features exclusive and patented technological solutions, such as electric heaters embedded in corrosion-proof aluminium alloy casting with a large heat exchange surface, and built-in temperature sensors to prevent overheating. The temperature sensor has the dual function of protecting against overheating, for maximum reliability over time, and detecting excessive lime scale deposits amply in advance, so as to allow correct preventive maintenance.

Modulating control with solid state relays ensures high precision humidity control. For each capacity there are two variants: basic and full optional.

The full optional units, compared to the basic versions, have heat insulation around the boiler for maximum energy savings, and heating elements coated in non-stick material to facilitate the separation of lime scale.

In addition, a water temperature sensor is fitted for managing the useful preheating function, giving a rapid response whenever there is humidification demand.

All models have an automatic system for measuring supply water conductivity, which optimises management of the drain cycles without requiring analysis of the water in the installation. This function also means energy savings and a reduction in maintenance.

Models from 2 to 10 kg/h have a cylindrical stainless steel boiler, which is easy to remove for cleaning.

The heavier models, from 20 to 60 kg, have a stainless steel boiler with a rectangular base and large openings (front and top) for easy maintenance without having to remove the boiler.

Pluses of this product include:

- extreme precision, up to $\pm 1\%$ RH;
- electric heaters are embedded in a

corrosion-proof light alloy casting with a large surface area, guaranteeing perfect diffusion of heat and exceptional reliability over time (CAREL patent);

- temperature sensors inserted into the heating elements prevent any overheating, and detect well in advance the need for cleaning any lime scale deposits (patented method);
- heating elements coated with Niflon, a non-stick and corrosion-proof material (full optional models) are very easy to clean);
- models H and T, with solid state relays, allow continuous modulation of steam production starting from 10% of capacity, with very precise control; model C provides ON/OFF operation;
- the patented "Anti Foaming System" detects foam and prevents any droplets of water being carried with the steam;
- model H supports a limit probe to prevent any condensate forming in the duct (better hygiene!);
- in models H and T the preheating function allows a rapid response to the request for steam production;
- model H can also control an external dehumidification device.



Controllers

Three different types of control unit are available:

- C: ON/OFF controller;
- H: built-in humidity controller, with serial port for Modbus® networks via an external gateway;
- T: built-in temperature controller for stand-alone applications (for example, steam baths).

Type C: ON/OFF controller

The unit works at 0% or 100% of maximum production, which can be set to 30%, 50%, 75% or 100% of rated capacity.

Type H: built-in humidity controller

Type H heaterSteam models can be configured at any time to operate in the following modes:

- ON/OFF, by an external humidistat;
- proportional to an external signal from BMS (0 to 1 V, 0 to 10 V, 2 to 10 V, 0 to 20 mA, 4 to 20 mA);
- modulating based on an outside humidity probe, and, where necessary, a limit probe in the duct.

Except for in ON/OFF mode, steam production is modulated linearly from 10% to 100% of maximum flow-rate, ensuring precision equal to $\pm 1\%$ RH even with a large number of air changes.

The preheating function (available on models H and T) can be activated to maintain the water at a set temperature (from 70 to 90 °C) so as to ensure an immediate start to steam production. Any malfunctions are indicated on the display and signalled via the alarm relay.

Type T: built-in temperature controller

This works in the same way as model H, with the difference that production is controlled according to temperature rather than relative humidity (suitable for steam baths).

Features	UR002*	UR004*	UR006*	UR010*	UR020*	UR027*	UR040*	UR060*
General								
Rated steam production (kg/h)	2	4	6	10	20	27	40	60
Power consumption (kW)	1.5	3	4.5	7.5	15	22.5	30	45
Power supply (other voltages upon request)								
• 230 Vac -15/10%, 50/60 Hz single-phase	●	●	●					
• 400 Vac -15/10%, 50/60 Hz three-phase			●	●	●	●	●	●
Steam connection (mm)	Ø 30				Ø 40			2 x Ø 40
Steam pressure (Pa)	0 to 1500				0 to 2000			
Number of heaters	1	1	3	3	6	6	6	9
Operating conditions	1T40 °C, 10 to 60% RH non-condensing							
Storage conditions	-10T70 °C, 5 to 95% RH non-condensing							
Degree of protection	IP20							
Water fill								
Connection (mm)	3/4"G male							
Temperature limits (°C)	1T40							
Water pressure limits (MPa - bar)	0.1 to 0.8 - 1 to 8							
Instant flow-rate (l/m)	0.6	0.6	1.2	1.2	4	4	4	10
Total hardness (°fH) (*)	5 to 40							
Conductivity limits (µS/cm) (*)	0 to 1500							
Water drain								
Connection	Ø 40							
Temperature (°C)	<100							
Instant flow-rate (l/m)	5				22.5			
Blower								
Number	1							2
Type	VSDU0A*				VRDXL*			
Power supply (Vac)	24				230			
Rated power (W)	37				35			
Rated air flow-rate (m3/h)	192				650			
Network								
Network connection	RS485, Modbus® (with optional gateway)							

(*) heaterSteam can be supplied with completely demineralised water (0 °µS/cm). If supplied with softened water, the minimum hardness value indicated must be observed, and the instructions described in the manual must be followed.

Control

Features	C	H	T
Continuous modulation (with SSR)		10 to 100%	10 to 100%
Integrated controller (probes not included)		● (R.H.)	● (temp.)
External ON/OFF signal	●	●	●
External proportional signal		●	●
Limit probe supported		●	●
Dehumidification control		●	●
Remote ON/OFF	●	●	●
Alarm relay	●	●	●
Type of signal (probe or external controller)		0 to 10 V; 0 to 1 V; 2 to 10 V; 0 to 20 mA; 4 to 20 mA	
Alphanumeric display		●	●
RS485 interface		●	●

● standard

Versions

Features	basic	full optional
Heaters embedded in aluminium casting	●	●
Heaters with non-stick coating		●
Thermally insulated		●
Preheating function	●	●
Descaler bag		up to 10 kg/h

Dimensions in mm (inches) and weights in kg (lbs)



Model	AxBxC	weight	LxWxH	weight
UR002*, UR004*	365x275x620 (14.37x10.83x24.41)	21 (46.30)	520x380x730 (20.47x14.96x28.74)	26 (57.32)
UR006*, UR010*	365x275x710 (14.37x10.83x27.95)	26 (57.32)	520x410x870 (20.47x16.14x34.25)	31 (68.34)
UR020*, UR027*	690x438x887 (27.16x17.24x34.92)	63 (138.89)	680x460x1090 (26.77x18.11x42.91)	73 (160.94)
UR040*	690x438x887 (27.16x17.24x34.92)	67 (147.71)	680x460x1090 (26.77x18.11x42.91)	77 (169.75)
UR060*	876x438x887 (34.49x17.24x34.92)	87 (193.65)	946x510x1050 (37.24x20.08x41.34)	98 (216.05)

Unit code

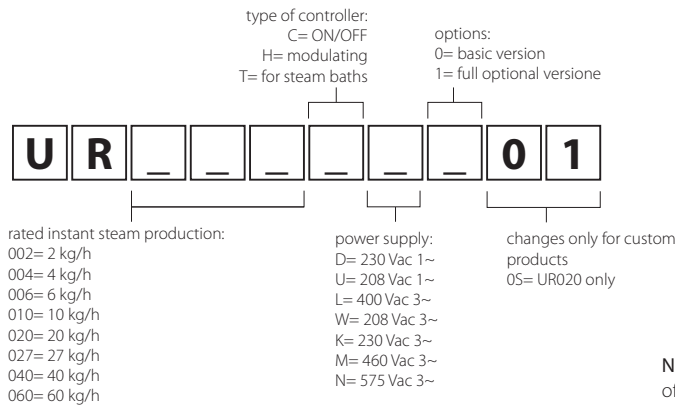

NB: not all the combinations of codes are available.

OVERVIEW DRAWING heaterSteam

room applications

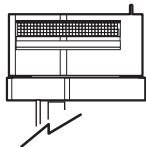

VSDU0A0001 & VRDXL0000:
steam blower
VSDBAS0001: remote support for VSDU0A*

duct applications

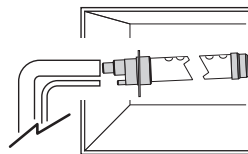

DP*: linear steam distributor (inlet Ø 22 mm, Ø 30 mm, Ø 40 mm)

steam bath applications

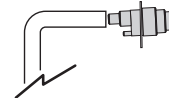

SDP*: plastic nozzle up to 15 kg/h steam

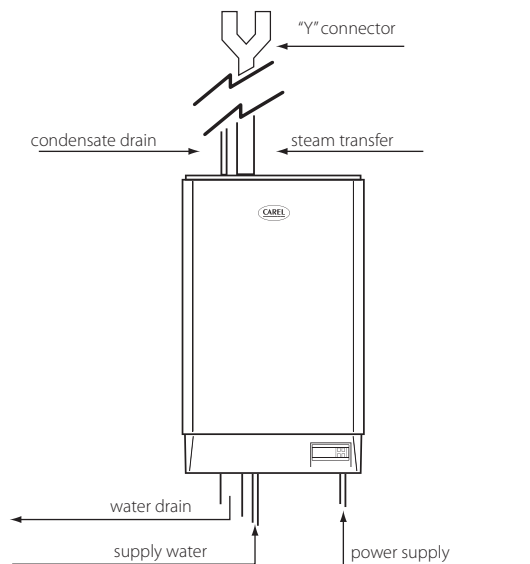

Probes

DPW*: temperature and humidity probe for civil environments

DPP*: temperature and humidity probe for industrial environments

ASET*: temperature and humidity probe for steam baths

DPD*: temperature and humidity probe for ducts



Gas-fired humidifiers

CAREL's extensive experience in the humidification sector has been used to develop the gaSteam range of gas-fired humidifiers, exploiting an energy source that is more economical than electricity. The humidifiers now have updated controllers, and the smallest model has now been upgraded to 45 kg/h (still below the 35 kW limit). The range thus now features the 45 kg/h, 90 kg/h and 180 kg/h models.

CAREL gas-fired humidifiers can run on both natural gas and LPG: the changeover is made by simply modifying a number of parameters, without the need to replace any parts.

Cost effectiveness

To generate 1 kg of steam at atmospheric pressure, considering all the various factors, requires around 750 Wh of energy, either electrical or from other sources. One of the main factors when choosing solutions in the field of isothermal humidification is therefore energy cost, particularly for heavy-duty applications. Gas can be considered an ideal solution in terms of energy source, however to completely exploit its advantages, a system with high thermal efficiency is required, capable of minimising heat loss. Thanks to Ecoflam know-how, the efficiency of our humidifiers is between 92 % and 95%. The graph shows the economic comparison between a gaSteam and

an immersed electrode humidifier, expressed in terms of total cash flow in euro, including purchase, energy and maintenance costs. Even considering the higher purchase price compared to an immersed electrode humidifier, the break-even point for gas-fired humidifiers is reached quite quickly.

This graph compares the costs based on 2000 operating hours/year using 90 kg/h humidifiers, and with the current costs of gas and electricity in Italy. The break-even point is easily reached before two years, after which there are significant savings. In many other countries, the break-even point is reached even earlier, making gaSteam even more cost effective.

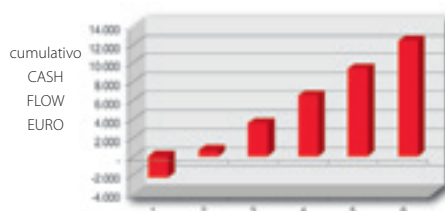

Certification

CAREL has paid significant attention to approval of gaSteam, so as to be able to guarantee complete product safety and achieve all major certifications. gaSteam is approved according to European CE standards, German TÜV standards and American ETL standards.

In Europe, specific DVGW certification has been obtained for gas-fired appliances.

In addition, thanks to the low NOx emissions, gaSteam is approved as a class 5 appliance for models UG045 and UG090, and class 4 for model UG180: this means it can be installed in countries with very strict legislation in force.

As regards applications, refer to the following standards:
 directive 90/396/EEC;
 for places subject to certification by the relevant authorities, the Italian reference standard is: Min. Decree dated 12 April 1996;
 for the gas line the reference is: UNI - CIG 7129 of 1972.



gaSteam

UG*

The family of gaSteam humidifiers features very high thermal efficiency, so as to fully exploit the cost savings of gas. The heat exchanger, which is easily removable for cleaning, is made from aluminium alloy coated with a special anti-corrosion and non-stick treatment that prevents scale from attaching.

The gaSteam humidifiers all come with the pHc electronic microprocessor controller that adopts all the best features of the CAREL pCO programmable controllers. The user interface is made up of a backlit display that features simultaneous and flexible use of graphic icons and texts in various languages. The pHc controller also comes with network connection: via the pCO family pLAN protocol (RS485 interface included), or the Modbus®, Echelon®, BACnet™, RS485 and GSM communication protocols using optional interfaces. The controller can be connected to an active probe and optional second limit probe; operation is ON/OFF or proportional based on a signal from an external controller. It can also manage a dehumidifier, and includes a complete set of diagnostics for maintenance.

Safety

gaSteam is fitted with various safety devices, including:

- pre-mix, room-sealed burner with forced ventilation;
- an air/gas control valve with double safety closing;
- safety negative pressure switch on combustion air intake;
- temperature sensor in the flue gas outlet that checks for malfunctions, and provides early warning of excessive scale on the heat exchanger;
- a flame detector in the burner that closes the gas valve in the event of malfunctions;
- the patented AFS antifoam system with corresponding sensor;
- a multi-stage water level sensor;

- an automatic water conductivity control system to avoid corrosion.

Added advantages

- continuous modulation from 25 to 100% (12.5% for the 180 kg/h model);
- low NOx emissions;
- boiler and components in contact with the water in AISI 304L stainless steel;
- pre-heating function for a faster response;
- supply with mains water or demineralised water. The controller can be set for use with softened water, within the limits described in the reference tables;
- frost protection function;
- precision: 2% RH

Accessories



Heat exchanger

The advanced design, featuring a high transfer surface area both internally and externally, offers unrivalled energy efficiency (between 92% and 95%, according to the model); made from aluminium alloy with a special Niflon lining, which is both corrosion resistant and prevents scale from attaching, is easily removable for cleaning on the bench.



Burner head (90 kg/h model)

Including ignition and flame detection device. The controller manages the production of steam by adjusting the burner fan speed. The gas inlet valve controls the flow of gas as a consequence. The flame sensor controls both the automatic ignition device and gas valve: with no flame the flow of gas is shut off.

gaSteam table

Features	UG045*	UG090*	UG180*
General			
Rated steam production (kg/h)	45	90	180
Modulation of steam production	25 to 100%	25 to 100%	12.5 to 100%
Heat input (kW)	34.8	65	130
Heat output (kW)	33	62.5	125
Power supply	230 Vac (-15/+10%), 50/60 Hz single-phase		
Power input at rated voltage (W)	180	250	400
Steam outlet pressure limits (Pa)	0 to 2000	0 to 2000	0 to 2000
Steam connection (dia. mm)	2x40	2x40	4x40
Gas connection	1"G	1"G	1" 1/4 G
Types of gas	natural gas (G20 and G25); propane (G31); butane (G30)		
Flow-rate/pressure on natural gas (G20) (m ³ St/h - Pa)	3.68 - 2000	7.21 - 2000	13.4 - 2000
Flow-rate/pressure on natural gas (G25) (m ³ St/h - Pa)	4.2 - 2000	8.7 - 2000	17.5 - 2000
Flow-rate/pressure on propane (G31) (m ³ St/h - Pa)	1.43 - 3000	2.68 - 3000	5.36 - 3000
Flow-rate/pressure on butane (G30) (m ³ St/h - Pa)	1.10 - 3000	2.06 - 3000	4.12 - 3000
Operating conditions	1T40 °C, 10 to 90% RH non-cond.		
Storage conditions	-10T70 °C, 5 to 95% RH non-cond.		
Degree of protection	IP20		
Water fill			
Connection	3/4"G male		
Temperature limits (°C)	1T40		
Water pressure limits (MPa - bar)	0.1 to 0.8 - 1 to 8		
Instant flow-rate (l/m)	10	10	18
Total hardness (°fH) (*)	5 to 50		
Maximum conductivity limits (µS/cm) (*)	1500		
Water drain			
Connection (dia. mm)	40		
Temperature (°C)	≤100		
Instant flow-rate (l/m)	25		
Flue gas			
Air intake (dia. mm)	80	80	2x 80
Flue (dia. mm)	80	80	2x 80
Flue gas flow-rate (natural gas G20) (kg/s)	0.0163	0.0303	0.606
Flue gas temperature (natural gas G20) (°C)	123	175	165
NOx emissions class	5	5	4
Network			
Network connection	pLAN over RS485 included; optional Modbus®, Echelon®, BACnet™ and RS232+GSM		
Control			
Integrated controller	●	●	●
External ON/OFF or proportional controller	●	●	●
Preheating	●	●	●
Alphanumeric display	●	●	●
Remote ON/OFF; alarm relay	●	●	●
Limit probe supported	●	●	●

(*) gaSteam can run on completely demineralised water (0 °fH). If supplied with softened water, the minimum hardness value indicated must be observed, and the instructions described in the manual must be followed.

● standard

Dimensions in mm (inches) and weights in kg (lbs)

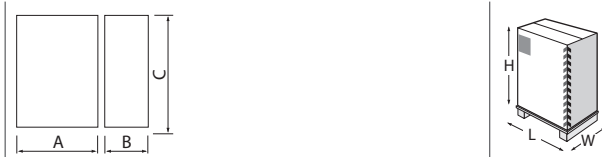

Mod.	AxBxC	peso	LxWxH	peso
UG045*	1020x570x1200 (40.16x22.44x47.24)	150 (330.69)	1090x620x1270 (42.91x24.41x50)	165 (363.76)
UG090*	1020x570x1200 (40.16x22.44x47.24)	150 (330.69)	1090x620x1270 (42.91x24.41x50)	165 (363.76)
UG180*	1020x930x1200 (40.16x36.61x47.24)	240 (529.11)	1090x980x1270 (42.91x38.58x50)	270 (595.25)

Unit code

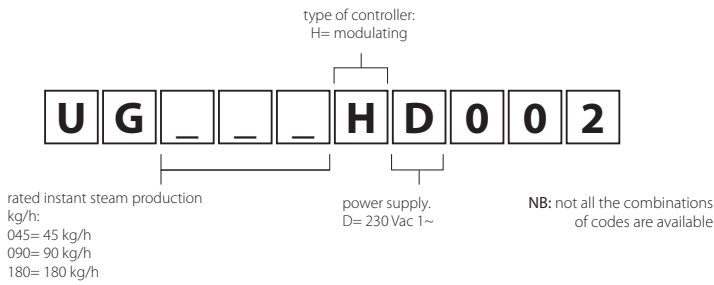

OVERVIEW DRAWING gaSteam

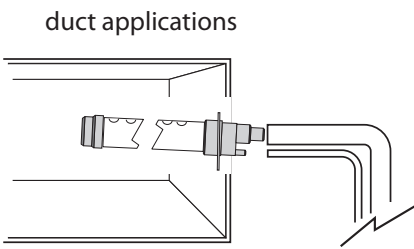

DP*: linear steam distributor (inlet Ø 22 mm, Ø 30 mm, Ø 40 mm)

flue accessories

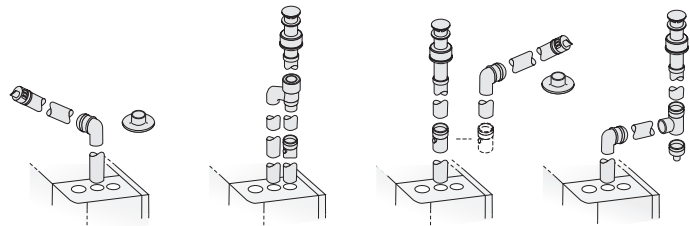

EXH* various flues and fittings

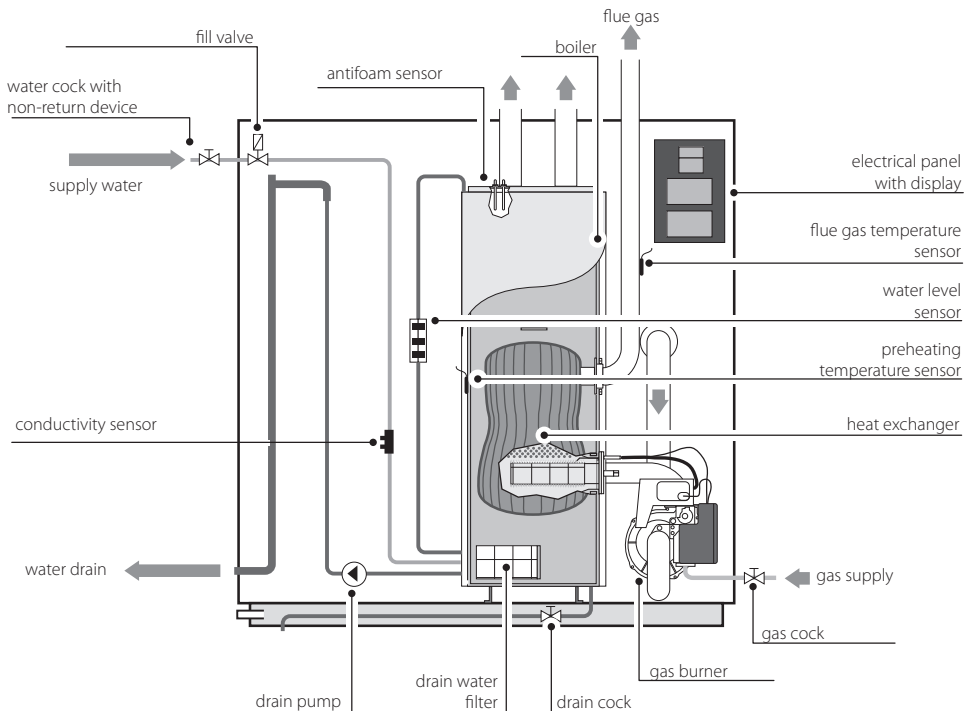

Probes

- DPW***: temperature and humidity probe for civil environments
- DPP***: temperature and humidity probe for industrial environments
- ASET***: temperature and humidity probe for steam baths
- DPD***: temperature and humidity probe for ducts

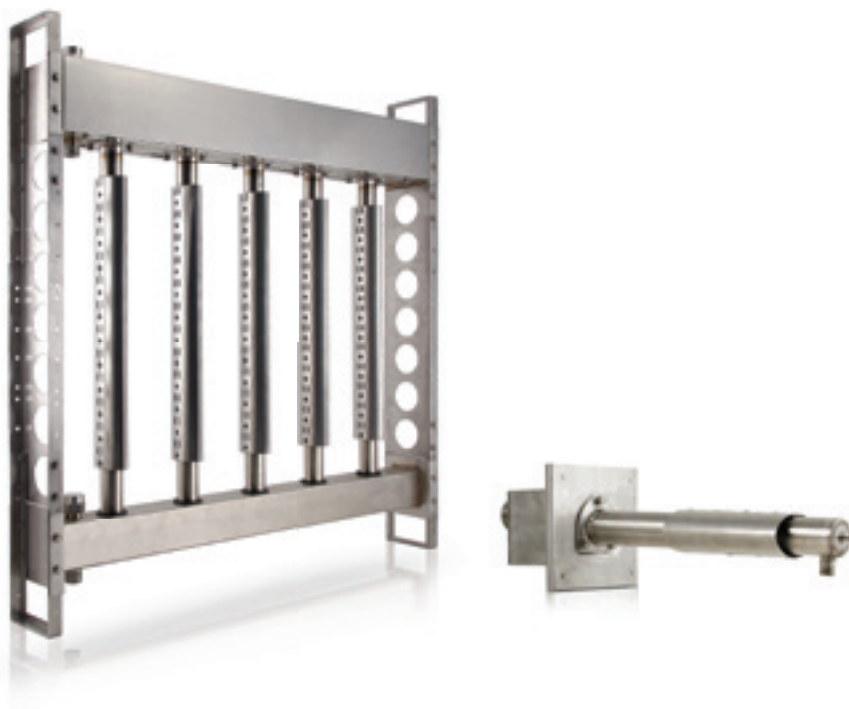

Centralised steam distributors

ultimateSAM is an atmospheric or pressurised steam dispersion system, designed to uniformly and effectively distribute dry steam into ducts or air handling units.

SAM stands for Short-Absorption Manifold, in other words a steam dispersion system with a short absorption or non-wetting distance (even less than 0.5 m).

It has been designed to be built "to measure" for the AHU/duct, guaranteeing low heat gain (max. 2 °C/4 °F) and very low condensate formation, thanks to the air cushion insulation on the pipes.

All metal parts fitted in the AHU/duct are made from AISI 304 steel so as to guarantee hygiene and long operating life. The features of the ultimateSAM humidification system make it a perfect solution for all humidification requirements in AHUs/ducts, providing designers, installers and service personnel with the best solutions. The wide product range and choice of steam capacity, plus the numerous options, make the system ideal for use in various applications, including hospitals, the pharmaceutical industry, libraries, museums, offices, shopping centres, data centers, telecommunications and many, many others.

Main features

SAB*/SAT*

- steam: 20 to 1110 kg/h (44 to 2440 lbs/h), 0 to 4 barg (0 to 58 PSig), also suitable for steam at atmospheric pressure;
 - dimensions WxH: 447x598 mm to 3031x3181 mm in 152 mm steps (18"x24" to 120"x120" in 6" steps);
 - can be supplied with/without insulation, with/without support frame, unassembled or completely assembled.
- SA0*
- SA0* single-pipe version also available; steam flow-rate 20 to 140 kg/h (44 to 309 lbs/h), 0 to 4 barg (0 to 58 PSig), also suitable for steam at atmospheric pressure; dimensions from 503 mm to 2175 mm in 152 mm steps (from 19" to 86" in 6" steps).

Benefits

- holes set out along the entire height of the pipes deliver steam uniformly, ensuring a very short non-wetting distance;
- energy saving due to insulation on the pipes, decreasing air heat gain and condensate formation;
- hygiene: ultimateSAM is made from AISI 304 steel;
- ultimateSAM can be purchased with valves controlled by electric actuators for precise modulation of steam flow into the AHU/duct;

- different configurations of ultimateSAM are available for applications with high steam flow-rates or if the required non-wetting distance is particularly short;
- the single-pipe version is insulated and is supplied with a manifold that also acts as steam trap.

System composition

- AISI 304 steam distribution pipes with/without insulation. On insulated pipes, the nozzles are made from PPS (Ryton), which has a continuous operating temperature of 220 °C/428 °F;
- AISI 304 manifold that carries the steam to the distribution pipes. The manifold is placed at the bottom for steam flow-rates from 20 to 370 kg/h (SAB*); for steam flow-rates up to 1110 kg/h, the manifold is fitted at the top (SAT* top-feed models); these are nonetheless also suitable for steam flow-rates starting from 60 kg/h);
- silicone gaskets for high temperatures (min 150 °C/300 °F); EPDM when in contact with steam;
- AISI 304 support frame;
- model SA0*: insulated AISI 304 pipes with nozzles.



ultimateSAM

SAB*, SAT*

The ultimateSAM system can use both steam from a pressurised distribution network or from a generator at atmospheric pressure (humidifier). When supplied by a pressurised steam line, the fluid reaches the distributor via a regulating valve, which expands the steam until almost atmospheric pressure. When steam is supplied at atmospheric pressure, no valve is fitted between ultimateSAM and the steam generator, with steam flow-rate being modulated based on demand and managed directly by the humidifier.

To minimise condensate formation, the steam distribution pipes have been designed with baffles and nozzles that ensure only dry steam is delivered into the AHU/duct.

ultimateSAM can be ordered with insulated upright distribution pipes, featuring a cushion of air that reduces both heat gain and condensate formation. On insulated distributors, the nozzles pressed into the pipes take dry steam from the centre of the distributors so as to prevent the release of condensate into the air stream. On the other hand, if the uprights are not insulated, no nozzles are fitted. Insulated models with nozzles reduce condensate formation by 30% compared to non-insulated models. In both cases, naturally, a short not-wetting distance is guaranteed (around ½ a metre).



ultimateSAM single pipe

SA0*

This can be used with pressurised steam or steam at atmospheric pressure. The manifold in this case also acts as a steam trap, being fitted with a baffle on the inside, as well as ensuring condensate drainage. The single-pipe version comes with insulation and nozzles to reduce condensate formation and non-wetting distance.

Accessories available for the single-pipe version:

- SAKC*S10*0: condensate drain hose kit;
- SAKCO*T0*0: condensate drain T connection kit
- SAKD0*10*0 and SAKD0*20*0: steam inlet kit for double-pipe version.

Accessories



Modulating valves

(SAKV*)

Modulating valves with electric actuator and automatic safety closing in the event of power failures: the modulating valves control steam flow-rate based on a signal from an external controller; this is required for systems supplied by pressurised steam.



Steam inlet connections

(SAKI*)

The ultimateSAM humidification system includes a variety of steam inlet adapters, so as to offer maximum installation flexibility. All the adapters are made from stainless steel and are sized for easy connection to all the other components in the system.



Steam traps and condensate drains

(SAKT*P*, SAKT*D*, SAKT*B*)

These are integral parts of a steam distribution system, both supplied with pressurised steam or steam at atmospheric pressure. The steam trap + condensate drain assembly prevents condensate from forming in the supply line to the valve and steam dispersion system.



Y strainers

(SAKT*F*)

These remove any type of impurity that may be entrained in the piping, preventing these from reaching the distributor



Condensate drain T connection kit

(SAKC*S10*0) for models SA0*

Stainless steel condensate drain connector for single-pipe models. Used to drain condensate from the pipes and manifold.

Spare parts

Distribution pipes

(SAKU*)

Spare distribution pipes are sold in kits including:

- the distribution pipe;
- 1 O-ring;
- bolts to fasten the distributor to the horizontal manifold.

Gaskets

(SAKG*) (for models SAB*/SAT*)

Each kit contains:

- 2 O-rings;
- 2 gaskets for condensate drainage.

Distribution manifolds

(SAKM*, SAKMS*, SAKMD*)

Each SAKMS*00 kit for SAB* and SAT* contains only the horizontal steam distribution manifold; gaskets are not included, as the existing ones are used.

Each SAKMD*00 kit for SAT* contains:

- horizontal condensate collection manifold;
- gaskets for connection to the upright distributors.

Kit SAKMSA00*0 kit for SA0* contains:

- manifold;
- gasket;
- fastening bolts.

Metal support structure parts

(SAKF*, SAKS*) (for models SAB*/SAT*)

SAKS**0000: top and bottom supports for installing ultimateSAM in duct/AHU

SAKFB00000: top corner for ultimateSAM SAB* for assembling the support frame (the kit includes the fastening bolts).

SAKFR*0000: locking rings for securing the uprights to the ultimateSAM SAB*.

SAKFF0*000: frame shoulder and top side of the frame for the ultimateSAM SAB*.

ultimateSAM table

Features	SAB* (bottom steam feed)	SAT* (top steam feed)	SA0* (horizontal single-pipe version)
Insulation for energy and water savings	air cushion upon request		air cushion
Capacity kg/h (lbs/h)	20 to 370 (44 to 814)	60 to 1100 (132 to 2440)	20 to 140 (44 to 309)
Steam pressure - bar (Pa)	from around 0.01 bars (1000 Pa) to 4 barg		
Duct width (mm)	497 to 3081		383 to 2055
Duct height (mm)	623 to 3206		min 300
Material	AISI 304 stainless steel		
Certification	ETL certification		

Dimensions in mm (inches) and weights in kg (lbs)

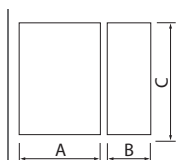

Model	AxBxC	weight
SAB*	447x135x598 / 3031x135x3030 (17.60x5.31x23.54 / 119.33x5.31x119.29) in 152 mm steps	7.5 to 202.5 (17 to 446)
SAT*	447x135x749 / 3031x15x3181 (17.60x5.31x29.49 / 119.33x5.31x125.24) in 152 mm steps	10 to 213.5 (22 to 470)
SA0*	pipe length 383 to 2055 mm (15.08-80.90) in 152 mm steps B=C= 160 mm (6.30)	4to 8.81 (8.7 to 19.4)

Unit code

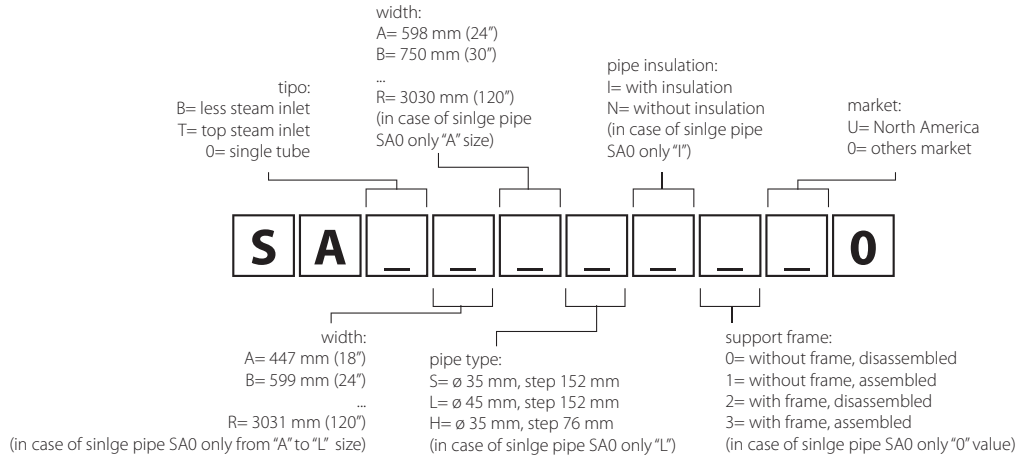

OVERVIEW DRAWING ultimateSAM

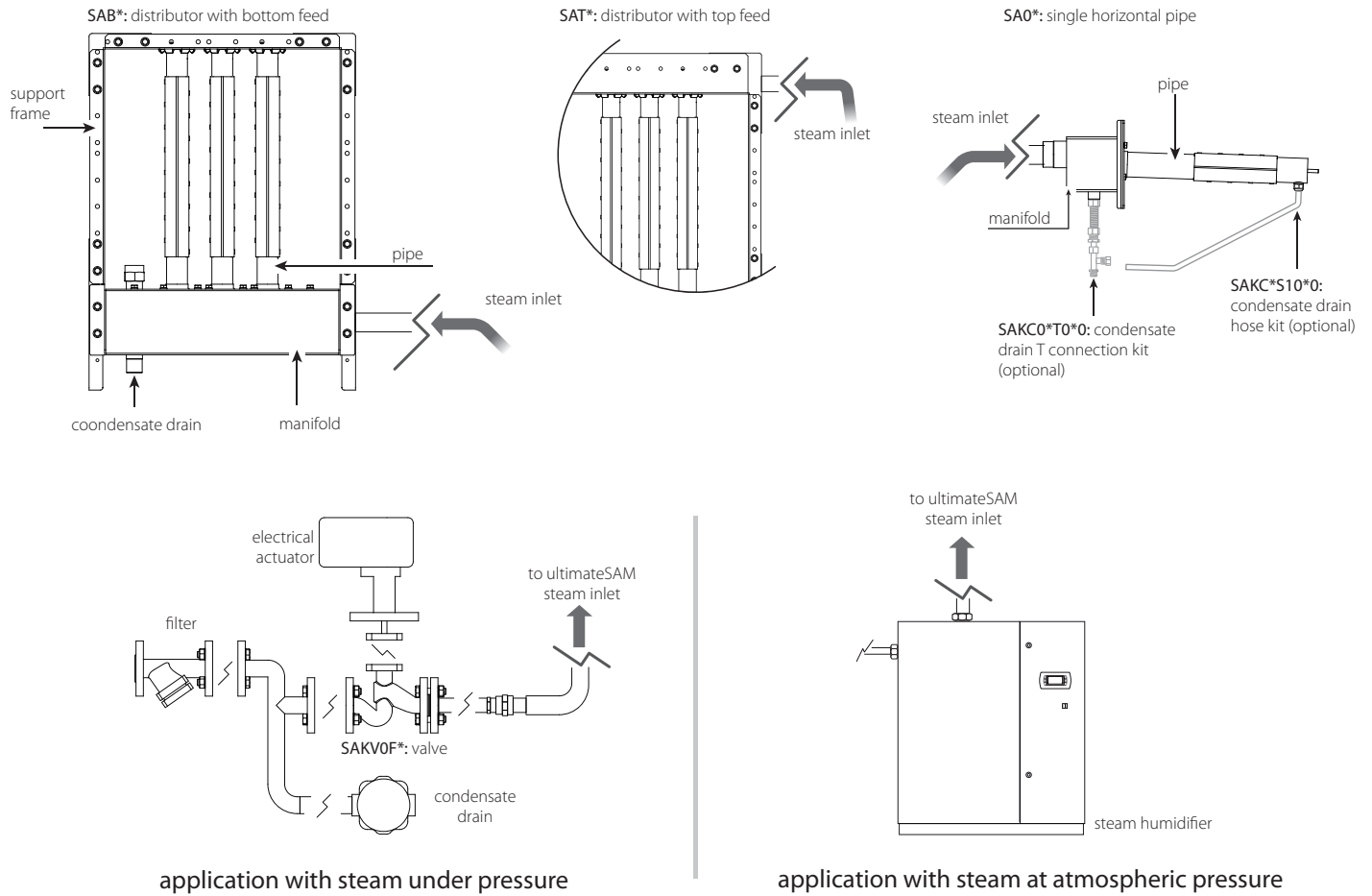

Accessories

These accessories are available for the humiSteam, compactSteam, heaterSteam and gaSteam humidifiers.

The CAREL range of accessories for isothermal humidifiers have been especially developed to allow designers to create humidification systems that are complete and suitable for all types of application.



UE UR
 CH UG

Steam distributors for ducts

(DP***D**R*)

The wide range of linear steam distributors for ducts in the "DP" series is made up of perforated stainless steel pipes supported by a fastening bracket made from Ryton®.

This material combines excellent mechanical characteristics with extraordinary resistance to high temperatures.

The new fastening bracket allows the steam distributor to be fastened vertically to a wall, guaranteeing the correct incline of the distributor for draining condensate.

The stainless steel linear steam distributors are available in 3 different diameters (35, 45 and 60 mm), which couple respectively to the 22, 30 and 40 mm diameter steam hoses used on the entire range of CAREL humidifiers.

These distributors are designed to release steam in a uniform manner along the entire length, so as to minimise non-wetting distance.



UE UR
 CH UG

Steam nozzles

(SDPOEM00**)

A range of steam nozzles is also available for distributing steam into small ducts or steam baths (SDPOEM0012 for models from 1 to 3 kg/h, SDPOEM0022 for models from 5 to 18 kg/h, SDPOEM0000).



UE UR
 CH UG

Fittings and connectors

(UEKY*****)

If the humidifier steam outlet lines need to be branched, two stainless steel Y connectors are available, one with 40 mm inlet and two 30 mm outlets (UEKY000000), and one with 40 mm inlet and two 40 mm outlets (UEKY40X400).

The fundamental idea is to guarantee optimum operation of the humidification system by providing the installer, maintenance personnel and user all the auxiliary components that simplify installation, steam distribution, operation and control of the humidifier.



UE UR
 CH UG

Fill hoses

FWHDCV0000: water fill kit
FWH3415000: hose L=1.5 m
FWH3430000: hose L=3 m
9997*ACA: straight and elbow quick connector
1312350APN: hose with 6 mm ID and 8 mm OD.

The FWHDCV0000 kit includes the FWH3415000 hose and a double non-return valve. The kit has been designed both to ensure conformity to standards that require the use of a double non-return valve upstream of the humidifier (WRAC), and to avoid breakages of the fill valve due to direct connection to metal mains water pipes. The plastic fill solenoid valve may be damaged if connected directly to metal mains water pipes: using hoses with plastic fittings, FWH3***000, eliminates this risk.

The FWH3***000 hoses are available in two lengths: 1.5 m and 3 m, with two ¾" female GAS connectors (one straight and one elbow). Alternatively, the 6 mm hose and the quick connectors described below can be used. The straight or elbow connector (999572*ACA) is screwed onto the fill solenoid valve and can be quickly fitted by tightening a nut to the 6 mm water fill hose (1312350APN).



UE UR
 CH UG

Steam hoses

(1312360AXX - 1312365AXX - 1312367AXX hose for cylinders with 22/30/40 mm fitting and harmonic steel coil - outside diameter 32/41/52 mm).

The steam distribution hoses are made from rubber resistant to 105 °C in continuous operation without the emission of odours, and suitable for use with foodstuffs. The harmonic steel coil immersed in the rubber gives the hose flexibility and strength, preventing it from being choked and blocking the flow of steam.

The accessories, described in the following paragraphs, are divided into:

- steam distribution accessories: steam hoses and distributors, for rooms and ducts;
- plumbing components, for filling and draining the water;
- probes and external controllers (described in the chapter "Probes and control devices").



UE UR
 CH UG

Steam blowers

(VSDU* and VRDX*)

The steam blowers for rooms (VSDU0A0002) are suitable for humidifiers up to 18 kg/h. The steam blower can be fitted directly onto the humidifier, or in a remote position. In the latter case, a support is required for mounting the blower (VSDBAS0001), as well as a steam hose to connect the blower to the humidifier. The steam blower works in ON/OFF mode, and is controlled by a temperature device that is activated when steam is produced.

For humidifiers larger than 18 kg/h, the VRDXL00000 steam blowers are available, with 230 Vac power supply.

The VRDXL00000 distributors are designed for installation in a remote position from the humidifier, and require two 30 mm diameter steam hoses.

Both models of steam blowers are designed to drain condensate using a 7 mm diameter hose (see below).



UE UR
 CH UG

Condensate drain hoses

1312353APG: 7 mm, 1312368AXX: 10 mm, 1312357APG: 40 mm (1 m lengths)

The condensate that forms inside the steam distributors must be drained using the 7 mm hose for the steam blowers, and the 10 mm hose for the "DP" linear distributors for ducts. The water drain hose is the same for all isothermal humidifiers and is made from rubber resistant to 100 °C.

Table for choosing duct steam distributors

																	for special applications only*						
	DP035D22R0	DP045D22R0	DP060D22R0	DP085D22R0	DP035D30R0	DP045D30R0	DP060D30R0	DP085D30R0	DP105D30R0	DP125D30R0	DP165D30R0	DP085D40R0	DP105D40R0	DP125D40R0	DP165D40R0	DP205D40R0	DP030D22RU	DP030D30RU	DP045D30RU	DP060D30RU	DP060D40RU		
inlet diameter (C)	22 mm				30 mm							40 mm						22 mm	30 mm			40 mm	
length (A)	350	450	600	850	350	450	600	850	1.050	1.250	1650	850	1.050	1.250	1.650	2050	300	300	450	600	600		
CH001 - CH005	1	1	1	1													1						
UE001	1	1	1	1													1						
UE003	1	1	1	1													1						
UE005					1	1	1	1	1	1								1	1	1			
UE008						1	1	1	1	1								1	1	1			
UE009							1	1	1	1								1	1	1			
UE010							1	1	1	1	1							1	1	1			
UE015								1	1	1	1									1			
UE018								1	1	1	1												
UE025								2*	2*	2*	2*	1	1	1						2**	1		
UE035								2*	2*	2*	2*	2**	1	1	1	1					1		
UE045 230 V 3-phase												2	2	1**	1**	1**					1**		
UE045 other voltages												2**	2**	1	1	1					1		
UE065												4**	2	2	2	2					2		
UE090												4**	4**	2	2	2					2		
UE130													4	4	4	4					4		
UR002					1	1												1	1				
UR004					1	1	1	1	1	1								1	1	1			
UR006						1	1	1	1	1								1	1	1			
UR010							1	1	1	1	1							1	1	1			
UR020							2*	2*	2*	2*	2*	1	1	1					2*	2*	1		
UR027							2*	2*	2*	2*	1	1	1					2*	2*	1			
UR040												2**	2**	1	1						1		
UR060												4**	2	2	2						2		
UG045												2	2	2	2						2		
UG090												4**	4**	2	2	2					2		
UG180													4	4	4						4		

Note: the quantities with asterisks require branched connections

*: use CAREL "Y" kit P/N UEKY000000, 40 mm (1.6") inlet and 2 x 30 mm (1.2") outlets

** : use CAREL "Y" kit P/N UEKY40400, 40 mm (1.6") inlet and 2 x 40 mm (1.6") outlets

***: not recommended for use in normal applications

Adiabatic humidification





Pressurised water humidifiers

Pressurised water humidifiers exploit the potential energy transferred to the water by a special volumetric pump in the form of high pressure (generally 70 bars), so as to achieve very fine atomisation through special nozzles.

The most common application of these humidifiers is in AHUs, where the pressurised water distribution system is installed. In industrial environments for processing wood or paper, or in the textiles industry, systems are often used to distribute atomised water directly into the rooms.

As well as humidity control, pressurised water atomisers are the best solution for fully exploiting the potential offered by evaporative cooling, both direct and indirect, inside AHUs or in rooms, as in the case of industrial facilities and large public spaces, such as metropolitan railway stations and airports.

One crucial aspect is the hygiene that pressurised water humidifiers must guarantee in the application where they are used. Management of washing cycles, the materials used and the configuration of the atomised water distribution system are the main features that guarantee CAREL humidifiers comply with the strictest hygiene regulations in force (VDI6022).

humiFog multizone represents the new generation in high pressure atomised water humidifiers. A volumetric pump sends water at high pressure to a distribution system made up of nozzles that atomise the water into very fine droplets, which can be absorbed by the air in a very short space.

Energy saving

The only energy humiFog consumes is used to power the water pump, just 4 watts for every l/h of capacity. Cooling in summer is provided by lowering air enthalpy, while humidification in winter has the advantage of being able to use thermal energy at low temperature. Power consumption is thus minimised. In addition, an inverter is used to modulate pump speed, meaning both more precise control and even lower power consumption.

Benefits

- **very low power consumption:** consumes just 4W per l/h capacity, less than 1% of any steam humidifier.
- **summer/winter operation:** humidifies the air during winter, cools the air in summer by direct and indirect evaporative cooling.
- **choice of models available:** single zone or multizone to best satisfy different requirements.
- **high capacity:** standard models are

available with capacities from 100 to 600 kg/h and custom models up to 5000 kg/h.

- **maximum hygiene:** suitable for all applications that require a high level of hygiene.
- "silicon free" version available with steel pump for painting applications.

Winter/summer operation

The winter/summer function allows classic air humidification in winter, while in summer humiFog is used to evaporatively cool the inlet air. The air is cooled due to spontaneous evaporation of the droplets of water: the change in state (from liquid to vapour) absorbs energy from the air, which by transferring sensible heat to the water is cooled. 100 kg/h of water absorbs 68 kW of heat from the air when evaporating.



pumping unit



zone controller



controllers

humiFog multizone

UA*H*, UA*Z*

Single-zone/multi-zone configurations

The humiFog system can be used in the following configurations:

Single zone

for applications in AHUs, the pump operates at variable pressure with flow control, for precise and continuous modulation of humidification capacity.

Multizone

for applications in AHUs and in rooms, in which a pumping unit (master) supplies multiple distribution systems (up to 6). Water pressure is kept constant (70 bars), capacity is modulated in steps. The multizone configuration rationalises the use of the humiFog pumping unit as, despite the lower precision due to stepped modulation ($\pm 5\%$ against the $\pm 2\%$ guaranteed by the single zone solution), it can manage multiple zones at the same time, without having to install a pumping unit for each AHU or industrial environment.

Direct humidification into rooms: humiFog multizone is the ideal system, as by keeping water pressure high (70 bars), each nozzle generates a cone of very fine droplets (average diameter 10 to 15 μm) that evaporate completely in a short time and space. The air temperature and humidity conditions, together with the presence of objects, may represent limits that must be considered in the installation to prevent the droplets from wetting objects, machinery and people in the room. When these limits are not satisfied, blowers can be used that, due to the cushion of air generated by the built-in tangential fan, carry the droplets of water in a substantially horizontal trajectory.

Hygiene aspects

Certification in accordance with the latest European standards (VDI6022) make humiFog for AHUs suitable for all applications, including the most demanding as regards hygiene, such as hospitals.

humiFog does not use chemical biocides but rather pure and simple water. Combining humiFog with reverse osmosis demineralisation and the UV lamp disinfection system guarantees maximum hygiene of the supply water.

HumiFog does not atomise recirculated water: the built-in controller automatically fills the water lines only when humidification is required. At the end of the humidification cycle, all the lines are emptied to avoid stagnation of water in the system. In the event where there is no humidification demand for an extended time, automatic periodical washing cycles are activated on the water lines. All the components in the distribution system in contact with water are made from AISI304 stainless steel.

Supply water characteristics

For correct operation, the humiFog multizone system should be supplied with demineralised water (with conductivity between 0 and 50 $\mu\text{S}/\text{cm}$). To reach these values, a reverse osmosis system is usually required. This treatment involves having the water pass through a special membrane that, being permeable only to molecules the same size as H_2O , eliminates almost all the mineral salts present. As well as representing a physical barrier to bacteria, reverse osmosis water treatment removes mineral salts, and limits maintenance requirements inside the duct to simple periodical inspections!

System composition

- Pumping unit with continuous pump modulation (by inverter);
- Fibreglass or stainless steel mist eliminator for hygienically certified installations;
- Zone controller (for multizone version);
- High pressure connection pipes.
- Water treatment system (reverse osmosis).

Controllers

Simple and intuitive user interface

A large display shows easily understandable messages even for users without detailed knowledge of the product

The user interface is available in 5 languages (Italian, English, French, German and Spanish) while the menus can be browsed simply using the buttons with icons.

Solution for installation in AHUs



Atomising rack made-to-measure for AHUs

(RACK*)

Atomising rack made to measure for the AHU. This is made up of nozzle manifolds, atomising nozzles, manifold on-off valves, manifold drain valves, vent valve and the main drain valve. All the metal parts are made from stainless steel. The on-off solenoid valves control the number of nozzles that are open, while the drain and vent solenoid valves are used to empty the rack.



Certified mist eliminator for AHUs

(UAKDS*, SPFR*)

The mist eliminator has the purpose of trapping the droplets of water that are not completely evaporated, so as to prevent them from leaving the humidification chamber. The eliminator is supplied in standard modules that can be assembled to cover the cross-section of the AHU.

It is available in two versions: with fibreglass or AISI304 steel filtering material, the latter required for VDI6022 certified installations.

Pressure drop is very low and, with air speeds up to 3.5-4m/s, varies from 30 Pa when dry to around 70 Pa when wet.

The structure of the mist eliminator is always in stainless steel, and guarantees fast and effective water drainage.

Solutions for installation in rooms



Blowers for all types of environment

(DL*)

This consists of a tangential fan located behind a manifold with nozzles. The tangential fan generates a flow of air that assists evaporation of the droplets and the sustains the droplets with a cushion of air, so as to produce an essentially horizontal trajectory.

The entire assembly is enclosed in a metal structure that also contains the on-off and solenoid drain valves, controlled by the pumping unit.

The blowers have capacities that reach 32 kg/h! The "Master" version, with a built-in pressure switch, can independently manage the on-off and drain solenoid valves.

Multiple blowers can be connected in series to make up a complete distribution line.



Room distributors

(UAKC*FP*)

These consist of stainless steel manifolds (pipes) with fittings for nozzles that are installed inside the room being humidified/cooled. The manifolds are available in various models, to fit nozzles from one side only or on two opposing sides. A series of manifolds make up a line in the distribution system. The stainless steel manifolds are 2450 mm long, with an outside diameter of 16 mm.

Each distribution line can be connected directly to the pumping unit or shutoff by a solenoid valve. By controlling these solenoid valves, humiFog manages the capacity of the distribution system, thus obtaining stepped capacity modulation (up to 6 steps). Each line has a drain valve that is mainly used to quickly discharge the water pressure when the line stops atomising: when opening the drain valve, the pressure quickly drops from 70 to 0 bars and the line is emptied, preventing the nozzles from dripping. In addition, the drain valves are used for the periodical automatic washing cycles managed by humiFog.

The on-off solenoid valves are made from stainless steel in the normally closed version, up to 100 bars, while the normally open valves open automatically at around 15 bars; both have 1/8" GAS F fittings.

Accessories and options



Pulsation damper

The damper reduces peaks in pressure generated by the pump pistons so as to limit pulsation along the pipes and the distribution system. Recommended for high capacity systems starting from 200 kg/h.



Connection pipes and fittings

(UAKT)

CAREL can supply hoses or stainless steel pipes for connection between the pumping unit and the rack or the room distribution system, as well as high pressure (up to 100 bar) compression fittings for stainless steel pipes.



Liquid Teflon

(5024612AXX)

Liquid Teflon for high pressure water fittings, 100 ml package.

This is used to seal the nozzles and all the fittings on the rack and the blowers pre-assembled by CAREL.



Junction box

(UAKDER*0000)

Junction box for the solenoid valves fitted on the atomising rack in the duct.

Models available for 4 to 8 solenoid valves.

Example of operation with direct and indirect evaporative cooling

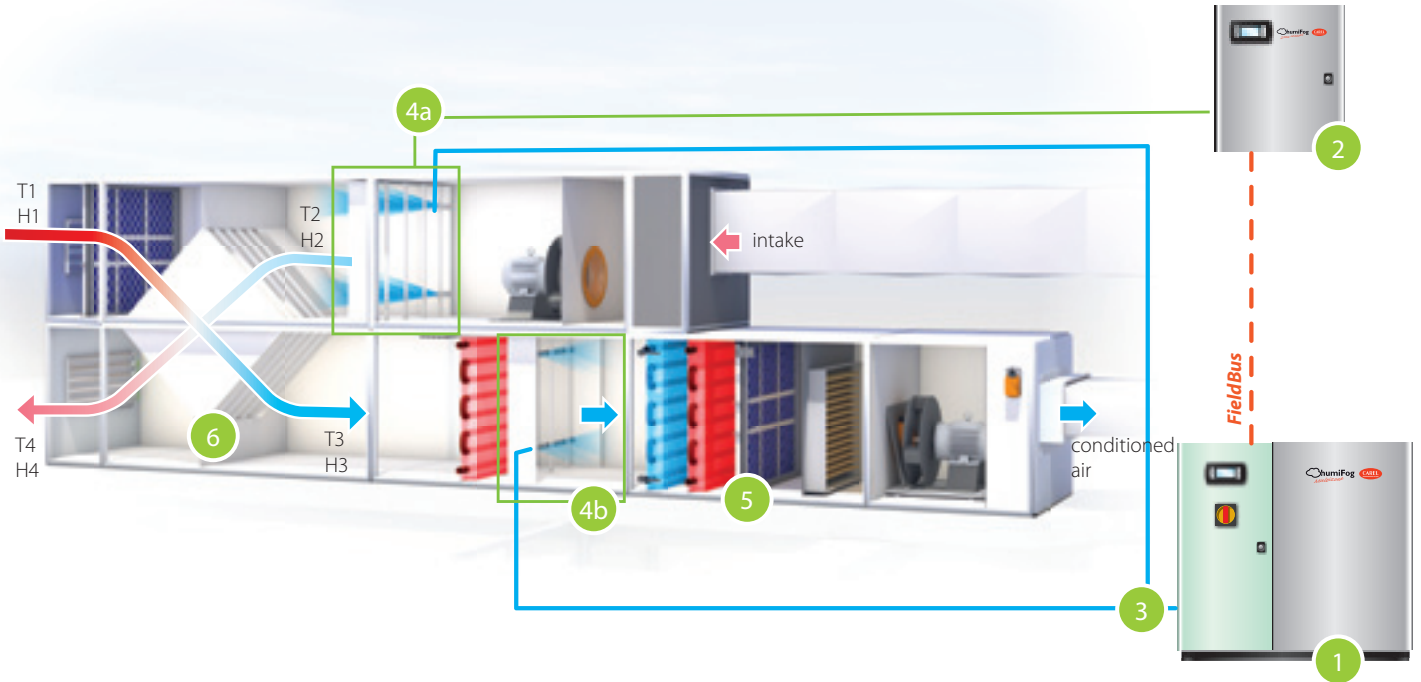

Winter/summer operation

The winter/summer function allows air humidification in winter, while in summer humiFog is used to evaporatively cool the inlet air.

Direct evaporative cooling

This extends the range in which free cooling can be used, by evaporatively cooling the inlet air, while always controlling the relative humidity set point (4b).

Indirect evaporative cooling

This is applied to the exhaust air, which can be cooled by several degrees without limits in terms of humidity (the air is

discharged by the AHU), by flowing first through a cross-flow heat exchanger together with the inlet air. This pre-cools the fresh air, reducing the capacity required by mechanical cooling (chiller) to bring the air to the desired conditions, thus reducing power consumption. The efficiency of this solution depends on the heat recovery unit used, yet easily exceeds 50%!!! The humiFog multizone is perfect for these types of applications in AHUs.

- 1 *pumping unit and zone controller for humidification in winter*
- 2 *zone controller for cooling in summer*
- 3 *pressurised water line*
- 4 *a: rack for cooling in summer
b: rack for humidification in winter*
- 5 *mist eliminator*
- 6 *heat recovery unit*

	Outside air		Exhaust air		Cooled outside air		Outlet air		Cooling capacity*
	T ₁	H ₁	T ₂	H ₂	T ₃	H ₃	T ₄	H ₄	P
WITHOUT evaporative cooling	35 °C	40% RH	25 °C	50% RH	29 °C	56% RH	31 °C	36% RH	58 kW
WITH evaporative cooling	35 °C	40% RH	18 °C	saturation	25 °C	70% RH	28 °C	55% RH	100 kW
							Additional capacity		42 kW

In the example shown in the table, the exhaust air is pre-cooled to 18 °C and then used by the heat exchanger to cool the outside air from 35 to 25°C, a decrease of 10 °C, without increasing absolute humidity.

*: The cooling capacity is calculated based on an outside air flow-rate of 30000 m³/h, atomising 100 kg/h of water, and a heat recovery unit with an efficiency of 58%.

Features	UA100*	UA200*	UA320*	UA460*	UA600*
General					
Rated capacity kg/h	100	200	320	460	600
Power supply	230 V, 1 phase, 50 Hz or 208 V, 1 phase, 60 Hz				
Pumping unit power consumption (kW)	0.955	0.955	1.15	1.15	1.95
Zone controller power consumption (kW)	0.28				
Operating conditions	1T40 °C <80 % RH non-condensing				
Storage conditions	1T50 °C <80 % RH non-condensing				
Degree of protection	IP20				
Water fill					
Connection	G3/4" F (NPT3/4F for UL versions)				
Temperature limits	1T40 °C / 34T104 °F				
Water pressure limits (MPa)	0.3 to 0.8				
Total hardness (ppm CaCO ₃)	0 to 25				
Conductivity limits (µS/cm)	0 to 50 µS/cm (stainless steel pump) – 30 to 50 µS/cm (brass pump)				
Water outlet					
Connection	M16.5m DIN 2353 (G3/8" F) (NPT3/8F for UL versions)				
Water drain					
Connection (Ø mm)	Stainless steel pipe, OD 10 mm/ 0.4 inch				
Network					
Network connection	RS485; Modbus® (others upon request)				
Control					
Control	external signal, temperature or humidity control; additional temperature or humidity limit probe				
Type of input signals	0 to 1 V, 0 to 10 V, 2 to 10 V, 0 to 20 mA, 4 to 20 mA, NTC				
Certification					
Hygiene certification for generic air-conditioning applications	VDI 6022, page 1 (04/06), VDI 3803 (10/02), ONORM H 6021 (09/03), SWKI VA104-01 (04/06), DIN EN 13779 (09/07)				
Hygiene certification for hospital applications	DIN 1946, part 4 (01/94), ONORM H 6020 (02/07)*, SWKI 99-3 (03/04)				
Certification	CE and ETL998 (pumping unit); ETL508A (zone controllers)				

Models of blowers for rooms

Features	DL*
Water inlet	M12 x 1 male
Water outlets	M12 x 1 male or TNF 6x8 for DLxxSDxxxx and DLxxMDxxxx
Outlet fan power	230 Vac, 50 Hz
Capacity (kg/h)	5, 11, 16, 22, 32
Air flow-rate	700 m ³ /h model with 4 nozzles, 1500 m ³ /h model with 8 nozzles
Dimensions	850 model with 4 nozzles, 1500 model with 8 nozzles, 200x200 mm
Material	stainless steel
Nozzle capacity at 70 bars (kg/h)	MTP0= 1.45 kg/h, MTP1= 2.8 kg/h, MTP2= 4 kg/h
Nozzle fittings	4 or 8
Manifold connectors	1/4" G female
Manifold dimensions	2450 mm, Ø14 mm
Maximum distribution line length (m)	50 m (contact CAREL for longer lines)

Dimensions (mm) and weights (kg)

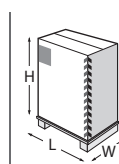
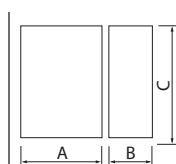

Model	AxBxC	weight	LxWxH	weight
UA*H*	1030x400x860	85 to 100	1100x455x1020	100 to 120
UA*S*	515	19.5	605x255x770	21

Unit code

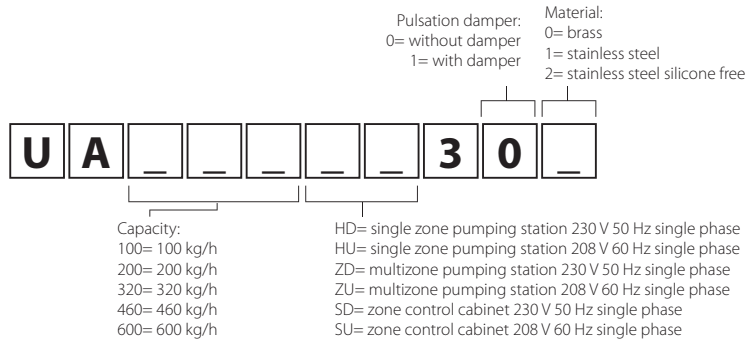

OVERVIEW DRAWING humiFog

duct applications

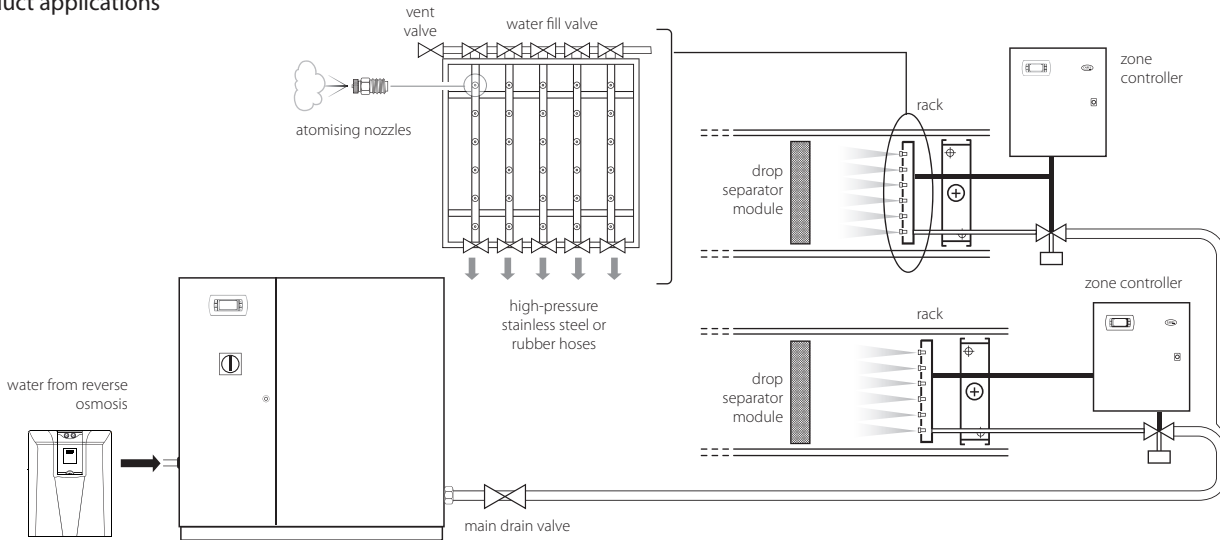

room applications

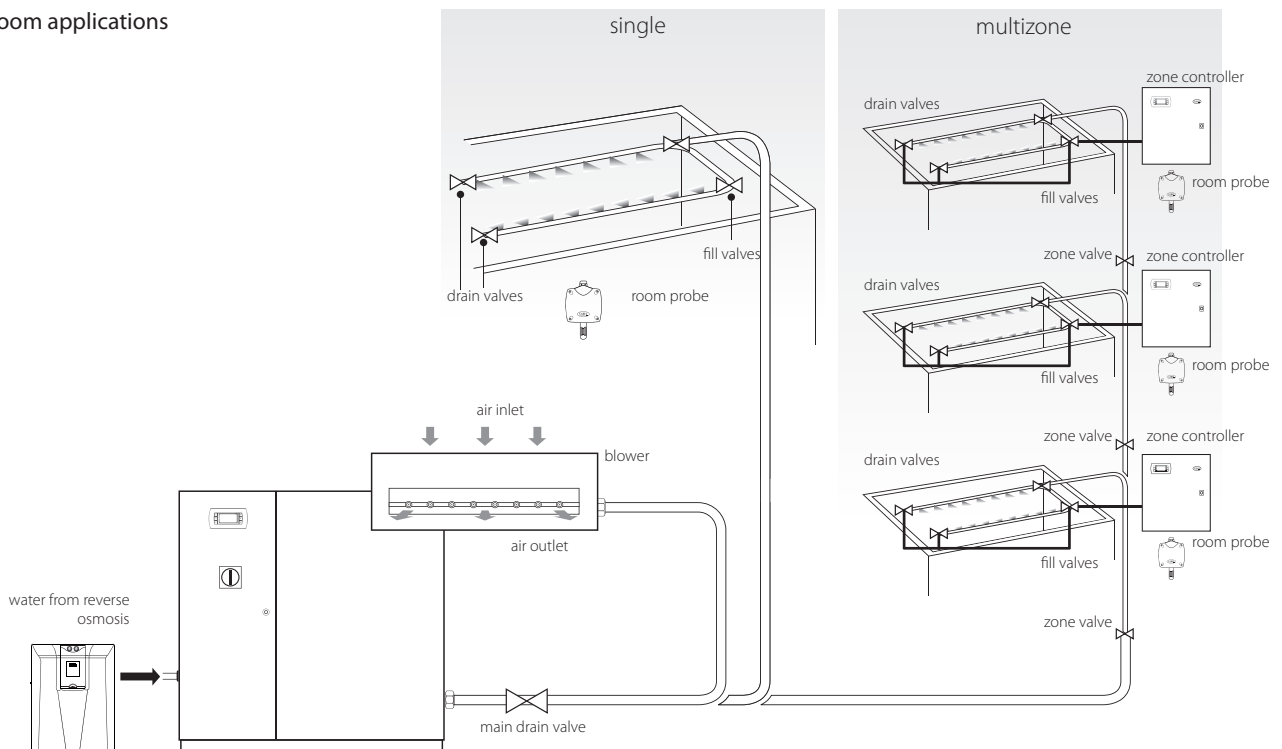



Compressed air and water atomisers

Compressed air humidifiers are the ideal humidification solution whenever a compressed air supply is available, as is the case in many industrial applications, even if humidification systems are often fitted with a dedicated air compressor.

The humidifier essentially consists of a cabinet fitted with electronic controller that, using two independent connection pipe networks, supplies the spray nozzles with compressed air and water at the ideal pressure for instant operating conditions. The units can be installed inside an AHU or directly in the room where humidity needs to be controlled.

The greatest advantage of these atomisers is the minute dimensions of the droplets produced and their thorough mixing in the compressed air that, due to its speed, distributes the aerosol in the room and consequently allows quick absorption. These units can therefore be readily used for direct cooling in rooms, and are ideal for the textile industry, wood and paper processing, and storerooms, where there is almost always a supply of compressed air.

mc multizone features an electronic controller that manages the supply of water and compressed air to the nozzles. Water atomisation is managed by an external control signal or, in the case of stand-alone control, so as to maintain the humidity/temperature set point.

The unit also manages a series of automatic cycles, such as nozzle cleaning and washing.

The system has the ability to control humidity independently in multiple zones (rooms, AHUs, cold rooms) using a master-slave layout. The layout has one master and multiple slaves (up to 5) connected in a pLAN. The master is fitted with a display for accessing the readings, viewing the status and messages on the master and slaves. The slaves have their own internal controller and can be set to continue operating even if connection to the master is interrupted.

The master slave configuration can be used for:

- **high capacity:** applications in rooms or ducts where more than 230 kg/h of humidification is required, and thus more than one mc cabinet. The control signals (probes, external signals, limit probe) are connected to the master only. The master and the slaves generate a humidification/cooling capacity that is proportional to demand and their capacity. This allows systems to be developed with a capacity up to 1380 kg/h;
- **multizone applications:** applications in multiple zones, rooms or ducts, each with its own humidity/temperature set point. All the parameters, status information and messages for all the

cabinets can be viewed and edited from the user interface on the master. Installations in large spaces can be divided into zones, each with their own humidity/temperature probe, using the multizone master slave system.

Automatic nozzle self-cleaning system

Each cabinet, master and slave, periodically activates a cycle for drying and cleaning the atomising nozzles. A special cleaning piston inside the nozzle is periodically pressed, by a spring, into the opening of the nozzle, removing any mineral salts and considerably reducing the need for cleaning.



mc multizone

MC*

Guaranteed hygiene

mc multizone ensures a very high level of hygiene, through:

- automatic emptying of the water line whenever the unit stops;
- automatic periodical washing of the water line during inactivity.

This prevents the nozzles from spraying stagnant water. In addition, an effective UV sanitising lamp can also be installed upstream of mc multizone; this shines UV light ON the flow of supply water, helping eliminate any biological contaminants such as bacteria, viruses, mould, spores and yeast that may be in the water.

Water quality for mc multizone systems

The constructional and functional features of the mc multizone allow the use of untreated drinking water. Nonetheless, the quantity and quality of dissolved minerals affect the frequency of routine maintenance operations (periodical cleaning of the nozzles) and the quantity of mineral dust deposited by the droplets of water after these have completely evaporated. For best operation, demineralised supply water by reverse osmosis should be used. This is also specified by the main reference standards, such as UNI 8884, VDI6022 and VDI3803.

Compressor

mc multizone requires compressed air, provided by an external compressor, not supplied by CAREL. The volume of air at standard atmospheric pressure required to atomise one litre of water is 1.27 Nm³/h, compressed to a pressure between 4 and 10 bars.

Accessories

Nozzles and assembly kits

(MCA* and MCK1AW0000)

AlSi316 stainless steel nozzles are available with different capacities, however all with the same outside dimensions.

Model	Capacity
A	2.7 l/h
B	4.0 l/h
C	5.4 l/h
D	6.8 l/h
E	10 l/h

Compressed air consumption: each 1 kg/h of atomised water requires 1.27 Nm³/h of compressed air.

Dripping is avoided thanks to the closing mechanism in periods of inactivity. The nozzle assembly kit includes the components required for assembly of a nozzle between a manifold in the water line and a manifold in the compressed air line, and is suitable for all types of mc nozzles.



Pressure sensor at the end of the line

(MCKPT*)

This is installed at the end of the compressed air line that supplies the nozzles. In this way, the controller can regulate air pressure to the optimum value (2.1 bars) at the nozzle that is furthest away, making up for pressure drop. This enormously simplifies setup of the installation, which will work perfectly right from the very first time.



Drain valve at the end of the line

(MCKDVWL*)

This is installed at the end of the water line that supplies the nozzles. In this way, mc multizone can empty the line when the unit is off and run the automatic periodical wash cycles. These procedures ensure a high level of hygiene by avoiding stagnated water in the line.



UV lamp disinfection system and filters

(MCKSUV0000, MCKFIL* and MCC*)

For optimum operation and to ensure maximum hygiene, a UV sanitising lamp and water filter are installed upstream of the cabinet. For the compressed air line, CAREL also provides a filter to trap any solid particles and an oil filter to remove any oil.



Pressure gauge at the end of the line

(MCKM*)

This has the same purpose as the pressure sensor at the end of the line, described above. In this case, the pressure generated by the cabinet can be adjusted manually so as to reach a pressure of 2.1 bars on the gauge at the end of the line.

A pressure gauge is also available for displaying water pressure at the end of the line.

Compressed air filter

(MCFILAIR01)

Installed before the mc multizone cabinet, this protects the nozzles against being clogged by particles contained in the compressed air line.

Compressed air oil mist eliminator

(MCFILOIL01)

The eliminator is needed to trap any oil leaks from the compressor.

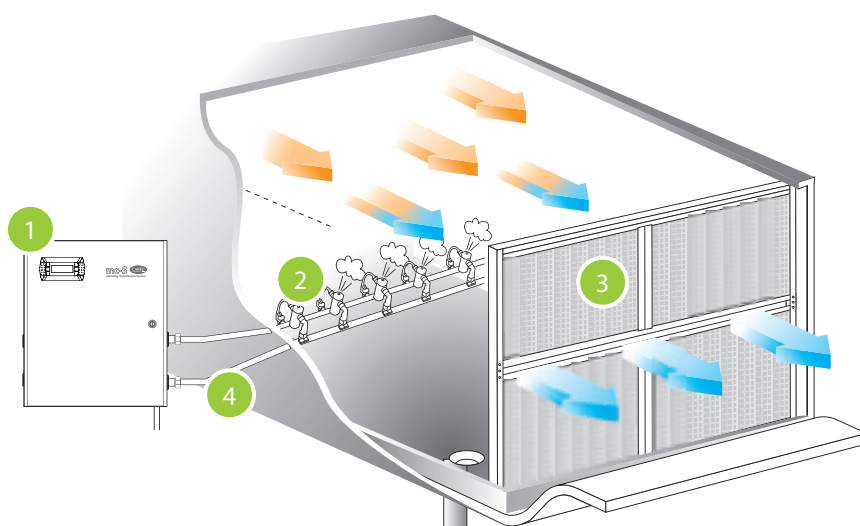

- 1 Cabinet: available in various models, according to maximum capacity, type of control (ON/OFF or modulating), type of supply water, master/slave and power supply.
- 2 Nozzles: as well as the special atomising nozzles, assembly kits are also available for installing each nozzle.
- 3 Mist eliminator: with fibreglass or AISI304 filtering mesh (the same used for humiFog).
- 4 Manifolds: stainless steel manifolds are available for installation in the ducts where the atomising nozzles are installed. Manifolds and lines for installations in rooms are not supplied.

Features	MC060*	MC230*
Maximum humidification capacity (kg/h)	60	230
Power supply	230 Vac single-phase, 50/60 Hz / 110 Vac single-phase 60 Hz, 37...48 W	
Operating conditions	1T40 °C, 0 to 80% RH non-condensing	
Storage conditions	-1T50 °C, 0 to 80% RH non-condensing	
Degree of protection	IP40	
Water fill		
Connection	1/2" G	1/2" G
Temperature limits (°C)	1T50 °C	
Water pressure limits (MPa - bar)	0.3 to 0.7 - 3 to 7	
Instant flow-rate (l/h)	60	230
Total hardness (ppm CaCO ₃) *	0 to 400	
Conductivity limits (µS/cm) *	0 to 1250	
Water drain		
Connection	TCF 8/10 or TCF 6/8 normal water model, TCF 8/10 demineralised water model	
Water outlet		
Connection	1/2" G	
Water pressure (MPa - bar)	0.035 + 0.01Δh - 0.35 + 0.1 Δh (Δh: height difference in metres between cabinet and nozzles)	
Air line		
Connection	1/2" G	
Temperature limits (°C)	1T50 °C	
Water pressure limits (MPa - bar)	0.5 to 0.7 - 5 to 7	
Outlet	1/2" G	
Air pressure (MPa - bar)	0.12 to 0.21 - 1.2 to 2.1 (intermediate pressure values available only on modulating versions)	
Nozzles		
Material	stainless steel (AISI 316)	
Nozzle capacity at 2.1 bars (kg/h)	2.7 - 4.0 - 5.4 - 6.8 - 10	
Network		
Network connection	Modbus®, LON, TCP/IP, SNMP	

(*) The mc system can operate on untreated drinking water. Nonetheless, the quantity and the quality of dissolved minerals affect the frequency of routine maintenance operations (periodical cleaning of the nozzles) and the quantity of mineral dust deposited by the droplets of water after these have completely evaporated. For best operation, demineralised supply water by reverse osmosis should be used. Softened water, on the other hand, should not be used as it does not reduce the concentration of mineral salts. In any case, observe the provisions of the UNI8884 standard "Characteristics and treatment of the water in cooling and humidification circuits", according to which the main water characteristics are conductivity < 100 µS/cm and total hardness < 5 °fH (50 ppm CaCO₃). Similar recommendations are also provided by VDI6022 and VDI3803.

Dimensions (mm) and weights (kg)

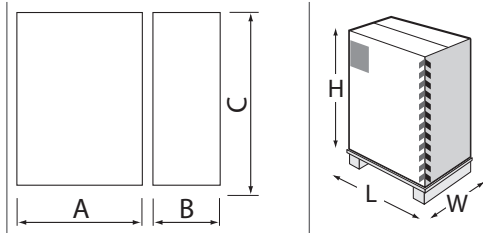

Model	AxBxC	weight	LxWxH	weight
MC*	515x165x580	19.5	605x255x770	21

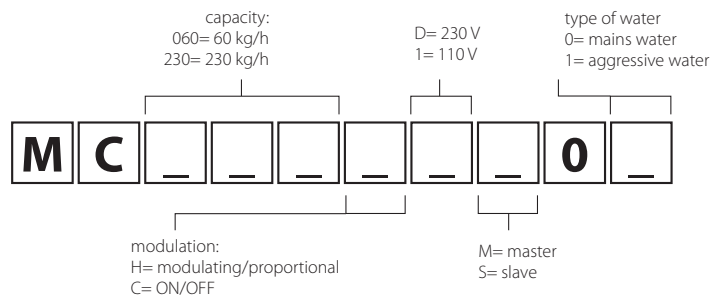

Unit code

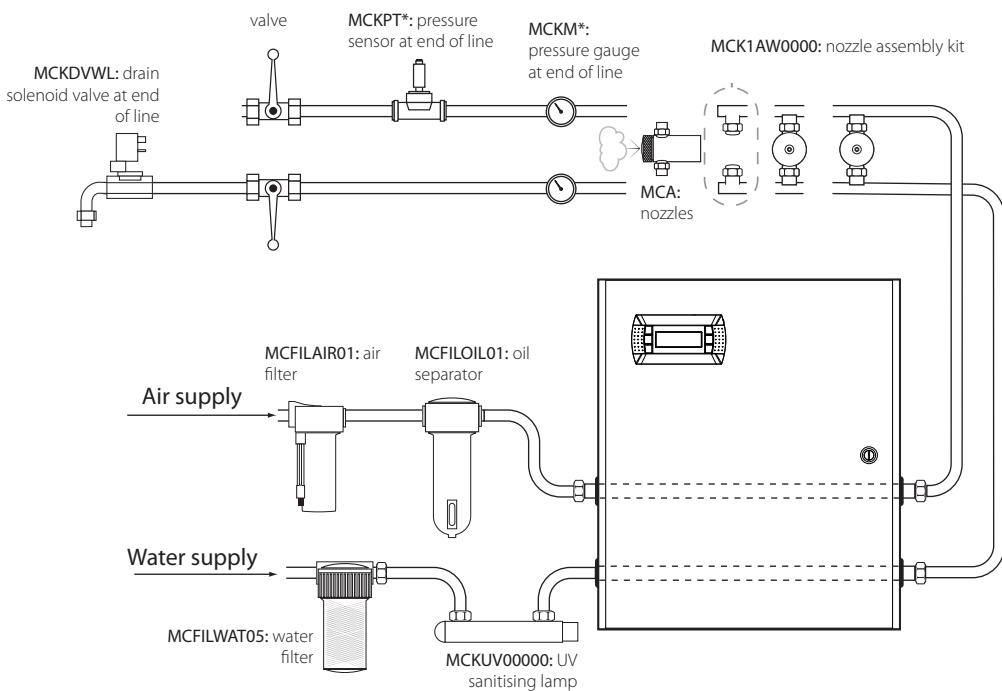

OVERVIEW DRAWING mc multizone

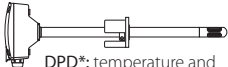

Probes

-  **DPP***: temperature and humidity probe for industrial environments
-  **DPD***: temperature and humidity probe for ducts
-  **DPW***: temperature and humidity probe for civil environments

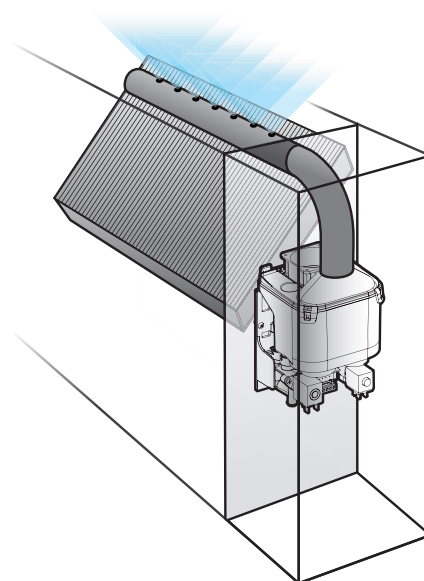

Ultrasound humidifiers

Ultrasound humidifiers feature a small water storage tank and piezoelectric transducers installed at the bottom of the tank.

The surface of the transducer oscillates at a very high speed (1.65 million times per second), so as to prevent the water from moving (the water cannot keep up with the oscillations of the transducer) due to its mass inertia. As a consequence, a column of water is generated above the transducers.

During the negative amplitude of the transducer, an instant vacuum is produced because the water cannot follow the very fast transducer movements. The cavity created allows the production of bubbles, which are pushed to the edge of the water column during the positive amplitude phase, where they collide. During this process, very fine particles of water are atomised on the edge of the column of water.

Due to the sound waves, cross waves are produced directly underneath the surface of the water, in the centre of which very small water droplets are separated thus generating a mist, which is absorbed immediately by the air stream.

Ultrasound technology applied to air humidifiers is an efficient and versatile solution:

- it is efficient because ultrasound humidifiers guarantee high energy saving (>90%) if compared to common

steam generators.

- it is versatile thanks to the dimensions of the droplets produced (average diameter of 0.005 mm). This fundamental feature guarantees rapid absorption of the atomised water in the surrounding area, thus preventing possible condensation.

humiSonic is the new ultrasound humidifier developed by CAREL. It has been developed to control and maintain the desired level of humidity for a specific environment constant. humiSonic, installed on fan coils, is the ideal solution for coupling accurate control of ambient humidity with common temperature control (guaranteed by the fan coils). The combination and accurate management of these two fundamental features of the air assure that comfortable conditions in the home or commercial environment can be reached and maintained.

The forced ducting system, installed between the coil and the air outlet, easily manages to evenly distribute the mist in the fan coil outlet duct.

By supplying humiSonic with a humidity probe and flow sensor (TAM), a complete solution is obtained that can operate completely independently!

Advantages

- significant energy saving;
- easy installation and maintenance;
- safe and guaranteed hygiene;
- accurate ambient humidity control.



humiSonic for fan coil

UU*

humiSonic, installed on fan coils, is the ideal solution for coupling accurate control of ambient humidity with common temperature control (guaranteed by the fan coils).

The combination and accurate management of these two fundamental features of the air assure that comfortable conditions in the home or commercial environment can be reached and maintained.

Energy saving

Ultrasound humidification is adiabatic, requires very low power consumption compared to steam solutions (40 W to atomise 0.5 kg/h of water). This important feature makes humiSonic an “Energy Saving” solution in line with modern energy saving expectations.

Easy installation and maintenance

Thanks to the compactness of its design humiSonic is easy to install in new generation fan coils and at the same time can be retrofitted on existing units! The maintenance of humiSonic consists only in periodic replacement of the transducers (once a year) and, thanks to the ergonomic design, this does not have to be performed by trained staff.

Hygiene

This is one of the main strong points of humiSonic and is guaranteed by three important characteristics:

- washing cycles are carried out periodically (even if humiSonic is in stand-by) thus preventing accumulation of dirt inside the tank;
- the drain valve ensures the humidifier empties completely once the humidification cycle has ended, also in the event of a power failure.
- the tank (made from plastic) also features silver ions, which are able to prevent proliferation of bacteria.

Complete solution

As humiSonic is fitted with an integrated control board, no external electric control board is required. The humidifier receives the power supply from the transducer (supplied complete with cable kit) while as a control signal it can be connected to a voltage-free contact (ON/OFF), be managed by the integrated micro probe (available as an accessory) or can be controlled via serial network with Modbus® or CAREL communication protocol. By installing an optional card, humiSonic can be managed with an external signal (e.g. 0 to 10 V, 4 to 20 mA...) or with other active probe models.

Supply water

humiSonic operates with demineralised water. Whenever normal water is used, the life span of the transducers will be decreased; in particular, the more mineral salts the water contains the shorter the maintenance interval for cleaning or replacement of the transducers.

Accessories



Dedicated humidity probe

HYHU000000

The humidity probe (supplied as an optional component) must be installed in the fan coil air intake circuit. humiSonic compares the value of the humidity present in the environment (measured via probe), against the set point and consequently modulates the production of mist in order to maintain the desired value. The small size of the probe (Ø= 20 mm L= 71 mm) simplifies installation inside the fan coil.



Flow sensor

UUKTA00000

The flow sensor can perform the important remote ON/OFF function and must be connected to the fan coil fan neutral wire. On measuring current, the flow sensor will enable or disable production of mist. In this way, the humidifier will only operate when the fan coil is running, irrespective of ambient conditions.



Display and optional card

UUKDI00000, UUKAX00000

With the optional card, humiSonic can:

- be connected to the display; in this way, access is available to the list of parameters in order to optimise the configuration of humiSonic and adapt it to particular application requirements.
- receive a signal from an external controller (0 to 10 V, 2 to 10 V, 0 to 20 mA, 4 to 20 mA) or from an active probe.



Distribution system

The distribution systems offered as an accessory allow easy and safe installation.

The kits are made up of a part in flexible plastic measuring 700 mm in length (to be connected to the humiSonic manifold) and a part in stainless steel to be installed between the coil and the fan coil outlet grill, available in three lengths: 250, 530 and 600 mm.

humiSonic table

Features	UU01F*0	UU01F*A0
Mist production	0.5 kg/h - 1.1 lb/h	
Mist outlet	Ø= 40 mm	
Supply water inlet	G 1/8" F	
Supply water temperature	from 1 to 40 °C - from 33.8 to 104 °F	
Supply water pressure	from 0.1 to 6 bars - from 14.5 to 87 psi	
Fill flow rate	0.6 l/min	
Supply water	Demineralised (the use of mains water does not compromise correct operation of humiSonic, however, reducing the life span of the piezoelectric actuators, it means that routine maintenance operations must be more frequent).	
Drain water outlet	10 mm	
Drain flow rate	7 l/min	
Power	40 W	
Power supply voltage	mod. D= 230 V 50 Hz, mod. 1= 115 V 60 Hz	
Current draw	0.5 A	
Power cable section	1.5 mm ²	
Dimensions	125x121x221 mm (4.92x4.76x8.70 inch)	
Control signals		
ON/OFF enabling	●	●
HYHU000000 humidity probe (to be installed in the fan coil intake line)	□	□
UUKTA00000 flow sensor to be connected to the neutral wire of the fan coil power supply.	□	□
BMS Serial (CAREL or Modbus® protocol).	●	●
Signal from active probe		□
External control signals (0 to 10 V, 4 to 20 mA)		□

- standard
- optional

Dimensions in mm (inch) and weights in kg (lbs)

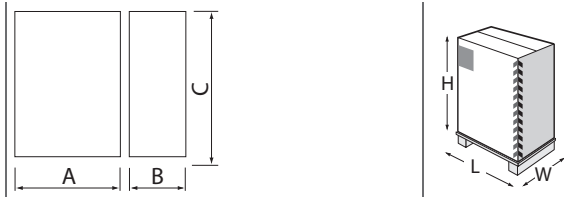

Mod.	AxBxC	weight	LxWxH	weight
UU01F*	125x121x221 (4.92x4.76x8.70)	2,8 (6.17)		3,9 (8.6)

Unit code

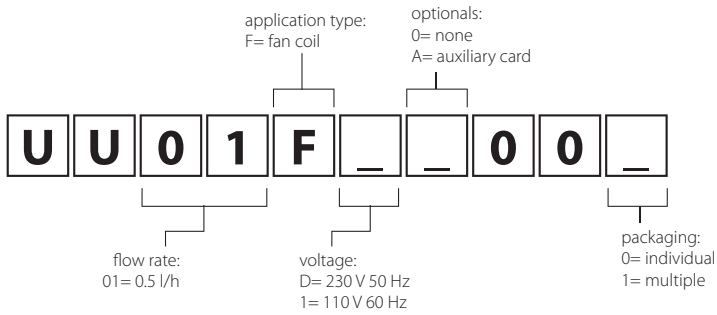

OVERVIEW DRAWING humiSonic

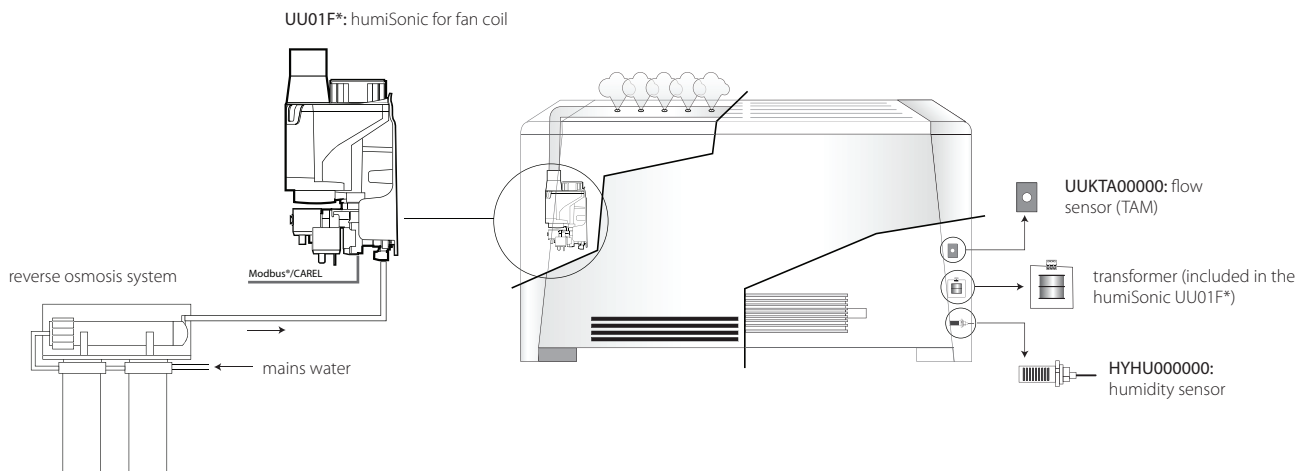



Centrifugal humidifiers

humiDisk is a small yet sturdy humidifier that uses a spinning disk to atomise water and transform it into millions of very small droplets that, blown by a built-in fan, are introduced into the environment, where they evaporate, humidifying and cooling the air.

Very low power consumption

humiDisk is a simple, economic and easy to maintain humidification system, with an energy consumption of just 220 W for 6.5 kg/h of capacity (31 W for the 1.0 kg/h model).

Guaranteed hygiene

The water tank inside the humiDisk contains just 0.055 litres of water, which is atomised, at maximum capacity, in just 30s for the 6.5 kg/h model and 3 minutes for the 1 kg/h model. The water in the tank is therefore changed very rapidly, meaning the humidifier substantially works with non-stagnant running water, so as to guarantee the best hygiene conditions.

Adjustable capacity (humiDisk₆₅ only)

Operation of humiDisk₆₅ controlled by an electronic board fitted with a trimmer for setting humidifier capacity, from 1.1 to 6.5 kg/h, making it suitable for all applications.

Automatic washing cycles (humiDisk₆₅ only)

The board, as well as managing normal unit operation, also performs a tank washing cycle when starting the unit, and an emptying cycle when humidification is no longer required. This avoids having stagnant water inside the unit.

Important: to ensure a higher level of hygiene, when using the CAREL electrical control panels, the humidifier also washes the water tank at the start of each humidification cycle.

Water used

humiDisk can operate on both mains water or treated water. The quantity and quality of the minerals dissolved in the water affect the frequency of the routine maintenance operations and the amount of dust generated. For best operation, use demineralised water (do not use softened water, as this does not reduce the content of minerals dissolved in the water).

In any case, observe the requirements of UNI8884 standard "Characteristics and treatment of the water in cooling and humidification circuits", according to which the main characteristics of the water are conductivity < 100 µS/cm and total hardness < 5 °fH (50 ppm CaCO₃). Similar requirements are also specified in standards VDI6022, VDI3803.

Benefits

- Simplicity:
 - requires just the 230 Vac power supply and the mains water and drain lines;
 - operation is ON/OFF;
- hygienically safe:
 - very small water tank, just 55 ml;
 - washing procedure at unit start;
 - emptying at the end of the humidification cycle;
 - washing procedure at the beginning of every cycle (with CAREL control panel only);
- modularity: 1 or 2 humiDisk₆₅ units can be controlled in parallel using the special control panel, or up to 10 humiDisk10 units using the CAREL humidistat



humiDisk₁₀ & humiDisk₆₅

UC*

Applications

- cold rooms, storage facilities and ripening rooms for products, such as fruit and vegetables, where low humidity level causes weight loss and product spoilage;
- printing facilities, where the correct level of humidity must be maintained to avoid variation in paper size and consequent misprints; the correct humidity value reduces the probability of electrostatic discharges and adhesion of the sheets of paper;
- textile industries, where maintenance of the required humidity according to the production process and the type of material used is fundamental.

Assembly and accessories

humiDisk can be wall-mounted or hung by chains from the ceiling.

humiDisk₆₅ is complete with accessories for wall and ceiling mounting, as well as the water fill and drain hoses.

humiDisk₁₀ is available in two versions:

- with accessories for ceiling installation only;
- also complete with wall-mounting bracket and water fill and drain hoses.

Accessories



UV lamp disinfection system

(MCKSUV0000)

To guarantee maximum hygiene, a UV sanitising lamp can be installed upstream of the humidifier. The lamp shines UV light on the flow of supply water, helping to eliminate any biological contaminants that may be present, such as bacteria, viruses, mould, spores and yeast.



Humidistat

(UCHUMM0000)

This simple and low-cost mechanical humidistat can be connected directly to one or more humiDisk units (up to a maximum of 10 units in parallel, for humiDisk₁₀ or one humiDisk₆₅). Used to set the desired humidity by simply turning the knob.



Electrical panels with electronic humidity controller

(UCQ065D*00)

CAREL supplies electrical panels fitted with electronic humidity controller. By connecting a humidity probe to the controller, this can activate one or two humiDisk₆₅ units, in parallel, so as to maintain the humidity level to the set value. The humidity measured by the probe can be read on the display of the controller. The humidity probe is not included in the electrical panel.

Frost protection device (humiDisk₆₅ only)

(UCKH70W000)

humiDisk₆₅ can be supplied with an optional frost protection device: an electric immersion heater, controlled by the electronic board and a temperature sensor that is activated when the temperature inside the unit approaches 0 °C. The appliance can operate at temperatures down to around 1 °C without the frost protection device, and down to -2 °C with the device (optional). This is especially useful for applications in fruit and vegetable cold stores.

Features	humiDisk ₁₀	humiDisk ₆₅
Capacity	1 kg/h at 230 V 50 Hz 1.2 kg/h at 110 V 60 Hz	6.5 kg/h, adjustable from 0.85 to 6.5 kg/h
Power supply	230 V, 50 Hz - 110 V, 60 Hz	230 V, 50 Hz - 110 V, 60 Hz
Power consumption	31 W	230 W - (290 W with frost protection device)
Air flow-rate	80 m ³ /h (47 CFM)	280 m ³ /h (165 CFM)
Water content	0.055 litres	0.055 litres
Operating conditions	1T35 °C (34T95°F)	1T35 °C (34T95°F) WITHOUT frost protection device
		-2T35 °C WITH frost protection device (not available for American version)
	0 to 100% RH non-condensing	0 to 100% RH non-condensing
Frost protection heater	no	yes (European version only)
Degree of protection	IPX4	IPX4
Electronic board for capacity control		●
Electrical panel with electronic humidistat		□
Mechanical humidistat	□	□
Installation accessories	accessories for ceiling-hung installation INCLUDED. Accessories for wall mounting and hoses NOT INCLUDED, available as options.	accessories for ceiling-hung AND wall-mounted installation and fill and drain hoses included.
Certification	CE and ETL	CE and ETL
Fill connections	Ø10 mm (OD)	3/4 G
Drain connection	Ø10 mm (OD)	3/4 G
Water		
Supply water pressure	100 to 1000 kPa	100 to 1000 kPa
Water temperature limits	1T50 °C (33.8T122 °F)	1T50 °C (33.8T122 °F)
Water total hardness limits (*) (**)	max 30 °FH (max. 300 ppm CaCO ₃)	max 30 °FH (max. 300 ppm CaCO ₃)
Water conductivity limits (**)	100 to 1200 µS/cm	100 to 1200 µS/cm

(*) not less than 200% Cl- in mg/l

(**) The quantity and quality of the minerals dissolved in the water affect the frequency of the routine maintenance operations and the amount of dust generated. For best operation, use demineralised water (do not use softened water, as this does not reduce the content of minerals dissolved in the water). Observe the requirements of UNI8884 standard "Characteristics and treatment of the water in cooling and humidification circuits", according to which the main characteristics of the water are conductivity < 100 µS/cm and total hardness < 5 °fH (50 ppm CaCO₃).

● standard

□ optional

Dimensions in mm (inches) and weights in kg (lbs)

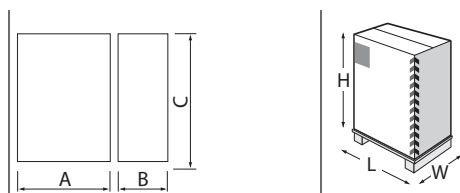

Model	AxBxC	weight	LxWxH	weight
UC010	302x390x312 (11.89x15.35x12.28)	4.3 (9.48)	400x400x350 (15.75x15.75x13.78)	5 (11.02)
UC065	505x610x565 (19.88x24.01x22.24)	17.6 (38.80)	640x600x665 (25.20x23.62x26.18)	20 (22.24)

Positioning

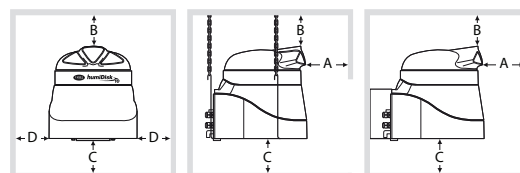

humidifier	distance (m)			
	A	B	C	D
UC010	≥2	≥0,5	≥1,5	≥0,5
UC065	≥3	≥1	≥1,5	≥0,5

Unit code

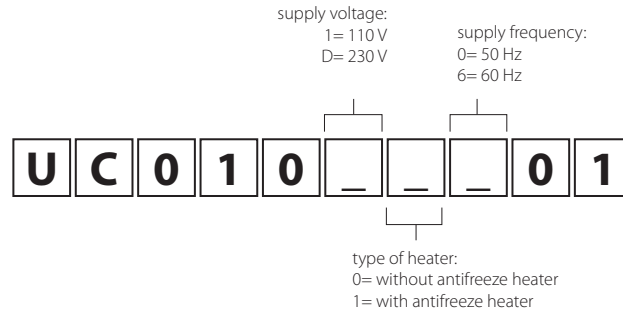

OVERVIEW DRAWING humiDisk10

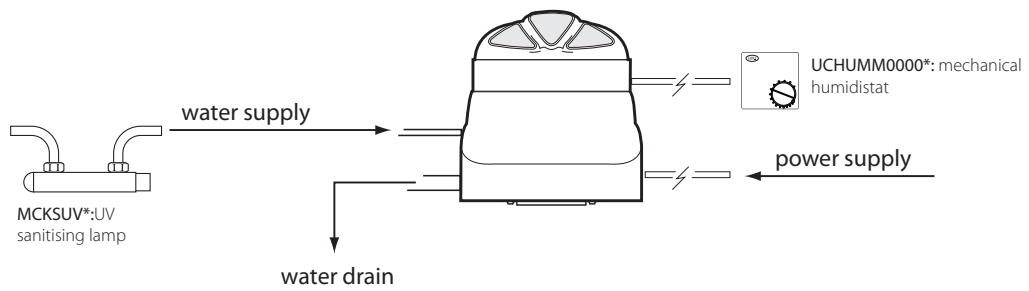

Unit code

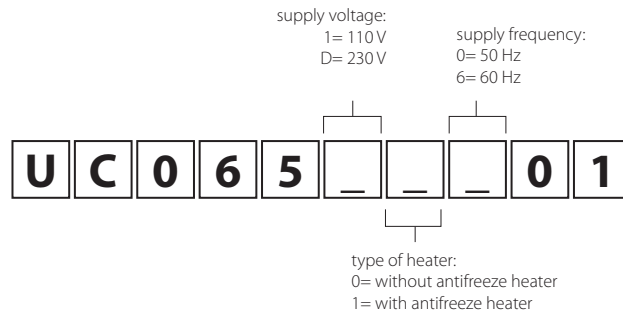

OVERVIEW DRAWING humiDisk65

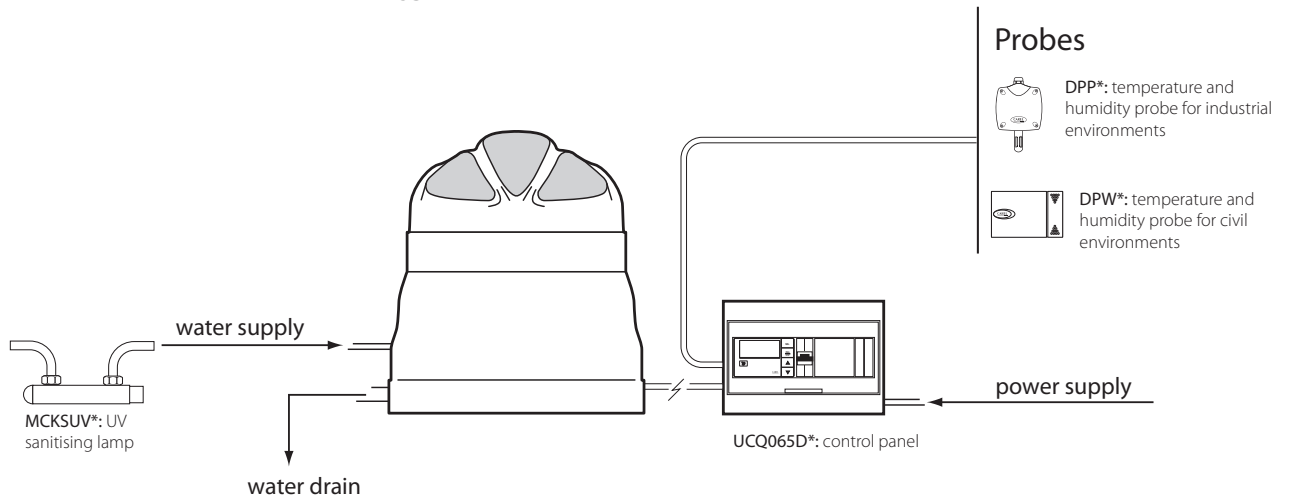

Evaporative cooling



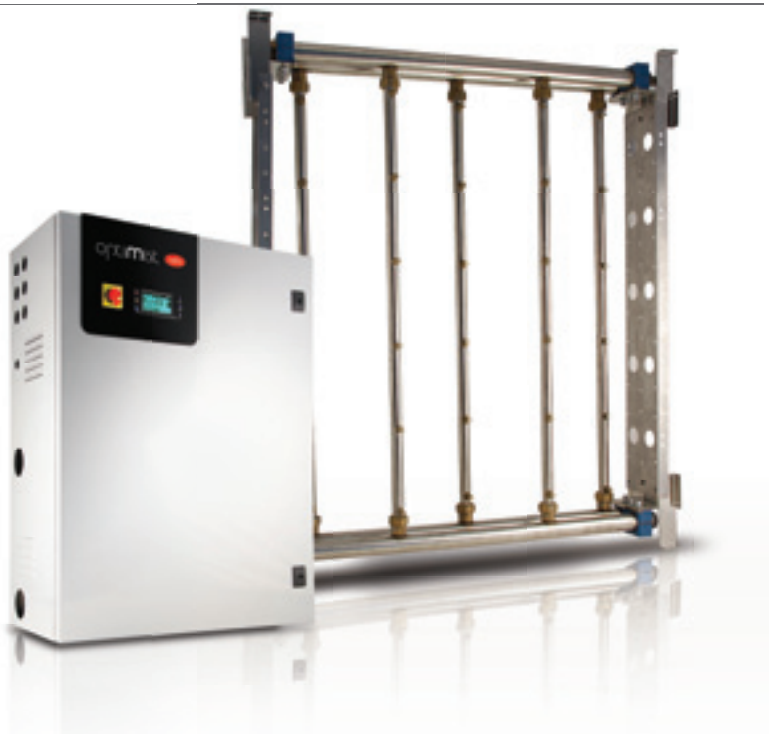

Atomisers - evaporative cooling

“Evaporative Cooling” is the process in which water cools the air through evaporation. For this to happen spontaneously, without the contribution of external energy, the water must be atomised in the air as very fine water droplets which, having a lower surface tension than the surrounding air, evaporate into the air.

Why does the air cool down?

No contribution of external energy is necessary, however, owing to its nature, the water evaporation process requires a certain amount of energy. This energy is removed from the air itself which, in order to absorb the water must release sensible heat, thus lowering its own temperature. Every kilogram of water that evaporates absorbs 0.69 kW of heat from the air. This is how the dual humidification and cooling effect of the air is obtained through the Evaporative Cooling process, which in many air handling applications represent two desired effects.

Energy Saving

The rapid development of evaporative cooling in HVAC applications is surely due to its very low energy impact. If we compare the cost for energy regarding Evaporative Cooling with that of other types of air transformations (e.g. humidification with steam emission or air cooling via chiller), it can be seen that the energy saving is considerable. The only energy required is for water pressurisation,

which is sent to the atomiser nozzles by a pump. Consumption is about 4 to 8 W for every l/h of atomised water.

Optimist atomisers

CAREL supplies a complete range of products that make use of the principles of evaporative cooling and all its advantages. The standard composition of these products is:

- cabinet, containing the pump for pressurising the water, an inverter and an electronic controller for modulating the production of atomised water instant by instant;
- atomiser nozzles, able to atomise the water into very fine water droplets (in the order of a few hundredths of a millimetre), extending the heat exchange surfaces.
- distribution system, composed of stainless steel manifolds, atomiser nozzles and drain valves, in order to guarantee emptying.

Advantages

- energy saving: combines adiabatic humidification and evaporative cooling in a single global solution for energy saving within the AHU.
- pressure loss management: optiMist guarantees real energy savings, assuring a very low pressure drop at the fans (30 Pa);
- controlled atomisation: in order to completely exploit the potential of evaporative cooling and without waste, it is necessary to have very accurate control of the amount of water atomised, instant by instant. By combining the action of the inverter and the modulation circuits, Optimist can precisely follow temperature and humidity demand;
- hygiene: thanks to the materials used, the design of the distribution systems without stagnation points and the automatic washing systems managed by the electronic controller, Optimist is a hygienically safe solution for adiabatic humidification and evaporative cooling within the AHU.



optiMist

EC**

optiMist is an evaporative humidifier and cooler that atomises water into very small droplets which, by evaporating spontaneously, extract heat from the humidified and cooled air. It uses an impeller pump to pressurise the water, atomising it successively through special nozzles.

The sophisticated control system combines the action of an inverter, which controls speed and therefore pump displacement, with that of 2 solenoid valves that activate only the nozzles necessary. This allows the system to always work at the best pressure for atomising the water, within a wide flow rate range.

The cooling effect of the air is due to the spontaneous evaporation of the water droplets: the change of state from liquid to vapour takes place at the expense of the energy in the air, which cools down as a consequence.

optiMist is a complete system, which includes humidification and evaporative cooling in a single solution, and can be used to handle air in an AHU (air handling unit), and to humidify the flow air (direct evaporative cooling) and also for indirect cooling of fresh air, for example with a cross-flow heat recovery unit, so as to increase energy efficiency of the AHU.

System components

- pumping station that pressurises the water (4 to 15 bars): this also contains the electronic controller that completely manages the pumping station, controlling the temperature/humidity in each optiMist section. As it is fitted with an inverter and pressure probe, it can control the flow rate produced moment by moment, thus guaranteeing maximum accuracy and minimum energy and water consumption;
- distribution system: this is made up of stainless steel piping, fittings for compression joints, atomiser nozzles and drain valves (mechanical valves or

optional solenoid valves managed by the pumping station). optiMist can be coupled with a distribution system with twin modulation circuits for precise temperature and humidity control or, coupled with two distribution systems it becomes an integrated solution for the management of evaporative cooling (with a single pumping station, without the addition of electric control boards).

- droplet separator: necessary to prevent condensation in the AHU outside the sections dedicated to humidification or evaporative cooling. The optional drain structure also facilitates installation and successive maintenance of the droplet separator; the filtering modules are in fact removable from the front without disassembling the structure.

Hygiene

All CAREL atomisers are designed following the VDI6022 standard guidelines. In particular, for the products that make use of evaporative cooling, the sophisticated electronic system that governs the distribution line drain solenoid valves prevents stagnating water from stopping in the piping; a main danger for the proliferation of bacteria.

Automatic washing is also managed by the distribution lines at the time interval set by the user.

All CAREL atomisers can be used (as further hygienic safety and to reduce maintenance) with dematerialised water.

The installation of the optional UV lamp guarantees further cleaning and disinfection of the water entering the atomiser.

Supply water.

Following the evaporation process, the mineral salts dissolved in the supply water are in part destined to deposit on the surface of the droplet separator.

The nature and quantity of the mineral salts contained in the water determine the frequency of routine maintenance

operations necessary to remove said deposits from inside the AHU.

In order to maintain the hygiene of the installation and to reduce system management costs, CAREL recommends to supply optiMist with demineralised water via reverse osmosis, as envisioned in the main standards such as UNI 8884:

- conductivity <100 S/cm;
- total hardness <5 °fH (50 ppm CaCO₃);
- 6.5 <pH < 8.5;
- chlorides content <20 mg/l;
- silica content <5 mg/l;

If demineralised water is not available, softened water can be used. In this case, in order to limit aggressiveness, it is recommended to guarantee minimum hardness not lower than 3°f.

CAREL recommends the use of mains water only if this has hardness lower than 16°f or conductivity lower than 400 µS/cm. The use of mains water will lead to routine maintenance operations (cleaning or replacement of the nozzles and the droplet separator), whose frequency depends on the chemical composition of the water itself.

Accessories and options



Drain valves

(ECKD*)

This is installed in the distribution system drain circuit in order to allow complete emptying. Thanks to these valves, periodic washing cycles can be planned automatically. These are very important for guaranteeing system hygiene. The ECKDSV0000 solenoid valves, controlled electrically by the optiMist cabinet or ECKDMV0000 mechanical valves, which open and close depending on working pressure can be used according to application requirements and the type of water used.



Drop separator for AHU/certified duct

(UAKDS*, ECDS*)

The droplet separator has the purpose of capturing the droplets of water that have not completely evaporated to prevent them passing beyond the evaporative humidification/cooling section. It is supplied in easy-to-assemble modular panels to cover the cross-section of the AHU.

The pressure drop of the droplet separator is very low, only 30 Pa with air speed of 3.5 m/s. The support structure of the droplet separator is always in stainless steel and guarantees quick and efficient draining of the water. The droplet separator can be supplied with glass fibre or stainless steel modules according to application requirements.



Differential pressure switch

DCPD0*0*00

Device for controlling the differential pressure of the air for the droplet separator. The differential pressure switch allows continuous monitoring of the pressure drop on the fans in order to guarantee global energy saving within the AHU.



Flexible hose

(ACKT*)

AISI304 stainless steel flexible corrugated hoses for connection of the pumping station to the distribution system. The following hose lengths are available: 1, 2 and 10 m.

Table of model features

Features	EC005*	EC010*	EC020*	EC040*	EC080*	EC100*
General						
Power supply	EC*0= 230 V, 1 phase, 50 Hz EC*U= 230 V, 1 phase, 60 Hz					
Power consumption	0.375 kW				0.75 kW	
Current	1.6 A	1.6 A	1.7 A	1.7 A	3.0 A	3.2 A
Operating conditions	5 to 40 °C (34 to 104 °F) <80% R.H. non condensing					
Water supply						
maximum flow rate	50	100	200	400	800	1000
pressure	0.2 to 0.7 mPa					
connection:	EC*0= G3/4" f EC*U= NPT 3/4" f					
Water drain						
connection	stainless steel coupling G3/4f ID, OD ~35 mm/ 1.18 inch.					

Dimensions in mm (inches) and weights in kg (lbs)



Model	AxBxC	weight	LxWxH	weight
EC005*, EC010*	605x300x805 (23.62x11.82x31.50)	53 (117)	700x410x1020 (27.56x16.14x40.16)	56 (124)
EC020*, EC040*	605x300x805 (23.62x11.82x31.50)	55 (121)	700x410x1020 (27.56x16.14x40.16)	58 (128)
EC080*, EC100*	605x300x805 (23.62x11.82x31.50)	59 (130)	700x410x1020 (27.56x16.14x40.16)	62 (137)

Unit code

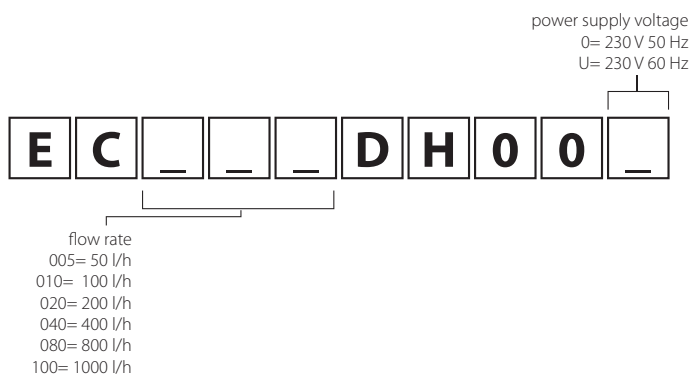

OVERVIEW DRAWING optimist

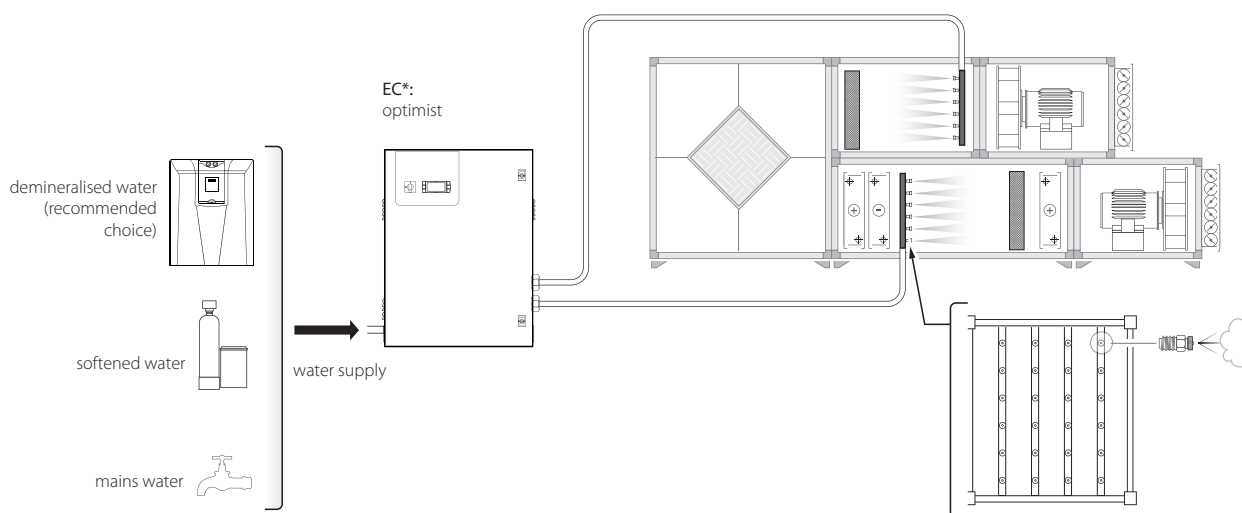



ChillBooster

AC100D*, AC050D*, AC010D*

ChillBooster is made up of a pumping station and a water distribution and atomisation system:

- an electrical panel for ON/OFF control of capacity;
- a pump power supply solenoid valve;
- inlet water pressure switch;
- an impeller pump with incorporated pressure adjustment valve calibrated at 10 bars;
- outlet pressure gauge;
- high temperature protection heating valve;
- drain solenoid valve for unit shutdown;
- modular stainless steel manifolds with 20 mm diameter;
- atomiser nozzles;
- distribution system drain solenoid valves, at line end;
- corrugated steel flexible connection hoses;
- metal compression fittings;
- UV system for cleaning and disinfecting water inside the cabinet (optional).

The pumping station is available in two versions: stainless steel version for demineralised water (recommended), or version for normal water with brass pump.

Supply and top-up water

ChillBooster can operate with untreated drinking water and with demineralised water.

Following the evaporation process, the mineral salts dissolved in the supply water are in part destined to be transported by the flow of air as a very fine dust and in part deposited on the surface of the heat exchange fins or in the pipes.

The problem is minimised with the use of demineralised water via reverse osmosis, as envisioned by the main standards, such as UNI 8884, VDI6022, VDI3803.

Applied to chiller/drycoolers, to limit the formation of deposits on the surface of the coils. Whenever untreated water is used it is recommended to limit the use of

ChillBooster only to when necessary and indicatively not over 200 h per year.

ChillBooster for chillers or drycoolers

Chillbooster cools the air before it is used by the unit for cooling the fluid in the coil. Atomisation takes place against the flow so that the droplets follow the longest route possible, in a way to have sufficient time to evaporate. The cooled air is extracted by the fans and therefore the heat exchange of the coil increases considerably! Part of the droplets will wet the coil fins: this water will tend to evaporate thus absorbing heat and contributing to the increase in capacity. Part of the water will fall onto the fins and must be drained.

ChillBooster allows liquid coolers and condensers to deliver rated capacity even in periods with high temperatures, which often coincide with maximum loads, without oversizing the systems.

pRack

pRack manages Chillbooster for air condensers, maximising performance during high summer temperatures and minimising energy consumption.



Components



Line end solenoid valve

½" GAS brass or stainless steel solenoid valve, normally open for draining water due to inactivity.



Manifold

AISI304 stainless steel, Ø20 mm manifolds, with threaded holes for nozzles, available with 7 holes (1052 mm), 13 holes (1964 mm) or 19 holes (2876 mm).



Quick couplings

Compression fittings for unthreaded Ø20 mm pipes in brass or stainless steel.



Flexible hose

AISI304 stainless steel corrugated flexible hoses.



Nozzles

Nozzles with capacity of 5, 7.5 or 15 kg/h at 10 bars.

Layout example for chiller or drycooler

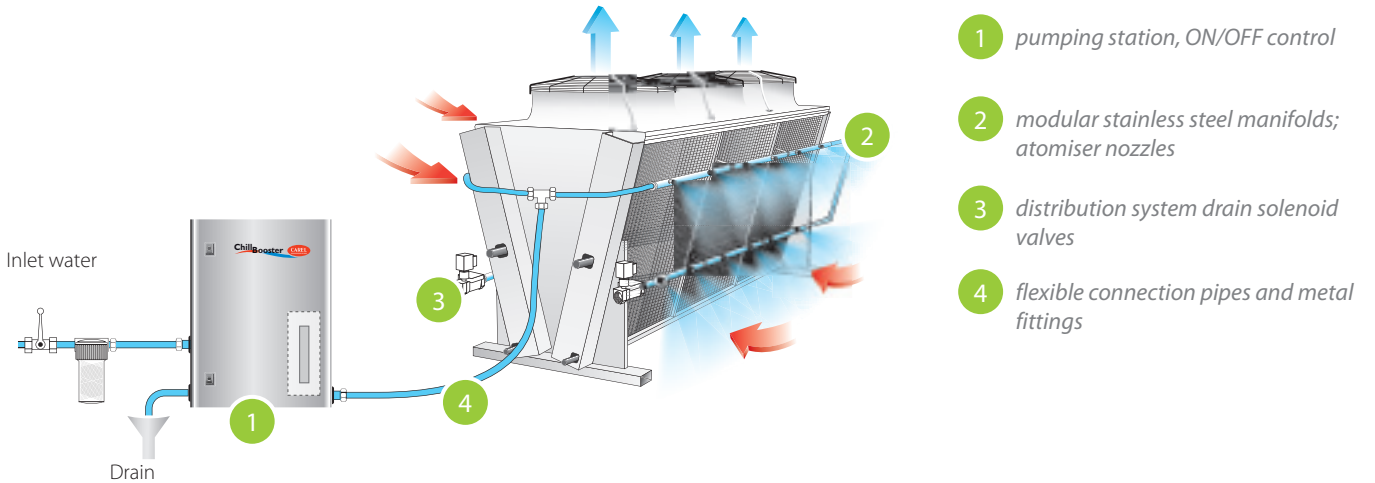

ChillBooster table

Features	AC010****	AC050D****	AC100D****
Flow rate (l/h)	100	500	1000
Power consumption	0,4	0,5	0,6
Temperature	5T40 °C (40-104 °F)		
Heat valve discharge connection	pipe OD 10, ID 5		
Electrical features	230 V, 50/60 Hz (depending on the model)		
Certification	CE		
UV lamp duration (optional)	4000 h		
Protection rating	IP55		
Water supply			
Connection	1/2" G female		
Pressure (min.-max.)	3-8 bars, 0.3-0.8 Mpa, 40-115 Psi		
Water drain			
Connection	1/2" G female		
Output			
Connection	1/2" G female		
Supply water*			
Conductivity	<100 µS/cm		
Total hardness	<5 °fH (50 ppm CaCO3)		

* see "Supply and top-up water"

Dimensions (mm(inch)) and weights (kg(lb))

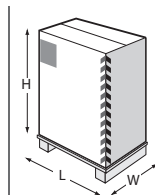
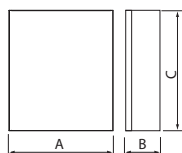

Model	AxBxC	weights	LxWxH	weights
AC*****0**	600x300x800 (23.62x11.82x31.50)	49 (108)	720x410x1020 (28.5x16x40)	52 (115)
AC*****01*	600x300x800 (23.62x11.82x31.50)	53 (115)	720x410x1020 (28.5x16x40)	56 (125)
AC*****K**	550x210x750 (21.65x8.30x29.53)	27 (60)	860x660x360 (34x26x14)	32 (70)
AC*****K1*	550x210x750 (21.65x8.30x29.53)	32 (70)	860x660x360 (34x26x14)	37 (82)

Unit code

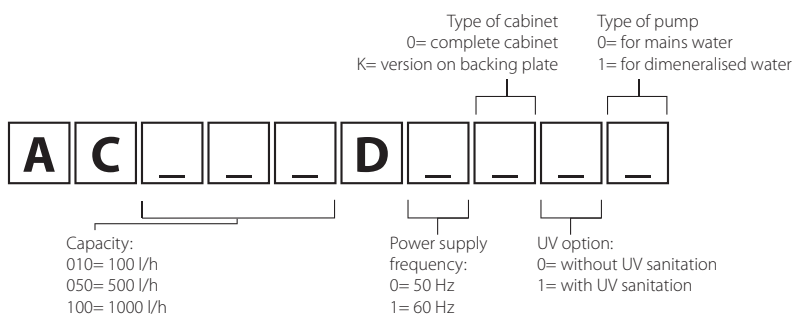

OVERVIEW DRAWING ChillBooster

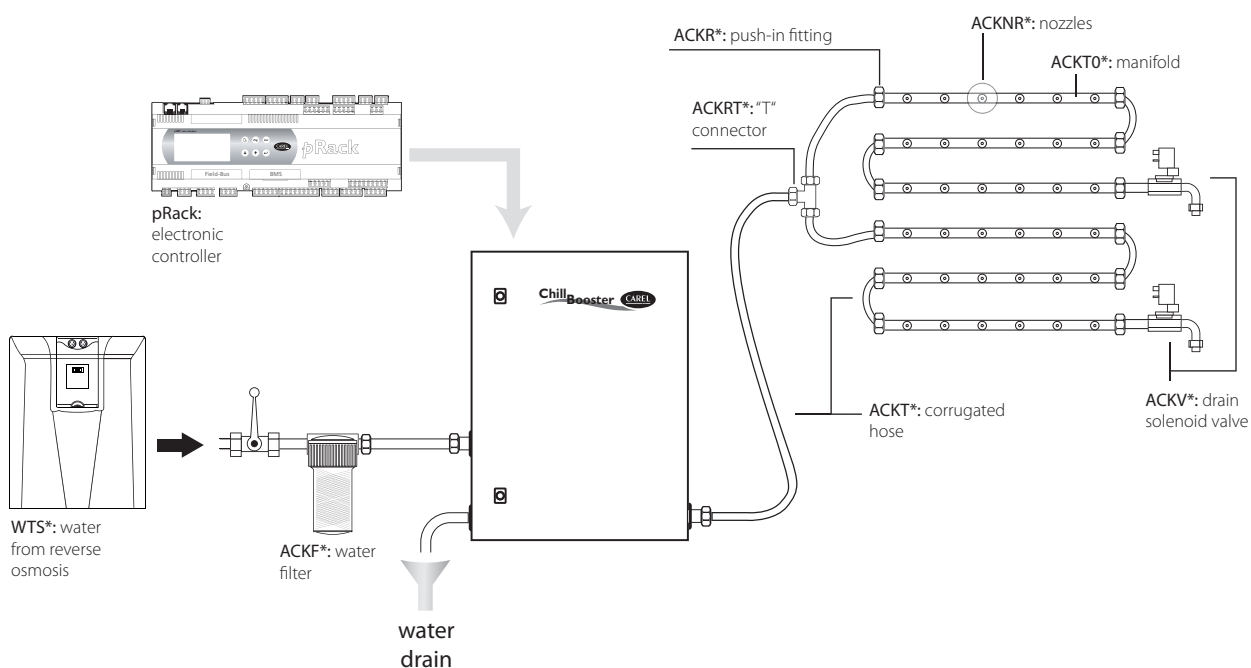

Water treatment systems

A close-up, grayscale photograph of a leaf with numerous water droplets of varying sizes on its surface. The leaf is positioned diagonally from the bottom right towards the top right. The background is a soft, out-of-focus light gray.



Water treatment

The CAREL reverse osmosis water treatment system has been designed for use with humiFog multizone, mc multizone, heaterSteam and gaSteam humidifiers. The system can also be combined with the ChillBooster for evaporative cooling.

Supplied with mains drinking water, it generates demineralised water with physical/chemical, flow-rate and pressure characteristics suitable to supply the humidifiers.

The strong points of this product are its completeness (no storage tank or pumping system is required) and compact dimensions.

What is reverse osmosis?

This is a technique in which the water being purified is pumped at high pressure and forced through a semi-permeable membrane with pores smaller than 0.001 µm in diameter: the majority of the dissolved ions are filtered by the membrane, thus producing relatively pure water. The removal of minerals, measured as a percentage of the original mineral content, may vary from 95% to 99% and even higher. Automatic operation and reduced operating costs (electricity required to pump the water) make the use of this technique quite extensive. Note however that reverse osmosis systems

are not ideal for treating water that is very hard and/or with significant quantities of contaminants: in these cases, to extend the operating life of the membrane, the water is pre-treated (filtering, deferrization, etc.).

Observations on water softening

Reverse osmosis is a completely different treatment from water softening, which simply decreases the hardness of the water without removing the mineral salts, rather replacing "fouling" salts, such as calcium and magnesium, with sodium.

Softening is therefore not recommended for use with adiabatic humidifiers. In addition, using softened water in isothermal humidifiers generates considerable amounts of foam and increases the risk of corrosion of the heating elements. In this case too, softened water is not recommended.

Why use demineralised water in humidifiers?

Isothermal humidifiers (steam): to reduce maintenance and unit downtime, minimising accumulation of mineral salts and scale in the cylinders

Adiabatic humidifiers (atomisers): to prevent scale in the nozzles, accumulation of mineral salts in air handling units (filters, mist eliminators) and avoid introducing mineral salts into the humidified rooms; to improve hygiene conditions in ventilation systems and reduce maintenance costs.

Limits on the maximum conductivity and hardness of water are specified by standards such as UNI8884, VDI6022, VDI3803, L8.

Benefits

- easy maintenance/start-up: WTS is pre-calibrated for simple and fast start-up. The automatic "flushing" procedure extends membrane life and reduces maintenance
- savings: by using a multi-stage centrifugal pump, WTS can deliver reverse osmosis water at the right pressure and flow-rate without requiring booster pumps and expansion vessels
- maximum hygiene: WTS provides reverse osmosis water only when required by the humidifier, thus avoiding storage. The water is also treated using the ultraviolet disinfection system.



WTS

CMR*

WTS contains all the components required for water treatment in just one, single optimised solution.

A typical reverse osmosis system consists of a frame housing the osmosis membrane, a storage vessel for the demineralised water and a pumping circuit to deliver pressurised water to the humidifier.

WTS, on the other hand, is directly controlled by the humidifier and produces demineralised water only when required. In this way, WTS doesn't store water in the tank and doesn't require a pumping circuit! As well as evident simplification of the system, absence of the storage tank ensures much better hygiene by avoiding stagnation of water and minimising maintenance.

The system consists of:

- micrometric safety pre-filtering (to remove "impurities" from the water);
- activated carbon dechlorination system;
- descaler liquid dosing system;
- electrical control panel;
- high pressure main pump;
- TFC reverse osmosis membrane;
- UV sanitation system (on models for adiabatic humidifiers).

All the components in the system are contained in a single skid to optimise costs, dimensions and simplify installation on site.

WTS must be commissioned and serviced by authorised CAREL personnel.

System commissioning is not included in the price and must be agreed upon in advance with CAREL.

Accessories



UV lamp disinfection system (MCKSUV0000)

To guarantee maximum hygiene, a UV sanitising lamp CAN BE installed upstream of the humidifier. The lamp shines UV light on the flow of supply water, helping to eliminate any biological contaminants that may be present, such as bacteria, viruses, mould, spores and yeast. Maximum flow-rate 240 l/h.



Antiscalant descaler liquid (CMROL00000)

25 kg container of descaler liquid. To guarantee perfect operation, the characteristics of the water must be provided in advance to CAREL, on a special form, so as to check compatibility with the treatment system. This information is usually available from the mains water supplier; often it is found free-of-charge on the supplier's website.

Installation example

Traditional installation, not optimised

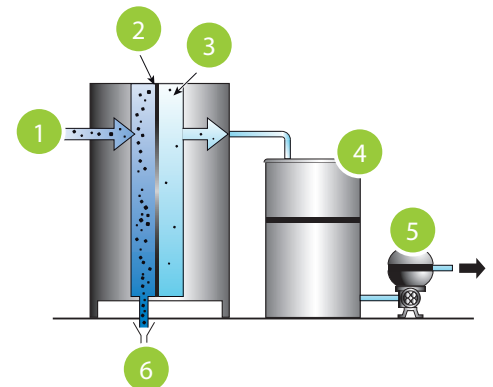

Optimised CAREL solution

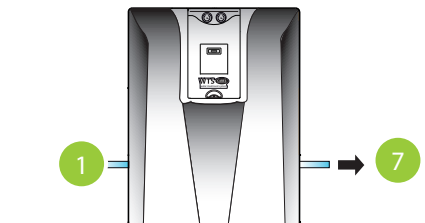

- 1 mains water inlet
(water + mineral salts)
- 2 membrane
- 3 demineralised water
- 4 storage tank
- 5 generic points of use
- 6 drain water
(concentrated mineral salts)
- 7 demineralised water
flow-rate and pressure guaranteed
for CAREL humidifiers

Table of WTS models

Features	CMR*000090	CMR*000180	CMR*UV0320	CMR*UV0600	CMR*UV1200
	for heaterSteam and gaSteam		for humiFog, mc and ChillBooster		
Maximum capacity of connected humidifier (l/h)	90	180	320	600	1200
Ultraviolet sanitation system			●	●	●
Water fill					
Water connection	3/4"				
Water inlet flow-rate (l/h)	600	100	600	1000	2000
Water inlet pressure (bar)	2.5 to 4				
Concentrated water drain					
Water connection	3/4"				
Water flow-rate (max) (l/h)	280	500	280	500	800
Demineralised water outlet					
Water connection	1"				
Maximum outlet flow-rate	5.3 l/min	10 l/min	320 kg/h	600 kg/h	1200 kg/h
Water					
Inlet water (*)	mains drinking water, conductivity < 1000 µS/cm				
Demineralised water outlet	conductivity of water produced ≤ 20 µS/cm				
Recovery factor	70%				

(*) To guarantee perfect operation, the characteristics of the water must be provided in advance to CAREL, on a special form, so as to check compatibility with the treatment system.

This information is usually available from the mains water supplier; often it is found free-of-charge on the supplier's website.

● standard

Dimensions in mm (inches) and weights in kg (lbs)

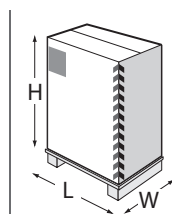
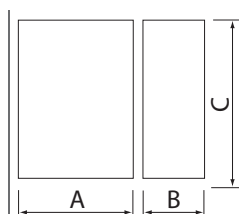

Model	AxBxCxD	weight	LxWxH	weight
CMRO****0	970x603x1539x1469 (381.89x237.40x605.90x578.35)	80 (176.37)	120x80x175 (4.72x3.15x6.89)	150 (330.69)

Unit code

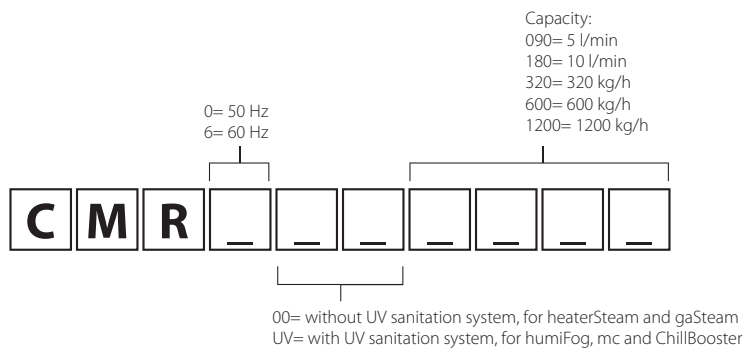

OVERVIEW DRAWING WTS

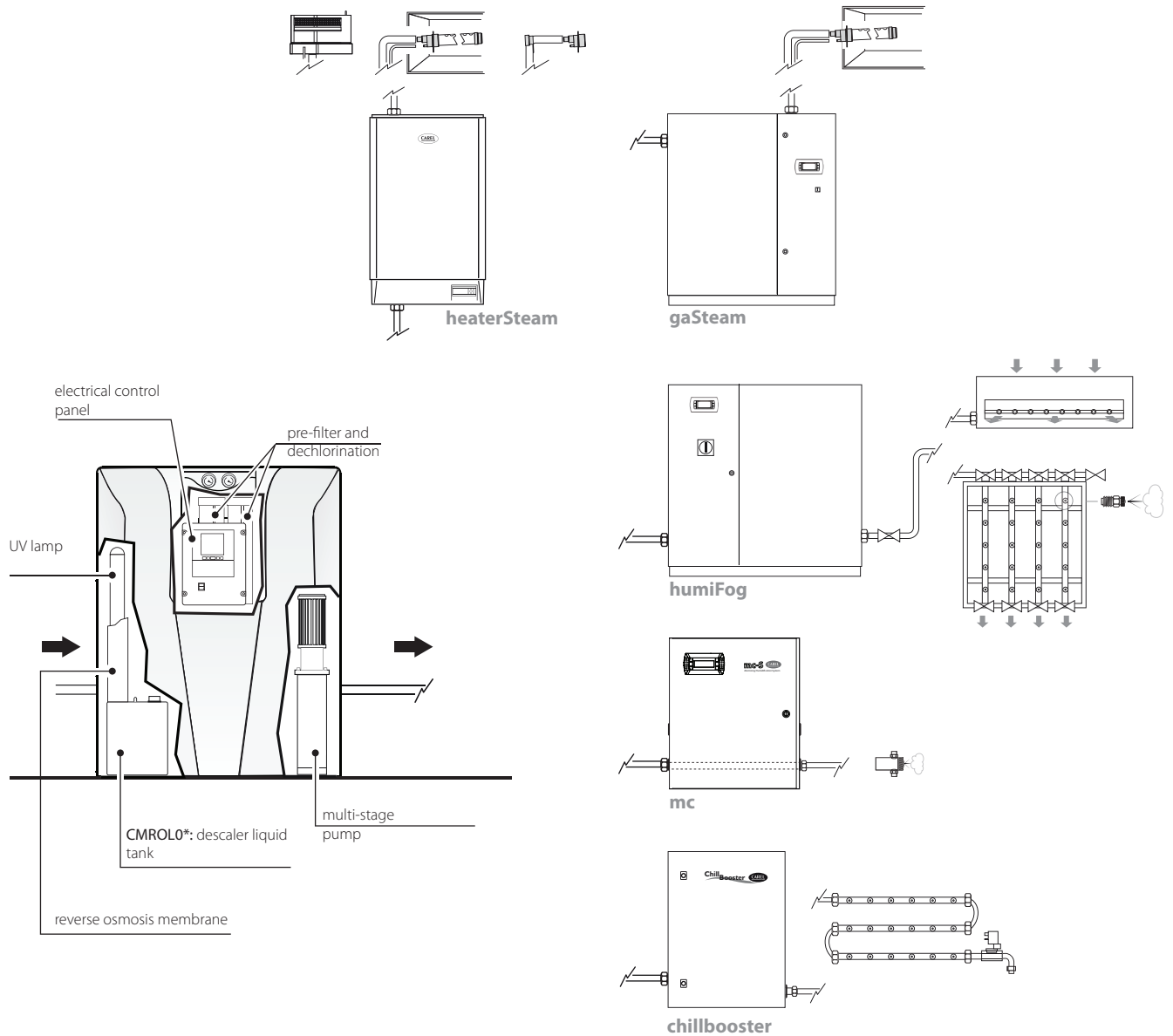

Sensors and protection devices

A close-up, grayscale photograph of a leaf covered in water droplets, serving as a background for the text. The leaf is positioned on the right side of the frame, with its veins and the texture of the water droplets clearly visible. The droplets vary in size and are scattered across the surface of the leaf. The overall tone is soft and natural, with a focus on the interplay of light and water.



Sensors and protection devices

CAREL offers increasingly advanced and complete global solutions.

For this reason, CAREL has designed an entire range of probes that respond to the needs of HVAC/R installers and manufacturers, as well as for the control of CAREL's own line of humidifiers.

The range envisions temperature and humidity sensors with different uses, housed in sockets, ducted, residential or industrial environment, pressure transducers, smoke, fire and flood detectors, air quality probes, gas leak detectors for refrigerant units, guaranteeing performance and compatibility with all CAREL controllers.

The range has been enhanced with the most innovative technological solutions, offering new international standards at increasingly competitive prices.

Advantages

CAREL probes, as well as being characterised by the acknowledged performance that sets them apart, are very versatile and can satisfy various market requirements.

In fact, all the probes have been especially designed to be compatible not only with all CAREL controllers, but also with the most commonly used standards worldwide.

The temperature and humidity probes, offering a great choice between active and passive technology, are available in different operating ranges and also in specific versions for corrosive or polluting environments.

The pressure transducers are available in a ratiometric version, 0 to 5 V and 4 to 20 mA, also in a sealed version (to be installed without capillary directly onto the piping) offering improved performance in terms of precision.

The air quality sensors offer a new and important accessory to installers and manufacturers of AHUs, absolutely in line with CAREL quality.

The smoke/fire and flood detectors are small devices with auto-calibration function, thus adapting to different environmental conditions without losing activation accuracy.

For the detection of CFCs, HFCs and CO₂ gas refrigerants, CAREL offers a range of sensors designed to satisfy requirements in the industrial refrigeration and air-conditioning for supermarkets, shopping centres, and other public places.



Temperature, humidity and temperature/humidity probes.

DPW*: for installation in the room
 DPD*: for installation in the duct

This probes are particularly suitable for civil and commercial environments where particular attention is paid to design. They are used in heating and air conditioning systems that use ducts. The range also envisions models with RS485 connection with CAREL and Modbus® protocol.

Technical specifications

Power supply: 12/24 Vac -10/15%
 9 to 30 Vdc ±10%

Operating conditions:

- DPW*: -10T60 °C, <100% R.H. non cond.;
- DPD*: -10T60 °C, -20T70, <100% R.H. non cond.

Protection rating:

- DPW*: IP30;
- DPD*: IP55, IP40 sensor.

Assembly:

- DPW*: wall-mounted;
- DPD*: duct;

Number of I/Os:

- **analogue outputs:** -0.5 to 1 V, 0 to 1 V, 0 to 10 V, 4 to 20 mA

Serial Ports: RS485 (specific model)

Dimensions:

- DPW*: 127x80x30 mm;
- DPD*: 98x105x336 mm.

Connections: screw terminal board for cables up to 1.5 mm²



Active temperature/humidity probes

DPP*: for industrial environment

Specifically designed to measure high levels of humidity with great accuracy. The range also envisions models with RS485 connection with CAREL and Modbus® protocol.

Technical specifications

Power supply: 12/24 Vac -10/15%,
 9 to 30 Vdc ±10%

Operating conditions: -10T60 °C, -20T70,
 <100% R.H. non cond.

Protection rating:

- IP55 (container);
- IP54 (sensor).

Assembly: wall-mounted

Number of I/Os:

- **analogue outputs:** -0.5 to 1 V, 0 to 1 V, 0 to 10 V, 4 to 20 mA

Serial Ports: RS485 (specific model)

Dimensions: 98x170x44

Connections: screw terminal board for cables up to 1.5 mm²



Active immersion temperature probes

ASIT*: immersion

The ASIT* immersion probes are used in cases where it is necessary to measure the temperature inside cooling and heating circuits. They are particularly adaptable where the sensitive element must be in direct contact with the fluid being controlled.

Technical specifications

Power supply: 12/24 Vac -10/15%,
 9...30 Vdc ±10%

Operating conditions: -10T70 °C, <100%
 R.H. non cond.

Protection rating:

- IP55 (container);
- IP67 (sensor).

Assembly: direct or with housing

Number of I/Os:

- **analogue outputs:** -0.5 to 1 V, 4 to 20 mA

Dimensions: 94x102x176

Connections: screw terminal board for cables up to 1.5 mm²



Active universal temperature probes

ASET*: universal

The universal temperature probes are used for many applications; in particular the ASET03* version has an electronic amplifier, protected by a container with IP55 protection rating, which allows remote control up to 200 m with 4 to 20 mA output.

Technical specifications

Power supply: 12/24 Vac -10/15%, 9...30 Vdc $\pm 10\%$

Operating conditions: -30T90 °C or 30T150 °C, <100% R.H. non cond.

Protection rating:

- IP55 (container);
- IP67 (sensor).

Assembly: directly in socket

Number of I/Os:

- **analogue outputs:** -0.5 to 1 V, 4 to 20 mA

Dimensions: 94x102x176

Connections: screw terminal board for cables up to 1.5 mm²



VOC, CO₂, CO₂+VOC air quality probes

DPWQ*: for installation in the room

DPPQ*: for installation in the duct

These analyse the quality of the air and are ideal for air ventilation and handling systems in domestic and commercial areas.

Main functions:

- measurement of air quality;
- quantitative analysis of contamination by parts of polluting gases;
- setting of a sensitivity threshold depending on that envisioned;
- for the ventilation of rooms only when necessary, contributing to a large energy saving.

Technical specifications

Power supply: 24 Vac/dc $\pm 10\%$, 50/60 Hz

Operating conditions: 0T50 °C, 10/90% R.H. non cond.

Protection rating:

- IP55 (container);
- IP67 (sensor)

Assembly:

- DPWQ: wall-mounted;
- DPPQ: duct

Number of I/Os:

- **analogue outputs:** 0 to 10 V, 4 to 20 mA

Dimensions:

- DPWQ*: 95x97x30 mm; 79x81x26 mm;
- DPPQ*: 108x70x262.5 mm; 64x72x228.4 mm.

Connections: screw terminal board for cables up to 1.5 mm²



Refrigerant gas leak detector

DPWL*

The refrigerant gas detection sensor is a device that indicates leaks of the most common gases (R22, R134a, R404a, R407c, R410a and CO₂). It can be used in stand-alone applications, integrated with Carel controllers or with third party devices. It envisions connection with the CAREL controller via the analogue, digital output or via RS485 Modbus[®] serial connection. When a leak above a certain concentration is detected, the sensor informs the controller of the alarm and locally activates an audible and visual signal and a relay (SPDT) at the same time. It offers the advantage of intervening immediately on gas leaks, thus preventing unit standstill and guaranteeing the safety of persons in the vicinity.

Its installation ensures compliance with the European F-GAS and EN378 and ASHRAE 15 standards.

Technical specifications

Power supply: 12 to 24 Vac/Vdc $\pm 20\%$ 50/60 Hz

Operating conditions:

- semicond. ver. -20T50°C;
- infrared ver. -40T50°C 80% R.H. non condensing.

Protection rating:

- semicond. ver. IP41;
- infrared ver. IP66.

Assembly: wall-mounted

Number of I/Os:

- **analogue outputs:** configurable 0 to 5 V, 1 to 5 V, 0 to 10 V, 2 to 10 V, 4 to 20 mA;
- **digital outputs:** 1 amp at 24 Vac/Vdc.

Serial Ports: RS485 Modbus[®]

Connections: disconnectable clamps, 0.5 mm² cable cross-section



Temperature probes with NTC thermistor

NTC*HP*, NTC*WP*, NTC*WH*, NTC*WF*,
NTC*HF and NTC*HT, NTCINF*, NTC*PS*

CAREL offers a range of sensors with different features for the various controllers, suitable for different applications mainly in the HVAC/R market sector.

The accuracy obtained thanks to the technical solutions used in developing the sensor, the reliability as a result of the tests to which they are subjected, mean that CAREL NTC probes are reliable transducers for measuring temperature at a low cost.

Probes for socket assembly are available in strips for installation on piping for pass-through with or without pre-heater, to measure the core temperature of the product, and a sensor for estimating product temperature.

Technical specifications

Operating conditions: -50T105 °C

Protection rating: IP67 and IP68

Assembly: depending on the model

Dimensions: depending on the model



Immersion probes

TSN* and TSC*= NTC version
TST* and TSM*= Pt1000 version
TSOPZ= accessories (connectors, fittings, housing...)

CAREL offers a range of TS* series immersion probes in NTC and Pt1000 models, suitable exclusively for hydronic applications.

Quick installation, fast response of the sensor an excellent price/performance ratio are features on which this product range is based.

Connectors are available with cables, fittings and the socket as accessories.

Technical specifications

Operating conditions: -40T90 °C,
-40T120 °C

Assembly: on piping

Dimensions:

- TSN* and TSC*: 1/8" GAS x 5 mm
- TST* and TSM: M14 x23 mm with 2 m cable



Temperature probes with PTC, Pt100, Pt1000 sensor

PTC*

The PTC temperature probes represent a possible solution for both cooling and heating applications, used to measure temperature within the operating range, -50T100 °C and 0T150 °C.

PT100*

The PT100 probes represent the ideal solution for all applications in which it is necessary to measure temperatures within the range from -50 to 400 °C (depending on the models).

PT1*HP*, PT1*WP*, PT1*WF*, PT1*HF*,
PT1*HT*, PT1*PS; TSQ*

The Pt1000 probes (PT1* and TSQ*) are suitable for all those applications in which it is necessary to measure temperatures in a range from -50 to 250 °C (TSQ*) and from -50 to 105 °C (PT1*), maintaining accuracy also over long distances..

Probes for socket assembly are available in strips for installation on piping for pass-through with or without pre-heater, to measure the core temperature of the product, and a sensor for estimating product temperature.

Technical specifications

Operating conditions: -50T105 °C,
-50T250 °C, -50T350 °C

Protection rating: IP65 and IP67

Dimensions: depending on the model



Pressure transducers 4 to 20 mA series C and D

SPKT*C*, SPK1*, SPK2*, SPK3*, SPKT*D*

The pressure transducers supply an analogue current signal (4 to 20 mA). They are used particularly in refrigeration and air conditioning to measure pressure in cooling circuits, but their high performance allows their use in almost all other applications. Compatible with all types of refrigerant. They are available with male and female connection for the C series and only female for the D series.

Technical specifications

Power supply: 8 to 28 Vdc $\pm 20\%$

Operating conditions:

- -25T80 °C (male);
- -40T135 °C (female).

Protection rating: IP65 (IP67 with built-in connector)

Number of I/Os:

- analogue outputs: 4 to 20 mA

Dimensions: depending on the model

Connections: Packard



Ratiometric pressure transducers 0 to 5 V series S

SPKT*S*

The Carel 5 V ratiometric pressure transducers (Sealing) have been developed to be used in commercial refrigeration and air conditioning applications. They are completely hermetic and can be installed directly in contact with the piping, in conditions with the refrigerant fluid lower than the dew point (it is not necessary to use the capillary positioned between piping and sensor).

Available with female connection only

Technical specifications

Power supply: 5 Vdc

Operating conditions: -40T125 °C

Protection rating: IP67

Number of I/Os:

- analogue outputs: 0.5 to 4.5 V

Dimensions: $\varnothing 21 \times 51$ mm

Connections: Packard



Ratiometric pressure transducers 0 to 5 V series R

SPKT*R*

These pressure transducers supply a 0 to 5 V ratiometric signal (automotive standard).

They can be used in air conditioning and refrigeration systems, with exception to those containing ammonia.

Available with female connection only.

Technical specifications

Power supply: 4.5 to 5.5 Vdc

Operating conditions: -40T135 °C

Protection rating: IP65

Number of I/Os:

- analogue outputs: 0.5 to 4.5 V

Dimensions: 20x51.6 mm

Connections: Packard



Combined pressure-temperature transducer

SPKP*

The combined pressure and temperature transducer has been developed for applications in the refrigeration and air conditioning sectors. The sensor-pressure transducer is 0 to 5V ratiometric, while the temperature sensor is NTC. It offers the advantage of having a single component with a quicker and more accurate measurement. Typical use is in combination with a driver for electronic expansion valves in refrigeration and air conditioning applications.

Technical specifications

Power supply: 4.5 to 5.5 V

Operating conditions: -40T120 °C

Protection rating: IP67

Number of I/Os:

- **analogue outputs:** 0.5 to 4.5 V and NTC 10K at 25°C (non STD)

Dimensions: Ø= 23.80 x 65 mm

Connections: 4-way AMP

Micro-Quadlok System connector



Differential pressure transducers

SPKD*

The differential pressure transducers use a ceramic sensor that supplies a voltage or current signal that is calibrated and compensated by temperature. They are particularly suitable for measuring low pressure values in air conditioning systems, laboratories and clean rooms (non-corrosive air and gas)

The main features are:

- compact construction;
- easy and simple installation;
- model can be configured for 4 different pressure ranges.

Technical specifications

Power supply: 15 to 36 Vdc

Operating conditions: 0T50 °C

Protection rating: IP65

Assembly: panel

Number of I/Os:

- **analogue outputs:** 4 to 20 mA

Dimensions: 70x108x73.5 mm

Connections: screw terminal board for

cables up to 1.5 mm²



Differential pressure switch

DCPD0*0*00

Device used to control the differential pressure of the air for filters, fans, air ducts, air-conditioning and ventilation units. The pressure switch is particularly suitable for control and safety in air-conditioning systems for indicating fan shutdown and clogging of the filters. It is applied in environments with non-aggressive and non-flammable air and gases, also in the version with assembly kit.



Anti-freeze thermostat

DCTF000320

This manages heat exchanger (evaporation coils) and electric heater protection for air conditioning and refrigeration systems. It can be used in all applications where it is necessary to control the temperature in a certain point of the system in order to prevent it dropping below a pre-established safety value. Moreover, the thermostat offers self-protection if the sensitive element should breakdown.



Airflow switch

DCFL000100

Flow switch for controlling air or non-aggressive gas flow inside the distribution ducts for air conditioning and air handling units. It signals the lack of or excessive decrease in flow rate in the duct, thus activating the switch.



Flood detector

FLOE*

The flood sensor device can detect the presence of water in an environment. It is usually used for the protection against the flooding of datacentres, offices, laboratories, special rooms. It is made up of a detector (normally positioned on the electric control board) and a sensor (positioned on the point to be controlled).

When the water comes into contact with the sensor, the detector immediately signals an alarm, switching over relay status.



Smoke and fire detector

SFF*

The smoke and heat detectors are electronic devices that can quickly detect dangerous and sudden temperature changes or the increase in fumes. Their peculiarity lies in the self-calibration, i.e. the possibility to maintain the guarantee of activation over time, adapting perfectly to the different environmental conditions, without losing sensitivity.

Active temperature and humidity probes

Models	temper. range	temper. range	output
Active probes for rooms, power supply 9 to 30 Vdc/12 to 24 Vac			
DPWT010000	-10T60 °C		selectable 0 to 1 V/-0.5 to 1 Vdc/4 to 20 mA
DPWT011000	-10T60 °C		NTC 10 K at 25 °C
DPWC111000	-10T60 °C	10...90% R.H.	• NTC 10 K at 25 °C (temperature) • selectable 0 to 1 V/-0.5 to 1 Vdc/4 to 20 mA (humidity)
DPWC110000	-10T60 °C	10...90% R.H.	selectable 0 to 1 V/-0.5 to 1 Vdc/4 to 20 mA
DPWC115000	-10T60 °C	10...90% R.H.	• NTC 10 K at 25 °C (temperature) • 0 to 10 Vdc (humidity)
DPWC112000	-10T60 °C	10...90% R.H.	0 to 10 Vdc
DPWC114000	-10T60 °C	10...90% R.H.	opto-isolated RS485 serial
DPWT014000	-10T60 °C		opto-isolated RS485 serial
Active probes for industrial environments, power supply 9 to 30 Vdc/12 to 24 Vac			
DPPT010000	-20T70 °C		selectable 0 to 1 V/-0.5 to 1 Vdc/4 to 20 mA
DPPT011000	-20T70 °C		NTC 10 K at 25 °C
DPPC111000	-10T60 °C	10...90% R.H.	• NTC 10 K at 25 °C (temperature) • selectable 0 to 1 V/-0.5 to 1 Vdc/4 to 20 mA (humidity)
DPPC110000	-10T60 °C	10...90% R.H.	selectable 0 to 1 V/-0.5 to 1 Vdc/4 to 20 mA
DPPC210000	-20T70 °C	0...100% R.H.	selectable 0 to 1 V/-0.5 to 1 Vdc/4 to 20 mA
DPPC112000	-10T60 °C	10...90% R.H.	0 to 10 Vdc
DPPC212000	-20T70 °C	0...100% R.H.	0 to 10 Vdc
DPPT014000	-10T60 °C	10...90% R.H.	opto-isolated RS485 serial
DPPC114000	-10T60 °C	10...90% R.H.	opto-isolated RS485 serial
DPPC214000	-20T70 °C	0...100% R.H.	opto-isolated RS485 serial
Active probes for ducts, power supply 9 to 30 Vdc/12 to 24 Vac			
DPDT010000	-20T70 °C		selectable 0 to 1 V/-0.5 to 1 Vdc/4 to 20 mA
DPDT011000	-20T70 °C		NTC 10 K at 25 °C
DPDC111000	-10T60 °C	10...90% R.H.	• NTC 10 K at 25 °C (temperature) • selectable 0 to 1 V/-0.5 to 1 Vdc/4 to 20 mA (humidity)
DPDC110000	-10T60 °C	10...90% R.H.	selectable 0 to 1 V/-0.5 to 1 Vdc/4 to 20 mA
DPDC210000	-20T70 °C	0...100% R.H.	selectable 0 to 1 V/-0.5 to 1 Vdc/4 to 20 mA
DPDC112000	-10T60 °C	10...90% R.H.	0 to 10 Vdc
DPDC212000	-20T70 °C	0...100% R.H.	0 to 10 Vdc
DPDT014000	-20T70 °C		opto-isolated RS485 serial
DPDC114000	-10T60 °C	10...90% R.H.	opto-isolated RS485 serial
DPDC214000	-20T70 °C	0...100% R.H.	opto-isolated RS485 serial
Container protection rating:	IP55 for DPD, DPP		for duct and technical environment)
	IP30 for DPW		(wall-mounted)
Sensitive element protection rating	IP30		for DPW
	IP40		for DPD
	IP54		for DPP
Time constant, temperature	in still air		300 s
	in ventilated air (3 m/s)		60 s
Time constant, humidity	in still air		60 s
	in ventilated air (3 m/s)		20 s
Models	temperature range		output
Active probes for immersion and power supply environment 9 to 30 Vdc/12 to 24 Vac			
ASIT030000	-30T90 °C		selectable -0.5 to 1 Vdc/4 to 20 mA
Active probes for universal power supply use 9 to 30 Vdc/12 to 24 Vac			
ASET030000	-30T90 °C		selectable -0.5 to 1 Vdc/4 to 20 mA
ASET030001	-30T90 °C		selectable -0.5 to 1 Vdc/4 to 20 mA
ASET030002	-30T150 °C		selectable -0.5 to 1 Vdc/4 to 20 mA

Passive temperature probes

Models	range	accuracy	constants (time) in fluid	IP
NTC*				
NTCI*HP**	-50T105 °C	25 °C: ±1%	25 s	IP67
NTCI*WF**	-50T105 °C	25 °C: ±1%	10 s	IP67
NTCI*WP**	-50T105 °C	25 °C: ±1%	30 s	IP68 limited
NT*WG**	-50T105 °C	25 °C: ±1%	20 s	IP67
NT*HT**	0T150 °C	±0.5 °C, -10T50 °C - 25 °C: ±1.0 °C; -50T85 °C ±1.6 °C; +85T120 °C - ±2.1 °C; +120T150 °C	30 s	IP55
NT*HF**	-50T90 °C	±0.5...25 °C; ±1.0 °C from -50T90 °C	50 s	IP55
NT*WH*	-50T105 °C	25 °C; ±1%	30 s	IP68 permanent
NTC*PS*	-50T105 °C	25 °C: ±1%	50 m	IP67
NTCINF	-50T110 °C	25 °C: ±1%	45 s	IP67
TSN*	-40T120 °C	25 °C: ±1%	30 s	IP68
TSC*	-40T90 °C	25 °C: ±1%	45 s	IP68
PT100*				
PT100000A1	-50T250 °C	IEC 751 class B	20 s	IP65
PT100000A2	-50T400 °C	IEC 751 class B	20 s	IP65
PT1000				
PT1*HP*	-50T105 °C	IEC 751 class B	10 s	IP67
PT1*WF*	-50T105 °C	IEC 751 class B	15 s	IP67
PT1*WP*	-50T105 °C	IEC 751 class B	25 s	IP68 limited
PT1*HF*	-50T105 °C	IEC 751 class B	15 s	IP67
PT1*HT*	-50T250 °C	IEC 751 class B	20 s	IP67
PT1*PS*	-50T105 °C	IEC751 class B	50 m	IP67
TSQ15MAB00	-50T250 °C	IEC 751 class B	10 s	IP65
TST*	-40T120 °C	IEC 751 class B	10 s	IP68
TSM*	-40T90 °C	IEC 751 class B	10 s	IP68
PTC				
PTCO*0000	0T150 °C	±2 °C; 0T50 °C - ±3 °C; -50T90 °C - ±4 °C; 90T120 °C	15 s	IP65
PTCO*W*	-50T100 °C	±2 °C; 0T50 °C - ±3 °C; -50T90 °C - ±4 °C; 90T120 °C	15 s	IP67
PTCO3000*1	-50T120 °C	±2 °C; 0T50 °C - ±3 °C; -50T90 °C - ±4 °C; 90T120 °C	15 s	IP67

Air quality probes

Models	type	output
For rooms, 24 Vac/15 to 36 Vdc		
DPWQ306000	V.O.C.	0 to 10 Vdc or 4 to 20 mA
DPWQ402000	CO2	0 to 10 Vdc
DPWQ502000	V.O.C. and CO2	0 to 10 Vdc
For ducts, 24 Vac/15 to 36 Vdc		
DPDQ306000	V.O.C.	0 to 10 Vdc or 4 to 20 mA
DPDQ402000	CO2	0 to 10 Vdc
DPDQ502000	V.O.C. and CO2	0 to 10 Vdc

Pressure transducers

Models	power supply:	operating temperature	range	accuracy	output signal	constants (time)	IP
SPKT00-R0: 0 to 5 V ratiometric - female series R							
53	4.5 to 5.5 Vdc	-40T135 °C	4.2 relative bar	±1,2%	0.5 to 4.5 V	10 ms	IP65 ¹
13	4.5 to 5.5 Vdc	-40T135 °C	9.3 relative bar	±1,2%	0.5 to 4.5 V	10 ms	IP65 ¹
33	4.5 to 5.5 Vdc	-40T135 °C	34.5 relative bar	±1,2%	0.5 to 4.5 V	10 ms	IP65 ¹
43	4.5 to 5.5 Vdc	-40T135 °C	17.3 relative bar	±1,2%	0.5 to 4.5 V	10 ms	IP65 ¹
B6	4.5 to 5.5 Vdc	-40T135 °C	45.0 relative bar	±1,2%	0.5 to 4.5 V	10 ms	IP65 ¹
F3	0.5 to 5.5 Vdc	-40T135 °C	20 relative bar	±1,2%	0.5 to 4.5 V	10 ms	IP65 ¹
E3	0.5 to 5.5 Vdc	-40T135 °C	12.8 relative bar	±1,2%	0.5 to 4.5 V	10 ms	IP65 ¹
SPK*: 4 to 20 mA - male series C							
*1000000	8 to 28 Vdc	-25T80 °C	-0.5 to 7 bar	±1% fs	4 to 20 mA	-	IP67
*240000	8 to 28 Vdc	-25T80 °C	-1 to 24 bar	±1% fs	4 to 20 mA	-	IP67
*2500000	8 to 28 Vdc	-25T80 °C	0 to 25 bar	±1% fs	4 to 20 mA	-	IP67
*3000000	8 to 28 Vdc	-25T80 °C	0 to 30 bar	±1% fs	4 to 20 mA	-	IP67
SPK*C*: 4 to 20 mA - female series C							
*T0021C0	8 to 28 Vdc	-40T135 °C	-0.5 to 7 bar	±1% fs; 0T50 °C	4 to 20 mA	<10 ms	IP65 ¹
*T0011C0	8 to 28 Vdc	-40T135 °C	0 to 10 bar	±1% fs; 0T50 °C	4 to 20 mA	<10 ms	IP65 ¹
*T0031C0	8 to 28 Vdc	-40T135 °C	0 to 30 bar	±1% fs; 0T50 °C	4 to 20 mA	<10 ms	IP65 ¹
*T0041C0	8 to 28 Vdc	-40T135 °C	0 to 18.2 bar	±1% fs; 0T50 °C	4 to 20 mA	<10 ms	IP65 ¹
*T00B1C0	8 to 28 Vdc	-40T135 °C	0 to 44.8 bar	±1% fs; 0T50 °C	4 to 20 mA	<10 ms	IP65 ¹
*T00G1C0	8 to 28 Vdc	-40T135 °C	0 to 60 bar	±1% fs; 0T50 °C	4 to 20 mA	<10 ms	IP65 ¹
*T00D8C0	8 to 28 Vdc	-40T100 °C	0 to 150 bar	±1% fs; 0T50 °C	4 to 20 mA	<10 ms	IP65 ¹
SPK*: 4 to 20 mA - female series D							
*T0021D0	8 to 28 Vdc	-40T135 °C	-0.5 to 7 bar	±1% fs; 0T40 °C	4 to 20 mA	<10 ms	IP65
*T0011D0	8 to 28 Vdc	-40T135 °C	0 to 10 bar	±1% fs; 0T40 °C	4 to 20 mA	<10 ms	IP65
*T0041D0	8 to 28 Vdc	-40T135 °C	0 to 18.2 bar	±1% fs; 0T40 °C	4 to 20 mA	<10 ms	IP65
*T0031D0	8 to 28 Vdc	-40T135 °C	0 to 30 bar	±1% fs; 0T40 °C	4 to 20 mA	<10 ms	IP65
*T00B1D0	8 to 28 Vdc	-40T135 °C	0 to 44.8 bar	±1% fs; 0T40 °C	4 to 20 mA	<10 ms	IP65
SPK*: 0 to 5 V - female series S							
*T0051S0	0.5 to 4.5 Vdc	-40T125 °C	-1 to 4.2 bar	±1% fs; 0T50 °C	0.5 to 4.5 V	<10 ms	IP67
*T0011S0	0.5 to 4.5 Vdc	-40T125 °C	-1 to 9.3 bar	±1% fs; 0T50 °C	0.5 to 4.5 V	<10 ms	IP67
*T00E1S0	0.5 to 4.5 Vdc	-40T125 °C	-1 to 12.8 bar	±1% fs; 0T50 °C	0.5 to 4.5 V	<10 ms	IP67
*T0041S0	0.5 to 4.5 Vdc	-40T125 °C	0 to 17.3 bar	±1% fs; 0T50 °C	0.5 to 4.5 V	<10 ms	IP67
*T00F1S0	0.5 to 4.5 Vdc	-40T125 °C	0 to 20.7 bar	±1% fs; 0T50 °C	0.5 to 4.5 V	<10 ms	IP67
*T0031S0	0.5 to 4.5 Vdc	-40T125 °C	0 to 34.5 bar	±1% fs; 0T50 °C	0.5 to 4.5 V	<10 ms	IP67
*T00B1S0	0.5 to 4.5 Vdc	-40T125 °C	0 to 45 bar	±1% fs; 0T50 °C	0.5 to 4.5 V	<10 ms	IP67

¹ with built-in IP67 connector

Differential air pressure transducers

Models	power supply:	input current	differential pressure range	differential pressure accuracy full scale	output signal	filtered signal	IP
SPKD00C5N0	15 to 30 Vdc	≥20 mA	-50 to 50 Pa -100 to 100 Pa 0 to 50 Pa 0 to 100 Pa	±3%	4 to 20 mA	selectable 1 or 10 s	IP65
SPKTD00U5N0	15 to 30 Vdc	≥20 mA	0 to 1000 Pa 0 to 2000 Pa 0 to 3000 Pa 0 to 5000 Pa	±3%	4 to 20 mA	selectable 1 or 10 s	IP65

Pressure switches and flow switches

Operating conditions	sensor	range	accuracy	maximum current	output signal	contacts	IP
DCPD0*0100: pressure switch for duct							
-25T85 °C max 50 mbar	silicone membrane	0.5 to 5 mbar	0.2 ± 15% mbar	1.5 (A) 25 Vac 0.1 A 24 Vac	NO...NC voltage-free contact	AgCdO contacts watertight switch	IP54
DCPD0*1100: pressure switch for duct							
-20T85 °C max 50 mbar	silicone membrane	0.2 to 2 mbar	0.2 ± 15% mbar	1.5 (A) 25 Vac 0.1 A 24 Vac	NO...NC voltage-free contact	AgCdO contacts watertight switch	IP54
DCFL000100: flow switches							
-40T85 °C	silicone membrane	2.5 to 9.2 m/s (start) 1 to 8 m/s (stop)		15 (8) A 24/250 Vac	NO...NC voltage-free contact	watertight switch	IP65

*: "1" with assembly kit

