

SORVALL®

Legend™ T / RT

Instruction Manual

EASYset™



DJB Labcare - The UK's Leading Centrifuge Specialist
info@djblabcare.co.uk www.djblabcare.co.uk
01908 612598

 **Kendro**
Laboratory Products

How to use this manual

Please, use this manual to get acquainted with your centrifuge and its accessories.

The manual helps you to avoid inappropriate handling. Make sure to always keep it close to the centrifuge.

A manual that is not kept handy cannot provide aid against improper handling and thus against damage to individuals and surrounding.

The manual contains chapters on

- Safety regulations
- Instrument description
- Rotors and accessories
- Transportation and installation
- Use of the centrifuge
- Maintenance and care
- Troubleshooting
- Technical data
- Index

On the overleaf is a graphic representation of the control panel and a description of the control functions.

Unfold, please

DJB Labcare - The UK's Leading Centrifuge Specialist
info@djblabcare.co.uk www.djblabcare.co.uk
01908 612598

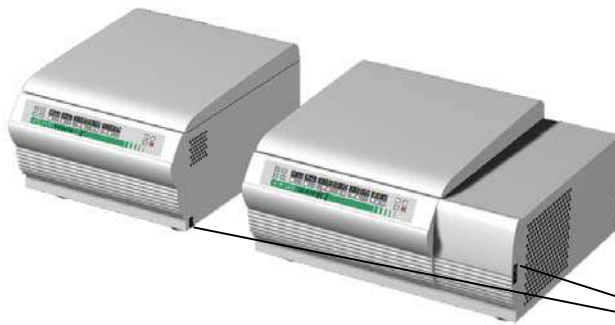
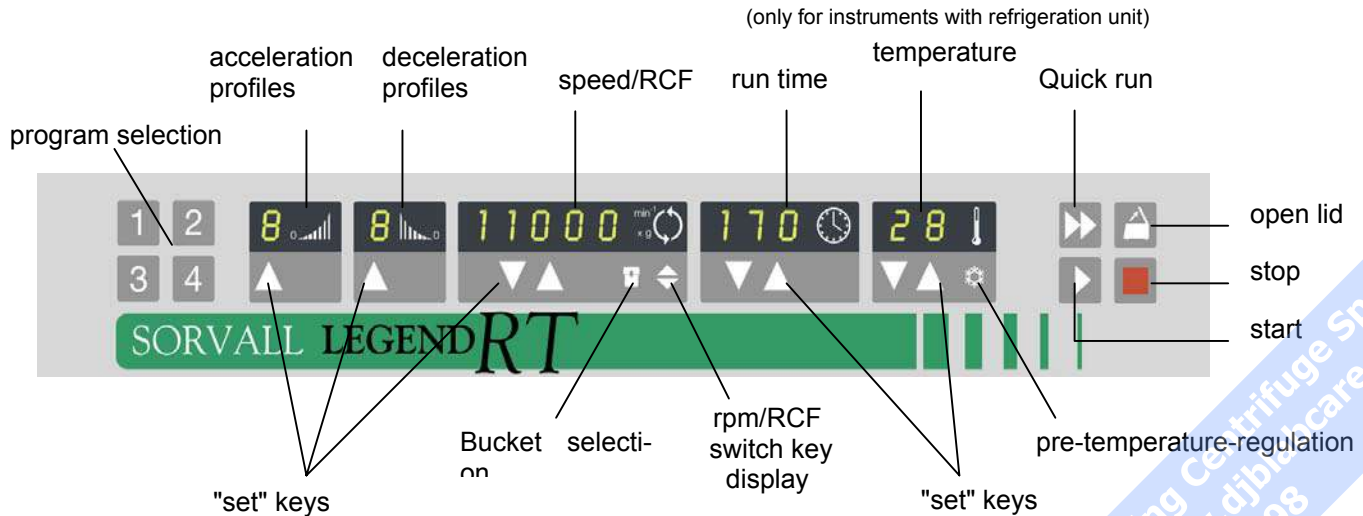

 Before switching on the centrifuge please read this manual

The **mains switch** is located on the right-hand side panel.

Pressed up = ON 1
 Pressed down = OFF 0

DJB Labcare - UK's Leading Centrifuge Specialist
 www.djblabcare.co.uk 0800 612598

Control panel of the Legend™ T / RT

Display panels

Program selection

Key 1 - 4 : store or recall programs.

Acceleration profiles (1= slowest 9= fastest)

permanent

display: acceleration profile last set 1- 9

Deceleration profiles (1= slowest 9= fastest)

permanent

display: deceleration profile last set 1- 9

Speed / RCF

run: current value of speed or RCF after activation of switch key

end: "End"

lid open: "OPEN"

"Lift Lid" (if lid is not automatically lifted off)

(before start)

lid closed: "0" with flashing point
(rotor not yet identified)

error code: will flash in display

Run time

time selection: - remaining run time to 0

continuous - run time passed (HLD)

operation (hld) (in hours, minutes)

"Quick Run": - run time passed (as long as button is held;
in minutes and seconds)

Temperature*

run: current sample temperature in °C
(in temperature equilibrium)

* only for instruments with refrigeration unit

Keys

start : normal start of the centrifuge

stop : manual stop of a run

open lid: open lid (possible only with the instrument switched on)

Quick run: short-term operation of the centrifuge as long as key remains pressed

rpm/RCF

switch: switching between rpm and RCF display

Bucket set.: Setting of the bucket number

Pretemp : Pre-temp-function*

"set" keys: stepwise increase/decrease of setpoint values

Short pressing of any of the "set" keys: switch from current to preset value, signalled by flashing display.

Error codes (troubleshooting see chapter "Troubleshooting"):

E-19: Unpermissible rotor

E-20: Rotor not identified

E-29: Motor or rotor blocked

E-31: Overtemperature in motor

E-32: Overtemperature in electronic

E-33: Excessive pressure in the refrigeration unit

E-34: Overvoltage

E-35: Overcurrent

Lift Lid : Smoothly lift the lid

rotor: set speed higher than permissible speed of the rotor

bAL : unbalance

Contents

For your safety..... 3
 Proper use.....3
 Improper use3
 Centrifuging hazardous materials3
 Handling the centrifuge4
 Conformity to current standards.....5
 Safety instructions in this manual5

The Legend™ T / RT..... 7
 Description7
 Safety systems8
 Parts supplied8
 Function and features9

Accessories 13
 Rotors for the Legend™ T14
 Rotors for the Legend™ RT.....18

Before use..... 27
 Centrifuge transport and installation27
 Proper location27
 Main connection28

Operation..... 29
 Switching on the centrifuge.....29
 Actuating the lid29
 Opening the lid29
 Closing the lid.....29
 Installing the rotor30
 Loading the rotor.....36
 Maximum loading36
 Filling the centrifuge tubes37
 Maximum permissible load difference37
 Inserting the centrifuge tubes.....38
 Aerosol-tight operation.....40
 Checking for aerosol-tight bio-containment43
 Entering parameters45
 Deceleration curves45
 Switching from speed to RCF display.....45
 Bucket selection for swinging bucket rotors45
 Selecting speed45
 Entering the RCF value46
 More about the RCF value47
 Selecting run time47
 Run time selection.....47
 Continuous operation.....48
 Extended time mode48
 Selecting the temperature.....49
 Pretemp function.....49
 Starting the centrifuge.....50

Imbalance display.....	50
Changing the settings during the run	50
Stopping the centrifuge	51
Stopping with preset run time	51
Stopping with continuous operation	51
Temperature control during standby	51
Working with programs	52
Program display.....	52
Entering/changing a program	52
Centrifuging with a program	52
"Quick Run"	53
Removing the rotor.....	53
Audible alarm	54
Turning the centrifuge off	54
Maintenance and care	55
Routine maintenance to be performed by the customer.....	55
Cleaning.....	55
Disinfection	56
Decontamination.....	58
Autoclaving	58
The KENDRO service offering	59
Warranty conditions	59

Troubleshooting.....	61
Emergency lid release	61
Error troubleshooting	63
Contacting Kendro Service	72
Technical Data.....	73
Electrical connections / fuses	75
Appendix.....	77
Acceleration and deceleration profiles.....	77
Speed/RCF diagrams	87
Index	93

For your safety

The SORVALL® centrifuges are manufactured according to current technical standards and regulations. Nonetheless, centrifuges may pose danger to individuals and surrounding if

- they are not used as designed
- they are operated by untrained personnel
- their design is improperly changed
- the safety instructions are not followed

Therefore, personnel involved with operation and maintenance of the centrifuge must read and follow the safety instructions.

In addition, the pertinent regulations for prevention of accidents must be strictly followed.



This manual is an integral part of the centrifuge assembly and must be kept close at hand at all times.

Proper use

The centrifuge is designed to separate liquid-suspended materials having different densities and particle size, respectively (maximum sample density is 1.2 g/cm³ {ml} at maximum speed).

Improper use

During a run, a safety zone of 30 cm (12 inches) around the centrifuge must be maintained where neither persons nor hazardous materials may be stationed.

The centrifuge may cause harm to user or others or may damage instruments and samples if safety measures are not followed:

Centrifuging hazardous materials

- The centrifuge is neither made inert, nor is it explosion-proof. Therefore never use the centrifuge in an explosion-prone environment.
- Explosive or flammable substances must not be centrifuged. The same holds for substances prone to react violently with each other.

- Do not centrifuge toxic or radioactive substances or pathogenic microorganisms unless you have taken proper precautions.
If microbiological samples of risk group II (according to "Laboratory Biosafety Manual" of WHO) are being centrifuged, aerosol-tight bioseals have to be used.
For materials with a higher risk group, a secondary containment is required.
- Should toxins or pathogenic substances enter the centrifuge or its parts, you must perform the proper procedures for disinfection (see "Maintenance and care – Disinfection").
- Strongly corrosive substances that may cause damage to materials and reduce the mechanical strength of the rotor, may be centrifuged only inside protective tubes.

Handling the centrifuge

- Use only original accessories for the centrifuge. The only exception are common glass or plastic centrifuge tubes, if they are approved for the rotor speed and RCF values then they can be used.
- Never use the centrifuge unless the rotor is properly installed.

- You may use the centrifuge only with a properly loaded rotor. You must not overload the rotor.
- Strictly follow the rules and regulations for cleaning and disinfection
- If the rotor or the rotor cover shows signs of corrosion or wear, you must stop using it.
- Never manually open the lid if the rotor still turns.
- You may use the emergency lid release only in case of emergency, e.g. during a power failure (see chapter "Troubleshooting").
- Never use the centrifuge with the lid open.
- Never use the centrifuge if the front panel has been partially or totally removed.
- Changes in mechanical or electrical components of the centrifuge may be carried out only by individuals authorized by Kendro Laboratory Products.

Conformity to current standards

SORVALL® centrifuges are manufactured and tested according to the following standards and regulations:



for all voltages:

- IEC 1010-1 / EN 61010-1
- IEC 1010-2 / EN 61010-2-020
 - Pollution degree 2
 - Overvoltage category II

for 120 V only:

- CAN/CSA-C22.2 No. 1010.1-92
- CAN/CSA-C22.2 No. 1010.2.020-94

Safety instructions in this manual



This symbol denotes potential hazards to persons.



This symbol denotes potential damage to the centrifuge or parts in its immediate surroundings.



General hints are marked with this symbol.

In addition, you are asked to adhere to the pertinent regulations, in Germany

- Regulations for prevention of accidents VBG 4
- Regulations for prevention of accidents VBG 5
- Regulations for prevention of accidents VBG 7z
- Regulations for prevention of accidents VBG 20

Notes

DJB Labcare - The UK's Leading Centrifuge Specialist
info@djblabcare.co.uk www.djblabcare.co.uk
01908 612598

The *Legend™ T / RT*

The figure below shows a *Legend™ RT* with the lid open and a swinging bucket rotor installed.



Description

The *Legend™ RT* is a general-purpose tabletop centrifuge for biotechnological and pharmaceutical research that moves high capacity centrifugation onto the fast track. It spins more tubes, at higher RCFs, more rapidly than competitive instruments, and can process nominally three liters of sample in a single run. There are various rotors with high RCF values that can accommodate a wide range of accessories for all common tube types, microtiter plates and deep-wells.

The user-friendly "EASYset™" control panel permits easy selection of speed, RCF value, run time and run profile (acceleration and deceleration), as well as temperature of the *Legend™ RT*. You can switch from speed to RCF display and vice versa, with a touch of a button and even during a run.

DJB Labcare - The UK's Leading Centrifuge Specialist
info@djblabcare.co.uk 01908 612399

Safety systems

The *Legend™* is equipped with a number of safety systems:

- Housing and lid is constructed of 8 mm steel.
- Lid with window
- Lid lock with safety check

You can open the centrifuge lid only when the power is turned on and the rotor has come to a stop. You can start the centrifuge only if the lid is properly locked.

- Automatic rotor identification
- Electronic imbalance detection as a function of rotor (SMARTspin™)



Do not tamper with the safety system!

Parts supplied

Accessories supplied with the centrifuge are:

- power cord
- a special wrench for securing the rotor (as seen in picture)
- condensed operating instructions
- corrosion protective oil



The printed documents consist of the delivery notes and this Manual

Function and features

Basic unit/ function	Description / feature
Cabinet / frame	galvanized steel
Chamber	stainless steel
Drive	Brushless induction drive
Key pad and display	key pad and display elements covered by an easy-care continues surface
Control	Microprocessor driven by EASYset™
Main memory	Recalls last run parameters
Program memory	data are stored until new values are entered.
Advanced features	RCF-programming, quick run, pretemp *, temperature control during standby
Acceleration and deceleration profiles	9 acceleration and 9 deceleration profiles
Rotor identification	automatic
SMARTspin™ imbalance detection system	electronic, effective as a function of rotor and speed
Soft touch lid lock	motor assisted lid locking





(* only with refrigeration unit)

DJB Labcare - The UK's Leading Centrifuge Specialist
 info@djblabcare.co.uk www.djblabcare.co.uk 01908 612599

The EASYset™ user interface

Function	Feature
Program memory keys	freely programmable
Acceleration / deceleration profile	1 = slowest, ... 9 = fastest acceleration / deceleration curve
Setting speed by rpm	adjustable from 300 rpm to 15 000 rpm, in 10 rpm increments
RCF selection	upon activation of RCF switch , the RCF value can then be entered
Time selection	adjustable in minutes from 1 min to 9 h 59 min, or extended time mode from 1 min to 99 h, "hld"-mode: continuous operation
Run time display in "quick run" mode	between 1 s and 60 s in seconds' steps, above in minutes' steps
Setting temperature *	adjustable from -9°C to +40°C, in one degree increments
End of centrifugation	the speed display will read "End"

(* only with refrigeration unit)

Function	Feature
Lid opening	automatic unlocking via "Open lid" key () (unlocking in case of power failure: see chapter "Troubleshooting")
Start	start key ()
Stop	stop key ()
"Quick Run" mode	pressing the "Quick Run" key () activates maximum acceleration up to the maximum permissible speed of rotor; upon key release centrifuge stops with maximum deceleration power.
Diagnostic messages	<ul style="list-style-type: none"> • alternating display "Rotor"/maximum speed or RCF (speed selected exceeds max. speed of the rotor) • lid has not been lifted off the lock during opening: display "Lift lid" (manual lifting of lid required) • general instrument malfunction (error messages with ERROR codes, see "Troubleshooting")

DJB Labcare - The UK's Leading Centrifuge Specialist
 info@djblabcare.co.uk www.djblabcare.co.uk 01208 612598

Notes

DJB Labcare - The UK's Leading Centrifuge Specialist
info@djblabcare.co.uk www.djblabcare.co.uk
01908 612598

Accessories

A rotor is not included as part of a *Legend*[™] T or RT centrifuge.

A large variety of rotors are available as accessories.

In addition, there are adapters and reduction sleeves for a variety of commercially available tubes and bottles.

For a complete list of available tubes, bottles, adapters, and accessories refer to our current sales documentation.

For more information you can visit our web site at <http://www.Kendro.com>



DJB Labcare - The UK's Leading Centrifuge Specialist
info@djblabcare.co.uk www.djblabcare.co.uk
01908 612598

Rotors for the Legend™ T

<i>Table 1: Rotors for Legend™ T</i> 100V / 120V (differences of 230V instruments are shown in parentheses)			
Rotor designation	Swinging Bucket Rotor 7500 6445 (7500 6434 with integrated locking mechanism)		
With bucket	Round bucket	Rectangular bucket	Carrier for microplates
Order no.	750 ml 7500 6441	250 ml 7500 6446	7500 6449
Maximum permissible load [g]	4 x 800	4 x 750	4 x 500
Maximum speed n_{max} [rpm]	4150 (4350)	3750 (4350)	4150 (4350)
Maximum RCF value at n_{max}	3696 (4083)	2986 (4020)	3061 (3364)
Radius (max.) [cm]	19.2	19.0	15.9
Acceleration / deceleration time [s]	60 / 30 (40 / 40)	60 / 30 (45 / 40)	50 / 25 (40 / 35)
Heating of samples at n_{max} relative to room temperature 23°C, run time 1 hour	7°C (9°C)	7°C (10°C)	4°C (5°C)
Aerosol-tight *	yes (with cap 75006421)	yes (with cap 75006448)	no
Autoclavable	121°C	121°C	121°C

* Checked by TÜV (Technical Supervision Association) Product Service GmbH - Hamburg

<i>Table 1: Rotors for Legend™ T</i> 100V / 120V (differences of 230V instruments are shown in parentheses)			
Rotor designation	Swinging Bucket Rotor 7500 6445 (7500 6434 with integrated locking mechanism)		
With bucket	Tissue culture bucket	Multiple carriers	Multiple carriers
Order no.	250 ml 7500 6497	25 x 5 / 7 ml 7500 6470	20 x 10 / 15 ml 7500 6471
max. tube dimension d ¹⁾ x l [mm]	61 x 180	14 x 120	17 x 140
Maximum permissible load [g]	4 x 325	4 x 400 25 x 16	4 x 520 20 x 26
Maximum speed n _{max} [rpm]	3750 (4350)	3750 (4350)	3750 (4350)
Maximum RCF value at n _{max}	3348 (4506)	2814 (3787)	3018 (4062)
Radius (max.) [cm]	21.3	17.9	19.2
Acceleration / deceleration time [s]	50 / 25 (35 / 35)	50 / 25 (40 / 40)	55 / 27 (45 / 40)
Heating of samples at n _{max} relative to room temperature 23°C, run time 1 hour	9°C (11°C)	8°C (10°C)	8°C (10°C)
Aerosol-tight *	no	no	no
Autoclavable	121°C	121°C	121°C

¹⁾ d = diameter

<i>Table 1: Rotors for Legend™ T</i> 100V / 120V (differences of 230V instruments are shown in parentheses)			
Rotor designation Order no.	BIOshield® Rotor 4 x 250 ml 7500 6435	Highplate® Rotor 2 x 5 plates 7500 6444	
Maximum permissible load [g]	4 x 600	2 x 500	
Maximum speed n_{max} [rpm]	5350	5250	
Maximum RCF value at n_{max}	5824	5083	
Radius (max.) [cm]	18.2	16.5	
Acceleration / deceleration time [s]	145 / 70 (85 / 70)	110 / 55 (85 / 60)	
Heating of samples at n_{max} relative to room temperature 23°C, Run time 1 hour	10°C	13°C	
Aerosol-tight *	yes	yes	
Autoclavable	121°C	no	

* Checked by TÜV (Technical Supervision Association) Product Service GmbH - Hamburg

DJB Labcare - The UK's Leading Centrifuge Specialist
 info@djblabcare.co.uk www.djblabcare.co.uk 01908 612598

<i>Table 1: Rotors for Legend™ T</i> 100V / 120V (differences of 230V instruments are shown in parentheses)			
Rotor designation Order no.	Fixed-Angle Rotor 6 x 94 ml 7500 3334	Highconic® Rotor 6 x 50 ml 7500 3046	
Maximum permissible load [g]	6 x 140	6 x 130	
Maximum speed n_{\max} [rpm]	10 500	8500	
Maximum RCF value at n_{\max}	12 449	10 016	
Radius (max. / min.) [cm]	10.1 / 6.3	12.4 / 6.0	
Tube angle [°]	26	45	
Acceleration / deceleration time [s]	45 / 45 (40 / 45)	33 / 35 (25 / 35)	
Heating of samples at n_{\max} relative to room temperature 23°C, Run time 1 hour	13°C	10°C	
Aerosol-tight *	yes	yes	
Autoclavable	no	121°	

* Checked by CAMR, Porton-Down, UK

Rotors for the Legend™ RT

<i>Table 2: Rotors for Legend™ RT 120V</i> (differences of 200V / 230V instruments are shown in parentheses)			
Rotor designation	Swinging Bucket Rotor 7500 6445 (7500 6434 with integrated locking mechanism)		
With bucket Order no.	Round buckets 750 ml 7500 6441	Rectangular buckets 250 ml 7500 6446	Carrier for microplates 7500 6449
Maximum permissible load [g]	4 x 800	4 x 750	4 x 500
Maximum speed n_{max} [rpm]	4150 (4600)	3750 (4600)	4150 (4600)
Maximum RCF value at n_{max}	3696 (4566)	2986 (4494)	3061 (3761)
Radius (max.) [cm]	19.2	19.0	15.9
Acceleration / deceleration time [s]	60 / 35 (45 / 45)	55 / 30 (45 / 40)	50 / 30 (35 / 40)
Min temperature at n_{max} relative to room temperature 23°C	2°C (4°C)	2°C (6°C)	0°C (2°C)
Speed at 4°C [rpm]	4150 (4600)	3750 (4500)	4150 (4600)
Aerosol-tight *	yes (with cap 75006421)	yes (with cap 75006448)	no
Autoclavable	121°C	121°C	121°C

* Checked by TÜV (Technical Supervision Association) Product Service GmbH - Hamburg

Table 2: Rotors for Legend™ RT 120V (differences of 200V / 230V instruments are shown in parentheses)

Rotor designation	Swinging Buckets Rotor 7500 6445 (7500 6434 with integrated locking mechanism)		
With bucket	Tissue culture bucket	Multiple carriers	Multiple carriers
Order no.	250 ml 7500 6497	25 x 5 / 7 ml 7500 6470	20 x 10 / 15 ml 7500 6471
max. tube dimensions $d^1) \times l$ [mm]	61 x 170	14 x 120	17 x 140
Maximum permissible load [g]	4 x 325	4 x 400 25 x 16	4 x 520 20 x 26
Maximum speed n_{max} [rpm]	3750 (4600)	3750 (4600)	3750 (4600)
Maximum RCF value at n_{max}	3348 (5039)	2814 (4235)	3018 (4542)
Radius (max.) [cm]	21.3	17.9	19.2
Acceleration / deceleration time [s]	45 / 25 (35 / 35)	45 / 25 (40 / 40)	50 / 30 (50 / 45)
Min temperature at n_{max} relative to room temperature 23°C	< 0°C (2°C)	< 0°C (2°C)	< 0°C (5°C)
Speed at 4°C [rpm]	3750 (4600)	3750 (4600)	3750 (4400)
Aerosol-tight *	no	no	no
Autoclavable	121°C	121°C	121°C

¹⁾ d = diameter

Table 2: Rotors for Legend™ RT 120V (differences of 200V / 230V instruments are shown in parentheses)

Rotor designation Order no.	BIOshield® Rotor 4 x 250 ml 7500 6435	Highplate® Rotor 2 x 5 plates 7500 6444	
Maximum permissible load [g]	4 x 600	2 x 500	
Maximum speed n_{max} [rpm]	5350 (5850)	5250 (5650)	
Maximum RCF value at n_{max}	5824 (6963)	5083 (5888)	
Radius (max.) [cm]	18.2	16.5	
Acceleration / deceleration time [s]	135 / 60 (95 / 75)	135 / 60 (100 / 75)	
Min temperature at n_{max} relative to room temperature 23°C	4°C	4°C	
Speed at 4°C [rpm]	5350 (5850)	5250 (5650)	
Aerosol-tight *	yes	yes	
Autoclavable	121°C	no	

* Checked by TÜV (Technical Supervision Association) Product Service GmbH - Hamburg

DJB Labcare - The UK's Leading Centrifuge Specialist
 info@djblabcare.co.uk www.djblabcare.co.uk 01908 612598

Table 2: Rotors for Legend™ RT 120V (differences of 200V / 230V instruments are shown in parentheses)

Rotor designation Order no.	Micro Liter Rotor 24 x 2.0 ml 7500 3332	Fixed-Angle Rotor 6 x 94 ml 7500 3334	Highconic® Rotor 6 x 50 ml 7500 3046
Maximum permissible load [g]	24 x 4	6 x 140	6 x 130
Maximum speed n_{\max} [rpm]	15 000	12 000	8500
Maximum RCF value at n_{\max}	21 885	16 260	10 016
Radius (max./min.) [cm]	8.7 / 5.9	10.1 / 6.3	12.4 / 6.0
Tube angle [°]	45	26	45
Acceleration / deceleration time [s]	30 / 35	65 / 45 (55 / 45)	35 / 30 (25 / 30)
Min temperature at n_{\max} relative to room temperature 23°C	< 0°C	< 0°C	< 0°C
Speed at 4°C [rpm]	15 000	12 000	8500
Aerosol-tight *	yes	yes	yes
Autoclavable	121°C	no	121°C

* Checked by CAMR, Porton-Down, UK

Adapter

<i>Table 3: Adapter (1)</i>		* max. tube length with aerosol-tight cap			
Adapter and accessories for round buckets 7500 6441	max. tube dimensions d x length / * [mm]	cap diameter [mm]	tubes per rotor	color	order no.
Centri-Lab® Adapter type C					
48 x 1.5 / 2 ml micro liter tube	11.0 x 50	13.0	192	black	7500 8132
35 x 7 ml DIN	12.8 x 125	14.0	140	yellow	7500 8133
19 x 7 ml blood sampling	13.5 x 125	18.5	76	light-grey	7500 8134
19 x 15 ml DIN	17.0 x 125	18.5	76	red	7500 8135
17 x 15 ml blood sampling	17.0 x 125	20.0	68	white	7500 8136
12 x 15 ml conical	16.5 x 123	23.5	48	olive-brown	7500 8137
12 x 14 / 15 ml with flange	18.3 x 125	21.5	48	brown	7500 6494
7 x 25 ml DIN	25.0 x 125	31.0	28	orange	7500 8138
7 x 45 / 50 ml flat and round bottom	29.5 x 125	31.0	28	blue	7500 6493
4 x 50 ml DIN	34.5 x 125	39.0	16	green	7500 8140
5 x 50 ml conical	29.5 x 123	35.5	20	light- green	7500 6495
2 x 100 ml DIN	45.0 x 125	47.5	8	light- blue	7500 8142
1 x 150 ml DIN / 180 ml bottle	56.5 x 132 / 128		4	black	7500 6498
1 x 175 -225 ml conical ¹⁾ / 250 ml bottle	62.0 x 140	75.0	4	nature	7500 8144
for your special tube	Customer adapted				750 15655
Aerosol-tight caps	2 pieces, incl. seals and lubricants				7500 6421
Bottle 750 ml (nominal volume)	100.0 x 135.4				7500 6443

¹⁾ An additional pad is necessary obtainable from tube manufacturers

<i>Table 3: Adapter (2)</i>		* max. tube length with aerosol-tight cap			
Adapter and accessories for rectangular buckets 7500 6446	max. tube dimensions d x length / * [mm]	cap diameter [mm]	tubes per rotor	color	order no.
Centri-Lab® Adapter type D					
56 x 1.5 / 2 ml micro liter tube	11.0 x 50	13.0	224	black	7500 6452
28 x 7 ml DIN	12.8 x 117	14.0	112	yellow	7500 6453
20 x 7 ml blood sampling	14.0 x 117	17.5	80	light-grey	7500 6454
16 x 15 ml DIN / blood sampling	17.0 x 117	19.0	64	red	7500 6455
9 x 15 ml conical / US-urine	16.5 x 120	24.0	36	olive-brown	7500 6456
9 x 14 / 15 ml with flange	18.3 x 117	25.0	36	brown	7500 6492
6 x 25 ml DIN	25.0 x 117	28.0	24	orange	7500 6457
4 x 25 / 50 ml universal container	25.5 x 117	32.0	16	blue-green	7500 6459
4 x 45 / 50 ml flat and round bottom	29.5 x 117	35.0	16	blue	7500 6491
3 x 50 ml DIN	34.5 x 117	38.0	12	green	7500 6460
4 x 50 ml conical	29.5 x 120	35.5	16	grey-green	7500 6461
1 x 100 ml DIN	45.0 x 120	66.0	4	grey-blue	7500 6462
1 x 150 ml DIN / 180 ml bottle	56.6 x 125	66.0	4	grey-blue	7500 6463
1 x 175 ml conical Falcon ¹⁾ / 250 ml bottle	62.0 x 120 / 125	63.0	4	black	7600 6465
for cyto-system				black	7600 6466
for Centri-Lab® Adapter type A				black	7600 6467
Aerosol-tight caps	2 pieces, incl. seals and lubricants				7500 6448

¹⁾ An additional pad is necessary obtainable from tube manufacturers

Adapter and accessories for BIOshield® Rotor 7500 6435	max. tube dimensions d x length / * [mm]	cap diameter [mm]	tubes per rotor	color	order no.
Centri-Lab® Adapter type D					
56 x 1.5 / 2 ml micro liter tube	11.0 x 50	13.0	224	black	7500 6452
28 x 7 ml DIN	12.8 x 117	14.0	112	yellow	7500 6453
20 x 7 ml blood sampling	14.0 x 117	17.5	80	light-grey	7500 6454
16 x 15 ml DIN / blood sampling	17.0 x 117	19.0	64	red	7500 6455
9 x 15 ml conical / US-urine	16.5 x 120	24.0	36	olive-brown	7500 6456
9 x 14 / 15 ml with flange	18.3 x 117	25.0	36	brown	7500 6492
6 x 25 ml DIN	25.0 x 117	28.0	24	orange	7500 6457
4 x 25 / 50 ml universal container	25.5 x 117	32.0	16	blue-green	7500 6459
4 x 45 / 50 ml flat and round bottom	29.5 x 117	35.0	16	blue	7500 6491
3 x 50 ml DIN	34.5 x 117	38.0	12	green	7500 6460
4 x 50 ml conical	29.5 x 118	35.5	16	light-blue	7500 6461
1 x 100 ml DIN	45.0 x 125	66.0	4	light-blue	7500 6462
1 x 150 ml DIN / 180 ml bottle ¹⁾	56.6 x 125	66.0	4	grey-blue	7500 6463
1 x 250 ml bottle	62.0 x 125	63.0	4	black	7600 6465
for cyto-system				black	7600 6466
for Centri-Lab® Adapter type A				black	7600 6467

¹⁾ Pay attention to the maximum load of 600 g

Table 3: Adapter (4)

Adapter for Micro Liter Rotor 7500 3332	max. tube dimensions d ¹⁾ x length [mm]	tube capacity [ml]	number per set	color	order no.
Reduction sleeve PCR	6.2 x 20	0,2	24	grey	7600 3750
Reduction sleeve	8 x 43.5	0.5 / 0,6	24	turquoise	7600 3758
Reduction sleeve	6 x 46	0.25 / 0.4	24	red	7600 3759

Adapter for Fixed-Angle Rotor Highconic® Rotor 7500 3046	max. tube dimensions d ¹⁾ x length [mm]	number per adapter	number per rotor	color	order no.
1.5 ml micro tube	11 x 58	4	24	nature	7600 2905
3.5 ml	11 x 103	4	24	nature	7500 3091
6.5 ml	13 x 115	2	12	nature	7500 3092
12 ml	16 x 96	2	12	nature	7500 3093
16 ml	18 x 124	1	6	nature	7600 2906
38 ml	25 x 112	1	6	nature	7500 3094
50 ml	29 x 118	1	6	nature	7500 3014
15 ml conical	16.5 x 120	1	6	nature	7500 3095
50 ml conical	30 x 117	1	6	nature	7500 3096
for your special tube	Customer adapted				750 15665
Spare seal	2 sets, incl. lubricants				7500 3423

¹⁾ d = diameter

Table 3: Adapter (5)

Adapter for Fixed-Angle Rotor 7500 3334	max. tube dimensions d ¹⁾ x length [mm]	number per adapter	number per rotor	color	order no.
1.5 ml micro tubes	11 x 51	4	24	nature	7600 2905
3.5 ml	11 x 95	4	24	nature	7500 3091
6.5 ml	13 x 108	2	12	nature	7500 3092
12 ml	16 x 89	2	12	nature	7500 3093
16 ml	18 x 117	1	6	nature	7600 2906
38 ml	25 x 104	1	6	nature	7500 3094
50 ml	29 x 110	1	6	nature	7500 3014

¹⁾d = diameter

Before use

Centrifuge transport and installation

After opening the box remove the protective materials.



When transporting the centrifuge, consider its weight (see „Technical Data“); always grab it on both sides taking care that enough helpers are around.

Do not lift on the front panel!

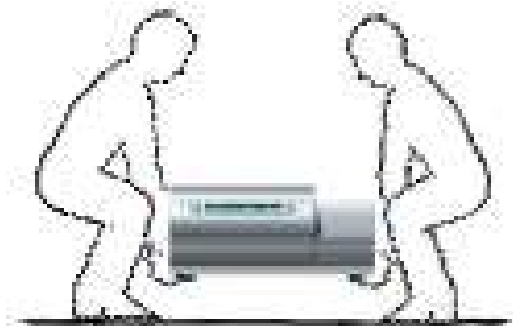

The centrifuge can be damaged by jolting during the transport!

Transport the centrifuge only in the upright position using proper containment and secure it properly. Handle the centrifuge carefully.

Proper location

The centrifuge may only be used indoors. Its location must meet the following criteria:

- A safety zone of at least 30 cm (12 inches) around the centrifuge must be maintained. Hazardous materials must not be stored beside unit while centrifugation.
- The laboratory bench or centrifuge trolley must be stable and resonance-free. A good support is provided by a laboratory bench or a centrifuge cart with lockable casters.
- To ensure sufficient air circulation, a minimum distance from the wall of 10 cm (4 inches) at the back and of 15 cm (6 inches) on each side must be kept.

- The centrifuge must be protected from heat and direct sunlight.
- The location must be well ventilated at all times.



UV rays reduce the durability of plastics.

Protect the centrifuge, rotors and plastic accessories from direct sunlight.

Main connection

Connect the centrifuge only to an grounded main power supply. Make sure that the power cord is compatible with the safety regulations valid, and that your main voltage and frequency correspond to the specifications on the instrument label.

Make sure that the centrifuge is switched off (on the right-hand side of front panel) before connecting electrical wire to main power supply.

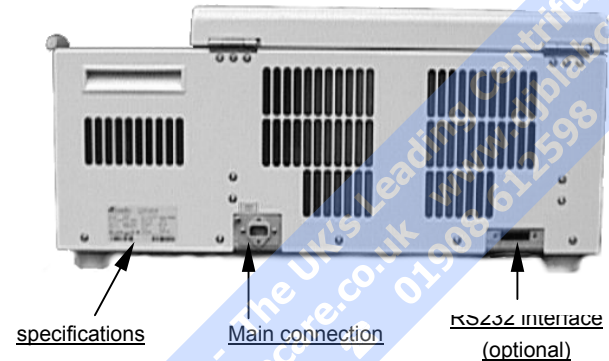

Operation

Switching on the centrifuge

Locate the main power switch on the right-hand side of the front panel, and set it to the ON (I) position. For a couple of seconds the following reading appears in the control panel:



The display shows that the instrument going through an internal check of its software. (see table on page 72).

After this check, the display shows to the actual value mode. The remaining run time and speed should both read 0. The display of the acceleration/deceleration curve depends on the last set value.

The following figure gives an example of possible readings. A detailed description of possible settings is given below in this chapter.



Actuating the lid

Opening the lid

Press the "open lid" key .

If the message "Lift lid" appears, you must lift the lid slightly.

(Emergency release in case of malfunction or power failure: see chapter "Troubleshooting")

Closing the lid

The centrifuge lid is locked by slightly pressing down the front part of the lid. Locking is motor-driven



Do not slam the lid!

Installing the rotor



Improper or improperly combined accessories may cause severe damage to the centrifuge!

The rotors approved for the *Legend*[™] are detailed in the chapter "Accessories". Use only rotors listed for this instrument.

To install the rotor, you need the socket wrench supplied* (see chapter "Accessories").

* The swinging buckets rotor 7500 6434 comes complete with a locking mechanism.

Proceed as follows:

1. Open the lid and make sure that the rotor chamber is clean. Clean any dust, foreign material or sample residues out of chamber before use.
2. Check whether the collet chuck is loose (collet chuck moves freely on the spindle). If not, loosen the rotor seat using the socket wrench supplied.
3. Place the rotor on top of the collet chuck so that the rotor is located precisely above the center.

4. The rotor must glide freely down the collet chuck until it hits the lower stop.
5. If you have positioned the rotor correctly, you can tighten the collet chuck easily using the socket wrench supplied.
6. Place the rotor cover on the rotor and tighten securely.



Regularly check the proper positioning of the rotor and re-tighten the collet chuck as needed.

Handling the rotor



On swinging bucket rotors, at regular intervals, apply a light coating of lubricant to the rotor body trunnion pins and to the corresponding mating surfaces on the buckets!

Lubricant 7000 6692 is supplied with the centrifuge.



Swinging Bucket Rotor 7500 6445

(7500 6434 with locking mechanism)



Do not operate the Swinging Bucket Rotor 7500 6445 with the rectangular buckets belonging to BIOshield® Rotors!

All positions have to be loaded with identical carrier buckets always!



The various swinging buckets are split up into weight categories. These can be identified from the letters suffixing the order number on the bucket. Buckets of identical weight categories should always be installed in opposing positions to avoid imbalance.

Handling microplates

Remove the microplate holder from carrier to load and unload the microplate carrier 7500 6449. Make sure, before loading, that the rubber bottom is placed in the cut-outs of the bottom of plate carrier. Deep-well plates can also be inserted in the carrier without using plate holder.

Operation

Insert the individual plate holders as shown in the illustration below.

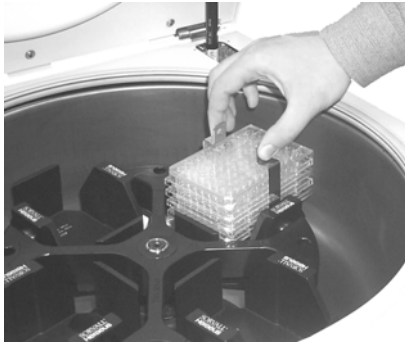

Make sure the rotor is uniformly loaded!



The maximum loading height is 60 mm with a base of 127 x 85 mm.

Large volume tissue culture tubes of 175 to 250 ml capacity, available from various manufacturers, can be used directly.

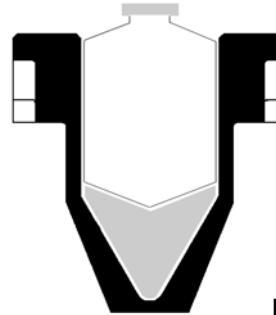

The adapters 70060302 supplied with the cell culture buckets are for use with flat-bottomed conical tubes.

Einsatz des Bodenformstücks

tube		
Falcon®	175 ml	x
	225 ml	x
Nalgene®	175 ml	-
Nunc™	200 ml	-
Corning®	250 ml	-

Tissue culture bucket 7500 6497

BIOshield® Rotor 7500 6435

The bucket set is a permanent part of the rotor and must not be interchanged with any different rotor.

Do not run the rotor without the rotor cover installed. The rotor cover is installed and removed by pushing down and turning the cover locking knob.

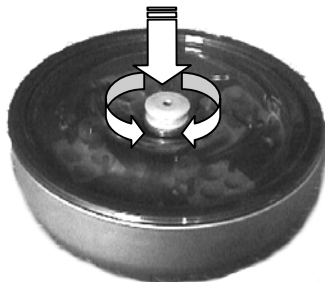

Store the BIOshield® Rotor with the cover removed after cleaning. This will enable the rotor to dry thoroughly.



The rotor has to be retired upon reaching the end of its life, which depends on the number of runs that may be performed, and varies depending on run speed.

max. speed	max. number of runs allowed
5850 rpm	22 000
5350 rpm	31 000

Exceeding the maximum number of cycles can result in rotor failure with subsequent damage to the centrifuge!

The following examples are intended to illustrate the different estimates of rotor life for various typical everyday use:

Profile of use	Max. period of use at	
	5850 rpm	5350 rpm
- frequent use 20 runs / day, 220 days / year	5 years	7 years
- average use 7 runs / day, 220 days / year	14 years	20 years



Always maintain the rotor in the recommended manner. The rotor and accessories must be clean and inspected regularly: do not use when showing signs of corrosion or cracking.



Store the Highplate®-Rotor with the cover removed after cleaning. This will enable the rotor to dry thoroughly.

Highplate® Rotor 7500 6444

Do not run the rotor without the rotor cover installed,



DJB Labcare - The UK's Leading Centrifuge Specialist
 info@djblabcare.co.uk www.djblabcare.co.uk 01908 612598

Handling microplates



Remove the appropriate plate holder from the carrier body for loading and unloading micro plates in the Highplate® Rotor 7500 6444.

Before loading, ensure that the rubber bottom is placed in the cut-outs of the bottom of the plate holder. Deepwell plates can also be inserted directly to the carrier without plate holder.

Make sure the rotor is balanced!

The plate carriers are inserted as shown in the illustration below.

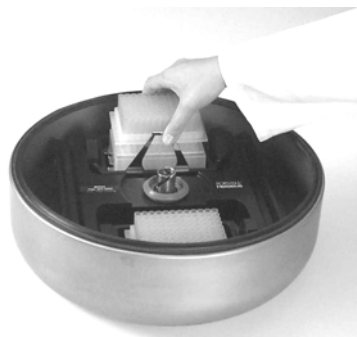

Highconic® - Rotor 7500 3046



In case longer tubes shall be centrifuged precluding the complete locking of the rotor cover, it is allowed to operate the rotor without cover up to a maximum speed of 4000 rpm.

Above 4000 rpm the rotor is not allowed to be operated without cover in any case. Otherwise the rotor could be destroyed.



Loading the rotor

Maximum loading



Overloading can result in destruction and severe damage to the centrifuge.

The *Legend*TM can reach high rotational speeds implying enormous centrifugal force. The rotors are designed in a way warranting sufficient residual strength even at the highest permissible speed.

However, this safety system presupposes that the maximum permissible load of the rotor is not exceeded.



Please note the data about the maximum permissible loads and maximum speeds in chapter "Rotor and accessories".

If you wish to centrifuge samples that together with the adapters exceed the maximum permissible load, you must either reduce the sample volume or calculate the permissible speed n_{perm} according to the following formula:

$$n_{perm} = n_{max} * \sqrt{\frac{\text{maximum permissible load}}{\text{actual load}}}$$

* n_{perm} = permissible speed
 n_{max} = maximum speed

Filling the centrifuge tubes



Check carefully whether your tubes are approved for the respective RCF value. Follow tube manufacturers recommendation.

For common borosilicate glass tubes the maximum permissible rcf is limited to 4000 xg!

The tube manufacturers normally limit the respective maximum allowed RCF value to the fixed angle rotor.



Please note that for the same RCF value the stress for the tubes in a swinging-bucket rotor is higher!

Because of the higher difference of the radii ($r_{\max} - r_{\min}$) the pressure of liquid column to the tube bottom is appreciably higher and strongly depended on filling.

Plastic tubes and bottles – especially for the highest load (speed, temperature) – have a limited life time only and must to be replaced as recommended by the manufacturer.

Maximum permissible load difference



The smaller the imbalance of the centrifuge, the better the separation effect, because as imbalance is minimized, so is the resultant vibration that could affect separation quality.

Therefore it is important, that the tubes are balanced properly.

The maximum permissible load difference depends on several factors (e.g. rotor, loading). For a swinging bucket rotor 7500 6445 this amounts to at least 20 g in opposite carriers.

The values refer to a weight difference on the bottom of the tube. If there is a weight difference resulting from inhomogeneously filled tubes, the centrifuge can operate with larger weight differences as well, without causing an imbalance interruption.

Inserting the centrifuge tubes



The rotor must be loaded symmetrically. Failure to do so can cause rotor imbalance, which may lead to noisy operation, affect separation quality, or result in imbalance detection shut-down, as well as introduce significant detrimental wear to the motor and drive system.

The rotor has to be loaded symmetrically. When loading the rotor only partially, you have to ensure that opposite bores always receive tubes of equal weight (when centrifuging a single sample, place a centrifuge tube e.g. filled with water).

After placing the tubes, install the rotor cover.

Fixed-angle rotors:

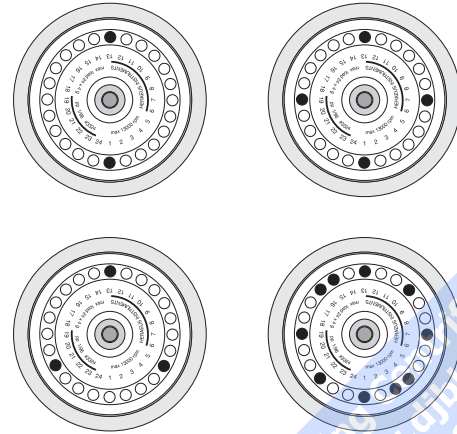

Proper loading

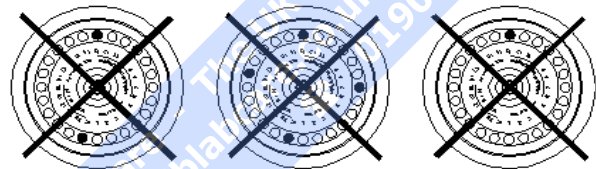

Improper loading

DJB Labcare Ltd. The UK's Leading Centrifuge Specialist
info@djb-labcare.co.uk www.djb-labcare.co.uk 1908 612598

Swinging bucket rotors:

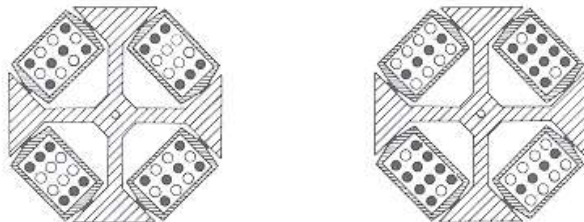
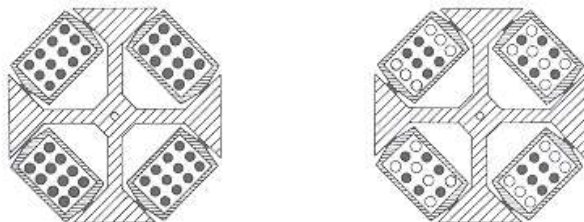
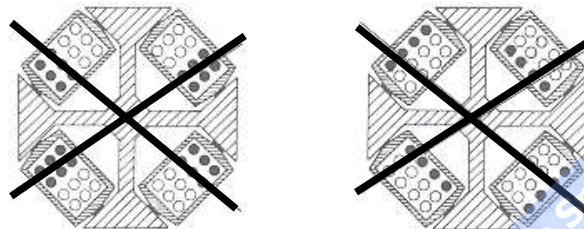

Proper loading



These examples are to be applied to the other rotors in an analogous manner!

Improper loading

DJB Labcare - The UK's Leading Centrifuge Specialist
info@djblabcare.co.uk 01908 605598

Aerosol-tight operation



Aerosol-tight rotors and tubes are only to be opened in an approved safety work bench when centrifuging dangerous samples!

Paying attention to the maximum permissible filling quantities is necessary!

Correct operation when filling the sample tubes and closing the rotor cover are prerequisites for aerosol bio-containment.



Before use, the seals in the rotors and rotor covers, as well as the aerosol-tight caps, have to be checked for abrasion or damage and slightly greased.

Replace damaged O-rings and seals!



Use the special lubricant 7600 3500 only to grease the seals !

Spare parts are delivered with the rotor or may be ordered separately.

Replace and lids



damaged or clouded caps of rotors and tubes immediately.

The tubes are only to be filled such that the sample does not reach the rim of the tube during centrifuging.

BIOshield®-Rotor
Highplate®-Rotor



The aerosol-tight bio-containment of air vessel rotors is only warranted in a horizontal position!

If the air vessel rotors are filled with samples outside the centrifuge (e.g. in a safety work bench), one has to care, that during the installation into the centrifuge the rotor should be kept in a vertical position.



Closing the aerosol-tight bio-containment

After greasing the seal, turn the cover until it sits lightly on the bucket.

To achieve uniform seal, turn the cover clockwise by 1 ½ grip area (approx. 15°). Use the setting marks on the bucket as a guide.



DJB Labcare - The UK's Leading Centrifuge Specialist
 info@djb-labcare.co.uk www.djb-labcare.co.uk 01908 22598

Closing fixed angle rotors for aerosol-tight bio-containment

The hexagon screwdriver of the pliers should be used as a support tool to fasten and loosen the cover of fixed angle rotors in order to achieve secure closing (insert the hexagon through the hole in the screw cap).

The maximum permissible filling volumes for most of the tubes used are listed in the table on page 44.



DJB Labcare - The UK's Leading Centrifuge Specialist
info@djblabcare.co.uk www.djblabcare.co.uk
01908 612598

Checking for aerosol-tight bio-containment



Check the aerosol-tight bio-containment of your rotor whenever appropriate!

Since you cannot yourself carry out the check with the swinging bucket rotors, you should monitor seals, sealing surfaces and screw caps particularly carefully!

To test, proceed as follows:

- Carefully clean and degrease the rotor chamber wall, then attach an adhesive white paper strip (about 4 x 2 cm) so that liquid leaking out of the rotor may precipitate on it.
- Fill all places of the respective rotor with water according to the following table. Insert the rotor into the centrifuge and fasten it.
- Carefully place the amount of test liquid (0.5 % sodium fluorescein in water) specified in the column “leakage test” into the lower part of the rotor within a virtual circle comprising the tube bores

(not the bores themselves) using a pipette or syringe.

- Place the rotor cover on top and screw it on.
CAUTION: Make sure that there is no spilled test liquid on the rotor (clean it if necessary)!
- Carry out a test run for 10 minutes at maximum rotor speed and 23 °C environmental temperature.
- Check the paper strip under UV light (preferentially in a darkened room):
If there is no detectable fluorescence, aerosol-tight bio-containment is maintained.
- Before using, rinse the rotor, rotor cover and cover seal in running water and allow to dry.

Rotor	Type of tube / permissible filling volume for the centrifugation of hazardous samples					leakage test
Micro liter rotor 24 x 2,0 ml 75003332	Micro 2.0 ml 1.5 ml					8 ml
Fixed-Angle Rotor 6 x 94 ml 75003334	94 ml / glt 58 ml	94 ml / Schr 58 ml	85 ml / Oakr 61 ml	50 ml / glt 36 ml	50 ml / Oakr 36 ml	1.5 ml
Highconic® Rotor 6 x 50 ml 75003046	conical 50 ml 49 ml	conical 15 ml 14 ml				*

***) tube filled to the rim, cover screwed on lightly**

- | | | | | | |
|---------|---|---------------------------------------|-----------|---|-----------------------------|
| • Micro | - | micro liter tube | • conical | - | conical tissue culture tube |
| • glt | - | smooth-rimmed tube | • Glas | - | glass tube |
| • Oakr | - | screw-cap tube type Oakridge | • Fla | - | PP bottle with screw cap |
| • Schr | - | screw-cap tube with extra fine thread | | | |

Entering parameters

Deceleration curves

The *Legend*™ offers 9 acceleration and deceleration profiles for optimal centrifuging samples and gradients. Please consult the diagrams in the Appendix for more detail of the acceleration and deceleration curves (for rotors not mentioned here you may extrapolate the respective values).

After switching the centrifuge on, the centrifugation profiles last entered are selected.

By pressing the “set” key  you can scroll through the profile settings until the desired profile is reached.

Once the display stops flashing, the value is stored in memory and remains unchanged until changed by a new entry.

Switching from speed to RCF display

Upon turning the centrifuge on, the speed display is set.

Use the speed mode selection key  to switch speed entry and display between rpm and RCF.

Bucket selection for swinging bucket rotors

When running a swinging bucket rotor, the automatic rotor identification feature will recognize the rotor body and not determine which bucket or carrier is installed. If various buckets or carriers are installed in the rotor cross, the corresponding type of bucket must be selected. The bucket selection affects the correct RCF values display and the correct selection of the corresponding parameters of the temperature regulation.

The current part number of the buckets is displayed by pressing the bucket selection key (corresponds to the last four 4 digits of the order number).

To change the bucket selection, press the bucket selection key again until the correct set of buckets appears.





The value is accepted when the change back to the speed RCF display has occurred.

Selecting speed

The centrifuge speed can be set to a minimum of 300 rpm and to a maximum of 15 000 rpm (depending on the rotor).

You can adjust the in 10 rpm increments. Proceed as follows:



1. By pressing the "set" keys  once (for an increase) or  (for a decrease) in the "speed" section of the control panel, you switch from actual to set point values. The value last stored is displayed, with the digit entered flashing (if there is no value stored in memory, this is indicated by dashes -----).



rpm) at a time.

2. By briefly pressing the input key you can raise or lower the speed by one step (10 rpm) at a time.
3. If you hold down the key pressed, the display changes at first slowly and after a few seconds at an accelerated pace.
4. Release the key as soon as you have reached the desired value, and adjust if necessary by repeatedly pressing the key. The decimal place

flashes for a number of seconds, then changes to permanent display. The speed is now stored.

For faster operation, you may shift the flashing cursor in the speed/RCF and the run time panels: just press both  and  simultaneously. The cursor moves by one digit to the left for each key depression.

Entering the RCF value

You can adjust the RCF set point in steps of 1. The set point is entered analogously to the speed.

As long as the rotor has not been identified, it is not possible to display RCF values. This is signaled by dashes ----- in the display.

Shortly after starting the centrifuge run, the rotor is identified and the current value is displayed.

NOTE:

If you set an extremely low RCF value, this may be automatically corrected if the resulting speed would be lower than 300 rpm.

DJB Labcare - The UK's leading online Specialist
info@djblabcare.co.uk www.djblabcare.co.uk 01908 559859

More about the RCF value

The **relative centrifugal force** (RCF) is given in multiples of the earth gravity g . It is a dimensionless number that allows one to compare the efficiency of separation or sedimentation of diverse instruments, since it is independent of the instrument used. The only values entered in the equation are radius and speed of centrifugation:

$$RCF = 11.18 * \left(\frac{n}{1000}\right)^2 * r$$

r = radius of centrifugation in cm

n = speed in rpm

The maximum RCF value refers to the maximum radius of the tube bore.



Please note that this value decreases depending on the tubes and adapters used.

You may take this into account when calculating the RCF value for your application.

Selecting run time



There are two time modes: standard and extended.

In the standard time mode you can select a run time between 1 min and 9 h 59 min or continuous operation (hLd) .

In the extended mode you can select a run time between 1 min and 99 h (from 10 h in one-hour steps), or continuous operation (hLd).

Run time selection

To set a time, proceed as follows:

1. Press one of the "set" keys  (for an increase) or  (for a decrease) in the "run time" section of the control panel once to switch from the actual to the set point mode.
2. By **briefly** pressing the "set" key you can now



raise or lower the run time in 1-minute increments.

- 3 If you keep the selected key pressed, the display changes at first slowly and after a few seconds at an accelerated pace.
- 4 Release the key as soon as you have reached the desired value, and adjust if necessary by repeatedly pressing the key.

The minute display flashes for a number of seconds, then changes to permanent display. The run time is now stored.

You may shift the flashing cursor to set the value as described under "Selecting speed".

Continuous operation

To switch the *Legend*TM to the continuous mode, you must press the key  until the display reads "hLd").



With this setting, the centrifuge keeps run until stopped manually.

Extended time mode

You can optionally switch to the extended time mode. To switch it on or off press the program selection key  and start the centrifuge simultaneously. As far as you keep the key pressed, the selective mode is active.

Pressing the upward key , you can switch back and forth between the signal menu „beep“ and the time menu “t-set“.

After selecting the time menu “t-set”, you can switch between the standards time mode “00.0” and the extended time mode „00”.h by pressing the upward key .



The time input in excess of 10 hours is set in one hour increments.

Selecting the temperature

You can select the temperature in the range of -9 °C to +40 °C.

(Please consult the standard diagram in the Appendix to obtain the attainable values.)

To adjust the temperature, proceed as follows:

1. Press one of the "set" keys  (for an increase) or  (for a decrease) in the "temperature" section of the control panel once to switch from the actual to the set point mode.
2. By **briefly** pressing the input key you can now raise or lower the run time in 1° steps.





3. If you keep the selected key pressed, the display changes continuously slowly at first and then at accelerated paces up or down.
4. Release the key as soon as you have reached the desired value, and adjust if necessary by repeatedly pressing the key.

The temperature display flashes for a number of seconds, then changes to the current value display. The temperature set point is now stored.

Pretemp function

The Pretemp function permits easy and quick pre-temperature-regulation of the empty rotor.

Upon calling this function by pressing the key , all you have to do is to enter the desired temperature.

After pressing the start key , the rotor temperature is equalized within 20 minutes at the speed defined in the Pretemp function.

Starting the centrifuge

Once the rotor is properly installed, the main switch turned on and the lid is closed, you can start the centrifuge.

Press the "start" key  in the control panel. The centrifuge accelerates to the selected value. Simultaneously time display starts counting down from the set time selected, at first giving the remaining run time in minutes and upon reaching the last minute in seconds (during continuous operation the time display goes forward).

If a value exceeding the maximum permissible speed or RCF of the respective rotor was entered, this is indicated after the start of the centrifuge by the alternately flashing messages "rotor" and the maximum permissible value for the inserted rotor.

Within 15 seconds you may adopt this value by again pressing the "start" key; the centrifugation is then continued. Otherwise the centrifuge stops, and you must enter a permissible value.

You cannot open the lid during the run.

Imbalance display

If rotor imbalance is detected, shortly after the rotor reaches 300 rpm, the message "bAL" will appear in the speed display.



The run is terminated, and you may restart the centrifuge after correcting the imbalance (check loading).

Changing the settings during the run

You can change all settings during a run. By pressing once any one of the "set" keys in the control panel you can switch from the actual to the set point mode.

The setting to be adjusted flashes and can then be altered. Once the data input is finished and the display has changed to the actual value display mode, the new settings become operative.

Stopping the centrifuge

Stopping with preset run time

Normally the run time has been selected, and all you have to do is wait until the centrifuge terminates the run automatically at the end of the set time.

As soon as the speed reaches zero, the display reads "End". You can now open the centrifuge by pressing the "open lid" key  and remove your samples.

If the lid has not been fully lifted out of the lid lock, the message "Lift lid" appears (you must manually lift the lid).

You can manually stop the centrifuge at any time by pressing the "Stop" key .

At this point the remaining run time is displayed.

Stopping with continuous operation

If you have chosen continuous operation, you must stop the centrifuge manually. Press the "Stop" key  in the control panel. The centrifuge starts deceleration with the preset deceleration profile.

The display reads "End", and you can open the lid by pressing the "Open lid" key  and remove your samples.

Temperature control during standby

Temperature control becomes active once the rotor has been identified. This is the case after a centrifugation run exceeding 300 rpm. At standby the display reads "End".

If the rotor has not been identified (lid has been closed and the "Start" key  has not yet been pressed, speed panel shows "0" with flashing point), the instrument regulates the temperature so that the samples cannot freeze in any one of the usable rotors.

If you find the systematic deviation of up to 4 K not being sufficient, you have to start the rotor for a short period until it is identified.

Working with programs

The 4 program selection keys offer the option of storing and recalling the individual centrifugation processes.



Program display

By actuating one of the program selection keys the specific set point values stored are displayed.

Entering/changing a program

All program places have been factory-set at the same values.

To change these values, proceed as follows:

- Entering the desired parameters
 - only the selection panel affected by the changes is flashing.
- After entering all set point values the desired program selection key has to be pressed for approx. 3 seconds:
 - the new program is being stored .

Repeat the process to set values to additional program places.

Centrifuging with a program

After closing the centrifuge lid, call the desired program memory number using the program selection key and press the start key .

If the rotor is started with a program the speed or RCF set point value of which exceeds the permissible one for the inserted rotor or the RCF/set point of which is below the rotor-specific minimum, the program selection keys LED of the program chosen beforehand will be switched off after the rotor identification.

”Quick Run”

For short-term operation, the *Legend*[™] is equipped with a "Quick Run" function.

Short-term centrifugation is started by pressing the "quick run" key  continuously; it stops as soon as the key is released.

In this mode the centrifuge accelerates with full power up to the maximum speed. The set speed or RCF is ignored in this case.



Depending on the rotor, the centrifuge accelerates to the maximum speed!

Check carefully whether you have to maintain a specific speed for your application.

During acceleration the time is counted forward in seconds. The display remains until the centrifuge lid is opened.

Removing the rotor

1. Open the centrifuge lid.
2. Remove the rotor cover.
3. Unscrew the clamping sleeve counterclockwise using the socket wrench supplied with the instrument until no resistance exists.
4. Grab the rotor with both hands and pull it perpendicularly off the drive shaft carefully. Make sure not to tilt it.



Grab rotor with both hands and pull upwards perpendicularly.

When using an aerosol-tight bio-containment cover, you may remove the respective rotor from the drive shaft without opening the cover! You may then open the rotor e.g. in a safety work bench and decontaminate it.

Audible alarm

Accompanying all error messages, a warning signal is given out which only is silenced upon pressing any key.

As an option, you can also have the end of a run signaled acoustically. To activate or deactivate this option press the program key  and switch on the centrifuge simultaneously. As far as you keep the key pressed, the selective mode is active.

The speed panel shows "beep" and the time panel shows "on" or "off".

By actuating the upward-key  in the time panel the signal function can be switched on or off.



When the message "rotor" flashes, pressing the start key once is sufficient to turn off the warning signal and to accelerate the rotor to the maximum speed displayed by the instrument.

Turning the centrifuge off

By switching the main switch into "0" position the centrifuge is turned off.



The main power switch should be turned off after a complete centrifugation run. Without motor deceleration, it takes much more time until the rotor comes to a halt.

The centrifuge lid can only be opened automatically if the centrifuge is turned on!

Maintenance and care

Routine maintenance to be performed by the customer

For the protection of persons, the environment and the equipment it is recommended to clean the centrifuge regularly and to disinfect it if necessary.



Unsuitable cleaning agents or disinfection procedures may damage the centrifuge and its parts!

If you intend to use cleaning agents or disinfection procedures not recommended by the manufacturer, you have to make sure by consulting the manufacturer, that the planned procedure does not cause any damages to the instrument!

Cleaning



Unplug the main power cord before cleaning the instrument!

Clean ventilation slots if necessary.

Clean the housing, the rotor chamber, the rotor and the accessories regularly and in case of need. This is indicated both for reasons of hygiene and to prevent corrosion due to contamination sticking to the instrument and its accessories.

Clean them with mild agents of pH values ranging from 6 to 8 such as dishwashing liquids.

The following cleaning agents have been approved by KENDRO:

- Caraform
- deconex 16 NT
- Extran MA 02 neutral
- RBS neutral

For all other cleaning agents please consult KENDRO.

After cleaning, dry the aluminum accessories with a soft cloth or put them into a drying oven (rotor and buckets must never be heated > 50°C / 122°F).



Liquids and especially organic solvents should not come into contact with the drive shaft and the ball bearing during cleaning.

Organic solvents can decompose the lubricant of the motor bearing. The drive shaft may block.

Refrigerated instruments:



If a strong ice sheet is present in the chamber, be sure to dry all condensate after defrosting.

Disinfection

If a centrifuge tube containing infectious material leaks during a run, you have to disinfect the centrifuge immediately.



Infectious material could enter the centrifuge if spills or tube breakage occur! Danger of infection may occur upon contact!

Take appropriate personal protective measures!

Comply with the permissible filling volumes and loading limits for the tubes!

In case of contamination the operator has to make sure, that no further persons are threatened.

Contaminated parts have to be decontaminated immediately.

If required further protective measures have to be initiated.

Rotor and rotor chamber must be treated with a neutral, universal disinfectant. Best suited for this purpose are disinfectant sprays, which ensure that all rotor and accessory surfaces are covered evenly.

- Use only disinfectants approved by KENDRO. These agents are to be used according to the Instructions for Use supplied with the respective disinfectant:
 - Aldasan 2000
 - Carlitt Spray
 - Coldspore
 - Gigasept FF
 - HBV Pump-Spray
 - Incidin Liquid Spray
 - Incidur Spray
 - Incidin plus
 - Kohrsolin iD
 - Lysetol FF
 - Lysoform
 - Lysoformin 3000
 - Sagromed
 - Sagrotan
- You may disinfect the rotor and the accessories as described in the following section. Be sure to follow the pertinent safety procedures for handling infectious material.
 1. Unplug the main power cord.
 2. Unscrew the collet chuck.
 3. Grab the rotor with both hands and pull it perpendicularly off the drive shaft.
 4. Remove the centrifuge tubes and adapters, and disinfect them or dispose of them as necessary.
 5. Treat the rotor and the rotor cover according to the instructions given for the disinfectant (soaking in liquid or spraying). You must strictly observe the specified reaction times!
 6. Turn the rotor head down and drain it. Thoroughly rinse rotor and cover with water.
 7. Dispose of the disinfectant solution as according to valid regulations.
 8. Aluminum rotors have to be treated with anticorrosive grease subsequently.

For all other disinfectants please consult KENDRO.

Disinfection with bleaching lye



These agents contain highly aggressive hypochlorites and must not be used with aluminum rotors!

Decontamination

For general radioactive decontamination, use a solution of equal parts of 70% ethanol, 10% SDS and water. Follow this with ethanol rinses, then deionized water rinses, and dry with a soft absorbent cloth. Dispose of all wash solutions in proper radioactive waste containers.

Autoclaving



Check whether autoclaving is permitted!

(see label on the rotor body and the rotor cover)

For the autoclaveable parts the allowed autoclaving cycle is 20 min at 121 °C.

Remove the rotor cover together with the centrifuge tubes and the adapter. The rotor has to be cleaned and rinsed with distilled water before being auto-

claved. Buckets and tubes must not to be closed during autoclaving.

Place plastic rotors on an even surface to avoid deformation.



Chemical additives to the steam are not permitted.

Never exceed the maximum permissible autoclaving time and temperature.



Aluminum rotors have to be treated with corrosion protective oil each time they have been autoclaved.

Should the rotor show signs of wear or corrosion, you must stop using it!

Corrosion protective oil 7000 9824 is delivered with the centrifuge.

The KENDRO service offering

Kendro Laboratory Products recommends annual servicing of the centrifuge and the accessories by an authorized service personnel. The preventive service provided by KENDRO includes checking:

- the electrical installation If a centrifuge tube containing infectious material leaks during a run, you have to disinfect the centrifuge immediately.
- the suitability of the location
- the lid lock mechanism and the safety circuit
- the rotor
- the rotor fastening and the drive shaft

Defective parts are exchanged.

KENDRO offers inspection and service contracts covering these benefits. Inspection costs are charged as flat-rate contracts.

Necessary repairs are carried out free of cost during the warranty conditions, and against payment after expiration of the warranty.

Warranty conditions

The warranty period starts with the day of delivery. Within the warranty period the centrifuge is repaired or replaced free of cost if there are demonstrable faults in materials or workmanship.

Conditions for a warranty are that:

- the centrifuge is used according to the instructions of use
- installation, additions, adjustments, changes or repairs are carried out exclusively by personnel authorized by KENDRO
- the required maintenance and care procedures are carried out regularly.

Notes

DJB Labcare - The UK's Leading Centrifuge Specialist
info@djblabcare.co.uk www.djblabcare.co.uk
01908 612598

Troubleshooting

Emergency lid release

In case of a power failure the lid could not be opened normally using the electrical lid unlocking mechanism. To permit unloading in this case, the centrifuge is equipped with an emergency override release. However, you may use this system in case of emergency only.



**Rotors can spin at high speed!
Touching it may cause severe injuries!**

Always wait for several minutes until the rotor has come to a complete stop. Without power the brake does not function, and deceleration takes much longer than normal!

Proceed as follows:

1. Make sure that the rotor is at a stand still (observe through window in the cover).



During a power failure it is impossible to lock the lid once the emergency lid release has been used. Never stop the rotor using your hands or tools!

2. Unplug the main power cord.
3. Facing the centrifuge under the left-hand side there is a plastic plug that can be removed using a screwdriver. After removal, use your fingers or a pair of pliers to pull the attached cord and activate the manual door override. The lid will open and you can remove your samples.



4. After finished, push the cord back into the instrument and reinserting the plastic plug.

Once the power is restored, you can connect the instrument to the main supply and turn it on.

Following the self test of the centrifuge, the lid may be closed and locked with the motor.

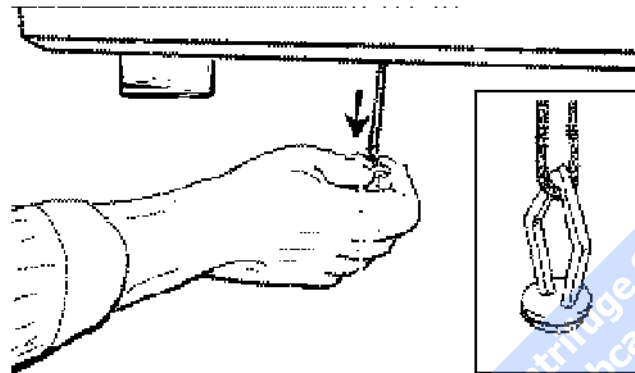

DJB Labcare - The UK's Leading Centrifuge Specialist
info@djblabcare.co.uk www.djblabcare.co.uk
01908 612598

Error troubleshooting



If problems other than those described in the following tables arise, you must contact KENDRO service.

Error	Symptom	Possible causes and corrective measures
Displays remain dark	The drive stops. The rotor stops without deceleration. The lid cannot be opened.	Mains power failure or not connected 1. Is the main plug connected to the main socket? 2. Check the main connection. 3. If the main connection is OK, contact KENDRO service.
Displays fail briefly.	The drive stops suddenly. The rotor stops without deceleration.	Brief interruption of main supply 1. Turn off main switch. 2. Check whether the mains power cord is connected properly. 3. Restart the centrifuge.

Error	Symptom	Possible causes and corrective measures
-------	---------	---

DJB Labcare - The UK's Leading Centrifuge Specialist
 info@djblabcare.co.uk www.djblabcare.co.uk
 01908 612598

<p>Lid cannot be opened.</p>	<p>Pressing the "open lid" key has no effect.</p>	<p>Lid not correctly engaged or lid warped.</p> <ol style="list-style-type: none"> 1. Check whether main power is on and the instrument is switched on (display is lit). 2. Press lid down in the middle of the front section once, and press the "open lid" key. 3. If this is unsuccessful, you may open the lid using the emergency lid release (see page 61).
<p>–</p>	<p>Centrifuge is exceptionally noisy.</p>	<p>Imbalance.</p> <ol style="list-style-type: none"> 1. Stop the centrifuge by pressing the "stop" key, in case of emergency, unplug mains power cord. 2. Wait until the centrifuge comes to a complete stop. 3. Check whether the rotor is properly loaded. 4. Check whether a broken tube, damage to the rotor or motor malfunction is responsible for the noise. <p>If you cannot locate and solve the problem yourself, contact KENDRO service.</p>

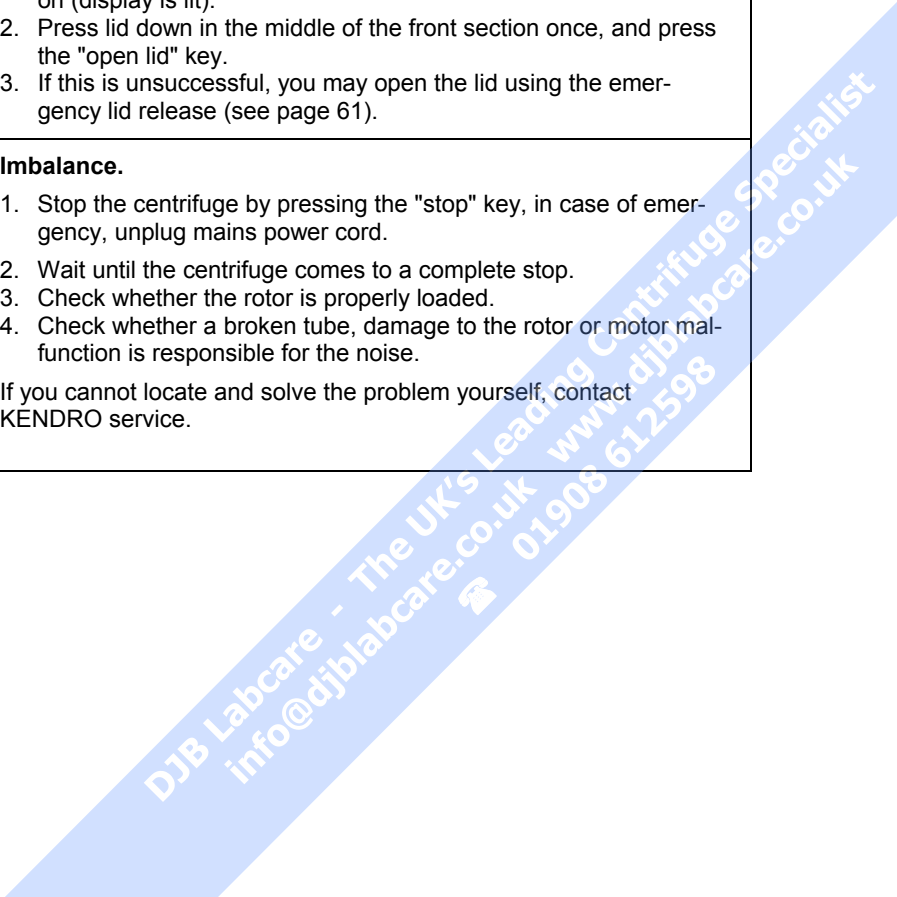

Error	Symptom	Possible causes and corrective measures
<p>Message "bAl" appears in display.</p>	<p>Rotor stops with deceleration.</p>	<p>Imbalance switch actuated</p> <ol style="list-style-type: none"> 1. Open the instrument by pressing "open lid" key . 2. Check whether the rotor is properly loaded. 3. Check whether a broken tube or damage to the rotor was responsible for imbalance switch actuation. 4. Check that the trunnions of the swinging bucket rotor have been properly lubricated. <p>If you cannot locate and solve the problem yourself, contact the KENDRO service.</p>
<p>Message "rotor" appears in display.</p>	<p>Rotor decelerates with delayed deceleration.</p>	<p>Set speed exceeds permissible maximum speed for the rotor. (The same holds for RCF setting)</p> <p>A) For about 15 sec. the display shows alternately "rotor" and the maximum permissible speed or RCF for the installed, after the rotor identification. Within this period, it is possible to accept this value by again pressing the "start" key. The centrifugation is then continued.</p> <p>B) Following onset of deceleration you must wait until the rotor has stopped. By opening and closing the lid you reset the message "rotor". After entering a permissible speed you can press start.</p>
<p>Error</p>	<p>Symptom</p>	<p>Possible causes and corrective measures</p>

Troubleshooting

Display "OPEN" appears although lid is closed.	Will not start.	Lid not properly closed Open the lid and repeat locking procedure.
Message "Lid" appears flashingly in the display.	Drive stops. Rotor stops without deceleration to standstill.	Lid was opened manually during the run. The instrument stops without deceleration. If you want to continue the run, you must switch the instrument off and on again.
Message "Lift Lid" appears in the display	Lid does not open automatically.	The lid has not been unlocked after release. 1. Avoid laying objects onto the centrifuge lid. 2. Lift the lid slightly.
E-01 E-13	Rotor stops without deceleration to standstill. Instrument cannot be operated.	Internal program error. Switch the instrument off and on again. If the error persists, contact KENDRO service.
E-14	Rotor stops with deceleration to standstill. Instrument cannot be operated.	Overtemperature in the centrifuge tank. Switch the instrument off and on again. If the error persists, contact KENDRO service.
Error	Symptom	Possible causes and corrective measures

<p>E-15 E-16</p>	<p>Rotor stops with deceleration to standstill. Instrument cannot be operated.</p>	<p>Temperature measurement error. Switch the instrument off and on again. If the problem persists, contact KENDRO service.</p>
<p>E-17</p>	<p>Rotor stops with deceleration to standstill. Instrument cannot be operated.</p>	<p>Max speed for the rotor identification exceeded. Switch the instrument off and on again. If the problem persists, contact KENDRO service.</p>
<p>E-18</p>	<p>Instrument stops with deceleration to standstill after short starting-up.</p>	<p>Bucket code for this rotor is not defined. Check, whether the bucket is permitted for the inserted rotor (rotor program, page 14).</p>
<p>E-19</p>	<p>Instrument stops with deceleration to standstill after short starting-up.</p>	<p>Uncertified rotor. Check, whether the rotor used is permitted to be operated in this instrument (rotor program, page 14).</p>
<p>E-20</p>	<p>Instrument does not start or brakes to standstill.</p>	<p>Rotor cannot be identified. A) Check whether a certified rotor is inserted. B) Check whether the rotor is completely fastened onto the motor shaft. For this release the rotor fastening until you can lift and depress it easily. Tighten the rotor fastening once again now.</p>
<p>Error</p>	<p>Symptom</p>	<p>Possible causes and corrective measures</p>

E-21	Instrument does not start or brakes to standstill.	<p>No rotor present or rotor identification impossible</p> <p>A) Check whether a certified rotor is inserted.</p> <p>B) Following a brief power failure, the rotor could not be identified. Switch the instrument off and on again using the main switch.</p>
E-22 E-23	<p>Rotor stops without brake to standstill.</p> <p>Instrument cannot be operated.</p>	<p>Error in speed measurement</p> <p>Switch the instrument off and on again. If the error persists, contact KENDRO service</p>
E-24 E-27	Instrument cannot be operated.	<p>Wrong status information from lid lock.</p> <p>Switch the instrument off and on again. If the error persists, contact KENDRO service.</p>
E-28	Instrument decelerates after a short starting-up.	<p>Motor runs in wrong rotational direction.</p> <p>Switch the instrument off and on again. If the error persists, contact KENDRO service.</p>
Error	Symptom	Possible causes and corrective measures

DJB Labcare - The UK's Leading Centrifuge Specialist
 info@djb-labcare.co.uk www.djb-labcare.co.uk 01900 612598

E-29	Motor does not start.	<p>Motor or rotor blocked.</p> <ol style="list-style-type: none"> 1. Switch instrument off and on again using the main switch. 2. Open the lid. 3. Check whether the rotor can turn freely. <p>If you cannot clear the malfunction, contact KENDRO service.</p>
E-30	Rotor stops without brake to standstill or does not start.	<p>Control voltage breaks down.</p> <p>Switch the instrument off and on again. If the error persists, contact KENDRO service.</p>
E-31	Rotor stops without brake to standstill or does not start.	<p>Overtemperature in the motor.</p> <ol style="list-style-type: none"> 1. Turn instrument off and unplug mains power cord. 2. Check and clean ventilation slots if necessary. 3. After about 60 min you can restart the instrument. <p>Observe the max. permissible environmental temperature! If the error persists, contact KENDRO service.</p>

DJB Labcare - The UK's Leading Centrifuge Specialist
 info@djblabcare.co.uk www.djblabcare.co.uk
 01908 612598

Error	Symptom	Possible causes and corrective measures
E-32	Rotor stops without brake to standstill or does not start.	<p>Overtemperature in the electronics.</p> <ol style="list-style-type: none"> 1. Turn instrument off and unplug mains power cord. 2. Check and clean ventilation slots if necessary. 3. After about 60 min you can restart the instrument. <p>Observe the max. permissible environmental temperature! If the error persists, contact KENDRO service.</p>
E-33	Rotor stops without brake to standstill or does not start.	<p>Overpressure in the refrigeration system</p> <ol style="list-style-type: none"> 1. Turn instrument off and pull main plug. 1. Check and clean ventilation slots if necessary. 2. After about 60 min you can restart the instrument. <p>Observe the max. permissible environmental temperature! If the error persists, contact KENDRO service.</p>
E-34	Rotor stops without brake to standstill or does not start.	<p>Overvoltage in the intermediate circuit.</p> <p>Switch the instrument off and on again.</p> <p>If the error persists, contact KENDRO service.</p>
E-35	Rotor stops without brake to standstill or does not start.	<p>Overcurrent in the intermediate circuit.</p> <p>Switch the instrument off and on again. If the error persists, contact KENDRO service.</p>
Error	Symptom	Possible causes and corrective measures

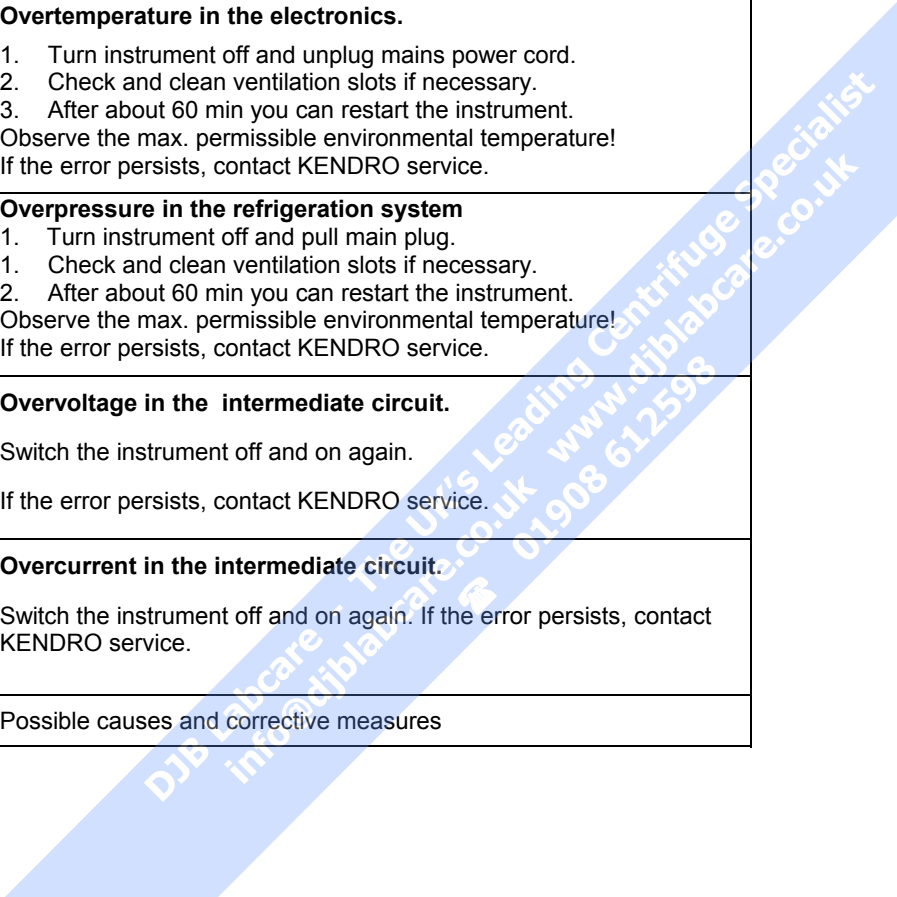

<p>E-36 E-38</p>	<p>Rotor stops without brake to standstill. Instrument cannot be operated.</p>	<p>Overcurrent or error in current measurement. Switch the instrument off and on again. If the error persists, contact KENDRO service.</p>
<p>E-39</p>	<p>Rotor stops without brake to standstill. Instrument cannot be operated.</p>	<p>Speed control measurement exceeds permissible rotor speed. Switch the instrument off and on again. If the error persists, contact KENDRO service.</p>
<p>E-40</p>	<p>Rotor stops without brake to standstill. Instrument cannot be operated.</p>	<p>Acceleration of rotor too slow Open the lid and check the load!</p> <ul style="list-style-type: none"> - Significant imbalance caused by missing bucket - Tubes or adapter do not fit (rotor is rubbing the chamber or the cover) - Micro plates carriers on the motor cover <p>If the error persists, contact KENDRO service.</p>

DJB Labcare - The UK's Leading Centrifuge Specialist
 info@djblabcare.co.uk www.djblabcare.co.uk 01908 612598

Technical Data

Features	specification						
Ambient conditions	<ul style="list-style-type: none"> - indoor use - maximum elevation 2000 m (6562 ft) above sea level - max. relative humidity 80 % up to 31°C (88°F), linearly decreasing down to 50 % relative humidity at 40°C (104°F). 						
Ambient temperature allowed	+2 °C to +35 °C (36°F to 95°F)						
run time	<ul style="list-style-type: none"> - standard mode : 1 min - 9 h 59 min, hold = permanent - extended mode : 1 min – 99 h, hold 						
maximum speed (n_{\max})	15 000 rpm (rotor-dependent, adjustable in steps of 10)						
minimum speed (n_{\min})	300 rpm						
maximum RCF	21 885 (micro liter rotor)						
maximum kinetic energy	<table style="width: 100%; border: none;"> <tr> <td style="width: 150px;">Legend™ T</td> <td>45.8 kNm</td> <td>(33 780 ft.lb)</td> </tr> <tr> <td>Legend™ RT</td> <td>54.8 kNm</td> <td>(40 418 ft.lb)</td> </tr> </table>	Legend™ T	45.8 kNm	(33 780 ft.lb)	Legend™ RT	54.8 kNm	(40 418 ft.lb)
Legend™ T	45.8 kNm	(33 780 ft.lb)					
Legend™ RT	54.8 kNm	(40 418 ft.lb)					
noise at maximum speed	<table style="width: 100%; border: none;"> <tr> <td style="width: 150px;">Legend™ T</td> <td>< 66 dB (A)</td> </tr> <tr> <td>Legend™ RT</td> <td>< 55 dB (A)</td> </tr> </table> <p>(sound pressure level of emission according to DIN EN ISO 11 201)</p>	Legend™ T	< 66 dB (A)	Legend™ RT	< 55 dB (A)		
Legend™ T	< 66 dB (A)						
Legend™ RT	< 55 dB (A)						
Temperature set range	-9 °C to +40 °C						

Technical Data

Features		specification
Dimension (H x W x D)	Legend™ T Legend™ RT	362 mm x 551 mm x 666 mm (14.3 x 21.7 x 26.2 inches) 362 mm x 733 mm x 666 mm (14.3 x 28.7 x 26.2 inches)
Weight without rotor	Legend™ T Legend™ RT	89 kg (196 lb) 131 kg (288 lb)
Standards for all voltages Manufactured and checked in accordance with		IEC 61010-1:1990 + amendment 1:1992 + amendment 2:1995 IEC 61010-2-020:1993 + amendment 1:1996
120V instruments Manufactured and checked in accordance with		CAN/CSA-C22.2 No. 1010-1.92 CAN/CSA-C22.2 No. 1010-1.B97 amendment 2 UL 3101-1
230V instruments Manufactured and checked in accordance with		EN 61 010-1, EN 61 010-2-020 EN 61326 (+ EN 61000-3-2/A14:2000-06) EN 55011 B, EN 61000-6-2.

Electrical connections / fuses

Order no.	Voltage	Frequency	Nominal current	Power consumption	Fuse protection of instrument - safety fuse * thermic excess current release	Fuse protection of building
Legend™ T 7500 4367	120 V	60 Hz	10.2 A	900 W	15 A	15 AT
Legend™ T 7500 4363	230 V	50/60 Hz	8.6 A	1250 W	10 A	16 AT
Legend™ RT 7500 4377	120 V	60 Hz	12.0 A	1220 W	15 A * 16 A	15 AT
Legend™ RT 7500 4373	230 V	50/60 Hz	10.6 A	1900 W	10 A * 16 A	16 AT
Legend™ T 7500 4368	100 V	50/60 Hz	12.9 A	920 W	15 A	15 AT
Legend™ RT 7500 4378	200 V	50/60 Hz	11.7 A	1920 W	10 A * 14 A	15 AT

DJB Labcare - The UK's Leading Centrifuge Specialist
 info@djblabcare.co.uk www.djblabcare.co.uk
 01908 612595

Notes

DJB Labcare - The UK's Leading Centrifuge Specialist
info@djblabcare.co.uk www.djblabcare.co.uk
01908 612598

Appendix

Acceleration and deceleration profiles

On the following pages you find acceleration and deceleration profiles for each rotor type respectively

DJB Labcare - The UK's Leading Centrifuge Specialist
info@djblabcare.co.uk www.djblabcare.co.uk
01908 612598

Acceleration profiles
Swinging bucket rotor with rectangular buckets 7500 6446

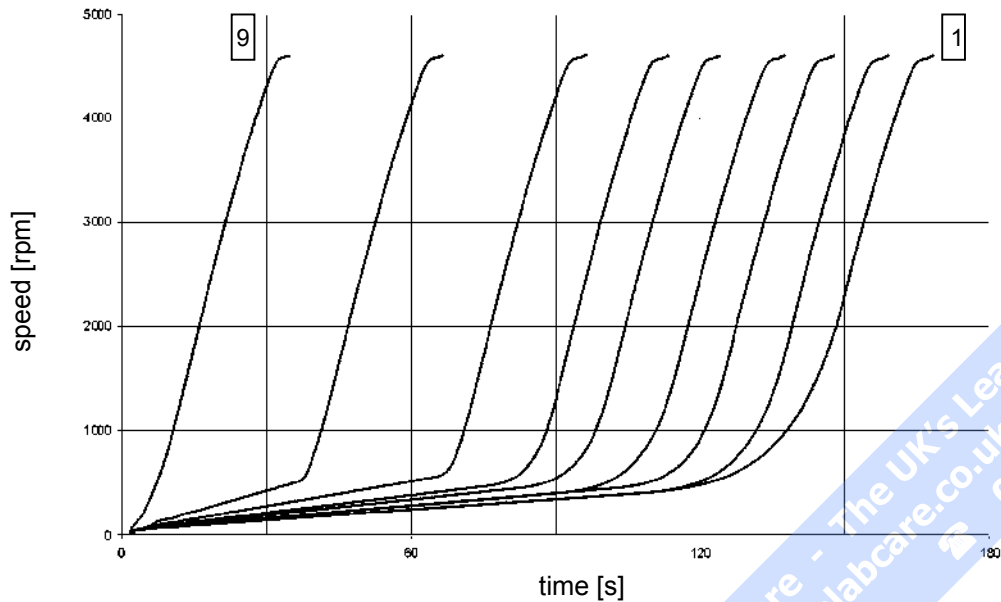

DJB Labcare - The UK's Leading Centrifuge Specialist
info@djblabcare.co.uk www.djblabcare.co.uk
01908 612598

Deceleration profiles

Swinging bucket rotor with rectangular buckets 7500 6446

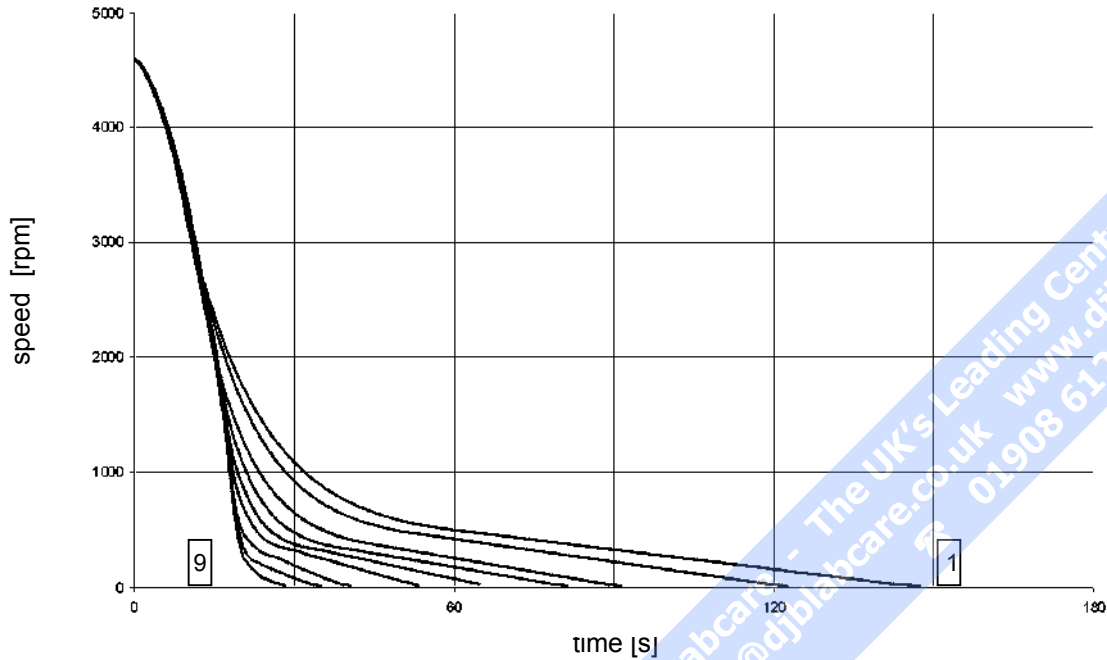

DJB Labcare - The UK's Leading Centrifuge Specialist
info@djblabcare.co.uk www.djblabcare.co.uk
01908 612598

Acceleration profiles

BIOshield® Rotor

7500 6435

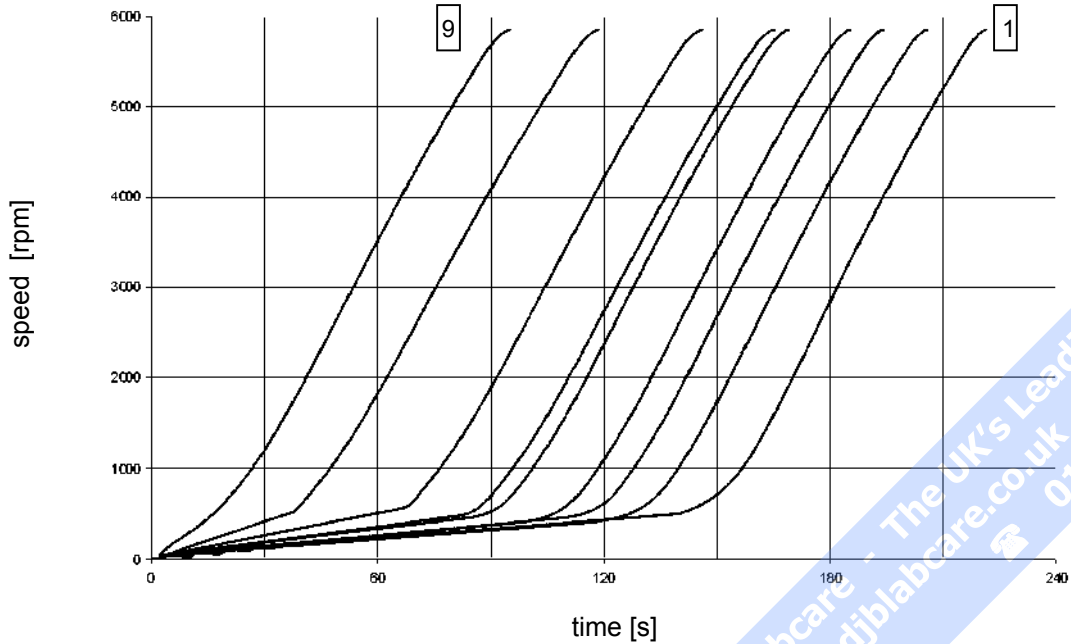

DJB Labcare - The UK's Leading Centrifuge Specialist
info@djblabcare.co.uk www.djblabcare.co.uk 01908 612598

Deceleration profiles

BIOshield® Rotor
7500 6435

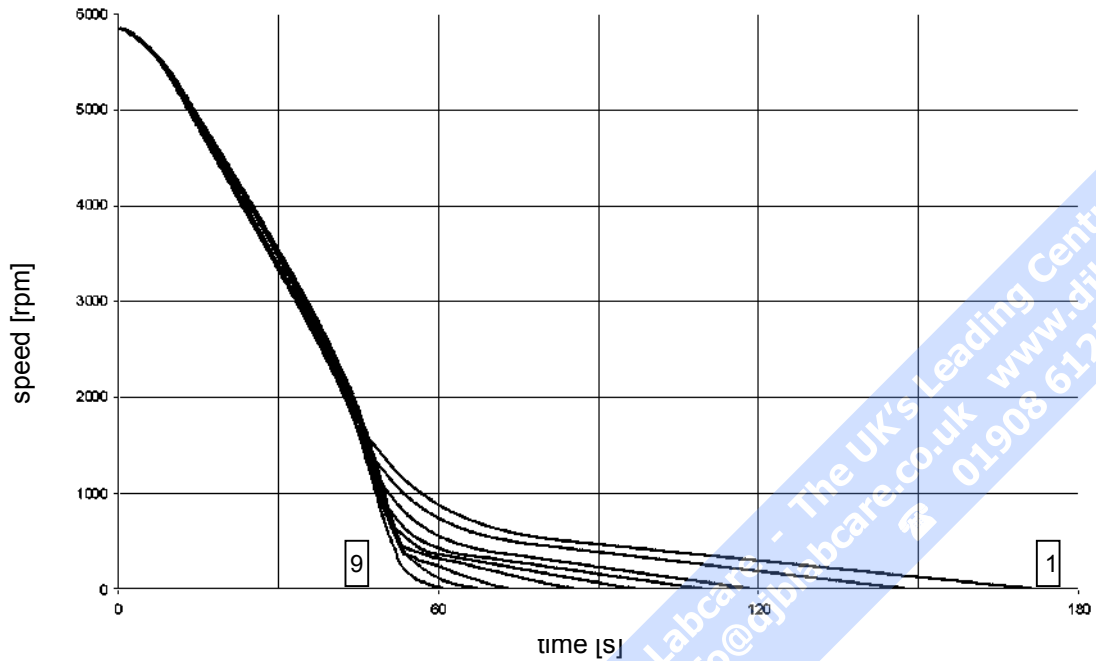

Acceleration profiles

Micro liter Rotor

7500 3332

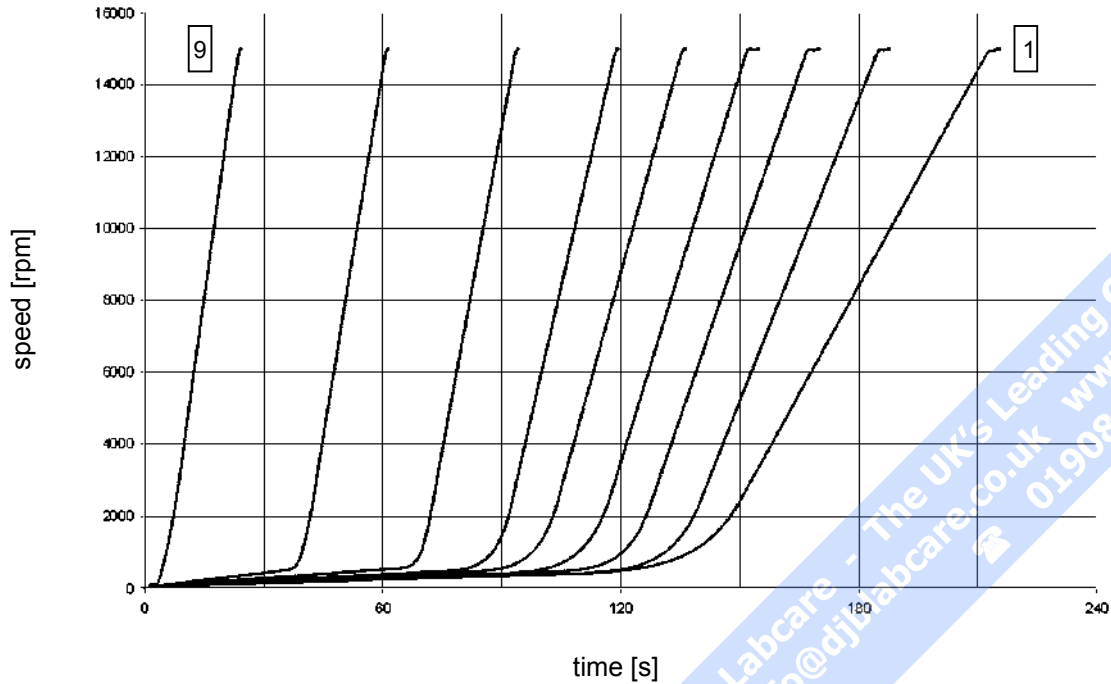

DJB Labcare - The UK's Leading Centrifuge Specialist
info@djblabcare.co.uk www.djblabcare.co.uk
01908 612598

Deceleration profiles

Micro liter Rotor

7500 3332

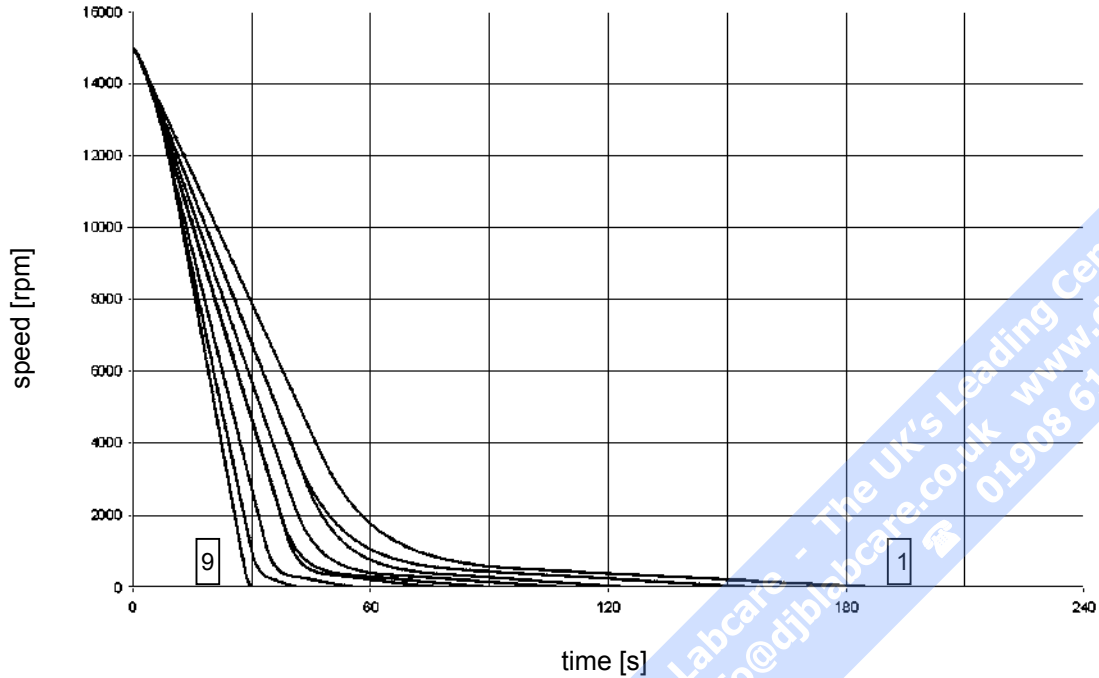

DJB Labcare - The UK's Leading Centrifuge Specialist
info@djblabcare.co.uk www.djblabcare.co.uk
01908 612598

Acceleration profiles

Highconic[®] Rotor

7500 3046

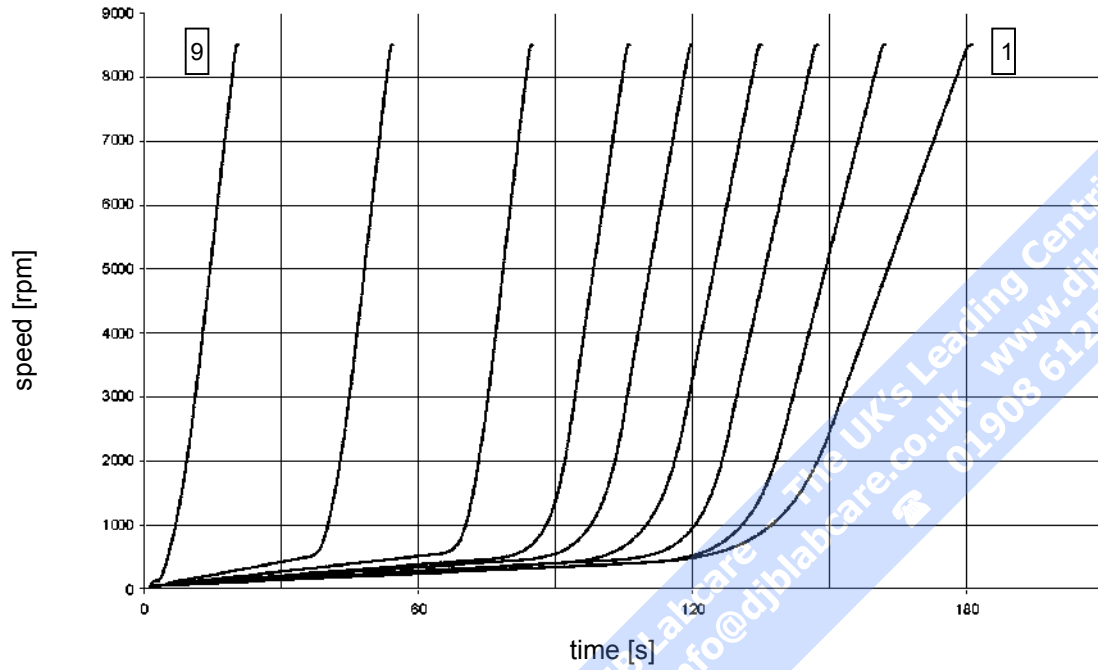

Deceleration profiles

Highconic® Rotor

7500 3046

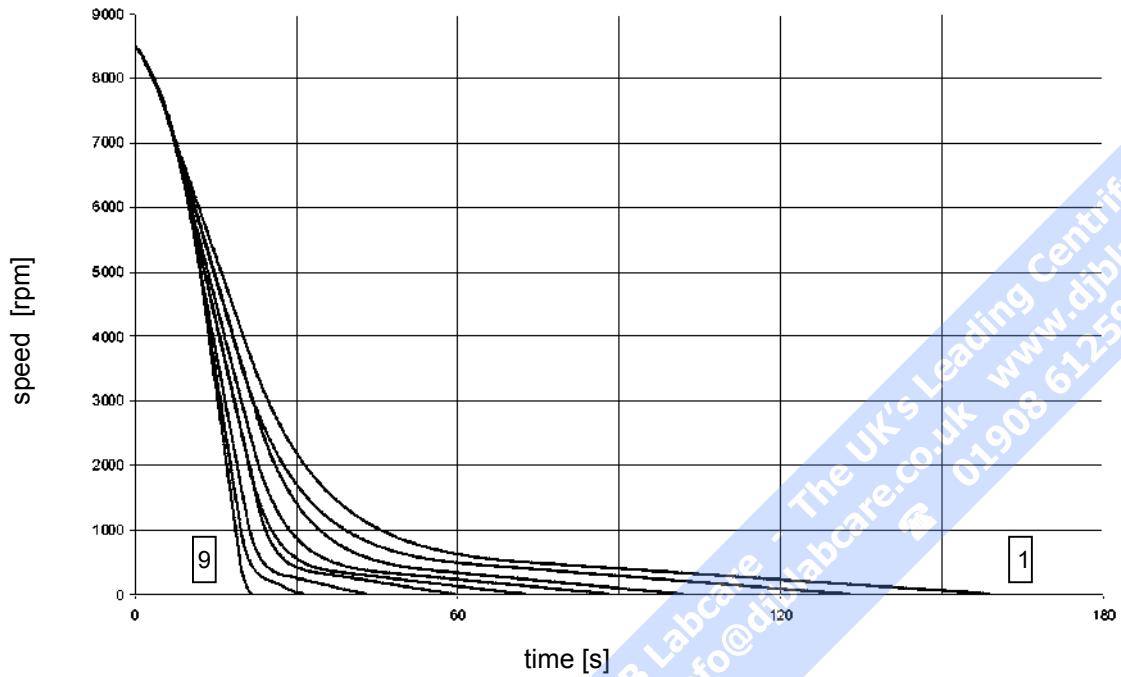

DJB Labcare - The UK's Leading Centrifuge Specialist
info@djblabcare.co.uk www.djblabcare.co.uk
01908 612598

Speed/RCF diagrams

* n_{\max} = max. speed

Speed/RCF diagram

Swinging Bucket Rotor 7500 6445 (7500 6434)

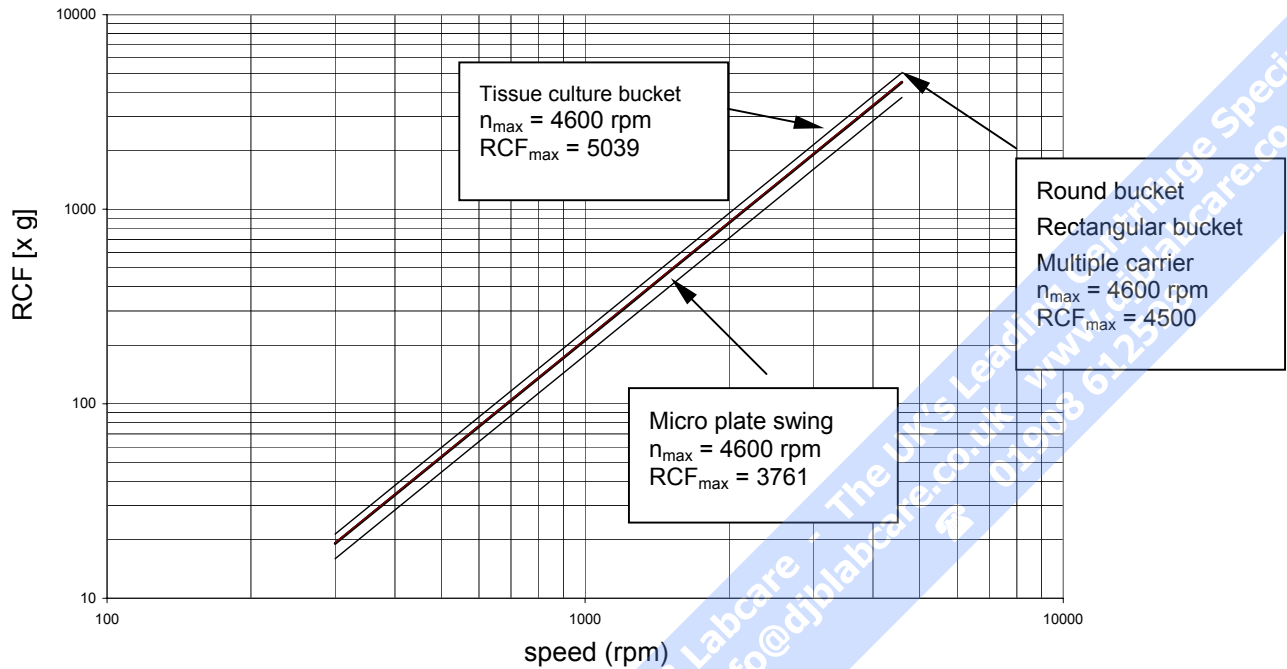

Speed/RCF diagram BIOshield® Rotor 7500 6435

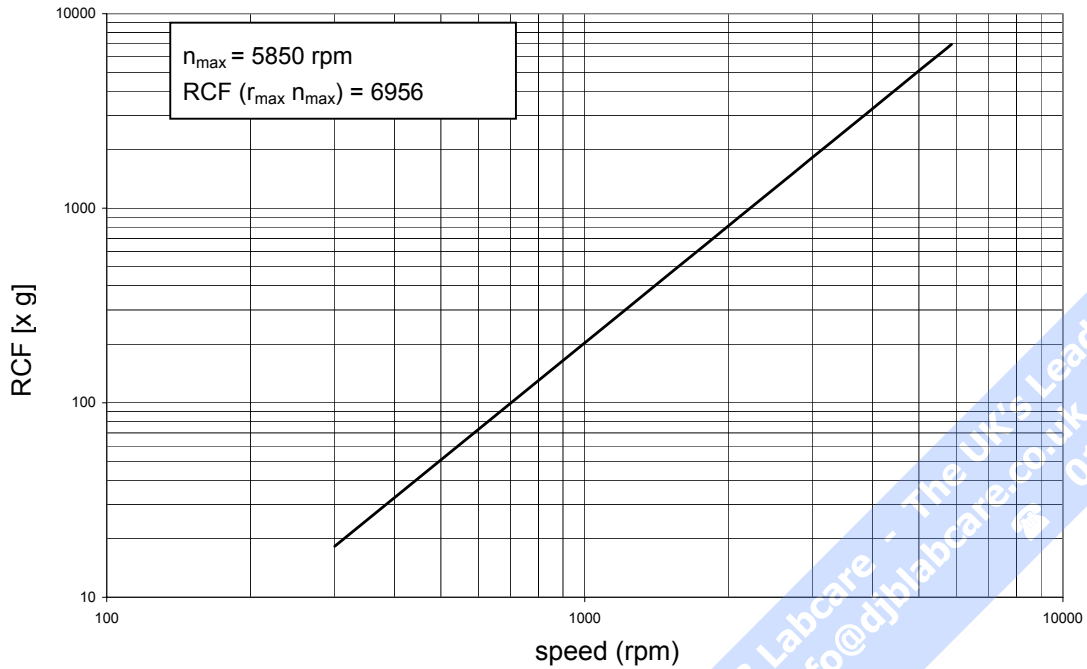

DJB Labcare - The UK's Leading Centrifuge Specialist
info@djblabcare.co.uk www.djblabcare.co.uk
01908 612598

Speed/RCF diagram

Highplate[®] Rotor 7500 6444

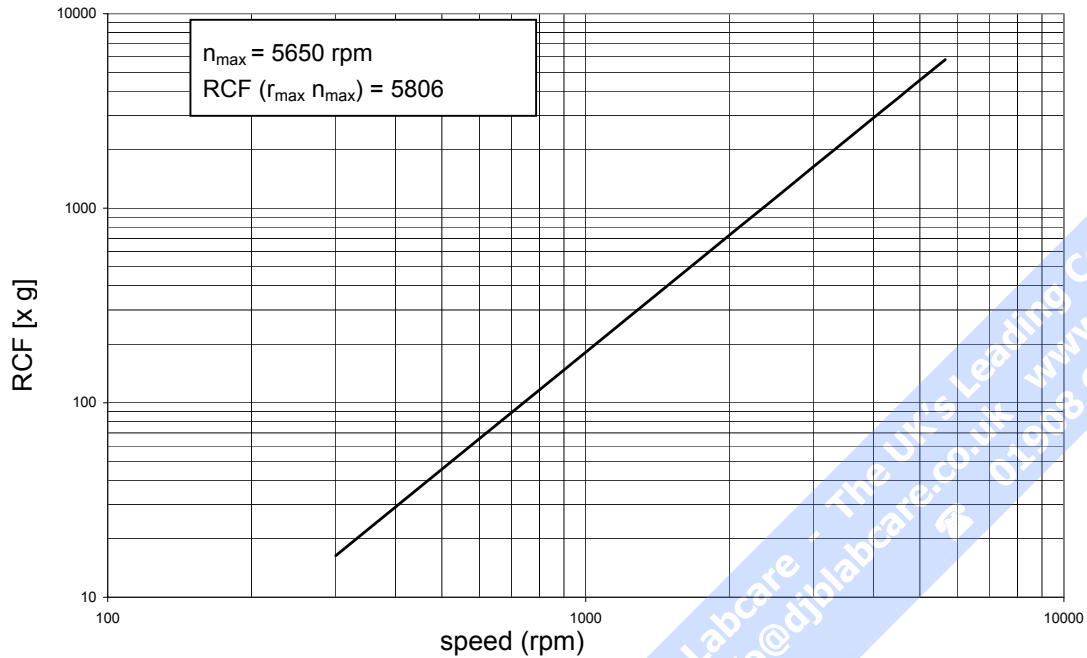

DJB Labcare - The UK's Leading Centrifuge Specialist
info@djblabcare.co.uk www.djblabcare.co.uk
01903 612598

Speed/RCF diagram

Micro liter Rotor 7500 3332

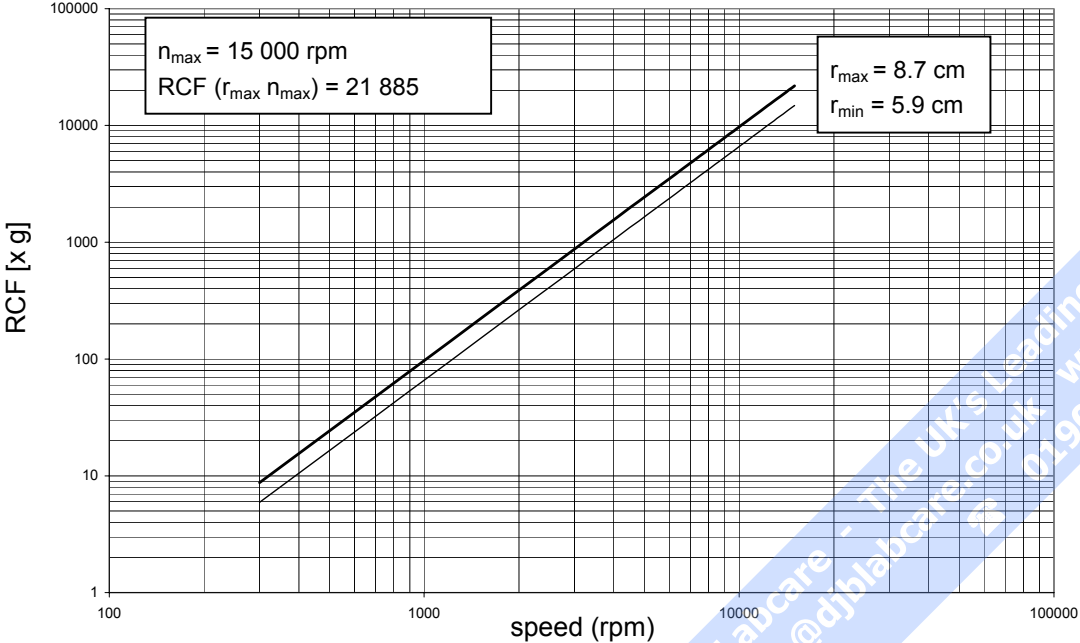

DJB Labcare - The UK's Leading Centrifuge Specialist
info@djblabcare.co.uk www.djblabcare.co.uk 012908 612598

Speed/RCF diagram

Angle Rotor 7500 3334

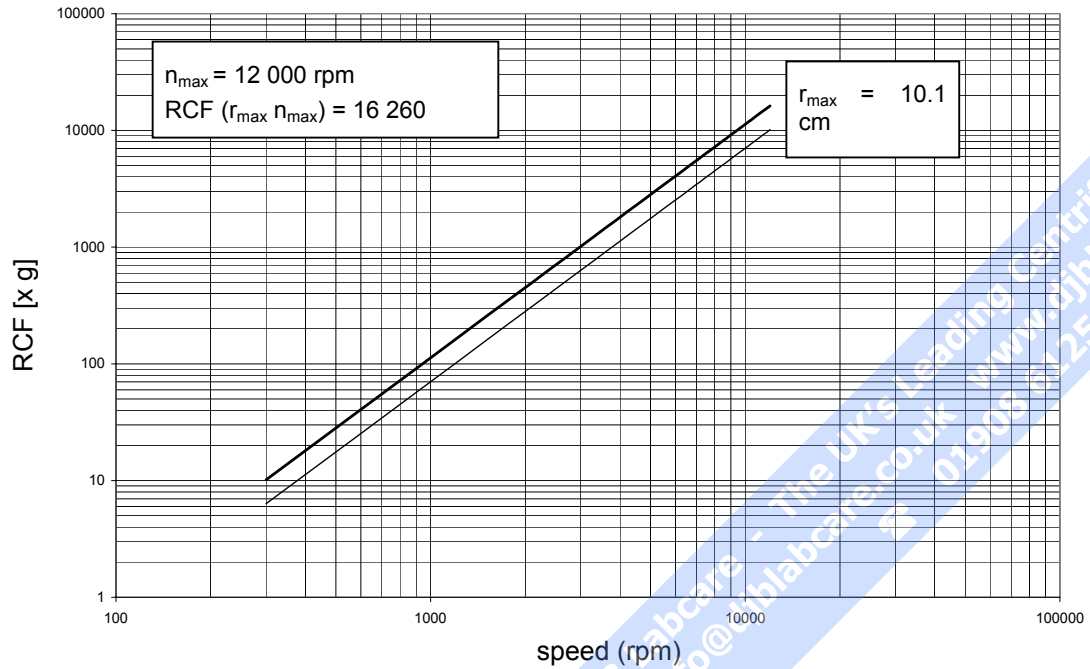

DJB Labcare - The UK's Leading Centrifuge Specialist
info@djblabcare.co.uk www.djblabcare.co.uk 01900 612598

Speed/RCF diagram

Highconic[®] Rotor 7500 3046

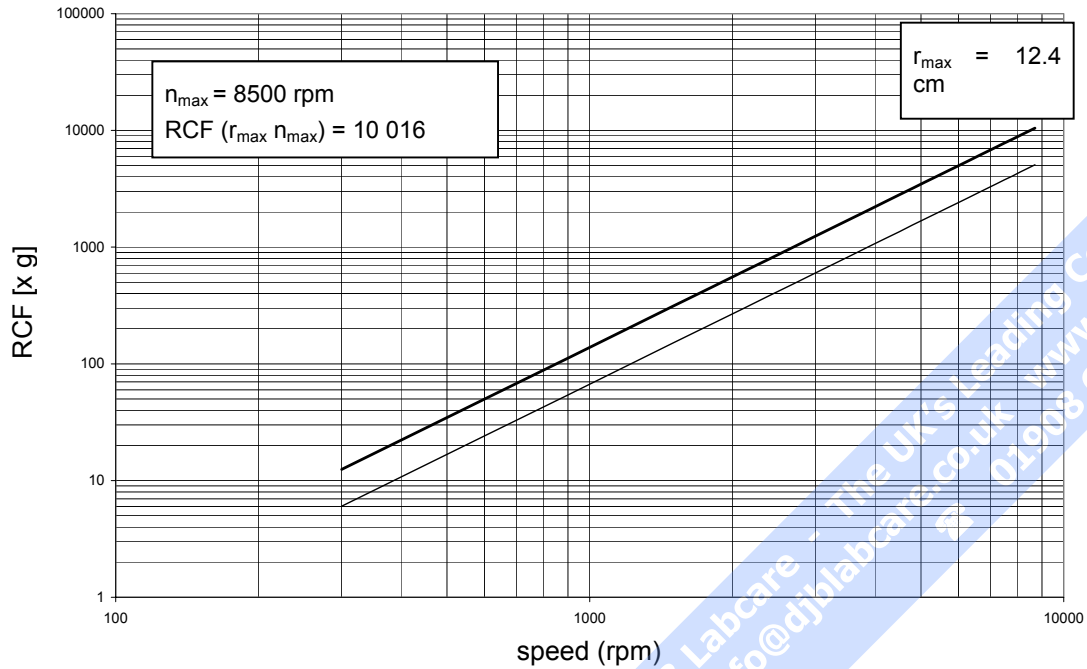

DJB Labcare - The UK's Leading Centrifuge Specialist
info@djblabcare.co.uk www.djblabcare.co.uk
01908 612598

Index

A

acceleration and deceleration curves · 77
acceleration profiles · 7
Acceleration/deceleration profile · 10
Accessories · 13
actual values · 46
adapter · 22
aerosol-tight operation · 40
agents
 for cleaning · 55
aluminum rotor: · 57
aluminum rotors
 anticorrosive grease · 58
angle rotor · 44
anticorrosive grease
 for aluminum rotors · 57
approved rotors · 30
audible signal
 can be switched on or off · 54
 switching on/off · 54
autoclaving · 58
autoclaving cycle · 58

B

bAL · 50
Basic unit/ function · 9

C

centrifuge exceptionally noisy · 64
Centrifuge transport and installation · 27
Centrifuging with a program · 52
changing settings
 during run · 50
cleaning · 55
closing the lid · 29
collet chuck · 30
common glass or plastic centrifuge tubes · 4
conditions of warranty · 59
Conformity · 5
contamination
 necessary measures · 56
continuous operation · 48
control panel
 readings · 7
corrosion · 4

corrosive substances
 protective tubes for corrosive substances · 4
cycle counter · 72

D

dangerous chemicals · 3
deceleration curves · 45
deceleration profiles · 7
decontamination · 56
Decontamination · 58
Description · 7
Description / feature · 9
Diagnostic messages · 11
disinfectants
 approved · 57
disinfection · 4
 procedure · 57
Disinfection · 56
displays
 brief failure · 63

E

EASYset™
 user interface · 10
EASYset™ control panel · 7

94

EC Guidelines · 5
emergency lid release · 61
entering parameters · 45
entering/changing a program · 52
error codes
 „Lid“ · 66
 „OPEN“ with lid closed · 66
 „rotor“ · 65
error codes
 „bAl“ · 65
 E-01 ... E-40 · 66

F

filling the centrifuge tubes · 37
fluorescein
 test solution for aerosol tightness · 43

G

general view · 7
goes forward · 50

H

Handling the centrifuge · 4

DJB Labcare - The UK's Leading Centrifuge Specialist
info@djblabcare.co.uk www.djblabcare.co.uk 01908 612598

hazardous substances · 3
hazards
 symbols · 5
hints
 symbol · 5
hLd · 47, 48

I

icons
 for denoting dangers and potential damage · 5
imbalance · 37, 38
imbalance · 50
imbalance detection · 8
indoor use · 27
infectious material
 precautions in case of tube breakage · 56, 59
Inserting the centrifuge tubes · 38
Installing the rotor · 30

L

lid
 blockage · 64
Lid lock with safety check · 8
lid opening · 29
lid release

 emergency · 61
lid unlocking mechanism
 manual · 61
limited life time · 37
location · 27

M

Maintenance and care · 55
manual lid unlocking · 61
manual stopping · 51
max. tube dimensions · 19, 22
Maximum loading · 36
maximum permissible RCF · 50
maximum permissible speed · 50
Maximum RCF value · 14
maximum sample density · 3
maximum volumes
 for aerosol-tighten operation · 42
microplates · 31, 35
minimum distance
 from wall · 27

O

opening the lid · 29
operation

short-time · 53
organic solvents
not allowed for cleaning · 56

P

parameters · 45
Parts supplied · 8
pathogenic microorganisms
protection against · 4
Plastic sample tubes
Pretemp function · 49
pretemperature-regulations · 49
problems
handling · 63
program display
symbols · 52
Program memory keys · 10
program storing · 52
protective tubes
for corrosive substances · 4

Q

quick run function · 53
Quick run mode · 11

R

radius of centrifugation
for calculation of RCF value · 47
RCF
maximum · 50
RCF display
and rotor identification · 46
RCF selection · 10
RCF setpoint · 46
RCF value · 7, 47
relative centrifugal force · 47
RCF-/speed display · 45
RCF-value · 18, 19, 20, 21
RCF-value · 15, 16, 17
readings
of control panel during run · 7
relative centrifugal force · 47
remain dark · 63
rotor cover · 30
rotor identification · 8
rotor identification · 46
and RCF display · 46
Rotor program for the Legend · 14, 18
rotors
approved · 30
run profile · 7
run time
range · 47

selection · 47
Run time selection · 47

S

safety instructions · 3
Safety instructions
marks · 5
safety measures · 3
safety standards · 5
safety zone · 3, 27
sample density
maximum · 3
sample tubes are approved · 37
selecting
run time · 47
selecting the temperature · 49
Service · 59, 72
service contracts · 59
setpoint values · 46
setting
speed · 46
settings
change during run · 50
Short time centrifugation · 53
short-time operation · 53
signal · 54
sodium fluorescein
test solution for aerosol tightness · 43

software check
internal · 29
software version
determination · 72
speed
maximum · 50
speed of centrifugation
for calculation of RCF value · 47
Speed selection, · 10
speed setting · 46
starting the centrifuge · 50
stopping
manually · 51
with continuous operation · 51
Stopping
with preset run time · 51
substructure · 27
Switching from speed to RCF display · 45
symbols
for hazards and dangers · 5

T

Technical Data · 73
The maximum permissible filling volumes for aerosol-tighten operation · 42
time
counted forward in quick run mode · 53
tools for installing the rotor · 30

toxins

 protection against · 4

troubleshooting · 61

t-set

 time mode · 48

tube

 breakage with infectious material · 56, 59

Tube type / permissible filling volume · 44

Turning the centrifuge off · 54

W

warning signal · 54

warranty conditions · 59

wear · 4

DJB Labcare - The UK's Leading Centrifuge Specialist
info@djblabcare.co.uk www.djblabcare.co.uk
01908 612598

AUSTRALIA

Kendro Laboratory Products Pty.
Ltd.
Building 4, 2-6 Orion Road
Lane Cove, Sydney, NSW 2066
Tel.: 61 (2) 9936 1540
Fax: 61 (2) 9427 9765
e-mail: info@kendro.com.au

INDIA

Kendro Laboratory Products India Pvt.
Ltd.
B-5/75 (LGF) Safdarjung Enclave
New Delhi, 110029, India
Tel.: 91 (11) 618 48 40
Fax: 91 (11) 618 53 97
e-mail: kendro.india@vsnl.com

JAPAN

Kendro Japan K.K.
Muroichi Building, 4/F,
1-13-4 Muromachi, Nihonbashi,
Chuo-ku, Tokyo, Japan 103-0022
Tel.: 81-3-3517-1661
Fax: 81-3-3517-1664
e-mail: yamakaway@kendro.co.jp

CHINA BEIJING:

Kendro Laboratory Products
Beijing Representative Office
8th Floor, Office Building
Hong Kong Macau Center
No. 2 Chao Yang Men Bei Da Jie
Beijing 100027, P.R. China
Tel.: 86 (10) 6501-1573
86 (10) 6501-3810
Fax: 86 (10) 6501-4229
e-mail: kendrobj@163bj.com

CHINA SHANGHAI:

Kendro Laboratory Products
Shanghai Representative Office
Room 22G, Hui Jia Building
No. 41 Cao Xi Bei Lu
Shanghai 200030, P.R. China
Tel.: 86 (21) 5490-0216
86 (21) 5490-0218
Fax: 86 (21) 5490-0230
e-mail: kendrosh@public4.sta.net.cn

CHINA HONG KONG**or other ASIA PACIFIC:**

Kendro Laboratory Products (H.K.) Limited
Suite 1105, 11/F, Chinachem Golden Plaza
77 Mody Road, Tsimshatsui East
Kowloon, Hong Kong
Tel.: 852-2711-3910
852-2142-3910
Fax: 852-2711-3848
e-mail: info@kendro.com

UNITED STATES of AMERICA

Kendro Laboratory Products
31 Pecks Lane
Newtown, CT 06470-2337
Tel.: (800) 522-7746 toll-free
Fax: (203) 270-2166
(203) 270-2115
(203) 270-2110
e-mail: info@kendro.com

**CANADA or other countries,
including LATIN AMERICA**

Kendro Laboratory Products
31 Pecks Lane
Newtown, CT 06470-2337
U.S.A.
Tel.: (203) 270-2080
Fax: (203) 270-2210
(203) 270-2166
e-mail: info@kendro.com

Or contact a local representative for **SORVALL**® brand products. Visit our web site at <http://www.kendro.com> or <http://www.kendro.de>

SORVALL®

The logo for Kendro Laboratory Products, featuring a stylized 'K' composed of three circles of varying sizes to the left of the text 'Kendro Laboratory Products'.