

ISBN 978-0-626-25188-8

SANS 10400-T:2011

Edition 3

SOUTH AFRICAN NATIONAL STANDARD

The application of the National Building Regulations

Part T: Fire protection

Table of changes

Change No.	Date	Scope

Foreword

This South African standard was approved by National Committee SABS SC 21E, *Fire safety – Fire threat to the community and environment*, in accordance with procedures of the SABS Standards Division, in compliance with annex 3 of the WTO/TBT agreement.

This document was published in March 2011.

This document supersedes the corresponding parts of SABS 0400:1990 (first revision).

Compliance with the requirements of this document will be deemed to be compliance with the requirements of part T of the National Building Regulations, issued in terms of the National Building Regulations and Building Standards Act, 1977 (Act No. 103 of 1977).

SANS 10400 consists of the following parts, under the general title *The application of the National Building Regulations*:

Part A: General principles and requirements.

Part B: Structural design.

Part C: Dimensions.

Part D: Public safety.

Part F: Site operations.

Part G: Excavations.

Part H: Foundations.

Part J: Floors.

Part K: Walls.

Part L: Roofs.

Part M: Stairways.

Part N: Glazing.

Part O: Lighting and ventilation.

Part P: Drainage.

Part Q: Non-water-borne means of sanitary disposal.

Part R: Stormwater disposal.

SANS 10400-T:2011
Edition 3

Foreword (*concluded*)

Part S: Facilities for persons with disabilities.

Part T: Fire protection.

Part V: Space heating.

Part W: Fire installation.

This document should be read in conjunction with SANS 10400-A.

Annexes A and B form an integral part of this document. Annexes C and D are for information only.

SANS 10400-T:2011

Edition 3

This page is intentionally left blank

Contents

	Page
Foreword	
1 Scope	5
2 Normative references	5
3 Definitions	8
4 Requirements	17
4.1 General	17
4.2 Safety distances	18
4.3 Different occupancies in a building	23
4.4 Division area	23
4.5 Fire performance	23
4.6 Fire resistance of occupancy-separating and division-separating elements	24
4.7 Fire stability of structural elements or components	25
4.8 Tenancy-separating elements	25
4.9 Partition walls and partitions	26
4.10 Protection of openings	29
4.11 Raised access and suspended floors of combustible material	30
4.12 Roof assemblies and coverings	31
4.13 Ceilings	33
4.14 Floor coverings	34
4.15 Internal finishes	36
4.16 Provision of escape routes	37
4.17 Exit doors	39
4.18 Feeder routes	39
4.19 Emergency routes	39
4.20 Dimensions of components of escape routes	40
4.21 Width of escape routes	41
4.22 Basements	42
4.23 Stairways and other changes of level along escape routes	42
4.24 Ventilation of stairways in an emergency route	43
4.25 Pressurization of emergency routes and components	43
4.26 Openings in floors	43
4.27 External stairways and passages	43
4.28 Lobbies, foyers and vestibules	44
4.29 Marking and signposting	44
4.30 Provision of emergency lighting	45
4.31 Fire detection and alarm systems	45
4.32 Provision and maintenance of fire-fighting equipment, installations and fire protection systems	46
4.33 Water reticulation for fire-fighting purposes	46
4.34 Hose reels	46
4.35 Hydrants	47
4.36 Automatic sprinkler and other fixed extinguishing systems	47

SANS 10400-T:2011

Edition 3

Contents *(concluded)*

	Page
4.37 Portable fire extinguishers.....	47
4.38 Mobile fire extinguishers	48
4.39 Fire-stopping of inaccessible concealed spaces.....	50
4.40 Protection in service shafts	50
4.41 Services in structural or separating elements	51
4.42 Smoke control	51
4.43 Air-conditioning and artificial ventilation systems.....	52
4.44 Lift shafts	53
4.45 Lifts.....	53
4.46 Firemen's lift.....	53
4.47 Stretcher lift	54
4.48 Stage and backstage areas	54
4.49 Seating arrangements in auditoriums or halls and on grandstands.....	56
4.50 Parking garages	58
4.51 Operating theatres and intensive, high or critical care units	58
4.52 Installation of liquid fuel dispensing pumps and tanks	58
4.53 Installation of other tanks	59
4.54 Access for fire-fighting and rescue purposes	60
4.55 Presumed fire resistance of building materials and components.....	60
4.56 Building materials	66
4.57 Single-storey category 1 buildings for H3 and H4 occupancies	67
4.58 Guest houses and bed and breakfast accommodation.....	68
4.59 Health care facilities	69
Annex A (normative) National Building Regulations – Part T: Fire Protection	70
Annex B (normative) Rational designs	71
Annex C (informative) Appointment of competent persons.....	76
Annex D (informative) Application of some of the requirements of this part of SANS 10400	78
Bibliography	86

The application of the National Building Regulations

Part T: Fire protection

1 Scope

This part of SANS 10400 provides deemed-to-satisfy requirements for compliance with part T (Fire Protection) of the National Building Regulations.

NOTE Part T of the National Building Regulations, issued in terms of the National Building Regulations and Building Standards Act, 1977 (Act No. 103 of 1977), is reproduced in Annex A.

2 Normative references

The following referenced documents are indispensable for the application of this document. For dated references, only the edition cited applies. For undated references, the latest edition of the referenced document (including any amendments) applies. Information on currently valid national and international standards can be obtained from the SABS Standards Division.

BS 7974, *Application of fire safety engineering principles to the design of buildings – Code of practice.*

EN 1125, *Building hardware – Panic exit devices operated by a horizontal bar, for use on escape routes – Requirements and test methods.*

EN 12101 (all parts), *Smoke and heat control systems.*

EN 14064 (all parts), *Thermal insulation products for buildings – In-situ formed loose-fill mineral wool (MW) products.*

PD 7974 (all parts), *Application of fire safety engineering principles to the design of buildings.*

SANS 193, *Fire dampers.*

SANS 306-4, *Fire extinguishing installations and equipment on premises – Part 4: Specification for carbon dioxide systems.*

SANS 428, *Fire performance classification of thermal insulated building envelope systems.*

SANS 543, *Fire hose reels (with semi-rigid hose).*

SANS 1128-1, *Firefighting equipment – Part 1: Components of underground and above-ground hydrant systems.*

SANS 10400-T:2011

Edition 3

SANS 1128-2, *Firefighting equipment – Part 2: Hose couplings, connectors, and branch pipe and nozzle connections.*

SANS 1151, *Portable rechargeable fire extinguishers – Halogenated hydrocarbon type extinguishers.*

SANS 1186-1, *Symbolic safety signs – Part 1: Standard signs and general requirements.*

SANS 1186-3, *Symbolic safety signs – Part 3: Internally illuminated signs.*

SANS 1186-5, *Symbolic safety signs – Part 5: Photoluminescent signs.*

SANS 1253, *Fire-doors and fire-shutters.*

SANS 1464-22, *Safety of luminaires – Part 22: Luminaires for emergency lighting.*

SANS 1475-1, *The production of reconditioned fire-fighting equipment – Part 1: Portable and wheeled (mobile) rechargeable fire extinguishers.*

SANS 1475-2, *The production of reconditioned fire-fighting equipment – Part 2: Fire hose reels and above-ground hydrants.*

SANS 1910, *Portable refillable fire extinguishers.*

SANS 2001-EM1, *Construction works – Part EM1: Cement plaster.*

SANS 10082, *Timber frame buildings.*

SANS 10087-2 (SABS 087-2), *The handling, storage, and distribution of liquefied petroleum gas in domestic, commercial, and industrial installations – Part 2: Installations in mobile units and small non-permanent buildings.*

SANS 10087-3, *The handling, storage, distribution and maintenance of liquefied petroleum gas in domestic, commercial, and industrial installations – Part 3: Liquefied petroleum gas installations involving storage vessels of individual water capacity exceeding 500 L.*

SANS 10087-7, *The handling, storage, distribution and maintenance of liquefied petroleum gas in domestic, commercial and industrial installations – Part 7: Storage and filling premises for refillable liquefied petroleum gas (LPG) containers of gas capacity not exceeding 9 kg and the storage of individual gas containers not exceeding 48 kg.*

SANS 10087-10, *The handling, storage, distribution and maintenance of liquefied petroleum gas in domestic, commercial and industrial installations – Part 10: Mobile filling stations for refillable liquefied petroleum gas (LPG) containers of capacity not exceeding 9 kg.*

SANS 10089-3, *The petroleum industry – Part 3: The installation, modification, and decommissioning of underground storage tanks, pumps/dispensers and pipework at service stations and consumer installations.*

SANS 10100-1 (SABS 0100-1), *The structural use of concrete – Part 1: Design.*

SANS 10105-1, *The use and control of fire-fighting equipment – Part 1: Portable and wheeled (mobile) fire extinguishers.*

SANS 10114-2, *Interior lighting – Part 2: Emergency lighting.*

SANS 10131, *Above-ground storage tanks for petroleum products.*

SANS 10400-T:2011
Edition 3

SANS 10139, *Fire detection and alarm systems for buildings – System design, installation and servicing.*

SANS 10145 (SABS 0145), *Concrete masonry construction.*

SANS 10177-2, *Fire testing of materials, components and elements used in buildings – Part 2: Fire resistance test for building elements.*

SANS 10177-3, *Fire testing of materials, components and elements used in buildings – Part 3: Surface fire index of finishing materials.*

SANS 10177-4, *Fire testing of materials, components and elements used in buildings – Part 4: Surface fire index of floor coverings.*

SANS 10177-5, *Fire testing of materials, components and elements used in buildings – Part 5: Non-combustibility at 750 °C of building materials.*

SANS 10177-10, *Fire testing of materials, components and elements used in buildings – Part 10: Surface burning characteristics of building materials using the inverted channel tunnel test.*

SANS 10177-11, *Fire testing of materials, components and elements used in buildings – Part 11: Large-scale fire performance evaluation of building envelope thermal insulation systems (with or without sprinklers).*

SANS 10263-0, *The warehousing of dangerous goods – Part 0: General requirements.*

SANS 10287 (SABS 0287), *Automatic sprinkler installations for fire-fighting purposes.*

SANS 10313, *Protection against lightning – Physical damage to structures and life hazard.*

SANS 10400-A:2010, *The application of the National Building Regulations – Part A: General principles and requirements.*

SANS 10400-D, *The application of the National Building Regulations – Part D: Public safety.*

SANS 10400-M (SABS 0400-M), *The application of the National Building Regulations – Part M: Stairways.*

SANS 10400-N, *The application of the National Building Regulations – Part N: Glazing.*

SANS 10400-O, *The application of the National Building Regulations – Part O: Lighting and ventilation.*

SANS 10400-S (SABS 0400-S), *The application of the National Building Regulations – Part S: Facilities for persons with disabilities.*

SANS 10400-W, *The application of the National Building Regulations – Part W: Fire installation.*

SANS 11601, *Wheeled fire extinguishers – Performance and construction.*

SANS 14520-1/ISO 14520-1, *Gaseous fire-extinguishing systems – Physical properties and system design – Part 1: General requirements.*

SANS 50054-7/EN 54-7, *Fire detection and fire alarm systems – Part 7: Smoke detectors – Point detectors using scattered light, transmitted light or ionization.*

SANS 50197-1/EN 197-1, *Cement – Part 1: Composition, specifications and conformity criteria for common cements.*

SANS 10400-T:2011

Edition 3

SANS 62305-3/IEC 62305-3, *Protection against lightning – Part 3: Physical damage to structures and life hazard.*

3 Definitions

For the purposes of this document, the definitions given in SANS 10400-A (some of which are repeated for convenience) and the following apply.

3.1

acceptable

acceptable

- a) in the opinion of any local authority, or
- b) in relation to any document issued by the council, in the opinion of the council

3.2

access door

entrance door to an emergency route

3.3

accredited certification body

certification body that has been accredited by a government-endorsed accreditation body

3.4

adequate

adequate

- a) in the opinion of any local authority, or
- b) in relation to any document issued by the council, in the opinion of the council

3.5

Agrément certificate

certificate that confirms fitness-for-purpose of a non-standardized product, material or component or the acceptability of the related non-standardized design and the conditions pertaining thereto (or both) issued by the Board of Agrément South Africa

3.6

air-conditioning system

system of mechanical ventilation where air that has been filtered is supplied to a building under conditions of controlled temperature, humidity, distribution and movement

3.7

air duct

pipe, tube, conduit or enclosed space used or to be used in any building for the transmission of air in an artificial ventilation system or air-conditioning system

3.8

approved

approved

- a) by any local authority, or
- b) by the Review Board on appeal to the Review Board in terms of the Act

3.9

artificial ventilation system

system in which air is caused to circulate through a room by means of a mechanical apparatus which forces air into or extracts air from such room

3.10

automatic

fitted with a suitable device which is activated by a predetermined amount of heat, smoke, combustion gases or flame, without the need for any manual operation

3.11

basement storey

basement

any part of a building which is below the level of the ground storey

3.12

block

masonry unit which has a length of more than 300 mm or a width of more than 130 mm

3.13

Board of Agrément South Africa

body that operates under the delegation of authority of the Minister of Public Works

3.14

building height

dimensional height in metres, measured from the lowest ground level abutting any part of the building to the level of

- a) the underside of a flat roof, or
- b) the underside of the roof of any plant room on such flat roof where the plan area of the plant room is more than 10 % of the area of such flat roof, or
- c) a horizontal ceiling which is immediately under any pitched roof, or
- d) halfway between the eaves level and the ridge of any pitched roof where there is no ceiling below such roof or where the ceiling follows the pitch of such roof

3.15

carport

building associated with an H4 occupancy intended to provide shelter for a motor vehicle, caravan or boat, and with a roof but with walls on not more than two sides

3.16

category 1 building

building which

- a) is designated as being of class A3, A4, F2, G1, H2, H3, or H4 occupancy (see Regulation **A20** in SANS 10400-A),
- b) has no basements,
- c) has a maximum length of 6,0 m between intersecting walls or members providing lateral support, and
- d) has a floor area that does not exceed 80 m²

NOTE 1 Table C.1 in SANS 10400-A:2010 outlines the difference in performance between category 1 buildings and other buildings that have the same occupancy designation in respect of a number of building attributes.

SANS 10400-T:2011

Edition 3

NOTE 2 A building may be classified as a category 1 building for the purposes of one or more parts of SANS 10400. Additional limitations may accordingly be imposed on category 1 buildings. For example, a category 1 building in terms of this part of SANS 10400 will be restricted to a single storey.

NOTE 3 Fire requirements for category 1 buildings are based on occupants escaping quickly from buildings. The design population for occupancies as set out in table 2 of part A of the Regulations (see SANS 10400-A) should therefore not be exceeded.

3.17

ceiling

upper interior surface of a room or similar compartment, including all materials comprising such surface

3.18

class 1 aggregate

coarse aggregate of foamed slag, blast-furnace slag, pumice, burnt clinker, crushed limestone, crushed dolomite, crushed masonry unit or crushed burnt clay product

3.19

class 2 aggregate

coarse aggregate of gravel or crushed natural stone other than limestone or dolomite

3.20

combustible

not classified as non-combustible when tested in accordance with SANS 10177-5

3.21

common path of travel

part of an escape route that leads to only one exit door, access door or escape door

3.22

communication pipe

pipe in a water supply system downstream of the municipal supply valve and meter (where applicable) to which any water installation is connected

3.23

competent person

person who is qualified by virtue of his education, training, experience and contextual knowledge to make a determination regarding the performance of a building or part thereof in relation to a functional regulation or to undertake such duties as may be assigned to him in terms of the National Building Regulations

NOTE This is a generic definition, to be used where no other definition is given, or no references are made to other standards. Other parts of SANS 10400 contain definitions of a more specific nature relevant to their disciplines.

3.24

competent person (fire engineering)

person who

- a) is registered in terms of the Engineering Profession Act, 2000 (Act No. 46 of 2000), as either a Professional Engineer or a Professional Engineering Technologist, and
- b) is generally recognized as having the necessary experience and training to undertake rational assessments or rational designs in the field of fire engineering

3.25

dead end

area from which escape is possible in one direction only

3.26

dead-end corridor

corridor that leads to safe escape in one direction only

3.27

deemed-to-satisfy requirement

non-mandatory requirement, the compliance with which ensures compliance with a functional regulation

3.28

detached

built separately as opposed to being attached horizontally with a common wall

3.29

division

portion of a building separated from the remainder of such building by one or more separating elements

3.30

division wall

internal wall that separates one division from another division in any building and that has a fire resistance of not less than that specified in this part of SANS 10400 (see 4.6)

3.31

drencher system

system of piping and outlets which, when activated manually or automatically by the action of fire, releases a continuous curtain of water

3.32

dwelling house

single dwelling unit and any garage and other domestic outbuildings thereto, situated on its own site

3.33

dwelling unit

unit containing one or more habitable rooms and provided with adequate sanitary and cooking facilities

3.34

emergency route

that part of an escape route which provides fire protection to the occupants of any building and which leads to an escape door

3.35

escape door

door in an escape route which, at ground level, leads directly to a street or public place or to any approved open space which leads to a street or public place

3.36

escape route

entire path of travel for all persons, including persons with disabilities, from the furthest point in any room in a building to the nearest escape door and may include an emergency route

3.37

exit door

door that is a component of an escape route from any room

SANS 10400-T:2011

Edition 3

3.38

feeder route

that part of an escape route which allows travel in two different directions from the access doors to at least two emergency routes

3.39

fire damper

automatic damper complete with components and assembly

3.40

fire door

fire shutter

automatic or self-closing door or shutter assembly especially constructed to prevent the passage of fire for a specific length of time

3.41

fire load

sum of the heat energy values of all combustible materials, including combustible partitions and other combustible elements, contained in a compartment or division

3.42

fire resistance

shortest period for which a building element or building component complies with the requirements for stability, integrity and insulation when tested in accordance with SANS 10177-2

3.43

fire stop

draught-tight, non-combustible barrier or seal placed within or between building elements in shafts, voids and other concealed spaces to retard the spread of flame, heat or smoke

3.44

flammable

having a closed cup flash point lower than 90 °C

NOTE For more information on flammable liquids, see SANS 10228.

3.45

flight

that part of a stairway which consists of consecutive steps between landings

3.46

floor area

total area of a building, or a storey thereof, enclosed within its external walls, exclusive of the area occupied by any lift shaft

3.47

free-standing wall

wall (that is not a retaining wall) without lateral support

3.48

functional regulation

regulation that sets out in qualitative terms what is required of a building or building element or building component in respect of a particular characteristic, without specifying the method of construction, dimensions or materials to be used

3.49

garage

enclosed area which is used or intended to be used for the parking, storing, servicing or repairing of motor vehicles

3.50

going

distance (measured on plan) between the nosing of a tread and the nosing of the tread or landing immediately above it

3.51

habitable room

room used or designed, erected, adapted or intended to be used by persons for sleeping in, living in, the preparation or consumption of food or drink, the transaction of business, the rendering of professional services, the manufacture, processing or sale of goods, the performance of work, the gathering together of persons, or for recreational purposes

3.52

landing

platform between two consecutive flights of a stairway

3.53

lapa

thatched roof building which is used for recreational purposes and has either no walls or non-combustible walls

3.54

lateral boundary

boundary of a site other than a boundary between such site and any street or public place where such a street or public place is wider than 6 m measured at right angles to the boundary

3.55

lining

internal surface finishing material, which may be partially or completely fixed or adhered to a substrate such as a wall, ceiling, roof or roof covering

3.56

load

value of a force corresponding to an action

3.57

maintained

condition of operational readiness at all times in accordance with the original design and installation and associated maintenance procedures

3.58

natural ventilation

movement of air through a building due to natural causes and that will disperse and dispel smoke

3.59

non-combustible

classified as non-combustible when tested in accordance with SANS 10177-5

3.60

non-structural wall

wall which does not form part of the structural system of a building

3.61

occupancy

particular use or the type of use to which a building or portion thereof is normally put or intended to be put

NOTE Regulation **A20** (see SANS 10400-A) classifies and designates occupancies.

SANS 10400-T:2011

Edition 3

3.62

partition

interior construction less than one storey in height, and which is generally of a light construction and demountable

3.63

partition wall

non-structural internal wall that extends to the ceiling and is constructed for the purpose of subdividing a space

3.64

person with disabilities

person who has long-term physical, mental, intellectual or sensory impairments which, in interaction with various barriers, might hinder his full and effective participation in society on an equal basis with others

3.65

population

population determined in accordance with Regulation **A21**

3.66

pressurization

creation of a positive air pressure differential between one area of a building and the remainder of a building

NOTE Pressurized has a corresponding meaning.

3.67

public place

square, park, recreation ground or open space which

- a) is vested in the local authority, or
- b) the public has the right to use, or
- c) is shown on a general plan of a township filed in a deeds registry or a Surveyor-General's office and has been provided or reserved for the use of the public or the owners of erven in such township

3.68

rational assessment

assessment by a competent person of the adequacy of the performance of a solution in relation to requirements including as necessary, a process of reasoning, calculation and consideration of accepted analytical principles, based on a combination of deductions from available information, research and data, appropriate testing and service experience

3.69

rational design

design by a competent person involving a process of reasoning and calculation and which may include a design based on the use of a standard or other suitable document

3.70

refuge

area that is separated from a fire by a fire-resistant construction, that is provided with a safe route to a storey exit, and that constitutes a temporarily safe place for persons to wait for assistance for their evacuation

3.71
riser

vertical distance between the tread of a step and the tread of the step immediately above it

3.72
roof assembly

building cover and its supporting structure, including any ceiling attached to such structure, and including any additional components such as insulation

3.73
safety distance

distance provided between any building and the lateral boundary of the site or, where there are two buildings on the same site, the distance provided between each such building and a notional boundary line between them, so that spread of fire from one building to another due to the effect of radiant heat will be minimized

3.74
safety glass

safety glazing material consisting primarily of glass

3.75
self-closing

equipped with a device to ensure immediate closing of a door, fire door, shutter or fire shutter after it has been opened

3.76
separating element

wall or floor, which has a specific fire resistance, used between divisions, occupancies or tenancies in a building

3.77
service pipe

pipe which is part of a water installation and which is connected to any communication pipe

3.78
site

erf, lot, plot, stand or other piece of land on which a building has been, is being or is to be erected

3.79
spiral stairway

succession of tapered treads forming a curved stairway which extends as a single flight from one floor or landing to another

3.80
sprinkler system

system of piping and sprinkler heads connected to a water supply which, when activated by the effect of fire, automatically releases water

3.81
stairway

part of a building which provides a route of travel between different levels in such building and is formed by a single flight or by a combination of two or more flights and one or more intervening landings

3.82
storey

that part of a building which is situated between the top of any floor and the top of the floor next above it or, if there is no floor above it, that portion between such floor and the ceiling above it (any

SANS 10400-T:2011

Edition 3

open work floor, catwalk or gallery being taken to be part of the storey in which it is situated); and in relation to a building

- a) the ground storey is taken as the storey in which there is situated an entrance to the building from the level of the adjoining ground or, if there is more than one such storey, the lower or lowest of these,
- b) a basement is taken to be any part of the building which is below the level of the ground storey,
- c) an upper storey is taken to be any storey of the building which is above the level of the ground storey, and
- d) the height expressed in storeys is taken to be that number of storeys which includes all storeys other than a basement

3.83

street

street, road, thoroughfare, lane, footpath, sidewalk, subway or bridge which

- a) is vested in the local authority, or
- b) the public has the right to use, or
- c) is shown on a general plan of a township filed in a deeds registry or a Surveyor-General's office and has been provided or reserved for use by the public or the owners of erven in such township

3.84

street boundary

boundary of a site which abuts any street

3.85

structural

relating to or forming part of any structural system

3.86

structural system

system of constructional elements and components of a building which is provided to resist the loads acting upon it and to transfer such loads to the ground upon which such building is founded

3.87

structural wall

wall forming part of any structural system

3.88

suitable

capable of fulfilling or having fulfilled the intended function, or fit for its intended purpose

3.89

surface fire index

classification awarded to a combustible surfacing material (in excess of 1 mm in thickness)

3.90

suspended ceiling

ceiling supported on a system of hangers

3.91

tenancy-separating element

separating element between tenants within the same occupancy classification group

3.92

thatch

reed, grass or straw used in roof construction

3.93

travel distance

distance in a building

- a) where emergency routes are required, from the furthest point on any storey in such building to an access door, or
- b) where no emergency routes are required, from the furthest point on any storey in such building to an escape door

3.94

tread

upper surface of a step

3.95

unprotected steel

structural steel which is not protected with fire-resistant material against the effect of fire

4 Requirements

4.1 General

4.1.1 The functional regulation **T1** contained in part T of the National Building Regulations (see annex A) shall be deemed to be satisfied where the fire protection

- a) in the case of
 - 1) buildings other than single-storey category 1 buildings, is in accordance with the requirements of 4.2 to 4.56, 4.58 and 4.59 provided that competent persons prepare rational designs for any automatic sprinkler system, fixed automatic fire-fighting system, pressurization of emergency routes, mechanical smoke or heat control system, and fire detection and alarm system that may be required,
 - 2) single-storey category 1 buildings, is in accordance with the requirements of 4.57; or
- b) is the subject of a rational design, prepared by a competent person (fire engineering) in accordance with the requirements of annex B.

NOTE 1 The provisions of 4.1.1(a) are intended to be of general application and are modelled with certain common types of buildings in mind. They are, for example, not intended for buildings of ten or more storeys, atriums, large shopping centres, airport terminals and petrochemical facilities. Where such buildings or anything unusual or obviously different is to be designed, it is important to rather satisfy the regulations by means of a rational design prepared by competent persons (fire engineering) in accordance with the provisions of 4.1.1(b).

NOTE 2 Regulation **T1(2)** empowers the local authority to require that a rational design be submitted should this be deemed necessary.

NOTE 3 Annex C provides information regarding the appointment of competent persons in terms of this part of SANS 10400.

4.1.2 Where a competent person (fire engineering) prepares a rational design or rational assessment, such person shall inspect the installation thereof at such intervals as might be

SANS 10400-T:2011

Edition 3

necessary in accordance with accepted professional practice in order to be satisfied that the design is being correctly interpreted and that the work is being executed generally in accordance with the requirements of the designs or assessments.

4.2 Safety distances

4.2.1 The external walls of any building, with the exception of any carport on the same site as any building classified as H4, shall be classified as one of the following types and shall comply with the requirements of 4.2.2 to 4.2.8:

- a) Type FR, which has a fire resistance equal to or more than that given in table 1 for the occupancy in question.
- b) Type F, which has a fire resistance of less than that given in table 1, is constructed with non-combustible external cladding and, when tested in accordance with SANS 10177-2, complies with the requirements for stability and integrity for a period of not less than that given in table 1 for the occupancy in question.
- c) Type N, which has a fire resistance of less than that given in table 1 for the occupancy in question and has
 - 1) combustible external cladding, or
 - 2) non-combustible external cladding but, when tested in accordance with SANS 10177-2, such wall has failed to comply with the requirements for either stability or integrity (or both) for a period given in table 1 for the occupancy in question.

A type N wall is a combustible wall with full fire resistance. Combustible cladding fixed to type FR or type F is regarded, for the purposes of this rule, as combustible and will have the same fire resistance as the wall it is fixed to unless tested in accordance with SANS 10177-2. For the determination of safety distances, the entire wall shall be regarded as combustible. (See annex D.)

4.2.2 Where any external wall of a building is of type FR and such wall does not contain any window or any other opening, there shall be no restriction upon the safety distance for such wall.

Table 1 — Fire resistance of external walls

1	2
Occupancy	Fire resistance min
All occupancies except those mentioned below	30
B1, C1, D1, E1, E2, E3, F1, F3, J2 and J3	60
J1	120

4.2.3 Where any external wall of a building is of type F and such wall does not contain any windows or other openings, the safety distance required shall be not less than the relevant values given in table 2, provided that

- a) for any occupancy classified as J1, J2 or J3, the safety distance required shall be not less than 3,7 m, 2,2 m and 1,5 m, respectively, and
- b) for any building classified as H4, where the area of elevation facing any boundary is not more than 7,5 m², such safety distance may be reduced to 0,5 m.

SANS 10400-T:2011
Edition 3

4.2.4 Where any external wall of any building is of type N, or where any building is provided with external walls containing windows or other openings, such building shall, subject to the requirements of 4.2.8, be so sited that a circle of radius equal to the safety distances given in table 2 for the window area and occupancy concerned, drawn from any point on any such window or other opening in such exterior wall, shall not intersect any lateral boundary of the site; provided that this requirement shall not apply in respect of

- a) any building contemplated in 4.57;
- b) any such wall which faces a public place, railway siding reserve or any open space secured by a servitude or servitudes on an adjoining site(s) approved by the local authority. Such servitude or combination of servitudes shall be not less than the requirements given in table 2;
- c) any such wall of a ground storey or basement, facing a lateral boundary on which is erected a free-standing wall which
 - 1) is constructed of non-combustible material,
 - 2) has a fire resistance of not less than that prescribed for such external wall,
 - 3) is equal in height to that of the ground storey or basement, as the case might be, and
 - 4) extends at each end beyond any window or opening concerned by a distance of not less than the difference between the minimum safety distance given in table 2 and the actual boundary distance.

4.2.5 Where there are two or more buildings on the same site, or where any building has two or more divisions and

- a) where any external wall of any such building or division does not contain any windows or other openings, the distance between such external wall and a notional boundary line between such buildings or divisions shall be not less than the relevant safety distance given in 4.2.2 or 4.2.3; and
- b) subject to the requirements of 4.2.8, where any external wall of such building or division is of type N or contains windows or other openings, any circle of radius equal to the safety distance given in table 2 for the occupancy concerned, drawn from any point on any window or opening in the external wall of one such building or division, shall not intersect any circle of radius equal to the safety distance given in table 2 for the occupancy concerned in the external wall of such other building or division, drawn from any point in any window or opening in the external wall of such other building or division; provided that the intersection of such circles shall be permitted where
 - 1) the included angle between such walls is more than 135°, or
 - 2) the included angle between such walls is more than 90° and the distance between the nearest points on such windows or openings is more than 2 m.

4.2.6 Notwithstanding the requirements given in 4.2.1, any structural external wall shall, when tested in accordance with SANS 10177-2, comply with the requirement for stability for a period not less than that required in 4.7.

4.2.7 Notwithstanding the requirements of 4.2.1 to 4.2.5, where any division or any building is equipped with a sprinkler system designed, installed and maintained by competent persons in accordance with SANS 10287, the minimum safety distances given in table 2 may be reduced to half the distances so given, provided that in no case shall such reduced distance be less than 1 m.

SANS 10400-T:2011

Edition 3

4.2.8 Where any building is not divided into divisions, the area of any window or opening or the sum of the areas of all windows or openings, in that portion of the elevation of the building between division floors and between division walls shall be calculated, provided that

- a) where portions of such elevation are at different distances from the boundary, another division of the same building or from another building, each such portion and the area of window or opening contained therein can be separately considered;
- b) no window or other opening or portion of such window or opening in any external wall of any building shall be taken into consideration in the calculation of the total area of windows or openings where the included angle between such wall and any boundary of the site, any external wall of any other division of the same building or any external wall of any other building on the same site is more than 30°, and such window, opening or portion thereof is situated more than 3 m from such boundary, other division or other building;
- c) where any building has external walls of type N, the total elevation area of such walls shall be construed as being a window or opening;
- d) where any garage on the same site as any building classified as H4 is situated close to any lateral boundary of the site and in such a way that the doorway is at an angle of approximately 90° to such boundary,
 - 1) any circle of radius equal to the safety distance required for an occupancy classified as H4 and drawn from a centre located in the plane of the garage door at a point nearest to such boundary, shall intersect a cut-off line drawn from the same point and at an angle of 45° to the plane of such door, at a position on or within such boundary, or
 - 2) the side wall of such garage may be extended and the centre of such circle located at a point in the plane of the door that will enable such circle and the related cut-off line to intersect on or within such boundary; provided that such wall extension shall be of a height not less than that of such door and of a length that will ensure that such cut-off line will simultaneously intersect the extension of such wall and such circle within the boundary.

NOTE Annex D provides commentary and guidance on the application of safety distances.

Table 2 — Safety distances

1	2	3	4
Area of openings in elevation m ²	Low fire load ≤ 25 kg/m ² (timber equivalent)	Moderate fire load > 25 kg/m ² ; < 50 kg/m ² (timber equivalent)	High fire load ≥ 50 kg/m ² (timber equivalent)
	Occupancy class		
	A1, A2, A3, A4, A5, B3, C2, D3, D4, E1, E2, E3, E4, G1, H1, H2, H3, H4, H5, J3, J4	B2, C1, D2, F1, F2, F3, J2	B1, D1, J1
	Minimum safety distances m		
Type F wall (no openings)	1,0	1,5	2,0
< 5	1,0	1,5	2,0
5	1,5	2,0	2,7
7,5	2,0	2,2	3,5
10	2,4	2,5	3,7
30	3,8	4,6	6,2
50	4,5	5,5	7,3
70	5,0	6,0	8,0
90	5,3	6,4	8,6
110	5,5	6,7	9,0
130	5,7	7,0	9,3
150	5,9	7,2	9,6
170	6,1	7,4	9,9
190	6,2	7,5	10,1
210	6,3	7,7	10,3
230	6,4	7,8	10,5
250	6,5	8,0	10,6
270	6,6	8,1	10,8
290	6,7	8,2	10,9
310	6,8	8,3	11,1
330	6,9	8,4	11,2

Table 2 (concluded)

1	2	3	4
Area of openings in elevation m ²	Low fire load ≤ 25 kg/m ² (timber equivalent)	Moderate fire load > 25 kg/m ² ; < 50 kg/m ² (timber equivalent)	High fire load ≥ 50 kg/m ² (timber equivalent)
	Occupancy class		
	A1, A2, A3, A4, A5, B3, C2, D3, D4, E1, E2, E3, E4, G1, H1, H2, H3, H4, H5, J3, J4	B2, C1, D2, F1, F2, F3, J2	B1, D1, J1
	Minimum safety distances m		
350	6,9	8,5	11,3
370	7,0	8,5	11,4
390	7,1	8,6	11,5
410	7,1	8,7	11,6
430	7,2	8,8	11,7
450	7,2	8,8	11,8
≥ 500	7,4	9,0	12,0

NOTE 1 Intermediate values may be interpolated. The values contained in this table are approximate to those calculated using the following formulae:

Low fire load: $D = 2,75 \times \text{Log } A - (1/A)^{1/2}$

Moderate fire load: $D = 3,25 \times \text{Log } (A - 3) - (1/A)^{1/2}$

High fire load: $D = 2,25 \times \text{Log } (A^2 - 5) - (5/A)^{1/2}$

where

D is the safety distance, in metres;

A is the total area, in square metres, of windows or other opening(s) on one elevation of the division.

NOTE 2 The unit of fire load can be expressed in calorific values (MJ/m²) or as a timber equivalent (kg/m²). The conversion factor from megajoules per square metre to kilograms per square metre is 0,056, and from kilograms per square metre to megajoules per square metre, is 18.

NOTE 3 The term 'fire load' refers to the amount of combustible material available in a particular occupancy and thus implies the degree of intensity of any fire when fully developed and also the duration of any fire which might occur in the occupancy in question. It has nothing to do with the ease of starting a fire or the degree of danger due to smoke or poisonous fumes which would be implied by the terms low, moderate or high fire hazard.

4.3 Different occupancies in a building

Any building shall be permitted to have an area of

- a) not more than 100 m² in total, of an occupancy classified as J1, or not more than 300 m² in total, of an occupancy classified as J2 or J3, within any other occupancy;
- b) not more than 100 m² of an occupancy not classified as J1, within an occupancy classified as J1.

4.4 Division area

Any building shall be divided into divisions with a floor area of not more than that given in columns 2, 3 or 4 of table 3, and such divisions of the respective floor areas shall be separated effectively from each other by division-separating elements, provided that

- a) where an occupancy classified as J1, used for the storage of flammable liquids, forms part of any building, such part shall be a separate division and the area of such division shall be not more than 100 m²; and
- b) where storage of goods is to a height which exceeds the requirements of ordinary hazards in SANS 10287, a fixed installation of automatic fire extinguishment designed, installed and maintained by competent persons in accordance with the requirements of SANS 10287 shall be provided.

Table 3 — Maximum division areas

1	2	3	4
Occupancy	Maximum division area m ²		
	No fixed automatic fire extinguishment installation	With fixed automatic fire extinguishment installation	
		One storey	Two storeys and over
E1 ^a , E2 ^a , E3 ^a	1 250	1 250	1 250
E4	250	1 250	1 250
A2, B2, B3, C1, C2, G1	5 000	No limit	10 000
A4, A5, D3, J3, J4	No limit	No limit	No limit
All other occupancies	2 500	No limit	5 000

^a The maximum division area on any storey, and all such divisions, shall be interconnected.

4.5 Fire performance

4.5.1 Where any element or component of a building is required to have a particular fire resistance, such requirement shall, in respect of the materials or method of construction of such element or component, be deemed to have been complied with where

- a) a representative specimen of such element or component has been shown to have the required fire resistance when tested in accordance with SANS 10177-2, or
- b) the element or component complies with the requirements of 4.55.

4.5.2 Where non-combustibility of any element or component is required, such requirements shall be complied with where such element or component is proved to be made only of the relevant material that complies with the requirements of 4.56.

SANS 10400-T:2011

Edition 3

4.5.3 Any insulation, insulating panel or lining used as a thermal insulation system under an external covering as part of a roof or wall assembly (thermal insulated building envelope), tested in accordance with SANS 10177-5 and found to be combustible, shall be acceptable if, when classified in terms of the SANS 428 protocol, its use and application are acceptable.

NOTE The classification methodology contained in SANS 428 is intended to classify thermal insulation materials in accordance with their fire safety performance in respect of thermal insulated building envelopes, and to recommend the usage of the materials in accordance with its classification. SANS 428 further specifies marking and installation requirements in respect of classified products. The classification protocol makes provision for both horizontal and vertical applications, with or without the use of a fixed water-extinguishment (sprinkler) system and designers should take note under which circumstances the thermal insulation materials were classified.

4.6 Fire resistance of occupancy-separating and division-separating elements

4.6.1 Any portion of a building that has an occupancy in any one of the groups of occupancies given in table 4 shall, subject to the requirements of 4.3, be separated by means of an occupancy-separating element from any portion of such building used for an occupancy in any other of such groups of occupancies.

Table 4 — Fire resistance of occupancy-separating elements

1	2	3	4	5	6	7	8	9	10	11	12	13	14	15	16	17	18
Occupancy groups	Fire resistance																
	min																
	B1 D1	B2 D2	J1	A1 A2 A4 F1	F3	D4	E1 E2 E3 E4	A3	J2	F2	G1	J3	J4	H1 H2 H3 H4 H5	A5	C1 C2	B3 D3
B1, D1	•	120	120	120	120	120	120	120	120	120	120	120	120	120	120	120	120
B2, D2	120	•	120	120	120	120	120	120	120	120	120	120	120	120	120	120	120
J1	120	120	•	120	120	120	120	120	120	120	120	120	120	120	120	120	120
A1, A2, A4, F1	120	120	120	•	120	120	120	120	120	120	120	120	120	120	120	120	120
F3	120	120	120	120	•	120	120	120	120	120	120	120	120	120	120	120	120
D4	120	120	120	120	120	•	120	120	120	120	120	120	120	120	120	120	120
E1, E2, E3, E4	120	120	120	120	120	120	•	90	90	90	90	90	90	90	90	90	90
A3	120	120	120	120	120	120	90	•	90	90	60	60	60	60	60	60	60
J2	120	120	120	120	120	120	90	90	•	90	60	60	60	60	60	60	60
F2	120	120	120	120	120	120	90	90	90	•	60	60	60	60	60	60	60
G1	120	120	120	120	120	120	90	60	60	60	•	60	60	60	60	60	60
J3	120	120	120	120	120	120	90	60	60	60	60	•	60	60	60	60	60
J4	120	120	120	120	120	120	90	60	60	60	60	60	•	60	60	60	60
H1, H2, H3, H4, H5	120	120	120	120	120	120	90	60	60	60	60	60	60	•	60	60	60
A5	120	120	120	120	120	120	90	60	60	60	60	60	60	60	•	60	60
C1, C2	120	120	120	120	120	120	90	60	60	60	60	60	60	60	60	•	60
B3, D3	120	120	120	120	120	120	90	60	60	60	60	60	60	60	60	60	•

4.6.2 Where any occupancy-separating element is required, in terms of 4.6.1, such occupancy-separating element shall have a fire resistance of not less than that given in table 4. Where, in terms of 4.4, a division-separating element is required, such division-separating element shall have a fire resistance of not less than that given in table 5.

Table 5 — Fire resistance of division-separating elements

1	2
Occupancy	Fire resistance min
All occupancies other than those mentioned below	60
B1, C1, D1, E1, E2, E3, F1, F3, J1	120

4.6.3 Any movement joint in a division-separating or occupancy-separating element shall have the same fire resistance rating as that required for the separating element.

4.6.4 No combustible roof components shall penetrate the occupancy-separating elements or division-separating elements between occupancies and divisions.

4.7 Fire stability of structural elements or components

4.7.1 Any structural element or component directly supporting a separating element contemplated in 4.6 shall, when tested in accordance with SANS 10177-2, comply with the requirement for stability for a period of not less than that required for fire resistance of such separating element.

4.7.2 Any other structural element or component (that is not a component that forms part of a roof assembly) which is located in an occupancy given in column 1 of table 6 shall, when tested in accordance with SANS 10177-2, comply with the requirements for stability for a period of not less than the appropriate period given in columns 3 to 7 of table 6 for the corresponding number of storeys, provided however, that it shall be permissible for structural components to be of

- a) unprotected steel in any single-storey building; or
- b) timber construction that complies with SANS 10082, and that has a fire resistance of not less than 30 min where the occupancy of the building is classified as G1, H3 or H4, provided that in the case of any such occupancy the timber construction shall not exceed two storeys in height.

4.7.3 The roof assembly construction of E1, E2 and E3 occupancies shall be non-combustible.

4.7.4 The structural elements or components used in any basement which is not naturally ventilated shall comply with the requirements given in column 7 of table 6. Any such basement which is naturally ventilated shall be construed as being an additional storey to the building concerned and any structural elements or components used in such basement shall comply with the appropriate requirements given in columns 3 to 6 of table 6.

4.7.5 No unprotected steel shall be permitted in the structure of any basement.

4.8 Tenancy-separating elements

4.8.1 Any separating element between tenancies shall have a fire resistance of not less than 30 min, except in E1, E2, E3, H1, H2 and H3 occupancies, which shall not be less than 60 min.

SANS 10400-T:2011

Edition 3

4.8.2 With the exception of E1, E2, E3, H1, H2 and H3 occupancies, an automatic sprinkler system designed, installed and maintained by competent persons in accordance with SANS 10287 may be used instead of a tenancy-separating element.

4.9 Partition walls and partitions

4.9.1 Any partition or partition wall in any occupancy

- a) shall have a nominal fire resistance of not less than 30 min and be non-combustible, or
- b) where combustible materials are present, shall not contribute a fire load of more than 5 kg/m² of floor area in a division

provided that wall finishes comply with the requirements of 4.15.

4.9.2 In any building classified as H3 or H4

- a) any separating element (wall and floor) between any garage that is not large enough to be classified as J4 and any habitable room shall have a fire resistance of not less than 30 min and the wall shall extend to the underside of the roof;
- b) any door between such garage and any such room shall have a fire resistance of not less than 30 min and such doorway shall require a threshold of not less than 10 mm; and.
- c) no combustible roof components shall penetrate the separating element dividing the space between the garage and the habitable room.

4.9.3 Any solid timber door constructed with double rebated joints, that have a thickness of not less than 40 mm, shall be deemed to comply with the requirement of 4.9.2 for a rating of 30 min.

Table 6 — Stability of structural elements or components

1	2	3	4	5	6	7
Type of occupancy	Class of occupancy	Stability min				
		Single-storey building	Double-storey building	3 to 10 storey building	11 storeys and more	Basement in any building
Entertainment and public assembly	A1	30	60	120	120	120
Theatrical and indoor sport	A2	30	60	120	120	120
Place of instruction	A3	30	30	90	120	120
Worship	A4	30	60	90	120	120
Outdoor sport	A5	30	30	60	90	120
High risk commercial service	B1	60	60	120	180	120
Moderate risk commercial service	B2	30	60	120	120	120
Low risk commercial service	B3	30	30	90	120	120
Exhibition hall	C1	90	90	120	120	120
Museum	C2	60	60	90	120	120
High risk industrial	D1	60	90	120	180	240
Moderate risk industrial	D2	30	60	90	120	180
Low risk industrial	D3	30	30	60	120	120
Plant room	D4	30	30	60	90	120
Place of detention	E1	60	60	90	120	120
Hospital	E2	60	90	120	180	120
Other institutional (residential)	E3	60	60	120	180	120
Medical facilities	E4	30	30	Not applicable	Not applicable	120
Large shop	F1	60	90	120	180	120
Small shop	F2	30	60	120	180	120
Wholesalers' store	F3	60	90	120	120	120
Office	G1	30	30	60	120	120

Table 6 (concluded)

1	2	3	4	5	6	7
Type of occupancy	Class of occupancy	Stability min				
		Single-storey building	Double-storey building	3 to 10 storey building	11 storeys and more	Basement in any building
Hotel	H1	30	60	90	120	120
Dormitory	H2	30	30	60	120	120
Domestic residence	H3	30	30	60	120	120
Detached dwelling house	H4	30	30	60	Not applicable	120
Hospitality	H5	30	30	Not applicable	Not applicable	120
High risk storage	J1	60	90	120	180	240
Moderate risk storage	J2	30	60	90	120	180
Low risk storage	J3	30	30	90	90	120
Parking garage	J4	30	30	30	90	120

NOTE 1 Unprotected steel may be used in the structural system of all single-storey and certain double-storey buildings in spite of the fact that in many cases such structural members would not comply with the requirements of this table. The practice is regarded as safe for all practical cases that are likely to occur in single-storey construction, but the possible consequences of early distortion or collapse should be considered in the design of double-storey buildings in order to be certain that escape routes will be able to serve their purpose for the required period. Particular care should be exercised where thin sections are used or in "space-frame" type structures.

NOTE 2 A further problem arises in the application of the requirement of 4.2. Distortion or collapse of any structural member should not cause loss of integrity or stability in any external wall facing a site boundary or another building as this might lead to non-compliance with the safety distance requirement. Where such a situation occurs, it would be necessary either to protect the steel to the extent required to attain the stability given in this table or to regard such wall as being of type N for the purposes of 4.2.

4.10 Protection of openings

4.10.1 Where an opening in any external wall of any division is less than 1 m measured horizontally or vertically from an opening in another division, a 500 mm projection from such wall shall be constructed between such openings. Such projection shall have a fire resistance of not less than half that required for the element separating the divisions concerned, provided that any other equivalent means of fire protection which ensures that the flame travel path from one opening to another is not less than 1 m shall be permitted.

Figures 1(a) and (b) show the requirements of 4.10.1, and figure 1(c) represents a possible alternative arrangement. In the examples shown, any flame travelling from one window to the other would have to travel along some path the shortest length of which would be at least 1 m. The windows are shown in plan but similar forms of construction could be used in the vertical plane.

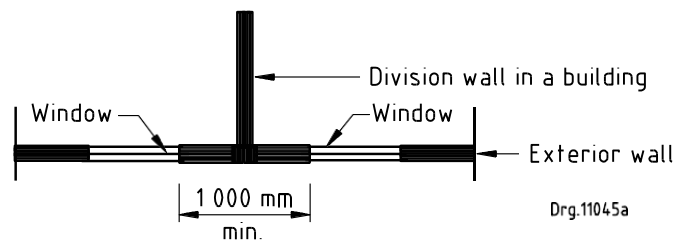

a) Flame path travel condition 1

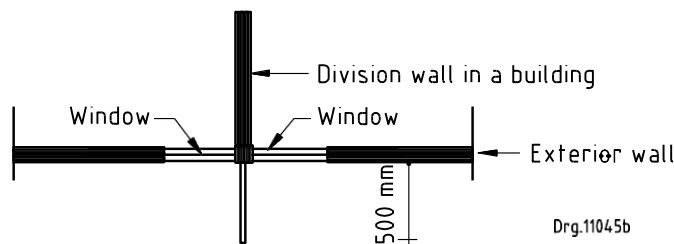

b) Flame path travel condition 2

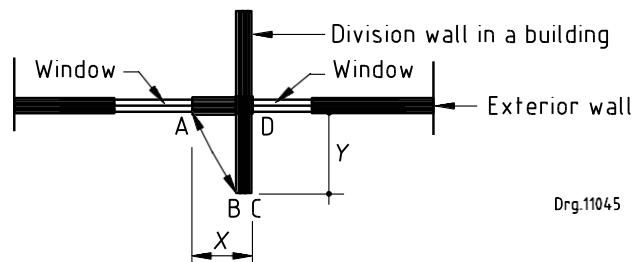

Dimensions X and Y should be such that the minimum path of flame travel ABCD is more than 1 000 mm.

c) Flame path travel condition 3

NOTE The figures are all shown in plan but would be identical in section, except that the division wall would be replaced by a division floor.

Figure 1 — Flame path travel between openings

SANS 10400-T:2011

Edition 3

4.10.2 Where there is an opening in any wall required to have a fire resistance of 60 min or more, such opening shall be provided with a fire door or fire shutter of the class given in column 3 of table 7, provided that this requirement shall not apply

- a) where such opening (that is not an opening contemplated in 4.27.2) gives access to a safe area outside the building, or
- b) in the case of any service shaft that is fire-stopped at every floor level.

Fire doors to service shafts and service rooms do not need to be fitted with self-closing devices, but shall be fitted with locks that provide restricted access.

Table 7 — Class of fire doors or fire shutters

1	2	3
Type of wall	Required minimum fire resistance of wall min	Class of fire door or fire shutter
Occupancy separation	60	A
	120	B
Occupancy separation – Plant rooms or other ancillary accommodation	120	C
	60	A
Divisional separation	60	A
	120	D
Emergency route	120	B
Protected corridor and protected stairs.	30	E
Service shafts not fire stopped at every floor level	60 or 120	A or B
Openings in all walls	30	F

4.10.3 Any fire door or fire shutter shall comply with the requirements of SANS 1253.

4.10.4 Any fire door or fire shutter (excluding fire doors and fire shutters to service shafts and service rooms) shall be fitted with a self-closing or automatic closing device in accordance with the requirements of SANS 1253.

4.10.5 Any fire door which is required to have a specific fire resistance may be replaced by two separate fire doors which shall be positioned apart not less than 1,5 times the width of any leaf of such door, provided that the sum of the fire resistances of such separate doors shall not be less than the fire resistance required for the single door.

4.10.6 Any hinged fire doors installed in terms of 4.10.5 shall open in the direction of egress and be hinged on the same side.

4.11 Raised access and suspended floors of combustible material

Except in the case of any building classified as H3 or G1 which does not exceed two storeys in height, or in the case of any building classified as H4, no suspended floor shall be permitted to be of combustible material unless such floor has ground directly below it or is not more than 50 mm above a non-combustible slab.

4.12 Roof assemblies and coverings

4.12.1 General

4.12.1.1 Where a roof of any part of a building meets any wall of a higher part of such building and such wall has any opening in a different division, occupancy or tenancy to that of the roof in question and such opening is in any position within 10 m above and 5 m to either side of such roof, such roof shall, for a distance of not less than 5 m from such wall, have a fire resistance required for a division-separating wall for the occupancy in question. (See figure 2.)

4.12.1.2 Where any combustible roof covering material, including thatch, shingles and bitumenized felt on boarding is used and the plan area of such roof is more than 20 m², the distance between the building so covered and any boundary of the site on which such building is situated shall be not less than 4,5 m.

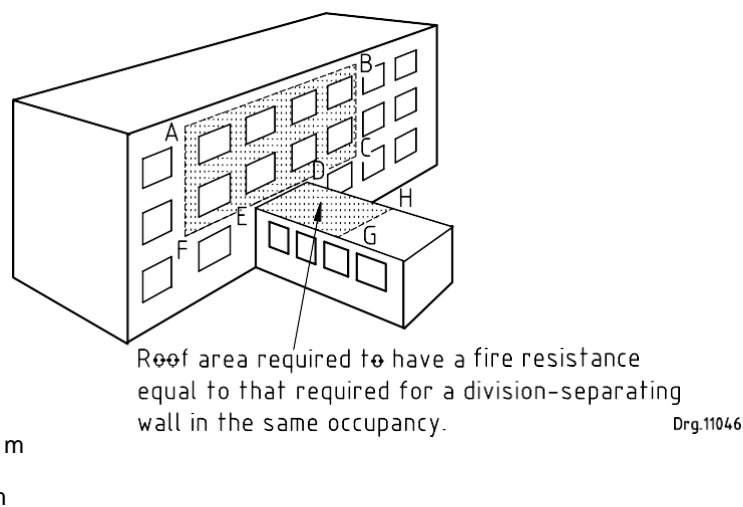

Figure 2 — Roof fire resistance

4.12.1.3 Where any roof covering includes individual, small areas of combustible material, the total area of which is not more than 5 % of the roof area, and where

- a) no such individual area is more than 20 m², such roof covering shall not be considered a combustible roof covering, provided that
 - 1) where the slope of the roof does not exceed 60° there shall be a minimum distance of 1 m between any two such areas, and
 - 2) where the slope of the roof exceeds 60° there shall be a minimum distance of 1 m measured horizontally and 3 m measured along the slope of such roof between any two such areas.
- b) any such individual area exceeds 20 m² in a roof and might constitute an element of danger to the public, such material shall be permitted only where it is the subject of a rational assessment regarding its use and application.

NOTE Figure 3 shows the application of 4.12.1.3(a).

4.12.1.4 Any combustible waterproof membrane in contact with a concrete slab shall be considered non-combustible.

4.12.1.5 When any insulation, roof lining or waterproof membrane not used as a ceiling and used under a roof covering as part of a roof assembly, is tested in accordance with SANS 10177-5 and found to be combustible, such material shall be acceptable should it be classified, marked and installed in accordance with the requirements of SANS 428.

SANS 10400-T:2011

Edition 3

4.12.1.6 Where roof space is formed between any ceiling and any roof covering, such space shall be divided by means of non-combustible fire stops with a stability and integrity rating of at least 20 min into areas of not more than 500 m². The distance between such fire stops shall be not more than 30 m, provided that this requirement shall not apply where such roof space and the room below are protected by a fixed automatic fire-fighting system and smoke control system in accordance with 4.42. If any combustible materials are installed in such roof space, such as combustible insulation, then the area for non-combustible fire stops shall be not more than 250 m² and the distance between such fire stops shall not be more than 20 m. Any such roof space used as an air-conditioning or artificial ventilation system plenum shall comply with the requirements of 4.43.6.

4.12.1.7 In the case of an occupancy classified as H1, H2 and H3, the separating elements specified between these units shall be extended, and any such extension shall

- a) have the same fire resistance as the wall supporting it,
- b) be taken to the underside of any non-combustible roof or roof covering or any concrete slab,
- c) for combustible roofs, be taken to not less than 500 mm above and to the sides of any combustible roof covering other than one laid on concrete, and
- d) be such that no part of the roof assembly, made of wood or any other combustible material, shall pass through the separating wall.

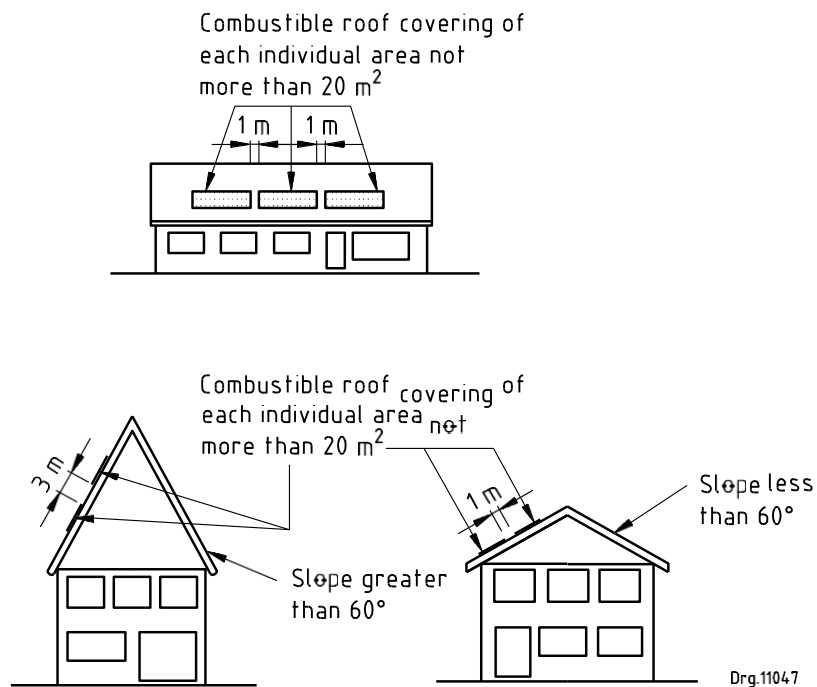

Figure 3 — Roof coverings

4.12.2 Thatched roofs

4.12.2.1 The safety distances derived from 4.2 shall, notwithstanding the occupancy classes given in table 2, be based on a high fire load where the thatch is untreated and value A in the formula will be based on the facade area of the roof. Where the thatch is treated with an acceptable fire-retardant system, the safety distances shall be based on the following fire loads:

- a) test result A – low fire load
- b) test result B – medium fire load

c) test result C – high fire load

NOTE A test result C is equivalent to an untreated roof.

4.12.2.2 Notwithstanding the requirements of 4.12.1, a thatched lapa that has a roof plan area of less than 20 m², that is free standing and not attached to any other building shall not be erected closer than

a) 1,0 m to any boundary, and

b) the safety distance from any building derived from 4.2, unless a free-standing masonry or concrete wall that has a height greater than 0,3 m above the bottom line of the roof and which extends at least 1,0 m on either side of the lapa is erected.

4.12.2.3 A competent person (fire engineering) shall perform a rational assessment to determine the acceptability of erecting a lapa against an existing building.

4.12.2.4 Buildings and lapas with a thatched roof plan area greater than 300 m² or which are closer than the greater of 4,5 m to any boundary and the safety distances from an existing building derived from 4.2, shall be provided with additional fire protection systems (post-treated on both sides, pre-treated as a permanent system or any other system) that are acceptable in relation to the actual roofing system that is to be used, and retreated and maintained at the intervals as indicated by the manufacturer of such systems.

4.12.2.5 Buildings and lapas with thatched roofs in areas with a lightning flash density greater than 7 (see SANS 10313) or where conductors (wire sways) are used in the thatch layer shall be provided with a lightning protection system designed and installed by competent persons in accordance with the relevant requirements of SANS 10313 and SANS 62305-3.

4.12.2.6 Buildings and lapas in which conductors (wire sways) are used in the thatch layer shall, in areas with a lightning flash density greater than 3 (see SANS 10313), be provided with a lightning protection system, designed and installed by competent persons in accordance with the relevant requirements of SANS 10313 and SANS 62305-3.

4.13 Ceilings

4.13.1 In any building that is not a building classified as E4, H3, H4 and H5, combustible material shall not be used for any ceiling or suspended ceiling, or as a component thereof, except as provided for in the following:

a) A ceiling tested in accordance with SANS 10177-5 and found to be combustible, shall be acceptable if it is used in terms of its classification in accordance with SANS 428, provided that this requirement shall not apply where the thickness of such combustible material is less than 0,5 mm and such finish adheres fully to a non-combustible substrate.

b) Air supply grilles or return-air intake grilles of combustible material, where the sum of the area of all such grilles form not more than 5 % of the total area of such ceiling and the overall area of any individual grille is not more than 0,09 m², shall be permitted.

c) No combustible materials shall be permitted in the ceilings or walls (or both) in occupancies classified as A1, E1, E2, E3, H1 and H2.

4.13.2 Where roof space is formed between a ceiling and a roof covering, such space shall be divided into areas of not more than 500 m² by means of non-combustible fire stops with a stability and integrity rating of at least 20 min. The distance between such fire stops shall be not more than 30 m, provided that this requirement shall not apply where such roof space and the room below are protected by a fixed automatic fire-fighting system and an automatic smoke control system (or both).

SANS 10400-T:2011

Edition 3

If any combustible products are installed in such roof space, for example combustible insulation, then the area for non-combustible fire stops shall not be more than 250 m² and the distance between such fire stops shall not be more than 20 m. Any such roof space used as an air-conditioning or artificial ventilation system plenum shall comply with the requirements of 4.43.6.

4.14 Floor coverings

4.14.1 Where any combustible material, other than the material specified in 4.14.2 or 4.14.3, is used as a floor covering in a building, the maximum area of any room in which such floor covering is used shall be not more than one quarter of the relevant division area given in table 3 for the occupancy classification in question.

4.14.2 Any fitted carpet shall be permitted in any building where such carpet is of a type of which a representative specimen, when tested in accordance with SANS 10177-4, has a classification not inferior to that specified in table 8 for the particular occupancy concerned, provided that this requirement shall not apply in the case of a fitted carpet laid in any occupancy classified as H4.

4.14.3 Any combustible floor covering shall be permitted in any building where such covering does not exceed 5 mm in thickness or is made up of timber of up to 20 mm thickness, and is fully adhered to the non-combustible substrate.

Table 8 — Classifications for fitted floor coverings

1	2	3	4	5	6	7	8
Class of occupancy	Classification						
	Basement of building of any height	Building up to three storeys		Building exceeding three storeys		Building of any height	
	Any floor area except that contained in column 7 or column 8					Feeder routes	Emergency routes
	USP or SP	USP	SP	USP	SP		
A1	2	3	NR	3	NR	2	1
A2	2	3	NR	3	NR	2	1
A3	2	3	NR	3	NR	2	1
A4	2	3	NR	3	NR	2	1
B1	2	3	NR	3	NR	3	1
B2	2	4	NR	3	NR	3	1
B3	3	4	NR	4	NR	3	1
C1	3	3	NR	3	NR	2	1
C2	3	3	NR	3	NR	2	1
D1	NC	NC	NC	NC	NC	NC	NC
D2	2	4	NR	3	NR	3	1
D3	2	4	NR	4	NR	3	1
D4	NC	NC	NC	NC	NC	NC	NC
E1	NC	3	NR	3	NR	2	1
E2	NC	3	NR	3	NR	2	1
E3	NC	3	NR	3	NR	1	1
E4	NC	3	NR	3	NR	1	1
NC – Non-combustible material only SP – Protected by a sprinkler system USP – Not protected by a sprinkler system NR – No requirement							

Table 8 (concluded)

1	2	3	4	5	6	7	8
Class of occupancy	Classification						
	Basement of building of any height	Building up to three storeys		Building exceeding three storeys		Building of any height	
	Any floor area except that contained in column 7 or column 8					Feeder routes	Emergency routes
	USP or SP	USP	SP	USP	SP		
F1	3	4	NR	3	NR	2	1
F2	3	4	NR	3	NR	2	1
F3	3	4	NR	3	NR	2	1
G1	3	4	NR	4	NR	3	1
H1	1	4	NR	4	NR	3	1
H2	1	4	NR	2	NR	3	1
H3	1	5	NR	3	NR	3	1
H5	1	5	NR	3	NR	3	1
J1	NC	NC	NC	NC	NC	NC	NC
J2	NC	NC	NR	NC	NR	2	1
J3	2	3	NR	2	NR	2	1
J4	NC	NC	NC	NC	NC	NC	NC
<p>NC – Non-combustible material only SP – Protected by a sprinkler system USP – Not protected by a sprinkler system NR – No requirement</p>							
<p>NOTE 1 Only those areas actually used for the occupancies are given.</p> <p>NOTE 2 The use of a combustible material as a ceiling, a fitted floor covering or a wall finish could make a considerable contribution to the fire load in the building. Since it is neither reasonable nor practical to preclude the use of such materials, it should be taken into account both that they are combustible and that, in burning, they might help to spread a fire and might make a significant contribution to the quantity of heat, smoke and noxious fumes generated.</p> <p>NOTE 3 Where a combustible material is used for a ceiling or wall finish or where a non-classified combustible material is used as a fitted floor covering, the increase in fire load could be significant. Under these circumstances the maximum area permitted for a division of any building will be reduced, although concessions have been made in the case of buildings of not more than three storeys in height and buildings that are sprinkler protected. However, it is always necessary, even within a division of reduced size, to control where and under what conditions combustible materials are used, as the rate of burning will be different for each material, as will its contribution to heat and smoke.</p> <p>NOTE 4 A material to be used for a floor covering or for a wall finish is tested in a standard manner and is classified on a scale of 1 to 5. In both cases the lower figures indicate better performance. These classifications are based on a "fire index" which in turn represents the effect of rate of burning and the amount of heat and smoke generated. In some cases the behaviour of a floor covering in a fire might be considerably influenced by the quality of the underfelt used and it is therefore recommended that, where a carpet is intended to be used with underfelt, it should be tested together with the particular underfelt. At present no classification of underfelt, equivalent to that used for carpets, is available and it is thus not possible to give any deemed-to-satisfy requirements for the underfelt.</p> <p>NOTE 5 Control of the use of a combustible material as a fitted floor covering or as a wall finish is covered in this table and table 9, respectively, and is based on the classification mentioned above. The class of material required in any given circumstances is related to the occupancy classification, burning height, and the provision of a fixed fire-fighting system in the building concerned and is determined from these tables. It should be stressed that this procedure should be followed whether or not it has been found necessary, in terms of 4.14 or 4.15, to reduce the maximum area permitted within a division.</p>							

SANS 10400-T:2011

Edition 3

4.15 Internal finishes

4.15.1 A combustible internal finish, such as a wall lining or decorative finish, except where used in a building classified as H4, shall be of a type of which a representative specimen, when tested in accordance with SANS 10177-3, has a classification not inferior to that specified in table 9 for the occupancy concerned, provided that this requirement shall not apply where the thickness of such finish is less than 0,5 mm and such finish adheres fully to a non-combustible material.

Table 9 —Classifications for internal finishes

1	2	3	4	5	6	7	8
Class of occupancy	Classification						
	Basement of building of any height	Building up to three storeys		Building exceeding three storeys		Building of any height	
	Any floor area except that contained in column 7 or column 8					Feeder routes	Emergency routes
	USP or SP	USP	SP	USP	SP		
A1	1	3	3	3	3	2	1
A2	1	3	3	3	3	2	1
A3	1	3	3	3	3	2	1
A4	1	4	4	3	4	2	1
B1	2	3	4	3	4	3	1
B2	2	3	4	3	4	3	1
B3	3	4	5	4	5	3	1
C1	3	3	4	3	4	2	1
C2	3	3	4	3	4	2	1
D1	NC	NC	NC	NC	NC	NC	NC
D2	2	3	4	3	4	3	1
D3	2	4	5	4	5	3	1
D4	NC	NC	NC	NC	NC	NC	NC
E1	NC	2	2	2	2	2	1
E2	NC	2	2	2	2	2	1
E3	NC	2	2	2	2	2	1
E4	NC	2	2	2	2	2	1
F1	3	2	3	2	3	2	1
F2	3	2	3	2	3	2	1
F3	3	2	3	2	3	2	1
G1	3	4	5	4	5	3	1
H1	Not permitted	3	5	3	5	3	1
H2		3	4	2	4	3	1
H3		4	5	3	4	3	1
H5		4	5	3	4	3	1
J1	NC	NC	NC	NC	NC	NC	NC
J2	NC	NC	NC	NC	NC	2	1
J3	2	3	4	2	3	2	1
J4	NC	NC	NC	NC	NC	NC	NC

NC – Non-combustible material only
 SP – Protected by a sprinkler system
 USP – Not protected by a sprinkler system

NOTE Only those areas actually used for the occupancies are given.

4.15.2 The use of combustible material shall be permitted for any door leaf or for trim to any door frame or window frame or for any pelmet, chair rail, picture rail or skirting.

4.16 Provision of escape routes

NOTE Annex D provides guidance on the application of this subclause.

4.16.1 One or more escape routes shall be provided in every building.

4.16.2 Where the travel distance, measured to the nearest escape door, is not more than 45 m, subject to the provisions of 4.16.6, 4.16.7, such escape route shall comply with the following requirements:

- a) In a single-storey building, in a dwelling unit that has an escape door at ground level, or from a dwelling unit at first floor level, where such dwelling unit is served by an individual stairway to ground level, such escape route shall not be required to include any emergency route and, in the case of a dwelling unit, such escape route shall not be required to comply with the requirements of 4.17 to 4.30, inclusive.
- b) In a single-storey or double-storey building with a population of less than 25 persons on either floor, the travel distance along a common path of travel shall not exceed 35 m. A secondary means of escape shall be provided where the common path of travel exceeds 35 m.
- c) In a building of two or three storeys in height, such escape route shall not be required to include any emergency route, provided that a building
 - 1) of two storeys in height where the population of the upper storey is more than 25 persons, or
 - 2) of three storeys in height;shall be provided with not less than two such escape routes.
- d) Any building of a height of more than three storeys shall be provided with not less than two escape routes and
 - 1) an emergency route shall form part of each such escape route, and
 - 2) such emergency route shall include a stairway that forms part of the escape route and also that part of the escape route from the lower end of the stairway to any escape door.

4.16.3 Where the travel distance measured to the nearest escape door is more than 45 m, not less than two escape routes shall be provided and an emergency route shall form part of each such escape route.

4.16.4 Where, in terms of 4.16.2 or 4.16.3, emergency routes are required in a building,

- a) the total travel distance from the furthest point in such room to an exit door or to a feeder route shall be not more than 15 m and the total distance travelled from within the room to the access door or escape door shall be not more than 45 m; or
- b) the travel distance measured to the nearest access door or escape door shall be not more than 45 m, provided that where the building is provided with a sprinkler system designed, installed, maintained and configured by competent persons to be a life-safety installation in accordance with SANS 10287, the travel distance may be increased to 60 m if the walls adjacent to the escape route are separating elements with a fire resistance of at least 30 min and all openings are protected;

SANS 10400-T:2011

Edition 3

- c) the path of travel to access doors and escape doors shall be along a feeder route; and
- d) such feeder route shall lead in two different directions to two or more independent emergency routes or escape doors.

4.16.5 All doorways and circulation spaces, obstructions in the path of travel, stairways, ramps, handrails and warning signals located along escape routes in buildings other than those occupancies classified as D4, H1, H3, H4, J1, or J2 in terms of Regulation **A20** (see SANS 10400-A) shall comply with the requirements of SANS 10400-S.

NOTE Emergency escape route signs are usually located high up against walls or hang from ceilings. Since persons with visual impairments need physical contact to read information, it is almost impossible for them to reach such signs. Evacuation of persons with visual impairments should therefore be included in the health and safety procedures and in regular evacuation exercises.

4.16.6 The exit door from any room shall lead directly into a feeder route or a common path of travel, provided that

- a) such exit door may lead into any other room, where such other room is within the same tenancy and the exit door from such other room leads into a feeder route, provided that the distances contemplated in 4.16.2, 4.16.3, and 4.16.4 are not exceeded, and
- b) the total common path of travel shall not exceed 30 m.

4.16.7 Any dead-end corridor shall not exceed 10 m in length.

4.16.8 Refuges, where required, shall be rationally designed by a competent person (fire engineering) and

- a) be provided at not less than one for each stairway on each storey;
- b) have a fire resistance of not less than 30 min;
- c) be of sufficient size and manoeuvring potential to accommodate a wheelchair user and a companion; and
- d) be located such that they do not adversely affect routes or means of escape.

NOTE The design means of escape in this part of SANS 10400 is based on the presumption that, given adequate information, the users of multi-storey buildings could make their way out, independently and relatively quickly, using suitable stairs. The increase in accessibility to buildings for all persons, including persons with disabilities means that this presumption might not always be true. The increasing provision of lift access within comparatively low-rise buildings presents different challenges for the design and management of buildings. The principal means of escape from a multi-storey building includes protected horizontal routes and suitably designed escape stairs that the occupants can use independently. However, such routes might not be suitable for persons who have made their way, by passenger lift, to a storey above or below an entrance level but who are unable to use stairs to make their way out. In addition, traditional forms of instruction with respect to the use of escape routes might be difficult to comprehend by some persons. For such persons, alternative provisions, such as refuges, might be required.

4.16.9 Every locking device fitted to an access door or escape door in any escape route shall be of a type approved by the local authority, provided that in any building where an electronic locking device is required for security purposes, such locking device shall be of a type which unlocks automatically when any of the fire detection equipment or electrical fire protection equipment of the building is activated or when there is no power to the locking device.

NOTE Locking devices that are unacceptable include keys in break glass boxes. Locking devices that are acceptable should be capable of being operated in a single movement without the use of a key.

4.16.10 An exit door provided with a lockable facility from any occupancy class A1, A2, A3, A4 and A5 shall be provided with a panic bar in accordance with EN 1125 if the population exceeds 60 persons. At no time during the use of such occupancy by the public shall such door be locked, obscured, obstructed, covered or hidden.

4.16.11 Security gates used to secure doors along escape routes shall comply with the relevant requirements of 4.16.9 and 4.20 and shall be provided with facilities to lock them in the open position whilst such premises are occupied. Such gates shall open in the direction of egress.

4.17 Exit doors

4.17.1 Where the population of any room is not more than 25 persons, the clear width of any exit door shall be not less than 750 mm. Where two or more exit doors are required, they shall be positioned as far apart as is practicable, but not closer than 5 m from each other.

4.17.2 A classroom, lecture room or boardroom that has a population of more than 50 persons or any other room that has a population of more than 25 persons shall have not less than two exit doors, and such doors

a) shall open in the direction of travel along the escape route, and

b) shall have an aggregate width of not less than the required width for an escape route for such population, in accordance with 4.21, provided that where such population is more than 240 persons, three or more exit doors, as might be required, shall be installed.

4.17.3 In any room in a building where the occupancy is classified as A1, A2, A3, A4, C1, C2, E2, E3, F1 or F3, an exit door shall open in the direction of travel along the escape route, provided that in any occupancy classified as A3 where the population of the room is less than 50 persons, such door may open into such room against the direction of travel along the escape route.

4.17.4 The requirements of 4.19.6, 4.20 and 4.21 shall apply, modified as appropriate, to any exit door.

4.18 Feeder routes

4.18.1 Where a corridor in a building forms part of a feeder route, the walls and partition walls enclosing such corridor shall be constructed of non-combustible materials and finishes shall be in accordance with the requirements of 4.14 and 4.15.

4.18.2 A door in the path of travel along any feeder route shall be of the double swing type and such door shall not be provided with any means of locking.

4.18.3 The requirements of 4.19.6, 4.19.7, 4.19.8, 4.20 and 4.21 shall apply, modified as appropriate, to any feeder routes.

4.19 Emergency routes

4.19.1 After being subjected to two impacts with a 30 kg mass sandbag swung from a vertical height of 1,5 m, a wall enclosing an emergency route shall have a fire resistance of not less than 120 min or the relevant time required for the stability of structural elements or components as given in table 6, whichever is the lesser. A floor or ceiling of an emergency route shall have a fire resistance of not less than 120 min or the relevant time required for the stability of structural elements or components as given in table 6, whichever is the lesser.

SANS 10400-T:2011

Edition 3

4.19.2 The finish of the floor of an escape route shall have a slip-resistant surface and shall be free from any projections, indentations, hollows or covering which might cause a person to trip. Such finish or covering shall be of a classification not inferior to that given in table 8.

4.19.3 Finishes of emergency routes shall be in accordance with the requirements of 4.14 and 4.15.

4.19.4 Services conveying any flammable substances or comprising combustibles shall not be located in an emergency route.

4.19.5 An emergency route shall consist of one or more of the following components so arranged that each component discharges directly into another component:

- a) doors;
- b) internal or external passages;
- c) internal or external stairways or ramps; and
- d) lobbies, foyers or vestibules.

4.19.6 The last component of any emergency route shall discharge at ground level directly into a street or public place or into an open-air space leading to a street or public place.

4.19.7 Subject to the requirements of 4.19.8, an access door or any other door that is a component of an emergency route shall be a hinged door which shall open in the direction of exit from the building.

4.19.8 A revolving or sliding door or automatically operated door or shutter may form part of an emergency route where such door or shutter is positioned at the end of the route discharging into a safe area, provided that

- a) there shall be, adjacent to such door or shutter, an alternative hinged door which shall comply with all the rules relating to hinged doors in emergency routes, or
- b) such automatically operated sliding door or shutter shall be equipped with a failsafe system and such revolving door shall be of a collapsible type.

4.19.9 No door giving access to an emergency route shall, when opened, obstruct the progress of persons using such route.

4.19.10 A door frame, and door leaf when in the open position, shall not protrude into the width of the emergency route by more than 100 mm on either side.

4.19.11 A door fitted with a locking device as specified in 4.16.9 shall be clearly indicated on the fire plan or general plan.

4.20 Dimensions of components of escape routes

4.20.1 The clear width of an exit door or escape door from a room that has a population of not more than 25 persons shall be not less than 750 mm.

4.20.2 The doors in a lobby, foyer or vestibule shall have a width of not less than that required for an escape route derived from 4.21 and 4.19.10.

4.20.3 The travel distance shall be measured along the centre line of the shortest natural unobstructed path of travel within a storey or room and along any escape route, and where such route is via a ramp or stairway, the measurement shall be along the plan centre line of such ramp or stairway.

4.20.4 An escape route shall be provided, throughout its length, with a clear vertical headroom of 2 m and in any lobby, foyer or vestibule the minimum room height shall be not less than 2,4 m.

4.21 Width of escape routes

4.21.1 The population of any room or storey or portion thereof shall be the actual number of persons in such room, storey or portion thereof during normal use. Where the actual population is not known, the population shall be calculated from the criteria given in Regulation **A21** (see SANS 10400-A). Where more than one escape route discharges into a common component, the width of such common component, and any subsequent components situated along the direction of exit, shall be calculated by taking into account the population discharging into such common component, provided that in the case of a stairway, only the population of the most heavily populated storey served thereby shall be deemed to discharge into such stairway.

4.21.2 In any building, the width of an escape route to be provided in respect of any room, storey or portion thereof shall be not less than that given in table 10 for the population concerned, provided that

- a) no individual escape route shall be designed for a population of more than 190 persons, and
- b) where there are two or more escape routes, one such route shall not be considered in determining the widths required for the remainder.

4.21.3 The aggregate width of escape routes shall be so distributed that the minimum widths of individual routes serving any room, storey or portion thereof shall be as nearly equal to each other as is practicable.

4.21.4 The width of an escape route shall not decrease in the direction of emergency travel, except at an exit door to a lobby, foyer or vestibule.

NOTE Annex D provides guidance on the application of the requirements of 4.19 to 4.21.

Table 10 — Width of escape routes

1	2	3
Maximum number of persons	Building not required in terms of Part S of the National Building Regulations to provide facilities for persons with disabilities	Building required in terms of Part S of the National Building Regulations to provide facilities for persons with disabilities
	Minimum width mm	
≤ 100	1 000	1 500
≤ 120	1 100	1 500
≤ 130	1 200	1 500
≤ 140	1 300	1 500
≤ 150	1 400	1 500
≤ 160	1 500	1 500
≤ 170	1 600	1 600
≤ 180	1 700	1 700
≤ 190	1 800	1 800

NOTE This table does not contemplate simultaneous evacuation from multi-storey buildings.

4.22 Basements

In a building not classified as D4 or H4, any basement storey shall be served by not fewer than two separate emergency route stairways, provided that where such storey is used for the parking of motor vehicles, one such emergency route stairway may be replaced by a motor vehicle ramp in accordance with SANS 10400-D, subject to the requirements of 4.19.5.

4.23 Stairways and other changes of level along escape routes

4.23.1 The storeys of a duplex dwelling unit may be served by a single stairway within such dwelling unit, provided that such dwelling unit shall have access to an escape route as required by this part of SANS 10400.

4.23.2 At any storey level, the entrance to a stairway that forms part of an emergency route shall be not closer than 5 m to the entrance to any other such stairway.

4.23.3 A stairway that forms part of an emergency route shall discharge into a street, public place or an open space and may include a corridor or foyer forming part of such emergency route.

4.23.4 A stairway that forms part of an emergency route from any storey above ground level shall not have direct access to a basement.

4.23.5 No escalator shall form part of any emergency route.

4.23.6 Where a stairway forms part of an emergency route, such stairway shall, throughout its length, be provided with a handrail on either side in accordance with the requirements of SANS 10400-S.

4.23.7 Notwithstanding the requirements for minimum width given in SANS 10400-M, the width of a stairway that forms part of an emergency route shall be not less than that given in table 10 for the population concerned and such width shall be not more than 1,8 m, provided that any handrail may project into such width by an amount of not more than 100 mm.

4.23.8 The distance between any change in floor level and the centre line of a doorway in an emergency route or between two changes of floor level in such route shall be not less than 1,5 m (see figure 4).

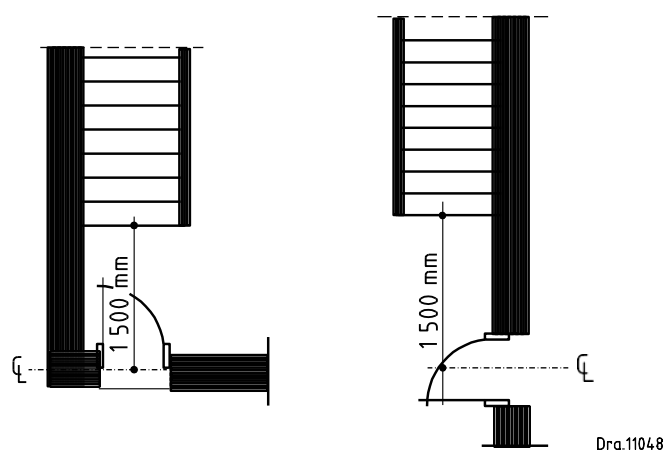

Figure 4 — Position of doors in relation to change in level

4.23.9 No spiral stairway, as given in SANS 10400-M, shall form part of any escape route for a building which is required in terms of the National Building Regulations to provide facilities for persons with disabilities. Where such stairways are provided, the narrowest part of the going of such stairways shall be greater than 250 mm.

4.23.10 The rise and tread of any step forming part of an escape route shall comply with the requirements given in SANS 10400-M and, in addition, such step shall have solid treads and risers, provided that, in the case of any occupancy classified as D4 or in the case of any external stairway specified in 4.27, such risers may be omitted.

4.23.11 Any change in the level of the floor of an escape route other than by a stairway between storeys shall be effected by means of a ramp or steps, provided that

- a) the ramp shall have a slope in accordance with the requirements of SANS 10400-S, and
- b) in the case of steps, not fewer than three steps shall be provided together with a ramp of width not less than 900 mm, and a slope in accordance with the requirements of SANS 10400-S.

4.24 Ventilation of stairways in an emergency route

An enclosed stairway which is not pressurized and which is a component of any emergency route in any building that does not exceed 30 m in height, shall be

- a) provided with a window or other opening not less than 1 m² in area for natural ventilation to the outside of the building at each storey level, or
- b) naturally ventilated by means of a roof ventilator that has an effective area of not less than 25 % of the plan area of the stairwell, and such ventilator shall be permanently open, with equal effective areas of inlet air vents provided at the bottom of such stairway.

4.25 Pressurization of emergency routes and components

Pressurization of emergency routes and components shall be designed, installed, tested and maintained by competent persons in accordance with the relevant part of EN 12101.

4.26 Openings in floors

4.26.1 In any building not classified as H4, any opening, including an opening occupied by a stairway or escalator that does not form part of an escape route, shall not connect more than

- a) two storeys, if such building is not protected by a sprinkler system, or
- b) four storeys, if such building is protected by a sprinkler system that is designed, installed and maintained by competent persons in accordance with SANS 10287.

4.26.2 At any landing of such stairway or escalator system, a sign shall be displayed indicating the direction to at least one of the escape routes.

4.27 External stairways and passages

4.27.1 No external stairway or passage shall be permitted to be a component of an emergency route of any building which exceeds 18 m in height unless such stairway is, subject to the requirements of 4.24, partially enclosed throughout its length.

NOTE In a high building, persons using a completely open external stairway will feel insecure and some might experience vertigo. This could lead to panic and disrupt evacuation of such building in case of fire or

SANS 10400-T:2011

Edition 3

other emergencies. Therefore, any external stairway to a building more than 18 m in height should be provided with some form of enclosing walls or screens, particularly where these will provide some visual barrier at the ends of each flight of stairs and at any landing outside an access door. The height and extent of such walls or screens will depend upon the dimensions and layout of the stairs, the sight-line in each case, and the degree to which it might be desired to provide additional protection against wind, rain, etc.

4.27.2 No window, door or other unprotected opening in any facade of a building shall be closer than 3 m to an access door, passage or an open stairway that forms part of an escape route, unless such opening is protected by a class F fire door or fire shutter that complies with SANS 1253 or fire damper that complies with SANS 193, provided that this requirement shall not apply to a window not exceeding 0,3 m² in area, serving any room containing a toilet pan, or any bathroom or cloakroom.

4.28 Lobbies, foyers and vestibules

4.28.1 Where a lobby, foyer or vestibule (hereinafter referred to as a "lobby") is a component of one or more escape routes, such lobby shall have the combined width of all escape routes discharging into it or be 33 % wider than the width calculated on the basis of the population which is to pass through it, whichever is the greater.

4.28.2 Any display in such lobby shall only be by means of a fixed board or fixed display case which shall not protrude more than 150 mm into such lobby and no other object shall be permitted to be placed in such lobby. Glass used for such display case shall be safety glass in accordance with the requirements of SANS 10400-N.

4.28.3 No trading or business activity shall be carried out in a lobby except from a fixed area approved by the local authority.

4.28.4 Where a lobby forms part of an emergency route, it shall comply with the requirements of 4.19.

4.28.5 Where a lobby forms the ground level exit discharge of an escape route, the maximum fire load contained in such lobby shall not exceed 5 kg/m² (timber equivalent).

4.29 Marking and signposting

4.29.1 A building that has escape routes shall be clearly marked and signposted to indicate the direction to be travelled in the case of any emergency. Such signage may be of the internally or externally illuminated, or photoluminescent type and shall comply with the relevant requirements of SANS 1186-1, SANS 1186-3, SANS 1186-5 and SANS 1464-22.

4.29.2 Any marks or signs referred to in 4.29.1 shall comply with the requirements of SANS 10114-2 with regard to the maximum viewing distance of the sign in proportion to the vertical dimension of the sign.

4.29.3 The exit door of a room which has a population of less than 25 persons shall not be required to be so marked. Where a room has more than one exit door, any door used for normal exit from such room shall not be required to be so marked.

4.29.4 In the case of any occupancy classified as A1, A2, A3, A4 and A5, an illuminated symbolic safety sign shall be displayed over any exit doors.

4.29.5 When any building is occupied, any mark or sign referred to in 4.29.1 which is not of the illuminated type, shall be illuminated to an intensity of not less than 50 lx. Internally illuminated signs shall comply with the luminance requirements of SANS 1186-3. Photoluminescent signs shall comply with the luminance requirements of SANS 1186-5. In the case of occupancies classified as

A1, A2, E1, E2, E3, or in any building normally occupied during the hours of darkness, such marks or signs shall, in the event of the failure of the normal mains supply, be so illuminated for not less than the time required for the structural stability requirements as given in table 6. The emergency power supply to the lighting of such marks or signs shall be protected against the effects of fire for a period of not less than the time required for the structural stability requirements given in table 6.

4.29.6 The local authority may, where deemed necessary for the safety of occupants, require the provision of signs prohibiting exit.

NOTE The signs given in SANS 1186-1 indicate direction of travel and thus have certain limitations with regard to where they can be used logically. In any escape route, the "running man" sign is satisfactory when used on the walls of a corridor, but could be misleading when used on a surface at 90° to the escape route. Where for information purposes it is essential to use it in this way, such sign should be closely followed by confirmatory signs placed on the walls in the direction of travel, in positions where they can be easily seen in conjunction with the original sign. In the opposite case, where it is desired to indicate a change in the direction of travel, the sign should be placed across rather than along the direction of travel. Where such a sign is used to indicate the access door to an emergency route, the confirmatory signs should take the form of two of the "running man" symbols facing each other and placed on either side of the access door. (See also SANS 10114-2.)

4.30 Provision of emergency lighting

4.30.1 Any escape route shall be provided with artificial lighting and, at any time when the building containing such route is occupied, there shall be a minimum average illuminance of 50 lx on a horizontal plane 100 mm above the floor. Such lighting shall also be provided above the final exit door where such door is at the discharge of a stairway or leads to stairs outside the building.

4.30.2 In any building that has emergency routes, a number of emergency light sources shall be installed along the escape routes. The light sources shall be connected to an emergency power supply that is

- a) independent of the mains supply, and
- b) capable, in the event of any failure of the lighting specified in 4.30.1, of providing power supply to such emergency light sources for not less than the periods given in table 6.

4.30.3 Emergency light sources, the minimum emergency lighting levels on the escape routes and the emergency lighting design shall comply with the relevant requirements of SANS 10114-2 and SANS 1464-22.

4.30.4 An escape route in a basement or in any occupancy classified as A1, A2, A3, A4, C1, C2, E2, E3, F1, F3 or H1, shall be provided with emergency lighting as specified in 4.30.2, provided that, in any occupancy classified as A3 that has a population of less than 50 persons, such escape route shall not be required to be provided with such lighting.

4.31 Fire detection and alarm systems

4.31.1 Any building containing an occupancy classified as

- a) F1, with a floor area of more than 500 m²; or
- b) H1, H2, E2 or E3, irrespective of height or floor area,

shall be equipped with a fire detection system and alarm system that is designed, installed and maintained by competent persons in accordance with SANS 10139.

NOTE 1 The term 'fire detection system' is used here to describe any type of automatic sensor network and associated control and indicating equipment. Sensors may be sensitive to smoke, heat, gaseous combustion

SANS 10400-T:2011

Edition 3

products or radiation. Normally the control and indicating equipment operates a fire alarm system and it may perform other signalling or control functions as well. Automatic sprinkler systems can also be used to operate a fire alarm system.

NOTE 2 The factors which have to be considered when assessing what standard of fire alarm, automatic fire detection or voice alarm or communication system is to be provided will vary from one set of premises to another. Therefore, the appropriate standard will need to be considered on a case by case basis.

4.31.2 All occupied areas within a building that exceeds 30 m in building height or contains any storey exceeding 5 000 m² in floor area, other than a building contemplated in 4.31.1, shall be equipped with a category M and a category L fire detection system, and an alarm system designed, installed and maintained by competent persons in accordance with SANS 10139.

4.31.3 Any occupancy classified as A1, A2, C1, C2 or F1 shall have a manually activated visual and audible alarm system that is designed, installed and maintained by competent persons in accordance with SANS 10139.

4.32 Provision and maintenance of fire-fighting equipment, installations and fire protection systems

4.32.1 Any fire-fighting equipment, installations and fire protection systems in any building shall be so installed and maintained as to be ready for their purpose at all times.

4.32.2 The disposition of such fire-fighting equipment shall be clearly visible at all times or shall be indicated by symbolic signs which shall be visible at all times and comply with the requirements in SANS 1186-1.

4.32.3 Such fire equipment shall be so installed that it facilitates maintenance. Where compartments are created to house this equipment, they should not impede maintenance.

4.33 Water reticulation for fire-fighting purposes

Water installations, which convey water solely for fire-fighting purposes, shall be in accordance with SANS 10400-W.

4.34 Hose reels

4.34.1 Hose reels for the purposes of fire fighting shall be installed in any building of two or more storeys in height or in any single-storey building of more than 250 m² in floor area, at a rate of one hose reel for every 500 m² or part thereof of floor area in any storey, provided that such hose reels shall not be required in any building classified as H4 or in any dwelling unit in an occupancy classified as H3 where each unit is provided with independent access to ground level.

4.34.2 Any hose reel installed in such building shall comply with the requirements in SANS 543, shall be installed in accordance with SANS 10105-1 and SANS 10400-W, and shall be maintained in accordance with the requirements in SANS 1475-2.

4.34.3 Any hose reel so installed shall be positioned to ensure that the end of the hose will reach any point in the area to be protected.

4.34.4 Any hose reel installed in any building shall bear, in a prominent position on the reel disc facing the user, a certification mark from an accredited certification body.

4.34.5 Where no water supply is available, two 9 kg or equivalent fire extinguishers that comply with the requirements of 4.37 shall be provided in place of each required hose reel.

4.35 Hydrants

4.35.1 Hydrants in positions subject to direction by the local authority shall be provided in

- a) any building that exceeds 12 m in height, and
- b) any building (excluding buildings classified as H4) of any height with a total floor area that exceeds 1 000 m².

4.35.2 Any hydrant required in terms of 4.35.1 shall be provided at a rate of not fewer than one per 1 000 m² or part thereof of total floor area and not fewer than one per storey located in the firemen's lift lobby in such building or occupancy, or emergency stairway where no firemen's lift is provided, as the case might be, and shall be distributed in such a manner that the fire hose referred to in **4.35.3** can reach to every part of the relevant area.

4.35.3 Any hydrant shall, where required by the local authority, be provided with an appropriate fire hose of 24 m or 30 m in length, together with couplings and a 16 mm internal diameter nozzle, all of which shall comply with the requirements of SANS 1128-2. Such hose and nozzle shall, when positioned in the open air or in any factory building, be suitably housed in a cupboard, provided that this requirement shall not apply in any occupancy classified as J4.

4.35.4 In any industrial park, permanent amusement park or exhibition ground, shopping centre or group housing, cluster housing, or townhouse complex there shall be installed ground or raised hydrants so placed that no point in such amusement park or exhibition ground or shopping centre or in any building in such housing complex shall be at a distance greater than 90 m from any hydrant.

4.35.5 A hydrant shall comply with the requirements of SANS 1128-1.

4.36 Automatic sprinkler and other fixed extinguishing systems

4.36.1 In addition to the requirements in 4.4, 4.26.1(b) and 4.42, a fixed automatic fire-fighting system that is designed, installed and maintained by competent persons in accordance with SANS 306-4, SANS 10287, or SANS 14520-1, as appropriate, shall be provided

- a) in any building that exceeds 30 m in height, except where such building is exclusively of an occupancy classified as G1 or H3 where the division size is not greater than 500 m², and
- b) in any basement storey which exceeds 500 m² in floor area.

4.36.2 Where a building is required to have a sprinkler system, any concealed space, such as a floor void, ceiling void or roof void, which has a total height that exceeds 800 mm and a total area of compartment of more than 100 m² above any ceiling or a total area of compartment of more than 500 m² below any raised floor, shall be equipped with a sprinkler system.

NOTE Cognizance should be taken with regard to the interaction of different systems, e.g. smoke control, artificial ventilation, air-conditioning and detection systems.

4.37 Portable fire extinguishers

4.37.1 A building that contains an occupancy given in table 11 shall, for the relevant occupancy and floor area, be provided with portable fire extinguishers in unobstructed positions approved by the local authority.

SANS 10400-T:2011

Edition 3

4.37.2 A local authority may specify the type of portable fire extinguisher to be provided and may require that a number of fire extinguishers shall be installed in excess of the number indicated in table 11 if, in its opinion, any particular hazards or risks warrant such increase.

4.37.3 Portable fire extinguishers installed in a building shall comply with the requirements in SANS 1910, and shall be installed, maintained and serviced by competent persons in accordance with SANS 1475-1 and SANS 10105-1.

4.37.4 Such portable fire extinguishers shall bear a certification mark from an accredited certification body.

4.38 Mobile fire extinguishers

4.38.1 A fire extinguisher that exceeds the capacities prescribed in SANS 1910 or SANS 1151, as relevant, and that is fitted with wheels for transportation, shall be deemed to be a mobile fire extinguisher. Transportable, rechargeable fire extinguishers shall comply with the requirements of SANS 11601.

4.38.2 A mobile fire extinguisher may replace half the required portable fire extinguishers as given in table 11, provided that

- a) the capacity of any mobile fire extinguisher shall be at least equal to the combined capacity of the number of portable fire extinguishers it replaces,
- b) it contains the same extinguishing medium as required for such portable extinguishers,
- c) it replaces such portable extinguishers only on the floor and within the division concerned,
- d) the floor area to be served by it does not exceed 500 % of the area given in table 11 or 1 000 m², whichever is the lesser,
- e) the extinguishing medium complies with the appropriate requirements of SANS 1151 or SANS 1910, as relevant, and
- f) such mobile fire extinguisher is kept in a readily accessible position.

Table 11 — Provision of portable fire extinguishers

1	2	3	4	5	6
Class of occupancy	Number of portable fire extinguishers required ^a per m ²	Minimum charge ^b			
		Water	Foam	Carbon dioxide	Dry chemical powder
A1	1/200	9 L	9 L	5 kg	4,5 kg
A2	1/200	9 L	9 L	5 kg	4,5 kg
A3	1/200	9 L	9 L	5 kg	4,5 kg
A4	1/400	9 L	9 L	5 kg	4,5 kg
A5	1/400	9 L	9 L	5 kg	4,5 kg
B1	1/100	9 L	9 L	10 kg	9 kg
B2	1/200	9 L	9 L	10 kg	9 kg
B3	1/400	9 L	9 L	10 kg	9 kg
C1	1/200	9 L	9 L	10 kg	9 kg
C2	1/200	9 L	9 L	10 kg	9 kg
D1	1/100	9 L	9 L	10 kg	9 kg
D2	1/100	9 L	9 L	10 kg	9 kg
D3	1/200	9 L	9 L	10 kg	9 kg
D4	1/400	9 L	9 L	10 kg	9 kg
E1	1/200	9 L	9 L	5 kg	4,5 kg
E2	1/200	9 L	9 L	5 kg	4,5 kg
E3	1/200	9 L	9 L	5 kg	4,5 kg
E4	1/200	9 L	9 L	5 kg	4,5 kg
F1	1/200	9 L	9 L	5 kg	4,5 kg
F2	1/200	9 L	9 L	5 kg	4,5 kg
F3	1/200	9 L	9 L	5 kg	4,5 kg
G1	1/200	9 L	9 L	5 kg	4,5 kg
H1	1/200	9 L	9 L	5 kg	4,5 kg
H2	1/200	9 L	9 L	5 kg	4,5 kg
H3	1/400	9 L	9 L	5 kg	4,5 kg
H5	1/100	9 L	9 L	5 kg	4,5 kg
J1	1/100	9 L	9 L	10 kg	9 kg
J2	1/100	9 L	9 L	10 kg	9 kg
J3	1/400	9 L	9 L	10 kg	9 kg
J4	1/400	9 L	9 L	10 kg	9 kg

^a The owner shall install by extinguisher charge mass. If the required size of extinguisher required is 1 × 9 kg powder extinguisher per 200 m² as with a C2 occupancy, the owner of the building may install 2 × 4,5 kg extinguishers of the same type per 200m².

^b See SANS 1910 for required minimum performance ratings.

SANS 10400-T:2011

Edition 3

4.39 Fire-stopping of inaccessible concealed spaces

4.39.1 Where there is an inaccessible concealed space with a maximum dimension of more than 5 m in any building, such space shall

- a) be fire-stopped whether it contains combustible material or not,
- b) where it is within any non-combustible building element, be fire-stopped not less than every 5 m measured horizontally or vertically, provided that this requirement shall not apply to the cavity of a masonry cavity wall, and
- c) where it is within a combustible element, be fire-stopped not less than every 3 m measured in both directions.

4.39.2 The void under an access floor shall not be connected to any space in another division unless such connection is protected by a fire door, fire shutter or fire damper that has the same fire resistance as the division-separating element. Any void below a raised access floor shall be divided by fire stops into areas of not more than 500 m² or shall be protected by a fixed automatic fire-fighting system. Any such void used as an artificial ventilation plenum shall comply with the requirements of 4.43.5.

NOTE An inaccessible concealed space could be any space in a building to which there is no ready access. It could, for instance, include the space above a false ceiling or under a false floor or that behind panelling fixed to a wall. Since, by definition, the space is concealed, any fire starting in such space or reaching such space from elsewhere could spread rapidly without anyone being aware of it before it is fully developed. It is for this reason that it is important that fire stops should be provided at regular intervals in both the vertical and horizontal directions to prevent such spread.

4.40 Protection in service shafts

4.40.1 The walls of an internal service shaft shall have a fire resistance of not less than the requirements for structural stability given in table 6, subject to a maximum requirement of 120 min.

4.40.2 Where a vertical service shaft provided in a building is not separated from the floors it serves by a separating element, and such shaft does not contain any combustible material, it shall be fire-stopped at the level of every second storey above the bottom of such shaft. Such fire stop shall have a fire resistance of not less than the requirements for structural stability given in table 6, subject to a maximum requirement of 120 min.

4.40.3 Where such a shaft is so provided and it contains any combustible material, it shall be fire-stopped at the level of every storey above the bottom of such shaft.

4.40.4 Where a vertical service shaft is used for ventilation or contains non-combustible plumbing or drainage services or is a non-combustible rubbish chute, no fire stop shall be required within such shaft, and the doors to such shafts shall be self-closing fire doors in accordance with the requirements of 4.10.

4.40.5 Where a service penetrates a separating element, such separating element shall be fire-stopped with a suitable system of the same rating of the element it passes through. Such system shall have a test report prepared in accordance with the requirements of SANS 10177-2 and shall be installed in accordance with the provisions relating thereto.

NOTE The proposed system should have a technical report for the intended application, installation instructions and certification on completion.

4.41 Services in structural or separating elements

4.41.1 A service pipe, conduit, duct, sleeve, cable or other equipment recessed into any structural or separating element which is required to have a fire resistance, shall be set into such element in such a manner that such fire resistance is not reduced to below the required fire resistance.

4.41.2 A service that penetrates through any wall or floor where such wall or floor is required to have a fire resistance, shall be sealed in such a manner that fire shall not penetrate such wall or floor. Such fire stop shall have a fire resistance of not less than the requirements for structural stability given in table 6, subject to a maximum requirement of 120 min.

4.42 Smoke control

4.42.1 Notwithstanding the requirements of SANS 10400-O, any room of which the floor area is more than 500 m² shall be provided with

- a) a system of mechanical or natural smoke ventilation designed in accordance with the relevant part of EN 12101; or
- b) in the case of a single-storey building or room that has a floor area of up to 2 500 m² and that is not fitted with a sprinkler protection system, roof ventilators or openable windows or panels to permit smoke ventilation and such roof ventilators or openable windows or panels shall
 - 1) have an aggregate area of not less than 3 % of the floor area of such room or, in the case of any single-storey building where such room has an occupancy classified as D2 or D3, not less than 1,5 % of the floor of such room,
 - 2) be located in the roof or in the upper third of the walls, as the case might be, and be distributed in such a way that smoke will be evenly extracted from all parts of the room,
 - 3) be designed to open automatically when activated by heat or smoke detectors, and
 - 4) be designed to maintain a clear layer of 2,5 m above the floor of the highest occupied level. This clear layer shall be maintained for the designed evacuation period or 600 s, whichever is the longer period;

provided that where such room is so situated that neither the roof space nor an external wall of the building form part of such room, such room shall be equipped with a system of mechanical smoke ventilation. Such mechanical ventilation shall be designed to provide a clear layer of 2,5 m above the floor of the highest occupied level.

Any building exceeding the parameters as given in 4.42.1(b) shall be provided with a smoke control system in accordance with 4.42.1(a).

4.42.2 Where openable panels are provided on any building elevation for the purposes of smoke ventilation, the position of such panels shall be suitably marked on the outside of the building to permit easy identification by the fire services.

4.42.3 In any smoke ventilation or heat ventilation system, the applicable equipment shall comply with the requirements of the relevant part of EN 12101.

NOTE Cognizance should be taken of the interaction between the sprinkler system and the detection system.

4.43 Air-conditioning systems and artificial ventilation systems

4.43.1 An air-conditioning system or artificial ventilation system in a building shall be so designed as to prevent the distribution of products of combustion in the event of a fire in such building.

4.43.2 An air shaft or duct used for air conditioning or artificial ventilation, including any internal or external insulation thereto and any flexible joint, shall be constructed of non-combustible material in accordance with SANS 10177-5, provided that

- a) combustible flexible connections may be used where the length of such connection does not exceed 1,5 m and such connection does not pass through any wall or floor which is required to have a specified fire resistance, and
- b) combustible flexible joints not more than 200 mm in length can be used in any plant room where such plant room is equipped with a smoke detection system, designed, installed and maintained by competent persons in accordance with SANS 10139.

4.43.3 A fire damper, which shall comply with the requirements of SANS 193, shall be provided in an air duct in any position where such duct passes through a required division or occupancy-separating element or any element required for the enclosure of an emergency route, or passes into any duct.

4.43.4 Any such fire damper shall

- a) close automatically upon the operation of a sensing device activated by the presence of smoke or heat in the air duct,
- b) be provided with access, the position of which shall be clearly marked, for inspection, maintenance and resetting of the mechanism,
- c) be so installed as to remain in position at the protected opening even if the air duct distorts during a fire,
- d) be provided with an overriding fusible or resettable link, and
- e) have the same fire resistance rating as the elements of construction through which it passes.

4.43.5 A plenum, the supports of which shall be non-combustible (excluding return-air intakes), that forms part of an air-conditioning system or artificial ventilation system, shall be constructed of non-combustible material or material which has been evaluated in accordance with SANS 10177-5. Where the sum of the areas of all air supply and return-air intake grilles in such plenum is not more than 5 % of the area of surface of such plenum exposed to the room below and no individual grille has an overall area of more than 0,09 m², such grilles may be of combustible material.

4.43.6 In any plenum system, the fire stops, as described in 4.12.1.6 and 4.13.2, shall be non-combustible and shall seal or close automatically upon the operation of sensing devices, or be activated when the temperature of the air in such space reaches 15 °C above its design temperature or 45 °C, whichever is the lesser.

4.43.7 No plenum system shall be used for storage or for the accommodation of persons.

4.43.8 Where the air-conditioning system or ventilation system constitutes the whole, or part of a smoke control system, the installation shall comply with the requirements for smoke control as given in 4.42.

4.44 Lift shafts

4.44.1 Any building of more than four storeys above or below the level of escape doors shall have at least one lift, accessible from all the floors.

4.44.2 In a building of more than 10 m in height, where a lift or bank of lifts is not provided with a lobby (see 4.44.4), the lift doors shall be fire rated with a stability and integrity rating of not less than 120 min and shall be sealed against the ingress of smoke for a minimum of 30 min.

4.44.3 A lift or bank of lifts shall have doors which

- a) have all edges fitted with flexible seals to prevent the passage of smoke and air when in the closed position, and
- b) have, when tested in accordance with SANS 1253, the stability and integrity of not less than 30 min.

This shall be 60 min where, in terms of table 6, a 120 min separation is required.

4.44.4 In a building of more than three storeys, where the lift or bank of lifts is not in compliance with the requirements of 4.44.2, such lift or bank of lifts shall be provided with a lobby which shall have a stability and integrity rating of not less than 30 min and shall be arranged to prevent the exit of smoke into the lift shaft(s) for a minimum of 30 min. The doors to such lobby shall have self-closing mechanisms to automatically close such doors after being opened. If double doors are used, a selector mechanism shall be installed to ensure the correct meshing of any rebate on the meeting styles.

4.44.5 A lift shaft shall have a fire resistance of not less than the requirements for structural stability given in table 6, subject to a maximum requirement of 120 min, and shall be so designed that not more than four lifts are accommodated in any one subdivision of such shaft, and when the lift motor is housed in a lift motor room, the lift motor room shall be similarly separated.

4.44.6 Where, on any storey of a building, a lift in a bank of lifts discharges into a division different from that into which the other lifts discharge, such lift shall be accommodated in a separate shaft or be provided with fire rated doors or a fire rated lobby in accordance with the relevant requirements of 4.44.2 and 4.43.4.

4.45 Lifts

4.45.1 No decorative finish or floor covering of lifts shall have a fire index of more than 2 when tested in accordance with SANS 10177-3 or SANS 10177-4.

4.45.2 In any building, the controls of any lift shall be so designed that, in the event of fire, such lift shall be brought automatically to the main entrance storey without stopping and shall remain there with its doors open.

4.45.3 The requirements of 4.45.2 shall not apply to any building with an occupancy classification of H3 and that is less than 30 m in height, and where each dwelling unit's exit door fronts onto a common passage that is open to atmosphere and freely ventilated, or to any building classified as H4.

4.46 Firemen's lift

4.46.1 In a building that exceeds 30 m in height or that is more than 12,5 m below the level of escape, at least one firemen's lift shall be provided to serve all storeys.

SANS 10400-T:2011

Edition 3

4.46.2 The firemen's lift shall be in a separate shaft and be controlled by a separate plant room that has a fire resistance of not less than 120 min, and shall have on each level, a lobby separated from any other lobby or space by walls and doors which shall have a fire resistance of not less than 120 min. If double doors are used, these shall be provided with a mechanism to ensure correct sequencing of the door leaves to mesh the rebates. The firemen's lift shall be provided with a pressurization system to the lobby and the lift's shaft to exclude smoke, as described in 4.42.1(a) and 4.42.3.

4.46.3 The firemen's lift shall

- a) have internal dimensions of not less than 1 100 mm wide by 2 100 mm deep and have a clear door width of not less than 800 mm,
- b) be clearly identified as a firemen's lift on every storey,
- c) be capable of being stopped at any storey and have access to all such storeys,
- d) be kept available for use at all times,
- e) be subject to independent control during an emergency,
- f) continue to be workable during an emergency when all other lifts have been brought to the main entrance storey as described in 4.45,
- g) be provided with a source of emergency power which will enable such lift to operate together with its lights and extraction fan for not less than 120 min in the event of failure of the mains supply,
- h) be provided with means of oral communication to a control point or to a control room where such a room is provided,
- i) have doors that open into the lobby and be provided with door closers that are designed to facilitate entrance by a person seated in a wheelchair, and
- j) be designed and equipped in such a way that provision is made for the lift to be lowered, by alternative means, in a controlled manner to ground in the event of failure of emergency power.

4.47 Stretcher lift

4.47.1 Where a building is provided with a lift in terms of 4.45, at least one such lift shall have internal dimensions of 1 100 mm wide by 2 100 mm deep to accommodate a stretcher.

4.47.2 The entrance to a stretcher lift shall be not less than 800 mm in width.

4.47.3 Where such building exceeds 30 m in height, the power supply to the motor operating such stretcher lift shall be protected against the effects of fire for at least 120 min and be designed and equipped in such a way that provision is made for the lift to be lowered, by alternative means, in a controlled manner to ground in the event of a power failure.

4.48 Stage and backstage areas

4.48.1 The requirements in 4.48.2 to 4.48.7 shall apply to any stage or backstage area, including any area beneath a stage that communicates directly with such stage, in a theatre or other occupancy in which plays, operas or other productions necessitating the use of scenery take place.

4.48.2 Subject to the requirements in 4.48.3, any area referred to in 4.48.1 shall be separated from a dressing room, auditorium, workshops, stores or any other area within the occupancy, by walls

and floors which shall have a fire resistance of not less than 120 min, and any opening, other than the proscenium opening, in such wall or floor shall be protected by a class B fire door or fire shutter. No dressing room shall be at a level lower than the first basement storey.

4.48.3 A proscenium opening shall be protected by a fire curtain which shall be

- a) of non-combustible material with a fire resistance of not less than 120 min,
- b) constructed to slide freely in non-combustible guide rails, with a fire resistance of not less than 120 min,
- c) so arranged that, when fully closed, it overlaps the proscenium wall on the stage side by not less than 450 mm at either side of such opening and 600 mm at the top, and is closed at the bottom onto the stage floor which, if of combustible material, shall be not more than 38 mm thick over a non-combustible slab or wall,
- d) so arranged that in the case of a fire it will descend automatically and close such opening,
- e) so arranged and controlled that it can descend completely within 30 s and be so regulated that the time taken for the last 2,5 m of its descent shall not be less than 5 s, and
- f) capable of being both manually activated and remotely operated by a rate of rise heat detection of between 8 °C/min and 10 °C/min, designed, installed and maintained by competent persons in accordance with SANS 10139.

4.48.4 In the case of a stage typical of that in any school (often part of a multi-purpose room, gymnasium or cafeteria), church hall, community centre or other similar places,

- a) with a stage area of less than 200 m²,
- b) with a room height of less than 10 m,
- c) with all adjacent areas, such as storerooms, dressing rooms, workshops and scene docks, separated from the stage area by a 60 min fire-resistant rated assembly, and
- d) with combustible hangings limited to a single main curtain, borders, legs, and a single backdrop which is not vertically retractable,

a heavy woollen or non-combustible fibre cloth curtain treated and maintained in accordance with 4.48.6(g) may be substituted for the fire curtain described in 4.48.3.

4.48.5 Any area referred to in 4.48.1 shall comply with the following requirements:

- a) any structure and any wall, partition, horizontal slab, roofing and ceiling material therein shall be of non-combustible material;
- b) any fitted decorative material therein shall be non-combustible; and
- c) any stage floor may be of timber where the supports of such timber floor are supported by a non-combustible floor slab.

4.48.6 In any area referred to in 4.48.1 the following means of fire protection shall be provided:

- a) An automatic sprinkler system, and an automatic drencher system designed, installed and maintained by competent persons in accordance with SANS 10287 shall be provided to the stage side of the fire curtain. Such sprinklers shall be provided throughout the stage and in dressing rooms, workshops, storerooms, and other accessory spaces contiguous to such stage, and the drencher shall protect the fire curtain.

SANS 10400-T:2011

Edition 3

- b) Exhibition halls, arenas, and coliseums shall be sprinkler protected throughout. The sprinkler system shall be designed, installed and maintained by competent persons in accordance with SANS 10287. Additionally, a smoke detection system designed, installed and maintained by competent persons in accordance with SANS 10139 shall be provided in the assembly seating area.

These requirements shall not apply to the following:

- 1) stages referred to in 4.48.4; and
 - 2) under-stage areas with a fire resistance of not less than 60 min, less than 1,2 m in clear height and used exclusively for the storage of chairs or tables.
- c) A system shall be provided to maintain the smoke level at not less than 2,5 m above the highest level of the assembly seating or above the top of the proscenium opening where the proscenium wall is provided. The system shall be activated independently by each of the following:
- 1) automatic activation by the sprinkler system in the stage area; or
 - 2) activation by a manually operated switch at a location approved by the local authority.

The emergency ventilation system shall be connected to both normal and standby power. The power wiring and ducts of the fan(s) shall be located and protected to assure a minimum of 20 min of operation in the event of activation.

Two or more roof vents shall be located near the centre of and above the highest part of the stage area. They shall be raised above the roof and provide a net-free roof vent area equal to 5 % of the stage area. Roof vents shall be constructed to open automatically by suitable heat-activated devices. Supplemental means shall be provided for manual operation of the roof ventilators from the stage floor.

Ventilation shall be provided in all areas not separated from the stage area by a 60 min fire resistance rated assembly where the stage area exceeds 200 m² but is less than 10 m in height.

Means and procedures for periodic testing and maintenance of this equipment shall be included in the operation manual of the building.

- d) Where the mechanical ventilation system is designed to fail in the operating position (open), no emergency power will be required.
- e) A direct communication with the local authority's fire services.
- f) Manual alarms, designed, installed and maintained by competent persons in accordance with SANS 10139, and that are in the backstage area in easily accessible positions.
- g) Curtains, drapes and similar decorative materials used on stages shall be constructed of flame-retardant materials or treated with a suitable flame-retardant solution or process. Flame-retardant treatments shall be renewed to maintain their effect in accordance with the manufacturers' documentation or at least once every five years.

4.48.7 Any dressing room area shall have direct access to an emergency route.

4.49 Seating arrangements in auditoriums or halls and on grandstands

4.49.1 In an auditorium or hall or on a grandstand containing seating,

- a) the seating and aisles serving such seating shall be so arranged as to allow unobstructed movement to the escape routes from such auditorium, hall or grandstand,

- b) notwithstanding the requirements in 4.16, no seat shall be more than 21 m from a feeder route, access door to an emergency route, or an escape door as measured along the route that a person occupying such seat might be expected to travel, and
- c) all calculations done shall take into consideration the applicable requirements of SANS 10400-S.

4.49.2 On a grandstand or in an auditorium or hall not used for more than one purpose, all seating shall be fixed to the building. Such seating need not be so fixed in any auditorium or hall, or a box therein, that accommodates not more than 25 persons.

4.49.3 Notwithstanding the requirements given in 4.20,

- a) Clearance between rows of seats means the distance as measured between plumb lines from the rearmost part of any seat to the nearest part, including armrests if any, of the seat behind it. In the case of gravity-operated automatic tip-up seats, such distance may be measured with the seats in the tipped-up position.
- b) Where individual seats are not provided, every 450 mm of seating shall be deemed to be a seat.
- c) The clearance between rows of seats in an auditorium or hall shall be not less than
 - 1) 300 mm where a person is not required to pass more than 14 seats to leave the row,
 - 2) 400 mm where a person is required to pass more than 14 seats but not more than 24 seats to leave the row, or
 - 3) 500 mm where any person is required to pass more than 24 seats to leave the row.
- d) The clearance between rows of seats with backrests in outdoor grandstands shall be not less than
 - 1) 300 mm where a person is required to pass not more than 20 seats to leave the row,
 - 2) 400 mm where a person is required to pass more than 20 seats but not more than 40 seats to leave the row, or
 - 3) 500 mm where a person is required to pass more than 40 seats to leave the row, and
 - 4) where backrests are not provided, or on terraced seating, 675 mm from the front edge of any seat to the front edge of the seat immediately in front or behind such seat.

4.49.4 An aisle in an auditorium, hall or grandstand shall have a clear width of not less than 1,1 m or such greater width as required for an emergency route in terms of 4.21 for the population served. The surface of the floor of any steps in such aisle shall be rendered suitably slip resistant and shall at all times be maintained in such slip-resistant condition. A cross-aisle shall discharge at both ends directly into an emergency route.

4.49.5 The gradient of an aisle which is not level shall not exceed 1 in 8 and a stepped aisle shall not exceed an overall gradient of 1 in 3. Steps along an aisle shall be the full width of such aisle and shall be illuminated to not less than 2 lx at tread level when normal lighting has been lowered. The steps shall have uniform tread widths and risers so designed as to reduce the likelihood of any person stumbling.

4.49.6 Where an aisle crosses parallel to the rows of seats and the floor level of such aisle is higher than the adjacent floor level of any row of seats, the edge of the aisle shall be provided with railings not less than 800 mm in height above the floor level of the row immediately behind such aisle. Where the floor level of any row of seats is higher than the floor level of an adjacent cross-

SANS 10400-T:2011

Edition 3

aisle, the edge of the floor level of such row shall likewise be provided, at the relevant clearance given in 4.49.3, with railings in front of all such seats. The railings shall be not less than 800 mm in height above floor level of such row of seats.

4.49.7 An exit door from any auditorium or hall shall be provided with panic bolts approved by the local authority, and at no time during occupancy of such auditorium or hall by the public shall such door be locked, obscured, obstructed, covered or hidden.

4.49.8 The floor covering in an auditorium or hall shall be securely fixed and maintained in a safe condition.

4.49.9 A standby system for uninterrupted emergency lighting independent of the normal mains supply shall be provided in any theatre complex or individual auditorium, hall or grandstand, in order to afford a level of illumination in accordance with the provisions of SANS 10114-2 to enable persons to leave all parts of such theatre complex, auditorium, hall or grandstand in the event of failure of the normal mains supply. This requirement shall not apply in the case of any hall referred to in 4.48.4.

4.49.10 The power supply to such emergency lighting shall be safeguarded against the effects of a fire for at least 30 min.

4.50 Parking garages

The floor of any occupancy classified as J4 shall be of non-combustible material and shall be not less than 10 mm lower than the threshold of any door leading to any adjoining room or space.

4.51 Operating theatres and intensive, high or critical care units

Where a suite of rooms in any building is used for the purposes of operating theatres, maternity delivery rooms or intensive, high or critical care units, such area shall comply with the following requirements:

- a) The walls, floor and roof separating such suite from any other suite or from any other part of the building shall have a fire resistance of not less than 120 min.
- b) There shall be not fewer than two means of exit from such suite.
- c) Such suite shall be provided with an emergency power supply independent of the normal mains supply and capable of operating for not less than 120 min in the event of failure of the mains supply.
- d) A lift used for the transport of patients from such suite shall be provided with an emergency power supply independent of the normal mains supply and capable of operating for not less than 120 min in the event of failure of the mains supply.
- e) At any level below the level of the suite, the lift referred to in (d) shall have a lobby with a fire resistance rating at least equal to that of the suite.

4.52 Installation of liquid fuel dispensing pumps and tanks

4.52.1 No liquid fuel dispensing pump or storage tank shall be situated less than 3,5 m from any lateral boundary or street boundary of any site except where there is a boundary wall and such wall

- a) has a fire resistance of 120 min,
- b) is not less than 1,8 m in height, and
- c) extends not less than 2 m on either side of such pump.

No part of such tank shall be within 500 mm of any building except in the case of a tank covered by 4.53.1.3. No such tank shall be situated within 500 mm of any other tank except where each tank is located in its own concrete-lined pit.

4.52.2 No part of a building, other than a canopy or similar protection to which the occupants of such building do not have access, shall be erected over a dispensing pump or tank unless

- a) the underside of such part is at least 3,5 m above ground level,
- b) such part has a fire resistance of at least 240 min and extends at least 2 m in every direction beyond the sides of the dispensing pump or tank concerned, and
- c) the floor below the dispensing pump, where such dispensing pump is erected over a basement storey, has a fire resistance of at least 240 min and extends at least 2 m in every direction beyond the sides of the dispensing pump or tank concerned.

4.52.3 A liquid fuel dispensing pump that might be approached by a vehicle, shall be erected on a raised plinth not less than 150 mm above the surrounding ground level. Such plinth shall extend not less than 300 mm beyond the perimeter of the base of such dispenser.

4.52.4 Such tank and associated equipment shall be constructed and installed under the direction of a competent person in accordance with SANS 10089-3 and SANS 10131.

4.52.5 The filler pipe of any fuel tank shall be positioned in a masonry-lined or concrete-lined chamber not less than 300 mm deep and such pipe shall be clearly identified to indicate its purpose.

4.52.6 No fuel tank shall have more than one filler pipe, one ventilating pipe and one dipping hole pipe, and such filler pipe and dipping hole pipe shall extend to as near to the bottom of the tank as is practicable.

4.53 Installation of other tanks

4.53.1 General

4.53.1.1 Where on any site liquid petroleum gas is stored in bulk in any vessel which has a water capacity in excess of 500 L, the design, erection and protection of such storage facilities shall be undertaken by a competent person in accordance with SANS 10087-3.

4.53.1.2 Where any small container is being filled with liquid petroleum gas on any site, the location, design and control of the area on such site in which such filling is carried out shall be strictly in accordance with SANS 10087-3 and SANS 10087-7 and the filling of vehicles shall comply with SANS 10087-2 and SANS 10087-10.

4.53.1.3 In the case of a tank installed in any building and intended to contain diesel fuel, such installation shall be undertaken under the direction of a competent person in accordance with SANS 10131. Such tank shall not be installed on any storey above the ground storey of a building.

4.53.2 Warehousing of dangerous goods

Dangerous goods shall be warehoused in accordance with SANS 10263-0.

4.53.3 Dangerous goods signage

Signage for dangerous goods shall be in accordance with SANS 10263-0.

SANS 10400-T:2011

Edition 3

4.54 Access for fire-fighting and rescue purposes

4.54.1 No building shall be erected on a site unless such site is provided with access for the purposes of fire fighting and rescue from such building by the fire services of the local authority.

4.54.2 All buildings shall be provided with access to their interior for rescue and fire-fighting purposes by such services.

4.54.3 The requirements of 4.54.2 shall not apply to any portion of a building which is to be used for the purposes of a normally unoccupied strong room, record room or security vault.

4.54.4 Any escape door shall be clearly identified from the exterior of the building.

4.54.5 The number of each storey shall be indicated inside an emergency route on any access door.

4.55 Presumed fire resistance of building materials and components

4.55.1 The building materials and components covered by tables 12 to 16 shall be deemed to comply with the performance requirements under fire conditions, provided that such materials and components conform to the relevant detailed descriptions given in the tables. Where materials are not listed, a currently valid test report to an internationally accepted test method or to the relevant part of SANS 10177 shall be provided, or they shall be the subject of a rational assessment by a competent person.

4.55.2 A monolithic unreinforced concrete element or concrete masonry constructed of solid concrete masonry units in accordance with the requirements of SANS 10145 shall be considered to be a solid concrete unit and shall be deemed to have the fire resistance given in table 12.

NOTE Only building materials, components and methods of construction for which sufficient test data are available are listed in tables 12 to 18. The tables will be updated, where necessary, when new evidence on performance becomes available.

4.55.3 Where concrete structural elements and components are constructed in accordance with the relevant requirements contained in SANS 10100-1, such elements and components may be presumed to have a fire resistance related to such construction as given in the tables of SANS 10100-1.

Table 12 — Fire resistance of structural walls

1	2	3	4	5	6
Construction and materials	Fire resistance min				
	240	120	90	60	30
	Minimum thickness, excluding plaster mm				
Solid construction clay masonry units:					
unplastered	190	110	90	90	90
plastered ^a	150	90	90	90	90
NOTE 1 For concrete masonry construction, see SANS 10145.					
NOTE 2 The values given above refer to the thickness of masonry units of commonly available sizes and do not include any allowance for plaster. Therefore, in column 2, it will be seen that a wall made of units of 190 mm thickness in the unplastered condition will give a fire resistance of 240 min. The next lower size has a thickness of 150 mm, but this is not adequate on its own to give a fire resistance of 240 min. However, when the wall is plastered on both sides (with a normal plaster thickness of at least 12 mm), it is possible to attain a fire resistance of 240 min. Similarly, with reference to column 3, units of 110 mm thickness will give a resistance of 120 min or more, but units of thickness 90 mm will not provide this resistance. When plastered, however, the 90 mm units are capable of providing a fire resistance of 120 min. For the lower values of fire resistance, there is no advantage in plastering a wall as the unplastered unit is capable of providing the required resistance.					
^a Plaster shall be in accordance with the requirements of SANS 2001-EM1 and shall be applied to both faces of the wall.					

Table 13 — Fire resistance of non-structural walls and partitions

1	2	3	4	5	6
Construction and materials	Fire resistance min				
	240	120	90	60	30
	Minimum thickness, excluding plaster mm				
Solid construction clay masonry units:					
unplastered	190	110	90	90	75
plastered	150	90	90	75	75
Solid concrete units:					
Class 1 aggregates					
unplastered	150	90	75	75	75
Class 2 aggregates					
unplastered	215	150	90	75	75
NOTE 1 For concrete masonry construction using hollow masonry units, see SANS 10145.					
NOTE 2 The values given above refer to the thickness of masonry units of commonly available sizes and do not include any allowance for plaster. Therefore, in column 2, it will be seen that a wall made of units of 190 mm thickness in the unplastered condition will give a fire resistance of 240 min. The next lower size has a thickness of 150 mm, but this is not adequate on its own to give a fire resistance of 240 min. However, when the wall is plastered on both sides (with a normal plaster thickness of at least 12 mm), it is possible to attain a fire resistance of 240 min. Similarly, with reference to column 3, units of 110 mm thickness will give a resistance of 120 min or more, but units of thickness 90 mm will not provide this resistance. When plastered, however, the 90 mm units are capable of providing a fire resistance of 120 min. For the lower values of fire resistance, there is no advantage in plastering a wall as the unplastered unit is capable of providing the required resistance.					

Table 14 — Fire resistance of hollow stud construction of steel and timber studs

1	2	3	4	5	6	7	8	9	10
Type of wall	Type of stud	Stud spacing mm	Size of stud mm	Cladding thickness ^a mm					
				9,9 or 9,5	12,0 or 12,5	2 × 9,0 or 2 × 9,5	9,0 + 12,0 or 9,5 + 12,5	2 × 12,0 or 2 × 12,5	12,0 ^b or 12,5 ^b
				Fire resistance min					
Gypsum plasterboard: non-structural	Steel	400	50 × 30	c	30	60	60	60	c
			63,5 × 30	c	30	60	60	60	
	Timber	600	50 × 30	c	30	c	c	60	c
58 × 30 63,5 × 30			c	30 20	c	c	60 c	c c	
Gypsum plasterboard: structural	Timber	400	114 × 38	c	c	30	c	30	c
		600	114 × 38	c	c	c	c	30	30
Fibre-cement boards (unpressed): non-structural	Steel	400	58 × 30	20	30	c	c	c	c
			63,5 × 30	30	c	c	c	c	c
	Timber	600	58 × 30	20	20	c	c	c	c
			63,5 × 30	30	c	c	c	c	c
Timber	400	75 × 38	30	30	c	c	c	c	
		600	75 × 38	c	30	c	30	c	c

NOTE 1 Screw spacing for each layer of cladding should not exceed 220 mm.
NOTE 2 Joints of such layers should be staggered.
NOTE 3 Boards should be horizontal.
NOTE 4 Cavities should be filled with mineral wool.

^a Same thickness or combination of thicknesses – face and reverse side.
^b Glass fibre reinforced gypsum boards.
^c This combination has not been tested.

Table 15 — Fire resistance of structural steel columns
(mass of steel not less than 45 kg/m)

1	2	3	4	5	6	7
Construction and materials	Fire resistance					
	min					
	240	180	120	90	60	30
	Minimum thickness of protection					
	mm					
Solid protection ^a						
1. Reinforced concrete strength of not less than 25 MPa with natural aggregates –						
a) concrete not assumed to be structural	50	38	25	25	25	25
b) concrete assumed to be structural	75	50	50	50	50	50
2. Solid masonry units of clay or sand-lime	75	50	50	50	50	50
3. Solid blocks of foamed slag or pumice concrete reinforced in every second horizontal joint	62	62	50	50	50	50
4. Sprayed vermiculite-cement or perlite-cement	–	–	38	32	20	12,5
Hollow protection ^b						
1. Solid masonry units of clay or sand-lime reinforced in every fourth horizontal joint, unplastered	100	75	50	50	50	50
2. Solid blocks of foamed slag or pumice concrete reinforced ^c in every second horizontal joint	75	62	50	50	50	50
3. Metal lath with gypsum or cement-lime plaster	–	–	45	30	20	12,5
4. Metal lath with vermiculite-gypsum or perlite-gypsum plaster	85	65	38	25	18	12,5
5. Metal lath spaced 25 mm from flanges with vermiculite-gypsum or perlite-gypsum plaster	65	24	25	18	12,5	12,5
^a Solid protection means a casing which is bedded close up to the steel without intervening cavities and with all joints in that casing made full and solid.						
^b Hollow protection means that there is a void between the protective material and the steel. All hollow protection to columns shall be effectively sealed at each floor level.						
^c Where reinforcement is required, it shall consist of steel binding wire not less than 2,3 mm in thickness, or a steel mesh weighing not less than 0,48 kg/m ² . In concrete protection, the spacing of that reinforcement shall not exceed 150 mm in any direction.						

Table 15 (concluded)

1	2	3	4	5	6	7
Construction and materials	Fire resistance min					
	240	180	120	90	60	30
	Minimum thickness of protection mm					
Hollow protection ^b (concluded)						
6. Gypsum plasterboard with 1,6 mm wire binding at 100 mm pitch –						
a) 9,5 mm plasterboard with vermiculite-gypsum plaster of thickness	–	–	16	12,5	10	7
b) 19 mm plasterboard with vermiculite-gypsum plaster of thickness	32 ^d	19	10	10	7	7
7. Metal lath with sprayed fibre-cement of thickness	85	65	38	25	12,5	10
8. Vermiculite-cement or perlite-cement slabs of 4:1 mix reinforced with wire mesh adequately fixed to the column and finished with plaster skim	–	–	25	25	–	–
^a Solid protection means a casing which is bedded close up to the steel without intervening cavities and with all joints in that casing made full and solid.						
^b Hollow protection means that there is a void between the protective material and the steel. All hollow protection to columns shall be effectively sealed at each floor level.						
^c Where reinforcement is required, it shall consist of steel binding wire not less than 2,3 mm in thickness, or a steel mesh weighing not less than 0,48 kg/m ² . In concrete protection, the spacing of that reinforcement shall not exceed 150 mm in any direction.						
^d Light mesh reinforcement is required 12,5 mm to 19 mm below the surface.						

Table 16 — Fire resistance of structural steel beams
(mass of steel not less than 30 kg/m)

1	2	3	4	5	6	7
Construction and materials	Fire resistance					
	min					
	240	180	120	90	60	30
	Minimum thickness of protection					
	mm					
Solid protection^a						
1. Reinforced concrete strength not less than 25 MPa with natural aggregates						
a) concrete not assumed to be structural	63	50	25	25	25	25
b) concrete assumed to be structural	75	50	50	50	50	25
2. Sprayed fibre-cement (density of 140 kg/m ³ to 240 kg/m ³)	44 ^b	32 ^b	19	19	10	10
3. Sprayed vermiculite-cement or perlite-cement	–	–	38	32	20	12,5
Hollow protection^c						
1. Metal lath						
a) with cement-lime plaster	–	–	38 ^b	25	19	12,5
b) with gypsum plaster	–	–	22	19	16	12,5
c) with vermiculite-gypsum or perlite-gypsum plaster	32 ^b	19	12,5	12,5	12,5	12,5
2. Metal lath with sprayed fibre-cement (density of 140 kg/m ³ to 240 kg/m ³)	85	65	38	25	12,5	10
NOTE The use of asbestos is prohibited in the Republic of South Africa.						
^a Solid protection means a casing which is bedded close up to the steel without intervening cavities and with all joints in that casing made full and solid.						
^b Light mesh reinforcement is required 12,5 mm to 19 mm below the surface.						
^c Hollow protection means that there is a void between the protective material and the steel. All hollow protection to columns shall be effectively sealed at each floor level.						

SANS 10400-T:2011

Edition 3

4.56 Building materials

4.56.1 General

The building materials listed in 4.56.2 shall, singly or in combination with each other, comply with the requirements for non-combustibility as prescribed in SANS 10177-5. Any addition of organic or other combustible material might render the listed material combustible in terms of SANS 10177-5. Materials not listed are presumed to be combustible except where proved otherwise when tested in accordance with SANS 10177-5.

4.56.2 Non-combustible building materials

The following building materials are deemed to be non-combustible:

- a) aluminium (extrusions or castings);
- b) fibre cement (excluding products containing asbestos);
- c) fibre-cement products with less than 7,5 % combustible additives;
- d) brass;
- e) masonry units (burnt clay, lime/sand, cement/sand);
- f) common cement (that complies with SANS 50197-1);
- g) clay (burnt or unburnt);
- h) concrete;
- i) furnace slag;
- j) glass;
- k) glass fibres (spun, woven or wool, with less than 5 % resin content);
- l) gypsum (with less than 7,5 % paper or other combustibles);
- m) lime;
- n) metals (other than the alkaline metals);
- o) mineral wool (with less than 5 % resin content);
- p) mortar (lime, cement, gypsum);
- q) perlite;
- r) porcelain;
- s) pumice;
- t) sand;
- u) steel (cast or rolled);
- v) natural stone; and

w) vermiculite.

NOTE 1 The metals listed may only be considered to be non-combustible when in their solid form and not when in the form of a powder, shavings, etc.

NOTE 2 The percentages given are mass fractions.

NOTE 3 Non-combustible material does not imply a fire resistance.

4.56.3 Surface fire index of materials other than floors

Samples of finishing materials to be used shall be tested in accordance with SANS 10177-3 and the values obtained from such test shall be used to calculate the class of the finishing materials in accordance with the limiting values given in table 17. For a given class of material, the requirements given in columns 2, 3, 4 and 5 of table 17 shall be individually complied with.

Table 17 — Surface fire index of materials other than floors

1	2	3	4	5
Class	Maximum values			
	Spread of flame index	Heat contributed index	Smoke emitted index	Surface fire index
1	0,1	0,1	0,2	0,1
2	0,7	0,8	1,0	0,6
3	1,5	1,7	2,0	1,2
4	3,5	3,8	4,0	2,9
5	5,5	5,8	6,0	4,5

4.56.4 Fire index of floor coverings

Samples of coverings shall be tested in accordance with SANS 10177-4 and the values obtained from such test shall be used to calculate the class of the floor coverings in accordance with the limiting values given in table 18. For a given class of floor covering, the requirements given in columns 2, 3, 4 and 5 of table 18 shall be individually complied with.

Table 18 — Classification of floor coverings

1	2	3	4	5
Class	Maximum values			
	Spread of flame index	Heat contributed index	Smoke emitted index	Surface fire index
1	0,2	0,2	0,15	0,1
2	1,0	0,9	0,9	0,7
3	2,1	2,1	2,1	1,7
4	3,9	3,9	3,9	3,3
5	5,0	5,0	5,0	4,5

4.57 Single-storey category 1 buildings for H3 and H4 occupancies

4.57.1 The minimum distances from an external wall of attached and detached single-storey category 1 buildings for H3 and H4 occupancies to the lateral and rear boundary of the site shall not be less than

a) 0,0 m for walls with no openings and a fire resistance (stability, integrity and insulation) of at least 30 min;

SANS 10400-T:2011

Edition 3

- b) 0,5 m for walls with no openings, constructed with non-combustible external cladding and a surface area of not more than 7,5 m², where such walls have a fire resistance of less than 30 min but which, when tested, comply with the requirements for stability and integrity for a period of not less than 30 min;
- c) 1,0 m for walls as described in (b) but with a surface area greater than 7,5 m²;
- d) that given in table 19 for walls similar to those described in (a), (b) and (c) above, but with openings, provided that the openings in walls at right angles to the boundary are at least 500 mm away from the boundary; and
- e) 4,5 m where walls have combustible external cladding, or non-combustible external cladding which does not have a fire rating of 30 min for stability or integrity, the entire facade should be regarded as an opening and the minimum boundary should be at least as tabled in table 2, column 2 (low fire load).

Table 19 — Minimum boundary distances

1	2
Area of openings in elevation m ²	Minimum boundary distance m
< 5	1,0
5	1,5
7,5	2,0
10	2,4

4.57.2 Where the roof cladding is combustible, the distance from the boundary to the edge of the combustible material shall be in accordance with the requirements for combustible roofs, unless the roofing system is the subject of an Agrément certificate, in which case the assessed safety distances shall apply.

4.57.3 Detached single-storey category 1 buildings for H3 and H4 occupancies constructed with internal walls that do not have a 20 min fire resistance, shall have

- a) external doors located such that an occupant does not have to move through more than one room to reach an external door or escape routes; and
- b) boundary distances appropriate to the type of cladding used in the roofs and walls.

4.57.4 Attached single-storey category 1 buildings for H3 and H4 occupancies shall either have

- a) external walls with a fire resistance of 30 min (stability and integrity) and a separation wall between buildings extending to the underside of the roof covering with a fire resistance of 30 min (stability, integrity and insulation) of 30 min; or
- b) external walls of combustible material, or non-combustible walls with a fire resistance of less than 30 min, and a separation wall between buildings extending to the underside of the roof covering with a fire resistance of 30 min (stability, integrity and insulation of 30 min) with projections of at least 500 mm beyond the faces of external walls and above the roof.

4.58 Guest houses and bed and breakfast accommodation

A building that has a building occupancy classified as H5 shall, in addition to complying with all the relevant requirements for a building occupancy classified as H3 or H4 in this part of SANS 10400,

- a) have the direction of egress suitably marked and the sign posted in all passages and corridors in accordance with the relevant requirements of 4.29;

- b) be provided with suitable self-contained luminaires that actuate automatically, in all passages and corridors leading to an exit;
- c) be fitted with a suitable smoke alarm that complies with the requirements of the relevant part of EN 14064, and that is audible in all areas within the building, as follows:
 - 1) in each separate sleeping room;
 - 2) in any kitchen area;
 - 3) at a central point in a passage or corridor leading to one or more sleeping rooms;
- d) be provided with hose reels in accordance with the requirements of 4.34;
- e) have doors leading to the outside of the building fitted with locks that can be opened from the inside without any special tools, in the case of an emergency.

NOTE A suitable and approved emergency plan and evacuation route, which informs guests as to what action should be taken in the event of a fire, should be affixed to the back of every guest room door. Such a plan should include

- a) the action to be taken by the person discovering a fire;
- b) the action to be taken for evacuation of the building and assuring accountability of the occupants;
- c) the action to be taken pending the arrival of emergency services; and
- d) an evacuation floor plan that identifies exit doors and windows.

4.59 Health care facilities

A building that has a building occupancy classified as E4 shall, in addition to complying with all the relevant requirements for such a building occupancy in this part of SANS 10400,

- a) be provided with suitable self-contained luminaires that actuate automatically, in all passages and corridors leading to an exit;
- b) be fitted with a suitable smoke alarm that complies with the requirements of SANS 50054-7, and that is audible in all areas within the building, as follows:
 - 1) in each separate sleeping room;
 - 2) in any kitchen area;
 - 3) at a central point in a passage or corridor leading to one or more sleeping rooms;
- c) have doors leading to the outside of the building fitted with locks that can be opened from the inside without any special tools, in the case of an emergency.

NOTE A suitable and approved emergency plan and evacuation route, which informs patients and staff as to what action should be taken in the event of a fire, should be affixed to the back of every patient room door. Such a plan should include

- a) the action to be taken by the person discovering a fire;
- b) the action to be taken for evacuation of the building and assuring accountability of the occupants;
- c) the action to be taken pending the arrival of emergency services; and
- d) an evacuation floor plan that identifies exit doors and windows.

Annex A
(normative)

National Building Regulations
Part T: Fire Protection

Definitions

approval
approval by

- a) any local authority, including approval contemplated in section 7(7)(b) of the Act, or
- b) the Review Board on appeal to the Review Board in terms of the Act

Regulations

T1 General Requirement

- (1) Any building shall be so designed, constructed and equipped that in case of fire –
 - (a) the protection of occupants or users, including persons with disabilities, therein is ensured and that provision is made for the safe evacuation of such occupants or users;
 - (b) the spread and intensity of such fire within such building and the spread of fire to any other building will be minimized;
 - (c) sufficient stability will be retained to ensure that such building will not endanger any other building: Provided that in the case of any multi-storey building no major failure of the structural system shall occur;
 - (d) the generation and spread of smoke will be minimized or controlled to the greatest extent reasonably practicable; and
 - (e) adequate means of access, and equipment for detecting, fighting, controlling and extinguishing such fire, is provided.
- (2) The requirements of subregulation (1) shall be deemed to be satisfied where the design, construction and equipment of any building complies with SANS 10400-T: Provided that where any local authority is of the opinion that such compliance would not comply with all the requirements of subregulation (1), such local authority shall, in writing, notify the owner of the building of its reasons for its opinion and may require the owner to submit for approval a rational design prepared by an approved competent person.

T2 Offences

- (1) Any owner of any building who fails to –
 - (a) provide sufficient fire extinguishers to satisfy the requirements of subregulation **T1(1)(e)**, or who installs fire extinguishers that do not comply with the relevant South African national standard, or who fails to ensure that such fire extinguishers are installed, maintained and serviced in accordance with SANS 10105; or
 - (b) maintain any other provision made to satisfy the requirements of subregulation **T1(1)(e)**, shall be guilty of an offence.
- (2) Any person who causes or permits any escape route to be rendered less effective or to be obstructed in any way which may hinder or prevent the escape of any person from a building in the case of fire or any other emergency shall be guilty of an offence.

Annex B (normative)

Rational designs

B.1 Design requirements

Rational designs shall be undertaken by a competent person (see annex C) in accordance with the requirements of BS 7974 in order to achieve the same level of fire safety implied in 4.2 to 4.59 of this part of SANS 10400.

NOTE 1 BS 7974 provides a framework for the application of fire safety engineering principles to the design of buildings and is supported by a number of documents (the PD 7974 series) containing guidance on how to undertake detailed analysis of specific aspects of fire engineering. BS 7974 is an engineering process description only. It does not place restrictions on the performance-based process of justified reasoning and calculation. Any relevant standards or technical documents can be used during the process (see figures B.1, B.2 and B.3).

NOTE 2 In tall buildings or buildings with large occupancies, specialist publications, such as the Institution of Structural Engineer's publication *Safety in tall buildings and other buildings with large occupancy*, should be consulted. Consideration should be given to key issues such as:

- a) vulnerability for progressive collapse;
- b) passive and active protection;
- c) escape – its management and the emergency services; and
- d) security.

NOTE 3 Consideration should be given to providing refuges to facilitate the evacuation of persons with disabilities from high-rise buildings.

B.2 The application of the framework

B21 The framework for an engineering approach to fire safety shall be applied in three main stages (see figure B.1):

- a) qualitative design review;
- b) quantitative design review; and
- c) assessment against criteria

NOTE BS 7974 describes a process to be followed by designers, which implies that the local authority should check that this has been done. As such, BS 7974

- a) provides designers with a disciplined approach to fire safety design;
- b) allows comparison of safety levels for alternative design;
- c) provides a basis of selection of appropriate fire protection systems;
- d) provides options for innovative design; and
- e) provides information on the management of fire safety for a building.

SANS 10400-T:2011

Edition 3

B22 During the qualitative design review (QDR) the scope and objectives shall be defined, the performance requirements (criteria) shall be established and some of the overall design solutions shall be identified. The QDR shall be used to identify the inputs to the quantitative analysis in the subsystems and to establish acceptance criteria.

NOTE 1 The QDR is conducted by the competent person (fire engineering) usually with the professional team (architect, services engineer, structural engineer) and a member of the operations management. In some instances, it may be advisable to include a member of the local authority and the insurers of the building.

NOTE 2 The typical steps in the QDR process include the following:

- a) Review the architectural design of the building.
- b) Establish the fire safety objectives using the checklist provided in PD 7974-0.
- c) Identify fire hazards and possible consequences.
- d) Establish trial fire safety designs.
- e) Identify acceptance criteria and methods of analysis.
- f) Establish fire scenarios for analysis (and their consequences).

B23 The quantitative design review phase shall be conducted in accordance with the guidance provided in the various parts of PD 7974 and shall take account of

- a) the initiation and development of the fire within the enclosure of origin;
- b) the spread of smoke and toxic gases within and beyond the enclosures of origin;
- c) the structural response and fire spread beyond the enclosure of origin;
- d) the detection of fire and activation of fire protection system;
- e) fire service interventions;
- f) human factors, life safety strategies and occupant evacuation, behaviour and condition;
- g) probabilistic risk assessments; and
- h) local requirements, e.g. those relating to flammable liquids.

B24 During the assessment phase results of the subsystems analysis should be compared with the acceptance criteria identified during the QDR stage. If trial designs do not satisfy the acceptance criteria, the process should be repeated to establish available options. When satisfactory solutions have been identified, the resulting fire safety strategy and fire safety engineering process that produced it should be fully documented.

B25 The report should provide

- a) a description of the building;
- b) the results of the QDR;
- c) analysis;
- d) a comparison of the results of analysis with the acceptance criteria;
- e) conclusions; and
- f) references.

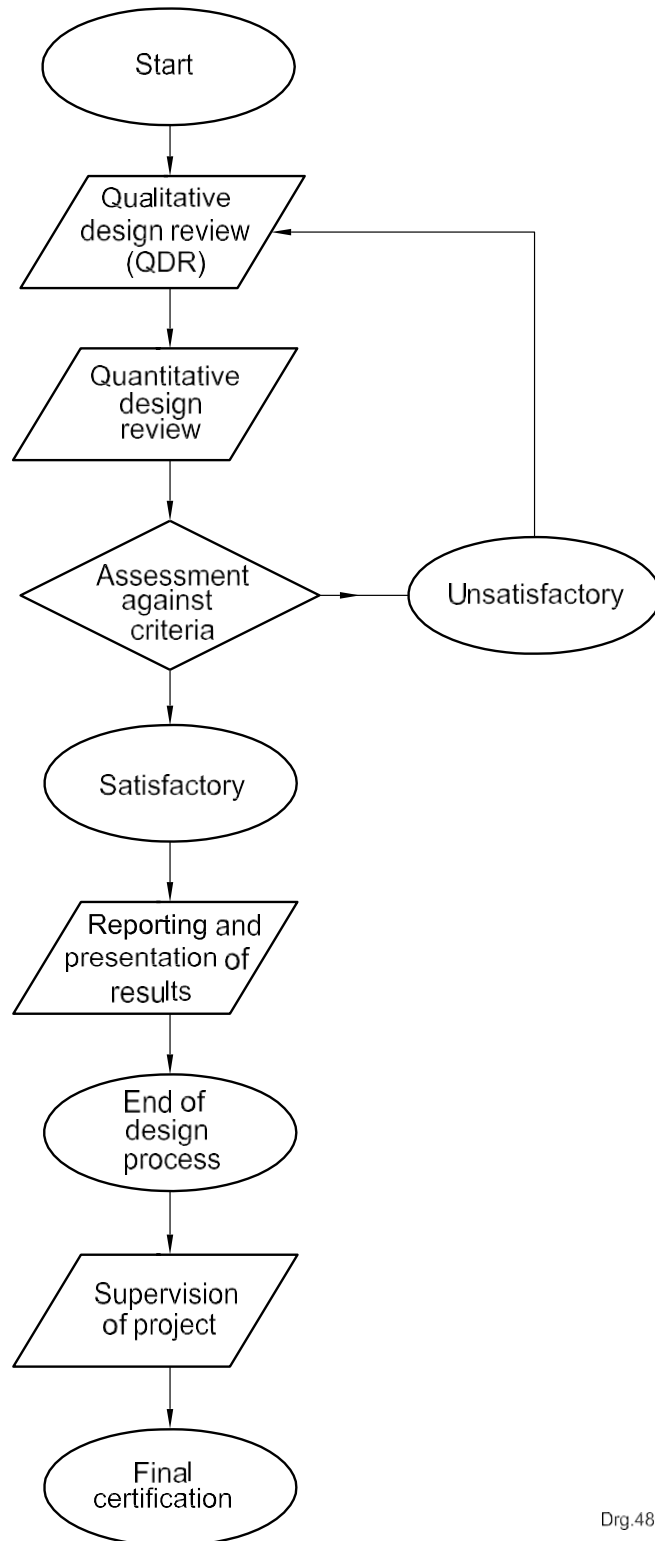

Drg.480

Figure B.1 — Basic fire safety engineering process

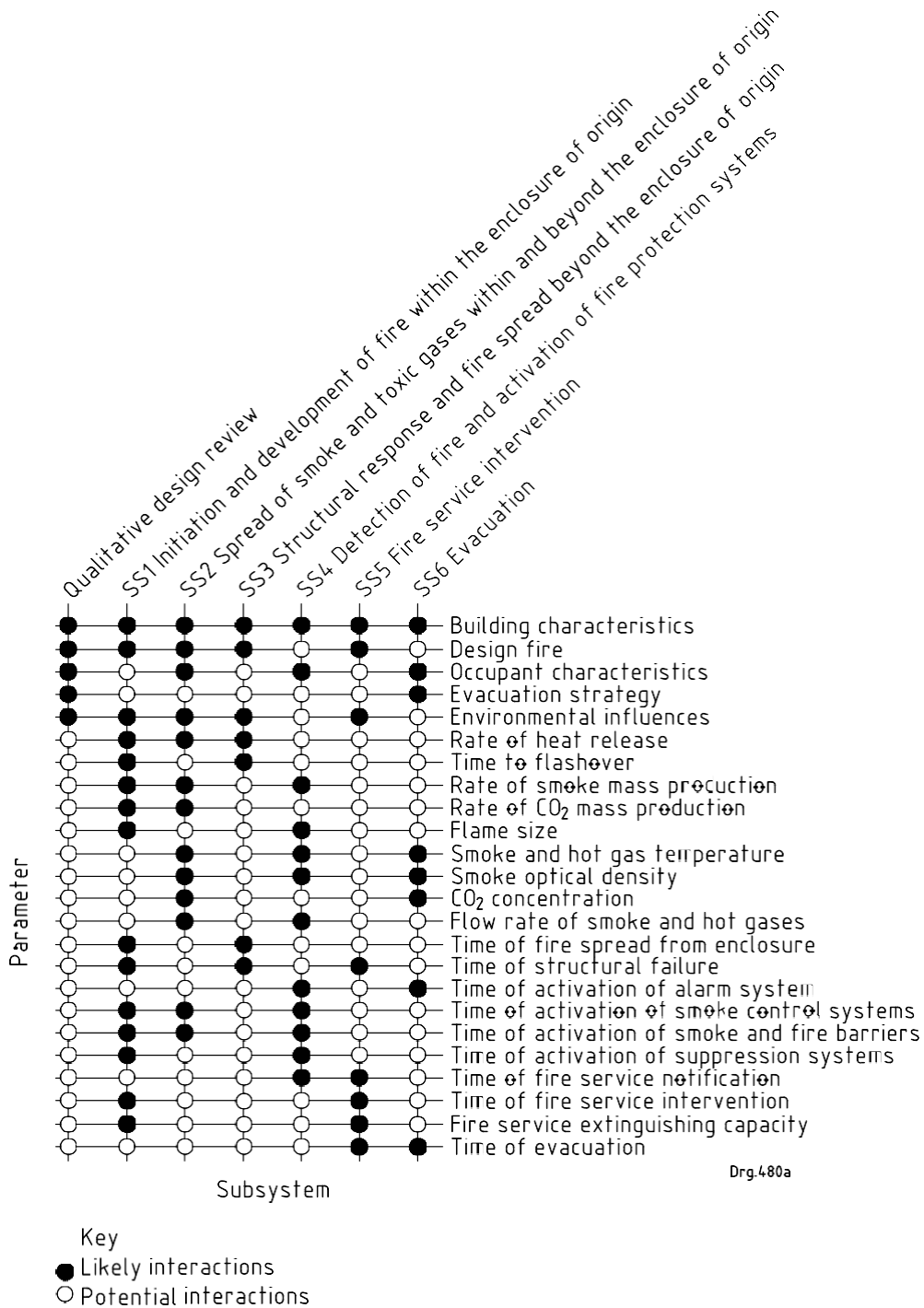

Figure B.2 — Illustration of likely interactions between subsystems

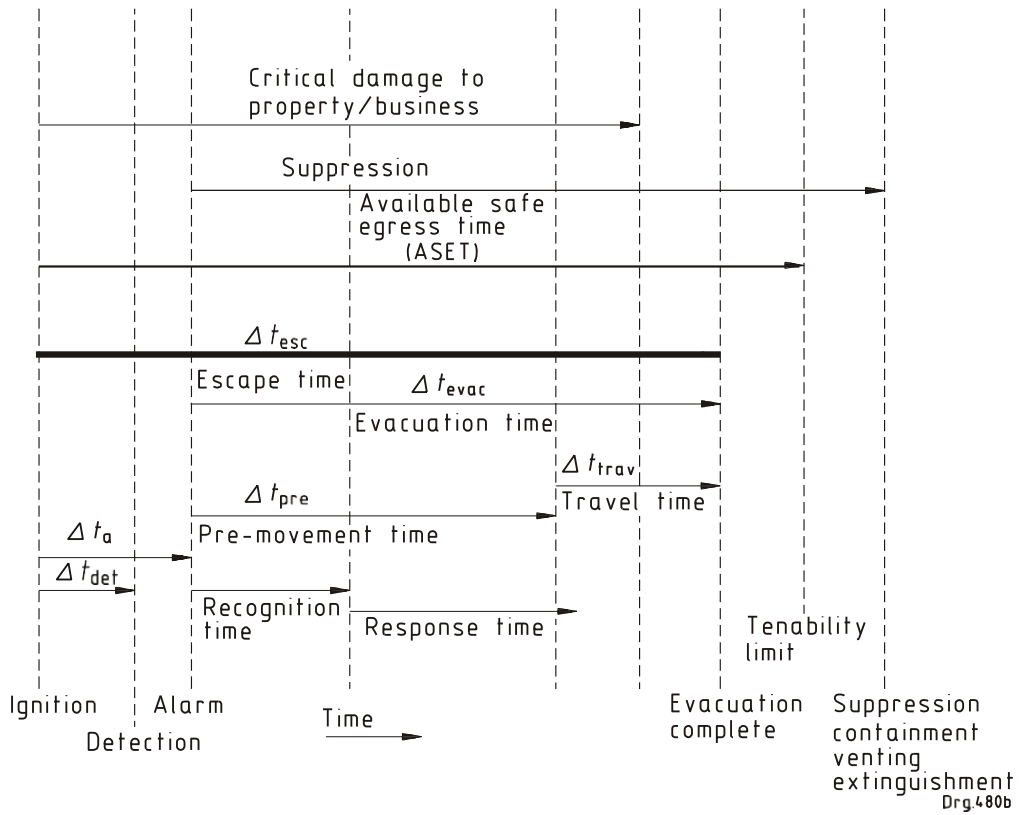

Figure B.3 — Example of timeline comparison between fire development and evacuation or damage to property

Annex C
(informative)

Appointment of competent persons

This part of SANS 10400 relies upon competent persons to perform specific tasks. Competent persons (fire engineering) are required to

- a) undertake rational designs in accordance with the requirements of BS 7974 (see 4.1.1(b) and annex B);
- b) rationally assess the acceptability of erecting a lapa against an existing building (see 4.12.2.3); and
- c) rationally design refuges (see 4.16.8).

Competent persons who might or might not be competent persons (fire engineering) are required to perform a number of other activities. These are set out in table C.1.

Table C.1 — Responsibilities assigned to competent persons other than competent persons (fire engineering)

Clause	Responsibility
4.2.7, 4.4, 4.8.2, 4.16.4, 4.26.1, 4.36.1 and 4.48.6	Design, install and maintain an automatic sprinkler system in accordance with the requirements of SANS 10287.
4.12.2.5	Design and install a lightning protection system in accordance with the requirements of SANS 10313 and SANS 62305-3.
4.25	Design, install, test and maintain the pressurization of emergency routes, mechanical smoke or heat control systems, and components in accordance with the requirements of EN 12101.
4.31.1, 4.31.2, 4.31.3, 4.43.2, 4.48.3 and 4.48.6	Design, install and maintain a fire detection and alarm system in accordance with the requirements of SANS 10139.
4.36.1	Design, install and maintain a fixed automatic fire-fighting system that is in accordance with the requirements of SANS 306-4 or SANS 14520-1.
4.37.3	Install, maintain and service portable fire extinguishers in accordance with the requirements of SANS 1475-1 and SANS 10105-1.
4.52.4	Direct the construction and installation of a tank in accordance with the requirements of SANS 10089-3.
4.53.1.1	Design, erect and protect liquid petroleum gas storage in accordance with the requirements of SANS 10087-3.
4.52.4 and 4.53.1.3	Direct the installation of a diesel fuel tank and associated equipment in accordance with the requirements of SANS 10131.
4.55.1	Perform a rational assessment of building materials and components to determine their fire resistance.

The design of any automatic sprinkler system, fixed automatic fire-fighting system, pressurization of emergency routes and fire detection and alarm system that may be required, is a rational design

(see 4.1.1(a)). The assessment of building materials and components to determine their fire resistance is a rational assessment (see 4.55.1).

Regulation **A19(1)** requires the owner of the building to appoint and retain one or more approved competent persons to undertake responsibility for the work associated with rational designs and rational assessments performed in accordance with the requirements of this part of SANS 10400.

Accordingly, competent persons (fire engineering) and competent persons who design automatic sprinkler system, fixed automatic fire-fighting system, pressurization of emergency routes and fire detection and alarm system or assessment of building materials and components to determine their fire resistance shall be appointed in terms of Regulation **A19**.

Annex D
(informative)

**Application of some of the requirements
of this part of SANS 10400**

D.1 Requirements for safety distances

D1.1 Radiant heat from a fire can cause the spread of fire from one building to another. This danger can be reduced by the provision of sufficient distances between buildings. It should be noted, however, that the term "safety distance" is in all cases related to a single building and its distance from some boundary. The distance required between buildings is always the sum of the two such "safety distances" although one or both such distances could be zero.

The degree to which fire in any building is a danger to any other building is influenced by the behaviour of the external walls and whether or not such walls contain windows or other openings.

D1.2 Additional fire protection may be provided by treatment with a suitable fire-retardant system (post-treated on both sides, pre-treated as a permanent system or any other system) that is acceptable in relation to the actual roofing system that is to be used, and retreated and maintained at the intervals as indicated by the manufacturers of such systems.

D1.3 A type FR wall does not limit the type of exterior cladding to be used, and either combustible or non-combustible cladding could be used. The fact that this type of wall has the required fire resistance is sufficient to ensure that, provided that such walls contain no openings, radiant heat from a fire in any building that has such walls will not present a danger to any other building provided that the walls in such other building also contain no openings and that a fire will be contained for long enough to enable any necessary action to be taken.

D1.4 A type F wall does not have full fire resistance but because the requirements for stability and integrity are complied with and only non-combustible cladding is allowed, any fire will be contained for long enough to enable the same safety distances that would be required for a type FR wall to be safely used under most circumstances. The fact that insulation requirements are not complied with could mean that radiant heat effects are somewhat greater than would be expected from a type FR wall. This is not generally regarded as significant in terms of safety distance, except insofar as there are limitations placed on the minimum distance permitted between a type F wall with no windows or other openings and a lateral boundary or another division or building.

D1.5 For the purposes of this part of SANS 10400, a type N wall is regarded as providing no protection against the spread of fire to any other building. In terms of safety distance this type of wall should therefore be regarded as the equivalent of a window or an opening.

D1.6 When a fire occurs in a building, radiant heat is emitted through windows or other openings and, similarly, enters buildings mainly through windows or openings. The distance between two walls both of which have the required fire resistance and no openings is therefore not restricted in any way.

D1.7 The introduction of openings of any kind, or the use of type F walls or type N walls, will lead to an increase of radiant heat outside any burning building and, in adjacent buildings, to an increased danger of ignition of the contents of such building. The danger of fire spread to other buildings is thus enhanced. The safety distances given in table 2 are calculated on the basis that, at the relevant distance, any wall having the required fire resistance and containing no openings can withstand the effects of radiant heat. At this distance, however, the degree of radiant heat will still be sufficient to constitute a danger to an adjacent building if it is able to penetrate such building through windows or other openings.

D18 In relation to the lateral boundaries of a site, a safety distance, as given in table 2, should be allowed between any building and such boundaries since a building (with a type FR wall) could be permitted on the boundary of the adjoining site. In the case of two buildings on the same site, each building requires its own safety distance from a notional line, i.e. a boundary line between them. This distance may be zero for either building where the building has type FR walls with no openings. However, where either or both buildings have openings or type F walls or type N walls a danger due to radiant heat can occur. Hence, one or both buildings, as the case might be, will require a safety distance from such notional line between the two buildings.

D19 Danger due to the effects of radiant heat will occur within a zone outside a window or other opening. This zone can be assumed to be bounded by cut-off lines at approximately 45° to the wall, extending out from such wall to a "safety distance" where the degree of heat no longer constitutes a threat to any other building, provided that such building has type FR walls with no openings. Radiant heat diminishes in approximately inverse ratio to the square of the distance from the source and the safety distances given in table 2 are calculated on this basis. The danger zone, shown in figure D.1, would thus be an area designated by points C, D, E, F, G and H where CE = safety distance = HF.

The danger caused by radiant heat entering a building through windows or other openings can be assumed to occur in a similar zone, calculated in terms of the safety distance required for the occupancy concerned.

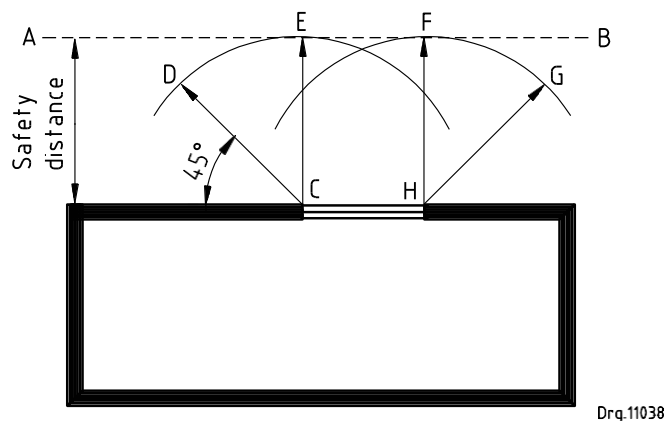

Figure D.1 — Danger zone

D1.10 Where there is, on the same site, a second building with windows opposite or nearly opposite those in the first building, any danger zone related to the one building would be assumed to extend to a notional boundary situated at a distance equal to the required safety distance from that building.

Another similar zone would exist between the second building and some notional boundary situated at an approximate safety distance from the second building. Where the two buildings are parallel to one another, it could be possible to locate the buildings (or parts of the buildings) and position the windows in each building in such a way that the two notional boundaries coincide in a single line as shown in figure D.2. This would represent the minimum spacing between the two buildings. It should be noted that this notional boundary is not necessarily a straight line, as its position will depend upon the relative positions of the windows in the two buildings.

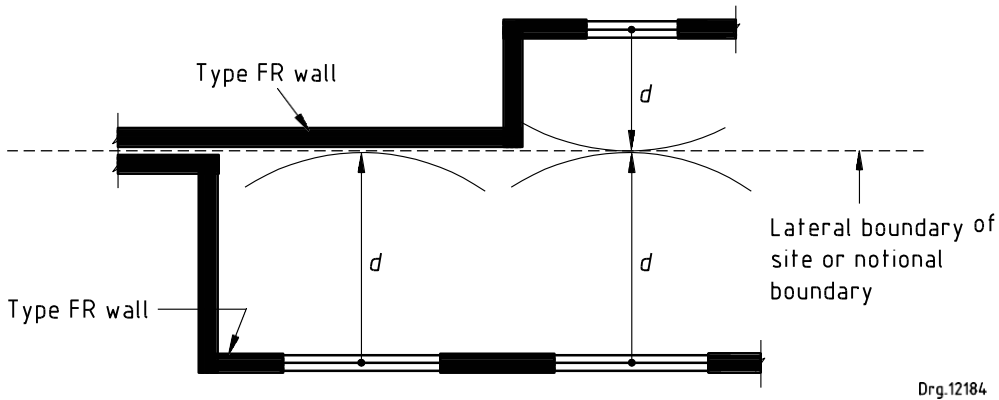

Figure D.2 — Safety distance for type FR wall

D1.11 In order to determine from a plan whether the layout of buildings and the safety distances provided are satisfactory, the following procedure should be adopted:

- a) From table 2 read off the safety distance required for the type of occupancy and the window area of the building in question. The values in table 2 may be modified in terms of the requirements of 4.2.7, 4.2.8 and 4.57.
- b) Using this distance as a radius, draw a sector of a circle from any point on a window, such as 1 in the building shown in figure D.3.
- c) Repeat for other windows such as 2, 3 and 4.
- d) Draw the line AB, which is tangent to these circles. The danger area is bounded by lines at 45° to the plane of the wall, as shown in figure D.1.

The Regulations will be complied with if no boundary line or wall of any other building lies in the zone between line AB and the building shown. In figure D.3, therefore, the wall of any building or boundary positioned on line EF would be acceptable but the wall of any building or any boundary on line CD would not. Note that where line EF represents the wall of another building the required minimum distance between lines AB and EF would be determined by the type of wall used in such building and the size of any openings in the wall.

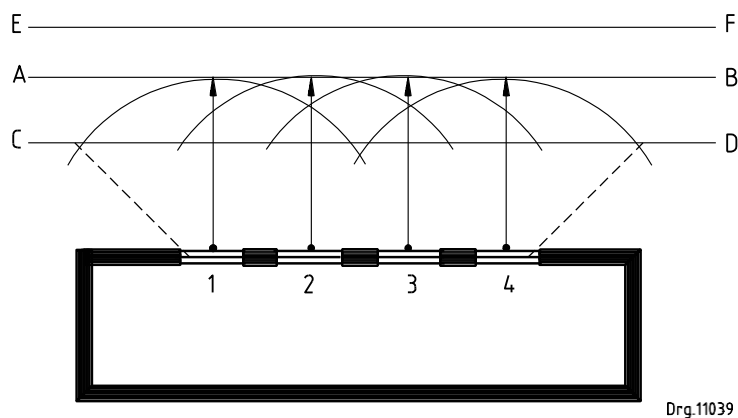

Figure D.3 — Window area safety distance

D1.12 In the building shown in figure D.4, the two portions of the building may be considered separately for the safety distance. The example given is acceptable in terms of distance from the boundary. The safety distance from portion B of the building would control the siting of the building in relation to the boundary even though B is further than A from the boundary.

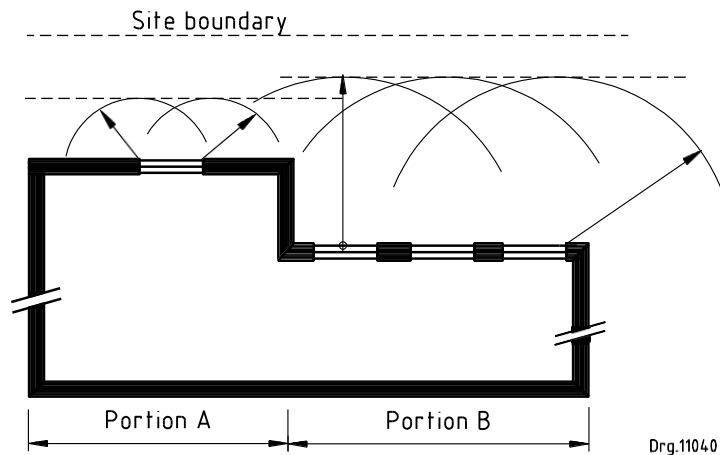

Figure D.4 — Combined danger zone and window area safety distance

D1.13 Figures D.5, D.6 and D.7 show certain common situations, but it is not possible to illustrate all the cases which might occur. In general, the layout is acceptable as long as no possible circle of radius equal to the required safety distance, drawn from any point on any window or other opening, intersects any boundary, wall of a building or any circle drawn from any opening in another building or in another division of the same building. Although the figures show the general rule, this is qualified by the requirements of 4.2.5, which allow certain exemptions from the rule subject to the limiting values given for the distance between windows and the included angle between such walls.

Where two buildings both have windows, sectors of circles of the required radius shall be drawn from the windows in facing walls as shown in figures D.5, D.6 and D.7. None of the circles drawn from one building shall intersect any circle drawn from the other.

D1.14 Where a garage on the same site as a building classified as H4 is situated very close to a lateral boundary of the site, any fire in such garage might give rise to some danger due to radiant heat from the door opening. However, in terms of 4.2.8(b), the area of opening to be considered is rarely likely to be more than about 5 m². In order to test whether the distance to the boundary is adequate, the usual method of drawing a circle (of radius equal to the required safety distance) from a point on the side of the door nearest to the boundary, should be applied. If the garage is found to be too close to the boundary, the necessary protection can be obtained by extending the side wall as shown in figure D.8. The required length of extension can be determined by adjusting the position of the centre of the circle so that the 45° line intersects the arc of the circle on the boundary line and touches the end of the wall.

Garages in any domestic occupancy represent a low fire load and any garage which is a component of an H3 occupancy should be treated in the same way as one on the site of an H4 occupancy, provided that such garage is not large enough to fall within the description of a parking garage (J4 occupancy). Garages attached to individual dwelling units in a townhouse complex should thus be considered as if each dwelling unit was an H4 occupancy.

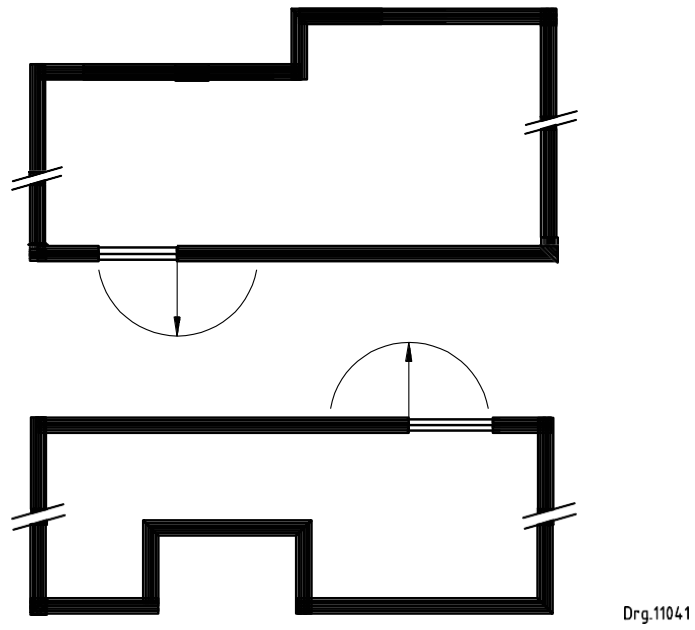

Circles drawn from windows do not intersect, therefore distance between buildings is acceptable.

Figure D.5 — Intersecting window safety distance (acceptable)

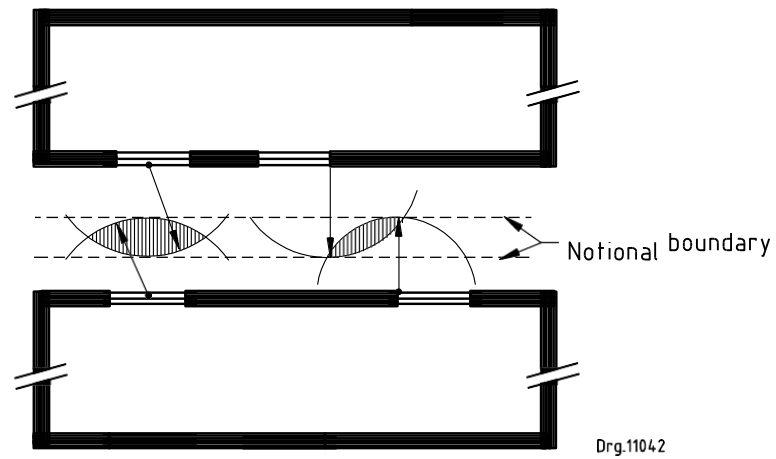

Circles intersect. Distance between buildings is not adequate.

Figure D.6 — Intersecting window safety distance (unacceptable) — Type 1

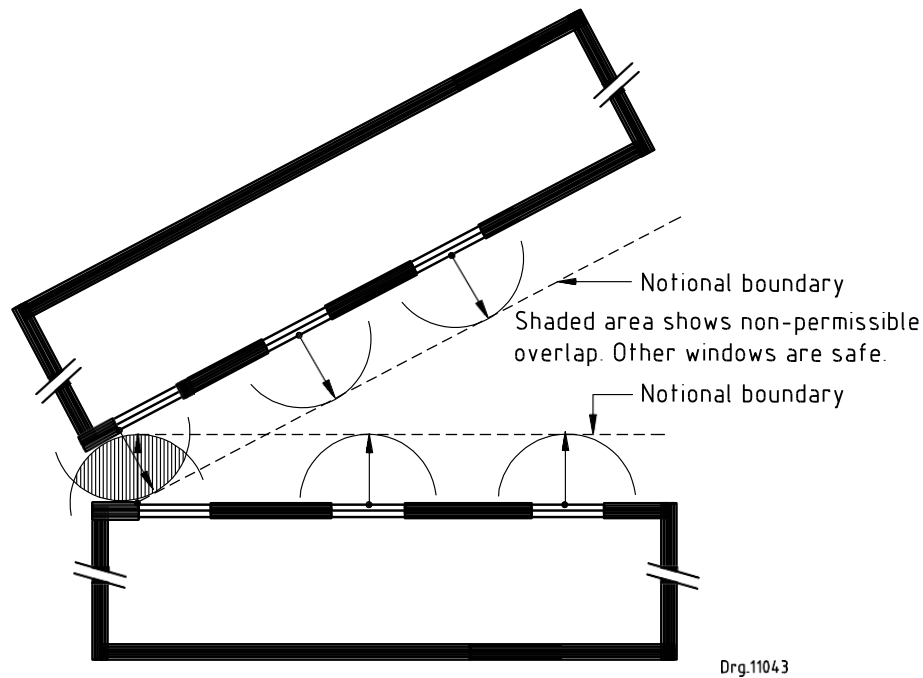

Figure D.7 — Intersecting window safety distance (unacceptable) — Type 2

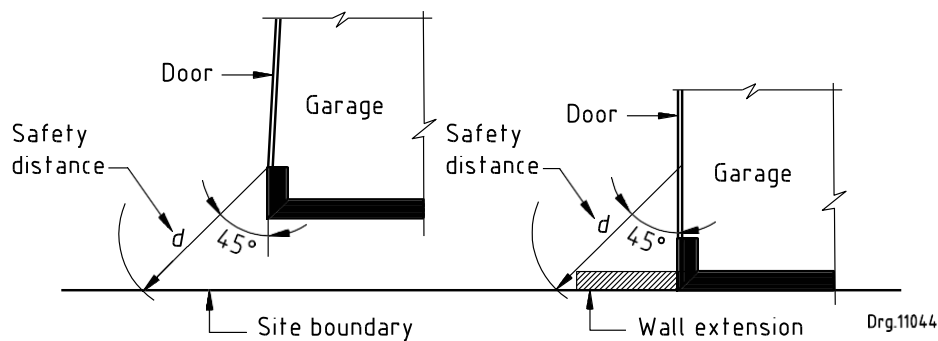

Figure D.8 — Protection of opening in a garage

D.2 Provision of escape routes

D.2.1 In terms of 4.16.1, all buildings shall be provided with one or more escape routes that can be used in case of fire or other emergencies. The two most important aspects are that the route

- a) should, at all points, be wide enough to allow the population using such route to move rapidly along it, and
- b) should not, at any time, be obstructed in any way.

D.2.2 The width of any escape route within a dwelling house (H4 occupancy) or within an individual dwelling unit in an H3 occupancy is not critical because of the small population involved and the fact that the layout of the dwelling unit can be assumed to be well known to the occupants. In the case of any H3 occupancy where two or more dwelling units open onto a part of the escape

SANS 10400-T:2011

Edition 3

route which serves all of them, such common part of the route should comply with all the requirements (including width) for escape routes (see 4.16).

D.2.3 A common path of travel is where, although there might only be one exit door to a room or small building, all the possible routes use the one exit point. If a corridor forms part of such a layout, this is termed a common path of travel corridor. Such layouts should not be confused with a dead-end corridor. An easy distinction between the two is that one can move directly out of a common path of travel whereas one has to retrace one's steps in order to exit a dead end, thereby doubling the distance to be travelled.

D.2.4 To be fully effective, feeder routes and emergency routes should supply at least the degree of protection envisaged in the deemed-to-satisfy requirements given in this part of SANS 10400. This is particularly important in the case of emergency routes which have to perform the dual function of protection during evacuation of the building and during subsequent fire-fighting operations.

The essence of any escape route that requires the incorporation of emergency routes is that there should be at least two possible directions of escape. Where the exit from a room leads into a dead-end corridor, this is not possible and it becomes necessary to reduce to the absolute minimum the distance to be travelled before either a feeder route or an access door into an emergency route is reached. In this case, account should be taken of the travel distance both in the room in question and along the dead-end corridor. This is of consequence both in itself and as part of the total travel distance to a safe area.

D.2.5 In order to determine what provision is required for escape routes, proceed as follows:

- a) Check the travel distance from the furthest point in a room, measured along the escape route, to the nearest escape door.

Where this distance is less than 45 m or in any building of not more than three storeys in height, no emergency routes (and hence no feeder routes) are required. With the exception of those cases covered in 4.16.2(b), only one escape route need be provided, but this should be dimensionally adequate for the population to be served.

Where the travel distance is more than 45 m, emergency routes should form part of the two or more escape routes that should be provided and these emergency routes should be as far apart as possible, subject to the limitation that the travel distance to the nearest access door to an emergency route should be not more than 45 m.

- b) Calculate the total population of each floor of the building. Note that in an occupancy classified as H3, the population within an individual dwelling unit is not, in itself, of concern as the population figure required is used only in connection with the common part of the escape route and not that part which is provided within each such dwelling unit.
- c) Using the population figure calculated in terms of (b), calculate the number and width of the necessary escape routes bearing in mind that
 - 1) the widths of all routes should be approximately equal,
 - 2) because fire might prevent the use of a particular emergency route, one such route is always discounted in determining the widths required for the remaining emergency routes, and
 - 3) in the case of a stairway only the population of the most heavily populated storey need be taken into account in the calculation of width.

D.3 Escape routes

D.3.1 The requirements given for the siting and dimensioning of escape routes apply essentially to individual occupancies in a building. Where there are unusual circumstances such as might arise in

shopping malls and sport stadiums, the same general principles will apply but much of the detail might have to be adapted to suit the particular situation.

D.3.2 In any design for fire protection measures in a shopping mall, for instance, population calculations in accordance with these provisions can only be based on the population calculated for individual shops. The total figure arrived at in this way will bear little relation to reality and should be modified by some "diversity factor" to allow for the number of shops. A further allowance will have to be made for the degree of compartmentalization, if any, in the mall and the proportion of the population likely to be inside shops at any given time.

It is not unusual for the larger shops in a shopping mall to have escape routes independent of those provided for the remainder of the mall. In the case of the smaller shops, service corridors may double as escape routes but the main promenade in the mall will inevitably also be used for escape purposes although it could never comply with the requirements for an emergency route. However, in many cases the mall is wide and the fire load in any individual small shop will not be very large. Where adequate fire protection measures have been installed, it could be possible to confine any fire to the shop in which it originated.

The number of factors involved is thus very large and is further influenced by the presence, or lack, of adequate smoke control measures and a fixed means of automatic fire extinguishment such as a sprinkler system. In such cases it is essential to consider from the onset the means of escape and to ensure that it is possible to evacuate the mall in the shortest possible time, preferably in a fully protected environment.

D.3.3 Large grandstands in sports stadiums suffer from all the usual problems associated with large crowds but, in addition, might present difficulties which are unique to this type of structure. In a panic situation persons might climb over the rows of seats and escape routes are often not as clearly defined as they would be within a building. The resultant lack of orderly flow might lead to choking of access doors to emergency routes or of exits from the grandstand. However, it would rarely be the case that simultaneous evacuation from all parts of the stadium would be necessary and it may be possible to consider alternative means of escape such as allowing movement of part of the population to other stands or onto the playing field. As in the case of shopping malls, it is impossible to lay down rigid rules for the provision of escape routes and all possibilities should be taken into account in order to ensure the safety of those using any grandstand.

D.4 Atrium buildings and shopping malls

Atrium buildings and shopping malls are not adequately covered by the deemed-to-satisfy requirements and should, in most cases, be the subject of a rational design.

Bibliography

Standards

BS 9999, *Code of practice for fire safety in the design, management and use of buildings.*

SANS 1567, *Portable rechargeable fire extinguishers – CO₂ type extinguishers.*

SANS 10228, *The identification and classification of dangerous goods for transport.*

SANS 10400-B (SABS 0400-B), *The application of the National Building Regulations – Part B: Structural design.*

Other publications

BOU/E9806:1998 *Guide to good thatching practice.* Published by the Division of Building and Construction Technology, CSIR, P.O. Box 395, Pretoria, 0001.

Institution of Structural Engineers. *Safety in tall buildings and other buildings with large occupancy.* ISBN 0 901297 24 0. The Institution of Structural Engineers. 2002.

SABS – Standards Division

The objective of the SABS Standards Division is to develop, promote and maintain South African National Standards. This objective is incorporated in the Standards Act, 2008 (Act No. 8 of 2008).

Amendments and Revisions

South African National Standards are updated by amendment or revision. Users of South African National Standards should ensure that they possess the latest amendments or editions.

The SABS continuously strives to improve the quality of its products and services and would therefore be grateful if anyone finding an inaccuracy or ambiguity while using this standard would inform the secretary of the technical committee responsible, the identity of which can be found in the foreword.

Tel: +27 (0) 12 428 6666 Fax: +27 (0) 12 428 6928

The SABS offers an individual notification service, which ensures that subscribers automatically receive notification regarding amendments and revisions to South African National Standards.

Tel: +27 (0) 12 428 6883 Fax: +27 (0) 12 428 6928 E-mail: sales@sabs.co.za

Buying Standards

Contact the Sales Office for South African and international standards, which are available in both electronic and hardcopy format.

Tel: +27 (0) 12 428 6883 Fax: +27 (0) 12 428 6928 E-mail: sales@sabs.co.za

South African National Standards are also available online from the SABS website

<http://www.sabs.co.za>

Information on Standards

The Standards Information Centre provides a wide range of standards-related information on both national and international standards, and is the official WTO/TBT enquiry point for South Africa. The Centre also offers an individual updating service called INFOPLUS, which ensures that subscribers automatically receive notification regarding amendments to, and revisions of, international standards.

Tel: +27 (0) 12 428 6666 Fax: +27 (0) 12 428 6928 E-mail: info@sabs.co.za

Copyright

The copyright in a South African National Standard or any other publication published by the SABS Standards Division vests in the SABS. Unless exemption has been granted, no extract may be reproduced, stored in a retrieval system or transmitted in any form or by any means without prior written permission from the SABS Standards Division. This does not preclude the free use, in the course of implementing the standard, of necessary details such as symbols, and size, type or grade designations. If these details are to be used for any purpose other than implementation, prior written permission must be obtained.

Details and advice can be obtained from the Senior Manager.

Tel: +27 (0) 12 428 6666 Fax: +27 (0) 12 428 6928 E-mail: info@sabs.co.za