

**HyGROMATIK**® SPA

# Spa Touch Control

---



Manual



STC.EN  
E-8881156

Certain computer programs included in this product [or unit/system] have been developed by HygroMatik GmbH ("the work").

Copyright © HygroMatik GmbH [17.08.2020]

Spa Touch Control EN

Current version of the operating manual at [www.hygromatik.com](http://www.hygromatik.com)

All rights reserved.

HygroMatik GmbH grants the legal user of this product [or unit/system] the right to use this work solely within the scope of the legitimate operation of the product [or unit/system]. No other right is granted under this licence. In particular and without prejudicing the above-mentioned provision in any way, the work cannot be used, sold, licensed or transferred either in its whole or a part thereof or in any way shape or form copied or reproduced other than here expressly allowed, without the prior written agreement of HygroMatik GmbH.

<b>1. Introduction</b> .....	<b>5</b>
1.1 Intended use .....	5
1.2 Protection class .....	5
1.3 Safety instructions .....	5
1.4 Typographic distinction .....	6
1.5 Definitions .....	6
<b>2. Overview</b> .....	<b>7</b>
2.1 Characteristics of the Spa Touch Control .....	7
2.1.1 Monitor characteristics .....	7
2.2 Scope of supply .....	8
2.3 Prerequisites for connection of the Spa Touch Control to the steam generator .....	8
<b>3. Mechanical setup</b> .....	<b>9</b>
<b>4. Wall installation</b> .....	<b>10</b>
4.1 Installation principle .....	10
4.2 Choice of installation location .....	10
4.3 Installation steps .....	10
<b>5. Electrical connection</b> .....	<b>11</b>
5.1 Connection principle (Spa Touch Control - side) .....	11
5.1.1 Connections .....	11
5.2 Connection to steam generator .....	12
5.2.1 On steam generators of the HyLine, CompactLine, HeaterLine, HeaterCompact and FlexLine series: .....	12
5.2.2 On steam generators of the HeaterSlim series: .....	13
5.3 Setting the baud rate for the communication interface .....	13
<b>6. Time control of the steam generator with the aid of Spa Touch Control</b> .....	<b>15</b>
6.1 Optional operating modes .....	15
6.1.1 Manual operation .....	15
6.1.2 Short-term mode .....	15
6.1.3 Timer mode .....	16
6.2 Status chart of available operating modes .....	17
<b>7. Menu structures</b> .....	<b>18</b>
<b>8. Initial operation</b> .....	<b>19</b>
8.1 Password entry .....	20
<b>9. Operation</b> .....	<b>22</b>
9.1 User and operator functions .....	22
9.2 Overview of operating and display elements for the user (main screen) .....	23
9.3 Operation by user .....	24
9.3.1 General operation .....	24
9.3.2 Operating examples for the user .....	24
9.3.3 Changing the set point temperature .....	26
9.4 Settings by the operator .....	27
9.4.1 Defining the main screen (options screen) .....	27
9.4.1.1 Set manual mode ("Steam on/off" or short-term mode) .....	29

9.4.2 Activate "Essence on/off" and set intensity .....	31
9.4.3 Activate the "Light on/off" button for the main screen .....	32
9.4.3.1 Particularity for the FlexLine Control .....	32
9.4.4 Activate "Fan on/off" button for the main screen .....	33
9.4.5 Activate set point temperature display and set point temperature .....	33
9.4.6 "Eco mode on/off" and set the setback temperature .....	34
9.4.7 Realtime clock setting .....	39
9.4.8 Timer function (weekly schedule) activation .....	40
9.4.9 Colour combination selection .....	44
<b>10. Parameters and read values when connected to a HeaterSlim steam generator .....</b>	<b>45</b>
10.1 Tabular overview of parameters .....	46
10.2 Tabular overview of Read_values .....	48
<b>11. Technical specifications .....</b>	<b>52</b>

---

## 1. Introduction

### Dear customer,

Thank you for choosing the Spa Touch Control for remote control of your HygroMatik steam generator.

The Spa Touch Control is designed for use with the steam generators of the HygroMatik **HyLine**, **CompactLine**, **HeaterLine**, **HeaterCompact**, **Heater Slim** and **FlexLine** series.

The Spa Touch Control is state of the art technology.

In order to be able to operate the Spa Touch Control reliably or to set it up, please read this manual. Since the units feature different controls, the operating menus differ from each other with respect to some of the operating steps. In these cases the menu descriptions relate to the unit series in a dedicated way.

Please use the Spa Touch Control only when it is in perfect condition and only for the purpose intended.

Should you have any queries please contact your specialist dealer.

For queries and ordering spare parts please always state type of unit and serial number.

### 1.1 Intended use

The Spa Touch Control is a display and operating panel for control of the operating functions of a HygroMatik steam generator. The unit is designed for moisture-proof wall installation with fixed control cable. Use inside the steam cabin is permissible if the installation manual is stringently complied with regarding the sealing. Nonetheless we do recommend that installation be outside the steam cabin

For test purposes the unit is capable for temporary portable use on a HygroMatik steam generator. Since no strain relief for the control cable is provided the permanent portable use of the display and operating panel is not permitted.

### 1.2 Protection class

When correctly installed the front of the assembly has the protection class IP 65. The rear protection class is determined by the construction provided by the customer. The rear protection class in as-supplied condition i.e. with no additional measures is IP00.

### 1.3 Safety instructions

For the running and operation of the Spa Touch Control no special safety notes apply. Nevertheless all safety notes applicable to each respective unit (steam generator) the operation of which the Spa Touch Control is used for are to be observed.

**Please note** If the steam bath operation is ceased for a longer period of time, it is recommended that the steam generator is switched off so

that no unintended unit start may occur caused by the Spa Touch Control. If it is intended that the dead leg flushing feature (if implemented) remains active during this period of time, the safety interlock system must be interrupted instead while the steam generator itself remains in the „on“ state.

#### **1.4 Typographic distinction**

- » With this double chevron operating steps are identified which are absolutely necessary for retrieving a function or carrying out a setting.

#### **1.5 Definitions**

In this operating manual differentiation is made between the user and the operator of the steam bath facility.

##### User (hereinafter called "user")

The user is a person who wants to "utilize" the steam bath facility. User operation of the steam bath is limited to the essentials.

The operating functions of the Spa Touch Control accessible to the user are depicted in the "User level".

##### Operator

The operator is the entity which has the technical responsibility for the facility. The operator can determine the functions of the steam bath facility in full and define which operating functions are to be made accessible to the user.

The operating functions of the Spa Touch Control available to the operator are depicted in the "Operator level". The user level is of course available to the operator as well.

## 2. Overview

The HygroMatik Spa Touch Control is a compact display and operating panel for HygroMatik steam generators.

Use direct on the steam generator or separated from it via cable with a maximum length of 50 m.

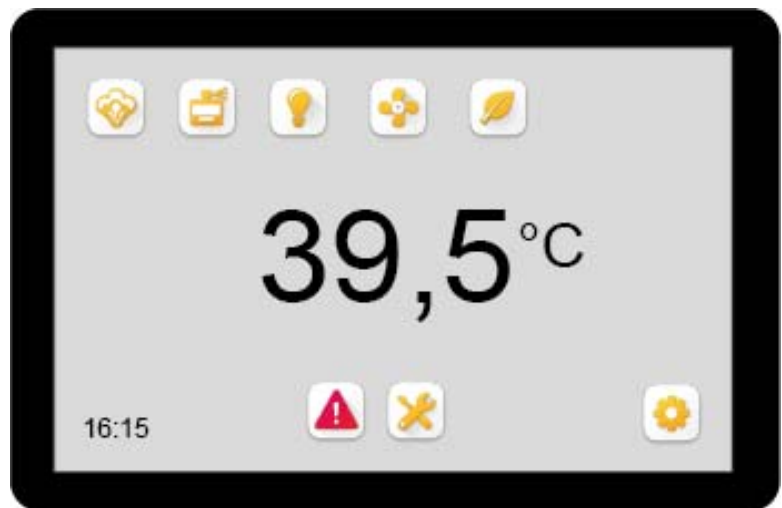

### 2.1 Characteristics of the Spa Touch Control

- Moisture-protected flush mounted wall installation
- Protection class frontal IP 65
- Data connection to steam generator via permanent Cat 5 control cable
- 12 V power supply through steam generator via the control cable
- Communication via Modbus RTU protocol
- Touch-sensitive surface (touchscreen)
- Range of functions of operational control definable by operator
- All functions controllable via screen icons (no text information)
- Screen icons supply information on device status
- Continuous mode, short-term and timer mode (weekly auto timer)

#### 2.1.1 Monitor characteristics

- Capacitive touchscreen (PCT)
- High scratch resistance

## 2.2 Scope of supply

The "Spa Touch Control" ordering package includes the following items:

- Touch-sensitive 5 inch monitor (touchscreen)
- Connecting cable 20 cm long, RJ45 plug on one end, 4-pin system specific connector on the other
- RJ45 socket for connection of the connecting cable with the permanent Cat 5 control cable
- Installation frame for flush fitting incl. bolts and seal plugs
- Aluminium frame as face cover
- Instruction manual

## 2.3 Prerequisites for connection of the Spa Touch Control to the steam generator

**On steam bath generators of the HyLine, CompactLine, HeaterLine and HeaterCompact series:**

The HygroMatik steam generator must be equipped with a connection kit consisting of the transformer for the 12V AC supply, a connector strip and the RS485 computer interface.

This connection kit is available from HygroMatik under item no. B-0608053.

**On steam bath generators of the HeaterSlim:**

The HeaterSlim steam generator is already equipped with a socket (BU1) on the main board, which allows the connection of the "Spa Touch Control" via Cat. 5 cable.



### 3. Mechanical setup

The Spa Touch Control consists of the monitor assembly, the installation well with 2 attachment bores for the monitor assembly with rear welded M4 nuts and the faceplate.

The monitor assembly is designed as a sandwich construction. The actual touchscreen is connected through a frame and combined with the circuit board at the rear to form a single compact unit. The circuit board carries the combined system plug for the 12V AC power supply and the RS485 2-wire bus.

After fitting the installation well (see section "Wall installation") the monitor assembly is attached to the flange of the installation well with the two M4 countersunk bolts. The finish at the front is provided by the black anodized aluminium faceplate which is attached to the frame over the whole area or with the aid of the four adhesive spots (see section "Wall fitting").

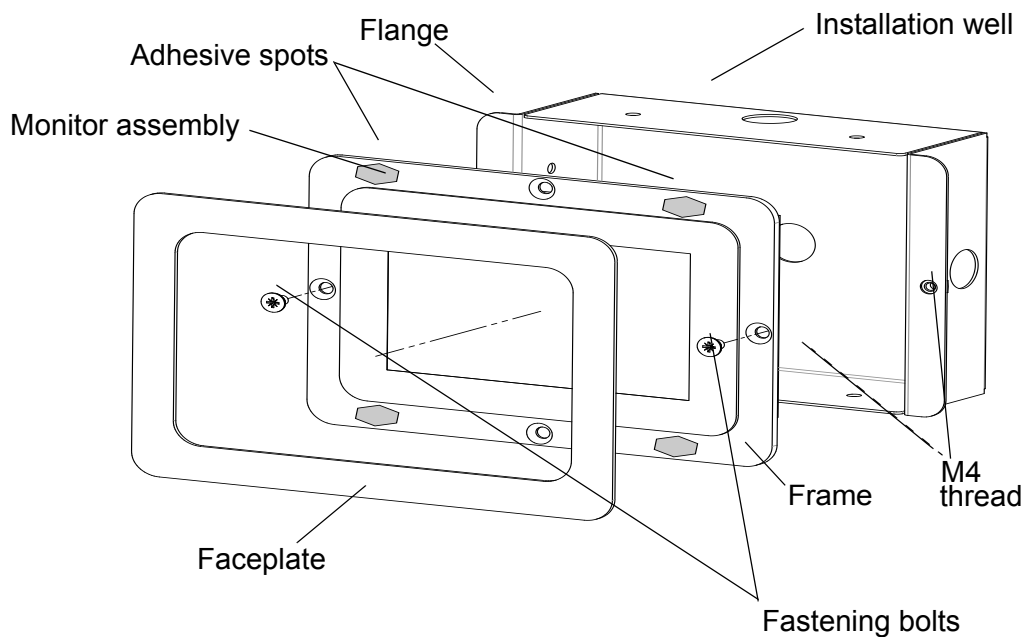

**NOTICE**

The SpaTouchControl module is only designed for horizontal installation.

## 4. Wall installation

### 4.1 Installation principle

The Spa Touch Control is designed for flush mounted installation. To protect the assembly an installation well is included which subject to the conditions provided by the customer is to be plastered into a solid wall construction or in the case of a cavity wall installed in another way. Depending on the judgement of the implementing company installation in a dry cavity wall can be made without the installation well. The attachment bores with M4 threads are then to be provided by the customer.

For leading the control cable to the electronic module the customer is similarly responsible for finding a suitable method (laid flush-mounted or in cavity).

### 4.2 Choice of installation location

The installation of the Spa Touch Control can be made inside or outside the steam cabin. The installation height above the floor is to be selected so that easy reading of the screen is possible for the kind of usage envisaged (sitting or standing operation).

### 4.3 Installation steps

- » Plaster installation well into wall recess or install by other method.
- » Lead Cat 5 control cable into well and connect to 20 cm adapter cable via RJ45 socket or directly to the electronic module (see section "Electrical connection").
- » Place electronic module in the installation well and attach it to the installation well with the two countersunk bolts.
- » Remove protective film from the 4 adhesive spots.
- » Place face cover onto the adhesive spots and press on. Alternatively the face cover can be glued on by the application of silicone joint material to the complete surface.
- » Draw a silicone joint around the face cover to seal to the wall.

**Please note** For the adhesive spots 3M™VHB™ adhesive tape item no. "4932" is used. Refer to the relevant data from the manufacturer for processing information.

## 5. Electrical connection

### 5.1 Connection principle (Spa Touch Control - side)

For connecting the Spa Touch Control to the steam generator a patch cable (no cross-over) is required to be laid by the customer and which is utilized for the 12V AC supply as well as the RS485 2-wire bus. Max. cable length is 50 m. The patch cable must at least correspond to category 5 (cat.5).

For connection a 20 cm long adapter cable is supplied which allows extension of the permanent patch cable via the RJ45 socket also supplied, provided the former is complete with RJ45 plug.

Alternatively the patch cable can be connected directly to the Spa Touch Control. For this purpose the 4-pin system plug of the adapter cable is to be used. Since the plug uses spring-type terminals, non-destructive dismantling of the adapter cable is possible.

#### 5.1.1 Connections

##### Connection 1: Utilization of the adapter cable



**Adapter cable Cat 5 on system plug**

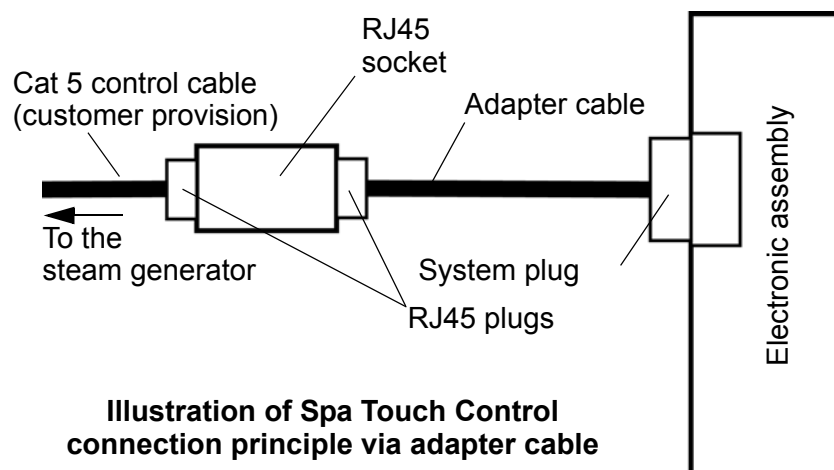

**Illustration of Spa Touch Control connection principle via adapter cable**

**Connection 2: Direct connection to electronic assembly**

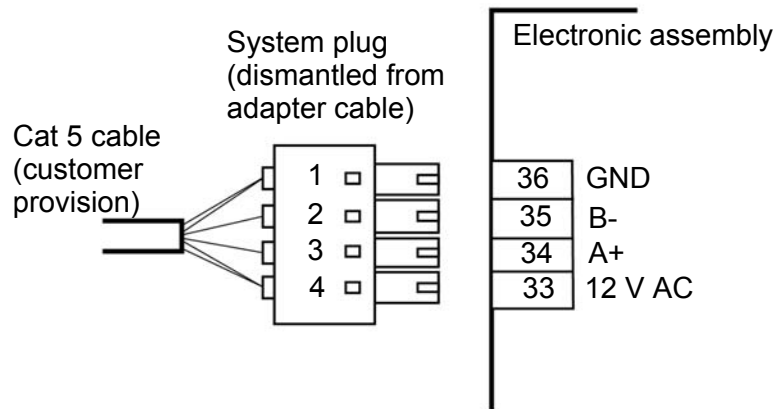

Plug pin	Assembly pin	Allocation	Core colours
1	36	GND	og and wh-bn
2	35	B-	wh-bu
3	34	A+	bu
4	33	12 V AC	wh-og and bn

**5.2 Connection to steam generator**

**5.2.1 On steam generators of the HyLine, Compact-Line, HeaterLine, HeaterCompact and FlexLine series:**



For connection of the Spa Touch Control to such a HygroMatik steam generator a connection kit is required (see Section "Overview" last paragraph). One component part of this kit is an RJ45 socket in the form of a feedthrough housing (see adjacent illustration).

The Cat 5 cable from the Spa Touch Control is inserted into this socket.

If the permanent cable is to be directly connected to the steam generator an RJ45 socket is to be fitted to its end. The core colours for pin allocation correspond with those of the above chart.

The permanent cable can also be completed by the customer with a flush or surface-mounted RJ45 socket. The connection of the steam generator can then be made with a commercially available Cat 5 patch cable (no cross-over) in line with normal network engineering practice.

### 5.2.2 On steam generators of the HeaterSlim series:

The HeaterSlim steam generator offers the socket marked BU1 on the main board.

The Cat. 5 control cable coming from the Touch Spa Control is equipped with an RJ45 plug at the end. This is plugged into socket BU1.

Sealing ring



**Note:** The Cat. 5 control cable and plug can be passed through one of the M25 cable glands of the steam generator.

If you unscrew the retainer nut of the cable screw connection you can dismantle the sealing ring inside. It can be replaced with a slotted sealing ring (in the enclosed accessories package) that may be bent open for inserting the cable.

### 5.3 Setting the baud rate for the communication interface

The communication parameters of the serial interface of almost all of the HygroMatik steam generators quoted are set ex factory in a way that the compatibility with the Spa Touch Control is given (9600 Baud/No parity/1 Stopbit). Exception from the rule is the FlexLine steam generator that requires a change of parameters (s. below).

#### Settings for the FlexLine series units



Other than the rest of the steam generators quoted, the FlexLine units are shipped ex factory with the following parameter settings:

Baudrate: 19200 Baud

Parity: None

Stopbits: 1

For operation with the Spa Touch Control, changing the FlexLine SPA control baudrate to 9600 Baud is required. To do so, follow these steps:

- » Touch the  icon in order to access the settings sub-menu
- » Enter „010“ by means of the virtual keyboard when the password setting view opens. Confirm by touching the green tick on the upper right side. The first view page of the main menu opens.
- » Use the scroll down arrow on the lower right side to access the second view page
- » Select the communications submenu by touching the  icon. The following screen is displayed:

11: Communications	
01: Address	1
02: Baudrate	19200
03: Parity	None
04: Stopbits	1

- » It is only required to make a baudrate setting change. For that reason, touch the second line in the view and select „9600“ as the new baudrate (to allow for this, change the view page by means of the scroll-up key). Confirm the setting by touching the green tick.

The baudrate is now set to „9600“ for use with the Spa Touch Control.

## 6. Time control of the steam generator with the aid of Spa Touch Control

With the aid of Spa Touch Control the steam generator can be run in manual mode, short-term mode (steam release is made for a fixed period) or timer mode (weekly schedule). In addition to these, mixed modes are possible. For example through manual intervention, the weekly schedule can be overridden ("manual override").

### 6.1 Optional operating modes

The operating mode is determined by the operator (see section "Operation", paragraph "Settings by the operator").

Please note

The operating modes only determine the behaviour of the steam release. Actual steam generation within the scope of the operating mode selected is determined by control of the steam generator on the basis of steam bath temperature.

#### 6.1.1 Manual operation

When the user operates the steam button the steam bath operation is enabled until the release is either withdrawn or the electronic control system of the steam generator in accordance with the internal parameter "Limitation of operating time", causes it to be switched off.

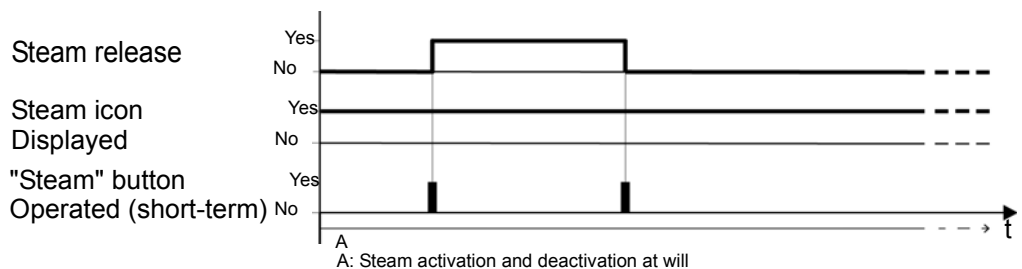

#### 6.1.2 Short-term mode

When the user touches the steam button steam release is made for a fixed period. During this period no new start is possible; after expiry however, any number of times.

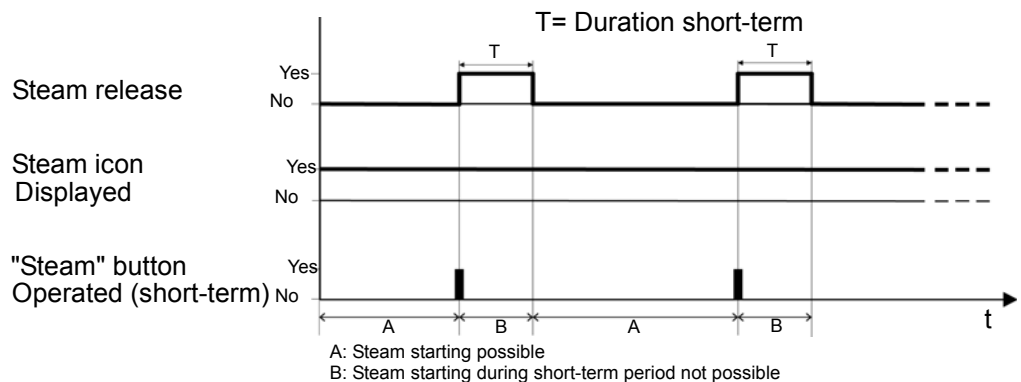

### 6.1.3 Timer mode

The on/off switching times for operation are saved to a weekly schedule. If there are no other activations (short-term mode or manual override) the weekly schedule directly determines the times for steam release. The three possible variants are described as follows:

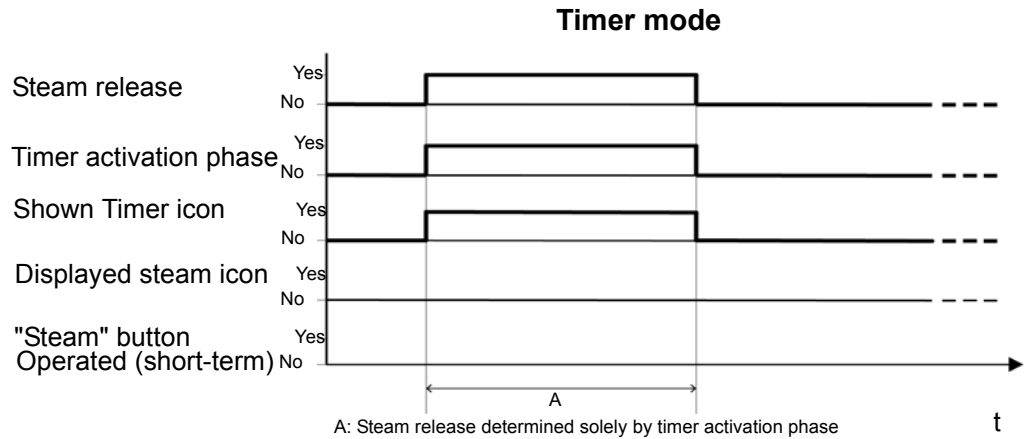

#### Timer mode with "Manual override"

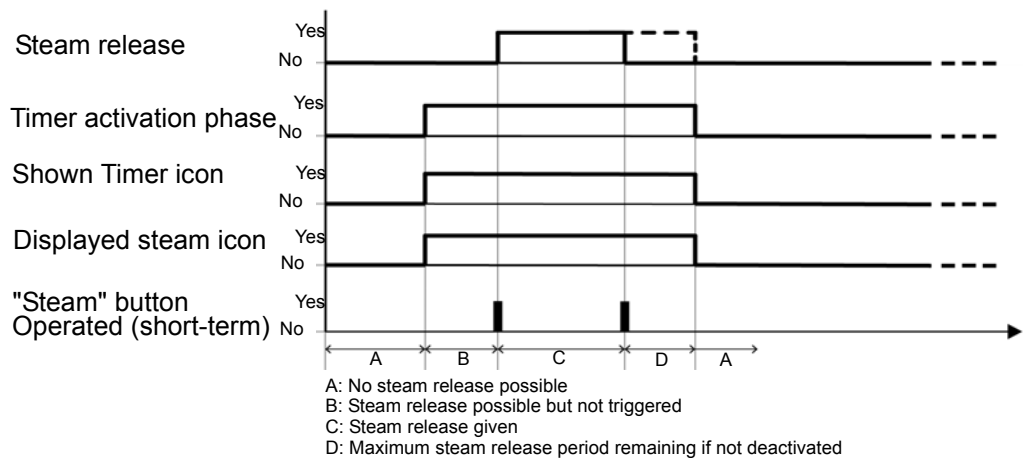

#### Timer mode with "Manual override" and short-term mode activation

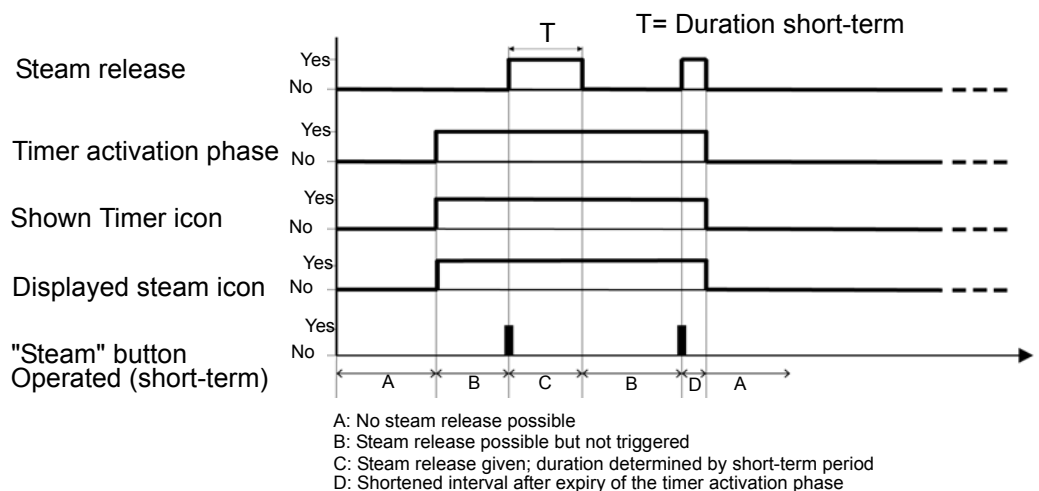



## 6.2 Status chart of available operating modes

Operating mode	Steam icon available	Steam button operated	Short-term mode activated	Timer activate	Timer in switch-on phase	Steam release
Manual	Yes	No	No	No	-	OFF
	Yes	Yes	No	No	-	Permanent until switched off or period limitation
Short-term	Yes	No	Yes	No	-	OFF
	Yes	Yes	Yes	No	-	for the fixed period set
Timer	No	n.a.	No	Yes	No	OFF
	No	n.a.	No	Yes	Yes	according to the programmed "ON" switching times
Timer with manual override	Yes	n.a.	No	Yes	No	OFF
	Yes	Yes	No	Yes	Yes	"Manual override" of switch-on period duration. Permanent "ON" until manual switch off or period limitation
Timer with manual override and short-term	Yes	Yes	No	Yes	No	OFF
	Yes	Yes	Yes	Yes	Yes	"Manual override" of switch-on period duration. "ON" for the duration of the short-term mode period saved

n.a. = not applicable

## 7. Menu structures

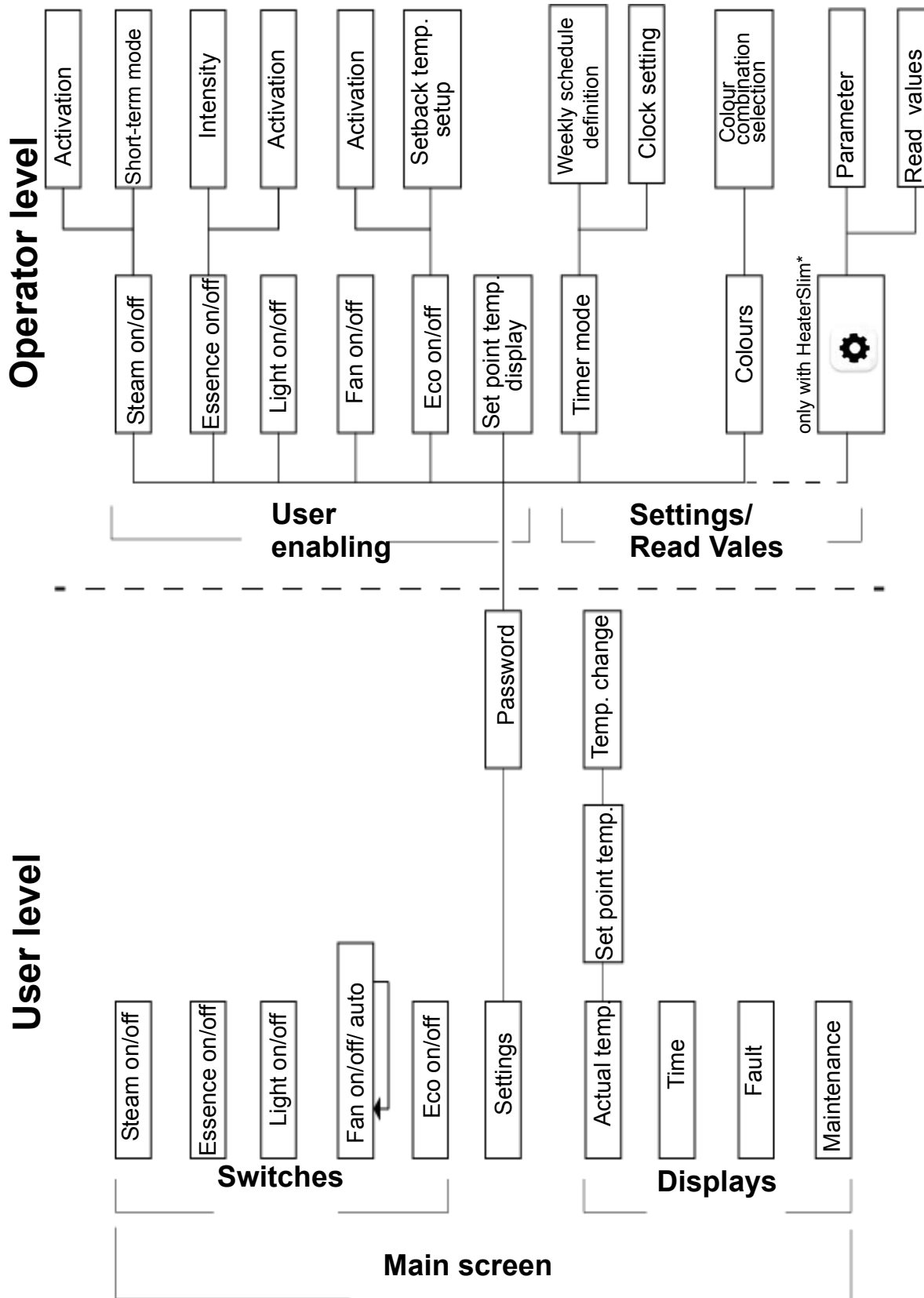

## 8. Initial operation

When the steam generator with Spa Touch Control connected is switched on the following start screen appears:



When initial operation is concerned after a brief period the display switches to the following screen in which there are not yet any operating options for the user.

**Main screen with no user access rights**

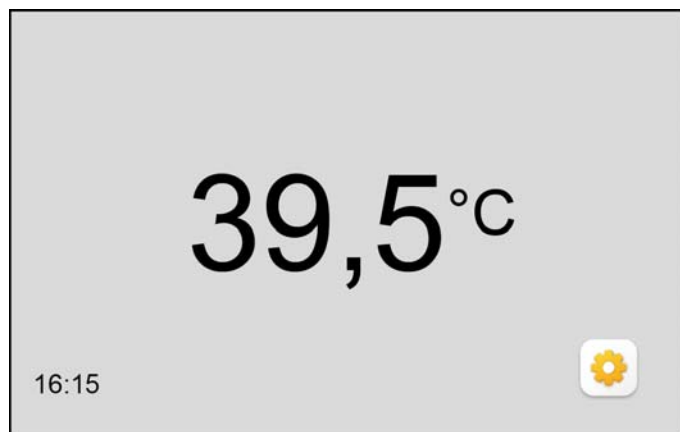

In the next step the operating functions which the user is permitted to access are to be set up by the operator.

- » Touch the button  , in order to enter set-up mode. The screen for entering the password is opened.

## 8.1 Password entry

View of password entry

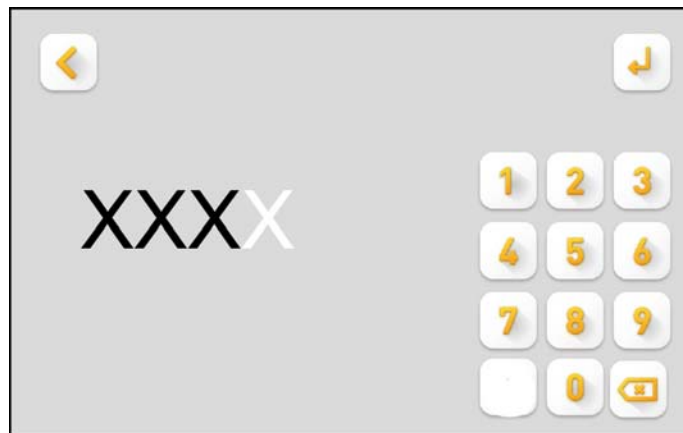

The password corresponds to the access code of the steam generator concerned (see operating manual of the relevant control system). By default, code 010 is used.

The steps depicted below refer to the Spa Touch Control usage in combination of a HygroMatik steam generator of the **HyLine**, **CompactLine**, **HeaterLine**, **HeaterCompact** and **HeaterSlim** series.

- » Digital entry of the three-figure password. The first digit is entered in the outermost right-hand position using the keyboard. With the next digital entry the previously entered digit moves one position to the left.
- » Repeat the step until the password is displayed in full.
- » Confirm the entry with the button .

Correction of the entry can be made with the button .

When the Spa Touch Control is combined with a steam generator of the **FlexLine** series, the following applies:

The Spa Touch Control password can be set by the provider in the „Functions“ submenu of the FlexLine Control Spa. To do so, the provider level main menu must be called up first with the internal password „010“ (also see description in section 5.3 of the FlexLine Control SPA manual). The icon for the „Functions“ submenu call can be found on screen page 2 of the main menu. When touching the  icon, the screen view „10: Functions“ opens.

- » Use the „Down“ arrow to scroll to the screen view showing line 11 („Password\_remote\_control“).
- » Touching the line opens a virtual keyboard allowing for entry of a 4-digit password.
- » Confirm the password by touching the green tick in the upper right of the screen.

The password is now set (three-digit or four-digit, FlexLine units only). It may be changed at any time.

After entering the password the screen is opened which enables the operator to define the buttons and display icons of the main screen and change the default values (in the following designated as the options screen). The procedure for configuration of this screen and the changes to settings is described in Section "Operation" (9.4.1).

## **9. Operation**

### **9.1 User and operator functions**

Differentiation is made between user operation and display functions and extended functions available to the operator only - after entering a password. Settings can only be changed by the operator. One exception is the modification of the set-point temperature of the steam bath which can be carried out by the user if permitted by the operator.

The user screen is referred to as the "main screen" in this document.

The operating and display functions which can be controlled by the user are limited to basic operations such as "Steam on/off", "Fan on/off" etc. The scope of the main screen (and hence the equipment functions allocated to the user) is to be adapted by the operator for each individual case. In the following section the main screen with all possible buttons and displays is described together with the respective explanation. The actual scope of the main screen is determined by the extent of enabling to be performed by the operator.

## 9.2 Overview of operating and display elements for the user (main screen)

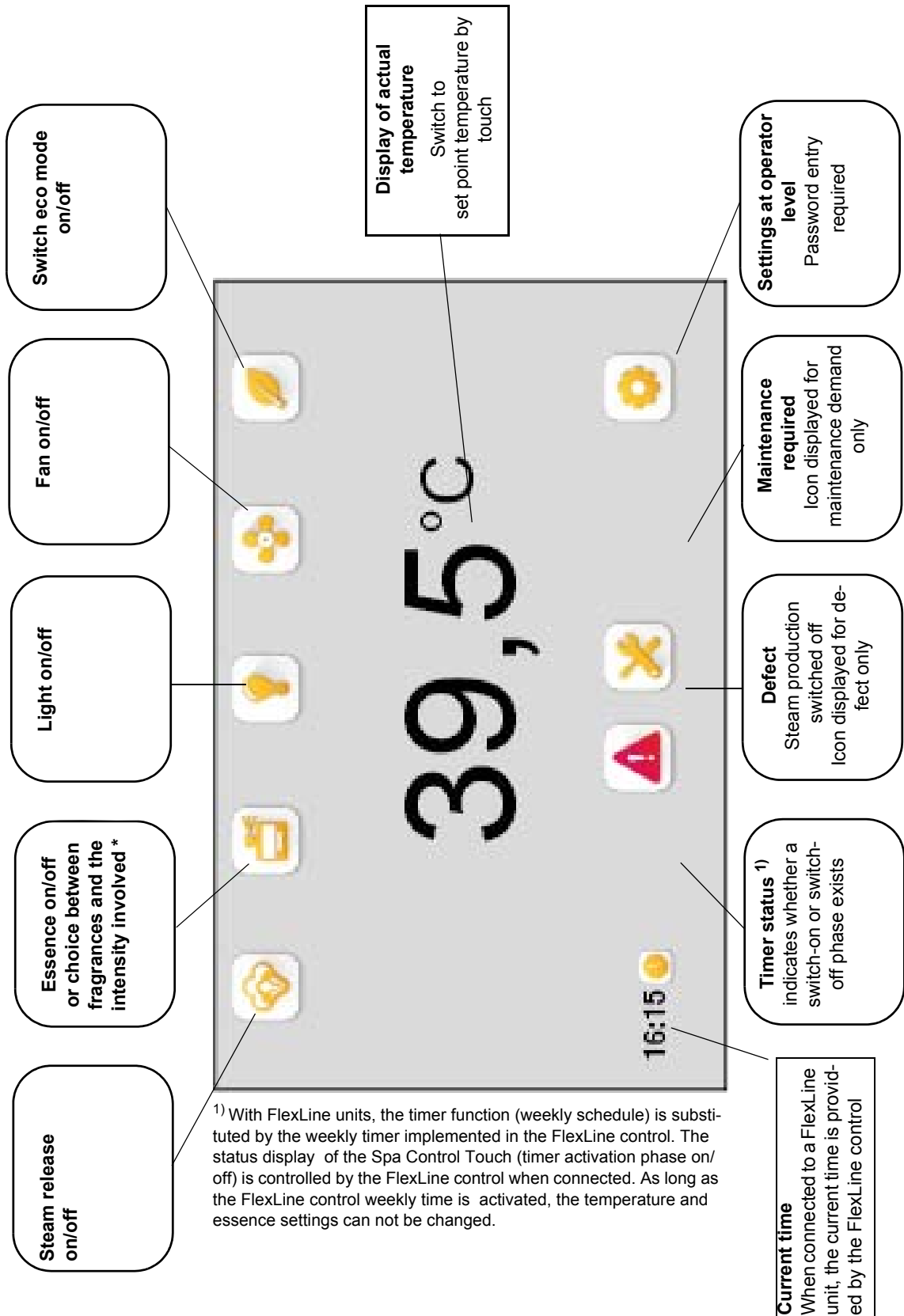

only available when connected to a HeaterSlim device

### 9.3 Operation by user

#### 9.3.1 General operation



The selection of individual functions such as "Steam generation on", "Essence supply off" is prompted by briefly touching the respective icons in the main screen with a finger.

**Please note** Since a capacitive touchscreen is involved sure functioning is only provided by direct touch with a finger. The screen does not react to pressure.

When touched the colour of the icon background changes as an acknowledgement for the user. When the finger is withdrawn the selected function is activated. At the same time the icon changes its colour as a status signal for the user.

By retouching the previously activated function is deactivated Here too a status signal for the user is provided by a change to the icon background.

The various icons displayed are depicted in the following example of the fan control.

Icon	Meaning
	Function capable of selection
	Function is active

#### 9.3.2 Operating examples for the user

##### Switching on the steam generation and the fan

» Beginning with the example main screen shown below, touch the buttons for steam generation and fan engagement consecutively.

**Main screen with possible operating functions**

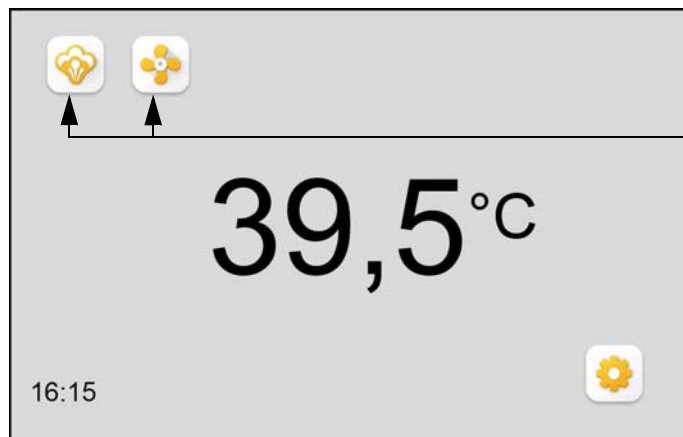



Both operating functions are launched and the main screen changes as follows:

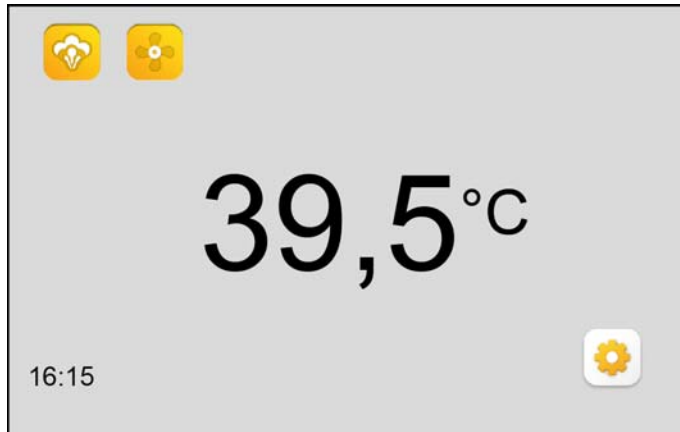

**Main screen with operating functions launched**



Steam release and fan are now enabled. By retouching the steam button the steam function can be switched off although in the case of the steam release this is only possible as long as the operator has not set a default runtime.

If steam release is made in short-term mode a further steam release can be made by the user after expiry of the set interval. As long as the interval has not expired further touching of the steam button does not produce an extension of the runtime.

Three different functions can be selected by touching the fan button.

Icon	Meaning
	Fan is active
	Fan is off
	Fan automatic is active

The following function can be selected by touching the fan button again.

The automatic function regulates the fan temperature controlled.

### 9.3.3 Changing the set point temperature

The set point temperature can be changed by the user if the operator has provided this option (please see also chapter „Defining the main screen (options screen)). Changing is to be made as follows:

- » Touch the temperature display on the main screen.

Switch to display of the set point temperature

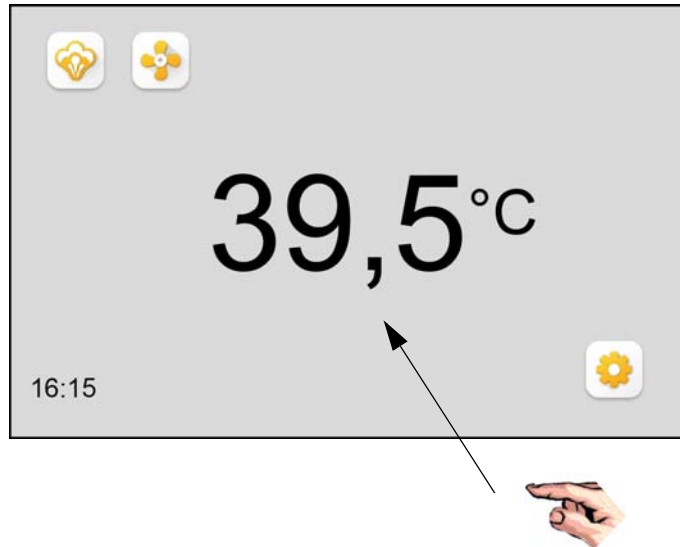

If enabled by the operator the temperature display now changes from "actual" to "set"

Display and changing of the set point temperature

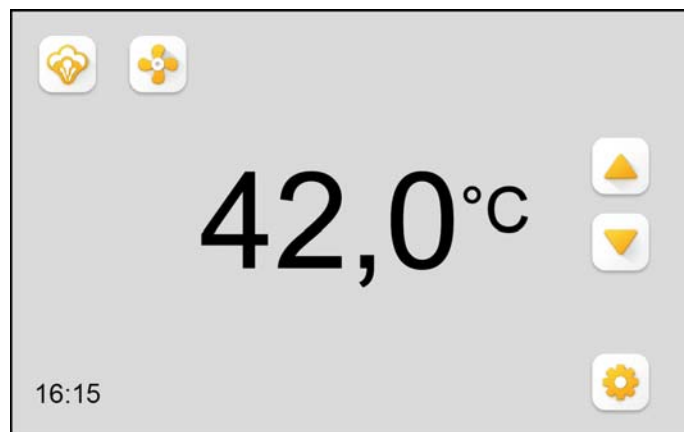

- » with button ▲ or ▼ change the set point temperature in 0.5 °C increments.
- » Accept setting and return to actual temperature display by touching the temperature display again.

The adjustment range for the set temperature lies between 25 °C and 49 °C.

## 9.4 Settings by the operator

Operator settings require the entry of a password. The procedure for password entry is described in Section "Initial operation".

In addition to the "main screen" which is also available to the user the operator has the "selection screen" and function-related "sub-menu screen" available. To select a sub-menu the relevant button above the dividing line is to be touched. When the selected icon is touched the drop-down list of sub-menu options opens below it which allows the relevant settings to be made (excluding the icons/buttons for "Light" and "Fan" for which no sub-menus exist).

Entries in or changes made to the sub-menus are directly adopted. Return to the main screen is reached via the button



### 9.4.1 Defining the main screen (options screen)

In the options screen for defining the main screen all the operating functions are displayed which are able to be made available to the user (when connected to a HeaterSlim or a FlexLine unit, particularities apply - see foot notes) . In addition there are icons/buttons present which are only relevant for the operator. After commissioning the Spa Touch Control all functions are initially deactivated:

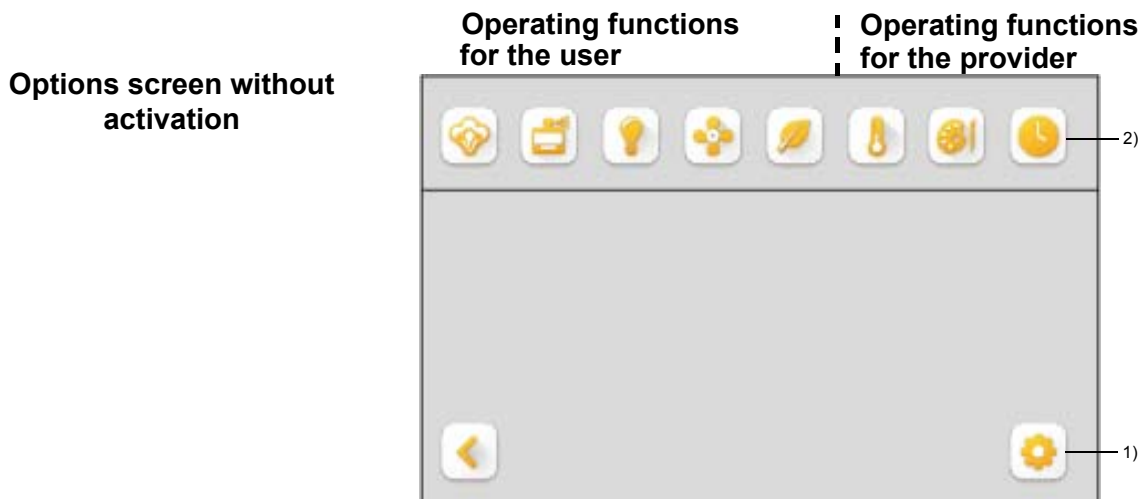

<sup>1)</sup> only visible when connected to a HeaterSlim unit. The button serves for the call-up of the parameters and read values of the control. As a particularity, call-up is possible in this screen view already.

<sup>2)</sup> not visible when connected to a HeaterSlim or FlexLine unit.

Activation can be made by touching the relevant buttons. Only the activated buttons/icons are then visible on the main screen for the user.

Accept and return to the main screen by touching the button .

Insofar as functions with modifiable parameters (e.g. parameters "Essence intensity" for the "Essence supply") are concerned, the release of the function is made in 2 stages (see Section "Selecting steam control and changing settings").

Example: On the main screen only the icons for "Light on/off" plus "Fan on/off" should be visible. In addition the user should have the option of changing the set point temperature.

For this purpose the following steps are to be taken:

- » Activate the icons for fan and set point temperature release by touching the buttons. This generates the following screen

**Options screen with activation**

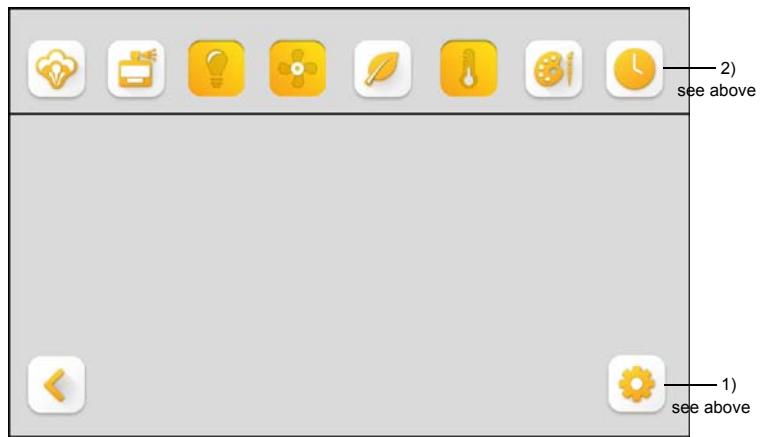

\*: only visible when connected to a HeaterSlim device

- » To store the selection and return to the main screen touch the button  .

Consequently the following screen appears for the user.

**Main screen with possible operating functions**

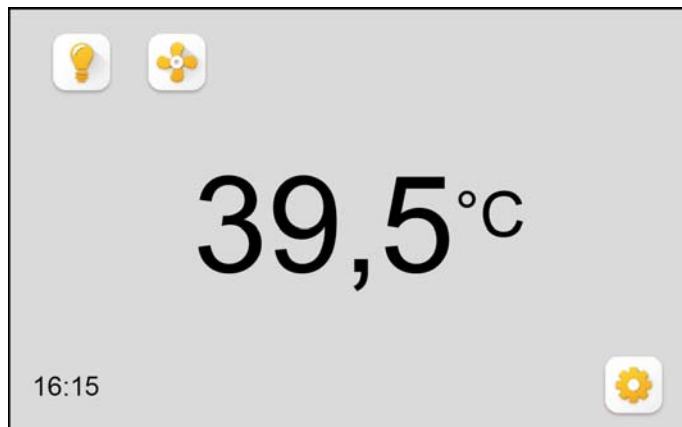

The buttons now permit the on/off switching of the cabin light and the fan. Moreover the set point temperature can be changed as described in Section "Changing the set point temperature".

Please note

In this example the button for "Steam on/off" are not enabled i.e. the operator prefers steam control by other means (see Section "Steam control" or the next one). Selection of steam control and modification of settings.

In order to navigate to the required sub-menu for changing the relevant button must first be touched. The additional steps for each setting are described as follows.

### 9.4.1.1 Set manual mode ("Steam on/off" or short-term mode)

#### "Steam on/off"-mode

» On the options screen touch the button  .

The following sub-menu screen:

Steam-mode select

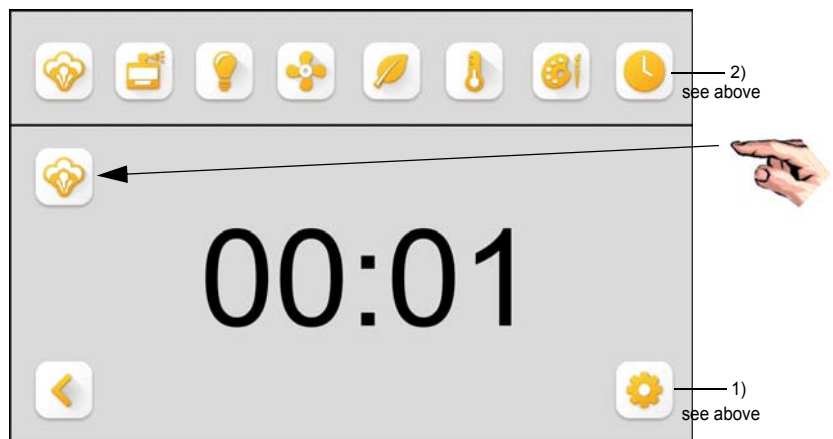

» By touching the button  under the dividing line the manual steam mode can be set i.e. switching steam generation on and off is made by the user ("Steam on/off"). Both steam icons are now shown as "activated":

Operating mode "Steam on/off" selected

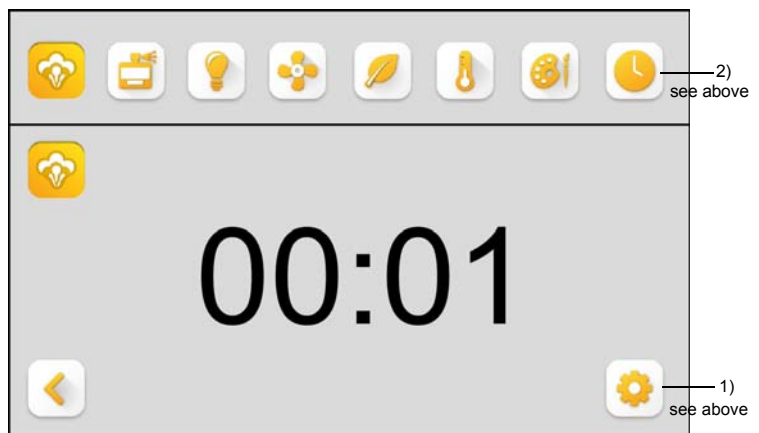

» Return to options screen with the button  .

**Short-term mode (Steam mode for a defined time interval)**

If the short-term mode is to be selected in place of the straight manual "Steam on/off" mode proceed as follows:

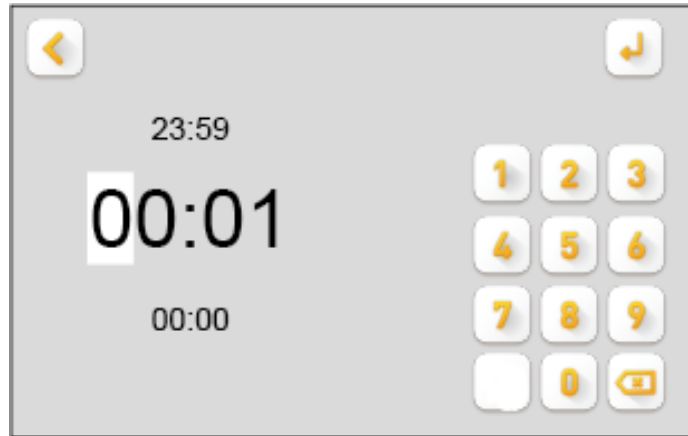

- » Touch the 00:00 display. The following sub-menu screen:

**Screen for setting the interval for short-term mode**



Activation of short-term mode is made by overwriting the 00:00 display using the keyboard. The format is "Hours:Minutes", digit input in a sequential way.

In activated condition the interval length can be overridden at any time.

- » Return to previous screen with the button .
- » Return to options screen with the button .

As long as the display remains at "00:00" short-term mode is not activated. For activated short-term mode the sub-menu display is shown as e.g. thus (Criterion is an interval which differs from "00:00").

**Operating mode "Short-term mode" selected**

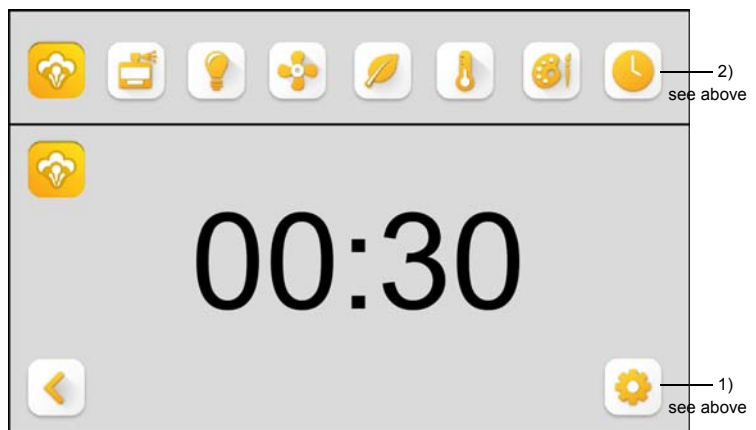

**Activation of essence function or setting the intensity**

**9.4.2 Activate "Essence on/off" and set intensity**

» Touch the essence button in the options screen. Depending on the connected steam generator type, one of the following two submenu views appears:



View when connected to a steam generator of the **HyLine, CompactLine, HeaterLine, HeaterCompact** series.

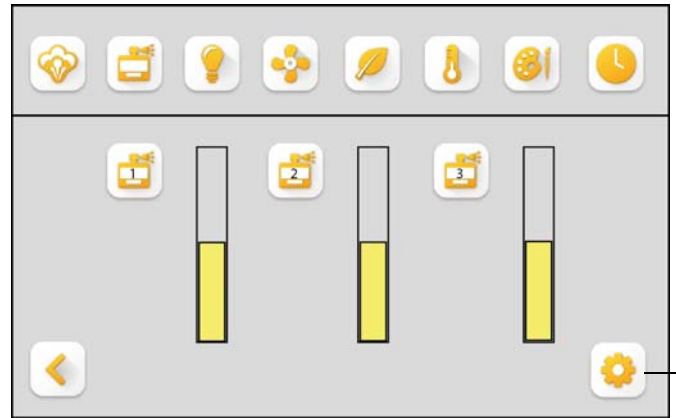

View when connected to a **HeaterSlim** steam generator - 3 different essences can be released for the main screen and their intensity can be preset.

see above

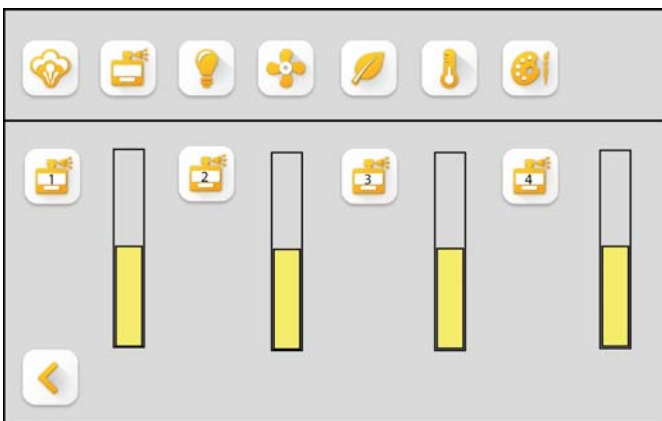

View when connected to a steamgenerator of the **FlexLine series** with 4 essence variants..

**Activate "Essence on/off" for the main screen**

For this purpose the button/s for fragrance/s on the upper left of the bar needs to be touched. The function is thereby enabled. The icon changes its display format (in both screen positions). The length of the bar corresponds to the intensity of the essence saved to the control system.

» Return to options screen with the button  .

**Set essence intensity**

By touching the bar diagram at the top or bottom (Denotes "more" or "less" essence) the preset essence intensity is increased or decreased. Each touch alters the intensity by one step. The scale is comprised of 10 regulating steps. Changes are to be confirmed with  .

» Return to options screen with the button  .

### 9.4.3 Activate the "Light on/off" button for the main screen

- » Touch the button .

#### 9.4.3.1 Particularity for the FlexLine Control

The FlexLine control supports the on/off-switching of 4 light sources. For each of the light sources a button can be offered on the main screen of the SPA Touch Control. To do so, pls. proceed as follows:

- » Touch the light button on the options screen as described above (s. section 9.4.3).

Consequently, an additional options screen opens that allows for the individual selection of one of the light sources 1 to 4:

Four light sources activated for display on the main screen



- » Save the options screen by touching the backarrow button.

After that, the **main screen** exemplarily looks like this:

Main screen with the activation of 4 light sources (among other settings)

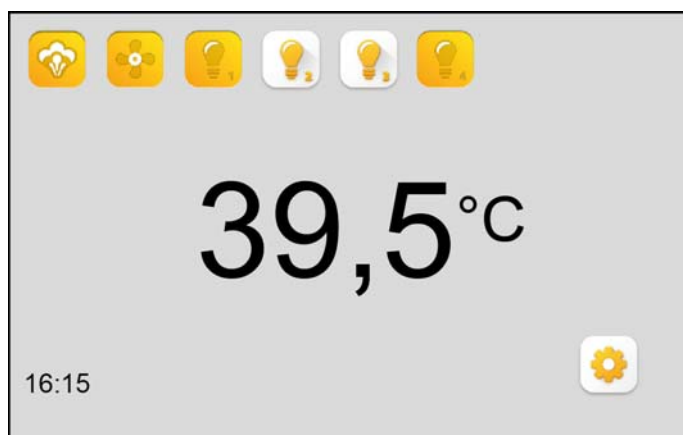

This example main screen shows the light sources 1 and 4 switched on besides the steam production and fan that are also switched on. Additionally, the light sources 2 and 3 can be switched on as well by touching the buttons.



**9.4.4 Activate "Fan on/off" button for the main screen**

» Touch the button  .

**9.4.5 Activate set point temperature display and set point temperature**

» Touch the button  . The following sub-menu screen appears:

**Set point temperature display activation**

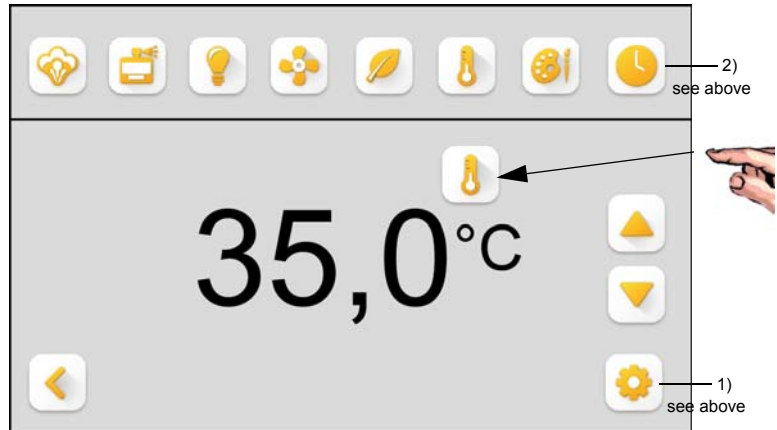



» Touching the button  under the dividing line activates the user temperature display switching option between actual and set point temperature. Without any further entry the temperature displayed in the screen is adopted as the set point temperature.

The screen changes as follows:

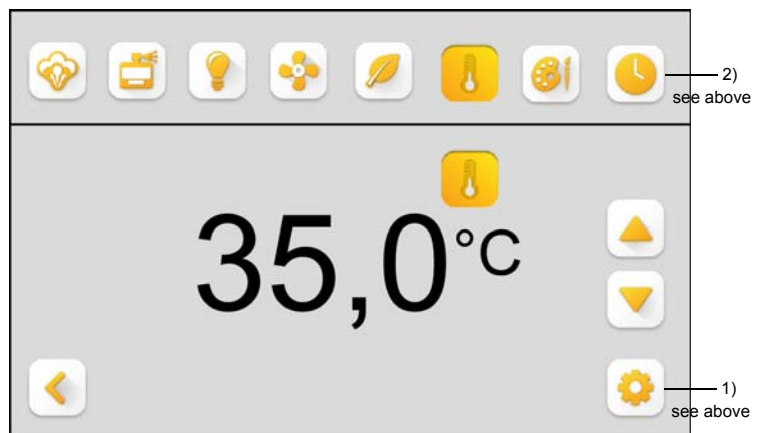
**Enable user switching to set point temperature and setting of the set point temperature**



» To change the set point temperature touch the button  or  .

### 9.4.6 "Eco mode on/off" and set the setback temperature

In eco mode the steam generator operates with lowered steam bath temperature. The eco mode can be combined with other Spa Touch Control functions (e.g. the timer functions). Depending on the steam generator series, the menus for the activation of eco mode in the main screen and the setting of the setback temperature vary.

#### HyLine, CompactLine, HeaterLine and HeaterCompact series

##### Activate "Eco mode on/off" for the main screen

- » Touch the eco button on the options screen. Depending on the connected steam generator type, one of the following two submenu views appears.

##### Activate eco mode

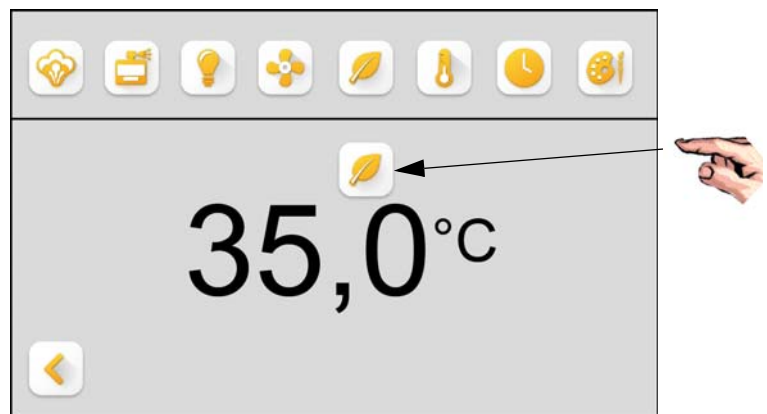

- » Touching the button  below the dividing line activates the eco mode for the main screen. The eco icon changes its display format in both screen positions:

##### Eco mode activated

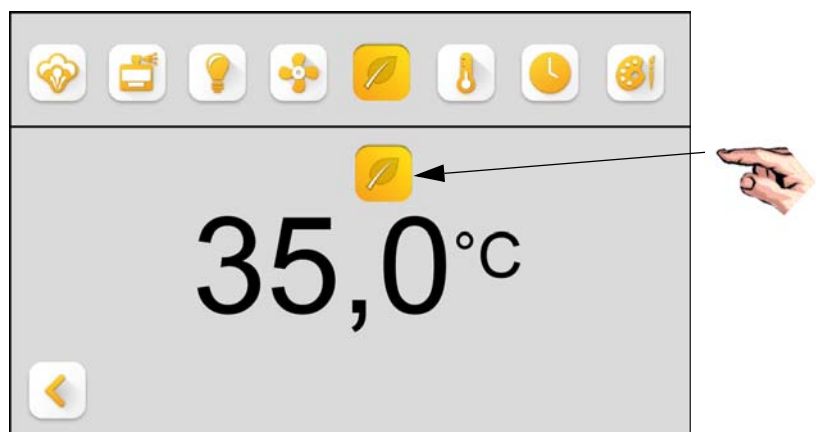

### Set the setback temperature

- » Touching the temperature display in the eco mode sub-menu screen leads to the following sub-menu screen:

#### Setback temperature setting

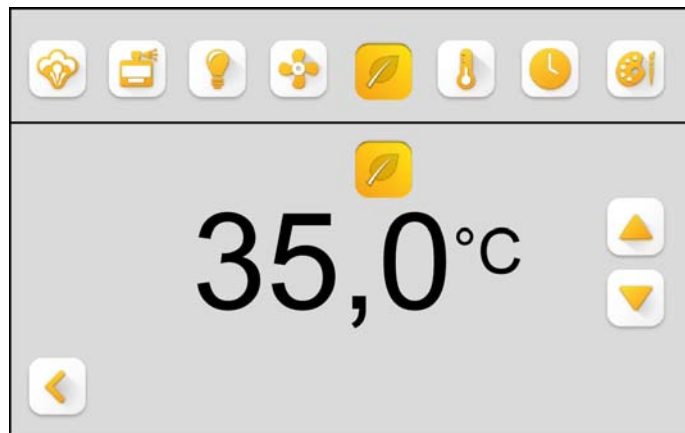

- » With buttons ▲ and ▼ the steam bath temperature for the eco mode can be changed in increments of 0.5 °C. This is possible irrespective of whether the eco mode is activated for the main screen or not. The change is adopted directly.
- » Return to previous screen with the button < .

**HeaterSlim series**

**Activate „Eco mode on/off“ for the main screen**

» Touch the Eco button in the options screen.

**Activate Eco mode**

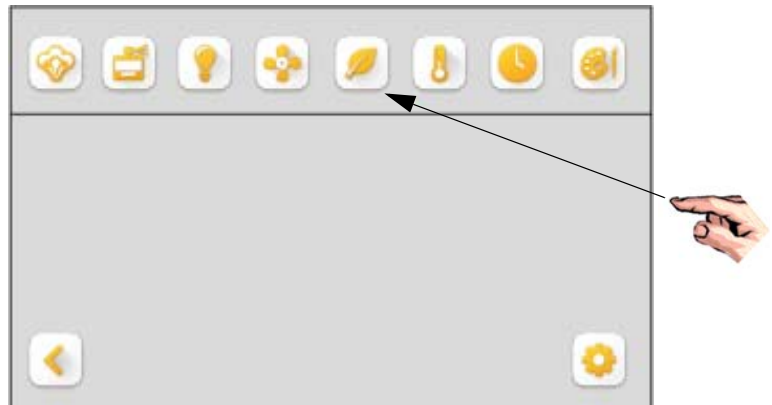

The icon in the options screen changes the display form as shown below:

**Eco mode activated**



**Set the setback temperature**

The eco setback temperature is to be changed in the **HeaterSlim** control parameter list. The list is accessible by touching the „Settings“ icon in the lower right of the options screen. In the list position no. 3 the parameter „ΔTemp.\_ECO“ is offered. By touching the line a virtual keyboard opens allowing for the direct input of the setback temperature within the limits of 0 to 20°C.

**FlexLine** series

**Activate „Eco mode on/off“ for the main screen**

» Touch the Eco button in the options screen.

**Activate eco mode**

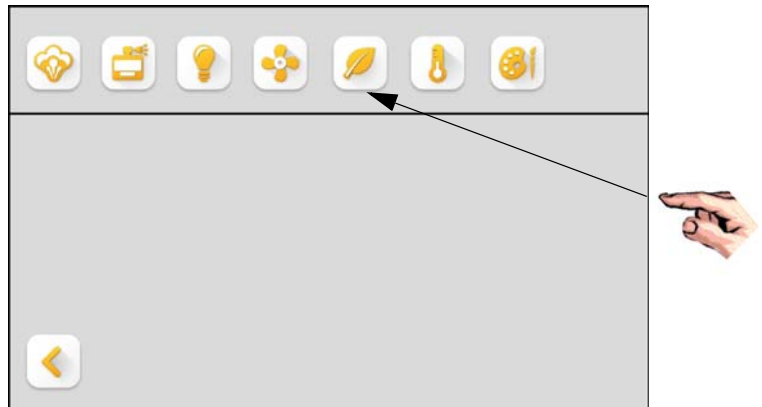

The icon in the options screen changes the display form as shown below:

**Eco mode activated**

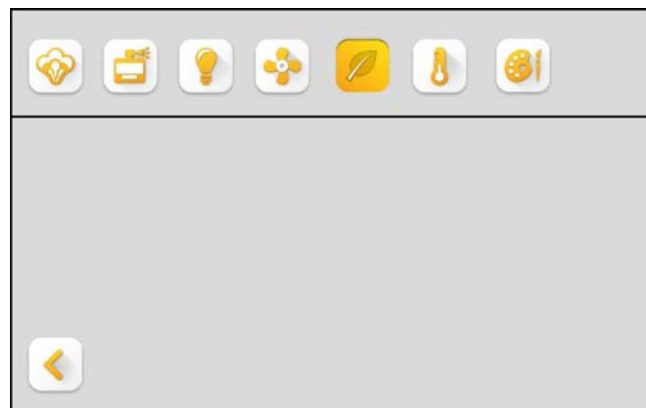

**Set the setback temperature**

The eco setback temperature is to be set in the FlexLine control by means of the „ΔTemp.\_ECO“ parameter in the „13:SPA“ sub-menu  (see section 6.9.2 in the FlexLine Control SPA manual).

Not dependant on the steam generator series, the following exemplary main screen results which enables the user to switch on the eco mode (with the saved setback temperature).

**Main screen with  
activation**

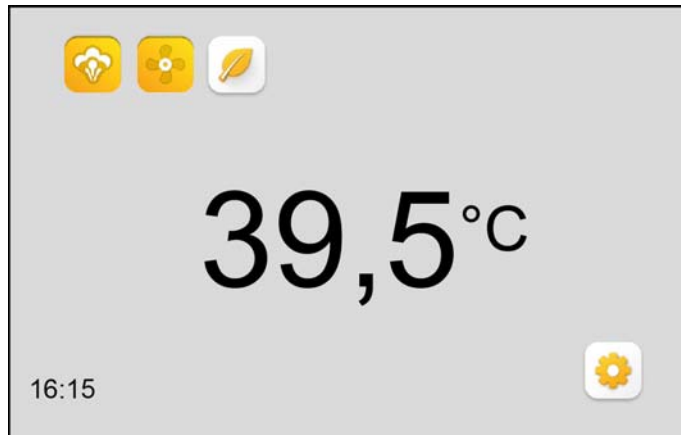

### 9.4.7 Realtime clock setting

**HyLine, CompactLine, HeaterLine, HeaterCompact and Heater Slim series**

» Touch the timer button. The following screen shows up:

Timer screen

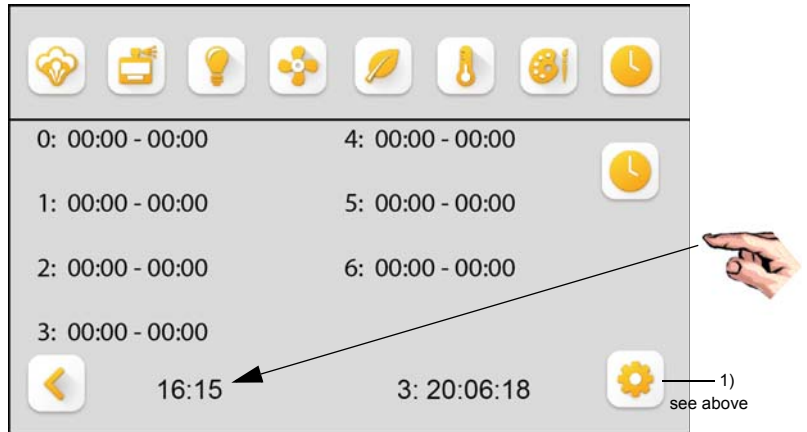

The clock continues to run as long as the display/button of the clock is not touched. When touched the clock is stopped and the (internal) second counter set to "zero". For setting the time the following screen appears:

Realtime clock setting

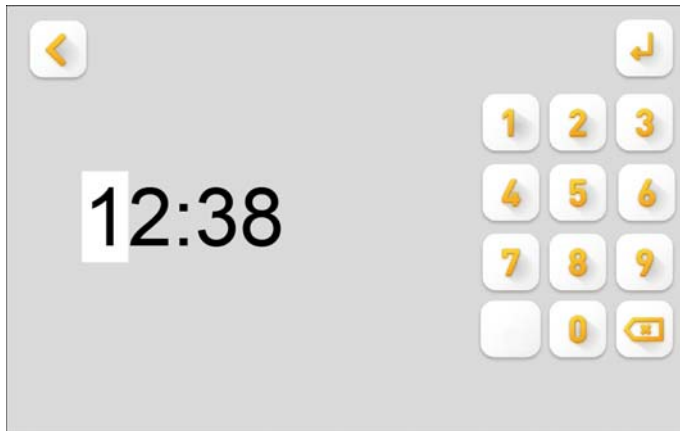



» With the button  return to the previous level is made without changing the time.

If the time setting is to be changed proceed as follows:

- » Overwrite the digit at the cursor position by touching one of the numerical buttons on the keyboard (digits not possible to overwrite are darkened); with the entry the cursor moves to the next position immediately to the right.
- » Overwrite all digits required by the same method. The cursor jumps back to the far left position after reaching the position on the far right. Deliberate return of the cursor to the previous position can be made with the button .

» Use the button  to save settings; the clock starts.

**Please note** If a start is required accurate to the second the operation of the button  must be synchronized with an external time signal.

» Return to main screen with the button .

**FlexLine series**

If the Spa Touch Control is connected to a FlexLine Control SPA, the real time clock of the control is used for controlling the time-of-day display on the Spa Touch Control screen. Setting the real time clock is accomplished in the „03: Settings“ submenu  (s. section 6.6.1 of the FlexLine Control SPA manual).

**9.4.8 Timer function (weekly schedule) activation**

**HyLine. CompactLine. HeaterLine. HeaterCompact and HeaterSlim series**

The weekly schedule enables the setting of day-related intervals for steam supply. The respective interval ("switch-on phase") is specified by the freely programmable switch-on and switch-off points.

The factory settings for switch-on times are:

Weekday	Day coding in display	Start	Finish
Monday	1	0:00	0:00
Tuesday	2	0:00	0:00
Wednesday	3	0:00	0:00
Thursday	4	0:00	0:00
Friday	5	0:00	0:00
Saturday	6	0:00	0:00
Sunday	0	0:00	0:00

In Section "Steam control" it was stated that in timer mode 2 additional variants are possible namely, "Timer mode with manual overwriting" and "Timer mode with manual overwriting and short-term".

For the moment the following section is concerned with the simple timer-mode in which the switch-on and switch-off times directly control the steam supply. The special features of both of the other variants are described subsequently.

**Please note** If simple timer mode without additional functions is to be used the "Steam on/off" button on the options screen must not be activated!



**Settings for operating mode "Timer"**

- » Touch the timer button on the options screen. The following sub-menu screen is displayed (shown here with the factory settings for switching times of the weekly schedule i.e. without entries).

**Timer function activation**

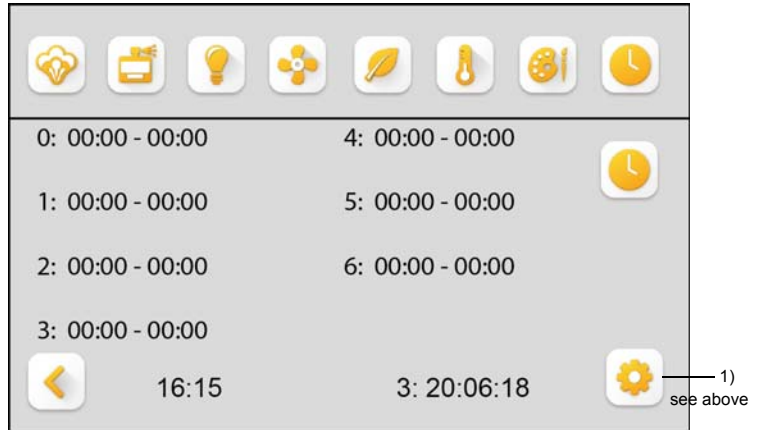

- » To activate the timer function touch the button  below the dividing line. The two button icons change their display format:

**Timer function activated**

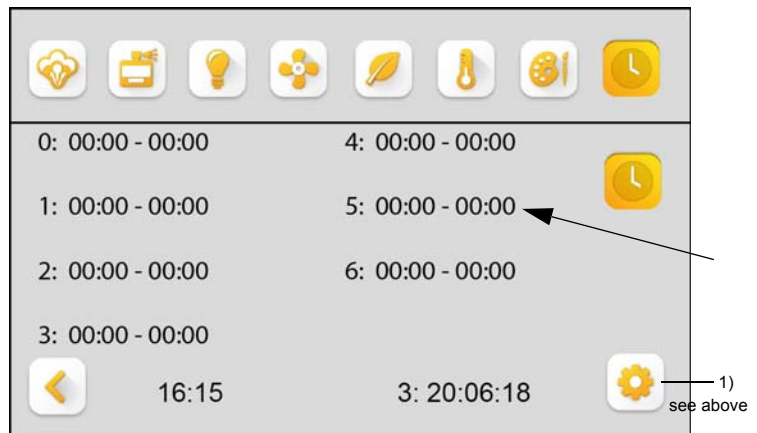



The timer function is now activated with those weekly switching times shown on the screen.

For setting of the switching times the relevant entries must be touched (separate settings for on- and off switch points). For every single switch point the submenu screen shown below opens:

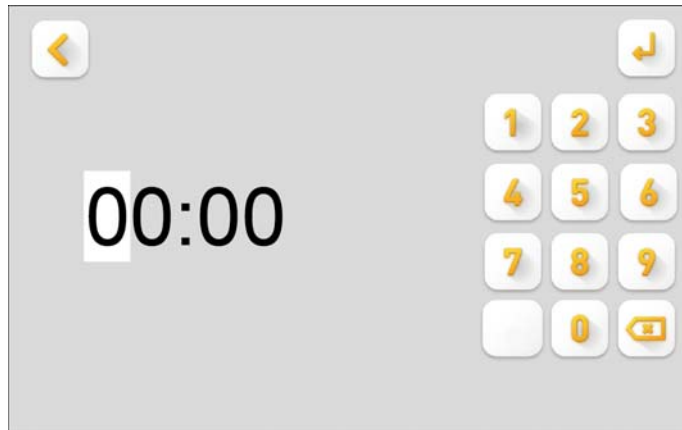
**Set timer switching times**





- » The entry may now be overwritten on a digit-by-digit base
- » Save with the button 
- » Return to previous screen with the button 
- » Return to the options screen with the button 

On the main screen (for the user) the activated timer mode is indicated by the relevant icon next to the daytime clock. The icon functions simultaneously as a status display. It is displayed with a yellow background during the weekly schedule on-phase and with a white background during the off-phase.

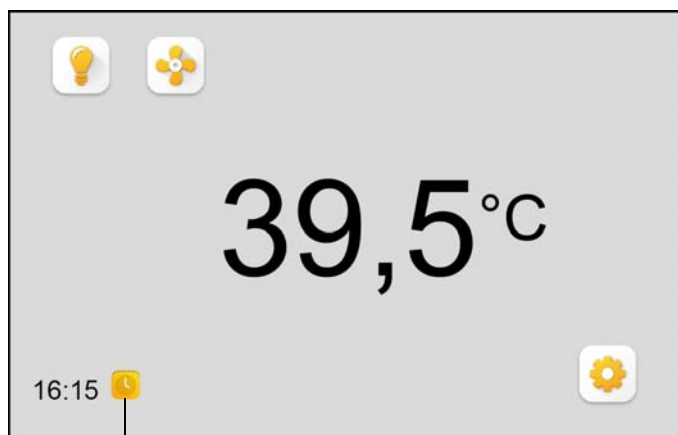
**Main display with activated timer function**





-  Weekly schedule in switch-off phase
-  Weekly schedule in switch-on phase

**Settings for operating mode "Timer with manual overwriting"**

For this operating mode it is necessary to activate the "Steam on/off" button on the options screen in addition to timer activation. Steam mode can be manually started and ended however only then when there is a switch-on phase in the weekly schedule at the same time. When the timer switch-off point is reached the steam supply is switched off. Up to this point in time the steam supply is continuous as long as a manual switch-off is not made. The main screen is presented to the user for example as shown below:

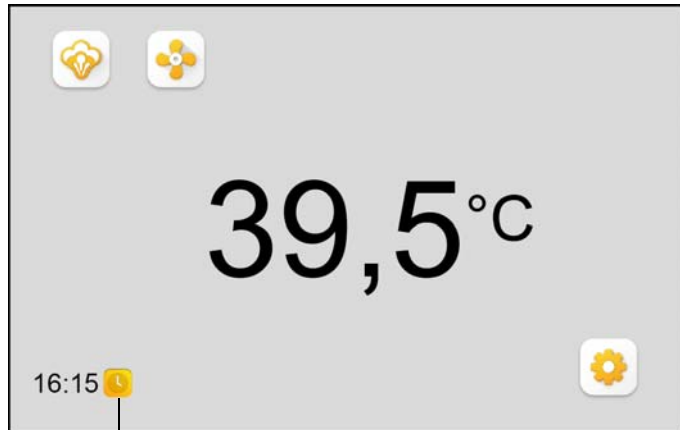
**Timer mode with manual overwriting**



-  Weekly schedule in switch-off phase  
-"Steam on/off" functionless
-  Weekly schedule in switch-on phase  
-steam mode possible by touching "Steam on/off"

**Settings for operating mode "Timer with manual overwriting and short-term"**

To select this operating mode an entry for the short-term mode interval must be made by the operator (see section "Short.term mode" in Section "Manual mode ...setting"), in addition to setting the timer mode and activation of the steam buttons.

If the steam control is in a timer switch-on phase the steam mode starts only after touching the "Steam on/off" button for the duration of the programmed short-term mode interval.

**FlexLine series**

The switching times and related fragrances may be set in the „12: Timer“  submenu (see section 6.9.1 in the FlexLine Control Spa manual).

**9.4.9 Colour combination selection**

For customizing the appearance of the main screen of the Spa Touch Control one of six colour combinations can be selected by the operator for the background and font colours.

The colour selection level is retrieved by operating the button  on the options screen (see Section "Defining the main screen (options screen)").

**Selection of the colour combination**

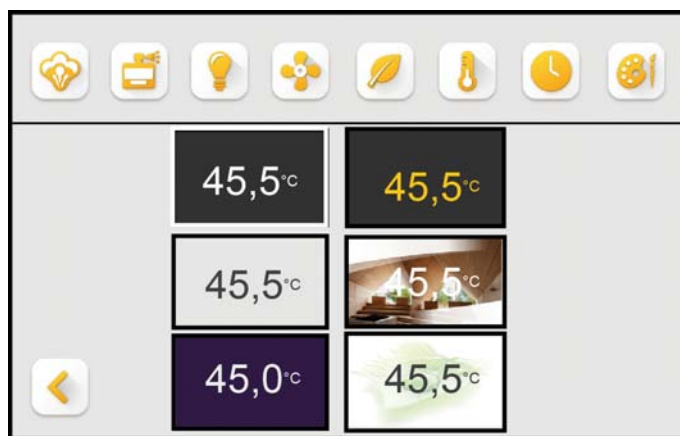





- » Select the required option by touching one of the six colour combination boxes. The screen changes immediately.
- » Accept and return to the options screen with the button  .

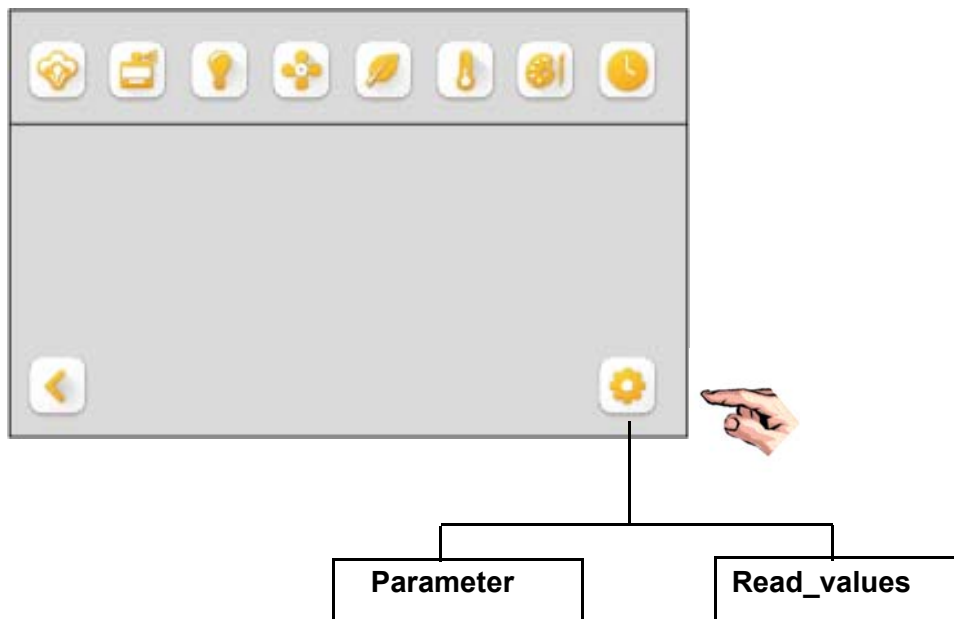

## 10. Parameters and read values when connected to a HeaterSlim steam generator

If the Spa Touch Control is connected to a HeaterSlim steam generator, an extended menu is offered.

After entering the password, the so-called "Selection View" appears. With HeaterSlim connected, this view has another button: 



Touching the button  first opens the **Parameters** submenu, from which you can access the **Read\_values** submenu via the buttons  or .

- » Press the corresponding label to select a parameter. A single view of the parameter opens.
- » Back with  or change value and confirm with .

In the following, the contents and setting options of the submenus **Parameter** and **Read\_values** are displayed in a table.

## 10.1 Tabular overview of parameters

No.	Parameter	Setting range	Unit	Factory-setting	Setting options	Description
1	Language					Language selection
					German	
					French	
					Italian	
					Swedish	
				X	English	
					Spain	
					Russia	
2	Temp_set_value	25,0	49,0	°C	45,0	Target value of steam bath temperature
3	ΔTemp_ECO	0	20	°C	10	The temperature set value is lowered by the amount entered in ΔTemp_ECO when ECO is enabled
4	ΔTemp_steam_off	0,1	5,0	K	0,5	For steam cylinders equipped with only one radiator, the steam production is switched off when (temperature set point +Δ temp._steam_off) is reached. If the steam cylinder is equipped with 2 or 3 radiators, radiator 2 switches off when the above value plus 0.5K has been reached and radiator 3 switches off when the above value plus 1.0K has been reached.
5	ΔTemp_max.	0,1	10,0	K	10,0	Temperature target value plus Δ temp._max. results in absolute max. temperature, at which the unit switches off for safety reasons
6	Runtime limitation	0	1440	min	480	The max. runtime of the timer is given in minutes
7	ΔTemp_steam_boost	0,1	5,0	K	5,0	If a steam impulse is triggered, the setpoint temperature is increased by this value in Kelvin for a certain duration (parameter "Steam impulse_duration")
8	Steam_boost_duration	0	300	s	20	see above
9	Essences_selection					Selection of essence pump
					Off	
				X	Essence 1	
					Essence 2	
					Essence 3	
10	ΔTemp_essence	0,1	30	K	25	Essence injection is enabled at steam bath temperature = (Temp_set_value - ΔTemp_essence)
11	Intensity_essence 1	0	10		5	The intensity of the fragrance injection of essence pump 1: The intensity of the fragrance injection can be gradually changed from 0... 10, whereby "0" switches off the respective essence
12	Interval_essence 1	0	30	min	5	The interval between the injections of fragrance in min.
13	Duration_essence 1	0	30	s	3	The duration of an essence injection process
14	Intensity_essence 2	0	10		5	according to the explanations for essence 1
15	Interval_essence 2	0	30	min	5	according to the explanations for essence 1
16	Duration_essence 2	0	30	s	3	according to the explanations for essence 1
17	Intensity_essence 3	0	10		5	according to the explanations for essence 1
18	Interval_essence 3	0	30	min	5	according to the explanations for essence 1
19	Duration_essence 3	0	30	s	3	according to the explanations for essence 1
20	Exhaust_fan_mode					Operating mode of steam bath fan
					Off	permanently off
					On	permanently switched on
				X	Automatic	according to the control settings (please see parameter 21)
21	Exhausts_fan_Δ temp.	0	5	K	0,5	Steam bath fan is switched off when Temp_set_value + steam bath fan_Δ Temp. has been reached
22	(Exh.)Fan_run-on	0	255	min	0	Delay time of exhaust fan in automatic mode in min. Used for supporting drying of the steam cabin after the end of operation
23	Supply_fan_mode					Operating mode fan
					Off	off
					On	Continuous operation, if unit control switch is in pos. "I"
				X	Automatic	Steam bath fan runs during steam production and is switched off when (Temp_set_value + Supply_fan_Δ temp.) has been reached
24	Supply_fan_Δ temp.	0	5,0	K	0,5	Temperature difference above target value which must be achieved for steam bath fan to be switched off
25	(Sup.) Fan_run-on	0	255	min	0	Follow-up time of the supply fan in automatic mode in min. Can be used for supporting drying of the steam cabin after the incoming operation

### Continuation of the tabular overview of the parameters

26	Assignment_relay 1					The relay is energized for a message (M) or switching function (S) if...
					Collective_fault	a persistent fault is present (M)
					Service_message	a service message exists (M)
					Humidification	steam is produced (M)
					Safety_interlock_open	the safety chain is open (M)
					Essence 1	Essence pump 1 should be activated (S)
					Essence 2	Essence pump 2 should be activated (S)
					Essence 3	Essence pump 3 should be activated (S)
					Exhausts_fan	Steam bath exhaust fan should be activated (S)
				X	Supply_fan	Supply fan should be activated (S)
					Light	Light should be activated (S)
27	Assignment_relay 2				Exhaust_fan	same as relay 1
28	Assignment_relay 3				Essence 1	same as relay 1
29	Assignment_relay 4				Light	same as relay 1
30	Digital_input_function					The digital input is assigned a logical meaning according to the selection list via this parameter. The digital input must be wired by the customer according to its use, e. g. with a push-button or a switch (NO)]. When the switch or push-button is actuated, the programmed switching function is carried out
					Off	Digital input without function
				X	Steam_boost	Activation of the steam boost function (see above) via a pushbutton
					Light	Switching of the light function (ON or OFF) via a pushbutton
					Timer_start	Activation of the timer function via a push-button
					ECO	Switching of the ECO function (On or OFF) via a push-button
					1-step	Activation of the 1-step control mode (please see parameter 35) via a switch
31	Timer_mode					
				X	Off	The timer function is not available
					Steam_off	Steam production stops after the timer has elapsed
					Humidification_ECO	The unit reverts to ECO mode after the timer has elapsed
32	Timer_running_time	0	1440	min		The running time of the timer is set in minutes
33	Start_blow-down					The cylinder water can be drained when the unit is switched on via the main switch
					Off	function disabled
				X	On	function enabled
34	Standby_blow-down	0	2880	min		If the unit was switched on for an extended period without a demand arising, or if the safety chain was opened for an extended period, a draining of the cylinder water is performed to prevent germ formation. The interval for triggering the blow-down is defined with the "Standby_blow-down_interval" parameter
35	Control					The control mode of the device is selected here:
				X	Temperature	A temperature sensor connected to the device gives a temperature actual value to the controller, which compares it with the set temperature set point and thus calculates the steam requirement
					1-step	The steam generator is controlled by a higher-level control system via the digital input (see parameter 30); <b>Function:</b> Digital input potential-free closed = steam production ON; digital input open = steam production OFF. <b>Note:</b> The steam generator does not control the temperature. External control devices must be used to protect against excess temperature in the steam room. <b>Note:</b> After adjustment to a 1-stage control mode, the device should be switched off and on again by means of the main switch to ensure stable operation of the device.
36	Service-reset					After a preset quantity of steam produced, the steam generator triggers the service message "Steam_counter".
				X	Off	Displayed for information only
					On	The steam counter for triggering the service message is reset
37	Main_contactor_1_reset					After a preset number of switching cycles of the main contactor, the steam generator triggers the service message "Cycles_main_contactor 1"
				X	Off	Displayed for information only.
					On	The counter for the switching cycles of the main contactor is reset
38	Factory-Reset					When a factory reset is performed, all parameters are reset to factory default
				X	off	Displayed for information only
					on	Activation of the factory reset

## 10.2 Tabular overview of Read\_values

No.	Reading value	Unit	Possible displays	Description
1	Status_unit			The status of the device is described.
			Safety_interlock_open	The safety chain (between terminals 1 and 2) is open.
			No_Demand	There is no demand for steam production.
			Humidification	The steam generator produces steam.
			Runtime_limitation	The steam generator operates at a time interval after which the steam production is stopped.
			Remote_off	The operation of the device was switched off by a Modbus RTU control command. Further information on communication via Modbus is given in the separately available "Quick Start Guide for HygroMatik Modbus RTU".
			Timer_steam_off	Steam is not produced after the timer has expired
			Humidification_ECO	Steam is produced in ECO mode.
			No_demand_ECO	There is no demand for steam in ECO mode.
			Filling	The steam cylinder is filled with water.
			blow-down	The steam generator drains water.
			Start_blow-down	The steam generator carries out a blowdown during the start sequence.
			Standby_blow-down	The steam generator carries out a standby blowdown.
			Fault_message	There is a fault signal (see also reading value 2).
			2	Fault_message
			No_fault	
			blow-down	
			Full_blow-down_counter	
			Filling	
			Thermoswitch	
			Max.-level	
			Water_level	
			Water_level_sensor	
			Steam_down_time_max.	
			Temp._sensor	
			Temperature_max	
			Internal	
			3	Service_message
			No_service_msg.	
			Steam_counter	
			Cycles_main_contactor 1	



Continuation of the tabular overview of reading values

4	Temp._actual_value	°C		The temperature value measured by the temperature sensor connected to the HeaterSlim is displayed.
5	Temp._set_value	°C		The setpoint of the steam bath temperature is displayed.
6	Water_level_max.	digits		Measured value of the water level sensor in digits - only for service purposes
7	Water_level_steam	digits		Measured value of the water level sensor in digits - only for service purposes
8	Water_level_dry	digits		Measured value of the water level sensor in digits - only for service purposes
9	Water_level_max.			The water level measurement is carried out in three steps. When reaching the maximum level, "ON" appears in this reading value; if the maximum level is not reached, "Off" appears here.
			Off	
			On	
10	Water_level_steam			The water level measurement is carried out in three steps. When the operating (steam) level is reached, "ON" appears in this reading value; if the operating level is not reached, "Off" appears here.
			Off	
			On	
11	Water_level_dry			The water level measurement is carried out in three steps. When reaching the dry level, "ON" appears in this reading value; if the operating level is not reached, "Off" appears here.
			Off	
			On	
12	Part._blow-down_counter	kg		The HeaterSlim steam generator carries out a partial blowdown in kilograms according to the amount of steam shown here. Part of the cylinder water is pumped into the drain. On the one hand, this periodic partial blowdown prevents excessive concentrations of cylinder water with dissolved salts and on the other hand, small lime particles are also removed.
13	Operating_time	h		The total operating time of the device is displayed.
14	Steam_amount_counter	kg		The total amount of steam produced by the unit is displayed.
15	Steam_until_msg.	kg		The steam quantity is displayed, which can still be produced until the next service message ("Steam_counter") is issued.
16	K1_switching_cycles_until_ms g.			The remaining number of switching cycles that the main contactor can still switch are shown until the next service message Main contactor ("Cycles_main_contactor 1") is issued.
17	Software version			The software version of the display is shown here.

This page intentionally left blank

This page intentionally left blank

## **11. Technical specifications**

### **Monitor**

- 5" capacitive touchscreen (PCT touchscreen)
- Resolution 800 x 480 pixels
- 65K colour saturation
- Protection class IP65 front (rear IP00)

### **Overall assembly (Screen and electronic assembly)**

- Operating temperature 0 to 55 °C
- Humidity: 10 to 60% relative humidity; non-condensing
- EMC compatibility: EN/IEC 60730-1

### **Electronic module**

- connected to screen by sandwich construction
- Power supply 12V AC via data cable (external feed by steam generator)
- RS485 interface for connection to the steam generator (Modbus RTU protocol)
- Protection class IP00 together with screen, but frontal IP65

Dimensions

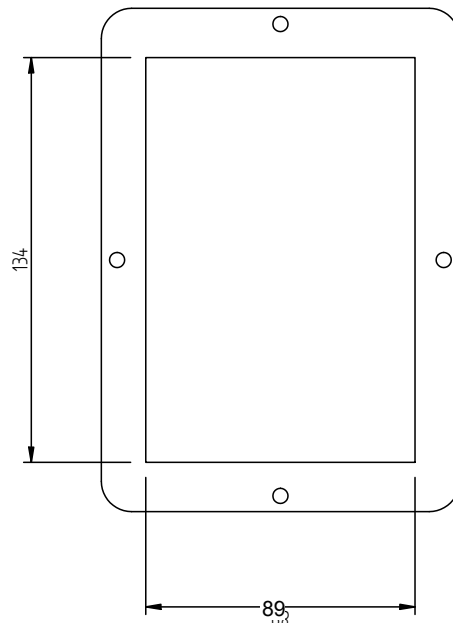
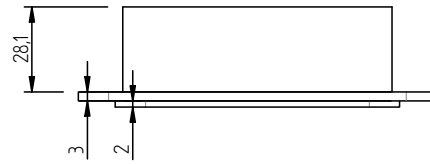
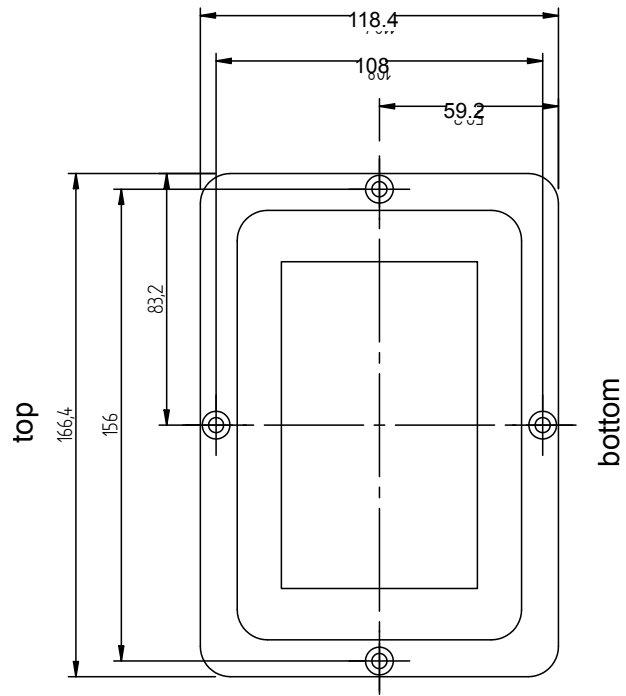

**Installation well**

- Steel construction 1.4301

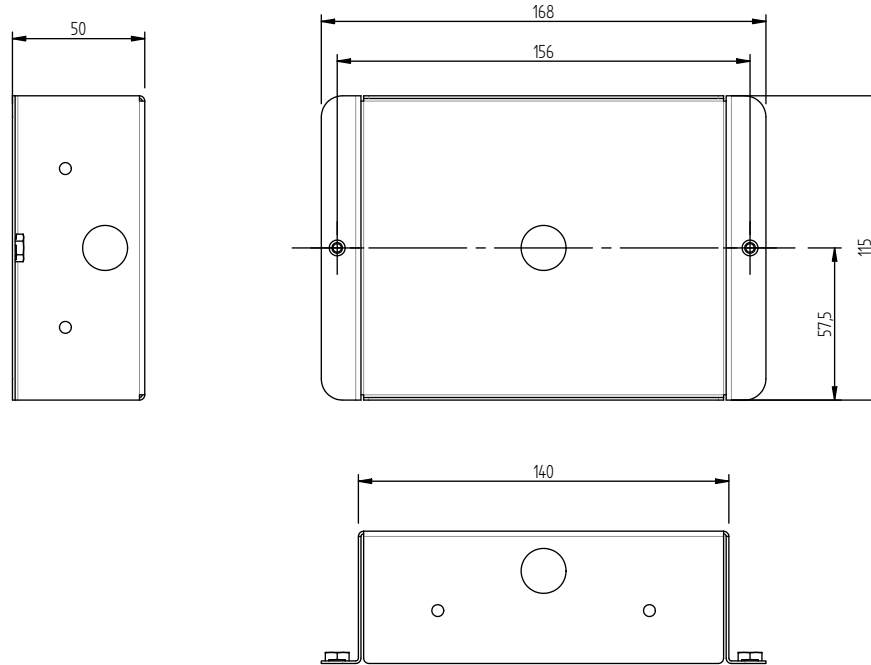
**Dimensions****Installation bolts**

- 2 off countersunk bolts M4 x 8

**Face cover**

- Aluminium black anodized

Dimensions

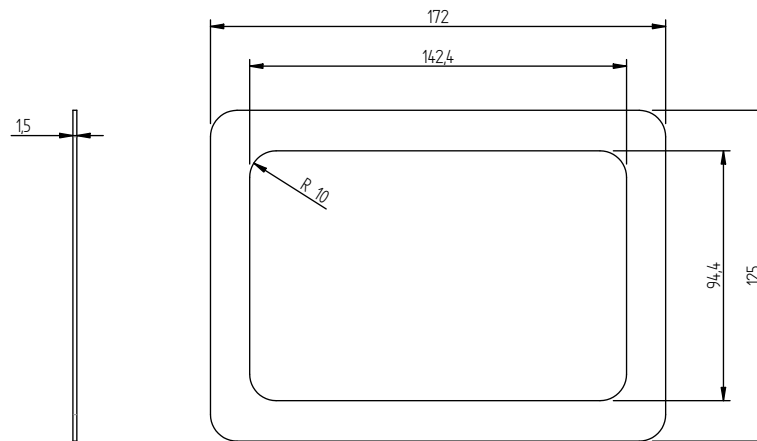

**HygroMATIK<sup>®</sup> SPA**

HygroMatik GmbH  
Lise-Meitner-Str. 3  
24558 Henstedt-Ulzburg  
Germany

T +49 4193 895-0  
F +49 4193 895-33  
hy@hygromatik.de  
www.hygromatik.com

member of **CAREL-group**

