

TECHNICAL SPECIFICATIONS

SPECIFICATION FOR SUPER-STRUCTURE OF BRIDGES

1.0 Books of reference

For the guidance of the bidder, list of the reference books, codes and manuals are given herewith. The list is only tentative. Additional documents as per the requirement of the engineer be referred to. Bidders are required to adhere to the latest instructions, updated versions and revised editions of the documents.

Railway/IRS books of reference:

- i. IRS Rules Specifying the Loads for Design of Super-Structure and Sub-Structure for Bridges (Bridge Rules)
- ii. Indian Railways Standard Code of Practice for the Design of Steel or Wrought Iron Bridges Carrying Rail, Road or Pedestrian Traffic (Steel Bridge Code)
- iii. IRS Code of Practice for Metal Arc Welding in Structural Steel Bridges Carrying Rail, Rail-cum-Road or Pedestrian Traffic (Welded Bridge Code)
- iv. IRS Specification for Fabrication and Erection of Steel Girder Bridges and Locomotive Turn-Tables: Fabrication Specification (B1)
- v. IRS Code of Practice for Plain, Reinforced & Prestressed Concrete for General Bridge Construction (Concrete Bridge Code)
- vi. Indian Railways Schedule of dimensions for Broad Gauge. -2005
- vii. Indian Railways Bridge Manual, 1998.
- viii. Indian Railways P. Way Manual. 2004
- ix. Indian Railways Works Manual. 2000
- x. M-3: Class I, II, III and IV steel forgings, blooms for forging and billets for rerolling
- xi. M-28: Classification, Testing and approval of metal-arc welding electrodes for use on Indian Railways.
- xii. M-39: Classification, testing and approval of submerged arc welding wire flux combination
- xiii. M-41: Corrosion resistance steel
- xiv. M-42: High strength low alloy structural steel with enhanced corrosion resistance
- xv. M-43: High strength low alloy structural steel rivet bars with enhanced corrosion resistance.
- xvi. P-31: Zinc chromate red oxide primer
- xvii. M&C/PCN/102/96: Epoxy zinc phosphate primer
- xviii. M&C/PCN/103/86: Epoxy micaceous iron oxide
- xix. M&C/PCN/109/88: Polyurethane red oxide
- xx. M&C/PCN/110/88: Polyurethane aluminium
- xxi. M&C/PCN/111/88: High build epoxy paint
- xxii. RDSO/M&C/Specification: Classification, testing and approval of CO₂ welding filler wires for use on Indian Railways

Indian Roads Congress codes and specifications:

- i. IRC-21: Standard specifications and Code of practice for Road Bridges- Sections – III- Cement concrete (Plain & reinforced)

- ii. IRC-24: Standard specifications and Code of Practice for Road Bridge –Section –V- Steel Road Bridges.
- iii. IRC- 83: Bearings for bridges.
- iv. IRC-87: Design and erection of false work for road bridges

Indian Standards Codes & Specifications:

- 1) IS: 2062 –2011 Steel for general structural purposes.(new code includes the provisions of IS:1077 & IS: 8500)
- 2) IS: 1786- High strength deformed steel bars & wires for concrete reinforcement.
- 3) IS: 1148- Hot rolled rivet bars (up to 40mm dia) for structural purposes.
- 4) IS: 1149- High tensile steel rivet bars for structural purposes.
- 5) IS: 1929 – Hot forged steel rivets for hot closing (12 to 36mm dia)
- 6) IS: 2004 Carbon steel forgings for general engineering purposes.
- 7) IS: 57 – Red lead for paints and other purposes.
- 8) IS: 75 – Linseed oil, raw and refined.
- 9) IS: 77 – Linseed oil, boiled for paints.
- 10)IS: 102 Ready mixed paints, brushing, red lead, non-settling, priming.
- 11)IS: 123 – Ready mixed paints, brushing, finishing, semi-gloss, for general purposes to Indian Colours etc.
- 12)IS: 2339- Aluminum paints for general purposes, in dual container.
- 13)IS: 280- Mild steel wire for general engineering purposes.
- 14)IS: 456- Plain and reinforced concrete.
- 15)IS: 883 – Design of structural timber in buildings.
- 16)IS: 814- Covered electrodes for manual metal arc welding.
- 17)IS: 1182- Radiographic examination of butt joints in steep plates.
- 18)IS: 2595- Radiographic testing.
- 19)IS: 383- Coarse and fine aggregates from natural sources for concrete.
- 20)IS: 2386 (all 8 parts) – Tests for aggregates for concrete.
- 21)IS: 3025 (all 49 parts) – Methods of sampling and test for water and waste water.
- 22)IS: 1791 – Batch type concrete mixers.
- 23)IS: 4634- Methods of testing performance of batch type concrete mixers.
- 24)IS: 6925- Methods of test for determination of water-soluble chlorides in concrete admixtures.
- 25)IS: 9103 – Admixtures for concrete.
- 26)IS: 516 – Method of test for strength of concrete.
- 27)IS: 4031 (all 15 parts) - Physical tests for hydraulic cement.
- 28)IS: 5513- Vicat apparatus.
- 29)IS: 10080- Vibration machine for casting standard cement mortar cubes.
- 30)IS: 10262- Concrete mix design.
- 31)IS: 1343 – Prestressed concrete.
- 32)IS: 875 (all 5 parts) – design loads (other than earthquakes) for buildings and structures.
- 33)IS: 2720 (all 41 parts)- Method of tests for soils.
- 34)IS: 800 General constructions in steel.
- 35)IS: 786- Conversion factors and conversion tables.
- 36)IS: 1024 – Welding in bridges and structures subject to dynamic loading.
- 37)IS: 1261 - Seam welding in mild steel.
- 38)IS: 1367 (all 20 parts) - threaded steel fasteners.
- 39)IS: 6639- Hexagonal bolts for steel structures.

- 40)IS: 104 – Ready mixed paint, brushing, zinc chrome, priming.
- 41)IS: 2074- Ready mixed paint, air drying, red oxide-zinc chrome, priming.
- 42)IS: 1852- Rolling and cutting tolerances for hot rolled steel products.
- 43)IS: 1270- Metric steel tape measure.
- 44)IS: 9595- Metal Arc Welding.
- 45)IS: 487- Brush, paint and varnish.
- 46)IS: 1030 – Carbon steel castings for general engineering purposes.
- 47)IS: 3400 (all 22 parts) - Methods of tests for vulcanized rubbers.
- 48)IS: 1915- Steel bridge code
- 49)IS: 1893- Earthquake resistant design of structures.
- 50)IS: 3502- Steel Chequered plates.
- 51)IS: 3085- Method of test for permeability of cement mortar and concrete.
- 52)IS: 7320 – Concrete slump test apparatus.
- 53)IS: 5515- Compaction factor apparatus.
- 54)IS: 6586- Metal spraying for protection of iron steel.
- 55)IS: 5666- Etch primer.
- 56)IS: 3955- Design and construction of well foundations.
- 57)SP 6, 7, 16, 21, 22, 23, 24, 34, 36, 52, 60.
- 58)IS: 2911- Design and construction of pile foundation.
- 59)IS; 7205- Safety code for erection of structural steel work.
- 60)IS: 8629- Protection of iron and steel structures form atmospheric corrosion.
- 61)IS: 5624- Foundation bolts.
- 62)IS: 7215- Tolerances for fabrication of steel structures.
- 63)IS: 8112- 43 Grade OPC.
- 64)IS: 4326- Earthquake resistant design and construction of buildings.
- 65)IS: 13920- Ductile detailing of reinforced concrete structures subjected to seismic forces.
- 66)IS: 34 – White lead for paints.
- 67)IS: 887 – Animal tallow.
- 68)IS: 816- Metal arc welding for general construction in mild steel.
- 69)IS: 819- Resistance spot welding for light assemblies in mild steel
- 70)IS: 1024 – Welding in bridges and structures subject to dynamic loading.
- 71)IS: 1261- Seam welding in mild steel.
- 72)IS: 1323- Oxy-acetylene welding for structural work in mild steel.
- 73)IS: 4081- Safety code for blasting and related drilling operations.
- 74)IS: 3764- Safety code for excavation work.
- 75)IS: 7293- Safety code for working with construction machinery.
- 76)IS: 817- Training and testing of metal arc welders.
- 77)IS: 1200 (all relevant parts)- Method of measurement of building and civil engineering works.
- 78)IS: 2132- Thin walled tube sampling of soils
- 79)IS 2131- Standard penetration test for soils.

Miscellaneous:

- i. UIC-772R: Bearings of rail bridges.
- ii. BS-5400 (all parts)
- iii. BS-1449, 3484, 1134, 5296
- iv. ASTM/AASHTO

Note: The books of reference shall also include further references mentioned in above-mentioned books of references. All the books, references and codes shall be of latest edition with up to date correction slips.

1.1 **GENERAL** :

The girders shall be steel girders or Concrete members as per approved drawings. Cast-in-situ method may also be adopted if approved by the Engineer for other members of the structure.

Steel grade conforming to IS: 2062-2011 (with latest amendment), is proposed to be used for all components for all spans as per approved drawings.

The steel shall comply in all respects with the requirements of approved drawings and relevant codes and specifications and shall be procured from approved manufacturers only. It may be noted that quality of steel used for fabrication shall be the essence of the contract & shall be rigidly followed. Steel sections to be supplied by the manufacturers shall be Ultrasonically tested as per codal provisions at the manufacturer's premises before dispatch. The Contractor on receipt of supply in his factory premises/fabrication workshop shall carryout random USFD testing as per standards laid down in various codes and verify them with the list received from manufacturers. Only tested steel shall be used for fabrication. All rolled sections shall bear cast mark and shall be of such length as to avoid butt welded joints in components of truss. Such rolled sections shall be within rolling tolerances stipulated as per IS:1852 and shall be defects free.

- (i) Only weldable steel conforming to IS: 2062 Steel fusion welding quality shall be used for fabrication of Steel Channels Sleepers.
- (ii) No Re-rolled Steel should be used.
- (iii) Steel should be procured only from SAIL, RINL, TISCO or JINDAL such reputed steel manufacturers only. The source of steel should be got approved by the Engineer / Employer.
- (iv) In support of purchase copy of vouchers are to be submitted.

The tenderer(s) shall supply information in the tender regarding source/manufacturers from where procurement of steel is proposed by him/them. However, the usage of type and grade of steel may vary during the execution of the work depending upon the design requirement and market availability. No claim shall be entertained from the Contractor on this account and payment shall be as per relevant items in the schedule of items, quantities and rates.

Steel for rivets shall conform to IS:1148 for M.S and IS:1149 for H.T.S.

Welding consumables for Manual Metal Arc Welding (MMAW) shall conform to IRS-M-28, wire and flux combination for submerged arc welding to IRS M-3 and filler wires for CO2 welding to RDSO/M&C/Specification issued vide letter No. M&C/W/111/24 dated 1.1.1994/7.2.1994.

All welding consumables (electrodes, wire, flux etc.) shall be procured only from the manufacturers approved by RDSO subject to final approval by Engineer.

All materials for the work shall pass tests and/or analysis prescribed by the relevant IS specifications or such other equivalent specifications.

For all materials including rivets and bolts, the Contractor shall furnish copies of test certificates from the manufacturers including proof sheets, mill sheets etc. showing that the materials have been tested in accordance with the requirements of various specifications and codal provisions.

If any further testing of materials is required by Engineer in respect of these and other items, it shall be arranged for by the Contractor at a reputed laboratory/National test house as approved by Engineer. For this, nothing extra shall be payable and accepted rates in the schedule of items, quantities and rates shall be deemed to include this.

Even satisfactory outcome of such tests or analysis shall in no way limit, dilute or interfere with the absolute right of the Engineer to reject the whole or part of such materials supplied, which in the judgment of the inspecting authority does not comply with the conditions of the contract. The decision of the Engineer in this regard shall be final, binding and conclusive for all purposes.

- 1.2 The contractor should prepare Quality Assurance Plan (QAP) based on RDSO guidelines for fabrication of girders and get the same approved from the Engineer before proceeding with the work. Girders should be got fabricated by a firm who has full fledged fabrication workshop and should have valid certification of RDSO for fabrication of girders. Any another procedure will require approval of Engineer.

2.0 ASSEMBLING/ ERRECTION OF STEEL GIRDERS

Fabrication and Workmanship

2.1 General

Fabrication, Workmanship shall generally comply with current IRS specification No.B1-2001 with latest correction/amendments thereof unless otherwise specified in special conditions of this contract or as specially directed by the Engineer in writing.

The fabrication of the girders and its accessories shall be carried out by the Contractor in his factory premises or in a well-established fabrication workshop to be set up by the Contractor at bridge site or any other location as approved by the Engineer. The workshop staff shall have requisite experience, proven skill and experience in the technique of fabricating large components. Accuracy of fabrication shall be realized through controlled high precision jigs, fixtures and templates, which shall be inspected and passed by Engineer / any other inspection agency as nominated by Engineer. The fabrication shall be preceded by Quality Plans to be submitted by the Contractor and every activity shall be documented in detail. The Quality Plans shall clearly indicate how individual processes such as cutting of raw steel, marking, drilling, assembly, riveting/welding, painting, handling etc shall be monitored for quality. The quality parameters for monitoring shall be identified alongwith monitoring frequency and quality records to be maintained. The officials responsible for monitoring these identified quality parameters shall also be specified in these quality plans. The Contractor shall get these quality plans approved from Engineer before start of

fabrication work. The Engineer shall be empowered to check the manufacturing process from time to time to ensure that the work is executed as per approved quality plans. The quality records shall be submitted to Engineer for record, after completion of fabrication work.

The work of fabrication in Contractor's fabrication shop will at all times be open for inspection by Engineer or any other agency as nominated by Engineer. Before dispatch of fabricated steel work from the shops the same will be inspected in the Contractor's fabrication workshop by Engineer or any other authority/agency nominated by Engineer who will thereafter issue inspection certificate.

Any defects noticed during inspection in the execution of work shall be rectified or replaced by the Contractor at his own cost. The decision of Engineer or any other agency nominated for inspection as to the existence of the defect, the manner in which the defective work has to be rectified or replaced, shall be final and conclusive.

In the fabrication of girder, necessary arrangement and provision shall be kept for inspection facilities underneath the girder and also for carriage of service cables, pipe lines etc as per approved plan.

2.2 Fabrication Drawings

The Contractor shall prepare detailed shop drawings including drawing office dispatch lists (DODL's) on the basis of design drawings supplied by Engineer, in such size and in such details as may be specified by Engineer. The shop drawings shall be submitted to Engineer in triplicate, one copy of which will be returned after scrutiny and approval. The fabrication drawings shall indicate member sizes prior and after flame cutting, machining to obtain correct length and shape, tolerance provisions, welding sequence, type and size of welding. No work of fabrication will be started without such approval being obtained. Engineer will make all efforts to approve the drawings submitted by the Contractor within reasonable time but no claim from Contractor for any delay on this account shall be entertained by Engineer.

For Engineer's use and record, the Contractor shall supply free of charge, four sets of prints on strong paper and one set of neatly executed tracings of all approved detailed drawings and fabrication drawings, soon after communication of approval, for use at site.

2.3 Maintenance of records by Fabricators

The records of fabrication shall be maintained in the registers as per the formats given in the Appendix I of B-1 Specification. For ready reference, extract of the same has been given in the end of this specification as well.

2.4 Tolerances in Fabrication

Fabrication tolerance for girders shall be as stipulated in Appendix II of IRS-B1-2001 (with latest revision). Permissible deviation for driven rivets shall be as stipulated in Appendix-IV of IRS-B1-2001 (with latest revision).

2.5 Testing of the Materials

In addition to the test certificate obtained from the steel producers/suppliers/dealers, for conformity sake, all materials/consumables, i.e. steel, rivets, welding electrodes, paints, etc shall be got tested from the NABL approved labs/recognized labs. Proper record of all such test results shall be maintained. A copy of the same be given to client/IRCON as well. Test result of the supplier and that of the lab should match with each other. In case of major difference, matter has to be investigated. Decision of the IRCON shall be final in that regard.

Rolled steel shall also be ultrasonically tested by the reputed firm. Only ultrasonically tested steel shall be used for fabrication work. Record of ultrasonically tested steel shall be maintained separately.

All the testing work shall be done in accordance to the provisions of the relevant codes.

Regarding radiographic testing/x-ray testing of the welded joints, matter shall be finalized in consultation with the inspecting authority, i.e. RDSO. Agreed to procedures shall be followed. Necessary arrangement for that has to be got done by the tenderer at their own cost.

All testing work shall be got done by the contractor at their own cost. Nothing extra shall be paid. Tenderers should quote their rate accordingly.

2.6 Fabrication / Manufacture

The whole work shall be representative of the highest class of workmanship. The greatest accuracy shall be observed in the design, manufacture and erection of every part of the work to ensure that all parts will fit accurately together on erection. For manufacture of the components of all spans to be made strictly interchangeable as specified in 'interchangeability' criteria given in this specification on the subsequent pages, approved set of same jigs and assembly fixtures shall be used. The tolerances in manufacture shall be in accordance with as shown in Appendix III of IRS B-1-2001 Specification. For ready reference, the same are also produced in the end of this technical specification (Quality control portion of this specification).

The Contractor shall state which of the following alternative methods of manufacture he/she intends to adopt.

- a). The whole of work to be erected complete and pieces marked to place.
- b). All spans to be made strictly as per the interchangeable criteria described subsequently of this technical specification

The Contractor shall maintain a master steel tape of approved make for which he/she has obtained a certificate of accuracy from any National Test House or Government recognized institutions, competent to do so.

2.7 Templates

The templates through out the work shall be of steel. The template shall be used for marking of cutting material and as well as profile machining for girders of railway loading. Templates shall be used for marking of drilling holes in steel structures other than girder of railway loadings. In case where actual materials from a bridge have been used as templates for drilling similar pieces the Inspecting Officer will decide whether they are fit to be used as part of the finished structure.

The contractor shall supply and provide templates at his own cost. **No separate payment shall be made for this and accepted rates shall be deemed to include this aspect.** The templates used for the work shall be of steel and of tested quality.

2.7.1 Template Shop

- (i) Fully covered template shop consisting of uninterrupted steel or concrete floor as approved having true and correct level covering adequate area shall be provided by the contractor.
- (ii) Camber layout shall be drawn to full scale from end of girder to half span. This camber layout once approved shall be used for fabrication of master gusset profiles and end profile of each member. It shall be used for working out the actual lengths of each member and checked to conform to the calculated length.
- (iii) Master gussets at every panel joint of top chord, bottom chord and middle web panel shall be marked accurately on camber layout drawn on template floor.
- (iv) All precautions shall be taken while drawing camber layout for correct setting of angle of intersection of chord and web member and great accuracy shall be ensured while transferring the same on master gusset. While marking centre point of field rivet holes on master gusset, if there is symmetry of holes on vertical axis, marking shall be made only on half the master gusset across vertical axis, and holes drilled by inscribing each hole. Subsequently remaining half portion shall be drilled through gusset using the same half portion master gusset. This will help realize symmetry of holes in gusset and fairing of field rivet hole during girder assembly.
Camber layout and fabrication of Master gusset at every panel joint requires highly skilled and trained staff experienced in accurate fabrication of large girders, drilling jigs and fixtures. At least one jig shall be required for each component. Each jig shall be numbered and a record kept in register for identification.

2.8 Flattening and Straightening

All steel materials, plates, bars and structurals shall have straight edges, flat surfaces and be free from twist. If necessary, they shall be cold straightened or flattened by pressure before being worked or assembled unless they are required to be of curvilinear form. Pressure applied for straightening or flattening shall be such as it would not injure the material and adjacent surfaces or edges shall be in close contact or at uniform distance throughout. Flattening and straightening under hot condition shall not be carried out unless authorized and approved by the Inspecting Officer.

2.9 Planning and Shearing

Except where otherwise indicated, cutting of all plates and sections shall be affected by shearing or sawing. All edges shall be clean, reasonably square and true. Wherever possible the edges shall be cut in a shearing machine, which will take the whole length of the plate in one cut.

As per direction of the engineer, if required, the cut edges shall be ground afterwards. Planing or machining of the edges or surface shall be carried out when so specified in the contract drawings or where specifically ordered by the Engineer. Where machining is specified, the plates or all sections shall be cut in the first instance to such a size so as to permit not less than 3mm of metal being removed from each sheared edge or end, in the case of plates or sections of 12mm or less in thickness and not less than 6mm of metal being removed in the case of plates and sections exceeding 12mm in thickness. The butting ends of all booms and struts where spliced shall be faced in an end milling machine after members have been completely fabricated. In the case of compression members the face shall be machined so that the faces are at right angle to the axis of the members and the joint when made, will be in close contact throughout. At the discretion of the Inspecting Officer, a tolerance of 0.4mm may be permitted at isolated places on the butting line.

All marking and checking of master gussets, camber layout, etc shall preferably be at the mean temperature of the fabrication zone.

2.10 Flame cutting

Flame cutting by mechanically controlled torch/torches shall be accepted both in the case of mild steel and high tensile steelwork. Provided the edge as given by the torch is reasonably clean and straight, plates may be cut to shape and beams and other sections cut to length with a gas-cutting torch, preferably oxyacetylene gas should be used. All flame cut edges shall be ground to obtain reasonably clean square and true edges. Draglines produced by flame cut should be removed. Unless machining has been specifically provided for, special care is to be taken to ensure that ends of all plates and members are reasonably in close contact and the faces are at right angles to the axis of the members and joints, when made, are also reasonably in close contact. Use of multi-head flame cutting machine having multiple oxy acetylene torches is desirable for higher productivity and reducing the distortion due to cutting operation. Plasma-arc cutting method can also be employed. This process offers less heat input causing less distortion.

2.11 Drilling and Sub-punching

All holes shall be drilled but the Contractor may, if he/she so prefers sub-punch them to a diameter 6mm less than that of finished holes, e.g. a punched hole which is to be drilled out to 25mm in diameter shall not exceed 19mm in diameter at the die end. When the rivet holes are to be sub-punched, they shall be marked with a centre punch and made with a nipple punch or preferably, shall be punched in a machine in which the position of the hole is automatically regulated. The punching shall be so accurate that when the work has been put together before drilling, a gauge 1.5mm less in diameter than the size of the punched holes can be passed easily through all the holes. Holes for countersunk heads of rivets, bolts or screws shall be drilled to the correct

profile so as to keep the heads flush with the surface. Holes for countersunk heads of rivets, bolts or screws shall be drilled to the correct profile so as to keep the heads flush with the surface. No sub-punching shall be allowed in the main truss members of open-web girders. Holes for turned bolts should be 1mm under drilled in shop and should be reamed at site to suit the diameter of turned bolt.

Where the number of thicknesses to be rivetted exceeds three or the total thickness is 90mm or more, the rivet holes, unless they have been drilled through steel-bushed jigs, shall be drilled out in place 3mm all round, after assembling. In such cases the work shall be thoroughly bolted together.

The steel bushes shall be case hardened by an approved process and checked for diameter after the heat-treatment. The bores of bushes shall initially have a tolerance of -0mm, 0.1mm. The tolerance shall be checked from time to time and when the bores exceed a tolerance of, -0mm, +0.4mm, the bushes shall be rejected. For this purpose, go and no-go gauges are to be used. Tolerances for checking jigs from master plates shall be +0mm -0.13mm.

The work shall be taken apart after drilling and all burrs left by the drill and the sharp edges of all the rivet holes completely removed..

2.12 Parts in Contact

All steel work intended to be riveted or bolted together shall be in contact over the whole surface.

Drifts as shown in Fig. No.-1 may be used for drawing light members into position but their use on heavy members should be restricted to securing them in their correct positions. In no case, shall drifting be allowed to such an extent that holes are distorted

Drifting to enlarge unfaired holes is prohibited. The holes that will have to be enlarged to admit rivets should be reamed provided the Engineer permits such reaming after satisfying himself about the extent of inaccuracy and the effect of reaming on the soundness of the structure. The Purchaser retains the right to reject all steel work if the holes are not properly matched.

2.13 Making of Joints

Cleaning of permanent contact surfaces: Surfaces which will have permanent contact shall be removed of paints and mill scale down to bare metal, clean and dried and immediately a coating of red lead to IS: 102 shall be applied. Care shall be taken to see that all burrs are removed and no surface defects exist before the parts are assembled. Bolting and drifting: Only barrel drifts as per Fig. No.-1 shall be used in erection. They may be used for drawing light members into position; but their use on heavy members shall be restricted to securing them in their correct position. Any apparent error in shop work, which prevents the assembling and fitting up of the parts by the proper use of these drifts, shall be investigated immediately. As all work is rigidly inspected in the manufacturers work before dispatch, these difficulties should not arise and the cause should be first be sought in the use of incorrect components or the transposition of a correct part. It is usually important that parts should be correctly handled. Should error still persist, the matter shall be immediately reported to the Engineer who will

decide what action is to be taken. No reaming shall be undertaken without the written authority of the Engineer, except for the under drilled holes meant for turned bolts. If approved, the Contractor shall supply, at his/her own expense, any special rivets that maybe required. Copies of all correspondence relative to the recourse to reaming and the use of over-size rivets shall invariably be sent by the Engineer for information to the inspectorate concerned.

Joints shall normally be made by filling not less than 50% of the holes with service bolts and barrel drifts in the ratio of four to one. The service bolts are to be fully tightened up as soon as the joint is assembled.

Special methods of erection other than described in Appendix III of IRS B-1-2001 Specification: In cases where the joints have to withstand stresses arising from special method of erection, provision is to be made to take the whole stress that will or may occur. Cylindrical drifts and turned bolts shall be used to withstand such stresses and no reliance is to be placed on the service bolts for this purpose. Up to maximum of 40% of the holes of each member of the joint are to be filled with drifts and balance of strength required is to be attained with turn bolts. The Engineer will intimate the position and number of the drifts and bolts. The condition of "Making of Joints" of this technical Specification must be observed and the bolt fully tightened up as soon as the joint is made.

Where the manufacturing of girders has been done in accordance with "Interchangeability" of this specification relating to steel girder bridges, the erection shall be done in accordance with Appendix III of IRS B-1-2001 Specification. However, if the Contractor desires to adopt any other method of erection, he/she shall submit the scheme and obtain the approval of the Engineer. It shall be ensured that when in position, the girder has the camber as per drawing.

In the event of an emergency arising such as the staging is in danger of being carried away by floods before the riveting can be completed, the joints shall be made secure by filling 40% of the holes with cylindrical drifts and equal number with service bolts fully tightened.

2.14 Rivets and Riveting

The dimensions on the drawings referred to the diameters of the rivet holes and their finished rivets. The rivet holes shall be 1.5 mm greater than the diameter of the rivet bars used. The rivets shall be made to IS: 1929. The shanks of the undriven rivets shall be made of a length sufficient to fill the holes thoroughly and form the head. The clearance i.e. the difference in diameter between the rivets measured under head before being heated and the rivet hole shall not be less than 0.75mm. Before rivetting is commenced, all works shall be properly bolted so that the sections rivetted are in close contact throughout. Rivets shall completely fill the holes and shall be machine driven by means of pressure or percussion riveters of approved design.

All rivets shall be properly heated to straw heat for the full length of the shank, firmly backed and closed. The head of the rivet, particularly in long rivets, shall be heated more than the point and in no case shall the point be heated, more than the head. Sparking or burnt rivets shall not be used. Where it is impossible to back up by

normal method of holding up, 'double gunning' may be resorted to. Alternatively pneumatic holding device may be used.

Gauges for rivet dimensions and contours shall be provided by the Contractor for the use of the Inspecting Officer.

Rivets when driven shall completely fill the holes, have the heads concentric with the shanks and shall be in full contact with the surface. Driven rivets when struck sharply on the head with the 110-gm. rivet testing hammer, shall be free from movement or vibration.

While rivetting built-up members, full care should be exercised to ensure that the set of holes for field rivets in each flange of the built-up member, is aligned dead-square in relation to that in the other flange and not 'aberrated'. Use of assembly fixtures shall be made to ensure this.

All loose and burnt rivets and rivets with cracks, badly formed, eccentric or deficient heads shall be cut out and replaced. Permissible deviation of driven rivets shall be as per Appendix IV of IRS B-1-2001 Specification. For ready reference, the same has been produced in the "Quality Control" part of this technical specification. Rivets shall also be cut out when required for the examination of the work. Actual method of cutting out shall be approved by the Engineer. Recupping and caulking shall in no circumstances be resorted to.

Riveting shall not be started until such time as the Engineer has personally satisfied himself that the alignment of the girders is correct, the verticals plumb laterally, the camber according to that shown on the camber diagram with camber jacks screwed tight, all the joints and cover plates well up, service bolts tight and field rivet holes coinciding. Special care should be taken that service bolts are frequently re-tightened as the riveting proceeds.

All field rivets shall be tested as directed by the Engineer. Where practicable all rivetting shall be done by pneumatic or hydraulic rivetting machine. The working pressure to be employed when using pneumatic or hydraulic tools shall be approved by the Engineer. Hand rivetting shall only be done when sanctioned by the Engineer. In such cases, means shall be adopted to ensure the rivets being used in their entire -only to give the correct form of head. When all the rivets of joints have been finally passed, they shall be painted as under. One coat of ready mixed zinc chrome primer to IS: 104 followed by one coat of ready mixed paint red oxide zinc chrome primer to IS: 2074.

Finishing coat as per painting schedule given under "Oiling, Painting and Metallising" of this technical specification. For further details on the rivetting, "Indian Railways Bridge Manual" can be referred to.

2.15 **Field rivets, Bolts, Nuts and Service Accessories**

Fabricators shall arrange rivets, bolts, nuts, drifts and service accessories, etc. for all those works required as a part of shop fabrication. For field erection and assembly work, it shall be the responsibility of launching/ erection contractor to arrange such type of fittings.

2.16 Smithed Work

All joggles shall be performed by pressure. Craned sections or knees can be formed by forging or by gas cutting and welding by any approved electric arc process. Any bending, forging, cutting or welding shall be carried out in such a manner as not to impair the strength in the metal. Forging shall be annealed as indicated in the drawing.

If drop forging through dies is resorted to, excessive forging in one operation shall be avoided. Where necessary, a series of intermediate stage dies shall be manufactured and used.

2.17 Welding

Welding of the bridge girders shall be done under strict supervision of the engineer. Approved procedures shall be followed. A brief of the same are given herewith:

2.17.1 Drawings and Procedure Sheets

The symbols for welding used on the fabrication drawings and procedure sheets shall be in accordance with IS: 813. If other symbols are used, a complete explanation of their meaning shall be given.

The fabrication drawings and/or welding procedure sheets prepared for direction of the welding organisation shall include the following information:

- a) Specification of the parent metal, and electrodes and/or wire-flux combinations.
- b) Locations, sizes, actual lengths and details, i.e. form of joint, angle between fusion faces, gap between parts, etc., of all welds.
- c) Whether welds are to be made in shop or field.
- d) Welding procedure, like welding sequence, pre-heating, post heating etc.
- e) Details of testing and inspection requirements.

2.17.2 Butt Welds

Forms and details: All details of butt-welded joints shall be in accordance with IS: 9595 and IS: 4353 as applicable.

Unsealed butt welds of single V, U, J and bevel types and incomplete penetration butt welds shall not be used. Sketches of different types of butt weld are given in Fig. No.-2 of the "SKETCHES" part of this specification. Intermittent butt welds shall not be used.

2.17.3 Sealing or backing

Single V, U, J bevel or square butt welds shall generally be completed by depositing a sealing run of weld metal on the back of the joints.

Where it is not practicable to deposit a run of weld metal on the back of the joint, then single V, bevel or square butt welds, welded from one side only, may be permitted,

provided that another steel part of the structure or a special steel backing strip is in contact with the back of the joint and the edges of the steel parts of the joint are prepared as specified in IS: 9595 or IS: 4353, whichever is applicable, to ensure complete fusion of the parts to be joined.

In all full penetration butt welds which are to be welded from both sides, the back of the first run shall be gauged out by suitable means to clean sound metal, before welding is started on the gauged out side (see Fig. 3 of the "SKETCHES" part of this specification).

2.17.4 Butt welding parts of unequal cross-section

In butt welding steel parts in line with each other which are intended to withstand dynamic forces, and which are of unequal width, or where the difference in thickness of the parts exceeds 25% of the thickness of the thinner part or 3 mm whichever is greater, the dimensions of the wider or thicker parts shall be reduced at the butt joints to those of the smaller part, the slope being not steeper than 1 in 5 (see Fig. 4 of the "SKETCHES" part of this specification). Where the difference in thickness of the parts does not exceed 25% of the thickness of the thinner part or 3 mm whichever is greater, the transition of thickness shall be accomplished by sloping weld faces (see Fig. 5 of the "SKETCHES" part of this specification) by chamfering the thicker part or by combination of the two methods (see Fig. 6 of the "SKETCHES" part of this specification), at an angle not steeper than 1 in 5.

Where the reduction of the dimensions of the thicker part is impracticable, and/or where structures are not designed to withstand dynamic forces, the weld metal shall be built up at the junction with the thicker part to dimension at-least 25% greater than those of the thinner part, or alternatively, to the dimensions of the thicker member (see Fig. 7 of the "SKETCHES" part of this specification).

2.17.5 Butt welded T joints

Butt weld in T joint shall be reinforced by welding as shown in Fig. 8 of the "SKETCHES" part of this specification. Flange to web connection will also fall under this category.

2.17.6 Ends of butt welds

The ends of butt joint shall be welded so as to provide the full throat thickness. This shall be done, in all cases of parent metal more than 20 mm thick and preferably in other cases also, by extending the ends of the butt welds past the edges of the parts joined by the use of run-on and run-off plates with a similar joint preparation and of reasonable thickness not less than the thickness of the part joined and of the length not less than 40 mm (see Fig. 9 of the "SKETCHES" part of this specification) If run on and run off plates are removed after completion of the welds, the ends of the weld shall be finished smooth and flush with the edges of the abutting parts. Run on and run off plates are to be removed after completion of welds by abrasive cut off or by hacksaw blade .To avoid thermal stress as well as heat affected zone, Oxy-acetylene cut should not be permitted. If the parent metal is not more than 20 mm thick, the ends of the butt welds may be chipped or cut back to sound metal and then filled up

with welds having a width not less than one and half time the 'V' opening and having the same reinforcement as adopted for the faces of the butt weld (see Fig. 10 of the "SKETCHES" part of this specification).

2.17.7 Reinforcement of butt welds

Sufficient convexity not exceeding 3 mm, shall be provided as reinforcement to ensure full cross sectional area at the joint. Where a flush surface is required, the butt welds shall be first built up as specified above and then dressed flush.

2.17.8 Fillet Welds: Types of fillet welds

Normal fillet weld - A normal fillet weld is one in which the depth of penetration beyond the root is less than 2.4 mm (see Fig. 11 of the "SKETCHES" part of this specification).

Deep penetration fillet weld: A deep penetration fillet weld is one in which the depth of penetration beyond the root is 2.4 mm or more (see Fig. 11 of the "SKETCHES" part of this specification). It shall be used only by agreement between purchaser and contractor, and tests shall be agreed between purchaser and contractor to verify that the requisite root penetration is being obtained.

Table-1 Minimum size of first run of a fillet weld

Thickness of thicker part	Minimum size
6 mm up to and including 20 mm	5 mm.
Over 20 mm up to and including 32 mm	6 mm.
Over 32 mm up to and including 50 mm	8 mm.

Table-2 Minimum size of a fillet weld

Thickness of thicker part	Minimum size
Upto and including 6 mm	3 mm
Over 6 mm upto and including 12 mm	4 mm
Over 12 mm upto and including 18 mm	6 mm
Over 18 mm upto and	8 mm

including 36 mm	
Over 36 mm upto and including 56 mm	10 mm
Over 56 mm upto and including 150 mm	12 mm
Over 150 mm	16 mm

Notes:

i- When the minimum size of the first run of fillet weld and /or minimum size of the fillet weld as given in Table-1 and Table-2 is greater than the thickness of the thinner part, the minimum size of the weld shall be equal to the thickness of the thinner part. The thicker part shall be adequately pre-heated to prevent cracking of the weld.

ii- Where the thicker part is more than 50 mm in case of steel to IS: 2062 special precautions like pre-heating as per IS: 9595 shall be taken to ensure weld soundness.

2.17.9 Angle between fusion faces:

Fillet weld shall not be used for connecting parts, whose fusion faces form an angle of more than 120° or less than 60°, unless such welds are demonstrated by practical tests to develop the required strength.

2.17.10 Intermittent fillet welds:

Intermittent fillet welds may be used in structures not subjected to dynamic loading, to transfer calculated stress across a joint when the strength required is less than that developed by a continuous fillet weld of the smallest allowable size for the thickness of the parts joined.

Load carrying intermittent fillet welds shall not be used in members subjected to dynamic loading, except for connecting intermediate stiffeners to webs of beams and girders, subject to the provisions of “intermediate stiffeners” contained in this 23.5 specification.

Intermittent fillet welds shall not be used where they would result in the formation of rust pockets.

Chain intermittent welding is to be preferred to stagger intermittent welding.

The distance along an edge of a part between effective lengths of consecutive intermittent fillet welds, whether the welds are in line or staggered on alternate sides of the edge, shall not exceed 12 times the thickness of the thinner part and shall in no case exceed 150 mm. This requirement shall not be taken into account in complying with the requirements of clauses 6.4 and 6.8 of IRS Steel Bridge Code.

In a line of intermittent fillet welds, there shall be a weld at both ends of the parts connected. For staggered welds, this shall apply to both sides.

In built up members in whose parts are connected by intermittent filled welds, continuous longitudinal fillet welds shall be used at the end for a length not less than the width of the part concerned.

2.17.11 Fillet welds applied to the edge of a plate or section:

Where a fillet weld is applied to the square edge of a part, the specified size of the weld shall generally be at-least 1.5 mm less than the edge thickness, in order to avoid melting down of the outer corner, (see Fig. 14 of "SKETCHES" part of this specification).

Where a fillet welds is applied to the rounded toe of a rolled section, the specified size of the weld shall generally not exceed $\frac{3}{4}$ of the thickness of the section at the toe (see Fig. 14 of "SKETCHES" part of this specification).

Where a fillet weld equal in size to the thickness of the section at the toe of a rolled section or at the square edge of a plate is required from design considerations and is specially designated in the drawing, the toe or edge shall be specially built up with weld metal in such a manner as to ensure full throat thickness, full fusion area and no injury to the parent metal (see Fig. 15 & 16 of "SKETCHES" part of this specification).

2.17.12 End Fillet:

When end fillets are used alone, each fillet shall be returned as a side fillet for a minimum length equal to twice the size of the weld, and this returned length shall be disregarded in calculating the strength of the joint.

2.17.13 Fillet welds in slots or holes:

1.0 When welding inside a slot or a hole, in a plate or other part, in order to join the same to an underlying part, fillet welding may be used along the wall or walls of the slot or the hole, but the later shall not be filled with weld metal or partially filled in such a manner as to form a direct weld metal connection between opposite wall. The dimensions of the slot or hole shall comply with the following limits in terms of the thickness of the steel part in which the slot or hole is formed.

2.0 The width or diameter to be not less than three times the thickness or 25 mm whichever is greater.

3.0 Corners at the enclosed ends of slots to be rounded with a radius not less than 1.5 times the thickness or 12 mm whichever is greater.

4.0 The distance between the edge of the part and edge of the slot or hole or between adjacent slots and/ or holes not to be less than twice the thickness when measured along the direction of stress and five times the thickness when measured normal to the direction of stress.

26.8 End Returns:
Fillet welds terminating at the ends or sides of parts or members shall be returned continuously around the corner for a distance of not less than twice the size of the weld. This provision shall apply particularly to side and end fillet welds joining

brackets, beam seating and similar attachments at the tension side of such connections.

2.18 Preparation of Joint Faces:

Preparation of joint faces shall be done as per IS: 9595.

2.18.1 Fusion faces:

The preparation of fusion faces, angle of preparation root radius and root face shall be as specified in IS: 9595 and IS: 4353. Where the gap between the root faces of a butt joint is excessive, the gap shall not be bridged since this procedure often leads to cracking. The fusion faces of the joint shall be built-up with weld metal to give the appropriate gap before the weld proper is commenced.

The preparation of fusion faces, angle of bevel, root radius and root face shall be such that the limits of accuracy required by the appropriate application standard can be achieved. When however, no appropriate application standard exists and this standard is itself to be used, it is recommended that, for manual welding, the tolerances on limits of gap and root face should be ± 1 mm on the specified dimensions for material up to and including 12 mm thick and ± 2 mm for material over 12 mm thick. The tolerance on the included angle between the fusion faces of a V preparation is recommended to be ± 5 degree and for U and J preparations + 10 degree. For an automatic process, closer limits are necessary and particular requirements depend on the characteristics of the process.

It shall be ensured, if necessary, by suitable non-destructive tests that the fusion faces and adjacent surfaces shall be free from cracks, notches or other irregularities which might be the cause of defects or would interfere with the deposition of the weld.

Fusion faces and the surrounding surfaces shall be free from heavy scale, moisture, oil, paint or any other substance which might affect the quality of the weld or impede the progress of welding. Certain proprietary protective coatings are specially formulated with the intention that they should not interfere with welding. The use of such coatings is not excluded by the requirements of this clause but shall be demonstrated by means of specimen welds that the coating complies with the above requirements.

2.18.2 Assembly for Welding:

Parts to be welded shall be assembled such that the joints are easily accessible and visible to the operator.

Jigs and manipulators shall be used, where practicable, so that the welding can be carried out in the most suitable position. Jigs shall maintain the alignment with the minimum restraint so as to reduce the possibility of locked in-stress.

2.18.3 Sequence of welding and weld pass for composite girders, shear connectors etc:

For fabrication of welded composite girders, channel shear connectors shall be welded on top flange plate prior to assembly of I-section. This facilitates correction of any distortion of flange plate developed during the welding of channel shear connectors.

In making a typical I-section four fillet welds are to be made. The welding sequence to be followed is indicated by number 1 to 4 as shown in the Fig. No.-23.

Whenever a square butt weld in a 10 or 12mm thick plate is required to be made, the sequence to be adopted is shown in Fig. No.-23.

2.18.4 Welding in solid web girders:

Flange Plates: Each flange shall, as far as possible, particularly in dynamically loaded structures, consist of a single section rather than of two or more sections super-imposed. The single section may comprise a series of sections laid end to end and effectively welded at their junctions.

If the use of curtailed flange plates cannot be avoided the end of the plate shall be tapered in plane to a rounded end and welded continuously round the end.

In dynamically loaded structures, flange plates laid end to end shall be joined by butt welds, and welded cover plates shall not be used. Joints in flange plates shall be butt welded and dressed flush before assembling.

Where the flange consists of more than one section, the butt joints shall be staggered.

Welded cover plates, where used in structures not subjected to dynamic loading, shall have enough welds on either side to develop the load 5% more than that of the element spliced.

The flange plate, welded directly to the web plate, shall not be more than 50 mm thick when steel conforms to IS: 2062.

Web Plates : Splices in the webs of plate girders and rolled sections used, as beams shall be made by butt welds dressed flush on all faces, in the case of dynamically loaded structures. In the case of structures not subjected to dynamic loading, splice plates may be used independently and not to reinforce a butt-welded splice.

Intermediate stiffeners:

Where intermediate stiffeners are connected to the web by intermittent fillet welds placed in pairs, one weld on either side of the stiffeners, the effective length of each weld shall be not less than four times the thickness of the stiffeners.

Where staggered intermittent fillet welds are used, the effective length of each weld shall be not less than 10 times the thickness of the stiffener.

Fillet welds placed on one side only of the stiffener shall not be used.

Intermediate stiffeners carrying cross bracings or diaphragms shall not be connected to the web by intermittent fillet welds.

Intermediate stiffeners shall be located away from web splices.

2.19 Safety Precautions

Provisions of IS: 818, IS: 1179 and IS: 3016 shall generally apply for safety and health requirements during welding operations.

2.20 Approval and Testing of Welding Procedures

Welding procedure test shall be carried out in accordance with IS: 7307(Part-I) to demonstrate, by means of a specimen weld of adequate length on a steel representative of that to be used, so as to confirm that satisfactory weld is achievable with the welding procedure to be used for fabrication.

Provisions of IS: 9595 and IS: 4353, shall generally be followed, as applicable, for welding procedure, details of workmanship, correction of weld faults, peening, painting, etc. In case any of the provisions contained therein contravene the provisions made on this code, the latter shall be followed.

In addition to the provisions of IS: 4353 the Inspector may, where deemed necessary, require a sample joint having the same cross-section as the joint to be used in construction and a length of at least 300 mm to be welded with the wire, flux current, arc voltage and speed of travel that are proposed to be used and a macroetched cross section of the welded joint prepared as a demonstration that the specified requirements will be met, when the welding current, arc voltage and speed of travel are established by a test made in accordance with requirements of this clause, they shall be kept within the following limits of variations.

Welding current	±10%
Arc Voltage	± 7%
Speed of travel	±15%.

2.21 Approval and Testing of Welders

The welders shall be trained in accordance with IS: 817. The welders shall be subjected to appropriate qualifying tests specified in IS: 7310 (Pt-I).

2.22 Welding Processes and Procedures:

Welding work shall be given to a contractor who does produce satisfactory evidence of his ability to handle the work in a competent manner. The contractor shall also prove the ability of the operator/Welders employed by him to produce welds of the required strength. The contractor shall employ a competent welding supervisor to ensure that quality of materials and the standard of workmanship comply with the requirements laid down in this code.

The sizes and length of welds shall not be less than those specified in the drawings nor shall they be substantially in excess of the requirements without prior approval of the Engineer. The location of welds shall not be changed without prior approval of the Engineer. Welds shall preferably be made in flat position.

In case of welds in structures subjected to dynamic loading, adequate means of identification, either by identification stamp or other records shall be provided to enable each weld to be traced to the welding operator by whom it was made. During the entire welding of cooling cycle, the joints shall not be subjected to any external forces or shocks.

Freedom of movement of one member of a joint shall be allowed wherever possible. No butt joint shall be welded without allowing one component, freedom of movement of the order of 1.5 mm. In making welds under conditions of severe external shrinkage restraint, the welding shall be carried out with electrodes having type 6 covering as per IRS:M-28 Specification. In case of welding using direct current, earthing on the work piece to be welded shall be connected carefully at more than one location with a view to avoid "Arc Blow" during welding.

All welds should be done by submerged arc welding process either fully automatic or semi-automatic. Carbon-di-oxide (CO₂) welding or manual metal arc welding may be done only for welds of very short runs or of minor importance or where access of the locations of weld does not permit automatic or semi-automatic welding.

Neither the depth of fusion nor the maximum width in the cross section of weld metal deposited in each weld pass shall exceed the width of the face of the weld pass.

All welds should be done by submerged-arc welding process either fully automatic or semi-automatic. Carbon di oxide welding or manual metal-arc welding may be done only for welds of very short runs or of minor importance or where access of the locations of weld do not permit automatic or semi-automatic welding.

Except for special types of edge preparation, such as single and double 'U' single and double 'J' the fusion edges of all the plates which are to be joined by welding may be prepared by using mechanically controlled automatic flame cutting equipment and then ground to a smooth finish. Special edge preparation should be made by machining or gouging.

The welding procedure shall be such as to avoid distortion and minimise residual shrinkage stresses. Properly designed jigs should be used for assembly. The welding techniques and sequence, quality, size of electrodes, voltage and current required shall be as prescribed by manufacturers of the material and welding equipment. The Contractor should submit full details of welding procedure in proforma given at Appendix V of IRS B-1-2001 specification, copy of which is available in "Maintenance of Records" of this specification.

Site welding should not be undertaken except in special circumstances with the approval of the Engineer. Site welding should be confined to connections having low stresses, secondary members, bracings etc.

Manual metal arc welding may be done taking adequate precautions as per IS: 9595 and under strict supervision.

2.23 Sequence of Welding

The sequence of welding shall be such that when possible the members, which offer the greatest resistance to compression, are welded first.

The welding in the thinnest element of a section (usually the web in case of beams) shall be done prior to the welding of the thicker elements (usually the flanges in case of beams).

In making butt welded joints in rolled shapes, the sequence and procedure of welding shall take into account unequal amount of expansion or contraction in elements being welded.

Splices in each component part of a solid web girder or built-up member shall be made before such component part is welded to other component part of the member.

2.24 Position of Welding:

For fabrication of steel bridge girders the following positions of welding shall be adopted.

- I) Flat and horizontal position for Submerged Arc Welding (SAW) and
- II) Horizontal or horizontal-vertical position for welding done using manual metal Arc welding (MMAW) or CO₂ welding.

All butt welds by the submerged arc process shall be made in the flat position. Fillet welds may be made in either flat or horizontal-vertical position. The size of the single pass fillet welds made in the horizontal-vertical position shall not exceed 8 mm.

2.25 Tack Welds:

Tack welds shall be not less than the throat thickness or leg length of the root run to be used in the joint. The length of the tack weld shall not be less than four times the thickness of the thicker part or 50 mm whichever is the smaller

Where a tack weld is incorporated in a welded joint, the shape, size and quality shall be suitable for incorporation in the finished weld and it shall be free from all cracks and other welding defects. Tack welds, which are prone to cracking, shall be cut out and rewelded.

Tack welds shall not be made at extreme ends of joints.

2.26 Inter-run Cleaning:

Each run of weld bead shall be thoroughly cleaned to remove particles of slag, spatters, etc. before the subsequent bead is super-imposed during multi-pass welding. Similarly, each layer of weld should be thoroughly cleaned of slag, spatters, etc, before depositing subsequent layers of weld with particular reference to thorough cleaning of toes of the welds. Visible defects, such as cracks, cavities and other deposition faults, if any, shall be removed to sound metal before depositing subsequent run or layer of weld.

2.27 Stray arcing on Work:

Stray arcing shall be avoided as this can leave local hard spots or cracking which are to be removed by mechanical means and be checked by inspection depending upon the application.

2.28 Inspection and Testing of Welded Joints:

The inspection of bridge girders shall be done by RDSO. The Inspector designated by the purchaser shall ascertain that fabrication by welding is performed in accordance with the requirements of this code. Inspection of welds shall also be carried out in accordance with this Code. For the provisions, which are not incorporated in this Code, IS: 822 "Code of procedure for inspection of welds" shall be followed.

He shall be furnished with complete detailed drawings showing the size, length, type and location of all welds, which are required to be made. He shall be notified in advance of the start of any welding operations. He shall have free access to the work being done at all reasonable times by the contractor and facilities shall be provided so that during the course of welding he may be able to inspect any layer of weld metal. He shall be at liberty to reject any material that does not conform to the provisions of this code and to require any defective welds to be removed and re-welded.

2.29 Inspection prior to welding:

2.29.1 Parent metal:

All plates and sections shall be inspected in the contractor's works before fabrication. Verification of the quality of parent metal shall be carried out by reference to the relevant test certificate. The Inspector may, at his discretion, ask for spot checks to be made on the chemical composition and physical properties of the material. Freedom from harmful defects such as cracks, surface flaws, laminations, and rough, jagged or imperfect edges shall be verified by visual examination of the material prior to welding. Dimensions of parts shall be checked by measurement.

2.29.2 Edge preparation and set-up of parts:

Edge preparation shall conform to the relevant drawings and meet the requirements of this code.

After the parts are assembled in position for welding, the Inspector shall check for incorrect root gap, improper edge preparation and other features that might affect the quality of the welded joint.

2.29.3 Verification of operator's qualification:

Welding shall be permitted to be performed only by welders and welding operators who are qualified in accordance to the "Approval and Testing of Welders" contained in this specification. The Contractor shall, if so required, prescribe the welding procedure to be followed. Before any welding on the actual job is allowed under the contract, the Inspector shall verify, in accordance with the provisions of IS: 9595 and IS: 4353 as applicable, that the procedure prescribed is satisfactory.

2.30 Inspection after Welding:

For visual inspection of defects, the weld surface shall be thoroughly cleaned of oxide layers and adherent slag. If chipping hammer is used to remove slag, care shall be taken to see that hammer marks do not obscure the evidence of fine cracks. Brushing with a stiff wire-brush or grit blasting shall normally be followed. Welding profile - The finished welds shall be visually inspected and shall conform to the size and contour specified in the drawings (Acceptable and defective weld profiles are illustrated in Fig. 17 to 21 of the "SKETCHES" part of this specification). Conformity of fillet welds as to size and contour shall be determined by the use of gauges as per Figure No.-22 of "SKETCHE" part of this specification. Concavity and excessive convexity of fillet welds shall be marked for correction.

2.31 Acceptance levels for Quality of Welds:

Welds shall meet acceptance levels as per Table No.-3 of "QUALITY CONTROL" part of this specification.

2.31.1 Dimensional check:

The weldment shall be inspected for dimensional accuracy (including warpage) and shall be within the tolerances specified.

2.32 Non-destructive tests:

2.32.1 Radiographic tests:

Butt welds shall be examined by radiographic test, which will present satisfactory evidence to the Inspector that welds are meeting the quality requirements. Other welds may be examined by radiographic or any other non-destructive method, which are equally effective. Welds shall also be examined by liquid penetrant flaw detection method or by magnetic particle flaw detection method as per IS: 3658 and IS: 3703.

2.33 Marking of Defective Welds:

The marking shall be positive and clear and in accordance with the method of marking followed and understood by the Inspector and shop personnel involved in making the repairs. Marking shall be permanent enough to be evident until the repair is carried out and the inspection completed. After the repair has been done, it shall be inspected again and properly marked to indicate whether the repair is satisfactory or not.

2.34 Bolts, Nuts and Washers

Bolts, Nuts and Washers shall be in accordance with the following specifications:

Black hexagonal bolts to IS: 6639 and Nuts to IS: 1363.

Precision and turned bolts with nuts and hexagonal screws to IS: 1364.

Plain washers to IS: 2016 and IS: 5369.

Spring washers - IS: 3063.

Taper washers - IS: 5372 and IS: 5374.

Manufacture, workmanship, Marking, Packing etc. for Bolts and Nuts shall comply with the requirements of IS: 1367.

Where the head and nuts bear on timber, square washers having the length of each side not less than three diameters of the bolt and the thickness not less than one quarter of the diameter shall be provided. Steel, wrought iron or malleable cast iron taper washers shall also be provided for all heads and nuts bearing on beveled surfaces.

For black bolts a clearance (difference in diameter) of 1.5mm for all sizes of bolts shall be allowed.

Where turned bolts are required they shall be carefully turned and shall be parallel throughout the barrel. Holes for turned bolts should be 1mm under drilled in shop and should be reamed at site to suit the diameter of the turned bolts.

The following limits of tolerances shall be permitted upon the diameter of the shank of turned bolts and of the holes which they are to fit:

Limit of tolerance	Shank of bolt (mm)	Hole(mm)
High	0.000	+0.125
Low	- 0.125	0.000

The shank of each turned bolt shall be of such a length that it is in full contact with the work, throughout, the screwed portion being made at least 1.5mm less in diameter than the shank or to suit the next smaller size of screw thread. The shank portion shall be joined to the threaded portion by a 45° chamfer within the thickness of the washer. Washers with perfectly flat faces should be provided with all turned bolts.

The washers under the nut shall have a hole of 1.5mm larger in diameter than the shank of the bolt and shall have a thickness of not less than 6mm so that the nut, when screwed up, shall not bear on the shoulder of the bolt.

2.35 Connecting Pins:

All connecting pins shall be finished accurately to gauge and parallel throughout, straight and with smooth surface entirely free from flaws and of sufficient length to

ensure that all parts connected thereby shall have a full bearing on the pin. They shall be turned to a smaller diameter at the end for the thread and driven to place with a pilot nut, where necessary to preserve the thread.

2.36 Pin Holes:

Pinholes shall be bored smooth straight and true to gauge and at right angles to the axis of the member. Boring shall only be done after the member has been rivetted up and the diameter of the pin shall not be less than that of the hole by more than 0.5mm.

2.37 Bearing and Expansion gear

All steel bed and bearing plates or plates over saddle castings, shall be made perfectly level and all rivet heads on their bearing surfaces shall countersunk and dressed flush.

The saddles, knuckle-bearers and roller bed-plates shall be planed on all bearing surfaces and elsewhere as indicated on the Contract Drawings and all bolt-holes shall be drilled. The bottom edge of ribs should be machined and welded to the bottom slabs after which the top edges of the ribs should be machined as a whole and the top plate welded. Subsequently the top and bottom surfaces should be machined to the specified tolerances as given in Appendix VI of B1 specification. Generally in connection with the bearing gear all meeting surfaces including the sides of the roller frames, shall be machined, all bolts except anchor bolts turned and fitted, all washers faced, the rollers knuckles and pins polished to smooth surface and the whole finished in the style of first class machined work.

Tolerances shall be as specified in Appendix VI of IRS B-1-2001 specification and shall be shown on the drawings.

2.38 Erection in Contractor's Works:

The work shall be temporarily erected complete at the Contractor's Works for inspection by the Inspecting Officer, with the exception of such rivetting as has to be done at site, so that accuracy of fit and perfection of workmanship may be assured. The work shall be put together with sufficient numbers of parallel drifts or turned bolts or both to bring the pieces into place. When so erected all holes left to be filled at site shall be so fair that a parallel gauge turned to a diameter 0.8mm less than that of the hole, of a length equal to the depth of the hole, can be passed through them without difficulty. No drift shall be used anywhere in the work larger in any part than the hole in which it is to be driven. Holes for turned bolts, which have been 1 mm-under drilled in shop, should be reamed at site by the erecting agency.

2.39 Interchangeability:

Every span is to be temporarily erected complete in Contractor's works adopting the method of giving camber and all parts as marked to their place, unless the whole of the work is made completely interchangeable by the use of steel jigs and hard steel bushes controlled by master gauges, in which case the first span must be completely erected to test the accuracy of the templates. Further spans or part span assemblies built from parts selected at random by the Inspecting Officer shall be erected from time to time to

check the accuracy of the work as the Inspecting Officer may require. If the work is considered interchangeable by the Inspecting Officer a simplified scheme of marking will be permitted, i.e. all pieces that are identical shall bear one distinguishing mark irrespective of the span to which they belong. Should the interchangeability not to the satisfaction of the Inspecting Officer, the whole of the spans must be erected complete and all parts marked to their place without additional charge. The tenderers must state in their tenders whether they intend to adopt complete interchangeability or not. Under special arrangement with the Purchaser, it shall be permissible for approved portions of the work to be dispatched before complete erection of the first span, provided the Contractor satisfies the Inspecting Officer that such portions of the work are strictly interchangeable and will assemble correctly and accurately in the complete structure.

2.40 Camber

In order to ensure that the fabrication and erection of main girders shall be such as to eliminate secondary stresses in the loaded span, the nominal length (i.e. the lengths which will give no camber) of member shall be increased or decreased by the amount shown on the camber diagram supplied by the Purchaser. For setting of the angles of intersection of the chords and web members and also for templating the gusset, full size of panels with nominal lengths of the members, shall be used. Similarly, the machining of all chords butts shall be to suit the nominal outline as defined earlier.

The procedure for erecting the span at Contractor's work shall be as specified. The site rivetting holes shall be rivetted or bolted and drifted as specified in Appendix III of IRS B-1-2001 specification.

When supported on blocks or stagings, the girders shall be erected to the camber specified in the fabrication drawings according to which the girders have been manufactured. A camber diagram indicating the relevant height of each panel point when erected on blocks at the manufacturing works shall be supplied by the Engineer. The cambering of the main girders along with pre-stressing, when all panel points are supported on the blocks or stagings, shall be carried out in accordance with Appendix 'A' of Steel Bridge Code. Special methods of erection will require special erection drawings approved by the Engineer, which must not be deviated from.

In the case where the girders are erected on yielding supports such as a service span, due allowance shall be made for the anticipated yield when the camber blocks are set out.

Frequent checks shall be made of the camber of girders during erection and care taken to see that the camber as per drawing is obtained when the girder is completely assembled. When span is supported on ends and intermediate supports are removed the dead load camber shall be recorded and entered in bridge register. This will provide the reference to compare the camber checked during technical inspection.

2.41 Testing

The Inspecting Officer shall be empowered, at his/her discretion to make or have made under the supervision, any of the tests specified in the specifications mentioned herein in addition to such other tests as he/she may consider necessary, at any time

upto the completion of the contract and to such an extent as he/she may think necessary to determine the quality of all materials used therein. In doing so, he/she shall be at liberty under any reasonable procedure, he/she may think fit to select, identify, have cut-off and take possession of test pieces from the material either before, during or after its being worked up into the finished product.

He shall also be empowered to call for a duly authenticated series of mechanical tests to be obtained from the maker for these materials used in the work and to accept the same in lieu of other tests to the extent he/she deems fit. The Contractor shall supply the material required for the test pieces and shall also prepare the test pieces necessary.

The test shall be carried out by the Contractor, for which Contractor shall provide all facilities including supply of labour and plant. Inspecting officer may at his/her discretion direct the Contractor to dispatch such tests pieces as he/she may require to the National Test House or elsewhere as he/she may think fit for such testing purposes.

2.42 Check on Tests made at Contractor's work

The Inspecting Officer may at his/her discretion, check test results obtained at Contractor's work by independent tests at National Test House. The Inspecting Officer shall at all times be empowered to examine and check the working of the Contractor's plant before and after using it. Should the Contractor's plant be found, in the Inspecting Officer's opinion, unreliable, he/she is empowered to cancel any tests already carried out in this contract and have these tests carried out at any National Test House or elsewhere, as he/she may think fit.

2.43 Analysis

The Contractor shall supply authenticated copies of analysis of any materials used in the contract when required to do so by the Inspecting Officer who shall be empowered to accept them to the extent he/she thinks fit. In addition to the above samples may, at the Inspecting Officer's discretion be subjected to complete analysis at the National Test House or elsewhere as the Inspecting Officer may determine, the cost of the same to be borne by the Purchaser.

2.44 Inspection – general

The Inspecting Officer shall have free access to the works of the Contractor at all reasonable times and shall be at liberty to inspect the process of manufacture at any such time and to reject in whole or part, any work or material that does not conform to the provisions of this Specification and may order the same to be removed, replaced or altered at the expense of the Contractor. All gauges and templates necessary to satisfy the Inspecting Officer of the complete interchangeability of parts must be supplied by the Contractor free of cost.

3.0 Oiling, Painting, Metallising of Girders, Packing and Dispatching

No part of the work shall be painted or coated, packed or dispatched, until it has been finally inspected and approved by the Inspecting Officer. Dry Film Thickness shall be measured by Eclometer or any other approved method.

When so specified by the Purchaser, the whole of the work except machined surfaces shall be given protective coating using one of the systems of painting or metallising given herewith. Prior to the application of protective coating, the surface of work shall be carefully prepared removing mill-scale, rust, etc. using wire brushes, sand or grit blasting as stipulated and approved by the Purchaser.

Specifications for metallising and painting of bridge girders shall be as per IRS B1-2001. No painting work will be permitted during the monsoon period.

3.1 Surface Preparation (for all types of Painting and Metallising)

Surface of all **components /members** of the superstructure shall be prepared as per following provisions before application of first coat of paint/primer or before metalizing.

- (i) The surface should be clean, dry and free from contaminants and it should be rough enough to ensure adhesion of the paint film. However it should not be so rough that the film cannot cover the surface peaks.
- (ii) The cleaning of the surface shall be done initially with the use of emery paper, wire brushes, scrapers etc. for spot cleaning to remove rust, scale etc. Subsequently, sand blasting of the surface shall be done to remove rust, mill scale along with some of the base metal. This will be achieved by high velocity impact of abrasive material against the surface in accordance with the provisions of IS:6586, which will also create a base for good adhesion. The abrasive material once used for cleaning heavily contaminated surface should not be reused even though re-screened. Washed salt free angular silica sand of mesh size 12 to 30 with a minimum of 40% retained on a 20 mesh screen shall be used for blasting. The material specifications and other requirements shall be as provided in Indian Railways Bridge Manual, 1998 (with latest revision).
- (iii) All site rivets, bolts, nuts and washers shall be thoroughly cleaned and dipped in boiled linseed oil. All machined surfaces are to be well coated with a mixture of white lead conforming to IS:34 and Mutton tallow conforming to IS:887 as per specifications before dispatch to site. Nothing extra shall be payable to contractor on this account.

3.2 Metallising and Painting of Floor and Deck systems of the Bridge

- (i) All the components in the floor and deck system in open web girders of this Railway Bridge shall be metalized as per IRS specifications. Components to be metalized in rail deck are cross girders, stringers, connecting gussets and other components.

- (ii) The sprayed coating shall be applied as soon as possible after surface preparation.
- (iii) The wire method shall be used for the purpose of metallising, the diameter of the wire being 3mm or 5mm as per approved by Engineer. Specified thickness of coating shall be applied in multiple layers and in no case less than 2 passes of the metal spraying unit shall be made over every part of the surface. The surface after spraying shall be free from uncoated parts of lumps of loosely spattered metal.
- (iv) The composition of the aluminium to be sprayed shall be in accordance with BS:1475, material 1-B(99.5%) aluminium otherwise as per IS:739 and IS:2590. However, the selection of metal for spraying, i.e. Zinc or Aluminium shall be subject to final approval by the Engineer.
- (v) At least one layer of the coating must be applied within four hours of blasting and the surface must be completely coated to the specified thickness within 8 hours of blasting.
- (vi) Minimum thickness of metal coating applied shall be 115 microns and average thickness shall be 150 microns. The metal coating shall be checked for thickness by approved magnetic thickness measuring gauge. At least one reading for each sqm of area painted shall be taken. The calibration of the gauge shall be checked against a standard of similar thickness within an accuracy of 10 %.
- (vii) For measurement of dry film thickness, following instruments may be used by the contractor. Dry film thickness is to be measured as described in Appendix-VII of IRS BI-2001.
 - (a) Electronic coating thickness gauge.
 - (b) Elcometer (magnetic thickness gauge) Dial type.
 - (c) Surface profile gauge.
- (viii) Any oil, grease or other contamination should be removed by thorough washing with a suitable thinner until no visible traces exist and the surfaces should be allowed to dry thoroughly before application of paint. The coatings may be applied by brush or spray. If sprayed, pressure type spray guns must be used. One coat of wash primer to IS: 5666 shall be applied first. After 4 to 6 hours or the application of the wash primer, one coat of Zinc chrome primer to IS: 104 with the additional provision that zinc chrome to be used in the manufacture of primer shall conform to type 2 of IS:51 shall be applied.
- (ix) The third coat shall be by Aluminium paint conforming to IS:2339. The girder parts shall be dispatched to site after the third coat (i.e. first finishing coat or cover coat).
- (x) After assembling and launching at site, second finishing coat of Aluminium paint conforming to IS:2339 shall be applied after touching up the primer and first finishing coat.

3.3 Painting of other components of this bridge (other than those in floor and deck systems)

Protective coatings by paintings as per following painting schedule may be applied with the approval of the Engineer:

- a) Primer coat: Two coats of ready mixed paint red lead primer to IS:102.

Or

One coat of ready mixed zinc chrome primer to IS:104 followed by one coat of zinc chrome red oxide primer to IS:2074

- b) Finishing Coat: Two coats of aluminium paint to IS:2339 shall be applied over the primer coats. One coat shall be applied before the fabricated steel work leaves the shop. After the steel work is erected at site, the second coat shall be applied after touching up the primer and the finishing coat if damaged in transit.

3.4 Miscellaneous

- (i) Final dry film thickness in case of metallising shall be average 150 microns and shall be measured before application of final finishing two coats.
- (ii) Surface preparation shall not be done unless approved paints of sufficient quantity (both primer and finishing) are available in stock.
- (iii) Special care should be taken in preparing corners, junctions of members, head and nuts of bolts, rivets, holes, areas less accessible, hidden pockets etc. Surface preparation at such locations shall not be inferior to that attained over the rest of the area.
- (iv) Surface preparation shall not be carried out in the following conditions:
- In rainy season from June to September and from December to January.
 - In extremely windy/misty/dust blowing conditions.
 - At night
 - In winter before 8 A.M.
 - In summer between 11 and 15 hrs, in areas, which are likely to be exposed to direct sunlight.

Engineer reserves the right to change the above timings.

Final dry film thickness in case of metallising as well epoxy painting shall be average 150 microns and shall be measured before application of final finishing coats.

Surface preparation shall not be done unless approved paints of sufficient quantity (both primer and finishing) are available in stock.

Special care should be taken in preparing corners, junctions of members, head and nuts of bolts, rivets, holes, areas less accessible, hidden pockets, etc. Surface preparation at such locations shall not be inferior to that attained over the rest of the area.

Surface preparation shall not be carried out in the following conditions:

- B. In rainy season from June to September and from December to January.
- C. In extremely windy/misty/dust blowing conditions
- D. At night
- E. In winter before 8 A.M.
- F. In summer between 11 and 15 hours, in areas, which are likely to be exposed to direct sunlight.

3.4.1 Inspection

Adhesion: The sprayed metal coating shall be subjected to an adhesion test using the method described in IRS B1-2001 if any part of the coating between the lines breaks away from the base metal; it shall be deemed to have failed the test.

Articles that have been rejected shall have the defective sections blasted clean off all sprayed material prior to re-spraying. Where the rejection has been solely due to too thin a coating, sprayed metal of the same quality may be added provided that the surface has been kept dry and is free from visible contamination.

3.5 Paints: Source & Quality:

Paint and other accessories including those for metallising for the work will be supplied by the contractor. Paints manufactured by the following firms (or more) may be used subject to their bearing in the approved list of RDSO and final approval by Engineer-in-charge.

- 1.M/s. British/Burger paints
- 2.M/s. Johnson & Nicholson
- 3.M/s. Shalimar paints
- 4.M/s. I.C.I.
- 5.M/s. Nerolac.

The contractor shall furnish to IRCON, the date of manufacture of paint as certified by the manufacturers with the necessary container marking and test certificate for paint conforming to relevant IS code. In addition to this, he shall also submit the necessary vouchers in respect of paint purchased by him.

IRCON reserves the right to get the paint tested at contractor's expenses as considered necessary by IRCON. If the test results do not conform to relevant IS specifications fully, then the lot of paint shall be rejected and got removed from the contractor(s) storage. If the paint has already been applied it shall be removed.

In addition to above, the following tests are required to be carried out in the field:

- i.Weight per litre
- ii.Consistency test
- iii.Scratch test
- iv.Flexibility and adhesive test

Note – *IRCON reserves the right to reject the lot of paint even on the basis of field results.*

3.5.1 Painting – General Instructions

Painting shall not be commenced till the surface preparation has been approved by the Engineer or his representative or inspecting officer.

Sealed containers of paint of approved brand shall be used. The paint drums must be rolled, turned upside down and shaken before opening. The paint must be stirred well before use. Over stirring which results in invisible air bubbles etc., shall be avoided.

Where brush painting is accepted, the paint must be applied by means of flat brushes not more than 75mm in width having soft flexible bristles conforming to IS: 384.

Round and oval brushes of approved quality conforming to IS: 487 may also be used as per the instructions of the Engineer or his representative or inspecting officer.

All new bushes should be soaked in raw linseed oil conforming to IS: 77 for at least 24 hours before use.

A little blue paint shall be added, in the first coat of aluminium paint to distinguish it from second coat. For paints of other colours for final and finishing two coats, suitable pigment shall be used as per instruction of the Engineer, to distinguish the first coat from the second coat.

The date of painting shall be marked with paint on the member.

3.6 Care During Painting

Paint should be mixed in small quantities sufficient to be consumed within one hour in the case of red lead paint.

The applied coat of paint shall be uniform, and free from brush marks, sack marks, blemishes, scratching, non-uniform thickness, holes, log marks, fuel staining, cracking, scaling, and other defects.

Paint shall be applied only on dry and clean surface free from moisture or dust (including scrapping dust).

Paint should be used within the prescribed shelf life from the date of manufacture.

Each coat of paint shall be left dry till it sufficiently hardens before the subsequent coat is applied. Each coat of paint shall be inspected by the engineer or inspecting officer and certified as satisfactory before applying subsequent coat.

The payment for complete painting of all components of girders including all accessories, painting of contact surface etc. including all labour and material, is included in the accepted rates for item in the schedule of items, rates and quantities and nothing extra shall be paid.

3.7 Specification for Metallising with Sprayed Aluminium for Bridge Girders

3.7.1 Surface Preparation:

The surface shall be thoroughly cleaned and roughened by compressed air blasting or centrifugal blasting with a suitable abrasive material in accordance with Clause 3 of IS: 6586. Immediately, before spraying it shall be free from grease, scale, rust, moisture or other foreign matter. It shall be comparable in roughness with a reference surface produced in accordance with appendix A of IS: 5905 and shall provide an adequate key for the subsequently sprayed metal coating.

3.7.2 Metal Spraying

The metal spraying shall be carried out as soon as possible after surface preparation but in any case within such period that the surface is still completely clean, dry and without visible oxidation. If deterioration in the surface to be coated is observed by comparison with a freshly prepared metal surface of similar quality which has undergone the same preparation, the preparation treatment should be repeated on the surface to be coated.

The wire method shall be used for the purpose of metallising the diameter of the wire being 3mm or 5mm. Specified thickness of coating shall be applied in multiple layers and in no case less than 2 passes of the metal spraying unit shall be made over every part of the surface. At least one layer of the coating must be applied within 4 hours of blasting and the surface must be completely coated to the specified thickness within 8 hours of blasting.

i- Purity of Aluminium:

The chemical composition of aluminium to be sprayed shall be 99.5% aluminium conforming to IS: 2590.

ii- Appearance of the coating:

The surface of the sprayed coating shall be of uniform texture and free from lumps, coarse areas and loosely adherent particles.

iii- Thickness of the coating:

The nominal thickness of the coating shall be 150 μ (microns). The minimum local thickness, determined in accordance with procedure given below, shall be not less than 110 μ (microns).

3.7.3 Shop Painting:

Any oil, grease or other contamination should be removed by thorough washing with a suitable thinner until no visible traces exist and the surfaces should be allowed to dry thoroughly before application of paint. The coatings may be applied by brush or spray. If sprayed, pressure type spray guns must be used. One coat of wash primer to IS: 5666 shall be applied first. After 4 to 6 hours of the application of the wash primer, one coat of Zinc chrome primer to IS: 104 with the additional proviso that zinc chrome to be used in the manufacture of primer shall conform to type 2 of IS: 51 shall be applied.

After hard drying of zinc chrome primer, one coat of Aluminium paint to IS: 2339 (brushing or spraying as required) shall be applied.

3.7.4 Site Painting:

After the steel work is erected at site a second cover coat of Aluminium paint to IS:2339 (brushing or spraying as required) shall be applied after touching up the primer and the cover coat given in the shop if damaged in transit.

3.7.5 Method for the Determination of Local Thickness

Equipment:

Any magnetic or electro-magnetic thickness meter that will measure local thickness of a known standard with an accuracy of ± 10 percent.

Calibration of Instrument

Calibrate and check the meter on one of the following standards (as appropriate):

(I) (Applicable to magnetic and electro-magnetic meters other than the pull-off type) A soft brass shim, free from burrs, in contact with the grit-blasted surface of the base metal prior to its being sprayed. The thickness of the shim shall be measured by micro meter and shall be approximately the same as the thickness of the coating.

(ii) A sprayed metal coating of uniform known thickness approximately the same as the thickness of the sprayed coating to be tested, applied to a base of similar composition and thickness to the article being sprayed, grit-blasted in accordance with Clause 1.

Procedure:

For each measurement of local thickness, make an appropriate number of determinations, according to the type of instrument used. With instrument measuring the average thickness over an area of not less than 0.645 cm^2 , the local thickness shall be the result of the one reading.

With instruments having one or more pointed or rounded probes, the local thickness shall be the mean of three readings within a circle of 0.645 cm^2 area.

With meters having two such probes, each reading shall be the average of two determinations with the probes reversed position.

3.7.6 Method of Test For Adhesion

Using a straight edge and hardened steel scribe which has been ground to a sharp 30 degree point scribe two parallel lines at a distance apart equal to approximately 10 times the average coating thickness. In scribing the two lines, apply enough pressure on each occasion to cut through the coating to the base metal in a single stroke.

3.7.7 Inspection:

Determination of Local Thickness

The minimum local thickness shall be determined by the method described above.

Adhesion

The sprayed metal coating shall be subjected to an adhesion test using the method described above. If any part of the coating between the lines breaks away from the base metal, it shall be deemed to have failed the test.

Articles, which have been rejected, shall have the defective sections blasted clean of all sprayed metal prior to repaying. Where the rejection has been solely due to too thin a coating, sprayed metal of the same quality may be added provided that the surface has been kept dry and is free from visible contamination.

The erection rate is to include the supply of all site rivets, turned and black Bolts, nuts, washers etc. required to complete erection at site as per relevant codes & practices.

3.8 Name Plate

A neat casting bearing the name of the Contractor, the place and year of manufacture, drawing number, the contract number and the standard of loading to be specified by the Purchaser shall be bolted conspicuously on each span. The drawing of the name plate shall be approved by the Engineer.

3.9 Erection Mark

Every portion of the work shall be distinctly stencilled with paint with letter size not less than 10 mm for guidance in the erection in the field, and stamped with the letters specified in the drawings. In the case of non-interchangeable work, the system of marking shall be in accordance with the drawings prepared by the tenderer and approved by the Purchaser.

3.10 Packing

All projecting plates or bars shall be kept in shape by timber or angle bars spiked or bolted to them, and the ends of the chord lengths, end posts and plate girders at their shipping joints shall be protected and stiffened so as to prevent damage or distortion in transit as the Inspecting Officer may direct.

All threaded ends and machined surfaces are to be efficiently protected against damage in transit. The parts shall be sent out in lengths convenient for transport. All straight bars and plates except small pieces are to be sent out in convenient bundles temporarily rivetted or bolted together or bound with wrought iron or suitable wire as the Inspecting Officer may direct. All rivets, bolts, nuts, washers, plates under 300 mm square and small articles generally are to be packed separately for each span in cases each weighing, when full, not more than 350 kg, or in strong petroleum casks, or in barrels approved by the Inspecting Officer. If not entirely filled by the contents the space left shall be closely packed with wood shaving or other suitable material. Bolts

and rivets of different sizes shall be separately packed in bags, each bag having a label indicating its contents. A list of the contents shall be placed in the top of each case or cask. In the case of imported material all cases shall be made of 32mm boards with ends nailed with 90mm wire nails strengthened by battens and 38mmx 1.6mm (No. 16 BG) hoop -iron and made thoroughly secure for transit to India. All casks shall be in sound condition, and if not entirely filled by the contents the space left shall be closely packed with wood-wool or other suitable material. The heads shall be firmly secured by means of hoops in the usual way, and in addition each head shall be further secured by a strong wooden batten and not less than two strips of 1.6mm (No.16 BG) hoop-iron passing over the head and nailed to the staves on both sides. The hoop-iron shall be long enough to pass over two hoops on each side of the cask and be nailed in such a manner that the hoops cannot slack back. Bolts and rivets of different sizes shall be packed in a separate canvas bags, each bag having a label in dictating its contents. End field holes to be bolted in case of members having split in plate and channels.

3.11 Dispatch or Shipping marks

Each package, case or bundle is to have clearly stencilled on it in good oil paint the address as stated in the order of contract, gross and net weight description of contents and such marks as may be required by the Purchaser must be shown against each item in the invoice. The Contractor is to provide necessary stencil plates for marking. Every piece of bundle shall be marked and in the case of material (shipped to India) all cases or casks shall be clearly cut or branded, not merely painted, with their net and gross weights and with such shipping marks and other particulars as the Inspecting Officer may direct and each bundle shall also have a metal label securely attached with wire stamped with similar marks. The marking shall be done with thick oil paint and in such a manner that it cannot be washed off or obliterated.

3.12 Loading

All trucks or wagons are to be loaded to as near their full capacity as is consistent with safe transport. While loading the material in wagon, truck or trailer, care should be taken that heavier material is loaded first and lighter material is kept on top so that lighter material is not damaged due to heavy weight. While transporting the material by road, adequate safety precautions shall be taken as per extant instructions.

The Contractor shall apply all dunnage and lashing required to hold the material securely in position free of charge.

While handling any girder or girder component it shall be ensured no damage to material takes place in the form of dent/cut mark etc. Wooden blocks, rubber pads shall be used to avoid direct contact between materials to be handled and handling equipment.

3.13 Tracings and Printings

Except in the case of standard spans fabricated without any modifications to the standard drawings the Contractor shall supply free of charge, one set of neatly executed tracing on linen. They shall be fully dimensioned and contain all erection marks, notifications as to the colour the work has been printed, the name of the

Contractor and any alterations from the contract drawings, which may have been made in executing the work. The drawings shall conform to standard sizes as given in IS: 962 and shall not exceed A0 size. The drawings shall not be folded but rolled outwards on a roller, in addition to three sets of full size copies on strong paper made by an approved process.

3.14 Rivets and Bolts lists

The Contractor shall also supply, without charge, three complete lists of the rivets, bolts, service bolts, washers and drifts required for erecting the work at site, showing the parts of the work to which the various rivets and bolts belong and having each item marked so as to indicate the particular case in which it will be found.

4.0 **Assembly, Erection and Launching**

4.1 General

Technical specifications given herewith are just for guidance of the erection/launching contractor. In case of difference as compared to the codal provisions, provisions of the codes shall prevail. Regarding this, decisions of the Engineer shall be final.

The Contractor shall provide at his own cost all tools, machinery, equipment and erection material, including all temporary works and shall assemble all components in every respect as stipulated in the contract and in accordance with approved drawings and specifications.

It is the responsibility of the erection/launching contractor to submit the erection/launching plan for dry span as well as water span both. The same shall be checked by the consultant and finally approved by the client / Engineer. Work shall be done as per the approved plan and the approved methods statements submitted by the erection/launching contractor.

Erection/launching contractor while finalizing the methods statements shall go through the details contained in this tender document as well as the referred codes and manuals and finalize the procedures along with specifications. The procedures/specifications/methods statements submitted by the erection/ launching contractor shall be at least at par with the details given herewith or superior to that.

On account of drawings under still finalization, it is possible that certain details contained in this tender document either might be missing or might be superfluous. In case of missing details, the erection/ launching contractor shall supplement the same, which shall be ultimately approved by the Engineer in consultation with the Consultant.

The supply, fabrication, erection & launching contractor shall note that payment shall be made strictly as per the Bill of Quantities. Nothing beyond that shall be payable. Contractors are advised to quote their rates accordingly.

Erection/launching contractor shall be totally responsible for the safe working. Following of the procedures contained herein does not mean that in case of any type of mishap, erection/launching contractor shall not be responsible. Erection/launching contractor shall examine each and every aspects and suggest some changes in procedures wherever he thinks like that, for the approval of Consultant and Engineer.

Trial launching of two spans (As per instruction of Engineer) will have to be done at ground level. While doing the trial launching all temporary/ permanent connection/ strengthening will have to be provided and all operations as per actual launching will have to be done. All fabrication material to be used in bridge girders shall be provided by contractor. Problem faced during the trial launching will have to be addressed before final launching is taken up. Trial launching shall be considered as part of the launching work, and for that, no extra payment shall be made. If the trial assembly is done within river bed (dry span) these girders may be raised to the bearing level and place on piers in position if so desired by the tenderers.

While doing the erection /launching work, the erection/ launching contractor shall follow the standard practices to ensure design Camber after erection /launching of the bridge girders.

4.2 Drilling and Sub-punching

All holes shall be drilled but the Contractor may, if he/she so prefers sub-punch them to a diameter 6mm less than that of finished holes, e.g. a punched hole which is to be drilled out to 25mm in diameter shall not exceed 19mm in diameter at the die end. When the rivet holes are to be sub-punched, they shall be marked with a centre punch and made with a nipple punch or preferably, shall be punched in a machine in which the position of the hole is automatically regulated. The punching shall be so accurate that when the work has been put together before drilling, a gauge 1.5mm less in diameter than the size of the punched holes can be passed easily through all the holes. Holes for countersunk heads of rivets, bolts or screws shall be drilled to the correct profile so as to keep the heads flush with the surface. Holes for countersunk heads of rivets, bolts or screws shall be drilled to the correct profile so as to keep the heads flush with the surface. No sub-punching shall be allowed in the main truss members of open-web girders. Holes for turned bolts should be 1mm under drilled in shop and should be reamed at site to suit the diameter of turned bolt.

Where the number of thicknesses to be riveted exceeds three or the total thickness is 90mm or more, the rivet holes, unless they have been drilled through steel-bushed jigs, shall be drilled out in place 3mm all round, after assembling. In such cases the work shall be thoroughly bolted together

The steel bushes shall be case hardened by an approved process and checked for diameter after the heat-treatment. The bores of bushes shall initially have a tolerance of -0mm, 0.1mm. The tolerance shall be checked from time to time and when the bores exceed a tolerance of, -0mm, +0.4mm, the bushes shall be rejected. For this purpose, go and no-go gauges are to be used. Tolerances for checking jigs from master plates shall be +0 mm -0.13 mm.

The work shall be taken apart after drilling and all burrs left by the drill and the sharp edges of all the rivet holes completely removed.

4.3 Parts in Contact

All steel work intended to be riveted or bolted together shall be in contact over the whole surface.

Drifts as shown in Fig. No.-1 may be used for drawing light members into position but their use on heavy members should be restricted to securing them in their correct positions. In no case, shall drifting be allowed to such an extent that holes are distorted

FIG.- 2&3

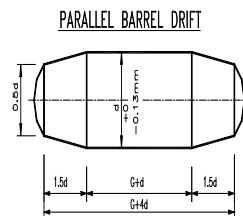

d. IS THE NOMINAL DIAMETER OF THE HOLE.
G. IS THE COMBINED THICKNESS OF THE METAL THROUGH WHICH THE DRIFT HAS TO PASS.
STEEL- IS: 1875 OR IS: 7283

FIG.-2
(REF. CLAUSE 19 & 20)

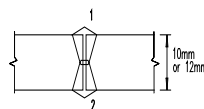

Sketch showing sequence of square butt welding

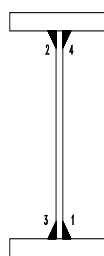

Sketch showing the sequence of fillet welding

for fabricating the I-section

FIG.-3
(REF. CLAUSE 27)

Figure No.-1

Drifting to enlarge un-faired holes is prohibited. The holes that will have to be enlarged to admit rivets should be reamed provided the Engineer permits such reaming after satisfying himself about the extent of inaccuracy and the effect of reaming on the soundness of the structure. The Purchaser retains the right to reject all steel work if the holes are not properly matched.

4.4 Making of Joints

Cleaning of permanent contact surfaces: Surfaces which will have permanent contact shall be removed of paints and mill scale down to bare metal, clean and dried and immediately a coating of red lead to IS: 102 shall be applied. Care shall be taken to see that all burrs are removed and no surface defects exist before the parts are assembled.

4.4.1 Bolting and drifting

Only barrel drifts as per Fig. No.-1 shall be used in erection. They may be used for drawing light members into position; but their use on heavy members shall be restricted to securing them in their correct position. Any apparent error in shop work, which prevents the assembling and fitting up of the parts by the proper use of these drifts, shall be investigated immediately. As all work is rigidly inspected in the manufacturers work before dispatch, these difficulties should not arise and the cause should be first be sought in the use of incorrect components or the transposition of a correct part. It is usually important that parts should be correctly handled. Should error still persist, the matter shall be immediately reported to the Engineer who will decide what action is to be taken. No reaming shall be undertaken without the written authority of the Engineer, except for the under drilled holes meant for turned bolts. If approved, the Contractor shall supply, at his/her own expense, any special rivets that maybe required. Copies of all correspondence relative to the recourse to reaming and the use of over-size rivets shall invariably be sent by the Engineer for information to the inspectorate concerned.

Joints shall normally be made by filling not less than 50% of the holes with service bolts and barrel drifts in the ratio of four to one. The service bolts are to be fully tightened up as soon as the joint is assembled.

4.4.2 Special methods of erection other than described in Appendix III of IRS B1-2001 Specification

In cases where the joints have to withstand stresses arising from special method of erection, provision is to be made to take the whole stress that will or may occur. Cylindrical drifts and turned bolts shall be used to withstand such stresses and no reliance is to be placed on the service bolts for this purpose. Up to maximum of 40% of the holes of each member of the joint are to be filled with drifts and balance of strength required is to be attained with turn bolts. The Engineer will intimate the position and number of the drifts and bolts. The condition of "Making of Joints" of this technical Specification must be observed and the bolt fully tightened up as soon as the joint is made.

Where the manufacturing of girders has been done in accordance with "Interchangeability" of this specification relating to steel girder bridges, the erection shall be done in accordance with Appendix III of IRS B1-2001 Specification or the methods suggested by the erection/launching contractor dully approved by the Consultant and the Client.

4.4.3 Emergency jointing

In the event of an emergency arising such as the staging is in danger of being carried away by floods before the riveting can be completed, the joints shall be made secure by filling 40% of the holes with cylindrical drifts and equal number with service bolts fully tightened.

4.5 Erection and Equipment

The erection/launching contractor shall provide at his/her own cost all tools, machinery, equipment and erection material necessary for the expeditious execution of the work and shall erect the structural steel and iron work, in every respect as covered by the contract and in accordance with the drawings and specifications.

Before starting the work, the Contractor shall advise the Engineer fully as to the method he/she proposes to follow and the amount and character of equipment he/she proposes to use, which shall be subjected to the approval of the Engineer. The approval of the Engineer shall not be considered as relieving the Contractor of the responsibility for the safety of his/her method or equipment or from carrying the work in full accordance with the drawings and specifications.

All temporary work shall be properly designed and substantially constructed for the loads, which it will be called upon to support. Adequate allowance and provision of a lateral forces and wind loads shall be made according to local conditions and ensure that support shall not settle during erection. Careful and periodical inspection of plants shall be made by the Contractor to ensure that all tackle, ropes, chains and other important lifting gear and machinery are in good order and fit for service and well up to the capacity for which they are required. When chains are used for lashing, care must be taken to protect the edges of members to avoid the marking and distortion otherwise caused. Span erected upon staging shall be supported upon suitable blocks, which shall ensure that the girders shall be at the correct elevation and alignment when completed. If other methods of erection be adopted where staging in situ is not employed, special means shall be used to ensure this. The method used for lifting and slinging flexible members shall be brought to the notice of the Engineer and shall be subject to his/her approval. Temporary bracing shall be provided to take care of stresses from erection equipment or other loads carried during erection.

4.6 Bearings & Anchorages

Bed plates shall be set to required level and fixed accurately in position by giving full and even bearing by setting them on a layer of cement sand and cast iron chips as approved and directed by the Engineer. The Contractor shall drill the holes where necessary and set the anchor bolts. The bolts shall be set accurately and fixed with cement grout or any other grouting material as approved by the Engineer completely filling the holes.

4.7 Arrangement of Drifts, Nuts, Bolts etc and all other Consumables required in this work

All required drifts, nuts, bolts and other fasteners including all types of consumables as required shall be procured by the erection/launching contractor at his/their own cost

for use of the same in the erection/launching work. All such materials shall conform to IRS/IS specifications.

4.8 Field rivets

All field rivets required in connection with the erection work shall be arranged by the erection/launching contractor at his/their own cost. Since the fabricated components are high tensile steel and mild steel both, rivets to be used shall be of high tensile steel only.

4.9 Rivets and Rivetting

The dimensions on the drawings referred to the diameters of the rivet holes and their finished rivets. The rivet holes shall be 1.5 mm greater than the diameter of the rivet bars used. The rivets shall be made as per the IS specifications. The shanks of the un-driven rivets shall be made of a length sufficient to fill the holes thoroughly and form the head. The clearance i.e. the difference in diameter between the rivets measured under head before being heated and the rivet hole shall not be less than 0.75mm. Before riveting is commenced, all works shall be properly bolted so that the sections riveted are in close contact throughout. Rivets shall completely fill the holes and shall be machine driven by means of pressure or percussion riveters of approved design.

All rivets shall be properly heated to straw heat for the full length of the shank, firmly backed and closed. The head of the rivet, particularly in long rivets, shall be heated more than the point and in no case shall the point be heated, more than the head. Sparking or burnt rivets shall not be used. Where it is impossible to back up by normal method of holding up, 'double gunning' may be resorted to. Alternatively pneumatic holding device may be used.

Gauges for rivet dimensions and contours shall be provided by the Contractor for the use of the Inspecting Officer.

Rivets when driven shall completely fill the holes, have the heads concentric with the shanks and shall be in full contact with the surface. Driven rivets when struck sharply on the head with the 110-gm. rivet testing hammer, shall be free from movement or vibration.

While riveting built-up members, full care should be exercised to ensure that the set of holes for field rivets in each flange of the built-up member, is aligned dead-square in relation to that in the other flange and not 'aberrated'. Use of assembly fixtures shall be made to ensure this.

All loose and burnt rivets and rivets with cracks, badly formed, eccentric or deficient heads shall be cut out and replaced. Permissible deviation of driven rivets shall be as per Appendix IV of IRS B1-2001 Specification. For ready reference, the same has been produced in the "Quality Control" part of this technical specification. Rivets shall also be cut out when required for the examination of the work. Actual method of cutting out shall be approved by the Engineer. Re-cupping and caulking shall in no circumstances be resorted to.

Riveting shall not be started until such time as the Engineer has personally satisfied himself that the alignment of the girders is correct, the verticals plumb laterally, the camber according to that shown on the camber diagram with camber jacks screwed tight, all the joints and cover plates well up, service bolts tight and field rivet holes coinciding. Special care should be taken that service bolts are frequently re-tightened as the riveting proceeds.

All field rivets shall be tested as directed by the Engineer.

Where practicable all riveting shall be done by pneumatic or hydraulic riveting machine. The working pressure to be employed when using pneumatic or hydraulic tools shall be approved by the Engineer. Hand riveting shall only be done when specified in the drawing and approved by the Engineer. In such cases, means shall be adopted to ensure the rivets being used in their entire -only to give the correct form of head. When all the rivets of joints have been finally passed, they shall be painted as under. One coat of ready mixed zinc chrome primer to IS: 104 followed by one coat of ready mixed paint red oxide zinc chrome primer to IS: 2074

Finishing coat as per painting schedule given under "Oiling, Painting and Metallising" of this technical specification. For further details on the riveting, "Indian Railways Bridge Manual" can be referred to.

4.10 Field Rivets, Bolts, Nuts and Service accessories

The work is to include supply of all units, bolts, nuts, washers etc required to complete erection at site with an allowance for wastage etc of 12.5% of the net number of field rivets, bolts and washers required subject to a minimum number of five in each item.

The Contractor shall be responsible for supplying site rivets of approved length. The length of such rivets shall be verified by snapping a few rivets of each length in the presence of the Inspecting Officer. In the case of rivets with long grips (with grip exceeding 6 times the diameter) specimen rivets on the test piece shall be cut to see if the holes are totally filled even though the rivets are tight under the usual hammer tests.

Black hexagonal bolts (Service bolts) with nuts and ordinary platter's washers and drifts for use in the erection of the work shall also be supplied at 60% (45% bolts and 15% drifts) of the number of field rivets per span in each size (this includes wastage). The Purchaser may however, specify a reduction in the quantities of service bolts etc. if more than one span of each type is ordered.

4.11 Smithed work

All joggles shall be performed by pressure. Craned sections or knees can be formed by forging or by gas cutting and welding by any approved electric arc process. Any bending, forging, cutting or welding shall be carried out in such a manner as not to impair the strength in the metal. Forging shall be annealed as indicated in the drawing.

If drop forging through dies is resorted to, excessive forging in one operation shall be avoided. Where necessary, a series of intermediate stage dies shall be manufactured and used.

4.12 Welding

Normally, field welding are not allowed for bridge works. Only in special circumstances, with the approval of Engineer, field weldings are being carried out and that too, as per the approved plan. Welding details given herewith shall only be used in special circumstances.

Welding of the bridge girders shall be done under strict supervision of the Engineer and Approved procedures shall be followed.

4.13 Transports from Workshop & Stacking at Site

All items fabricated in the workshop shall be marked and packaged with accompanying package list. Contractor shall be liable for all losses and damages in transit for the materials consigned by him till materials are erected and work completed and taken over by the Engineer. Insurance against loss or damage in transit, if any, shall be the responsibility of the contractor.

After identification & correct marking, all components of each girder shall be dismantled & similar components shall be grouped together & labeled; rivets bolts and plates of each size shall be packed separately in the manner described elsewhere in this tender document, after approval by the inspecting authority.

The packages shall be of such size by length & weight that they are safely transportable by Road. The components shall be provided with necessary packing to avoid damage to painting & members in transit.

Dimensions for transport shall be as per standard schedules.

4.14 Assembly at Site

Holes:

After drilling holes in temporary tack assembled components, the components shall be taken apart after match marking and all burrs left by drill and sharp edges of all holes shall be removed by spot grinding to ensure full contact when assembled.

Assembly fixture shall be used to build components for turned bolt connection. These connections will help realize correct position of member and matching of coaxial holes in opposite members besides true alignment and level.

After assembly, all blank holes shall be checked with plug gauge of diameter 0.8mm less than hole diameter, to check fair matching of holes before riveting.

Drifts:

Drifts as per IRS specifications may be used for drawing light members into position, but their use on heavy members should be restricted. In no case shall the drifting be

allowed to such an extent that holes are distorted. Drifting to enlarge the unfaired holes is prohibited.

Reaming:

The holes that will have to be enlarged to admit rivets should be reamed subject to approval of Engineer/Inspecting Officer who will satisfy himself about the extent of inaccuracy and the effect of reaming on the soundness of the structure. The Contractor shall supply special rivets to fill reamed holes, where reaming is approved. Record of all such variations shall be maintained. However, these provisions should not apply for under drilled holes meant for turned bolts. Copies of all correspondence pertaining to the recourse of reaming and the use of over size rivets shall be sent by the contractor for information to Engineer.

Making of joints:

Care shall be taken to see that all burrs are removed and no surface defects exist before the parts are assembled. The mating surfaces shall establish full contact when assembled. In cases where the joints have to withstand stresses arising from special methods of erection, provision is to be made to take the whole stress that will or may occur. Cylindrical drifts and turned bolts shall be used to withstand such stresses and no reliance is to be placed on service bolts for this purpose. Up to a maximum of 40 percent of the holes of each member of the joint are to be filled with drifts and balance of strength required is to be attained with turned bolts. The position and number of the drifts and bolts will be decided / approved by Engineer.

Painting of Joints:

All surfaces, which are in permanent contact, shall be thoroughly cleaned down to the bare metal, to remove mill scale and grease etc. They shall be painted immediately before assembly with one coat of red lead conforming to IS:102 and raw linseed oil freshly ground and the surface prepared for painting as per painting specification.

4.15 Assembly and Launching

- i. The assembling of components at site to required camber and grade along bridge axis, preceding additional temporary structures and accessories for launching of girders and all related matters shall be full responsibility of the contractor.
- ii. The launching of girders shall be done as per approved drawings. For this purpose, the contractor shall submit in triplicate, detailed launching schemes of all the girders including design calculations, safety procedures and method statement with such plans, sketches and other details as may be necessary to determine the suitability and adequacy of the schemes proposed. The methods adopted shall not, under any circumstances, cause the stresses in various members of girder spans to exceed permissible and safe limits at any stage of launching. One copy duly approved by the Engineer shall be returned to the contractor.
- iii. For the Engineer's use and record, the contractor shall supply free of charge, four sets of prints on strong paper and one set of neatly executed tracings on linen of approved detailed drawings for assembly and launching schemes for use at site.

- iv. The contractor shall provide full structural details of the temporary members and their connections to the girder, along with necessary design calculations not only justifying members sizes but also of the entire launching system adopted. Contractor will be responsible for getting approval of launching scheme submitted by him from the Engineer.
- v. In order to ensure perfect fit of the temporary components, holes may be carefully drilled for the connecting members in between the girders in situ and T & F High tension grip bolts used.
- v. The launching system shall be test tried if directed by the Engineer and no separate payment for this shall be made.
- vi. Nothing extra will be paid to the contractor for adopting any scheme for launching and the costs are to be covered in the relevant item in the schedule of items, quantities and rates. All temporary members shall be removed after launching and may be taken back by the contractor. Erection gussets provided for connecting the members may be cut and edges ground as directed /approved by the Engineer.

4.16 Permanent/Temporary Strengthening

The launching arrangement may include launching nose or restraining girders, sway restraining devices such as sway ropes, restraining cables etc. The supply and fixing of members for temporary strengthening of girder members to take care of erection stresses and strains and other relevant components for satisfactory and successful completion of the defined scope of work. Erection stresses must be kept within safe and permissible limits at every stage of erection.

The contractor has to make arrangements at his own cost for the steel for temporary arrangements including sway restraining devices for launching, as may be required for the launching operations. The rate quoted should take into account these factors as nothing extra shall be paid.

Launching scheme may also require temporary/permanent strengthening of some members, which will be done by contractor. Any work required to be done at site for launching with materials to be arranged and supplied by contractor.

4.17 Inspection and Rectification

During erection of girders, the contractor shall provide all facilities and permit the Engineer to inspect the field assembly, site riveting and erection of spans to the satisfaction of engineer.

After inspection by the Engineer/ Inspecting agency, the contractor shall identify cause of any defect, imperfection and/or fault noticed during such inspection and initiate corrective action as per the direction of the Engineer. All defects, imperfections or faults, shall be made good by the contractor to the Engineer's satisfaction and the cost of identifying and rectifying such defects, imperfection or faults shall be borne by the contractor.

4.18 Additional Requirements for Superstructure

SKETCHES

In this portion, some sketches useful to the fabrication work have been given for the benefit of the tenderer. In case further elaboration is required, tenderer will develop his own sketch and get approval of the Engineer.

FIG.- 2&3

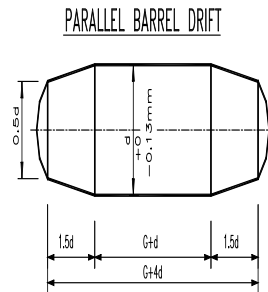

d. IS THE NOMINAL DIAMETER OF THE HOLE.
 C. IS THE COMBINED THICKNESS OF THE METAL THROUGH WHICH THE
 DRIFT HAS TO PASS.
 STEEL – IS: 1875 OR IS: 7283

FIG.-2
 (REF. CLAUSE 19 & 20)

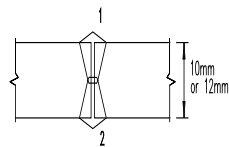

Sketch showing sequence of square butt welding

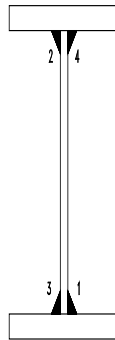

Sketch showing the sequence of fillet welding
for fabricating the I-section

FIG.-3
 (REF. CLAUSE 27)

Fig No.-1

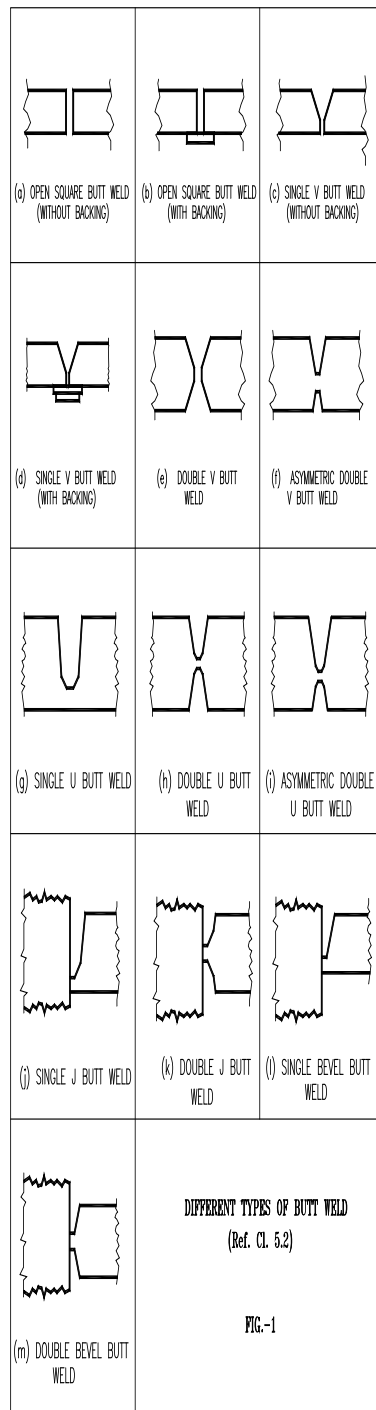
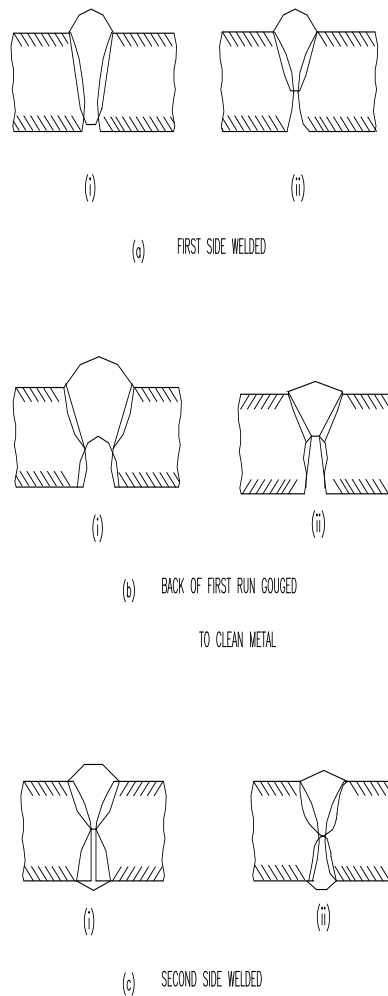

Fig. No.-2: Different types of Butt Welds



DIAGRAMMATIC REPRESENTATION
METHOD OF GOUGING OUT COMPLETE
PENETRATION BUTT JOINTS WELDED
FROM BOTH SIDES

FIG.2

Fig No.-3: Diagrammatic representation of method of gauging out complete penetration butt joints welded from both ends.

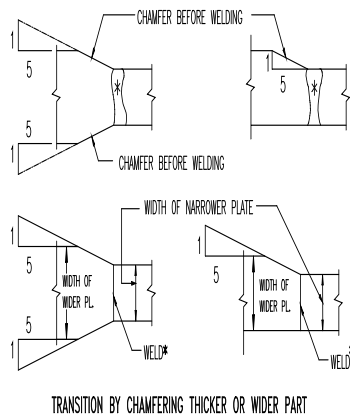

FIG.-3

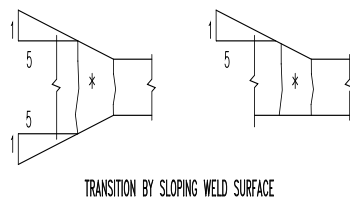

FIG.-4

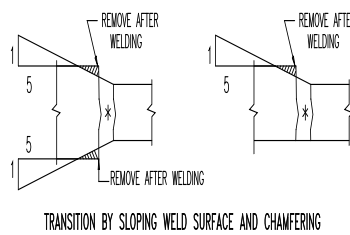
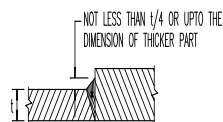

FIG.-5



BUTT WELD WHERE TRANSITIONING IS NOT PRACTICABLE

FIG.-6

NOTE:-

1. * WELD MAY BE OF ANY PERMITTED OR QUALIFIED TYPE & DETAIL.
2. TRANSITION SLOPES SHOWN ARE THE MAXIMUM PERMITTED.

BUTT WELDING PARTS OF UNEQUAL CROSS SECTION

Fig.No.-4

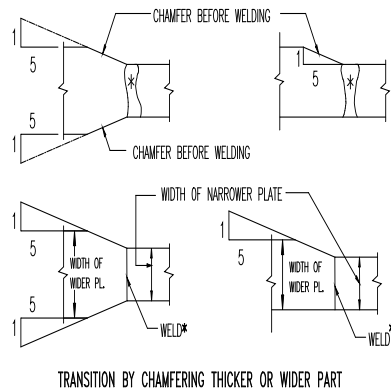

FIG.-3

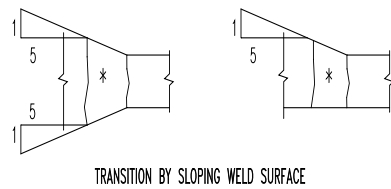

FIG.-4

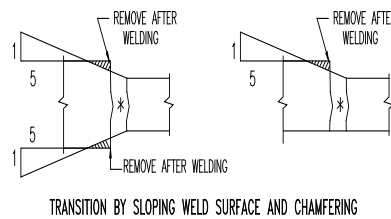

FIG.-5

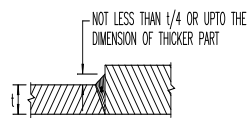

FIG.-6

NOTE:-

1. * WELD MAY BE OF ANY PERMITTED OR QUALIFIED TYPE & DETAIL.
2. TRANSITION SLOPES SHOWN ARE THE MAXIMUM PERMITTED.

BUTT WELDING PARTS OF UNEQUAL CROSS SECTION

Fig. No.-5

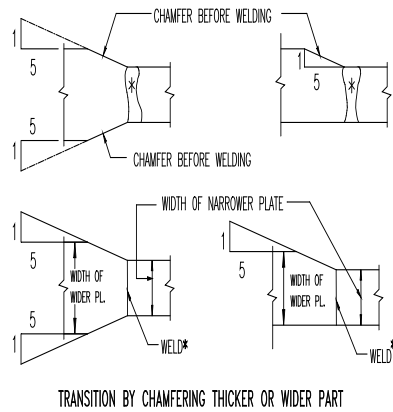

FIG.-3

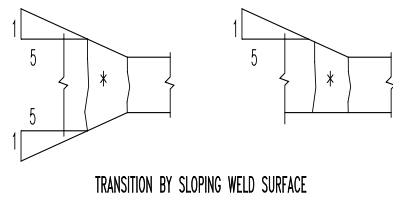

FIG.-4

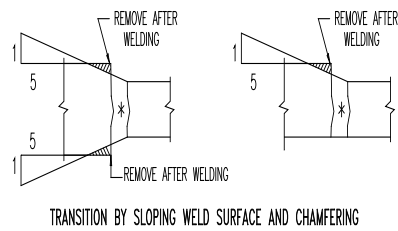
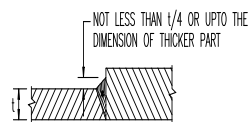

FIG.-5



BUTT WELD WHERE TRANSITIONING IS NOT PRACTICABLE

FIG.-6

NOTE:-

1. * WELD MAY BE OF ANY PERMITTED OR QUALIFIED TYPE & DETAIL.
2. TRANSITION SLOPES SHOWN ARE THE MAXIMUM PERMITTED.

BUTT WELDING PARTS OF UNEQUAL CROSS SECTION

Fig No.-6

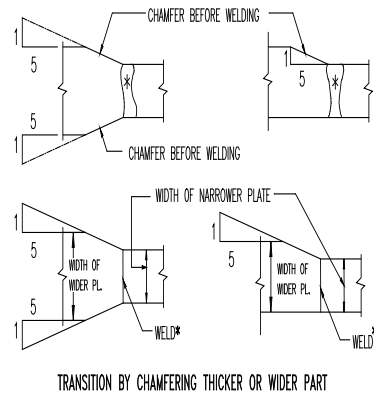

FIG.-3

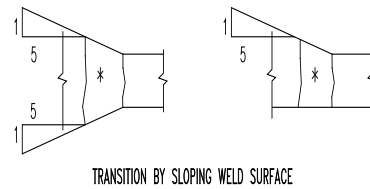

FIG.-4

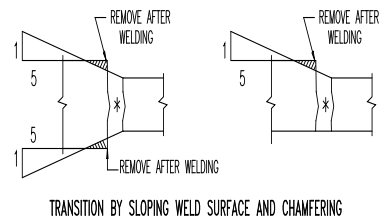
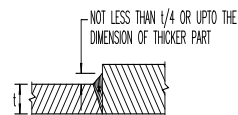

FIG.-5



BUTT WELD WHERE TRANSITIONING IS NOT PRACTICABLE

FIG.-6

NOTE:-

1. * WELD MAY BE OF ANY PERMITTED OR QUALIFIED TYPE & DETAIL.
2. TRANSITION SLOPES SHOWN ARE THE MAXIMUM PERMITTED.

BUTT WELDING PARTS OF UNEQUAL CROSS SECTION

Fig. No.-7

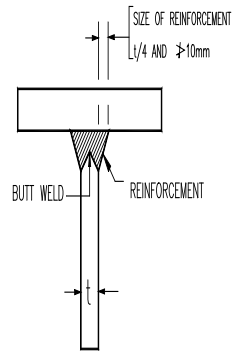

BUTT WELDED T JOINT

FIG.-7

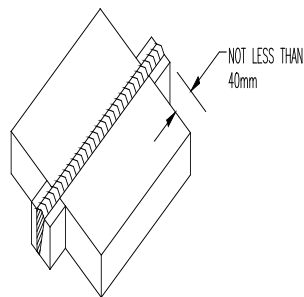

BUTT WELDED JOINT WITH RUN-ON
AND RUN-OFF PLATES

FIG.-8

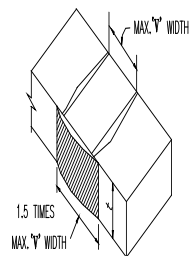

BUTT WELD END REINFORCEMENT

FIG.-9

Fig. No8:Butt Welded T Joint

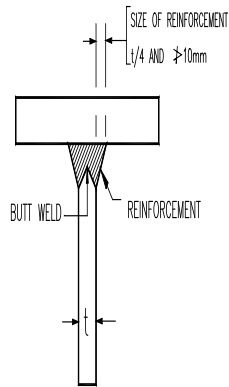

BUTT WELDED T JOINT

FIG.-7

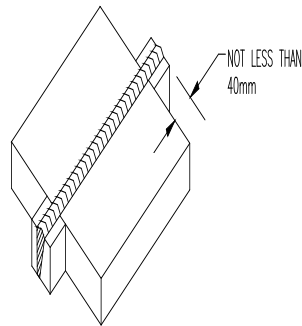

BUTT WELDED JOINT WITH RUN-ON
AND RUN-OFF PLATES

FIG.-8

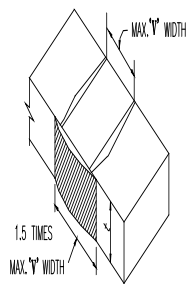

BUTT WELD END REINFORCEMENT

FIG.-9

Fig. No.-9: Butt Welded Joint With Run On & Run Off Plates

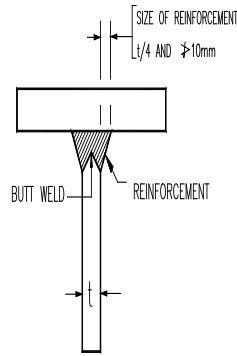

BUTT WELDED T JOINT

FIG.-7

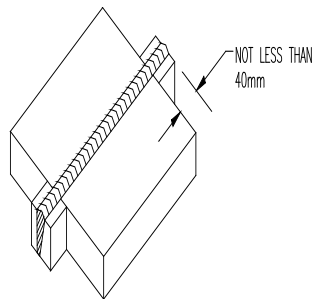

BUTT WELDED JOINT WITH RUN-ON
AND RUN-OFF PLATES

FIG.-8

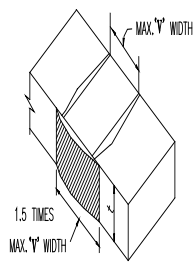

BUTT WELD END REINFORCEMENT

FIG.-9

Fig. No.-10: Butt Weld End Reinforcement

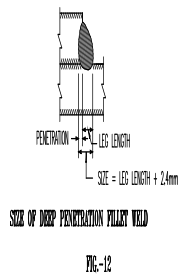
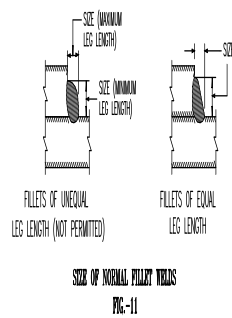
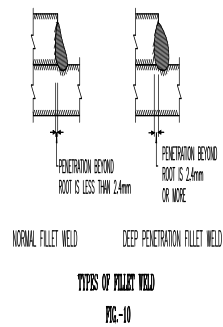

Z W W O K A N Z I A N S T E E L C O D E	60°-90°	90°-100°	100°-106°	107°-113°	114°-120°
		0.70	0.65	0.60	0.55

FIG-13

Fig. No.11: Types of Fillet Weld

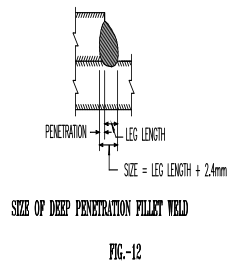
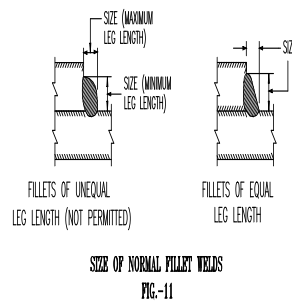
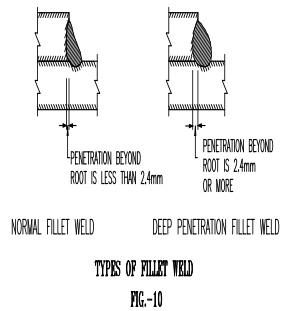

	60°-90°	91°-100°	101°-106°	107°-113°	114°-120°
ANGLE BETWEEN FUSION FACES					
CONSTANT	0.70	0.65	0.60	0.55	0.50

FIG.-13

Fig No.-12: Size of Normal Fillet Weld

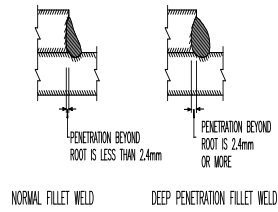

TYPES OF FILLET WELD

FIG.-10

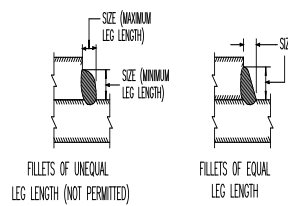

SIZE OF NORMAL FILLET WELDS

FIG.-11

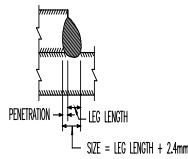

SIZE OF DEEP PENETRATION FILLET WELD

FIG.-12

	60°-90°	91°-100°	101°-106°	107°-113°	114°-120°
ANGLE BETWEEN FUSION FACES					
CONSTANT, 'K'	0.70	0.65	0.60	0.55	0.50

FIG.-13

Fig No.-13: Size of Deep Penetration Fillet Weld

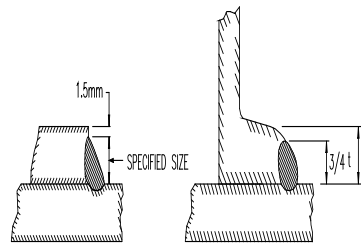

**FILLET WELD APPLIED TO SQUARE
EDGE OF PLATE OR ROUND TOE OF ROLLED SECTION**

FIG.-14

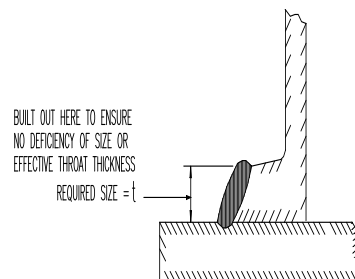
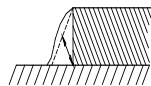
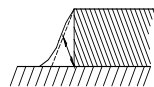

FIG.-15



(a) ACCEPTABLE - REQUIRED THROAT THICKNESS OBTAINED



(b) ACCEPTABLE - REQUIRED THROAT THICKNESS OBTAINED

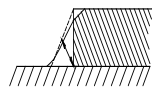

(c) NOT ACCEPTABLE - REQUIRED THROAT THICKNESS NOT OBTAINED

FILLET WELD EQUAL TO THE SIZE OF PLATE OR SECTION

FIG.-16

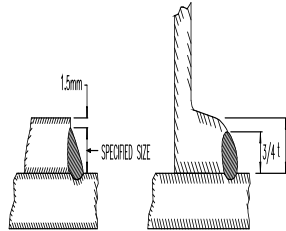

FILLET WELD APPLIED TO SQUARE
EDGE OF PLATE OR ROUND TOP OF ROLLED SECTION

FIG-14

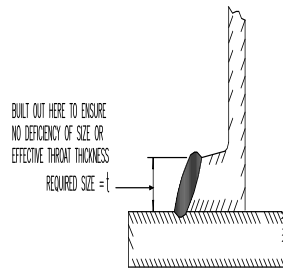
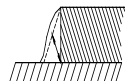
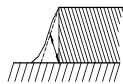

FIG-15



(a) ACCEPTABLE - REQUIRED THROAT THICKNESS OBTAINED



(b) ACCEPTABLE - REQUIRED THROAT THICKNESS OBTAINED

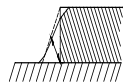

(c) NOT ACCEPTABLE - REQUIRED THROAT THICKNESS NOT OBTAINED

FILLET WELD EQUAL TO THE SIZE OF PLATE OR SECTION

FIG-16

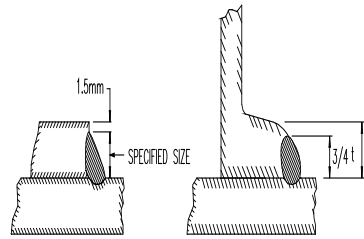

FILLET WELD APPLIED TO SQUARE
EDGE OF PLATE OR ROUND TOE OF ROLLED SECTION

FIG.-14

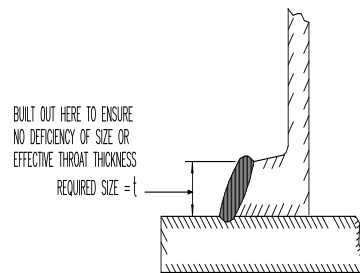
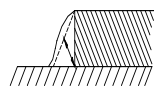
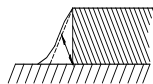

FIG.-15



(a) ACCEPTABLE - REQUIRED THROAT THICKNESS OBTAINED



(b) ACCEPTABLE - REQUIRED THROAT THICKNESS OBTAINED

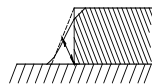

(c) NOT ACCEPTABLE - REQUIRED THROAT THICKNESS NOT OBTAINED

FILLET WELD EQUAL TO THE SIZE OF PLATE OR SECTION

FIG.-16

Acceptance and Rejection of the Welds

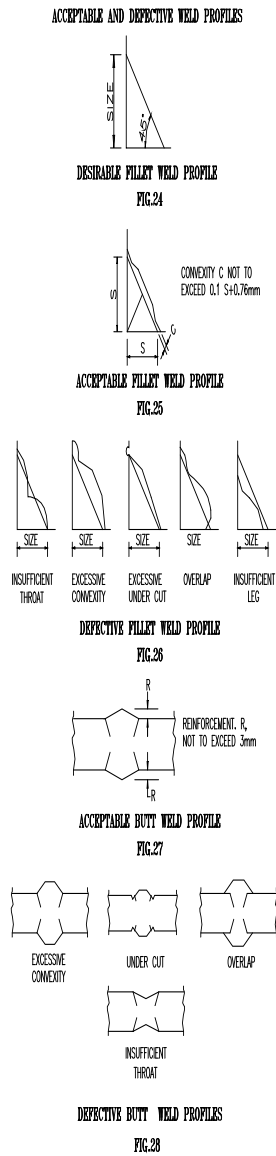

Fig. No.-17: Desirable weld profile

ACCEPTABLE AND DEFECTIVE WELD PROFILES



DESIRABLE FILLET WELD PROFILE

FIG.24

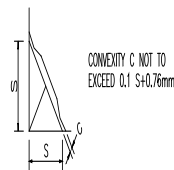

ACCEPTABLE FILLET WELD PROFILE

FIG.25

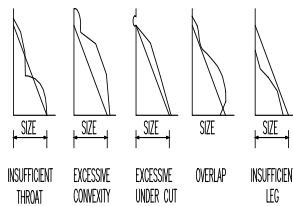

DEFECTIVE FILLET WELD PROFILE

FIG.26

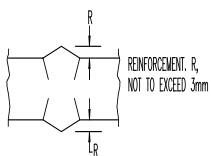

ACCEPTABLE BUTT WELD PROFILE

FIG.27

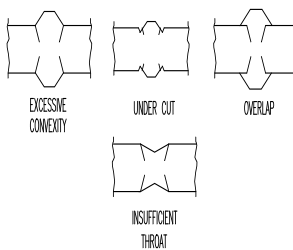

DEFECTIVE BUTT WELD PROFILES

FIG.28

Fig. No. 18: Acceptable weld profile

ACCEPTABLE AND DEFECTIVE WELD PROFILES

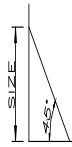

DESIRABLE FILLET WELD PROFILE

FIG.24

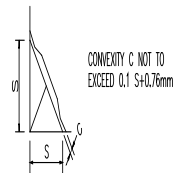

ACCEPTABLE FILLET WELD PROFILE

FIG.25

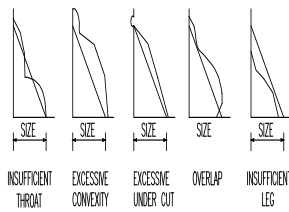

INSUFFICIENT THROAT EXCESSIVE CONVEXITY EXCESSIVE UNDER CUT OVERLAP INSUFFICIENT LEG

DEFECTIVE FILLET WELD PROFILE

FIG.26

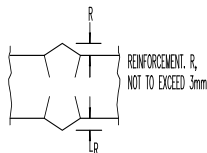

ACCEPTABLE BUTT WELD PROFILE

FIG.27

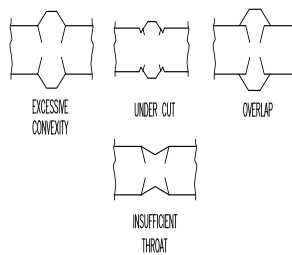

EXCESSIVE CONVEXITY UNDER CUT OVERLAP INSUFFICIENT THROAT

DEFECTIVE BUTT WELD PROFILES

FIG.28

Fig. No.-19: Defective fillet weld profile

ACCEPTABLE AND DEFECTIVE WELD PROFILES



DESIRABLE FILLET WELD PROFILE

FIG.24

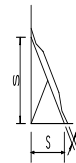

CONVEXITY C NOT TO EXCEED 0.1 S+0.76mm

ACCEPTABLE FILLET WELD PROFILE

FIG.25

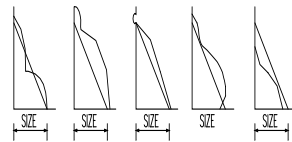

INSUFFICIENT THROAT EXCESSIVE CONVEXITY EXCESSIVE UNDER CUT OVERLAP INSUFFICIENT LEG

DEFECTIVE FILLET WELD PROFILE

FIG.26

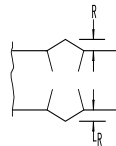

REINFORCEMENT, R, NOT TO EXCEED 3mm

ACCEPTABLE BUTT WELD PROFILE

FIG.27

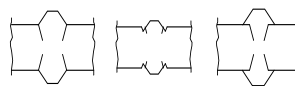

EXCESSIVE CONVEXITY UNDER CUT OVERLAP



INSUFFICIENT THROAT

DEFECTIVE BUTT WELD PROFILES

FIG.28

Fig. No. 20: Acceptable fillet weld profile

ACCEPTABLE AND DEFECTIVE WELD PROFILES



DESIRABLE FILLET WELD PROFILE

FIG.24

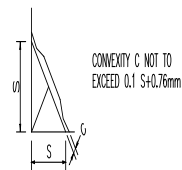

ACCEPTABLE FILLET WELD PROFILE

FIG.25

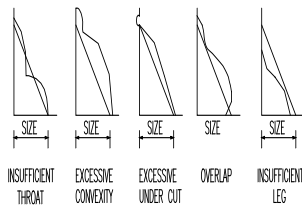

DEFECTIVE FILLET WELD PROFILE

FIG.26

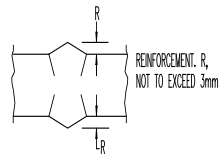

ACCEPTABLE BUTT WELD PROFILE

FIG.27

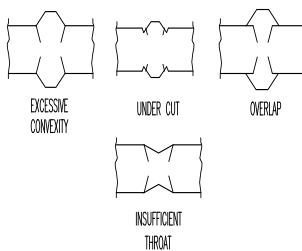

DEFECTIVE BUTT WELD PROFILES

FIG.28

Fig No. 21: Defective butt weld profile

APPENDIX - B
(Ref. CI 30.2)

FILLET WELD GAUGES AND THEIR APPLICATION

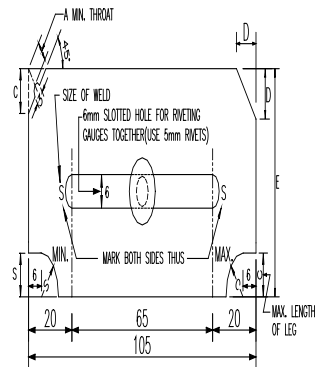

DIMENSION	WELD SIZE										
	5	6	8	10	12	14	16	18	20	22	25
A	3.5	4.2	5.7	7.1	8.5	9.9	11.3	13.9	14.2	15.6	17.5
S	5.0	6.0	8.0	10.0	12.0	14.0	16.0	18.0	20.0	22.0	25.0
C	6.0	7.0	9.0	11.0	13.0	15.0	17.0	19.0	21.0	24.0	26.0
D	6.7	7.8	10.3	12.4	14.8	17.2	19.3	21.6	23.7	26.3	30.3
E	40.0	40.0	50.0	50.0	50.0	50.0	50.0	50.0	65.0	65.0	65.0

METHOD OF GAUGE APPLICATION

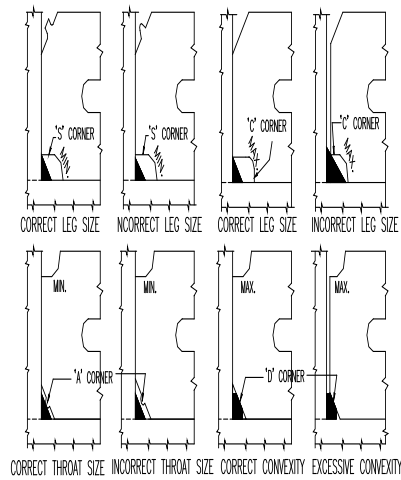

1. ALL DIMENSIONS ARE IN MILLIMETRES.
2. GAUGE FOR EACH WELD SIZE TO BE MANUFACTURED TO THE DIMENSIONS GIVEN IN THE TABLE ABOVE.
3. WELD GAUGE SIZE TO BE MARKED AT LOCATION 'S' IN 3mm LETTERS. OTHER MARKING IN 2mm LETTERS.
4. ALL MARKINGS TO BE DONE ON BOTH FACES.
5. THESE GAUGES ARE SUITABLE FOR INSPECTION OF NORMAL FILLET WELD OF SIZES 5 TO 25mm WITH ANGLE BETWEEN FUSION FACE OF 90° FOR DEEP PENETRATION WELD AND FOR ANY OTHER ANGLE BETWEEN FUSION FACES, SPECIAL GAUGES MAY BE MADE.

Fig No.-22: Fillet weld gauge and their application

FIG.- 2&3

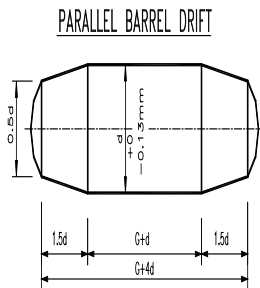

d. IS THE NOMINAL DIAMETER OF THE HOLE.
 G. IS THE COMBINED THICKNESS OF THE METAL THROUGH WHICH THE
 DRIFT HAS TO PASS.
 STEEL- IS: 1875 OR IS: 7283

FIG.-2
 (REF. CLAUSE 19 & 20)

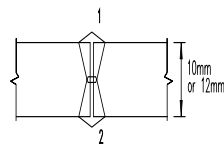

Sketch showing sequence of square butt welding

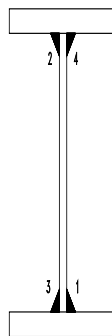

Sketch showing the sequence of fillet welding
 for fabricating the I-section

FIG.-3
 (REF. CLAUSE 27)

Fig. No.-23