

SPECIFICATIONS



BELL 429





Publisher's Notice

The information herein is general in nature and may vary with conditions. Individuals using this information must exercise their independent judgment in evaluating product selection and determining product appropriateness for their particular purpose and requirements. For performance data and operating limitations for any specific mission, reference must be made to the approved flight manual. Bell Textron Inc. makes no representations or warranties, either expressed or implied, including without limitation any warranties of merchantability or fitness for a particular purpose with respect to the information set forth herein or the product(s) and service(s) to which the information refers. Accordingly, Bell Textron Inc. will not be responsible for damages (of any kind or nature, including incidental, direct, indirect, or consequential damages) resulting from the use of or reliance on this information. Bell Textron Inc. reserves the right to change product designs and specifications without notice.

© 2022 Bell Textron Inc.

All registered trademarks are the property of their respective owners.

Table of Contents

Bell 429	1
Bell 429 Specification Summary (U.S. Units)	4
Bell 429 Specification Summary (Metric Units)	5
Bell 429 Helicopter Dimensions	6
Bell 429WLG	8
Bell 429WLG Specification Summary (U.S. Units)	9
Bell 429WLG Specification Summary (Metric Units)	10
Bell 429WLG Helicopter Dimensions	11
Bell BasiX-Pro™ Integrated Avionics System	12
Safety Enhancements	17
Bell 429 Maintenance Program	18
Seating and Interiors	21
Mission Profiles	24
External Paint Schemes	28
Bell 429 and 429WLG Common Production Configuration	29
Bell 429 and 429WLG Standard Configuration	32
Optional Accessories	33
Helicopter Performance Charts	39
Fuel Flow vs. Airspeed Charts	45
Cost of Operations	71
Limited Life Components	75
Global Support Network	77
Training	82
Aeronautical Accessories	86

New Standard Equipment

DIGITAL STANDBY INSTRUMENT

The Standby Attitude Module (SAM) is a single unit that provides airspeed altitude and attitude information to the pilot. It has backup power for continued operation in case of electrical power failure.

GARMIN GTX 345R TRANSPONDER

The GARMIN transponder GTX 345R is a Non-Diversity Extended Squitter (ES) Mode S transponder that operates on radar frequencies, receiving ground radar or Traffic Collision Avoidance System (TCAS) interrogations at 1030 MHz and transmitting a coded response of pulses to ground based radar on a frequency of 1090 MHz.

The GTX 345R is also equipped with Automatic Dependent Surveillance-Broadcast (ADS-B) In and Out to exchange aircraft traffic information with ADS-B ground stations and other ADS-B equipped aircraft.

FLIGHT STREAM 510 ADVANCED BLUETOOTH CONNECTIVITY

- Enabled Database Concierge wireless avionics database updates
- Permits 2-way flight plan transfers between compatible apps and avionics
- Initiate phone calls and send/receive text messages from contacts on your Apple® device, using the Garmin Pilot™ app through your compatible avionics, optional Connex™ datalink and service plan
- Streams traffic, weather, GPS information and back-up attitude information from your avionics to select portables and mobile devices
- Lets mobile devices wirelessly control SiriusXM™ satellite music from any position in the cabin



Bell 429

Bell 429

The Bell 429 delivers exceptional speed, range, hover performance and enhanced safety margins with a fully-integrated glass cockpit, advanced drive system, best-in-class WAAS navigation, with single-pilot and optional dual-pilot, IFR capability. The Bell 429 has more cabin space than any other light twin helicopter, and features flat flooring and seating for seven passengers plus one flight crew. Wide, 62-inch (159 cm) side doors and optional rear clam-shell doors provide quick and easy access for any mission.

SAFETY

The Bell 429 provides increased safety by incorporating redundant systems in the avionics, hydraulics, and power plant systems. This helps the helicopter maintain excellent performance characteristics, OEI capability and tail rotor authority through all power demands. It is a stable platform, certified for Single Pilot IFR and Category "A" operations and is compliant to EU-OPS regulations. In addition, the Automatic Flight Control System decreases pilot workload when flying on instruments, allowing for increased situational awareness.

The Bell 429 is compliant and certified to the latest standards for crashworthiness (FAR 27 Amendment 44, dated 2008) and meets all applicable crash protection requirements specified in the ADF's Airworthiness Design Requirements Manual. In addition, the Bell 429 is configured with a BasiX-Pro™ Integrated Avionics and Flight Control System which has been specifically designed to meet the requirements of twin engine helicopters.



The Bell 429

MAINTENANCE STEERING GROUP-3 (MSG-3)

The Bell 429 is the first helicopter to use the same maintenance process, MSG-3, used by commercial airlines to ensure continuing airworthiness. The process is lead by a steering group composed of representatives from Bell, regulatory authorities and operators. This approach improves safety by addressing maintenance of significant items at a system level, by zones, instead of at the individual component level. The objective is to sustain the highest level of safety and reliability while improving cost and operational readiness.

Bell 429

COCKPIT INSTRUMENT DISPLAYS

Light Weight Display Units: The standard configuration provides primary flight display for the pilot with a center display for EICAS and Multi-Function use. A single display unit can provide a composite of both presentations if required or selected. An optional third display unit provides flight displays for a second pilot or can act as a Multi-Function Display for an observer. The 2nd generation Bell 429 display units are light-weight, NVG-compatible and LED back-lit. An NVG-compatible Flight Directory (CFHD) is also standard equipment on the Bell 429.

Garmin GTN-650/750: The Bell 429 includes the Garmin GTN 650/750 NAV/COM/WAAS GPS system as standard equipment. The Garmin GTN-750/650 system provides intuitive touchscreen controls, and the large, six-inch GTN-750 display provides unprecedented access to Navigation/Communication/GPS-WAAS functions, including:

- Graphical flight planning capability with touchscreen waypoint entry or sequence modification;
- High-resolution terrain mapping, including optional Internal TAWS-B terrain alerting;
- GARMIN transponder GTX 345R Non-Diversity Extended Squitter (ES) Mode S which provides ADS-B IN and OUT;
- Two VHF communication transceivers with 10 watt standard or 16 watt optional transmitting power, and 8.33 or 25 KHZ channel spacing;
- Flight Stream 510 Advanced Bluetooth Connectivity;
- Geo-referenced charting;
- GPS TSO'd to C146C, authorized to C146, authorized for Class 1, 2 and 3 Localizer Precision with Vertical Guidance (LPV) approaches;
- Multiple weather options where the supporting weather reporting/advisory infrastructure is available.



Bell 429 cockpit displays

INCREASED GROSS WEIGHT CAPACITY

Transport Canada approved operation of the Bell 429 at an internal gross weight of 7,500 lb (3,402 kg) in December 2011 after conducting an extensive technical evaluation. The increased gross weight of the Bell 429 will allow customers to take full advantage of the aircraft's capabilities, and operate with greater payloads.

To date, the Bell 429 increased gross weight has been approved by Argentina, Australia, Brazil, Canada, Chile, China, Ecuador, Georgia, Guernsey, India, Indonesia, Isle of Man, Israel, Japan, Malaysia, Mexico, New Zealand, Nigeria, Philippines, Qatar, Taiwan, Thailand, San Marino, South Africa, UAE, Venezuela and Vietnam. Bell is actively pursuing validation in additional countries.

- Operation at an internal gross weight of 7,500 lb (3,402 kg) requires installation of the following equipment:
 - Flashing Forward Light
 - Radar Altimeter
 - Helicopter Terrain Avoidance and Warning System (HTAWS)
 - Cockpit Voice Recorder/Flight Data Recorder

Bell 429

THE BELL 429WLG

The Bell 429WLG can land in a larger number of environments and conditions, providing operators of all mission profiles additional flexibility. Its taxiing capability is ideal for both repositioning in limited spaces and situations that require ground taxi, such as positioning closer to fixed-base operators. These benefits mean that both flight crews and passengers can save time and effort getting where they need to go. The Bell 429WLG also has reduced drag, due to the absence of skid landing gear, and an increased cruise speed.



Bell 429WLG

Bell 429 Specification Summary (U.S. Units)

WEIGHTS (lb)

Empty Weight (std. config. with 18.5" wide passenger seats) ^[1]	4,465 / 4,486 ^[3]	Max Gross Weight (internal)	7,000 / 7,500 ^[3]
Useful Load (internal, std. config.)	2,535 / 3,014 ^[3]	Max Gross Weight (external load)	8,000
Minimum Empty Weight (SPIFR) ^[2]	4,222 / 4,245 ^[3]	Cargo Hook Capacity	3,000
Max Useful Load (internal, SPIFR)	2,778 / 3,255 ^[3]		

PERFORMANCE SUMMARY (International Standard Day except as noted)

			Takeoff Gross Weight (lb)			
			6,250	6,500	7,000	7,500 ^[3]
IGE Hovering Ceiling	ISA	ft	17,440	16,300	14,130	12,070
	ISA + 20 °C	ft	14,280	13,100	10,840	8,690
OGE Hovering Ceiling	ISA	ft	14,700	13,540	11,290	9,150
	ISA + 20 °C	ft	11,500	10,290	7,970	5,660
Service Ceiling (MCP) - AEO (30 minute) - OEI	ISA	ft	20,000+	20,000+	18,710	16,690
	ISA	ft	13,050	11,870	9,630	5,010
(continuous) - OEI	ISA	ft	11,930	10,730	8,440	5,010
	SL, ISA	ktas	153	152	150	148
Maximum Cruise Speed (true airspeed)	SL, ISA + 20 °C	ktas	152	151	149	147
	4,000 ft, ISA	ktas	155+	155+	155+	151
	4,000 ft, ISA + 20 °C	ktas	150	149	145	140
Cruise at Long Range Cruise (LRC) Speed						
Range (standard fuel, no reserve)	SL, ISA	nmi	386	381	372	365
		ktas	129	129	130	130
LRC Speed (average true airspeed)	4000 ft, ISA	nmi	424	418	411	403
		ktas	123	130	129	130
Endurance at Loiter Speed (60 kias)	SL, ISA	hr	4.3	4.2	4.1	4.0
		4,000 ft, ISA	hr	4.7	4.6	4.5

ENGINE RATING (100% RPM)

			Uninstalled Thermodynamic Capability	Mechanical Limit
Pratt & Whitney Canada PW207D1/D2 with Full Authority Digital Electronic Control (FADEC)	Takeoff (5 minutes)	SHP	2 × 719	2 × 598
	Max Continuous Power	SHP	2 × 635	2 × 586
	OEI (30 seconds)	SHP	1 × 826	1 × 729
	OEI (2 minutes)	SHP	1 × 784	1 × 701
	OEI (30 minutes)	SHP	1 × 753	1 × 663
	OEI (continuous)	SHP	1 × 719	1 × 655

TRANSMISSION RATINGS (100% RPM at mast)

Takeoff (5 minute)	SHP	1,100
Max Continuous Power	SHP	1,100
OEI (30 seconds)	SHP	729
OEI (2 minutes)	SHP	701
OEI (30 minutes and continuous)	SHP	550

FUEL (usable)

Type	Aviation Turbine
Capacity, standard	216.9 US gallons
Capacity, auxiliary (optional)	39.2 US gallons

Notes: [1] Standard Configuration includes all items listed in the Standard Configuration Table of this document, equipment required for 7,500 lb increased internal gross weight operations, and 24 lb of engine oil. Ballast is not included in the standard configuration (ballast is a function of installed equipment). Also, see Note 1 on page 29.

[2] See Note 2 on page 29.

[3] Performance at Increased Gross Weight applicable where approved for use, requires additional equipment, see Note 3 on page 29.

Bell 429 Specification Summary (Metric Units)

WEIGHTS (kg)

Empty Weight (std. config. with 18.5" wide passenger seats) ^[1]	2,025 / 2,035 ^[3]	Max Gross Weight (internal)	3,175 / 3,402 ^[3]
Useful Load (internal, std. config.)	1,150 / 1,367 ^[3]	Max Gross Weight (external load)	3,629
Minimum Empty Weight (SPIFR) ^[2]	1,915 / 1,921 ^[3]	Cargo Hook Capacity	1,361
Max Useful Load (internal, SPIFR)	1,260 / 1,481 ^[3]		

PERFORMANCE SUMMARY (International Standard Day except as noted)

			Takeoff Gross Weight (kg)			
			2,835	2,948	3,175	3,401 ^[3]
IGE Hovering Ceiling	ISA	m	5,316	4,968	4,307	3,679
	ISA + 20 °C	m	4,353	3,993	3,304	2,649
OGE Hovering Ceiling	ISA	m	4,481	4,127	3,441	2,789
	ISA + 20 °C	m	3,505	3,136	2,429	1,725
Service Ceiling (MCP) - AEO (30 minute) - OEI (continuous) - OEI	ISA	m	6,096+	6,096+	5,703	5,087
	ISA	m	3,978	3,618	2,935	1,527
	ISA	m	3,636	3,271	2,573	1,527
Maximum Cruise Speed (true airspeed)	SL, ISA	km/hr	283	282	278	274
	SL, ISA + 20 °C	km/hr	281	279	275	272
	1,220 m, ISA	km/hr	287+	287+	287+	279
	1,220 m, ISA + 20 °C	km/hr	278	276	268	260
Cruise at Long Range Cruise (LRC) Speed						
Range (standard fuel, no reserve)	SL, ISA	km	715	706	688	676
LRC Speed (average true airspeed)		km/hr	238	239	241	241
Range (standard fuel, no reserve)	1,220 m, ISA	km	784	774	761	746
LRC Speed (average true airspeed)		km/hr	239	240	239	241
Endurance at Loiter Speed (111 km/hr) (standard fuel, no reserve)	SL, ISA	hr	4.3	4.2	4.1	4.0
	1,220 m, ISA	hr	4.7	4.6	4.5	4.4

ENGINE RATING (100% RPM)

			Uninstalled Thermodynamic Capability	Mechanical Limit
Pratt & Whitney Canada PW207D1/D2 with Full Authority Digital Electronic Control (FADEC)	Takeoff (5 minutes)	kW	2 × 536	2 × 446
	Max Continuous Power	kW	2 × 474	2 × 437
	OEI (30 seconds)	kW	1 × 616	1 × 544
	OEI (2 minutes)	kW	1 × 585	1 × 523
	OEI (30 minutes)	kW	1 × 562	1 × 494
	OEI (continuous)	kW	1 × 536	1 × 488

TRANSMISSION RATINGS (100% RPM at mast)

Takeoff (5 minute)	kW	820
Max Continuous Power	kW	820
OEI (30 seconds)	kW	544
OEI (2 minutes)	kW	523
OEI (30 minutes and continuous)	kW	410

FUEL (usable)

Type	Aviation Turbine
Capacity, standard	821 liters
Capacity, auxiliary (optional)	148 liters

Notes: [1] Standard Configuration includes all items listed in the Standard Configuration Table of this document, equipment required for 3,402 kg increased internal gross weight operations, and 11 kg of engine oil. Ballast is not included in the standard configuration (ballast is a function of installed equipment). Also, see Note 1 on page 29.

[2] See Note 2 on page 29.

[3] Performance at Increased Gross Weight applicable where approved for use, requires additional equipment, see Note 3 on page 29.

Bell 429 Helicopter Dimensions

EXTERNAL DIMENSIONS

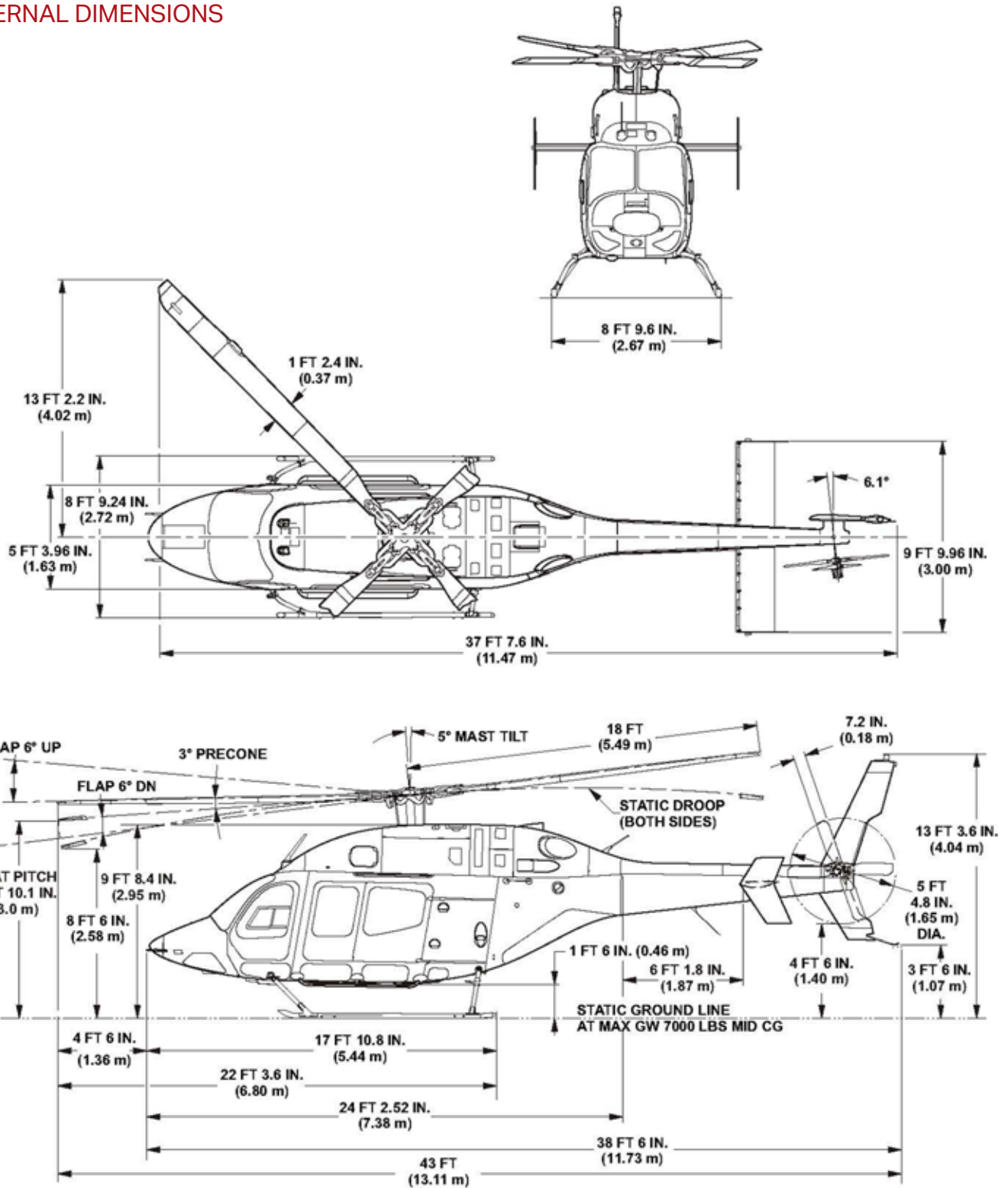

Bell 429 Helicopter Dimensions

Landing gear loading at Maximum Gross Weight (7,500 lb), based on 1G static conditions for both structural CG limits.

LANDING GEAR LOADING

CG Position		Loading		Contact Area		Contact Pressure	
		lb	kg	in ²	cm ²	lb/in ²	kg/cm ²
Forward	FWD	3,290	1,492.3	10.8	69.7	305	21.4
	AFT	4,210	1,909.6	19.8	127.7	213	15.0
Aft	FWD	2,950	1,338.1	10.8	69.7	273	19.2
	AFT	4,550	2,063.8	19.8	127.7	230	16.2

Bell 429WLG



With a range of 412 nautical miles (764 km) and speed of 154 knots (286 km/h) at 4,000 feet (1,220 m), standard day, the Bell 429WLG delivers exceptional performance with state-of-the-art single and dual pilot instrument flight rule capabilities. The additional flexibility of the retractable wheeled landing gear makes the Bell 429WLG ideal for both repositioning in limited spaces and situations that require ground taxi, such as positioning closer to fixed-base operators. A fully-integrated glass cockpit with two or three multi-function displays, dual digital autopilot and an integrated electronic data recorder help increase situation awareness and safety margins. The exceptionally spacious interior cabin offers seating for up to seven passengers plus a pilot and can be reconfigured for a number of missions.



Bell 429WLG Specification Summary (U.S. Units)

WEIGHTS (lb)

Empty Weight (std. config. with 18.5" wide passenger seats) ^[1]	4,730 / 4,751 ^[3]	Max Gross Weight (internal)	7,000 / 7,500 ^[3]
Useful Load (internal, std. config.)	2,270 / 2,749 ^[3]	Max Gross Weight (external load)	8,000
Minimum Empty Weight (SPIFR) ^[2]	4,487 / 4,510 ^[3]	Cargo Hook Capacity	3,000
Max Useful Load (internal, SPIFR)	2,513 / 2,990 ^[3]		

PERFORMANCE SUMMARY (International Standard Day except as noted)

			Takeoff Gross Weight (lb)			
			6,250	6,500	7,000	7,500 ^[3]
IGE Hovering Ceiling	ISA	ft	17,440	16,300	14,130	12,070
	ISA + 20 °C	ft	14,280	13,100	10,840	8,690
OGE Hovering Ceiling	ISA	ft	14,700	13,540	11,290	9,150
	ISA + 20 °C	ft	11,500	10,290	7,970	5,660
Service Ceiling (MCP) - AEO (30 minute) - OEI	ISA	ft	20,000+	20,000+	18,710	16,690
	ISA	ft	13,050	11,870	9,630	5,010
(continuous) - OEI	ISA	ft	11,930	10,730	8,440	5,010
	SL, ISA	ktas	155+	155+	154	152
Maximum Cruise Speed (true airspeed)	SL, ISA + 20 °C	ktas	155+	154	152	150
	4,000 ft, ISA	ktas	155+	155+	155+	154
4,000 ft, ISA + 20 °C	ktas	153	152	148	143	
	Cruise at Long Range Cruise (LRC) Speed					
Range (standard fuel, no reserve)	SL, ISA	nmi	--	390	381	374
		ktas	--	132	134	134
LRC Speed (average true airspeed)	4000 ft, ISA	nmi	--	428	421	412
		ktas	--	133	132	133
Endurance at Loiter Speed (60 kias)	SL, ISA	hr	--	4.2	4.1	4.0
		4,000 ft, ISA	hr	--	4.6	4.5

ENGINE RATING (100% RPM)

			Uninstalled Thermodynamic Capability	Mechanical Limit
Pratt & Whitney Canada PW207D1/D2 with Full Authority Digital Electronic Control (FADEC)	Takeoff (5 minutes)	SHP	2 × 719	2 × 598
	Max Continuous Power	SHP	2 × 635	2 × 586
	OEI (30 seconds)	SHP	1 × 826	1 × 729
	OEI (2 minutes)	SHP	1 × 784	1 × 701
	OEI (30 minutes)	SHP	1 × 753	1 × 663
	OEI (continuous)	SHP	1 × 719	1 × 655

TRANSMISSION RATINGS (100% RPM at mast)

Takeoff (5 minute)	SHP	1,100
Max Continuous Power	SHP	1,100
OEI (30 seconds)	SHP	729
OEI (2 minutes)	SHP	701
OEI (30 minutes and continuous)	SHP	550

FUEL (usable)

Type	Aviation Turbine
Capacity, standard	216.9 US gallons
Capacity, auxiliary (optional)	39.2 US gallons

Notes: [1] Standard Configuration includes all items listed in the Bell 429WLG Standard Configuration Table of this document, equipment required for 7,500 lb increased internal gross weight operations, and 24 pounds of engine oil. Ballast is not included in the standard configuration (ballast is a function of installed equipment). Also, see Note 1 on page 29.

[2] See Note 2 on page 29.

[3] Performance at Increased Gross Weight applicable where approved for use, requires additional equipment, see Note 3 on page 29.

Bell 429WLG Specification Summary (Metric Units)

WEIGHTS (kg)

Empty Weight (std. config. with 18.5" wide passenger seats) ^[1]	2,146 / 2,155 ^[3]	Max Gross Weight (internal)	3,175 / 3,402 ^[3]
Useful Load (internal, std. config.)	1,029 / 1,247 ^[3]	Max Gross Weight (external load)	3,629
Minimum Empty Weight (SPIFR) ^[2]	2,035 / 2,046 ^[3]	Cargo Hook Capacity	1,361
Max Useful Load (internal, SPIFR)	1,140 / 1,356 ^[3]		

PERFORMANCE SUMMARY (International Standard Day except as noted)

			Takeoff Gross Weight (kg)			
			2,835	2,948	3,175	3,401 ^[3]
IGE Hovering Ceiling	ISA	m	5,316	4,968	4,307	3,679
	ISA + 20 °C	m	4,353	3,993	3,304	2,649
OGE Hovering Ceiling	ISA	m	4,481	4,127	3,441	2,789
	ISA + 20 °C	m	3,505	3,136	2,429	1,725
Service Ceiling (MCP) - AEO (30 minute) - OEI (continuous) - OEI	ISA	m	6,096+	6,096+	5,703	5,087
	ISA	m	3,978	3,618	2,935	1,527
	ISA	m	3,636	3,271	2,573	1,527
Maximum Cruise Speed (true airspeed)	SL, ISA	km/hr	287+	287+	284	281
	SL, ISA + 20 °C	km/hr	287+	285	282	278
	1,220 m, ISA	km/hr	287+	287+	287+	284
	1,220 m, ISA + 20 °C	km/hr	286	282	273	265
Cruise at Long Range Cruise (LRC) Speed						
Range (standard fuel, no reserve)	SL, ISA	km	--	723	705	692
LRC Speed (average true airspeed)		km/hr	--	245	248	247
Range (standard fuel, no reserve)	1,220 m, ISA	km	--	793	779	764
LRC Speed (average true airspeed)		km/hr	--	247	244	247
Endurance at Loiter Speed (111 km/hr) (standard fuel, no reserve)	SL, ISA	hr	--	4.2	4.1	4.0
	1,220 m, ISA	hr	--	4.6	4.5	4.4

ENGINE RATING (100% RPM)

			Uninstalled Thermodynamic Capability	Mechanical Limit
Pratt & Whitney Canada PW207D1/D2 with Full Authority Digital Electronic Control (FADEC)	Takeoff (5 minutes)	kW	2 × 536	2 × 446
	Max Continuous Power	kW	2 × 474	2 × 437
	OEI (30 seconds)	kW	1 × 616	1 × 544
	OEI (2 minutes)	kW	1 × 585	1 × 523
	OEI (30 minutes)	kW	1 × 562	1 × 494
	OEI (continuous)	kW	1 × 536	1 × 488

TRANSMISSION RATINGS (100% RPM at mast)

Takeoff (5 minute)	kW	820
Max Continuous Power	kW	820
OEI (30 seconds)	kW	544
OEI (2 minutes)	kW	523
OEI (30 minutes and continuous)	kW	410

FUEL (usable)

Type	Aviation Turbine
Capacity, standard	821 liters
Capacity, auxiliary (optional)	148 liters

Notes: [1] Standard Configuration includes all items listed in the Bell 429WLG Standard Configuration Table of this document, equipment required for 3,402 kg increased internal gross weight operations, and 11 kilograms of engine oil. Ballast is not included in the standard configuration (ballast is a function of installed equipment). Also, see Note 1 on page 29.

[2] See Note 2 on page 29.

[3] Performance at Increased Gross Weight applicable where approved for use, requires additional equipment, see Note 3 on page 29.

Bell 429WLG Helicopter Dimensions

EXTERNAL DIMENSIONS

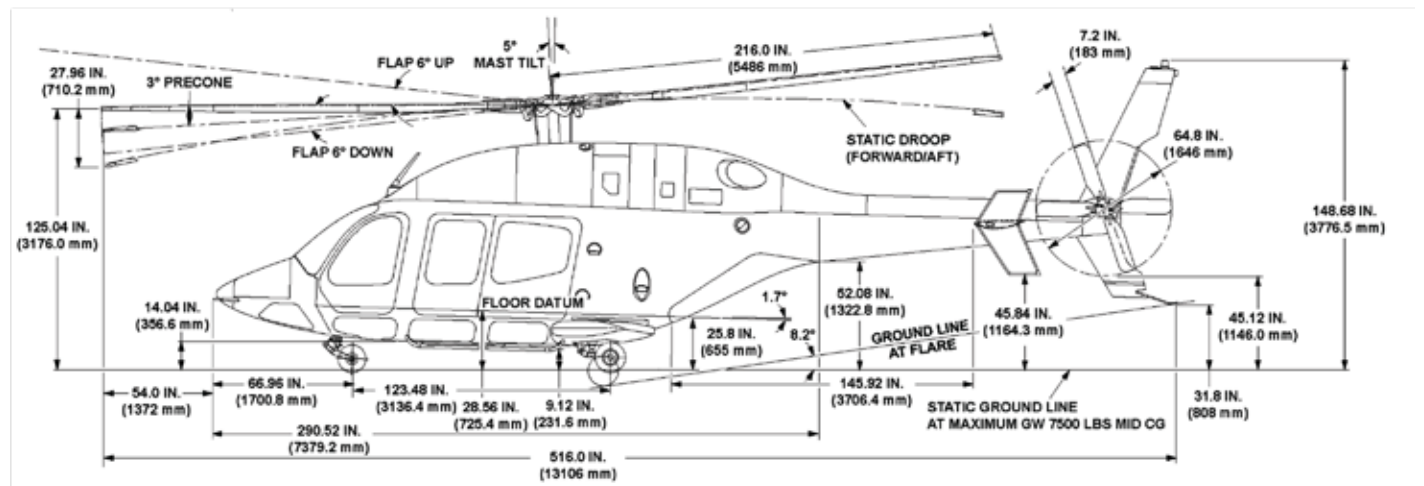
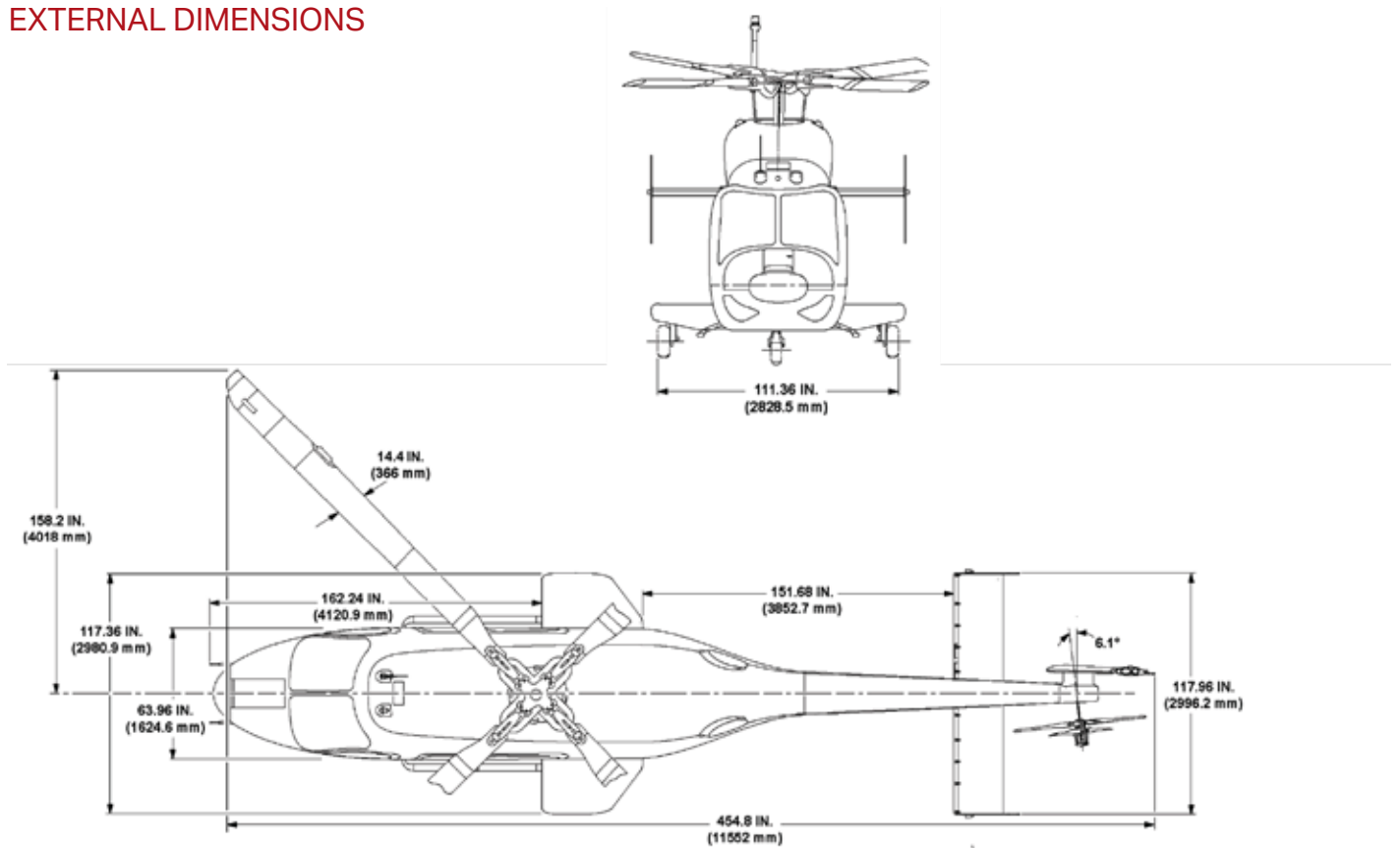

Bell BasiX-Pro™ Integrated Avionics System

The Bell BasiX-Pro™ Avionics System has been specifically designed to meet the requirements of twin engine helicopters and is optimized for IFR, Category A, and EU-OPS compliant operations. The system is highly flexible and configurable to meet various operating and customization needs. The system takes advantage of the latest in display, computer processing, and digital data bus technology to provide a high degree of redundancy, reliability, and flexibility.

STANDARD CONFIGURATION, SINGLE PILOT IFR (SPIFR)



Bell BasiX-Pro™ Single Pilot IRF (SPIFR)

The primary components of the Bell BasiX-Pro™ Avionics System in the Bell 429, include:

Two Multi-Function Display Units (DUs) with 6 × 8 inch high-resolution displays.	Dual Channel Aircraft Data Interface Unit (ADIU)	Dual Flight Director Mode Select Panels for the Automatic Flight Control System (AFCS)	Dual Channel Air Data Attitude Heading Resource System (ADAHRS)	Course/Heading/Flight Director Panel (CHFD)
--	--	--	---	---

Bell BasiX-Pro™ Integrated Avionics System

The standard configuration for the Bell 429 provides single-pilot IFR capability with 3-axis stability and control augmentation (SCAS) and a coupled flight director capability. All Engine Indication and Crew Alerting System (EICAS) display functions are provided through the Bell BasiX-Pro™ Avionics System. The system works in conjunction with the engine control units (EECs) for the dual Pratt & Whitney electronically-controlled PW-207D1/D2 engines. Other aircraft systems interfaces, warnings, cautions, aural alerts, and automated performance features are provided through the remotely located Aircraft Data Interface Unit (ADIU).

Power and performance situational awareness is enhanced through Bell's patented "PSI" presentation. The PSI (Power Situation Indicator) provides a single gauge to monitor use of engine power relative to multiple limits simultaneously, and assures maximum power usage and workload reduction in OEI as operation transitions to flying RPM indication against the engine limiters. Systems monitoring workload is reduced through EICAS design for rapid scanning. Display-by-exception, normalized scales, subdued red and yellow markings except in appropriate conditions: These all contribute to reduced pilot instrument scan times through an effective EICAS design made specifically for the demands of helicopter use.

Communications and Navigation: The Bell 429 standard configuration for Communications, Navigation and Surveillance (CNS) consists of the Garmin GTN-750/650 NAV/COM/WAAS GPS system. The standard system also includes a GTX-345R ES compliant Mode S transponder with extended squitter, providing ADS-B "out" reporting and ADS-B "in" for increased safety and situational awareness, a PMA-7000H Audio/Intercom Panel with VOX and Integral Marker Beacon Receiver, and an ARTEX C406-N-HM Emergency Locator Transmitter (ELT).

Display Units: The BasiX-Pro™ 2nd generation system incorporates Multi-Function "smart" displays units from Astronautics Corporation of America (ACA) which are NVG-ready[1] and provide vivid outlined fonts and graphics with improved color and contrast, increased resolution radar and HTAWS which can underlay Full Compass as well as Arc HSI presentations, plus expanded video and maintenance features. The ACA display units include the processing required to collect sub-system information and generate display formats and graphics for the following:

- All primary flight and navigation instrumentation
- Presentation of flight director and autopilot status
- Engine and rotor drive system indications
- Electrical, hydraulic, and fuel system monitoring
- Crew alerting system (warnings / cautions / advisories and aural alerts)
- Navigation route mapping display
- CAT I IFR, LPV approach, and Advisory vertical approach capability
- Presentation of ADS-B Traffic (using TCAS Symbology)
- Presentation of optional Traffic Collision Avoidance Symbology (TCAS)
- Presentation of optional weather radar information (multiple options), and/or HTAWS information

[1] BasiX-Pro™ Display Units LCD displays are RTCA DO-275 compatible for night vision goggle use when selected to NVG backlight mode. NVG completion installs the overhead control switch required to enable NVG mode. Display Unit key legend and control lighting is NVG compatible as a standard feature. Full NVG compatibility requires all other light sources, including customization, be tested and modified if required.

Bell BasiX-Pro™ Integrated Avionics System

- Presentation of optional FLIR video with symbology
- Presentation of up to 2 additional video source selectable via DU
- Video/FLIR displayed in partial or full-screen with pan provided for oversized video
- High Definition Video/FLIR inputs in either DVI or HD-SDI format supporting multiple aspects and DU correction for image rotation or flip.
- Analog Video/FLIR inputs in either Composite or Y/Pr/Pb Component format, NTSC or PAL with DU correction for image rotation or flip
- Presentation of electrical schematic, fuel schematic, and weight and balance summary information
- Presentation of automated power assurance, Category A performance, and hover performance calculations
- Presentation of maintenance and diagnostic data
- Embedded Data Recorder with up to 70 hours of prior flight data with rapid download capability



Radar display



FLIR or IR Camera

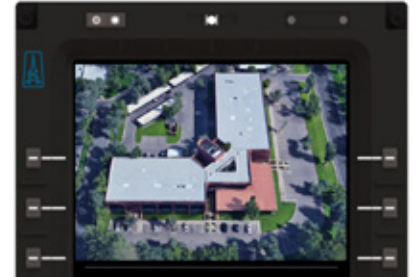

HD Video Display

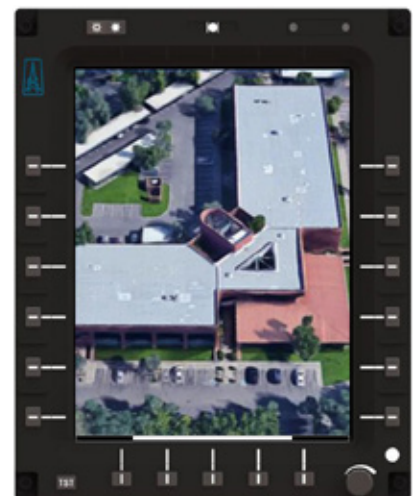

Full Screen Video Display
with pan position indicated

CONFIGURATION FLEXIBILITY TO MEET OPERATIONAL NEEDS

Basix-Pro™ includes built-in provisions to allow customized configuration of the following equipment:

- Alternate FMS / GPS systems
- Alternate ARINC-429 radio nav aids
- 2nd Radar Altimeter
- UHF / VHF Direction Finder or second ADF
- Weather Search Radar
- Video inputs for Multi-sensor camera / EVS display / General color video display / digital map display
- Designator Control Panel (allows FLIR or radar cursor designated positions to be captured as waypoints)
- Velocity Sensor (for hover cues and / or search and rescue approach options)
- L3 TACAN+ providing both TACAN navigation and replacing the KDM-706A DME
- Programmable CAS messages (cautions / warnings / advisories)



Bell Basix-Pro™ Dual Pilot IRF (DPIFR)

AUTOMATIC FLIGHT CONTROL SYSTEM

The Bell 429 utilizes a Bell-designed Automatic Flight Control System (AFCS) featuring redundant digital flight control computers (FCCS) and providing 3-axis or 4-axis capability with dual flight directors. The Bell 429 readily allows upgrade to 4-axis which adds a collective trim actuator and enables simultaneous vertical and speed coupling. The 4-axis AFCS is approved for fully-coupled steep (up to 9 degree) Localizer Precision with Vertical (LPV) approaches.

The 2nd generation BasiX-Pro design features a Course /Heading /Flight Director Panel (CHFD) with LED indicators to confirm selection at the panel as well as on the primary flight displays.

As an additional safety feature, the 2nd generation design also includes 1-button instant couple features that quickly restore coupled flight in the event of pending disorientation:

Pressing the collective-mounted GA (go around) will re-engage force trim and attitude hold if necessary and will set the aircraft to climb in a level roll attitude.

Pressing the CHFD “CPL” button when uncoupled will re-engage force trim and attitude hold if necessary and will stabilize flight by coupling the flight director to hold current heading, vertical speed, and if 4-axis, airspeed as well. From there, the pilot can adjust references and change modes as required.

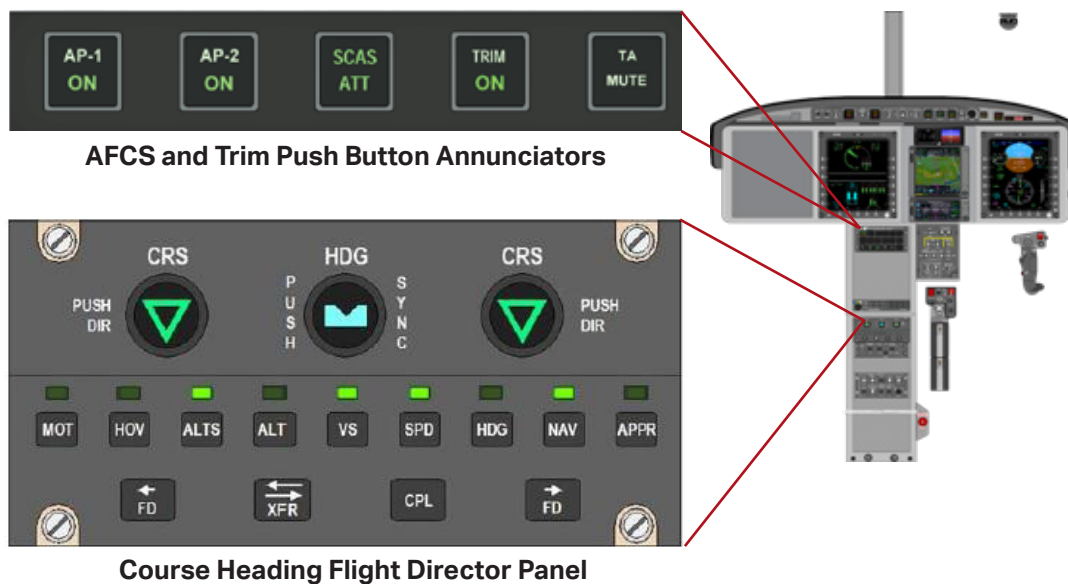

Safety Enhancements

Bell is at the forefront in providing multiple ways of satisfying evolving requirements in helicopter traffic management, flight following and terrain awareness safety. The Bell 429 is the first helicopter in the light twin category to provide fully-coupled steep (9-degree) LPV WAAS (Localizer Precision with Vertical guidance Wide Area Augmentation System) approaches. The Bell BasiX-Pro™ Integrated Avionics System concentrates on providing true operational capabilities and flexibility to our customers to address rapidly changing regulatory requirements and technologies, with an open architecture and flexible avionics systems solutions. The enhancements available for the Bell 429 through optional accessory kits and customizing include the Traffic Advisory System and Helicopter Terrain Awareness and Warning Systems / Enhanced Ground Proximity Warning System.

Traffic Advisory System (TAS):

- **Avidyne TAS605A** features:
 - 13 nm range
 - 5,500 ft vertical separation
 - 55,000 ft service ceiling

Helicopter Terrain Awareness and Warning System / Enhanced Ground Proximity Warning System: Three H-TAWS and EGPWS H-TAWS options are available to satisfy the 7,500 lb Increased Internal Gross Weight equipment requirement.

- **Garmin GTN-750 with H-TAWS:** TSO-C194 H-TAWS system, available as a Bell optional accessory kit for the GTN-750 NAV/COM/GPS:
 - Light weight, lowest cost solution
 - Displays on GTN-750 only
- **Honeywell Mark XXI EGPWS H-TAWS:** System available as customizing. TSO-C194 compliant
 - Installation with or without weather radar
 - Displays on BasiX-Pro™ Display Units
 - Underlaid on PFD HSI format or MFD Map / Radar format
 - Uses same input as weather radar
 - Provides only one TAWS image (one range setting only)
- **Honeywell Mark XXII EGPWS H-TAWS:** System available as customizing, TSO-C194 compliant adds the following features:
 - Provides dual H-TAWS images with independent range selection for pilot / copilot
 - Interfaces with ADC and Rad Alt
 - Provides additional alerting modes control



Garmin GTN-750 with H-TAWS

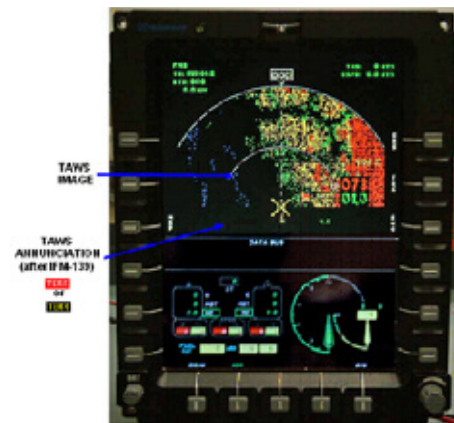

TAWS displayed on MFD Map/Radar page



TAWS displayed as HSI underlay on PFD

Bell 429 Maintenance Program

DESIGNED THROUGH MAINTENANCE STEERING GROUP - 3 (MSG-3)

Bell understands the importance of aircraft reliability to meet your mission needs. That's why our maintenance philosophy is to streamline maintenance requirements to ensure low direct operating costs, low direct maintenance costs, and improved reliability by utilizing the Maintenance Steering Group – 3 (MSG-3) while increasing occupant safety.

The Bell 429 is the first rotorcraft designed through the MSG-3 in the creation of a maintenance schedule on a commercial helicopter with the support of the Aviation authorities, mainly Transport Canada (TC), the Federal Aviation Administration (FAA) and the European Aviation Safety Agency (EASA).

During the Customer Maintenance Advisory Panel (CMAP) meetings, the team analyzed every aircraft system, including airframe structure and wiring installation, to determine the failure modes, their criticality, the ease of detection, the level of inspection required and the ideal recurrence of inspection. This is where the varied experience of the team came in to play; Aircraft Maintenance Engineers (AME) / Airframe and Power Plant (A&P) technicians also provided input as to the system detailed functions and used their many years of experience in aircraft operation, respectively. From this resulted a maintenance schedule that requires 35% less maintenance man hours versus a comparable aircraft, thus improving the cost of ownership for the Bell 429.

The following are excellent features derived through MSG-3 for the Bell 429.

- **Approved Maintenance Program (TC)**
 - First rotorcraft to use the MSG-3 Process
- **Certification through MSG-3 Process**
 - Same process used by commercial airlines to ensure continued airworthiness
 - Determines how and when maintenance will be performed
 - Helicopter designed and built for maintenance
- **Accessible panels to aircraft systems**
- **Maintenance Program**
 - Task Intervals
 - * Every 200 hours
 - * 800 hours/12 month
 - * Zonal Inspection Program introduced
 - Life Limited Parts
 - * Composite Components – On Condition
 - * Metallic Components – 10,000 + hours (Goal)
 - * Elastomeric Components – 5,000 hours

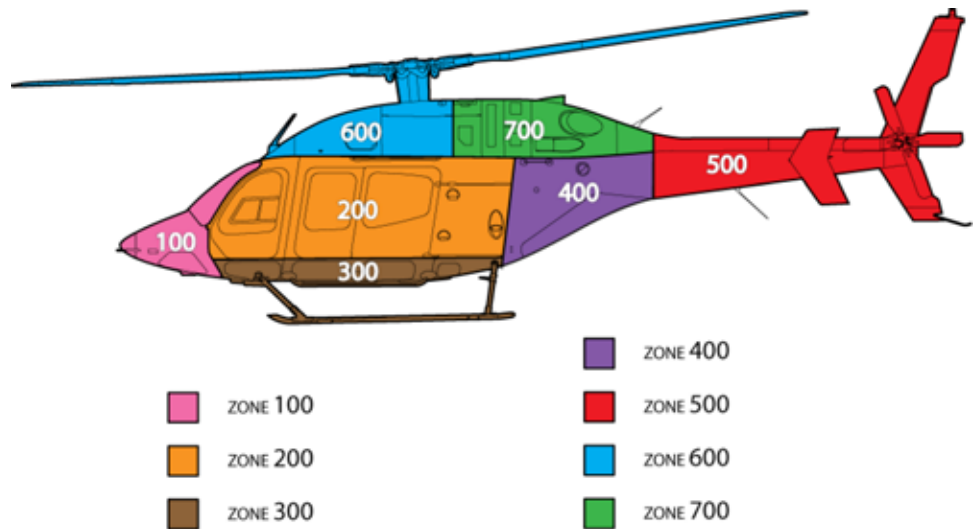

LE BELL 429 EST SEULEMENT DISPONIBLE AVEC TRAIN D'ATTERRISSAGE À ROUES EN FRANCE.

Bell 429 Maintenance Program

- **Zonal Inspections**
 - General Visual Inspections
 - Part of Scheduled Inspection Program
 - Start at 12-month
 - Extent out to 10-years
 - Reduce Scheduled Inspection repeats
- **Instructions for Continued Airworthiness (ICA)**
 - Maintenance Manual and Flight Manual
 - Maintenance Manual accepted by TC
 - Maintenance Program approved by TC
 - Flight Manual approved by TC
- **Scheduled Maintenance and Component Inspections**

BELL 429 SCHEDULED MAINTENANCE INSPECTIONS

Inspection	Individual Task Hours	Cumulative Task Hours	Notes
100-hour / 12-month	0.06	0.06	
200-hour / 12-month	1.47	1.53	100-hour inspection must be carried out
600-hour / 12-month	7.16	8.69	100 and a 200-hour inspection must be carried out
800-hour / 12-month	4	5.53	100 and 200-hour inspection must be carried out
800-hour / 24-month	0.13		
1,600-hour / 2-year	1	2.038	For Bell 429 WLG only
200-hour	2		
400-hour	4.99		
800-hour	19.752		
5,000-hour	24.03		
6,000-hour	0.64		
8,000-hour	4		
10,000-hour	4		
15,000-hour / 15-year	16		100-hour / 12-month, 200-hour/12-month, 600-hour/12-month, 5,000-hour, 12-month, 3-year, 5-year inspections must be carried out
5,000 RIN	1		
1-month	0.5		
12-month	2.56		
24-month	14.1		
3-year	0.93		
4-year	6.23		2-year inspection must be carried out
5-year	4.23		
6-year	24.74		2-year and 3-year inspections must be carried out
4-year	0.81		For Bell 429 WLG only
6-year	0.3		For Bell 429 WLG only
8-year	4.24		2-year and 4-year inspections must be carried out
10-year	8.86		2-year and 5-year inspections must be carried out
12-year	0.5		

Bell 429 Maintenance Program

BELL 429 SCHEDULED COMPONENT OVERHAULS

Component	Assigned Interval	Remarks	Total Task Duration (Hours)
Main Rotor Hub	5,000 hr		92
Swashplate and Support Assembly	5,000 hr		33
Main Rotor Gearbox (MRGB)	5,000 hr		160
Main Rotor Mast Assembly	5,000 hr		14
Tail Rotor Yoke Assembly	5,000 hr		21
Tail Rotor Gearbox (TRGB)	5,000 hr		33
		Total	353

Seating and Interiors

CREW SEATING

Two individual ergonomically designed energy attenuating seats with adjustable lumbar support, each equipped with seat adjustment controls forward and aft, up and down, adjustable lumbar support, a four-point restraint system, and adjustable pedals. The color and upholstery material for the seats match the color scheme selected for the cabin.

The cockpit crew station was designed from the outset to accommodate pilots from the 5th percentile female to the 95th percentile male (standing height 5 ft. ½ inch to 6 ft. 2 inches; sitting height 31.3 inches to 38.3 inches, reference U.S. FAA Human Factors Design Standard, HF-STD-001, dated May 2003). The pilot and copilot seats and pedals are also adjustable to enable the cockpit crew to adjust their seat positions for comfortable access to cockpit controls, so that they can easily carry out normal and emergency duties without hindrance:

- Forward and aft 6" (15 cm)
- Up and down 4.5" (11.4 cm)
- Adjustable pedals

The cockpit ceiling provides ample clearance for the 95th percentile male wearing a flight helmet in either the pilot or copilot seat.

PASSENGER / CARGO COMPARTMENT

The passenger/cargo compartment occupies the middle section of the cabin. The compartment has a volume of 130 ft³ (3.68 m³) which can be used in a standard or corporate configuration for passenger seating, or as cargo area. The aft cabin has an additional volume of 74 ft³ (2.10 m³), giving a total contiguous cabin volume of 204 ft³. (5.78 m³). The cabin dimensions are 60 inches (1.52 m) wide (W) by 49 inches (1.24 m) tall (H) by 79 inches (2 m) long (L). The baggage compartment dimensions are 47.6 inches (1.21 m) wide (W) by 46 inches (1.17 m) tall (H) by 48.9 in (1.24 m) long (L).

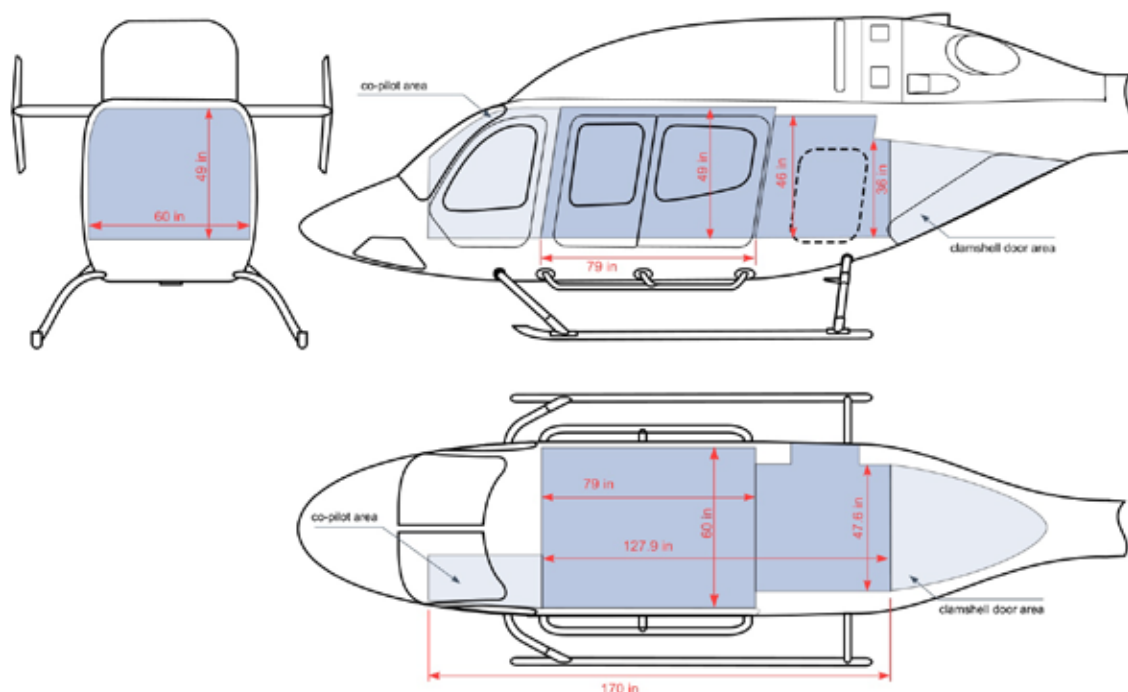

Bell 429 Cabin Dimensions

Seating and Interiors

A forward hinged and aft sliding door on each side of the cabin provide a 61.9 inches wide by 44.25 inches high (158.7 by 112.3 cm) unobstructed door opening on each side of the helicopter for easy passenger compartment loading and unloading. The two forward doors are hinged to open forward and the two sliding doors open aft and flush along the cabin exterior. The passenger/cargo compartment doors can be opened individually or at the same time.

STANDARD SEATING AND TRIM

Standard Configuration six-place seating consists of two rows of three energy-absorbing seats, with individual 4-point restraint system, quick release disconnects and fixed provisions for the optional passenger cabin ICS system. Four standard seating configurations are available: 6-place seating with either 15.5" or 18.5" wide seats, which can be quickly arranged into an airline configuration with both rows facing forward, or a club seating configuration with the two rows facing each other.

Each individual passenger seat assembly is installed on two transverse seat rail tracks that are attached to the cabin floor. The quick release disconnects enable the seats to be quickly arranged, or to remove individual seats to meet special mission configuration requirements. The seats are upholstered in fabric or optional vinyl.

Standard interior trim consists of full thermoplastic closeouts on all airframe areas, a molded thermoplastic headliner with two fixed slotted air vents, and a choice of either durable low loop nylon blend carpeting or optional "Aermat" vinyl floor covering.



Six place club seating with 18.5" seats and one center seat fold down table.



Standard six place 15.5" wide passenger seats in forward facing airline seating arrangement.



Standard six place 18.5" wide passenger seats in club seating arrangement.



Standard headliner with slotted air vents.



Optional headliner with LED lights and adjustable air vents.

Seating and Interiors

Additional Interior Options: The following additional optional accessory kits are also available for selection on aircraft equipped with standard interior and seating. See Optional Accessory Kits, page 18 for additional information on part numbers, availability and weights.

- Aft Cabin ICS – 6 Place (Headsets not included)
- Headliner with LED lights and adjustable Air Vents (recommended when optional air conditioning equipment is selected)
- Soundproofing
- Aft Bulkhead Closeout Panel, available with or without soundproofing.

CORPORATE SEATING AND INTERIOR TRIM

Three corporate seating options are available. All include plush seats, upholstered in premium leather, with individual 3- or 4-point restraint system, quick release disconnects and fixed provisions for a passenger cabin ICS system. For the five-place club seating option, the quick release disconnects enable the seats to be quickly arranged with the two 21.5-inch seats facing either forward or aft.

The interior features thermoplastic panels on all airframe areas, high--tech vinyl cockpit flooring, high-quality color-coordinated cabin carpet, corporate headliner with plated LED lights and adjustable air vents, plated door handles and color-coordinated leather accents.

Additional Interior Options: The following additional optional accessory kits are also available for selection on aircraft equipped with an corporate interior and seating.

- Aft Cabin ICS – Six Place (Headsets not included)
- Soundproofing
- Aft Bulkhead Closeout Panel, available with or without soundproofing
- 18.5" corporate seats with fold-down center tables as a customizing option

Note: Corporate passenger seats, interior trim and plush wool carpeting, corporate head liner, aft bulkhead closeout panel, and soundproofing are optional accessory kits, not included in Standard Configuration weight and price. See Optional Accessory Kits, page 29, for additional information.

The Bell 429 external noise levels are; Takeoff 88.9, Flyover 89.6 and Approach 91.4. All figures are in EPNL(EPNdB) at 7,000 lb per ICAO Annex 16.



Six place club seating with 18.5" wide seats.



Five place club seating with a row of two 21.5" seats separated by a center console facing a row of three 18.5" seats.



Four place club seating with two 21.5" seats separated by a center console in each row.

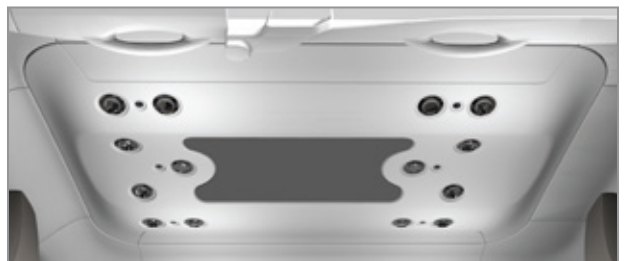

A molded thermoplastic corporate headliner with LED lights, adjustable air vents and color coordinated leather trim.

Mission Profiles

CORPORATE

An extremely smooth and quiet ride is just one of the things you will notice in the Bell 429. The large cabin is easily customized for luxurious amenities and the spacious seats provide ample legroom and comfort that makes any trip enjoyable. The large baggage area can easily accommodate both luggage and golf clubs. Whether maximizing your travel time working through papers or just taking a few minutes to relax and regroup, the Bell 429 provides the right corporate mission environment.



Corporate



Four Passenger Club Seating Configuration



Five Passenger Club Seating Configuration



Six Passenger Club Seating Configuration

Mission Profiles

MEDICAL

With configurations as unique as the patients you serve, the Bell 429 is an aircraft designed with the air ambulance market in mind. The deck height matches litter height and allows one-man litter loading with less lifting or back strain through either side or optional aft clamshell doors. The largest cabin in its class and structural flat floor affords tremendous mission-to-mission flexibility. Once configured, the large cabin allows full body access, optimizing patient care.



Medical



Medical



Single Litter Configuration



Dual Litter Configuration

Mission Profiles

ENERGY

Traveling to offshore oil platforms and wind farms can be tedious and treacherous, so safety and comfort were at the forefront of the Bell 429 design. The floatation system has been designed from the outset to meet the requirements for ditching certification for those operators who require it. Less obvious is the technology and MSG3 maintenance philosophy incorporated into protecting the Bell 429's airframe and components from the ravages of sea spray and salty air.



Energy



Energy



Six Passenger Club Seating Configuration

Mission Profiles

PUBLIC SAFETY

Fast, agile, smooth and quiet, the Bell 429 reduces response time and crew fatigue while expanding an agency's mission capabilities. Exceptional cabin volume, large cabin doors and optional rear clamshell doors easily accommodate special mission equipment, tactical deployments or hoist operations. Even the tallest crew member wearing an NVG-equipped helmet is comfortable flying the Bell 429 thanks to best-in-class volume and fully adjustable seats and pedals. Coupled with a fully integrated glass cockpit, with options that include moving maps, multi-sensor camera imagery, searchlight, loud hailer and NVG capability, the Bell 429 delivers the complete multi-role public safety package.



Public Safety



Public Safety



Public Safety

External Paint Schemes



Bell 429 Paint Schemes

For more color options, please visit bellflight.com or speak with a Sales Representative.

- Notes:
1. Color renderings (original) must be provided for any deviation to the standard schemes (all models).
 2. Custom paint schemes to customer specification are available, and a price quote will be provided on request. Please provide as much detail as possible when describing special instructions and custom paint schemes.
 3. The danger arrow is always applied on the tail boom between the horizontal stabilizer and the tail rotor, not withstanding any other illustrations.
 4. Unless clearly specified (location, dimension, color), registration markings will be applied per FAA regulations (all models).
 5. Metallic paint can not be applied over RADOME areas when a radar is installed.
 6. Placement of Bell model logos is effected by individual paint schemes, and will be applied at the discretion of Bell unless otherwise specified by the customer.

Bell 429 and 429WLG Common Production Configuration

The Bell 429 and 429WLG share many similarities. This commonality helps reduce costs for customers operating mixed fleets of skid gear and wheel gear Bell 429 aircraft. Pages 26 through 28 list the features and components found on any production Bell 429 rolling off the assembly line.

Unique components or features included on a production Bell 429 are listed on page 29. Similar information for the Bell 429WLG, with optional increased gross weight, is included following the standard production information.

AIRFRAME

Fuselage: Machined alloy airframe with single piece machined roof beams, lift frames, cabin keel beams and nose beams; carbon fiber composite side-bodies, belly panels, nose skins, floor panels, decks and engine cowls

Corrosion resistant design with wet installed fasteners and sealed surfaces where dissimilar materials are found, to provide exceptional resistance to adverse environmental conditions

Doors (six, carbon fiber): Hinged pilot and copilot doors with sliding windows; hinged forward and sliding aft passenger doors on both sides

Passenger doors provide 61.9 inches unobstructed opening on each side of the cabin

Door Locks for cockpit, cabin and luggage compartment, with common keying

Luggage compartment: Aft cabin (74 cubic feet), with 16 discrete tie-down hardpoints and R/H side external luggage door

Tailboom: Carbon fiber tailboom, vertical fin and horizontal stabilizer

Fuselage mounted passenger cabin steps, forward mounted crew steps, and aft maintenance step

Provisions for mooring, jacking and single point lifting

Windows: Gray tinted acrylic windows and windshields

Wire Strike Protection System Fixed Provisions, Cabin and Nose Provisions (Bristol/AA)

Air Conditioning Drive Quill (required for installation of any air conditioning system)

Air Conditioning Fixed Provisions

Three color exterior paint schemes, sample illustrations available upon request

COMMUNICATIONS AND NAVIGATION

Nav/Comm/GPS: VOR/ILS/GS/COMM/GPS and WAAS (Wide Area Augmentation System), with GTN-750/GTN-650

GARMIN transponder GTX 345R Non-Diversity Extended Squitter (ES) Mode S which provides ADS-B IN and OUT compliant for both 978 Mhz and 1090 Mhz providing TIS-B, FIS-B and METAR reports
Garmin Flight Stream 510 for Bluetooth Connectivity

Dual Keyed and/or VOX Intercom System

PMA-7000H Audio Panel with Integral Marker Beacon Receiver

ELT (ARTEX C406-N-HM)

ELECTRICAL

28 volt DC system, dual generator configuration

25 AmpH Valve Regulated Lead-Acid (VRLA) battery

Two 150 Amp Starter Generators, with two generator-regulator control units

External power source connection

LED Cockpit instrument, annunciator, utility and map lighting with programmable lighting power supply to ensure light balancing across all cockpit display and control panels

All LED basic external lighting system:

- One forward and two sideward facing fixed LED array landing lights
- Three high intensity LED position lights
- One flashing LED anticollision light

Digital maintenance interface available from cockpit for all digital aircraft systems

Baggage compartment lighting

Electrical Provisions Kit (Required for Cat. A Operations)

Bell 429 and 429WLG Common Production Configuration

FLIGHT and ENGINE INSTRUMENTS

EFIS/EICAS (Electronic Flight Instruments System/ Engine Indicating and Crew Alerting System)

Two 6" x 8" color NVG-compatible, LED back-lit LCD displays units (DU) with interface provisions for future kits and customized equipment installations, each with video display capability

Aircraft Data Interface Unit, Dual Channel

Course/Heading/Flight Director Panel

Electronic Data Recorder embedded in each DU

(non-crashworthy) Satisfies 14CFR135.607

AD/AHRS (Air Data/Attitude Heading Reference System), Dual Channel (Honeywell KSG7200)

AFCS (3-axis), Dual digital autopilot. Dual SCAS actuator & trim actuator with force trim per axis

Digital Standby Instruments:

Attitude

Altitude

Heading

Airspeed

Dual Pitot / Static system with monitored electric heat

INTERIOR

Open cabin design with flat floor, total contiguous cabin volume 232 cu. ft. (passenger and aft cabin/ area volume 204 cu. ft.)

Standard cockpit seating (2 seats), adjustable forward and aft, up and down, with lumbar support and adjustable pedals

Passenger Seat Rails

Standard 6-place passenger seating with 4-point restraint system, individual seat quick release disconnects and ICS fixed provisions (choice of 15.5" wide or 18.5" wide Seats)

Ram air cockpit and cabin ventilation system, with cockpit Windshield defogging vent blowers

Standard Interior: Thermoplastic panels covering all doors and interior trim areas, and choice of durable low loop nylon carpet or "Aermat" vinyl floor covering

Standard Headliner, Passenger Cabin, with two fixed slotted side air vents

LOOSE EQUIPMENT (not included in empty weight)

Keys for crew, passenger and baggage doors

Manuals:

Flight manual

Aircraft maintenance manual is available on ePubs located here: mybell.com

Illustrated parts breakdown

Special tools catalog

Diagnostic and Maintenance Information Transfer System (DMITS) harness & DMITS Software

Main and Tail Rotor tie downs

Cargo tie downs

Pitot covers

Engine inlet covers

Engine exhaust covers

Oil cooler cover

Ground handling wheels, hydraulic (for skid gear only)

POWERPLANT

Two Pratt & Whitney Canada 207D1/D2 Engines, 1,172 SHP; (Mechanical) Maximum Continuous Rating (586 SHP per engine)

Electronic Engine Controls (EEC)

Fuel Management Module (FMM)

Fuel system: 216.9 gal. (821 liter) usable capacity, with three rupture resistant fuel cells located under the cabin floor panel and suction type fuel feed system

Electrical Provisions for Inlet Barrier Filter

Engine Fire Detector and Fire Extinguisher System

ROTORS AND CONTROLS

Main rotor: Soft-in-plane system, 36 ft. diameter, four interchangeable M/R blades, with stacked composite yokes, titanium drive plate and centrifugal force (CF) fittings, elastomeric CF bearings and shear restraints, and elastomeric lead/lag dampers

Composite M/R blades with Nickel-Cobalt leading edge abrasion strips and tip caps, HIGH VISIBILITY (white/black top, black bottom with yellow tip) paint scheme

Tail rotor: 4-blade stacked system, 65" diameter, with low tip speed, scissor arrangement, composite T/R blades with swept blade tips, Nickel-Cobalt leading edge abrasion strips, and elastomeric flapping bearings

Bell 429 and 429WLG Common Production Configuration

Dual Hydraulic System with integrated hydraulic modules

Mechanical flight controls throughout

ROTORS AND CONTROLS (continued)

Collective mounted throttle controls

Rotor brake provisions

TRANSMISSION DRIVE SYSTEM

Two-stage dual input drive main transmission, 1,100 SHP Maximum Continuous Power

Two fluid filled pylon mounts LIVE suspension (left and right vertical axis mounts)

Two elastomeric forward/aft restraints

Three main transmission chip detectors (fuzz burning)

Two transmission-mounted hydraulic pumps

Tail rotor drive shaft:

- Two steel forward drive shafts in engine deck/fire zone
 - Two interchangeable carbon fiber composite aft drive shafts in tailboom zone
-

Single stage 96° tail rotor gearbox

One tail rotor gearbox chip detector (fuzz burning)

Bell 429 Standard Configuration

ADDITIONAL KITS

Tubular skid type with replaceable wear shoes

Bell 429WLG Standard Configuration

ADDITIONAL KITS

Retractable wheeled landing gear provisions

Retractable wheeled landing gear equipment

STANDARD CONFIGURATION NOTES

1. Standard Configuration includes:
 - Fixed provisions for: Cat A. Operations equipment, Inlet Barrier Filter, Air Conditioning, Rotor Brake and WSPS
 - ELT
 - Pilot and Copilot seats, 6-place Passenger Seating with 18.5" wide seats
 - Standard Interior, Headliner panels and Carpet
2. Minimum SPIFR Configuration includes:
 - Provisions for optional equipment including Cat A. Operations, Inlet Barrier Filter fixed provisions, Air Conditioning fixed provisions, Rotor Brake fixed provisions and Wire Strike Protection System fixed provisions
 - ELT
 - Pilot seat
3. Operation at 7,500 lb increased internal gross weight (where approved for use) requires installation of the following equipment:
 - Flashing Forward Light
 - Radar Altimeter
 - Helicopter Terrain Avoidance and Warning System (HTAWS), #1 Garmin GTN-750 NAV/COM/GPS HTAWS upgrade or equivalent HTAWS system
 - Cockpit Voice Recorder/Flight Data Recorder

Optional Accessories

Refer to notes for kit compatibility. Additional kits and STC items may be available for factory installation. Please consult sales or contract personnel regarding special needs prior to selection of final configuration.

OPTIONAL ACCESSORIES

Kit Description	Skid Gear	Weight		Wheel Gear	Weight		Notes
		lb	kg		lb	kg	
AIRFRAME							
Dual Pilot Control Provisions	✓	5.3	2.4	✓	5.3	2.4	2, 3
Dual Pilot Controls Equipment (does not include copilot head set) (required for dual pilot operation)	✓	10.5	4.8	✓	10.5	4.8	2, 3
Pilot Cyclic Stick Locking Device	✓	0.2	0.1	✓	0.2	0.1	
200 Amp Starter Generator (dual) (required for Cat. A operations)	✓	7.8	3.5	✓	7.8	3.5	1, 2, 22
Increased Capacity Battery, 53 AmpH (Cat. A compliant)	✓	35.1	15.9	✓	35.1	15.9	1, 22
Increased Capacity Battery, 44 AmpH (Cat. A compliant)	✓	28.2	12.8	✓	28.2	12.8	1, 2, 22
36 AmpH Battery	✓	19.2	8.7	✓	19.2	8.7	22
Articulated Landing Light (required for Cat. A operations)	✓	9.2	4.2	✓	9.2	4.2	1, 2
Rotor Brake Equipment	✓	9.8	4.4	✓	9.8	4.4	2
Aux. Fuel Tank Equipment (39 US Gal.)	✓	60.2	27.3	✓	60.2	27.3	
Windshield Wiper (pilot) (ECE)	✓	9.8	4.4	✓	9.8	4.4	5
Windshield Wiper (copilot) (ECE)	✓	6.9	3.1	✓	6.9	3.1	5
Rear Clamshell Doors with windows	✓	28.8	13.1	✓	28.8	13.1	
Emergency Float Provisions (electrical and fixed) - for Floats without Life Rafts	✓	23.3	10.6				6
Emergency Floats without life rafts (Aerazur) (life vests not included)	✓	129.6	58.8				6
Emergency Float Provisions (electrical and fixed) - for Floats with Life Raft(s)	✓	23.4	10.6				6
Emergency Floats with one life raft, left side (Aerazur) (life vests not included)	✓	175.3	79.5				6
Emergency Floats with two life rafts, left and right sides (Aerazur) (life vests not included)	✓	220.9	100.2				6
Emergency Floats Hoist Protection Cover	✓	1.6	0.7				6
Ditching Kit (additional strengthening to aircraft nose and belly)	✓	3.4	1.5	✓	3.4	1.5	7, 25
Life Vest Provisions, 4-place stowage pouches	✓	0.5	0.2	✓	0.5	0.2	7
Life Vest Provisions, 5-place stowage pouches	✓	0.6	0.3	✓	0.6	0.3	7

Optional Accessories

OPTIONAL ACCESSORIES

Kit Description	Skid Gear	Weight		Wheel Gear	Weight		Notes
		lb	kg		lb	kg	
Life Vest Provisions, 6-place stowage pouches	✓	0.8	0.4	✓	0.8	0.4	7
AIRFRAME (continued)							
Emergency Egress, Standard Interior (push-out windows for hinged passenger doors)	✓	8.1	3.7	✓	8.1	3.7	8
Protected Tail-Rotor System	✓	11.9	5.4	✓	11.9	5.4	9
Flashing Forward Light	✓	0.6	0.3	✓	0.6	0.3	4
Passenger Steps - single step each side	✓	-8.2	-3.7	✓	-8.2	-3.7	10
AUDIO							
Aft Cabin ICS - 6-place (headsets not included)	✓	2.5	1.1	✓	2.5	1.1	
AVIONICS							
Radar Altimeter (Honeywell KRA 405B) (required for Cat. A operations)	✓	5.5	2.5	✓	5.5	2.5	1, 2, 4
3rd Display Unit (NVG compatible) and 2nd Standby Compass (required for dual pilot IFR)	✓	19.6	8.9	✓	16.9	7.7	3
ADF (Honeywell KR 87)	✓	10.6	4.8	✓	10.6	4.8	
HTAWS Modification for GTN-750 HTAWS upgrade kit Provisions and HTAWS Data Card	✓	0.4	0.2	✓	0.4	0.2	4
Traffic Advisory System (Avidyne TAS605A)	✓	20.5	9.3	✓	20.5	9.3	11
4th Axis Autopilot	✓	4.5	2.0	✓	4.5	2.0	
Weather Radar (Primus 660)	✓	27.1	12.3	✓	27.1	12.3	25
ENVIRONMENT							
Single Evaporator Air Conditioning with manual controls (AirComm)	✓	84.5	38.3	✓	84.5	38.3	12, 13
Dual Evaporator Air Conditioning with manual controls (AirComm)	✓	113.3	51.4	✓	113.3	51.4	12, 13
Bleed Air Heater Provisions (AirComm)	✓	16.6	7.5	✓	16.6	7.5	2
Bleed Air Heater Equipment (with chin bubble defrost capability) (AirComm)	✓	21.1	9.6	✓	21.1	9.6	
EQUIPMENT							
Cargo Hook Provisions (Onboard Systems)	✓	12.0	5.4	✓	12.0	5.4	
Cargo Hook Equipment, 3,000 lb capacity (Onboard Systems)	✓	31.4	14.2	✓	31.4	14.2	
High Gross Weight Towing kit (AA) (required for towing at weight >5,850 lb)	✓	n/a	n/a	✓	n/a	n/a	
Main Rotor Blade Folding Kit (2 forward, 2 aft) (Paravion, loose equipment)	✓	n/a	n/a	✓	n/a	n/a	

Optional Accessories

OPTIONAL ACCESSORIES

Kit Description	Skid Gear	Weight		Wheel Gear	Weight		Notes
		lb	kg		lb	kg	
EQUIPMENT (continued)							
Main Rotor Blade Folding Kit - Fixed Provisions (Paravion)	✓	1.0	0.5	✓	1.0	0.5	
Quick Release Main Rotor Blade Bolts (4 bolts, 1 per blade; required for use with Main Rotor Blade Folding Kit)	✓	3.2	16.4	✓	3.2	16.4	
Rescue Hoist Provisions, including Interior Trim modification	✓	36.1	16.4	✓	36.1	16.4	14, 15
Rescue Hoist Equipment, Goodrich 600 lb. capacity	✓	184.2	83.6	✓	184.2	83.6	14, 15
FLIGHT and ENGINE INSTRUMENTS							
Cockpit Voice Recorder/Flight Data Recorder, Crashworthy	✓	14.2	6.4	✓	14.2	6.4	4
Health and Usage Monitoring System (AA)	✓	19	8.6	✓	19	8.6	
INTERIOR							
Headliner with LED lights and adjustable Air Conditioning vents	✓	11.5	5.2	✓	11.5	5.2	13
Corporate Headliner with LED lights, adjustable Air Conditioning vents and color coordinated leather trim	✓	12.0	5.4	✓	12.0	5.4	13
Corporate Interior, Single Pilot <ul style="list-style-type: none"> • Corporate Interior Trim • High-quality carpet/flooring (for use with single pilot controls) 	✓	11.8	5.4	✓	11.8	5.4	18
Corporate Interior, Dual Pilot <ul style="list-style-type: none"> • Corporate Interior Trim • High-quality carpet/flooring (for use with dual pilot controls) 	✓	11.5	5.2	✓	11.5	5.2	18
Cabin Soundproofing	✓	10.0	4.5	✓	10.0	4.5	17
Aft Bulkhead Closeout panel	✓	9.6	4.4	✓	9.6	4.4	14, 17
Aft Bulkhead Closeout panel with soundproofing	✓	26.5	12.0	✓	26.5	12.0	14, 17
Utility Light Weight Interior	✓	-20.0	-9.1	✓	-20.0	-9.1	
NVG-compatible lighting for all other internal light sources (may be US ITAR controlled) (typical weight estimate for reference)	✓	2.0	0.9	✓	2.0	0.9	16

Optional Accessories

OPTIONAL ACCESSORIES

Kit Description	Skid Gear	Weight		Wheel Gear	Weight		Notes
		lb	kg		lb	kg	
Note: All interior option weight values are delta increase or decrease from standard configuration weights.							
Passenger Seating Options							
Standard 6-place seating, 15.5" wide seats with 4-point restraint system, quick release disconnects and ICS fixed provisions	✓	-19.1	-8.7	✓	-19.1	-8.7	
Corporate 6-place seating, 18.5" wide seats with 3-point restraint system, quick release disconnects and ICS fixed provisions	✓	31.0	14.1	✓	31.0	14.1	
Corporate 5-place club seating with 1 center console and side arm rests, 3-point restraint system, quick release disconnects and ICS fixed provisions	✓	40.6	18.5	✓	40.6	18.5	
Corporate 4-place club seating with center consoles and side arm rests, 3-point restraint system, quick release disconnects and ICS fixed provisions	✓	33.2	15.1	✓	33.2	15.1	
Seat Rail Removal	✓	-6.0	-2.7	✓	-6.0	-2.7	2, 21
Note: All passenger seating option weight values are weight increase or decrease from the standard configuration 18.5" wide seating weight.							
Powerplant							
Engine Fuel Heater (PW207D2 engine) (P&W)	✓	4.3	2.0	✓	4.3	2.0	
Compressor Wash Kit	✓	1.4	0.6	✓	1.4	0.6	24
Inlet Barrier Filter	✓	20.5	9.3	✓	20.5	9.3	2
Engine Fire Extinguisher - 2nd bottle	✓	6.6	3.0	✓	6.6	3.0	
Vendor Kits - STC							
Sliding Passenger Door Photo (sliding) Window, L/H (AA)	✓	4.4	2.0	✓	4.4	2.0	19
Sliding Passenger Door Photo (sliding) Window, R/H (AA)	✓	4.4	2.0	✓	4.4	2.0	19
Automatic Door Openers, Crew (2 door kit) (AA)	✓	1.9	0.9	✓	1.9	0.9	
Automatic Door Openers, Hinged Passenger Doors (2 door kit) (AA)	✓	2.2	1.0	✓	2.2	1.0	
Wire Strike Protection System, detachable equipment, skid gear aircraft (AA) RECOMMENDED	✓	21.4	9.7	✓	21.4	9.7	20
Crew Floor Protectors, L/H and R/H (AA)	✓	5.2	2.4	✓	5.2	2.4	
Cabin Floor Protectors, forward and aft (AA)	✓	9.1	4.1	✓	9.1	4.1	
Cabin Floor Protector, forward (AA)	✓	4.0	1.8	✓	4.0	1.8	
Cabin Floor Protector, aft (AA)	✓	5.1	2.3	✓	5.1	2.3	
Cargo Mirror (AA)	✓	3.2	1.5				
Hard Point (Rappelling System) (AA)	✓	0.4	0.2	✓	0.4	0.2	23

Optional Accessories

OPTIONAL ACCESSORIES

Kit Description	Skid Gear	Weight		Wheel Gear	Weight		Notes
		lb	kg		lb	kg	
Hard Point (Ceiling, Spotter) (AA)	✓	0.3	0.1	✓	0.3	0.1	23
VENDOR KITS - STC (continued)							
Hard Point (Floor, Spotter) (AA)	✓	0.4	0.2	✓	0.4	0.2	23
Fuel Filler Area Protector (AA)	✓	0.1	0.0	✓	0.1	0.0	

EXPLANATORY NOTES

- Kits required for Category A Operations:
 - 200 Amp Starter Generator (Dual)
 - Increased Capacity Battery (53 AmpH or 44 AmpH)
 - Articulated Landing Light
 - Radar Altimeter
- Standard Configuration kits removable and / or replaceable by customizing or optional accessory kit.
- Kits required for Dual Pilot IFR:
 - Dual Pilot Control Provisions
 - Dual Pilot Controls Equipment
 - 3rd Display Unit and 2nd Standby Compass
- Optional Accessory Kits required for 7,500 lb. Internal Gross Weight Operations (ref. Transport Canada approved Flight Manual Supplement BHT-429-FMS-11):
 - Flashing Forward Light
 - Radar Altimeter
 - HTAWS Modification for GTN-750
 - Cockpit Voice Recorder / Flight Data Recorder, crashworthy
- The Bell 429 helicopter is certified for IFR operations without windshield wipers.
 - Installation of the Pilot Windshield Wiper kit does not require installation of the Copilot Windshield Wiper kit.
 - Installation of the Copilot Windshield Wiper requires installation of the Pilot windshield Wiper Kit.
- Emergency Floats Electrical and Fixed Provisions kits are required for installation of Emergency Floats. Each Emergency Float kit (removable equipment) consists of two removable integrated skid mounted modules containing inflatable floats, inflation bottles and, if selected, an optional JAR-OPS compliant 6-person life raft with survival equipment, giving customers a choice among three Emergency Float configurations:
 - Emergency Floats without life rafts
 - Emergency Floats with one life raft, LH or RH side
 - Emergency Floats with two life rafts
 - Towing or pushing the Bell 429 helicopter with ground handling wheels when the helicopter is equipped with the emergency flotation system requires each flotation module to be removed from the landing gear and temporarily stowed on the ground handling wheels, using a float carrier pad and strap.
 - Operation of the rescue hoist with emergency floats installed requires the Emergency Floats Hoist Protection Cover. The hoist cable length is 290 ft (88.39 m). The usable cable length is 270 ft (82.29 m). It is prohibited to deploy the last 20 ft (6.1 m) of the hoist cable. The last 20 ft (6.1 m) of the hoist cable is painted orange to provide a visual precaution to the hoist operator that the cable has been extend to within the last 20 ft (6.1 m) of the usable cable length. The maximum hoist cable angle deflection limit is 30 degrees from vertical.
- Ditching certification is required for operations under European Joint Aviation Regulation JAR-OPS 3.843(a) for Performance Class 1 or 2 flights over water in a hostile environment at a distance from land corresponding to more than 10 minutes flying time at normal cruise speed. If ditching certification is required, the following kits must be installed: Ditching Kit, Emergency Floats, and Life Vest Provision Kits.

Optional Accessories

8. Emergency Egress Kit is required for front row passenger emergency exit when Emergency Floats and 15.5" standard 6-place seating kits are installed with passenger seats in airline seating arrangement with front row of seats facing forward.
9. The Protected Tail Rotor System is designed to prevent injury and provide a safe working environment for personnel who are in the vicinity of the aircraft.
10. Optional kit to replace full length standard configuration passenger steps, if full length steps are not required. Single step kit is not compatible with airline configuration passenger seat installation.
11. Avidyne TAS605A Traffic Avoidance System is a lighter weight system available as a customized installation. See page 15 of the Bell 429 Product Specification for features comparison.
12. Air Conditioning Quill Drive and Provisions are included in Standard Configuration.
13. Headliner with adjustable air vents, p/n 429-706-202-107 or 429-706-202-109, is recommended for more effective cooling when air conditioning is installed.
14. Aft Cabin Bulkhead Closeout, if installed, must be removed for Rescue Hoist Operations.
15. Right side aft passenger seat must be removed for installation of the Rescue Hoist Control Box Pendent Bracket. Pendent bracket is removable when pendent is not installed for mission use.
16. The standard configuration primary, secondary and optional 3rd instrument display units are NVG-compatible, NVG-compatible lighting treatment for other internal and external light sources, including NVG lighting for the standby compasses and cabin black-out curtains, will vary depending upon specific aircraft configuration. Aerodynamix STC'd NVG lighting is available as a customized installation.
17. For effective internal noise reduction, Aft Cabin Bulkhead panel, p/n 429-706-060-103 or 429-706-060-105, is strongly recommended when cabin soundproofing is installed.
18. Standard Configuration floor covering includes a customer choice of materials, either durable low loop nylon blend carpet or "Aermat" vinyl floor covering. Either single pilot or dual pilot standard carpet is included in Standard Configuration Price. Corporate Interior floor coverings feature high-tech vinyl and high-quality cabin carpet, color coordinated to match the leather seat upholstery.
19. Three Passenger Door Sliding Window color options available:
 - p/n 429-564-007, L/H (Gray, this color is standard unless otherwise stated)
 - p/n 429-564-009, L/H (Medium Gray)
 - p/n 429-564-011, L/H (Dark Gray)
 - p/n 429-564-008, R/H (Gray, this color is standard unless otherwise stated)
 - p/n 429-564-010, R/H (Medium Gray)
 - p/n 429-564-012, R/H (Dark Gray)
20. Wire Strike Protection System Provisions are included in Standard Configuration.
21. Passenger Seat Rail Removal kit required for installation of AMC or Aerolite EMS Interior Systems.
22. Selection of optional increased capacity battery replaces standard aircraft's 25 AmpH battery. Installation of 53 AmpH, 44 AmpH or 36 AmpH battery requires installation of the 200 Amp Starter Generator kit. However, installation of 200 Amp Starter Generator does not require installation of the 53 AmpH, 44 AmpH or 36 AmpH battery.
23. At least one Spotter hardpoint is required for Rescue Hoist or Rappelling Operations.
24. Compressor Wash Kit consists of an engine wash inlet port located on the air inlet section of each engine, a flexible hose and spray nozzles for each side of the engine air inlet section. It does not include detachable loose equipment such as wash tank and hoses.
25. If the Meeker Nose Mount customizing kit is installed for operations of a search light or electro-optical camera system, the Weather Radar (part number 429-706-018-101) is required for physical installation compatibility.

Helicopter Performance Charts

Bell 429 (Skid Gear) AND Bell 429WLG (Wheeled Gear)

IGE and OGE hover, and service ceiling performance chart data based on the following conditions:

- Pratt & Whitney Canada PW207D1/D2 engines
- Minimum specification engine power
- Basic Inlet or Barrier Filter installed
- Air conditioning off / heater off
- Clean Inlet Filter Installed
- Zero wind or headwind



Helicopter Performance Charts

IGE HOVER CEILING

Conditions:

- Twin engine operation at takeoff power

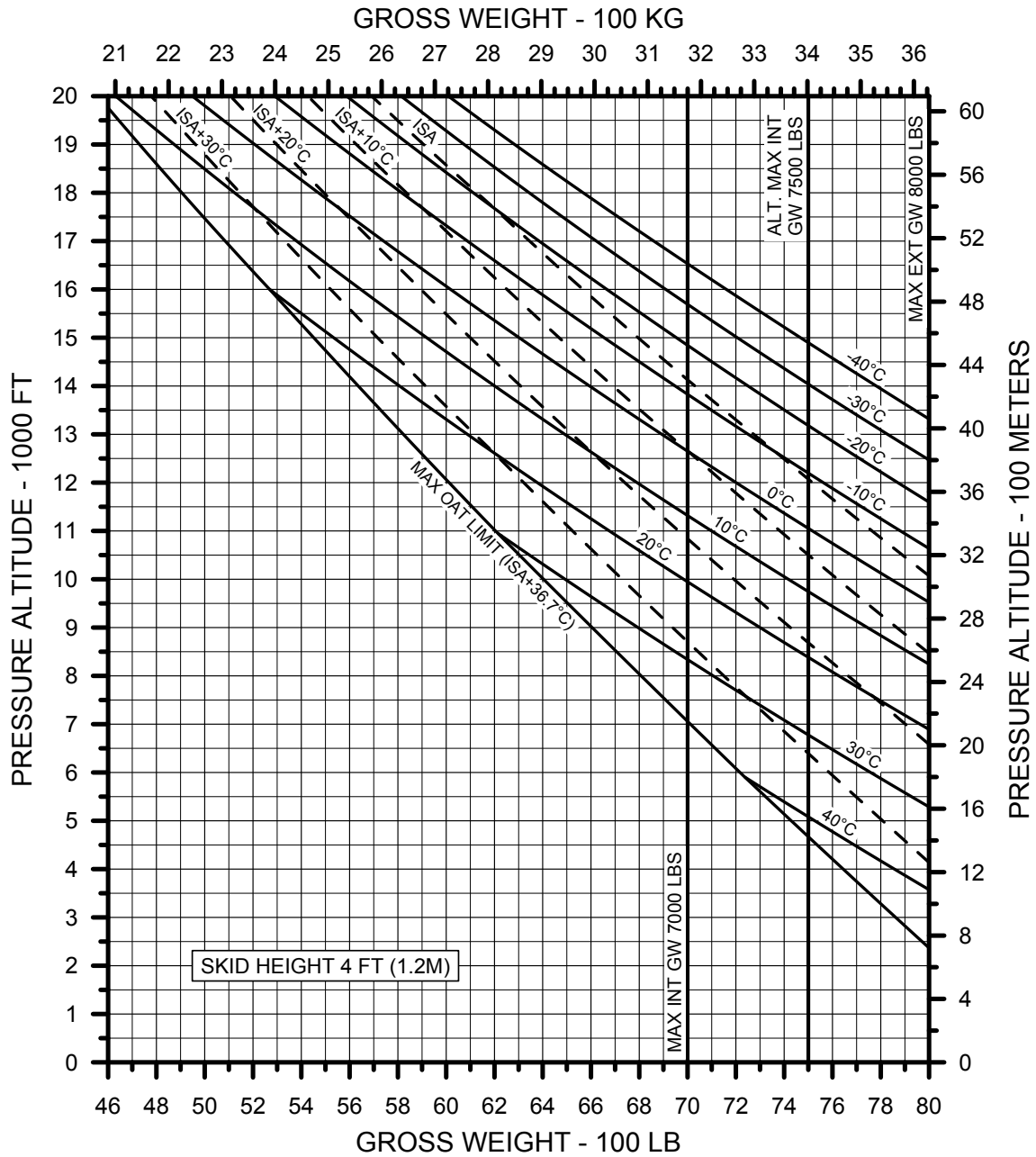

Helicopter Performance Charts

OGE HOVER CEILING

Conditions:

- Twin engine operation at takeoff power

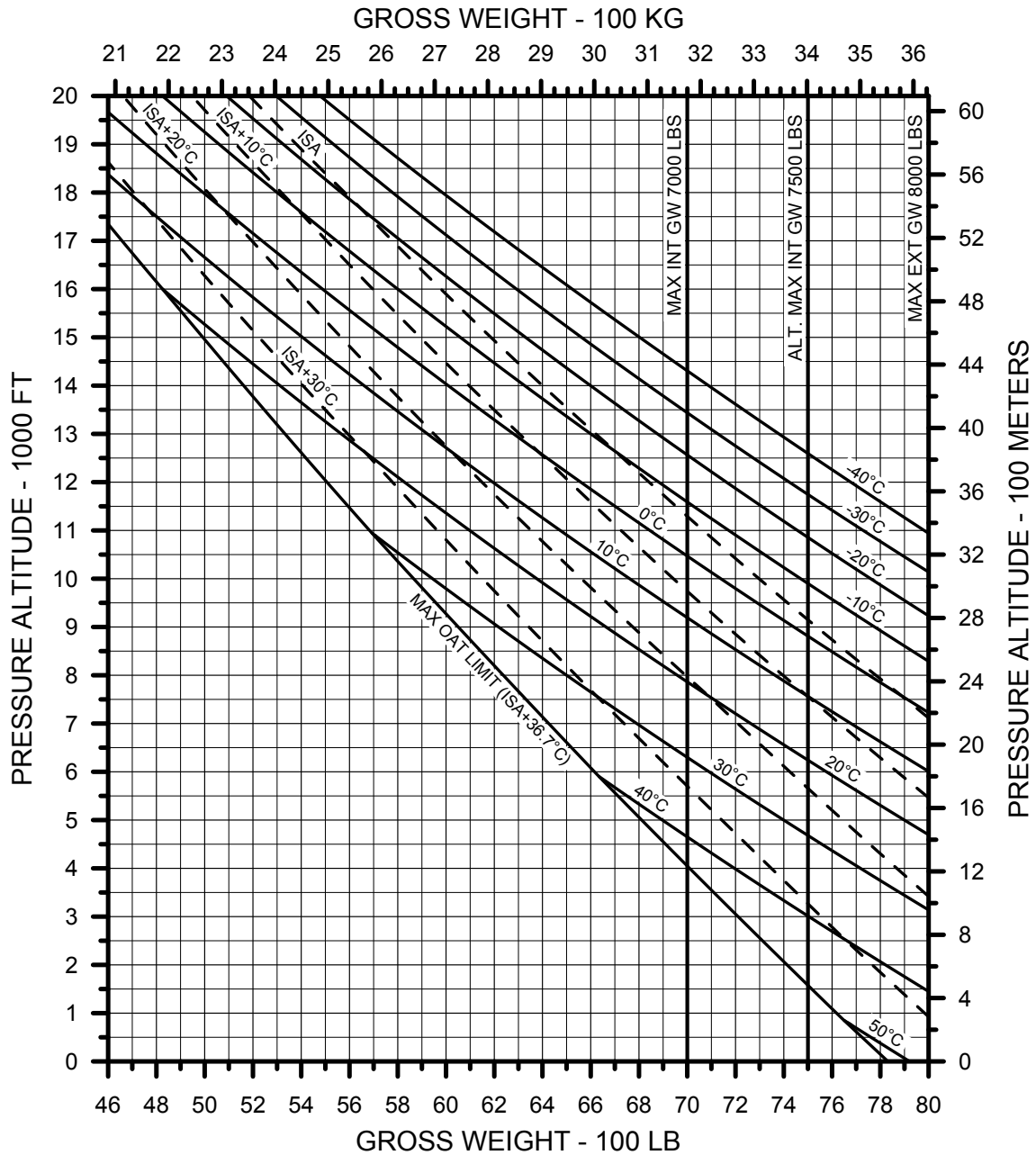

Helicopter Performance Charts

SERVICE CEILING

Conditions:

- Twin engine operation at maximum continuous power

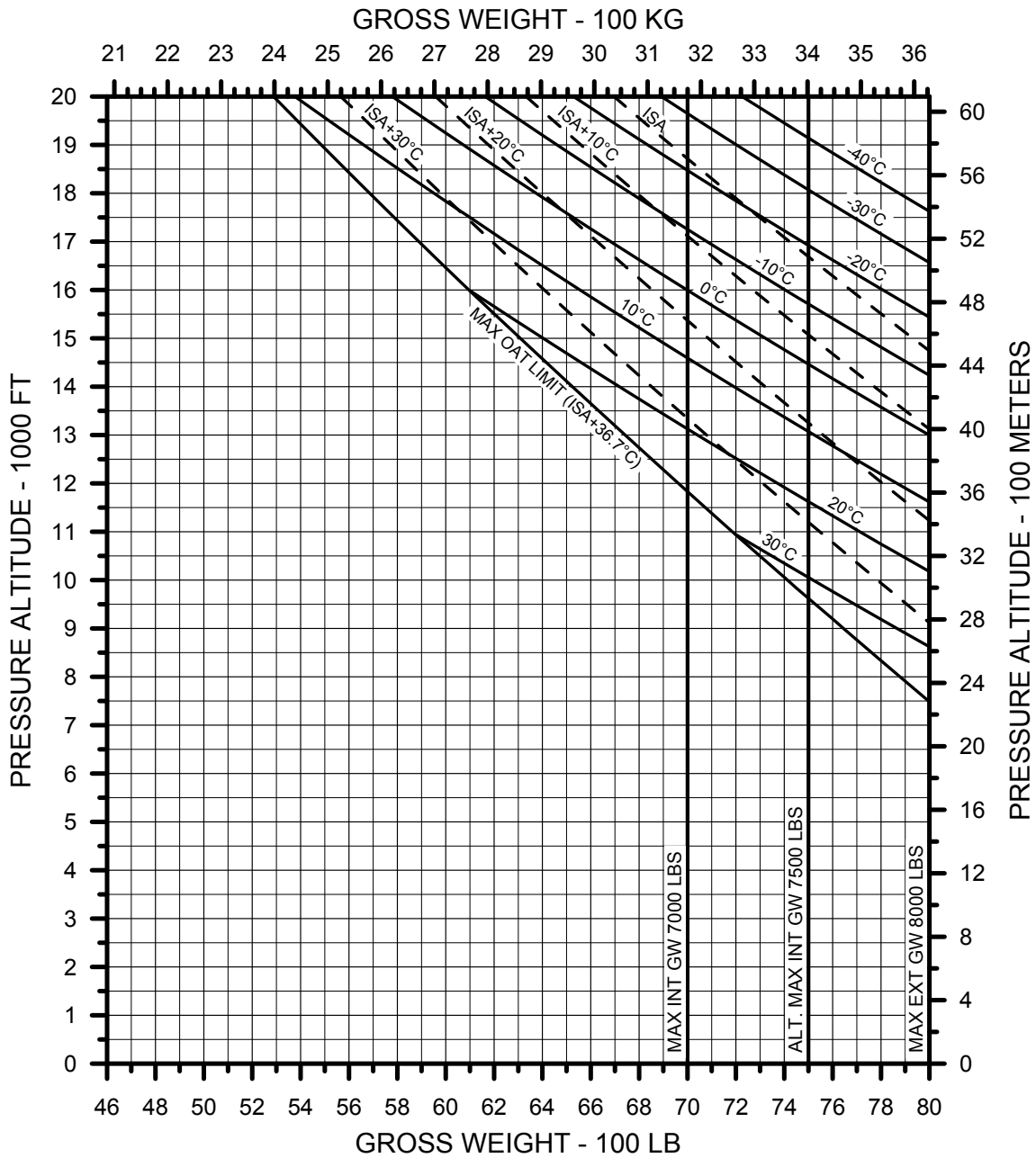

Helicopter Performance Charts

OEI SERVICE CEILING

Conditions:

- OEI 30-minute power

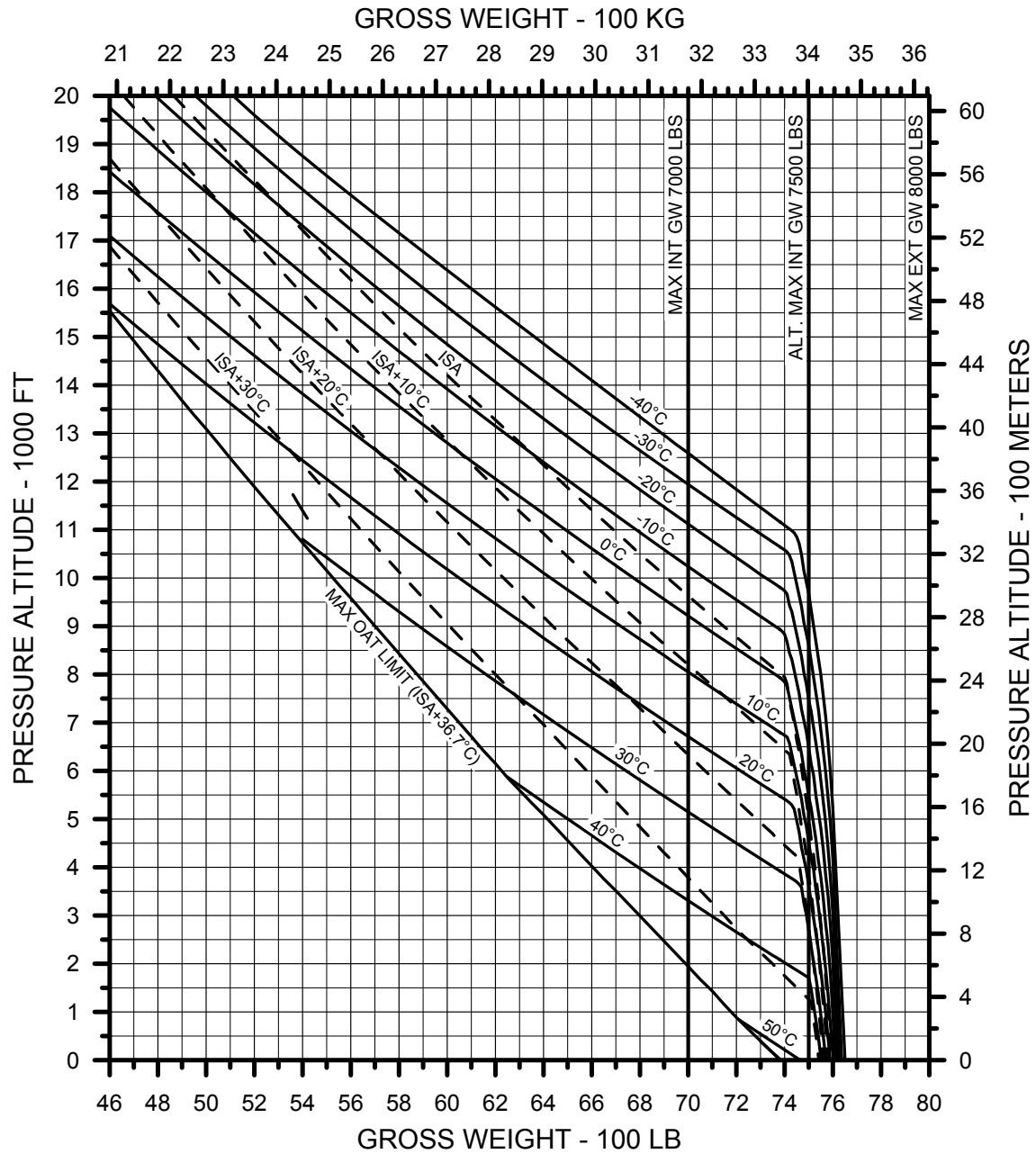

Helicopter Performance Charts

OEI SERVICE CEILING

Conditions:

- OEI continuous power

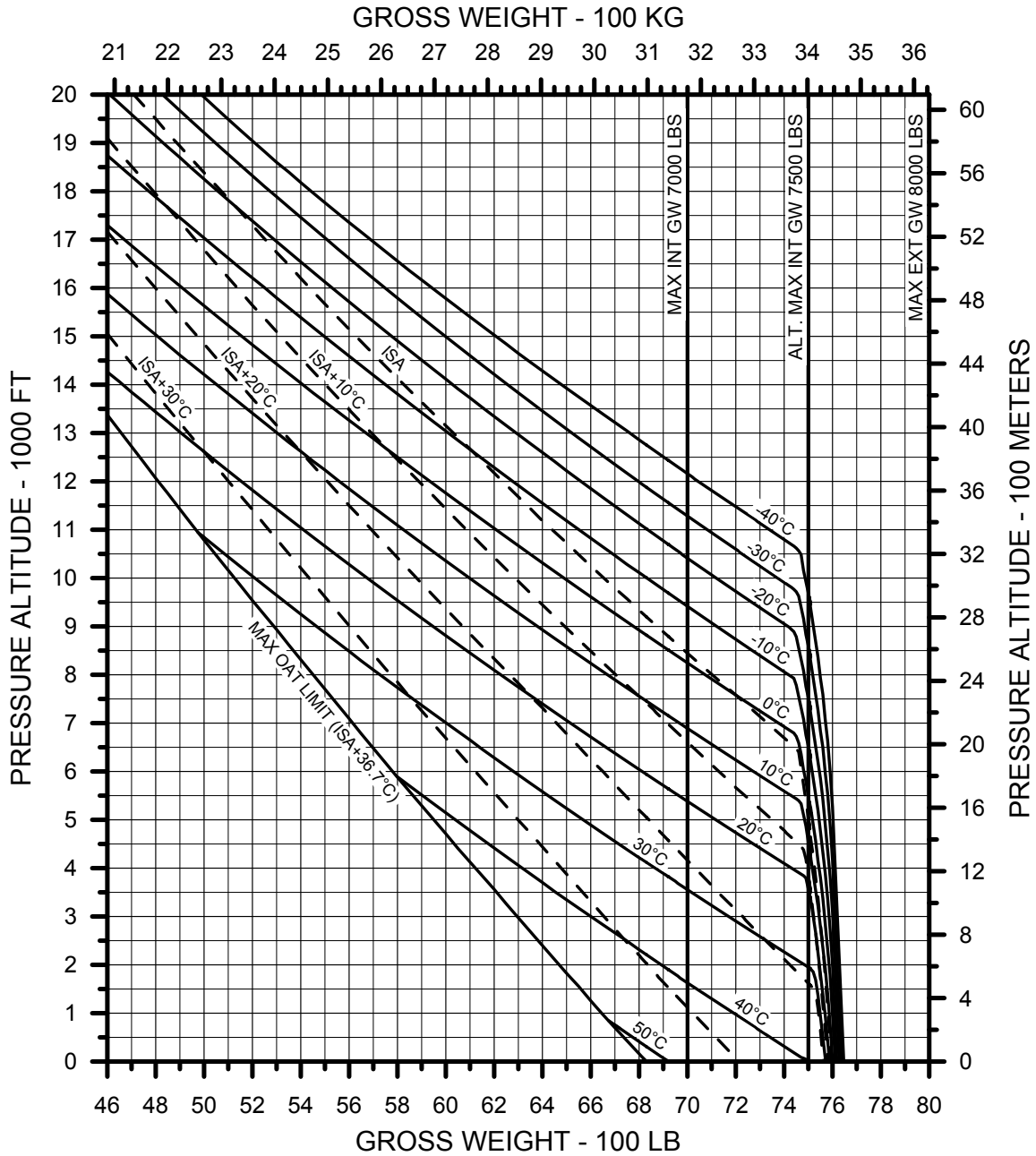

Fuel Flow vs. Airspeed Charts

BELL 429 (SKID GEAR)

Fuel Flow vs. Airspeed chart data based on the following conditions:

- Pratt & Whitney Canada PW207D1/D2 engines
- Minimum specification engine power
- Basic Inlet or Barrier Filter installed
- Air conditioning off / heater off
- Clean Inlet Filter installed
- Zero wind
- Max continuous power based on Worst New Engine (WNE)



Fuel Flow vs. Airspeed

BELL 429 (SKID GEAR)

PRESSURE ALTITUDE = SEA LEVEL, OAT = 15 °C (ISA)

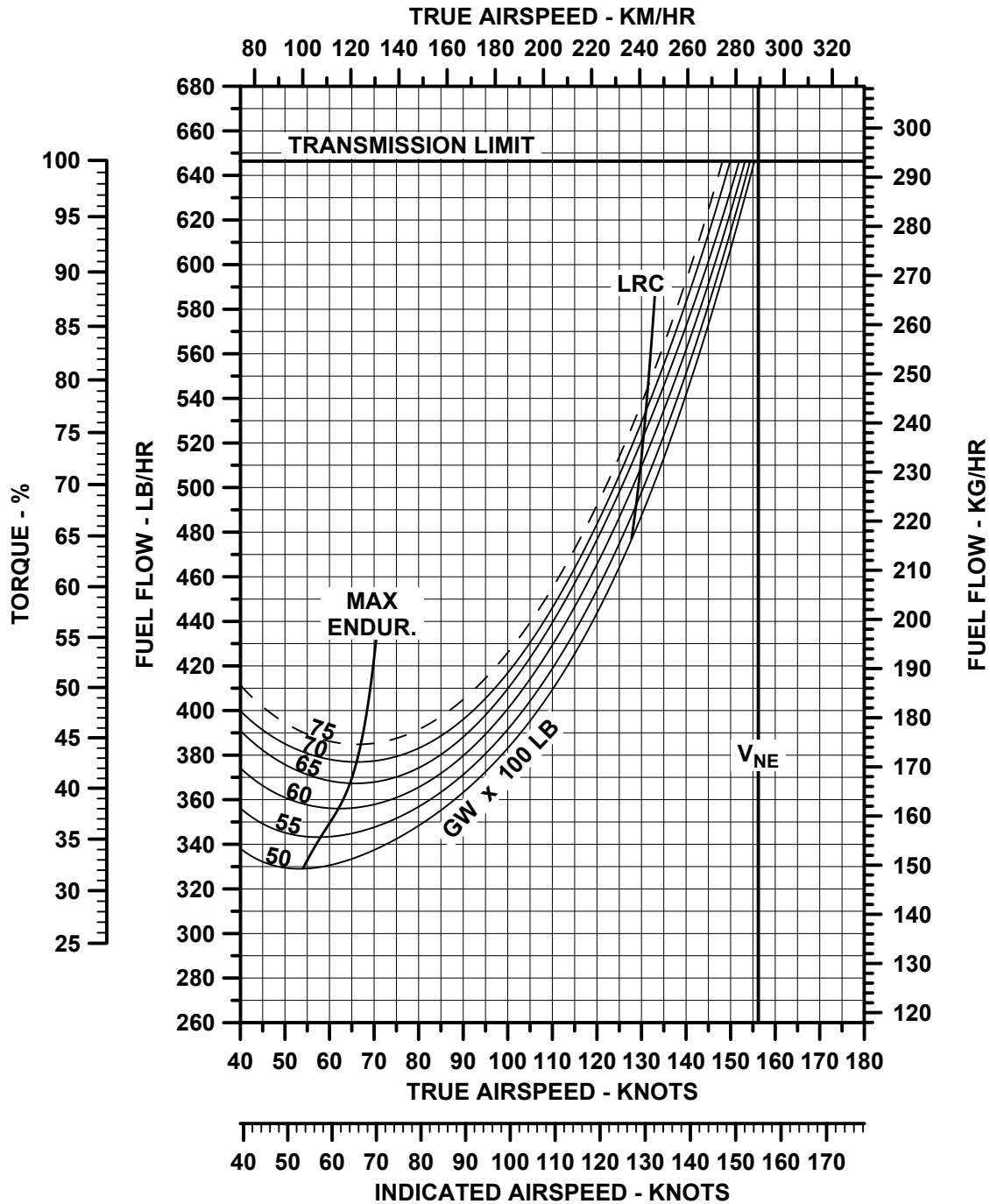

Fuel Flow vs. Airspeed

BELL 429 (SKID GEAR)

PRESSURE ALTITUDE = 2,000 FT, OAT = 11 °C (ISA)

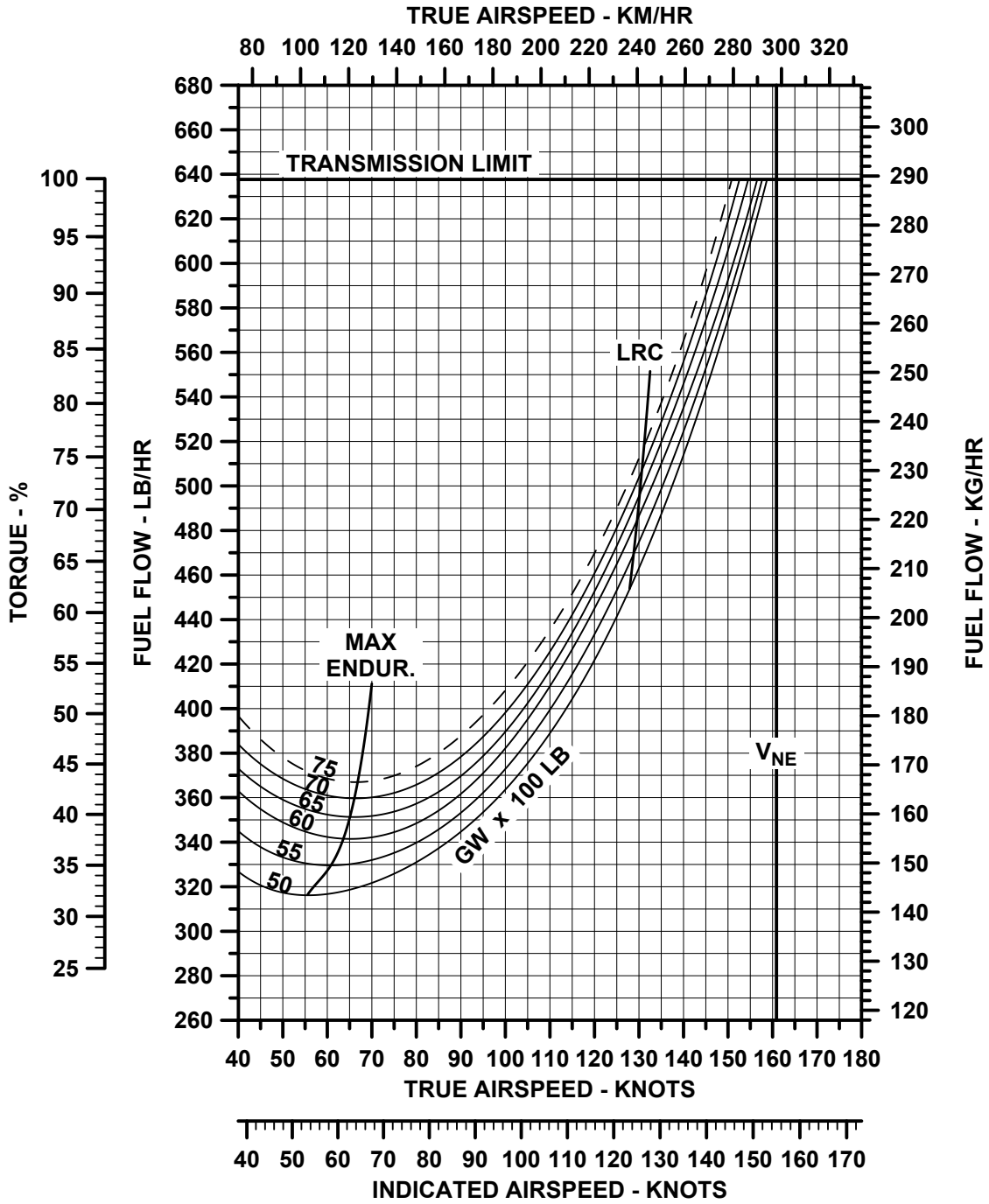

Fuel Flow vs. Airspeed

BELL 429 (SKID GEAR)

PRESSURE ALTITUDE = 4,000 FT, OAT = 7 °C (ISA)

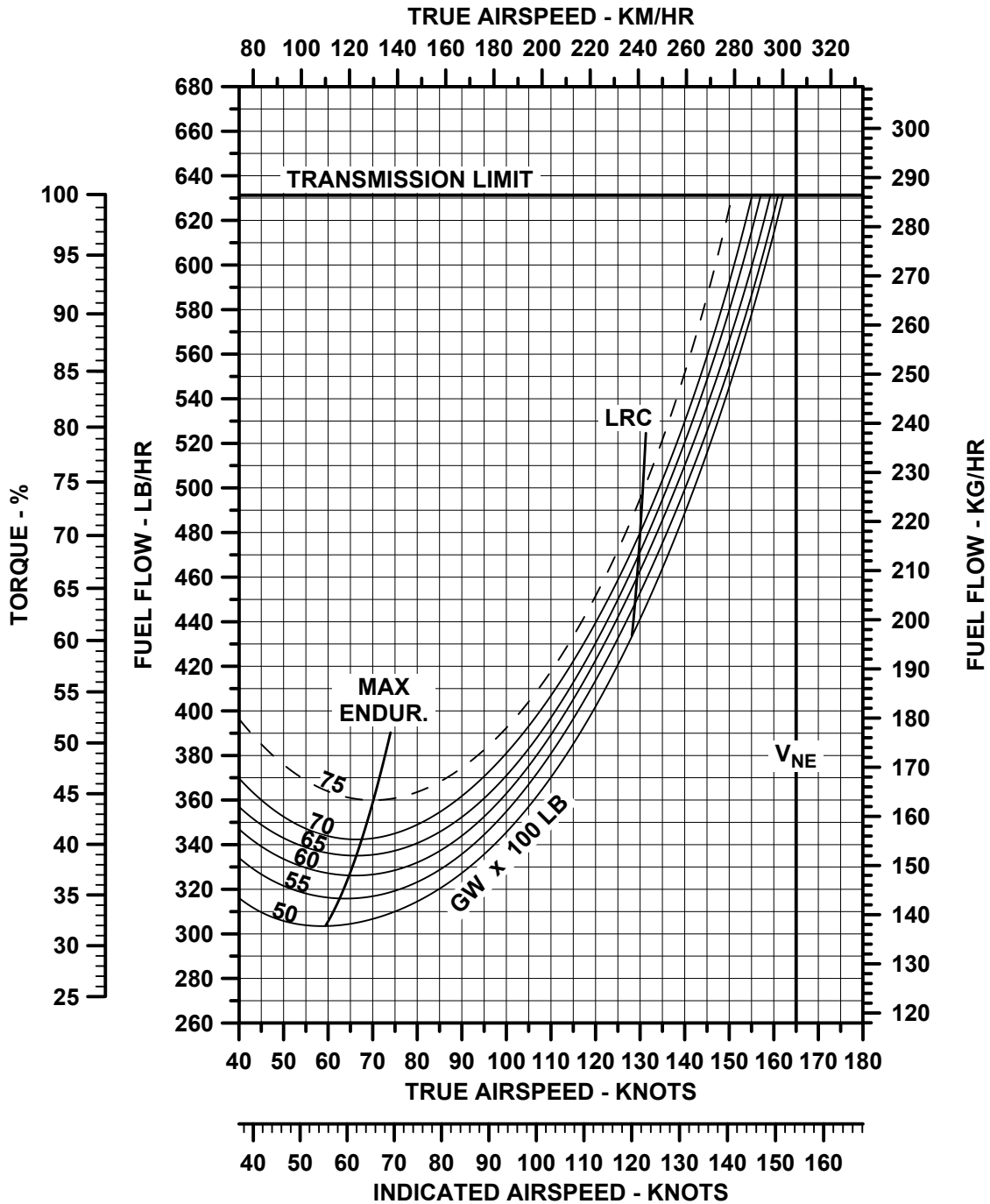

Fuel Flow vs. Airspeed

BELL 429 (SKID GEAR)

PRESSURE ALTITUDE = 6,000 FT, OAT = 3 °C (ISA)

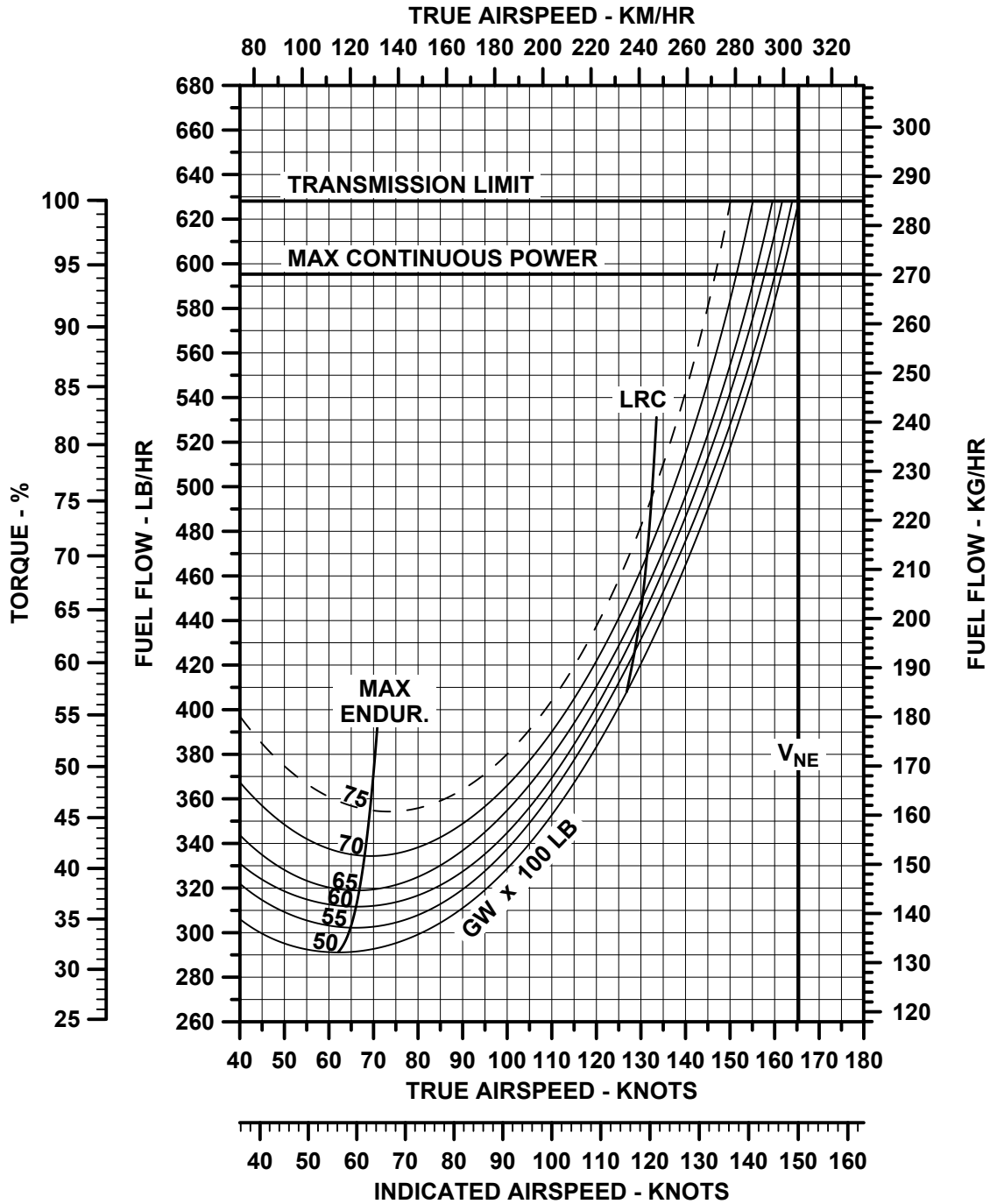

Fuel Flow vs. Airspeed

BELL 429 (SKID GEAR)

PRESSURE ALTITUDE = 8,000 FT, OAT = -1 °C (ISA)

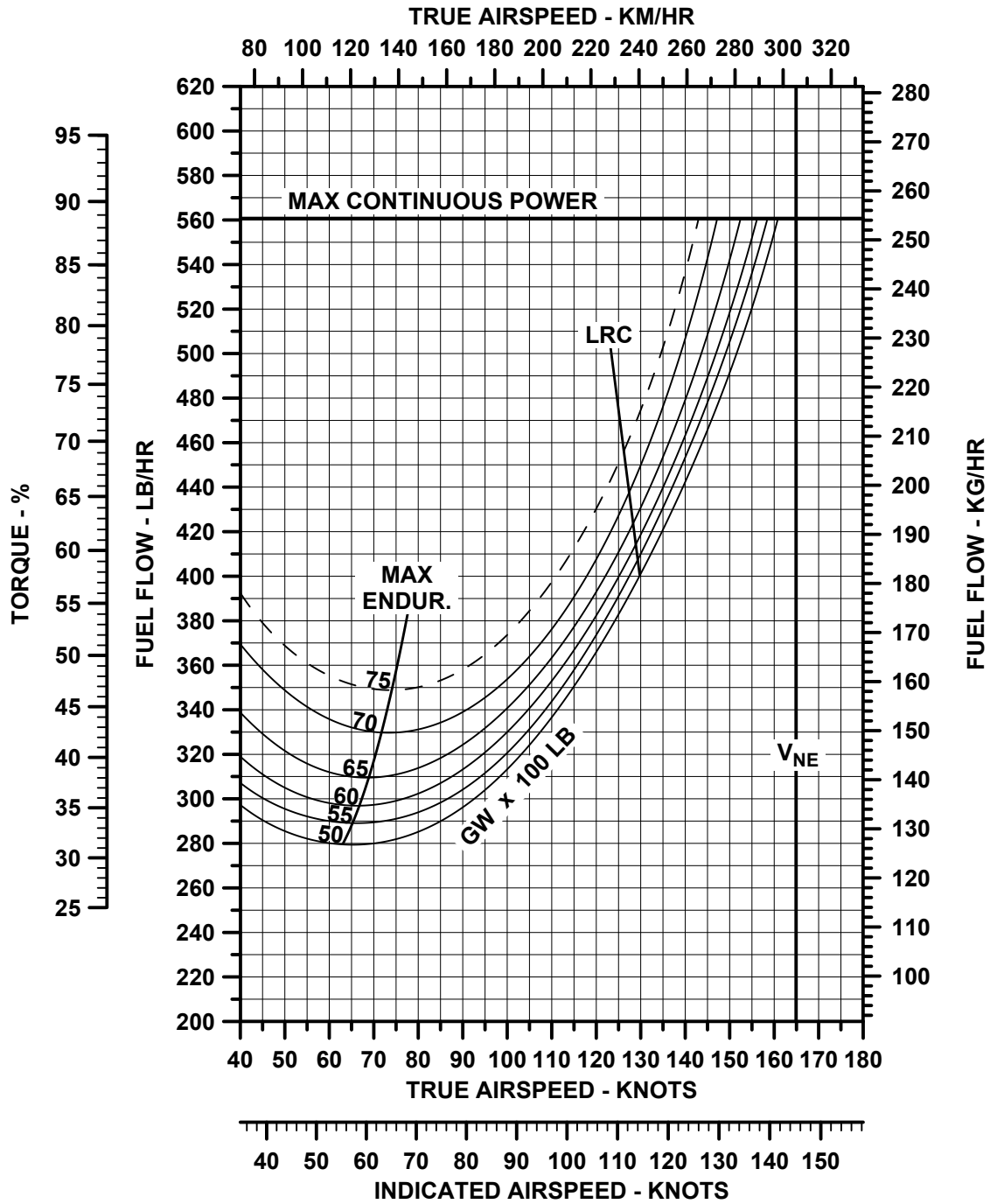

Fuel Flow vs. Airspeed

BELL 429 (SKID GEAR)

PRESSURE ALTITUDE = 10,000 FT, OAT = -5 °C (ISA)

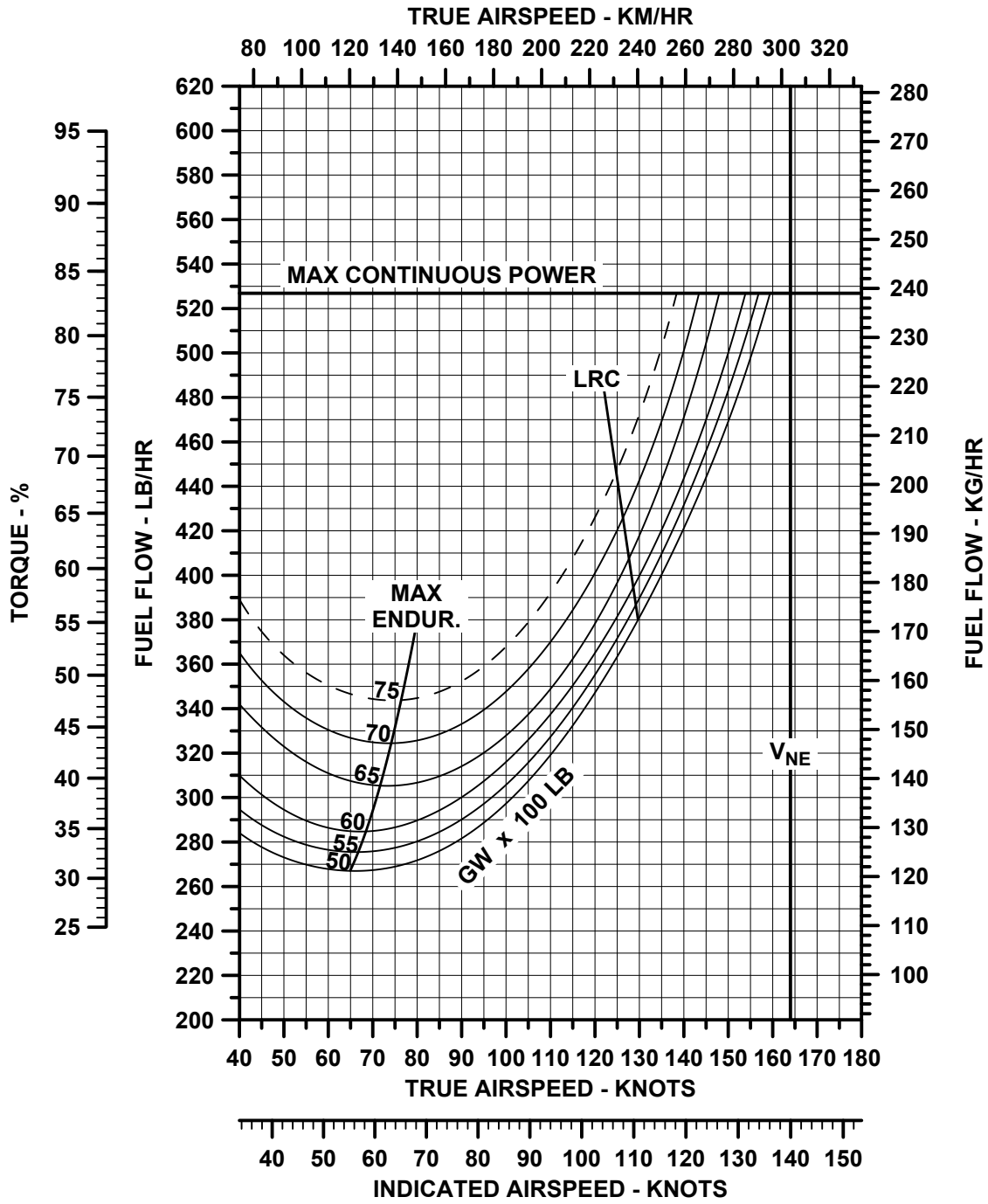

Fuel Flow vs. Airspeed

BELL 429 (SKID GEAR)

PRESSURE ALTITUDE = SEA LEVEL, OAT = 35 °C (ISA + 20)

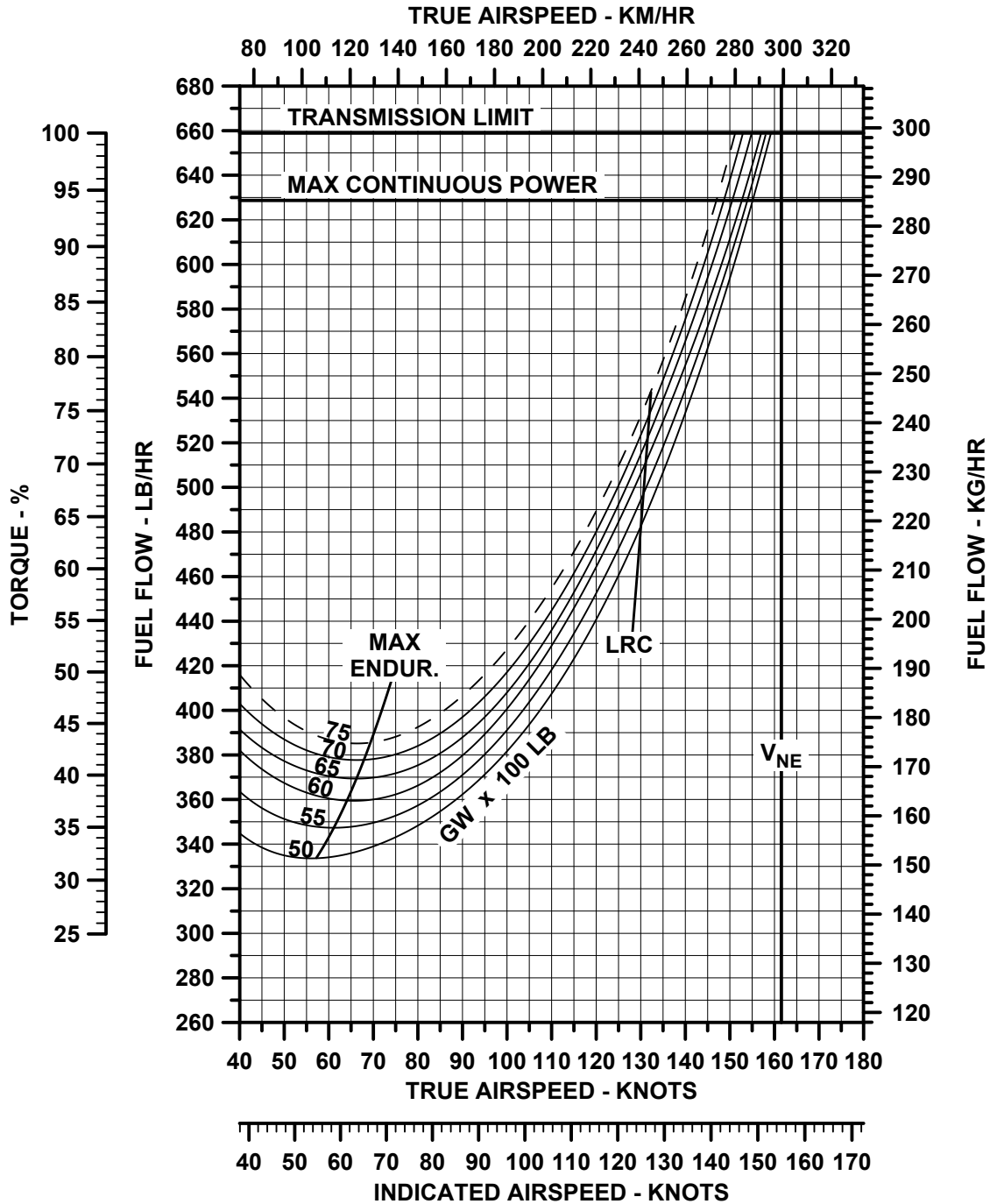

Fuel Flow vs. Airspeed

BELL 429 (SKID GEAR)

PRESSURE ALTITUDE = 2,000 FT, OAT = 31 °C (ISA + 20)

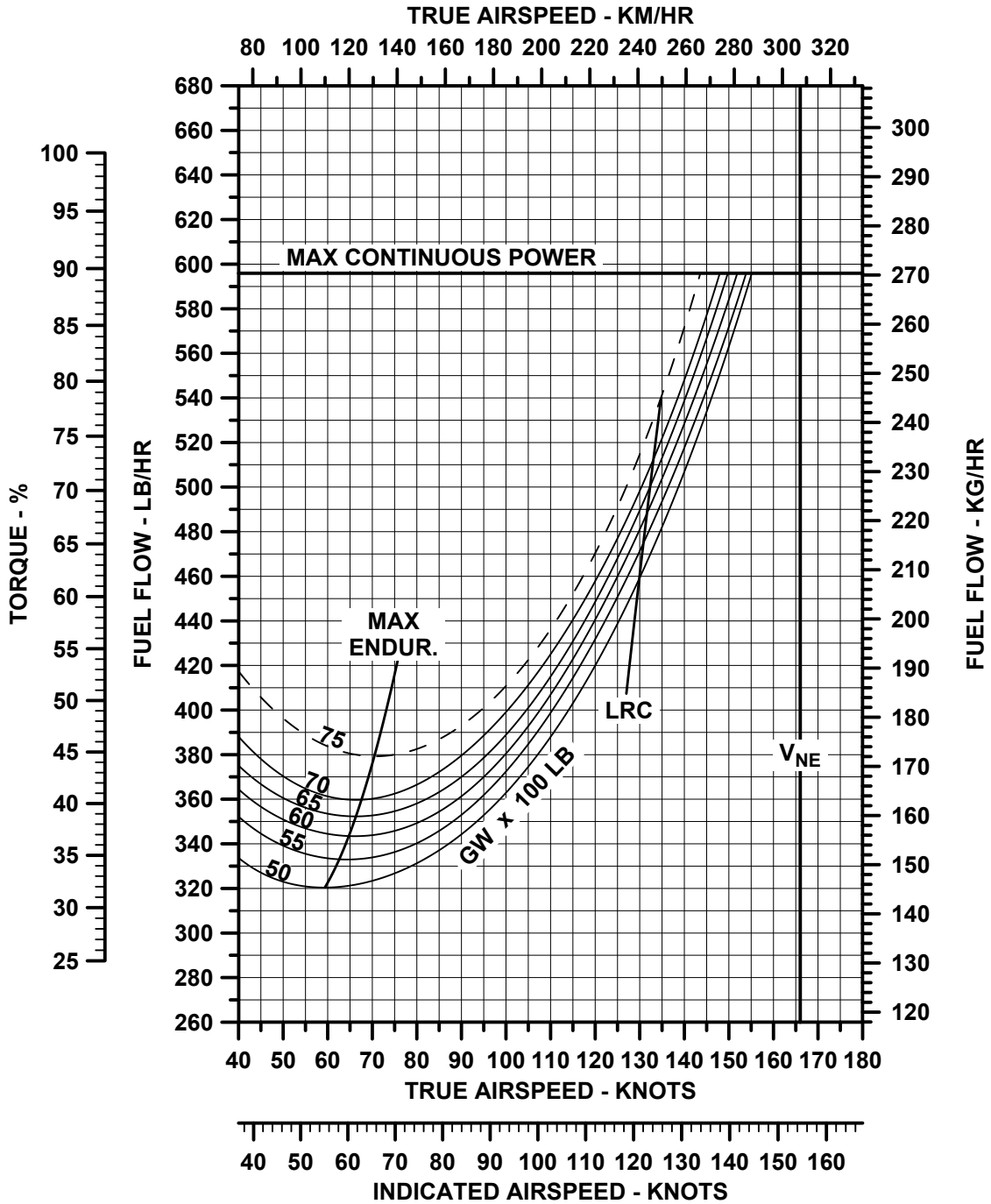

Fuel Flow vs. Airspeed

BELL 429 (SKID GEAR)

PRESSURE ALTITUDE = 4,000 FT, OAT = 27 °C (ISA + 20)

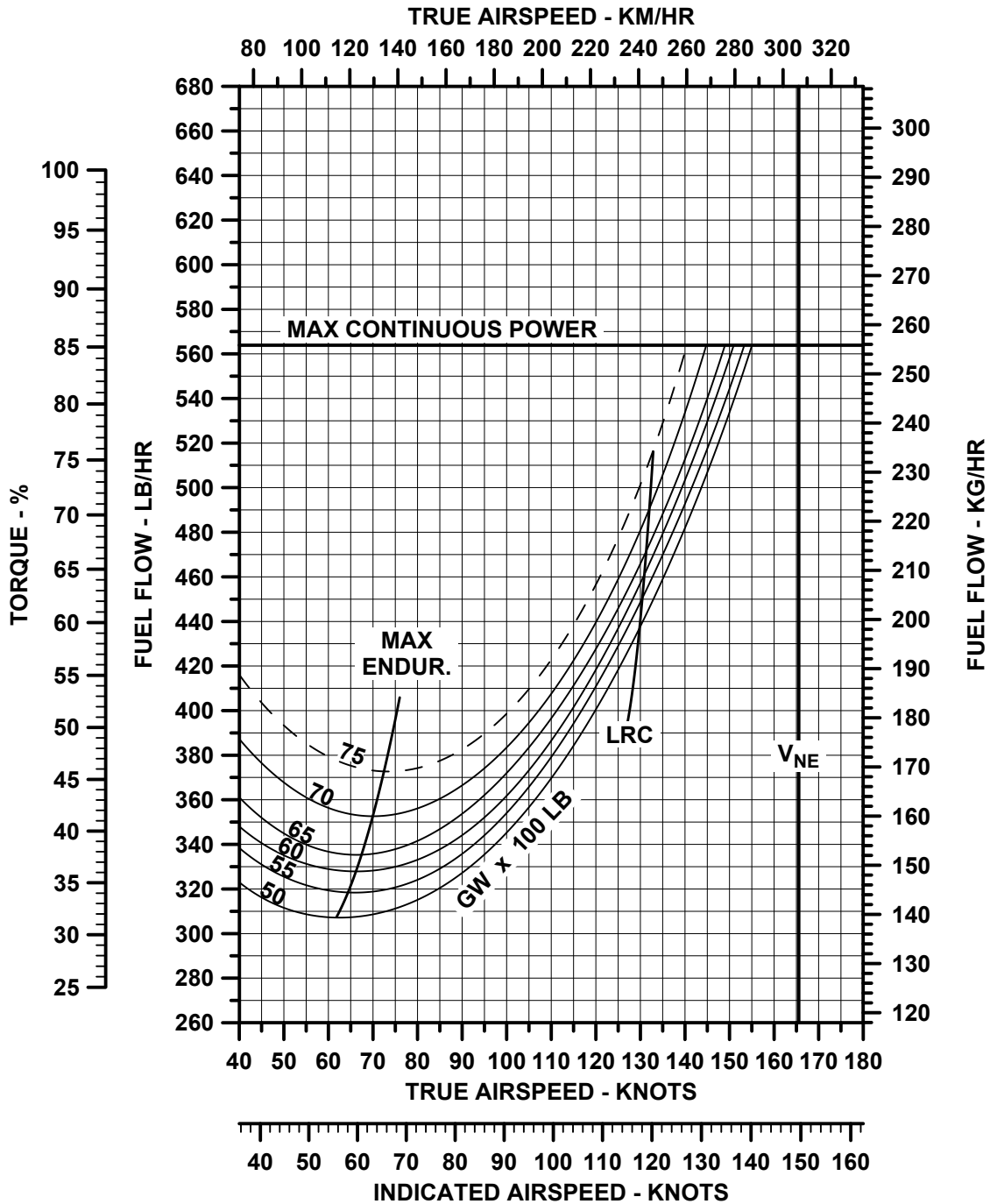

Fuel Flow vs. Airspeed

BELL 429 (SKID GEAR)

PRESSURE ALTITUDE = 6,000 FT, OAT = 23 °C (ISA + 20)

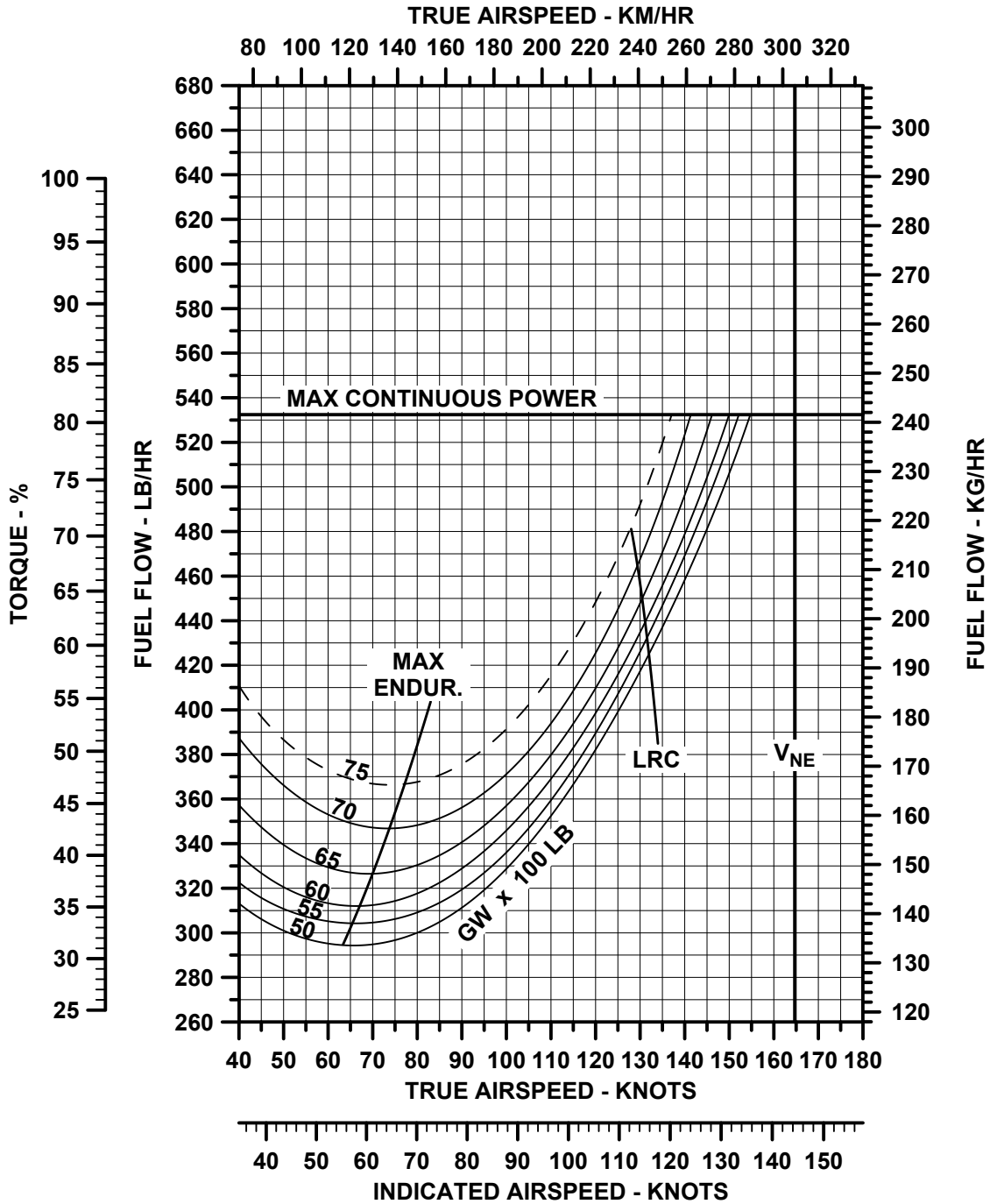

Fuel Flow vs. Airspeed

BELL 429 (SKID GEAR)

PRESSURE ALTITUDE = 8,000 FT, OAT = 19 °C (ISA + 20)

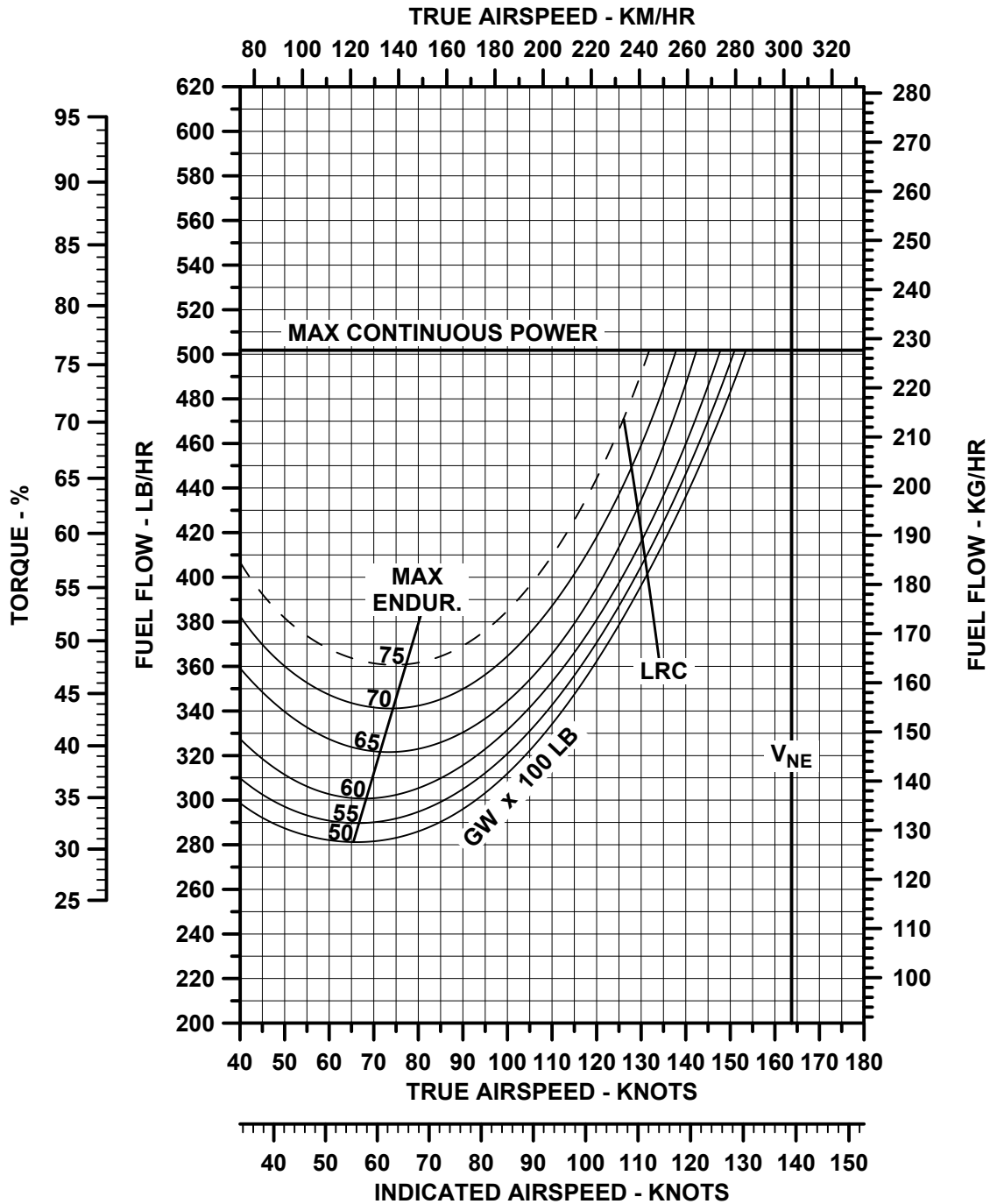

Fuel Flow vs. Airspeed

BELL 429 (SKID GEAR)

PRESSURE ALTITUDE = 10,000 FT, OAT = 15 °C (ISA + 20)

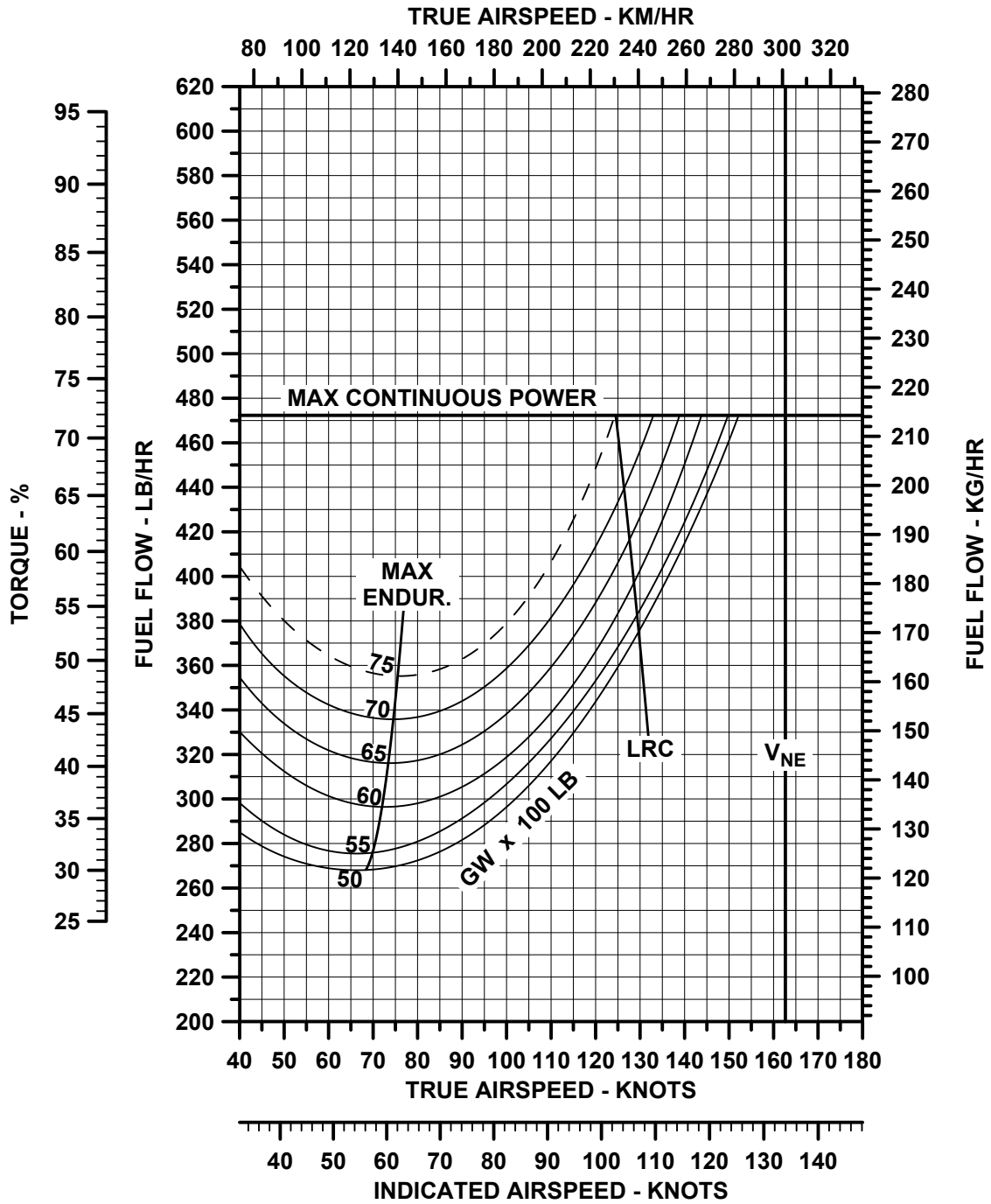

Fuel Flow vs. Airspeed Charts

BELL 429WLG (WHEELED GEAR)

Fuel Flow vs. Airspeed chart data based on the following conditions:

- Pratt & Whitney Canada PW207D1/D2 engines
- Minimum specification engine power
- Basic Inlet or Barrier Filter installed
- Air conditioning off / heater off
- Clean Inlet Filter installed
- Zero wind
- Max continuous power based on new engine



Fuel Flow vs. Airspeed

BELL 429WLG (WHEELED GEAR)

PRESSURE ALTITUDE = SEA LEVEL, OAT = 15 °C (ISA)

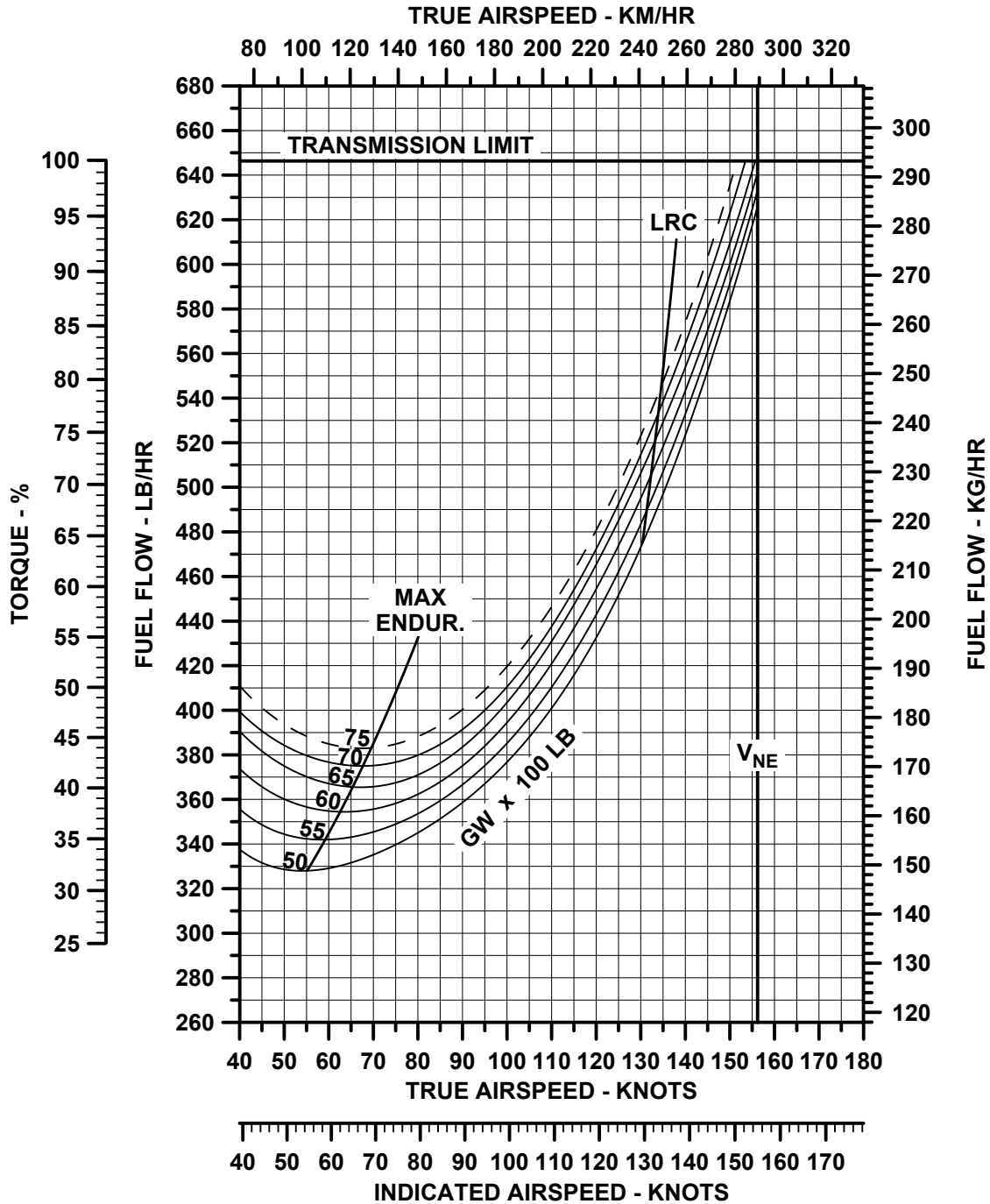

Fuel Flow vs. Airspeed

BELL 429WLG (WHEELED GEAR)

PRESSURE ALTITUDE = 2,000 FT, OAT = 11 °C (ISA)

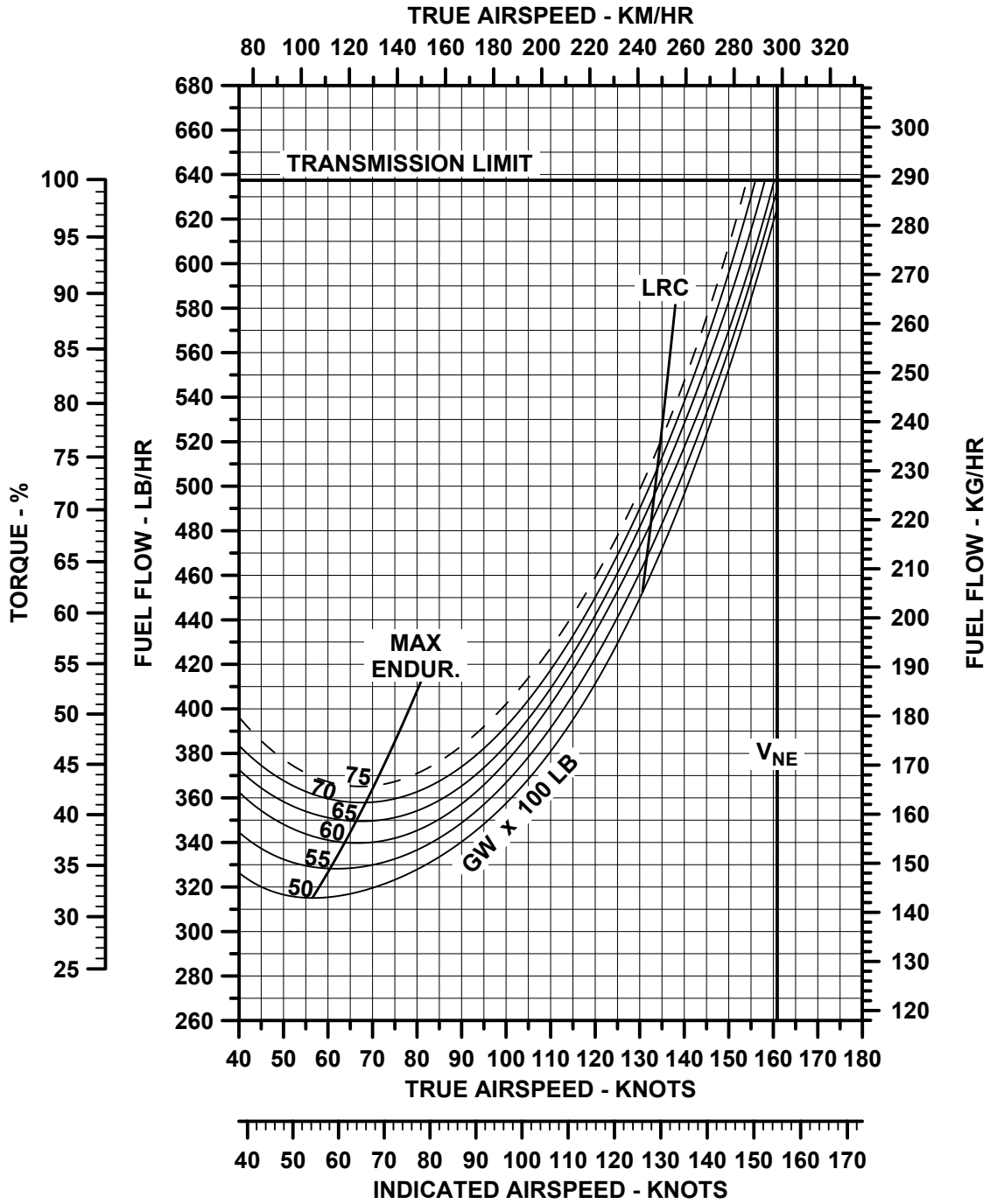

Fuel Flow vs. Airspeed

BELL 429WLG (WHEELED GEAR)

PRESSURE ALTITUDE = 4,000 FT, OAT = 7 °C (ISA)

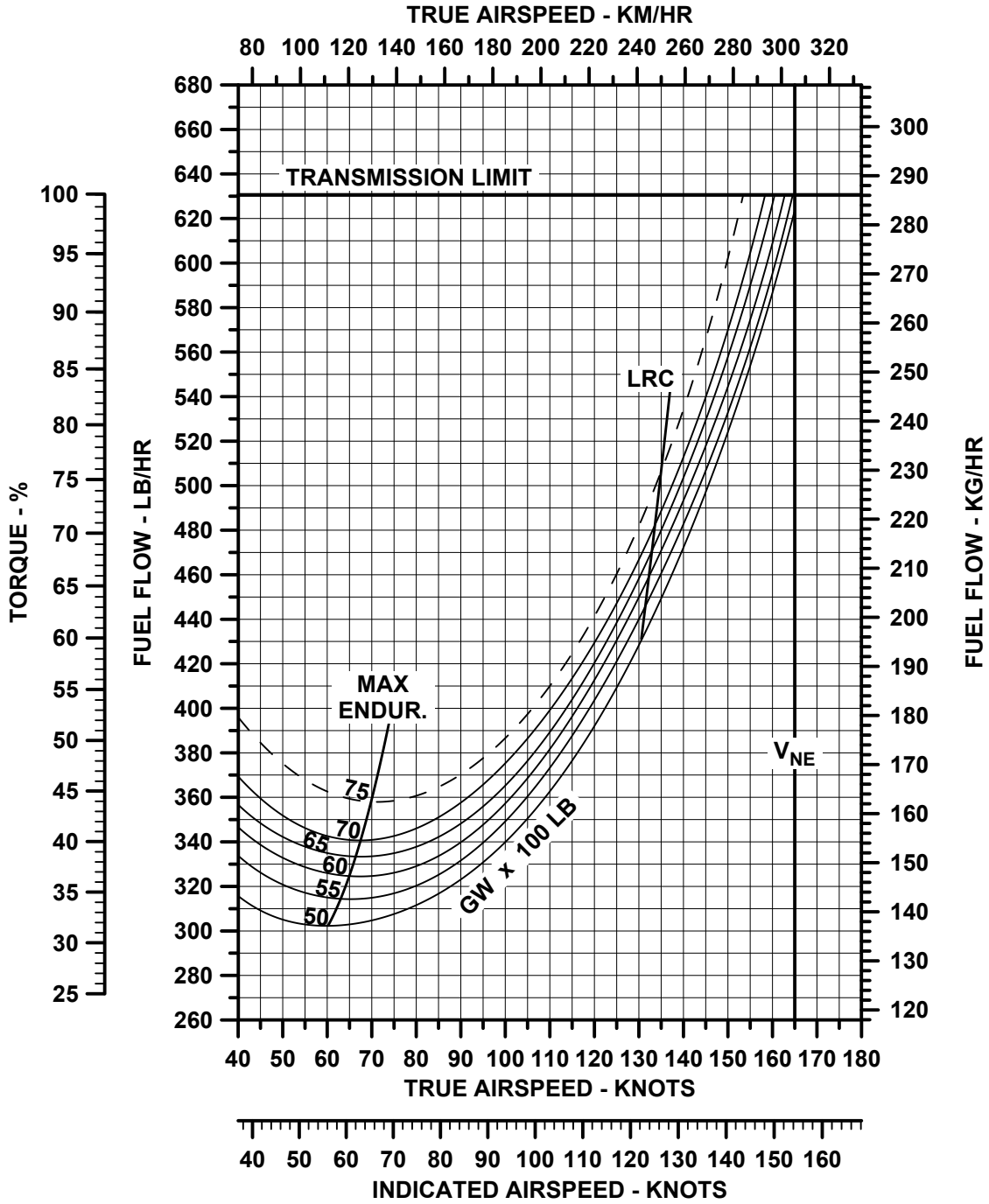

Fuel Flow vs. Airspeed

BELL 429WLG (WHEELED GEAR)

PRESSURE ALTITUDE = 6,000 FT, OAT = 3 °C (ISA)

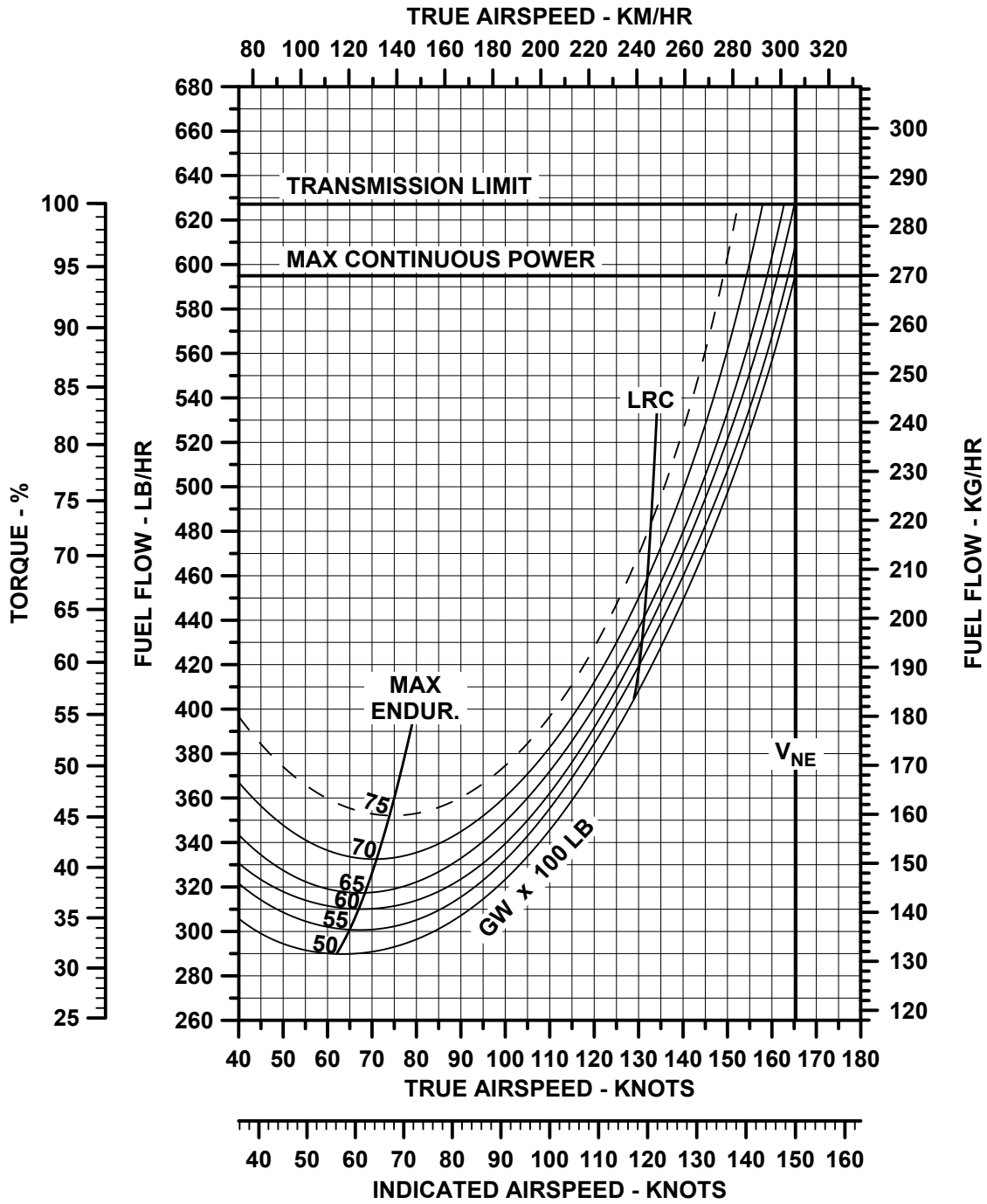

Fuel Flow vs. Airspeed

BELL 429WLG (WHEELED GEAR)

PRESSURE ALTITUDE = 8,000 FT, OAT = -1 °C (ISA)

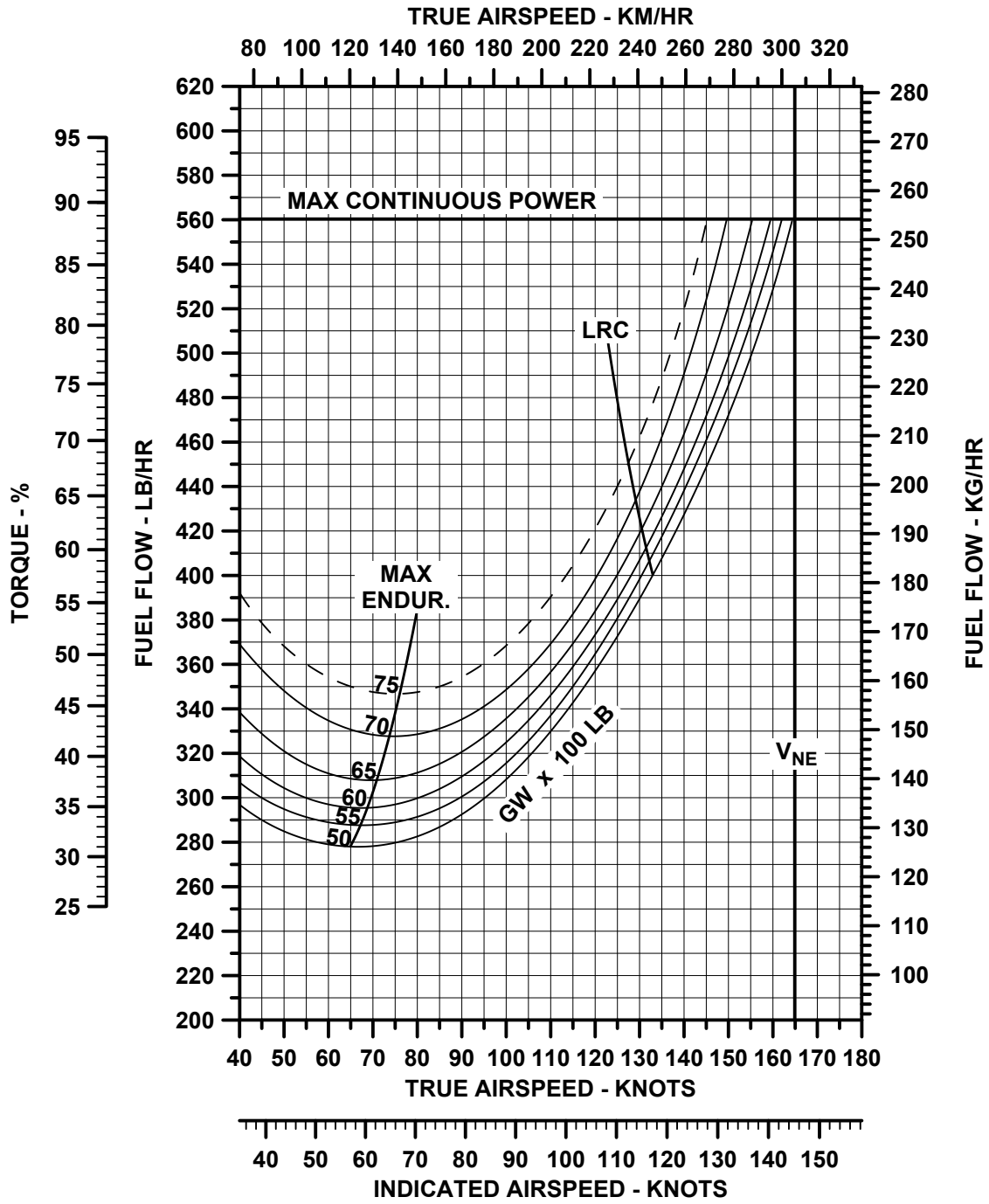

Fuel Flow vs. Airspeed

BELL 429WLG (WHEELED GEAR)

PRESSURE ALTITUDE = 10,000 FT, OAT = -5 °C (ISA)

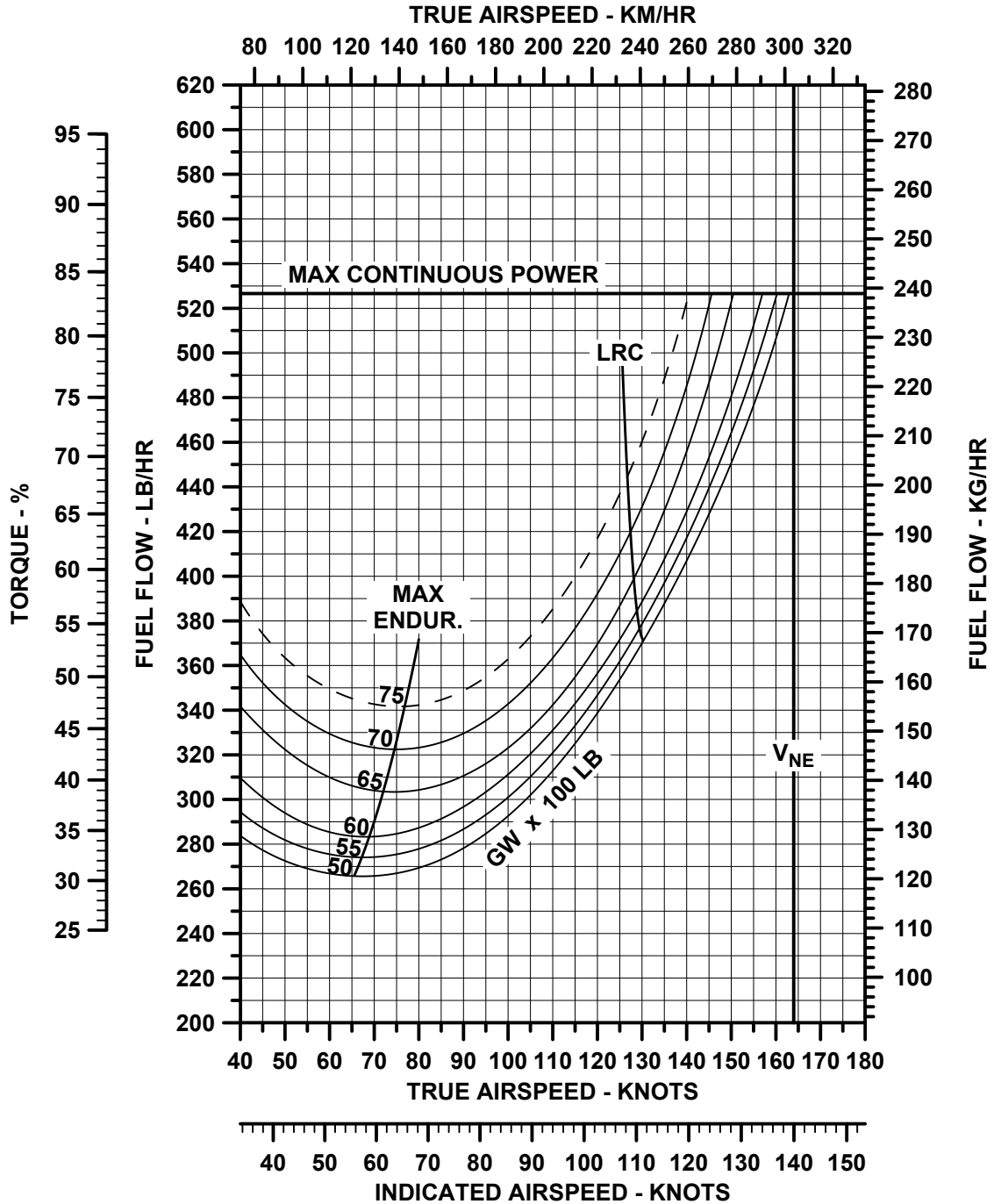

Fuel Flow vs. Airspeed

BELL 429WLG (WHEELED GEAR)

PRESSURE ALTITUDE = SEA LEVEL, OAT = 35 °C (ISA + 20)

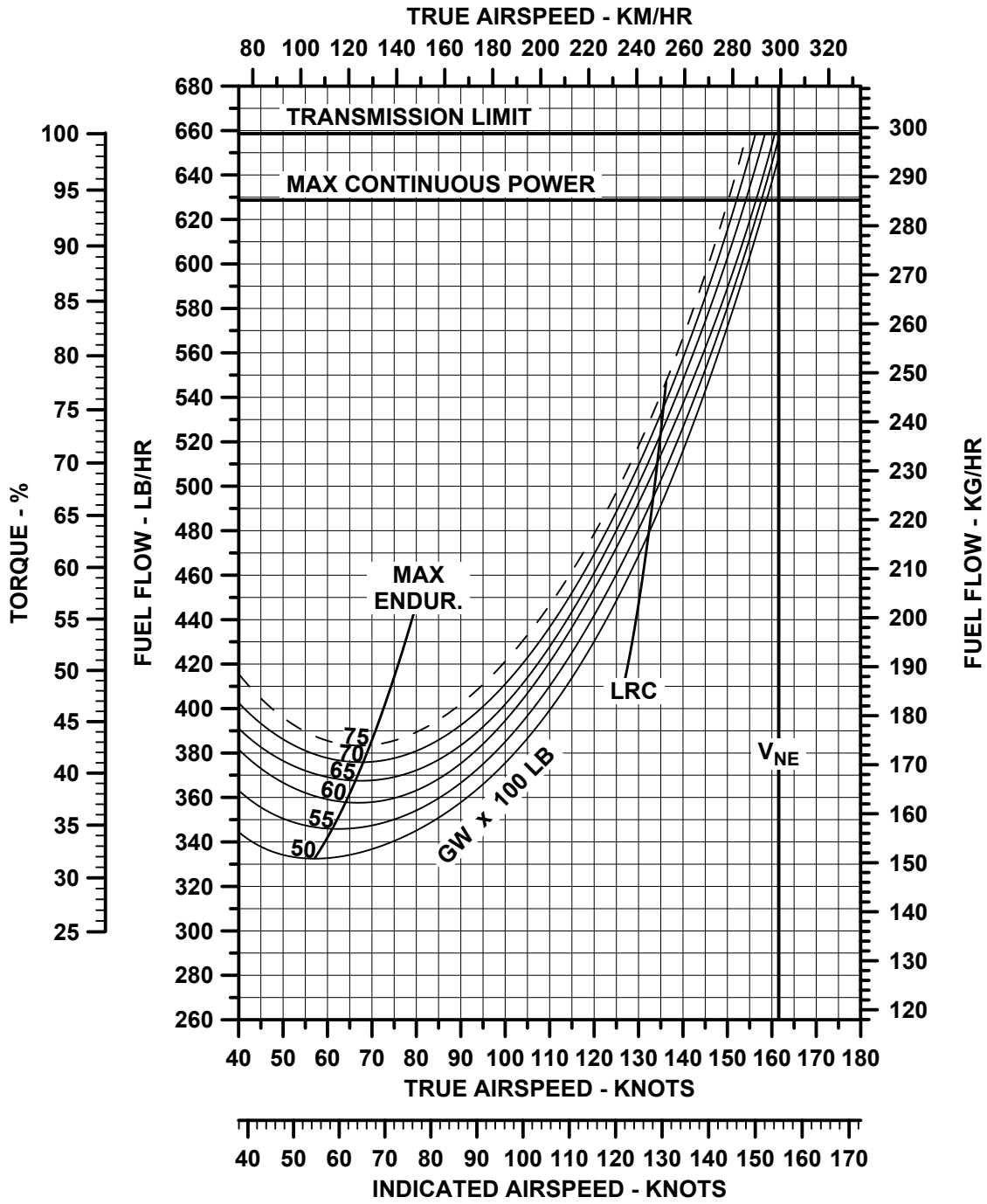

Fuel Flow vs. Airspeed

BELL 429WLG (WHEELED GEAR)

PRESSURE ALTITUDE = 2,000 FT, OAT = 31 °C (ISA + 20)

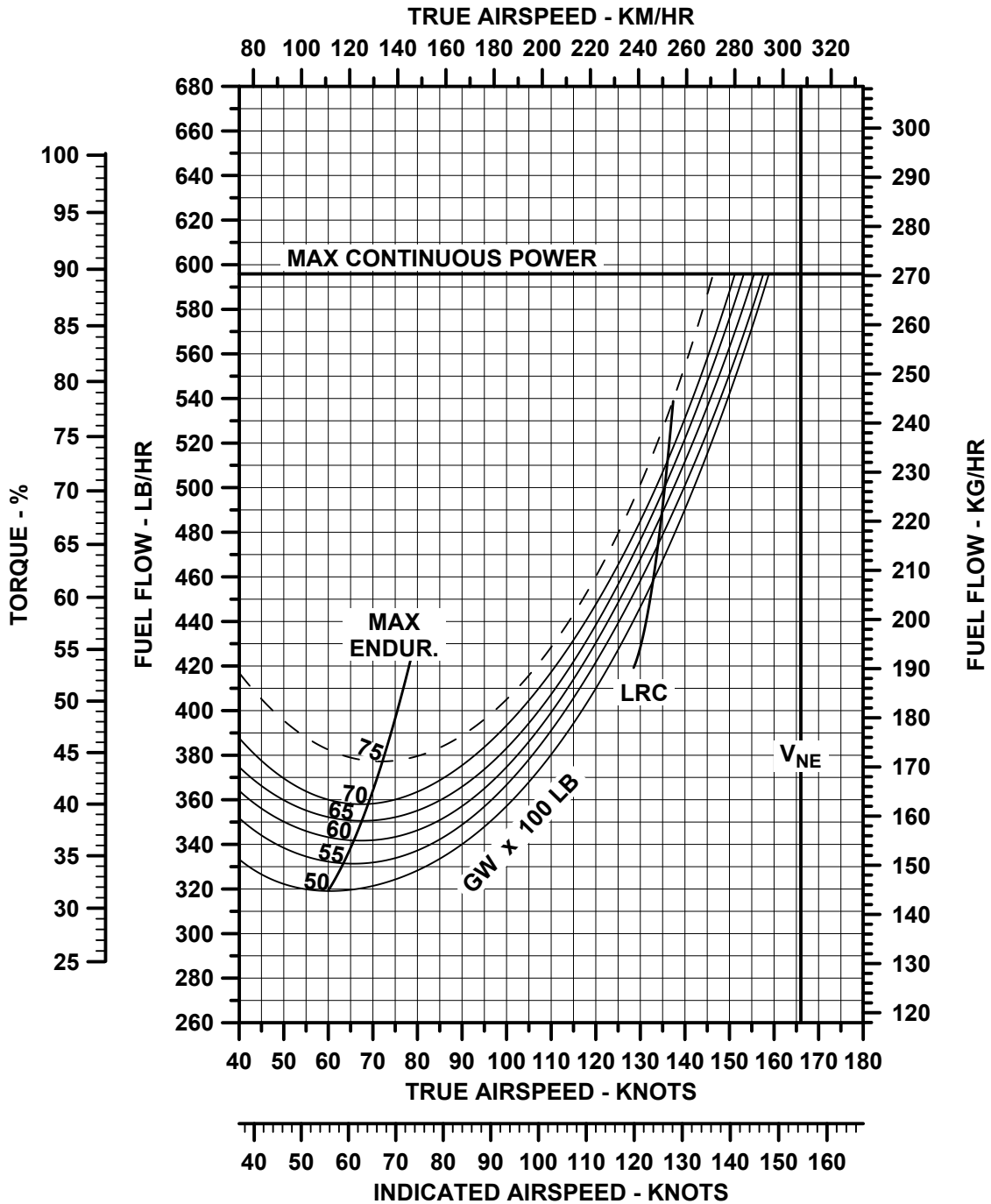

Fuel Flow vs. Airspeed

BELL 429WLG (WHEELED GEAR)

PRESSURE ALTITUDE = 4,000 FT, OAT = 27 °C (ISA + 20)

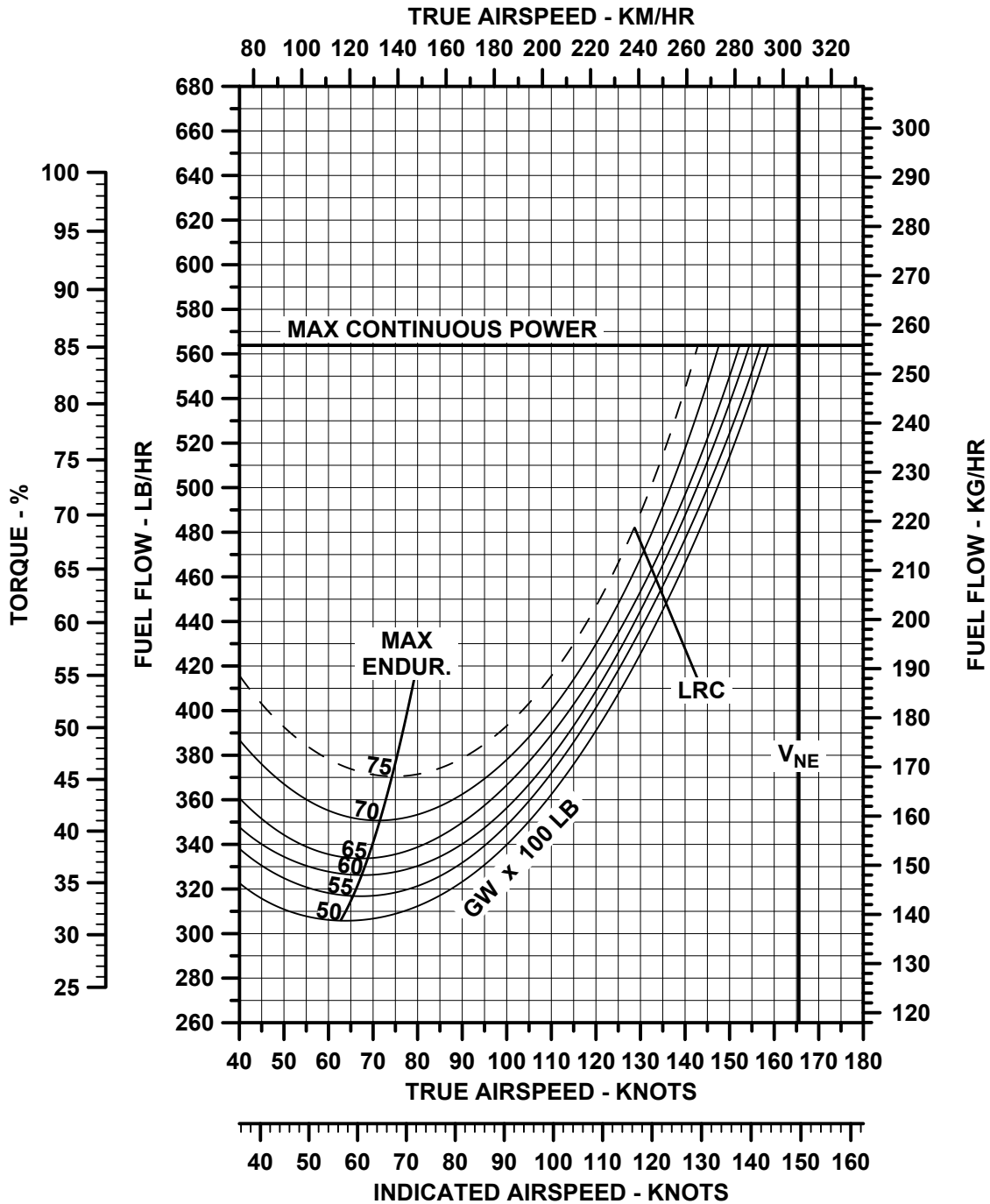

Fuel Flow vs. Airspeed

BELL 429WLG (WHEELED GEAR)

PRESSURE ALTITUDE = 6,000 FT, OAT = 23 °C (ISA + 20)

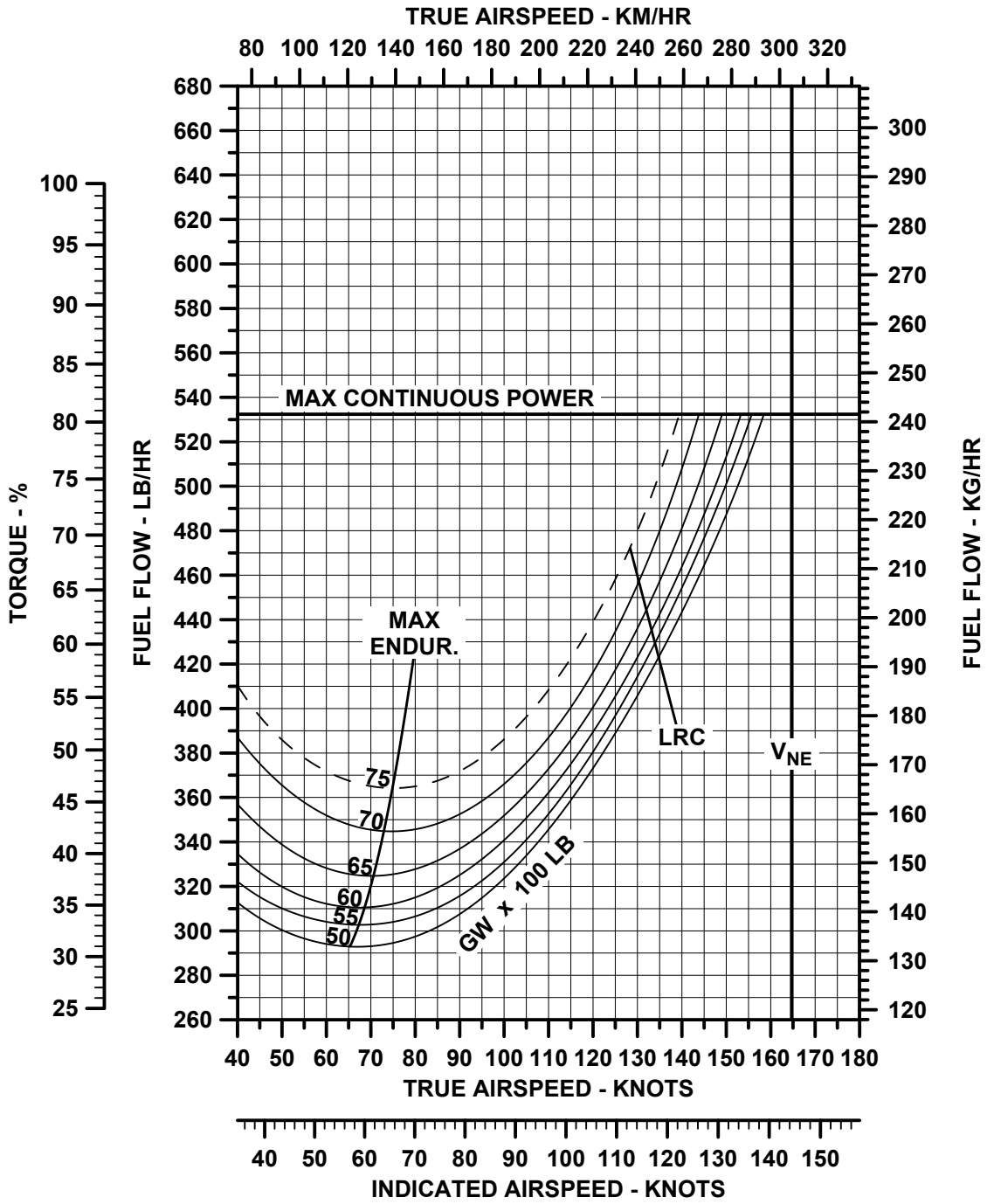

Fuel Flow vs. Airspeed

BELL 429WLG (WHEELED GEAR)

PRESSURE ALTITUDE = 8,000 FT, OAT = 19 °C (ISA + 20)

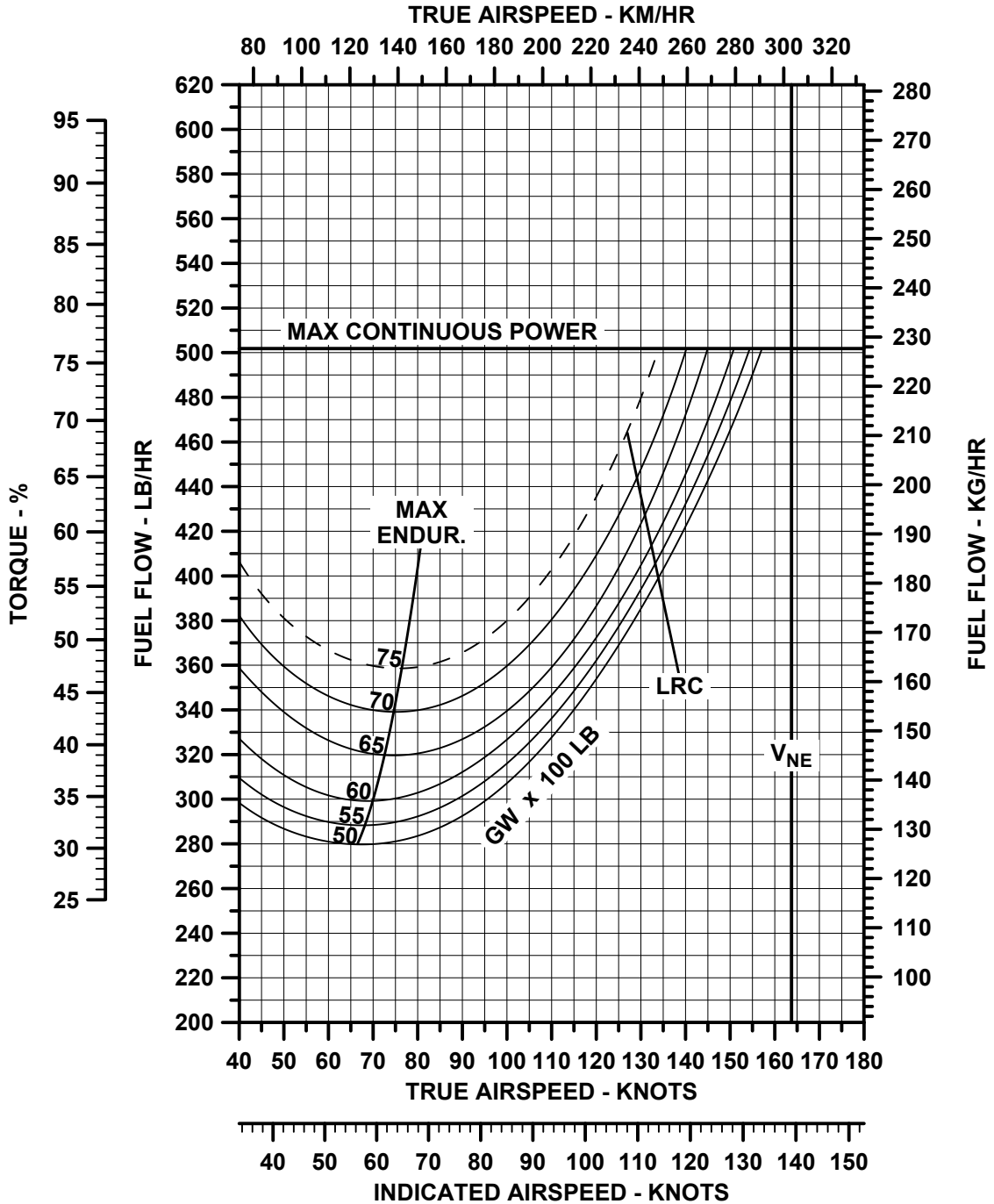

Fuel Flow vs. Airspeed

BELL 429WLG (WHEELED GEAR)

PRESSURE ALTITUDE = 10,000 FT, OAT = 15 °C (ISA + 20)

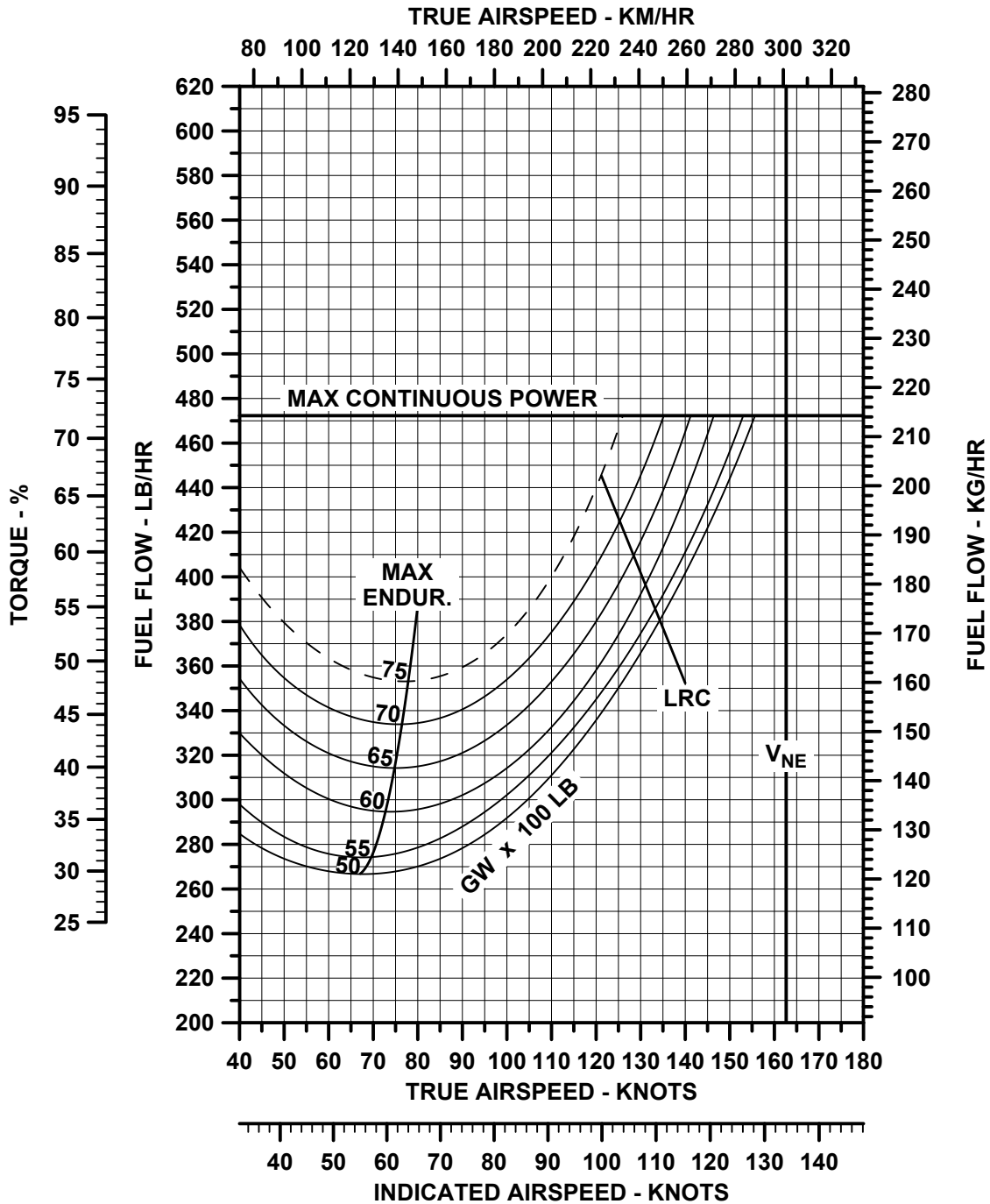

Cost of Operations

INTRODUCTION

Bell Textron Inc. cost of operations data for current production helicopters is based on information from Bell operators and service facilities. BTI's Product Support organization accumulates cost data from a diverse group of operators - large, small; sub-polar, subtropical; inland, coastal; corporate, charter. This information is analyzed to generate sample data for each production model which are averages of the field experience. BTI intends to continue monitoring actual costs and product improvements to enable annual updates of the data to maintain its currency. The following discussion is provided to review the variables involved in the helicopter's direct and indirect cost of operations as well as its cost of ownership.

The total cost of helicopter ownership and operation involves both direct and indirect costs. The direct costs are those which are incurred essentially by the flight hour and include:

- Fuel, Lubricants
- Basic Airframe Maintenance
- Powerplant Maintenance

The indirect costs are not directly dependent upon the number of hours flown and include:

- Insurance
- Facilities (hangar, workshop, etc.)
- Crew Compensation
- Financial Factors (depreciation, investment tax credit, financing costs, etc.)

DIRECT COSTS

Fuel, Lubricants	A typical average value of fuel and lubricant costs is included in the sample data provided for each model. Fuel consumption depends upon speed, temperature, externally-mounted accessories, sling loads, etc. A band of approximately 10% more or less than sample value will cover these factors for normal operations. Fuel pricing varies considerably based on where the fuel is purchased geographically and whether it is purchased retail or in bulk. The sample cases use average retail purchase price prevalent at the time of the sample data are prepared.
Basic Airframe Maintenance	<p>Airframe maintenance is divided into four categories:</p> <ul style="list-style-type: none"> • Periodic Inspections • Overhauls • Replacement of Retirement Parts • Unscheduled <p><u>Periodic inspections</u> include those inspection tasks, with their part requirements, listed in the Maintenance Manual for each model. Man hours for periodic inspections can vary from the sample value provided because of differences in personal experience, tool and parts availability, facilities, environmental effects such as extremes in working temperatures. Man hour costs/hour are also variable among the Authorized Service Centers as a result of differences in local costs, overhead expenses and volume of work. The sample value is an average of costs per hour at Authorized Service Centers at the time of publication.</p>

Cost of Operations

DIRECT COSTS

<p>Basic Airframe Maintenance (continued)</p>	<p><u>Overhauls</u> include removal, disassembly, inspection, parts replacement, reassembly and reinstallation of certain components/assemblies at the periods stated in the BTI Maintenance Manual. Overhaul man hour and parts requirements are subject to considerable variation depending upon the helicopter’s operations and environments. The sample data reflect average values.</p> <p><u>Retirement parts</u> are those which are subject to disposal after an operating time stated in the Maintenance Manual. These are normally components of the rotors/control systems which are subject to oscillatory loads and are designed and tested for use over a finite number of flight hours rather than on their condition. The replacement at the required intervals requires some labor which is included in the man hour data in the sample.</p> <p><u>On-condition/Unscheduled maintenance</u> encompasses labor and parts replacement for major maintenance not covered under the formal Maintenance Manual requirements for scheduled part retirements, periodic inspections and overhauls. It also includes those additional maintenance requirements imposed by the manufacturer through issue of Service Bulletins.</p> <p>The sample data for periodic inspections provide for some minor unscheduled maintenance tasks resulting from the inspection.</p>
<p>Powerplant Maintenance</p>	<p>The powerplant (engine) requires periodic inspection and overhauls. The overhaul periods are based on the number of operating hours or on the number of cycles, whichever is the first limit to be attained. Start cycles are a factor because thermal cycles are important in the design of the turbine engine’s rotating components. Overhauls are performed by the engine manufacturer and/or at authorized facilities. Powerplant overhaul can be performed for the engine as a unit, or in some cases for individual modules. (Modules can be gearbox, compressor, turbine, for example.) Each module can have its own overhaul period. Modular overhaul can be cost-effective for some operations and its use should be evaluated. Engine or module exchanges can be made in lieu of overhaul. For details, contact the engine manufacturer or his authorized distributors/service centers. The sample costs are based on an average exchange. The powerplant may also require unscheduled maintenance (unscheduled removals for repair, parts replacement).</p>

Cost of Operations

The following table is a sample of the Bell 429 direct cost of operations, in U.S. dollars per flight hour. This sample is developed by Bell using the *Guide for the Presentation of Helicopter Operating Cost Estimates* published in 2010 by Helicopter Association International.

SAMPLE BELL 429 DMC (PLUS FUEL ESTIMATE) SUMMARY SCHEDULE

	Parts	Labor ^[1]	Total
AIRFRAME MAINTENANCE			
Scheduled Inspections ^[2]	\$3.18	\$12.43	\$15.15
Scheduled Retirements ^[3]	\$92.42	\$0.86	\$93.28
Scheduled Overhauls ^[4]	\$49.12	\$9.51	\$58.62
Provision for Unscheduled Maintenance and Service Bulletins on above Components	\$18.14	\$1.14	\$19.28
On-condition Maintenance of other Airframe Components	\$101.79	\$77.52	\$179.31
Subtotal	\$264.65	\$101.13	\$365.64
1.06 Mx Man-Hour / Flt. Hr			
POWERPLANT - PRATT & WHITNEY PW207D2 (QUANTITY 2)			
Mfr. Estimate of Engine Cost Per Hour (Includes overhaul, accessories, LL items)			\$148.00
BHT Estimate of Additional Line Maintenance			\$11.74
		Subtotal	\$159.74
		Total DMC	\$525.38
FUEL AND LUBRICANTS			
Fuel ^[5]			\$323.76
Lubricants			\$3.24
		Subtotal	\$327.00
		Grand Total with Fuel	\$852.38

- Notes:
- [1] Labor rate figured at \$95.00 per hour.
 - [2] Based on 625 flight hours / year, 1.5 RIN/flight hours
 - [3] Based on 100% Life.
 - [4] Based on 100% TBO.
 - [5] Calculated at 76 GPH at \$4.26 per gallon.
 - [6] The costs above were calculated as of 02/2022 and are subject to change.

Other assumptions: Basic VFR helicopter with no optional equipment installed;
Mature helicopter (no warranty considerations);
Bell list price for spare parts.

Recommended fuels: ASTM-D-1655, Type Jet A, Jet A-1, and Jet B; MIL-DTL-5624 Grade JP-4 and Grade JP-5;
and MIL-DTL-83133 Grade JP-8

Cost of Operations

INDIRECT COSTS

Insurance	Insurance rates are based on a number of factors including claim experience, type of operations, and crew qualifications. Rates can be obtained from insurance agent/broker.
Facilities	Facilities can include hangar, workshop, parts storage area, tools, ground support equipment and administrative area as appropriate to the specific operation.
Crew Compensation	The number of aircrew personnel depends on the individual operation; i.e., whether the normal crew consists of one or two pilots, hours per day flown, backup requirements for illness, vacation, etc. Bell regional marketing managers can advise typical local costs for estimation purposes.
Financial Factors	Funding a helicopter purchase can be accomplished in a variety of ways, including cash, short term note, long term note, partnership, etc. For investment accounting, several depreciation methods also exist; straight line, double declining, sum of the years digits, etc. Value of resale is a significant factor.
Miscellaneous Factors	Staff expenses (other than aircrew and direct maintenance personnel), utilities, office expenses, etc.

OWNERSHIP ANALYSIS PROGRAM

Bell uses the most recently published edition of the Life Cycle Cost computer program provided by Conklin & de Decker Associates, Inc. to determine total ownership costs for an operators planned period of utilization for the aircraft. To request a Life Cycle Cost Analysis, contact your sales representative or call 1-800-FLY-Bell. Bell's regional marketing managers or corporate office personnel will be able to assist in preparing an ownership

analysis which is customized for our customers specific individual conditions and needs.

Limited Life Components

Hours are subject to change without notice. These data are provided for illustration purposes. Consult maintenance documents and BTI spare parts pricing for current, official information.

Part Number ^[1]	Component	Airworthiness Life ^[2]	Qty Per Aircraft
MAIN ROTOR			
429-010-104-105	CF Fitting	8,000	4
429-010-108-105	Grip Assembly	Unlimited	4
429-010-109-101	Drive Plate Assembly	10,000	1
429-010-114-101	Mast Adapter Assembly	10,000	1
429-010-119-101	Blade Bolt	10,000	8
429-310-003-103	Centrifugal Force Bearing ^[12]	8,000 RIN	4
429-310-004-101	Expandable Blade Bolt	10,000	
MAIN ROTOR CONTROLS			
430-010-409-105	Idler Link Assembly M/R	10,000	2
TAIL ROTOR			
429-012-120-101	Hub Drive Coupling	15,000	1
429-012-151-101	Tail Rotor Yoke Assembly	6,000	2
429-016-101-105	Tail Rotor Blade Assembly	5,200	
429-312-103-111/-113/-117/-119	Flapping Bearing, Outboard	15,000	1
429-312-103-109/-115	Flapping Bearing, Inboard	Unlimited	
TAIL ROTOR CONTROLS			
429-012-115-101	Idler Link Assembly	3,500	
429-012-115-105	Idler Link Assembly	Unlimited	
DRIVE SYSTEM			
429-042-102-101	Tail Rotor Output Shaft	20,000	1
PYLON SUPPORT			
427-010-210-105	Rod End Assembly	5,000	2
429-010-201-101	Pylon Beam Assembly, Left	8,000	
429-010-201-102	Pylon Beam Assembly, Right	8,000	
429-010-204-101	Pitch Restraint Spring Assembly	5,000	2
429-040-203-101	Transmission Top Case	8,000	
429-040-225-101	Adapter, Left	15,000	1
429-040-225-102	Adapter, Right	15,000	1
429-310-201-105	Pitch Restraint Spring	5,000	
SKID LANDING GEAR			
429-700-101/-102	Skid Tube Assembly ^{[3] [4] [5] [6] [7]}	16,000 RIN	1

Limited Life Components

Part Number ^[1]	Component	Airworthiness Life ^[2]	Qty Per Aircraft
429-030-586-107	Skid Tube Assembly ^{[3] [4] [5] [6] [7]}	16,000 RIN	1
429-712-101	Forward Crosstube ^{[3] [4] [5] [8] [9]}	10,000 RIN	1
429-723-108	Aft Crosstube ^{[3] [4] [5] [10] [11]}	30,000 RIN	1
FUSELAGE			
429-030-301-105	Roof Beam, Left	18,000 or 50,000 RIN	
429-030-302-105	Roof Beam, Right	18,000 or 50,000 RIN	

- Note:
- [1] Applies expected life limit of 39,000 RIN. DOC uses a 1/3 penalty of that value assuming 5 RIN per hour = 5,000 hour effective life.
 - [2] Airworthiness life in hours unless otherwise indicated.
 - [3] Aeronautical Accessories part.
 - [4] For every normal landing, add 1 RIN to the previous total.
 - [5] A run-on landing is defined as one where there is forward ground travel of the helicopter greater than 3 feet (0.91 m) with weight on skids.
 - [6] For every 1 run-on landing, add 81 RIN to the previous total.
 - [7] For every one autorotation landing, add 117 RIN to the previous total.
 - [8] For every one run-on landing, add 50 RIN to the previous total.
 - [9] For ever one autorotation landing, add 118 RIN to the previous total.
 - [10] For every one run-on landing, add 32 RIN to the previous total.
 - [11] For ever one autorotation landing, add 186 RIN to the previous total.
 - [12] When one or both engines are started, add 1 RIN to the previous total.

Global Support Network

As the industry leader in customer support, we at Bell pride ourselves on supporting our customers around the world at every step of your aircraft's life cycle. We are committed to providing customers with an extensive range of support and service capabilities to ensure safe and reliable operation of our products, enhance mission execution, and keep you flying.



SUPPORT AND SERVICE OFFERINGS

2

Straightforward Customer Advantage Plans (CAP) covering basic aircraft configuration with optional coverage for non-standard kits

4,000

Parts offered through the Aeronautical Accessories brand

and

10

Bell service centers around the world with wide ranging maintenance, repair and overhaul capabilities

1,200

Unique Supplemental Type Certificates (STCs), all of which comply with FAA regulations and meet rigorous internal quality standards

3

Bell Training Academy locations around the world with expert instructors who offer industry-leading pilot and technical training

85

Network Service Partners with the ability to perform a wide range of aircraft services

Global Support Network

CUSTOMER ADVANTAGE PLANS (CAP)

CAP safeguards your direct maintenance costs and provide the ultimate in cost predictability. The plans protect your investment and provide confidence of knowing you're backed by the industry leader in customer support. With coverage options for non-standard kits, our customers experience the Bell Advantage.

SIMPLE COMPREHENSIVE PLANS

Bell offers two simple CAP options: Standard and Premier Plans.

Both offer holistic coverage of the standard helicopter configuration, with optional coverage for non-standard kits. Standard and Premier Plans are both designed to provide peace-of-mind that your aircraft is protected from day one of your aircraft ownership. Why overcomplicate your OEM support?

Peace of Mind



DMC competitive



Residual value protection



Optional non-standard kit coverage



Improved financing terms



Preferred rates for aircraft serviced by any of the 100+ Bell Customer Service Facilities (CSFs)



Reduced part replacement and repair time



Streamlined budgeting



Fleet customers may be eligible for no 'Buy-Ins'

PREMIER ACCESS TO INCREASE AIRCRAFT AVAILABILITY

CAP members have preferred access to Bell's dedicated rotatable pool of parts. This inventory reduces traditional repair or replace turnaround times.

**Upon sale of aircraft, any remaining funds in the aircraft's Premier CAP account may be transferred with execution of new contract.*

Global Support Network

CAP FEATURES

		Premier	Standard
Typical Customer	Aircraft ownership	New aircraft, fielded, or fleet customers	New aircraft only
	Annual flight hours	High	Low
Coverage	Standard helicopter configuration parts	✓	✓
	Optional coverage for kits installed by Bell	✓	✓
	Optional OEM engine coverage	Varies by model	
	Parts used for scheduled maintenance	✓	
	Parts used for unscheduled maintenance	✓	✓
	Life-limited component coverage	✓	
	Overhauls	✓	
	OEM-original or authorized parts	✓	✓
	Alert Service Bulletins	✓	✓
Contract	Minimum annual flight hours	No minimum	No minimum
	Renewable	✓	
	Transferable	✓ *	✓ **
	Choice pricing under warranty	✓	✓
Support	Access to Bell Customer Portal	✓	✓
	On-site technical assistance	✓	✓
	24/7/365 Aircraft on Ground (AOG) support	✓	✓

* Upon sale of aircraft, any remaining funds in the aircraft's Premier CAP account may be transferred with execution of a new contract.

** Conditions may apply

NEW AIRCRAFT COVERAGE

CAP provides the confidence of knowing you're backed by the industry leader in customer support. For new aircraft, the plans are designed to provide peace-of-mind that your aircraft is protected from day one of your aircraft ownership.

KEY BENEFITS



LOWER RATES
DURING WARRANTY



SAVINGS ON OVERALL AIRCRAFT
SUPPORT



RESIDUAL VALUE
PROTECTION ON AIRCRAFT

To learn more about how CAP can assist you with your aircraft operations, please contact CAP@bellflight.com or contact your Bell Sales Representative.

Global Support Network

SERVICE CENTERS

Bell’s Global Support Network provides customers with a complete and seamless support system offering a full service experience anywhere in the world.

With a suite of available services including aircraft customizing, maintenance repair and overhaul, and Bell warranty work, our service centers offer direct OEM support in every corner of the world.

GLOBAL AFTERMARKET SUPPORT

		Piney Flats, TN	Miami, FL	Ozark, AL	Singapore	Prague	China	Mirabel, Canada	Broussard Blades	Broussard Composite Panels	RBI Hawker (UAE)	RBI Hawker (Australia)	RBL (United Kingdom)
Component Repair & Overhaul Capabilities	Expanded repair	●	●	●	●	●	●	▲					
	Transmission	●	●	●	●	●	▲	▲					
	Hubs	●	●	●	●	●	▲	▲					
	Avionics	●	▲	●	▲	●	●	▲					
	Rotor blades	▲	▲	▲	▲	▲	▲	▲	●		●	●	●
	Composite panels	▲	▲	▲	▲	▲	▲	●		●			
Additional Capabilities	Aircraft customizing	●	▲	●	●	●	●	●					
	Retrofits modifications & upgrades	●	●	●	●	●	●	●					
	Approved installer of Aeronautical Accessories parts & accessories	●	●	●	●	●	●	●					
	Aircraft Paint Services	●	▲	●	●	●		●					
	Field maintenance & repair (Remote)	●	●	●	●	●	●	●	●		●		●
	Bell maintenance training	●			●			●					
	Bell warranty work	●	●	●	●	●	●	●	●	●	●	●	●
	Engine support & rental program		▲		▲		▲						

- In-House Capabilities
- ▲ Outside Services

For more information on each facility visit: bell.co/MRO

Global Support Network

CUSTOMER SERVICE FACILITIES (CSF)

In addition to our 10 service centers, Bell has a strong network of more than 70 Authorized Customer Service Facilities (CSFs). These award-winning facilities enhance the accessibility of in-region global support and ensure that your aircraft is ready whenever and wherever you need it.

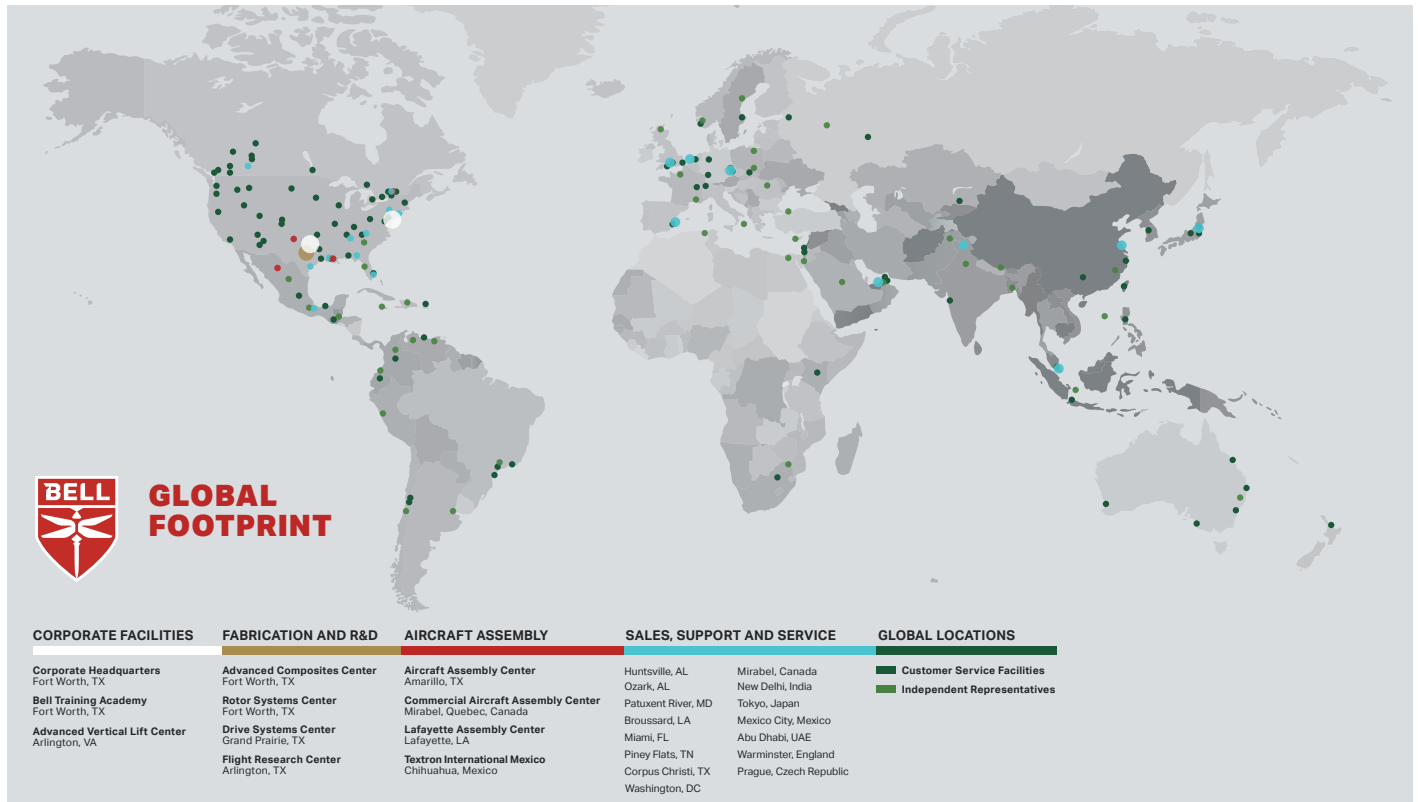

QUALITY ASSURED AND OEM APPROVED

Customers who choose an authorized CSF for maintenance, repair and overhaul work can be assured that both the staff members and the facility itself meet Bell's stringent internal standards for quality and safety. Authorized CSFs have factory-trained maintenance technicians and are equipped with the skills and expertise required to process Bell warranty claims. In addition, these facilities maintain guaranteed parts inventories to service aircraft and possess the most up-to-date technical and safety information available. All of this combines to provide in-region support you can trust.

Training

BELL TRAINING ACADEMY (BTA)

BellFlight.com/Training

Bell’s global training solutions are designed to equip customers with the knowledge and skills necessary to safely and efficiently perform their missions. Since 1946, the BTA has been committed to providing industry leading training programs that create better, safer flight operations. The BTA staff of highly skilled professional pilot and technical instructors leverages OEM data and expertise to deliver the finest helicopter training in the world. We continue to develop innovative programs that will take our customers’ pilot and technical skills to a whole new level.



The BTA at Bell’s headquarters in Fort Worth, Texas.

Pilot and maintenance training is complimentary with each new aircraft purchase. Supplemental, training courses are available at an additional cost.

STATE-OF-THE-ART TRAINING RESOURCES

Based at the Bell headquarters in Fort Worth, Texas, the BTA combines a track record of excellence with a wide variety of industry-leading amenities.

	<p>#1 Pilot and maintenance training consistently ranked #1 in the industry</p>		<p>375+ Years combined experience among Bell's technical instructors</p>
	<p>25,000+ Square foot maintenance hangar</p>		<p>8,500 Average instructor pilot flight hours</p>
	<p>200,000+ Pilot and maintenance technicians trained</p>		<p>134+ Countries represented by customers in every market segment</p>
	<p>3 Full Flight Simulators for the Bell 407GX, Bell 525 in Fort Worth, Texas, and a FFS for the Bell 429 in Valencia, Spain</p>		<p>6 Advanced Flight Training Devices (FTD) designed to train on seven models</p>

Training

The BTA's 80+ staff members welcome students from all over the world, and are eager to share the knowledge gained from decades of hands-on experience within the military and across other professions. Instruction can be provided in English or Spanish. Language translation is available for an additional cost.

Recognized by the European Aviation Safety Agency (EASA) as an Approved Training Organization (ATO), the BTA has the authorization to provide Part-FCL flight training courses to European customers for the 407, 212/412, 429, and 505 models, including the use of Flight Training Devices (FTD) for the Bell 407 and 429 models. A Performance Based Navigation (PBN) Generic Non-Type or 412/429 Type Rating Specific courses are also approved.

The BTA is also authorized by various international regulatory agencies for type-specific technical training of engineers / mechanics. These agencies include the Civil Aviation Authority of Singapore (CAAS), Transport Canada (TC), European Aviation Safety Agency (EASA), Australian Civil Aviation Safety Authority (CASA), Civil Aviation Administration of China (CAAC), Director General Civil Aviation of India (DGCA), and the UAE General Civil Aviation Authority (GCAA).

GLOBAL TRAINING NETWORK

With nearly 70 percent of our commercial aircraft delivered internationally, Bell understands the need for training to be readily available where our customers perform their missions. Our training centers are equipped and certified to meet the needs of our customers around the globe. We are committed to having resources where our customers operate and are investing to provide world-class, global training solutions to meet a growing customer demand.

Europe: All pilot training classes at BTA – Valencia, are instructed upon the Bell 429 EASA-certified Level D Full Flight Simulator (FFS). The Bell 429 FFS by TRU offers the largest standard visual field of view and the largest standard dome radius of any simulator on the market today. Additionally the FFS offers industry-leading motion performance with high-fidelity superior accelerations, smoothness, and responsiveness powered by REALFEEL® Control Loading System and REALVibe™ Secondary Cueing System.

BTA, Valencia, offers three courses with plans for additional class offerings in the coming years. BTA-Valencia offers a 10-day Bell 429 EASA initial type rating and a Bell 429 recurrent course to reinforce the initial type rating. Additionally, BTA-Valencia offers wet and dry leasing that is custom tailored to each operator. For more information on wet and dry leasing please visit bellflight.com/training.

Singapore: BTA Singapore is approved by the Civil Aviation Authority of Singapore (CAAS), European Aviation Safety Agency (EASA), Australian Civil Aviation Safety Authority (CASA), and Director General Civil Aviation of India (DGCA), and the UAE General Civil Aviation Authority (GCAA). BTA Singapore offers regulatory classes for maintenance theory and practical training on all current Bell models and select legacy aircraft. Available courses include avionics maintenance, field maintenance and refresher courses, cable and connector training, and vibration monitoring system training.



Bell training at BTA Singapore.

Training

GENERAL INFORMATION

The operator and maintenance training provided by BTA establishes a foundation that supports mission tasks with aircraft pilot qualification.

Pilot Operator Training: Our pilot training program includes basic academics and initial flight training to transition current pilots into Bell aircraft. All training is conducted by certified Bell instructor pilots.

Maintenance Technician Training: Experience is important, however, instruction received in the classroom and training lab provides an undeniable enhancement. Facilitating more efficient maintenance manpower and improving logistics supportability ensures that the customer's Bell is operational and maintainable in all types of climate and terrain.

Academic training includes both state-of-the-art instructor-led computer presentations and hands-on maintenance training. Mechanical, electrical, and avionics training takes place in a temperature controlled shop and will include use of composite maintenance trainers and avionics bench trainers. The BTA also has operational cutaway mockups, a composite repair room, and an electrical/avionics lab. Over half of the maintenance training is hands-on, skill enhancing, and performance focused instruction. Training is determined complete, as defined by Bell, after each student demonstrates an ability to perform to the course standards for actual maintenance and operation of the equipment referencing technical manuals.

Training Aircraft: The BTA conducts flight training in Bell OEM-owned or newly delivered customer aircraft.

Training Materials and Language: Bell provides each maintenance and pilot training candidate a hard-copy course notebook in the English language for each course conducted by BTA instructor personnel. The training materials will be sufficient to train maintenance technicians and pilots who meet the course prerequisites in the maintenance and operation of the applicable model helicopters. Course instructional electronic media, syllabi, course outlines, and company intellectual property will be considered non-deliverables.

Training Technology: Bell is leading the industry in its use of engineering technology to more effectively teach pilots and maintainers around the world. The use of 3-D rendered, high-fidelity, interactive graphics provide students an authentic representation of each component. Smart Board technology allows for independent media manipulations such as assembly and disassembly of system subassemblies and replication maintenance actions without leaving the classroom. The adoption of 3-D modeling of aircraft components and system assemblies has greatly improved training efficiency by enhancing student retention.



Training

Student Registration: The customer is responsible for submitting an enrollment request for each training candidate via Bell's on-line registration process at www.bellflight.com/training. It is encouraged that all training be scheduled at least ninety (90) days prior to the start of each established course date to ensure space and instructor availability.

Cancellation Policy: The customer agrees to comply with the BTA cancellation policy as set forth at bellflight.com/training.

Trainee Visas: Applying for and receiving a visa for students in a timely manner is the responsibility of the customer. To ensure timely approvals, students must register early.

Trainee Expenses: Arrangements and expenses associated with training, including but not limited to, air travel, ground transportation (car rental/taxi), meals, and lodging for each designated trainee will be the responsibility of the customer.

TRAINING COURSES

The following table summarizes the complimentary training provided with each purchased Bell 429. Additional training options are available at bellflight.com/training.

BELL 429 TRAINING COURSE SUMMARY

Course	Complimentary	Duration
Pilot Training		
Bell 429 Ground and Flight Initial	1	10 days
Bell 429 Ground and Flight Refresher		2 days
Bell 429 Ground and Flight Initial Blended Learning Package (Virtual)		12 days
Bell 429 Ground and Flight Refresher Blended Learning Package (Virtual)		4 days
Bell 429 Left Seat Orientation for Ips		2 days
Bell 429 NVG Ground and Flight Refresher		2 days
Bell 429 ATP (FAA Pat 142)		3 days
Maintenance Training		
Bell 429 Integrated Avionics System		3 weeks
Bell 429 Integrated Avionics System Refresher		3 days
Bell 429 B2		4 weeks
Bell 429 AVII		4 weeks
Bell 429 Field Maintenance (experienced)		2 weeks
Bell 429 Field Maintenance		3 weeks
Bell 429 Field Maintenance Refresher		3 days

COURSE DESCRIPTIONS

Please visit our website at bellflight.com/training for complete course descriptions.



Our Aeronautical Accessories brand offers more than 4,000 parts and 1,200 unique supplemental type certificates (STCs), allowing you to upgrade your aircraft to meet the latest mission requirements.

With a broad selection of competitively priced, proven replacement parts and accessories, Aeronautical Accessories also features outstanding customer service that has been rated the best in the rotorcraft aftermarket.

INNOVATION RELIABILITY & PERFORMANCE

Aeronautical Accessories is dedicated to listening to the voice of the customer in developing new products, focusing on the safety for your passengers and crew, and providing an uncompromising emphasis on quality. Our components meet FAA requirements as well as exacting internal standards and are backed by an exceptional warranty—a benefit of being part of Bell. Aeronautical Accessories is also registered under Bell as a certified ISO 9001 with AS9100 Revision D facility.

GLOBAL AVAILABILITY OF PRODUCTS

Through our global distribution and modern inventory management system, we minimize customer downtime for repairs, refurbishments and completions. Whether you are looking for new landing gear components, a specialty window or replacement interior plastic panels, Aeronautical Accessories has these in-demand items as part of our core product offering. We also can assist your needs with the latest developments in safety and mission equipment – featuring several new products that can take your aircraft to that next level. Our options such as enhanced doors and seating can make those long flights seem shorter, and the extensive choices for specialized lighting are sure to assist in all your flights that take place at night. Aeronautical Accessories' growing product line also features important items such as fuel filtration, floats for missions that occur over water, as well as the best solutions available in ground handling equipment.

WE ARE HERE TO HELP

Whether you are customizing your new aircraft, looking to improve your ship's capabilities, or repurposing your helicopter, Aeronautical Accessories is available to assist. Visit our website www.aero-access.com and learn about all the products we offer. You may also send an email to sales@aero-access.com to reach our Sales & Support team or give them a call at 800.251.7094.

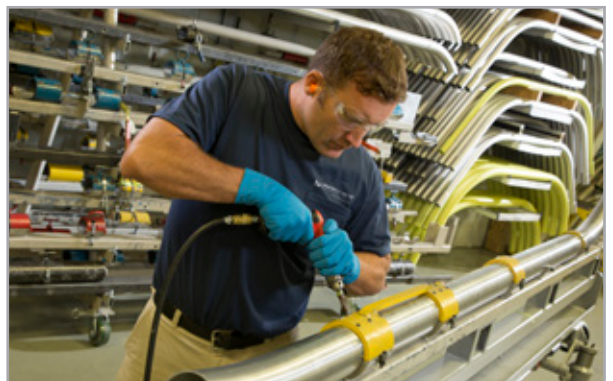

Aeronautical Accessories

BELL 429 FEATURED PRODUCTS

Health Usage Monitoring System (HUMS) Kit

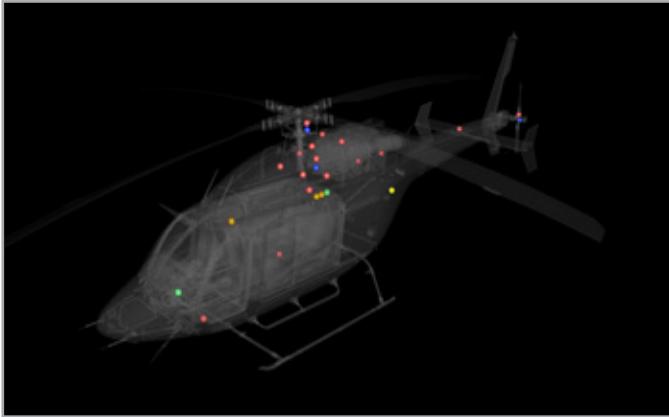

- Provides comprehensive airframe, rotor, engine and drive system vibration monitoring capability
- Aircraft data recording supports customer flight data monitoring (FDM) programs
- Designed to conduct routine vibration management functions, with no changes required in the mandatory maintenance functions of the Bell 429 Maintenance Manual
- Utilizes its vibration monitoring capability to make discretionary rotor and balance adjustments
- No pilot interface is required during flight operations
- Data downloads are manually commanded by pressing the LED array switch located on the PBA panel in the center pedestal

QuantIFLY: A new flight data monitoring system



- Automatic download and analysis through integration of to the ARINC or ADIU and FDR
- Basic data analysis available through Bell MissionLink application
- Advanced analysis available through Truth Data Flight Data Services application

Cargo Net



- Barrier Net Assembly Kit attaches a net to existing fastening points
- Eliminates article migration into the rear access/loading door area

Baggage Area Extender

- Prevents items stored in cargo area from falling into rear faring
- Large footprint makes it well suited for larger, soft, and irregularly shaped items (ex. backpacks, duffel bags, golf bags, etc.)

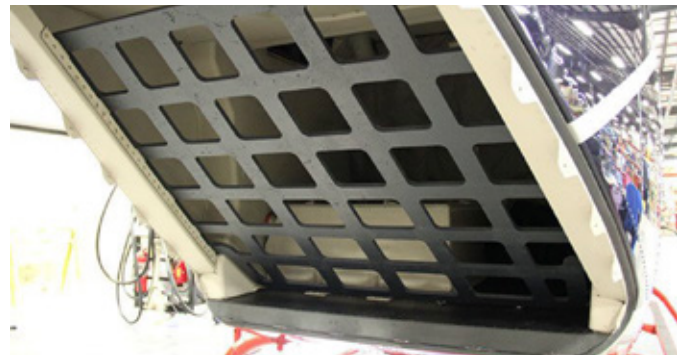

bellflight.com

© 2022 Bell Textron Inc. All registered trademarks are the property of their respective owners. The information herein is general in nature and may vary with conditions. Individuals using this information must exercise their independent judgment in evaluating product selection and determining product appropriateness for their particular purpose and requirements. For performance data and operating limitations for any specific mission, reference must be made to the approved flight manual. CML_429_SPCP_8.5x11_220323-R06_EN