

SPECIFICATIONS



BELL 412EPI





Publisher's Notice

The information herein is general in nature and may vary with conditions. Individuals using this information must exercise their independent judgment in evaluating product selection and determining product appropriateness for their particular purpose and requirements. For performance data and operating limitations for any specific mission, reference must be made to the approved flight manual. Bell Helicopter Textron Inc. makes no representations or warranties, either expressed or implied, including without limitation any warranties of merchantability or fitness for a particular purpose with respect to the information set forth herein or the product(s) and service(s) to which the information refers. Accordingly, Bell Helicopter Textron Inc. will not be responsible for damages (of any kind or nature, including incidental, direct, indirect, or consequential damages) resulting from the use of or reliance on this information. Bell Helicopter Textron Inc. reserves the right to change product designs and specifications without notice.

© 2019 Bell Helicopter Textron Inc.

All registered trademarks are the property of their respective owners.

Table of Contents

Bell 412EPI.....	1
Specification Summary (U.S. Units)	2
Specification Summary (Metric Units).....	3
Helicopter Dimensions.....	4
Bell BasiX-Pro™ Integrated Avionics System.....	6
Automatic Flight Control System	9
Safety Enhancements.....	10
Lighting and Controls.....	11
Extended Hover Performance (EHP) Kit	11
BLR Strake and FastFin®	12
Increased Gross Weight (IGW) Kit	12
Seating and Interiors.....	13
Mission Profiles.....	15
External Paint Schemes	17
Basic Bell 412EPI Configuration.....	18
Bell 412EPI Optional Accessories	21
Helicopter Performance Charts	25
Fuel Flow vs. Airspeed Charts	41
Cost of Operations.....	48
Component Overhaul.....	51
Limited Life Components	52
Customer Support and Services.....	54
Training	59
Aeronautical Accessories.....	63

Bell 412EPI

ELECTRONIC ENGINE CONTROL AND GLASS COCKPIT

The Bell 412EPI is an upgrade to the basic Bell 412EP helicopter, providing an electronically-controlled PT6T-9 engine and Bell BasiX-Pro™ integrated glass cockpit display system. It is a modern version of the helicopter known as the workhorse of the industry with a reputation of getting up and going to work every day in even the most extreme environments. Features are:

- **Electronically-controlled Pratt & Whitney PT6T-9 Twin Pac® engines**
 - Approximately 15% increase in hot day Take-Off power
 - Improved HOGE, CAT-A and PC-2e performance
 - Automatic engine start with Temperature Limiting Features
 - 30-second and 2-minute OEI rating structure with automatic limiting and OEI training mode
 - Allows an Increase in Gross Weight to 12,200 with optional IGW Kit
- **Bell BasiX-Pro™ integrated glass cockpit system**
 - 4 large-screen, high resolution multi-function displays providing EFIS, EICAS and systems displays
 - Bell's patented Power Situation Indicator (PSI) presentation
 - Garmin GTN-750 NAV/COM/GPS with high resolution digital maps, approach plates and more
 - Optional GTN-650 NAV/COM/GPS can complete the Garmin package
 - Approved WAAS GPS instrument approach capability
 - Common operation, equipment, support with BasiX-Pro™ system on Bell 429
- **Ease of integration / missionization for weather radar, search radar, HTAWS, TCAS, ADS-B with traffic, FLIR, video displays, and velocity/hover indication**
- **Fully integrated with Autopilot / Flight Director optimized for professional IFR operation – Single or Dual pilot, 3-axis or 4-axis**



The Bell 412EPI Glass Cockpit

Specification Summary (U.S. Units)

WEIGHTS (lb)

Empty Weight (IFR standard configuration) ^[1]	7,071	Maximum Gross Weight (internal/external)	11,900
Useful Load (base aircraft, internal)	4,829 / 5,129 ^[2]	Maximum Gross Weight (internal/external) ^[2]	12,200
Maximum External Load	4,500		

PERFORMANCE SUMMARY (International Standard Day except as noted)

			Takeoff Gross Weight (lb)			
			9,500 ^[3]	10,500 ^[3]	11,900 ^[3]	12,200 ^[2]
IGE Hovering Ceiling	ISA	ft	17,600	15,000	11,400	11,700
	ISA + 20 °C	ft	15,500	12,600	8,300	8,800
OGE Hovering Ceiling	ISA	ft	15,300	12,500	6,700	5,500
	ISA + 20 °C	ft	13,000	9,700	4,400	3,300
FAA Takeoff and Landing Limit, (WAT)	ISA	ft	14,000	11,270	7,270	7,110
	ISA + 20 °C	ft	11,730	9,000	4,990	4,840
Service Ceiling (AEO) (continuous OEI)	ISA	ft	20,000	18,970	16,320	15,720
	ISA	ft	14,100	11,960	8,870	8,190
Maximum Cruise Speed (true airspeed)	4,000 ft, ISA	ktas	132	130	125	123
Cruise at Long Range Cruise Speed (LRC)						
Range ^[4]	SL, ISA	nmi	371	369	363	361
LRC Speed (average true airspeed)		ktas	127	126	124	124
Range ^[4]	4000 ft, ISA	nmi	419	413	402	398
LRC Speed (average true airspeed)		ktas	129	129	127	126
Category A Takeoff and Landing Ceiling	ISA	ft	9,900	6,590	2,140	N/A
Backup profile for ground level and elevated helipads	ISA + 20 °C	ft	6,590	5,370	650	N/A
Category A Takeoff and Landing Ceiling	ISA	ft	11800	8900	5150	4370
Runway profile	ISA + 20 °C	ft	10020	7030	3020	2250
Endurance at Loiter Speed ^[4]	SL, ISA	hr	4.0	3.9	3.8	3.8
	4,000 ft, ISA	hr	4.5	4.4	4.2	4.2

ENGINE RATING (100% RPM)

			Uninstalled Thermodynamic Capability		Mechanical Limit
Pratt & Whitney PT6T-9 Twin Pack ®	Takeoff (5 minutes)	SHP	2 × 1,122		2 × 928
	Max Continuous Power	SHP	2 × 1,021		2 × 825
	OEI (continuous)	SHP	1 × 1,186		1 × 1,100
	OEI (2 minutes)	SHP	1 × 1,229		1 × 1,150
	OEI (30 seconds)	SHP	1 × 1,280		1 × 1,269

TRANSMISSION RATINGS (100% RPM at mast)

Takeoff (5 Minute)	1,370 SHP
Maximum Continuous Power	1,110 SHP
Single Engine	Limited by Power Available

FUEL (usable)

Type	Aviation Turbine
Capacity	330.5 US gallons

- Notes: [1] IFR Std Config includes all items listed in the Aircraft Configuration table of this document as well as 25 lb of engine oil. Ballast is not included in the standard configuration (ballast is a function of installed equipment).
 [2] Performance with optional Increased Gross Weight kit
 [3] With BLR FastFin® System.
 [4] Standard fuel, no reserve, average gross weight.
 [5] Performance at Increased Gross Weight.

Specification Summary (Metric Units)

WEIGHTS (kg)

Empty Weight (IFR standard configuration) ^[1]	3,207	Maximum Gross Weight (internal/external)	5,398
Useful Load (base aircraft, internal)	2,191 / 2,327 ^[5]	Maximum Gross Weight (internal/external) ^[2]	5,534
Maximum External Load	2,041		

PERFORMANCE SUMMARY (International Standard Day except as noted)

			Takeoff Gross Weight (kg)			
			4,309 ^[3]	4,763 ^[3]	5,398 ^[3]	5,534 ^[2]
IGE Hovering Ceiling	ISA	m	5364	4572	3475	3566
	ISA + 20 °C	m	4724	3840	2530	2682
OGE Hovering Ceiling	ISA	m	4663	3810	2042	1676
	ISA + 20 °C	m	3962	2957	1341	1006
FAA Takeoff and Landing Limit, (WAT)	ISA	m	4267	3435	2216	2167
	ISA + 20 °C	m	3575	2743	1521	1475
Service Ceiling (AEO) (continuous OEI)	ISA	m	6096	5782	4974	4791
	ISA	m	4298	3645	2704	2496
Maximum Cruise Speed (true airspeed)	1,219 m, ISA	km/h	244	241	232	228
Cruise at Long Range Cruise Speed (LRC)						
Range ^[4]	SL, ISA	km	687	683	672	669
LRC Speed (average true airspeed)		km/h	235	234	230	229
Range ^[4]	1,219 m, ISA	km	775	764	744	737
LRC Speed (average true airspeed)		km/h	239	239	235	234
Category A Takeoff and Landing Ceiling	ISA	m	3018	2009	652	N/A
Backup profile for ground level and elevated helipads	ISA + 20 °C	m	2009	1637	198	N/A
Category A Takeoff and Landing Ceiling	ISA	m	3597	2713	1570	1332
Runway profile	ISA + 20 °C	m	3054	2143	920	686
Endurance at Loiter Speed ^[4]	SL, ISA	hr	4.0	3.9	3.8	3.8
	1,219 m, ISA	hr	4.5	4.4	4.2	4.2

ENGINE RATING (100% RPM)

			Uninstalled Thermodynamic Capability		Mechanical Limit
Pratt & Whitney PT6T-9 Twin Pack ®	Takeoff (5 minutes)	kW	2 × 837		2 × 692
	Max Continuous Power	kW	2 × 761		2 × 615
	OEI (continuous)	kW	1 × 884		1 × 820
	OEI (2 minutes)	kW	1 × 916		1 × 858
	OEI (30 seconds)	kW	1 × 954		1 × 946

TRANSMISSION RATINGS (100% RPM at mast)

Takeoff (5 minute)	1,022 kW
Maximum Continuous Power	828 kW
Single Engine	Limited by Power Available

FUEL (usable)

Type	Aviation Turbine
Capacity	1,251 liters

- Notes: [1] IFR Std Config includes all items listed in the Aircraft Configuration table of this document as well as 25 lb of engine oil. Ballast is not included in the standard configuration (ballast is a function of installed equipment).
 [2] With optional Increased Gross Weight kit.
 [3] With BLR FastFin® System.
 [4] Standard fuel, no reserve, average gross weight.
 [5] Performance at Increased Gross Weight.

Helicopter Dimensions

LOW SKID GEAR

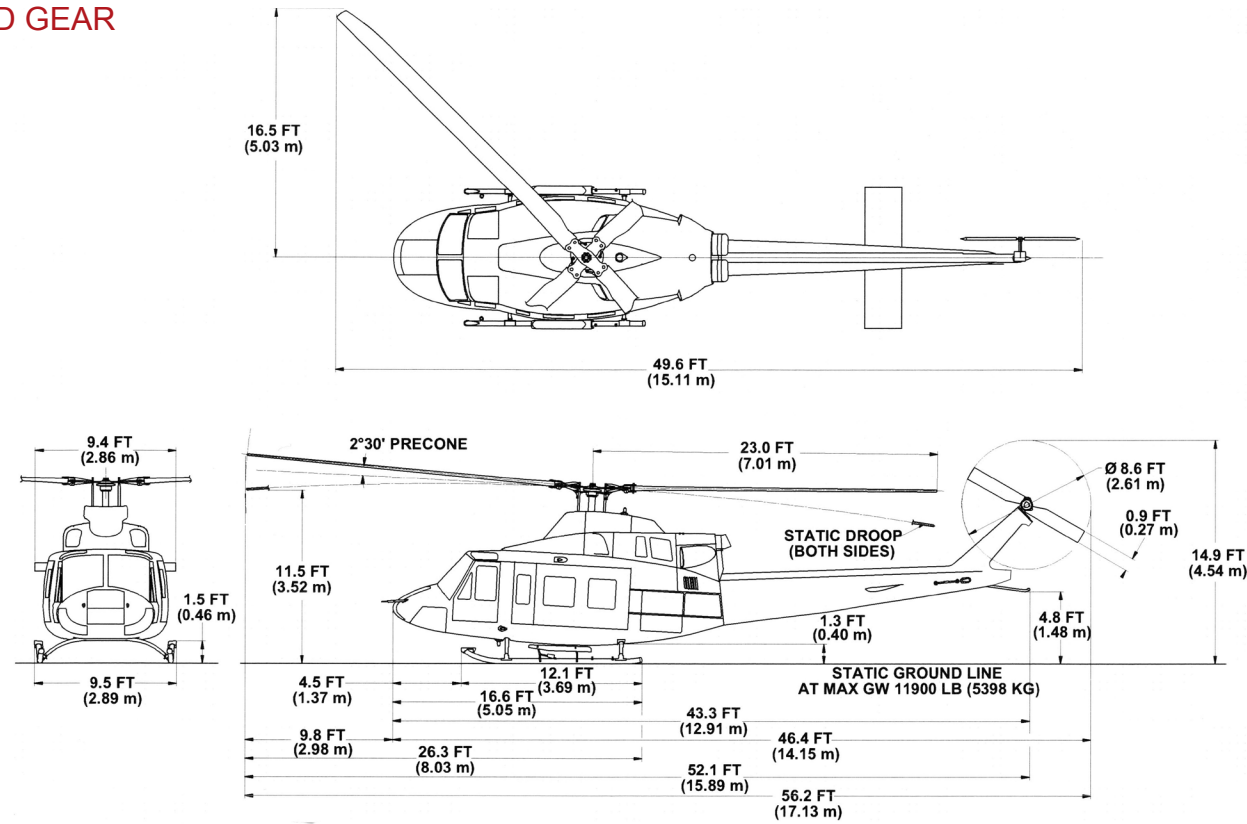

OPTIONAL HIGH SKID GEAR WITH OPTIONAL AA FLITESTEP®

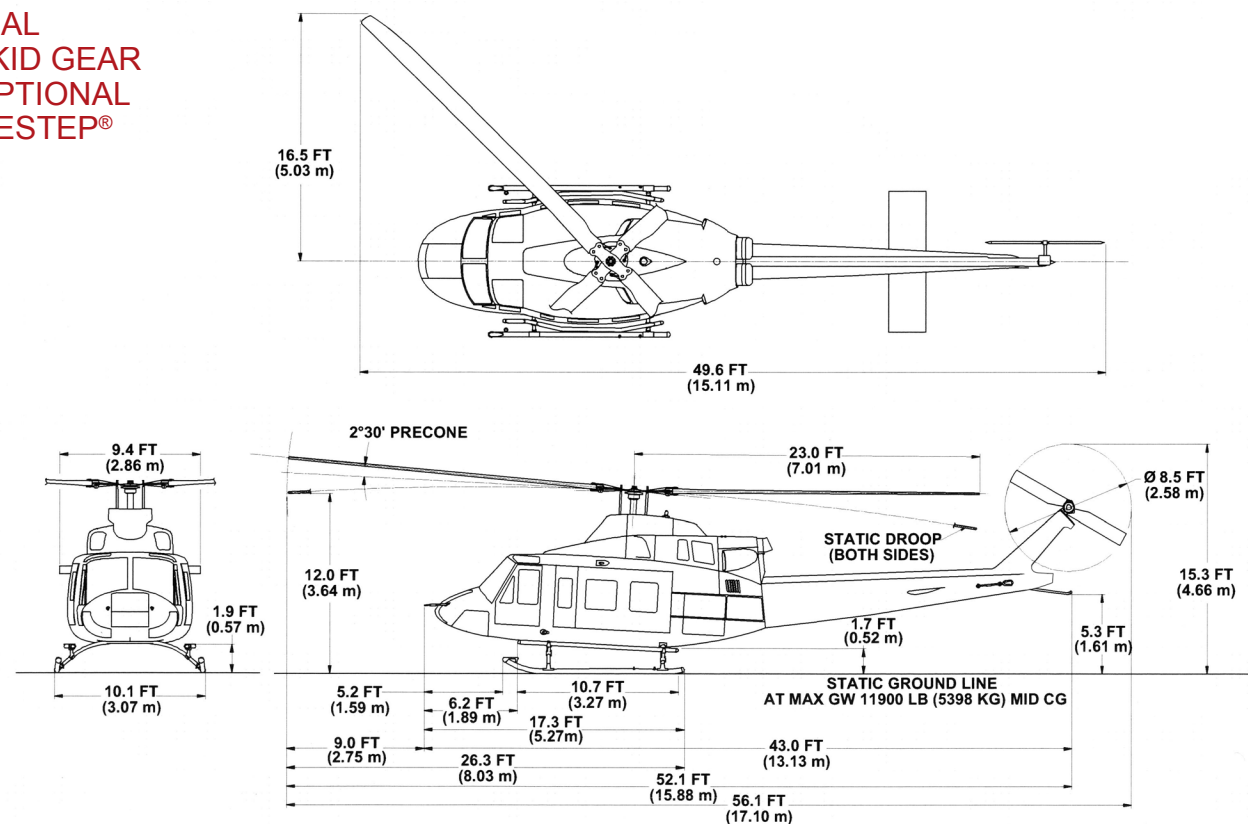

Helicopter Dimensions

OPTIONAL EMERGENCY FLOAT KIT

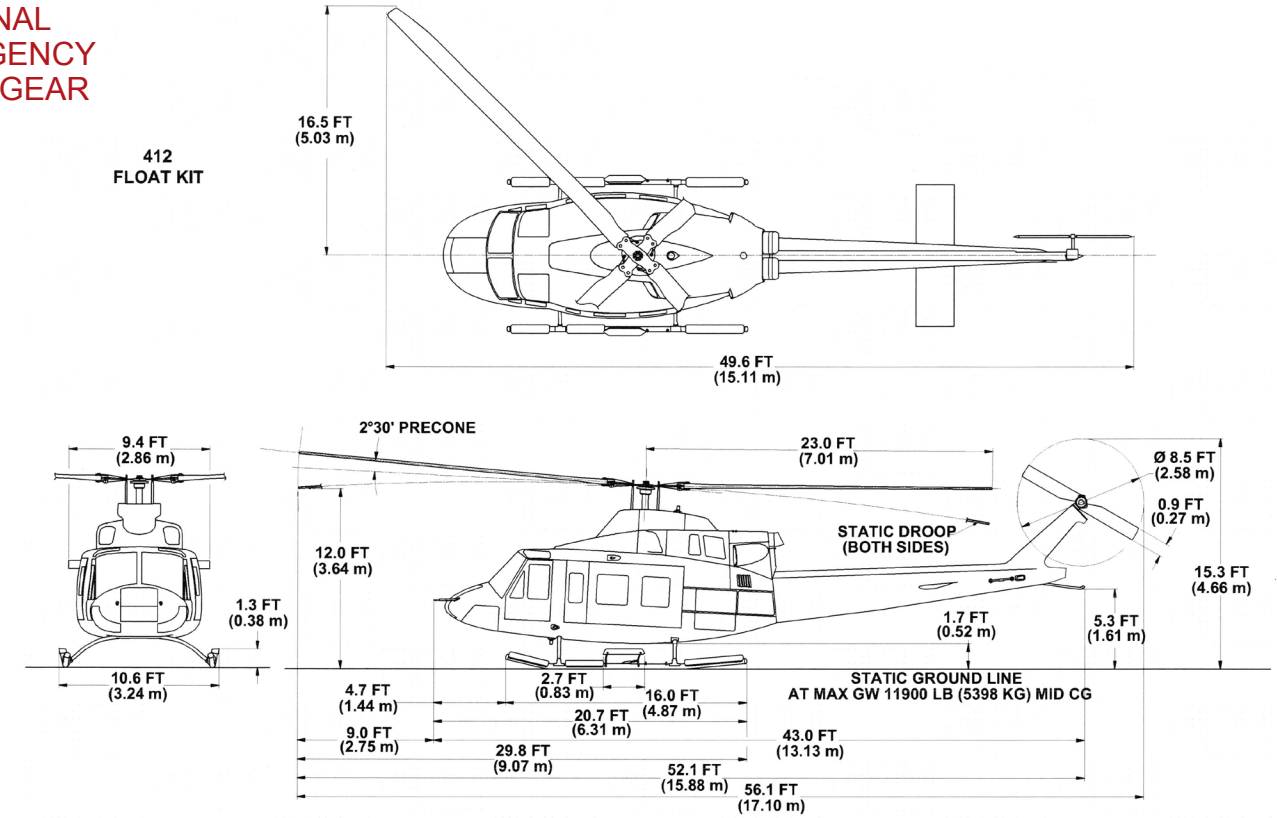

OPTIONAL BLADE FOLDING KIT DIMENSIONS

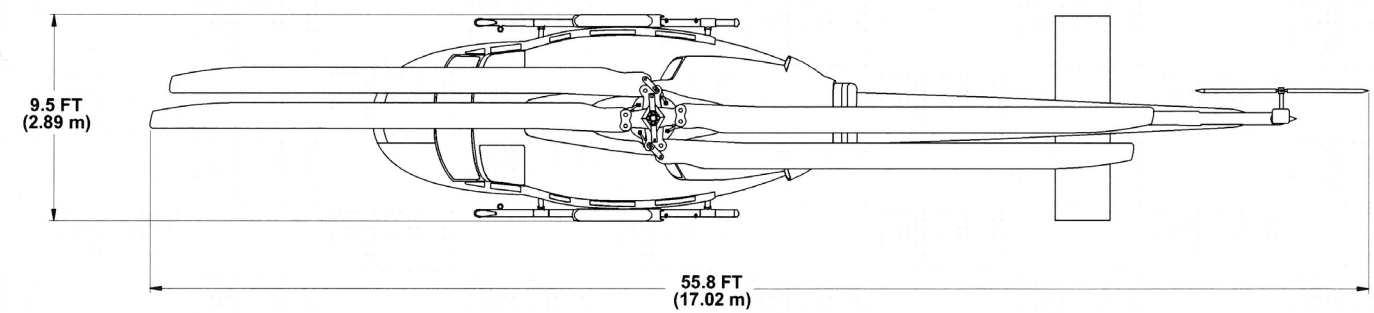

MINIMUM HANGAR SIZE

	US Units	Metric Units
Rotor not Folded	33.0 ft × 49.6 ft	10.1 m × 15.2 m
Rotor Folded	9.5 ft × 55.8 ft	2.9 m × 17.1 m

Note: Allowance should be made for high skid gear, ground wheels, empty fuel condition and door lip when considering hangar door width and height

Bell BasiX-Pro™ Integrated Avionics System

The Bell BasiX-Pro™ Avionics System has been specifically designed to meet the requirements of twin engine helicopters and is optimized for IFR, Category A, and JAROPS-3 compliant operations. The system is highly flexible and configurable to meet various operating and customization needs. The system takes advantage of the latest in display, computer processing, and digital data bus technology to provide a high degree of redundancy, reliability, and flexibility.

STANDARD CONFIGURATION

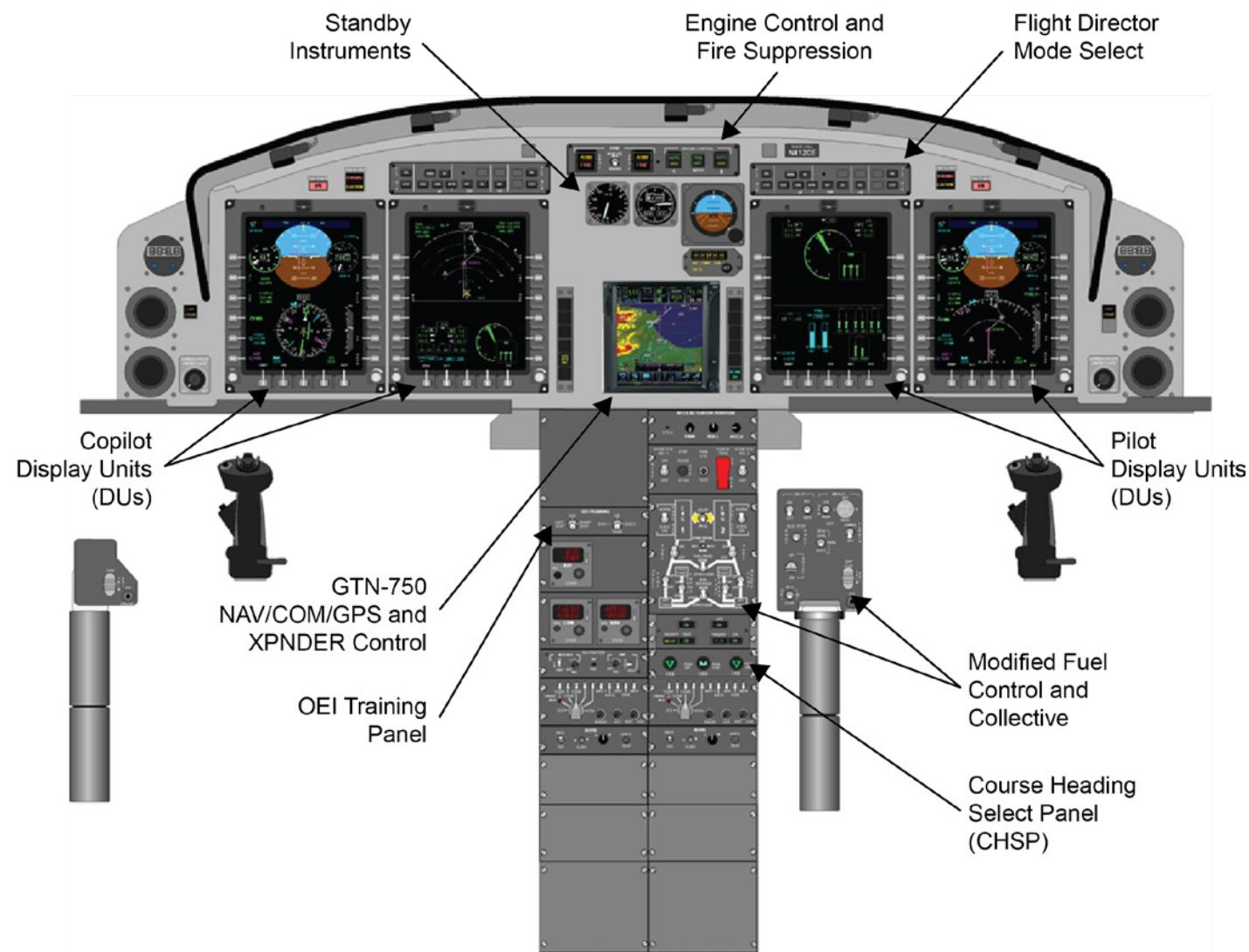

The primary components of the Bell BasiX-Pro™ Avionics System in the Bell 412EPI include:

Four Multi-Function Display Units (DUs) with 6 x 8 inch high-resolution displays.	Dual Channel Aircraft Data Interface Unit (ADIU)	Dual Flight Director Mode Select Panels for the Automatic Flight Control System (AFCS)	Dual Air Data Computer Systems (ADCs)	Course/Heading/Select Panel (CHSP)
---	--	--	---------------------------------------	------------------------------------

Bell BasiX-Pro™ Integrated Avionics System

The standard configuration of the Bell 412EPI provides single-pilot or dual-pilot IFR capability with 3-axis stability augmentation (SAS) and a coupled flight director capability. All Engine Indication and Crew Alerting System (EICAS) display functions are provided through the Bell BasiX-Pro™ Avionics System. The system works in conjunction with the engine control units (EEC/ECUs) for the Pratt & Whitney electronically-controlled PT6T-9 Twin Pac® engines. Other aircraft systems indications, warnings, cautions, aural alerts, and automated performance features are provided through the remotely located Aircraft Data Interface Unit (ADIU).

Power and performance situational awareness is enhanced through Bell's patented "PSI" presentation. The PSI (Power Situation Indicator) provides a single gauge to monitor use of engine power relative to multiple limits simultaneously, and assures maximum power usage and workload reduction in OEI as operation transitions to flying RPM indication against the engine limiters. Systems monitoring workload is reduced through EICAS design for rapid scanning. Display-by-exception, normalized scales, subdued red and yellow markings except in appropriate conditions: These all contribute to reduced pilot instrument scan times through an effective EICAS design made specifically for the demands of helicopter use.

Communications and Navigation: The Bell 412EPI provides updated COM1, NAV1, and the transponder from the original Bell 412EP with a helicopter-approved Garmin GTN-750 NAV/COM/WAAS GPS and a GTX-33H ES remote transponder. The GTN-750 provides a high-resolution touch-screen display with extensive digital mapping capability, terrain presentation, electronic charts and approach plates. The GTN-750 also provides the control interface for the GTX-33H ES. The Garmin GTX-33H ES is an ELS-compliant, Mode S transponder with 1090 MHz extended squitter ADS-B reporting capability. The Bell 412EPI also incorporates a KRA-405B radar altimeter as part of the basic equipment.

The Bell 412EPI retains the standard NAV2 (KNR-634A VOR/ILS/MB), COM2 (KTR-908), DME (KDM-706A), ADF (KDF-806), and Audio/Intercom Panel (NAT N301A) from the Bell 412EP IFR configuration. Standard installation of the NAT N301A is for high impedance headsets but the units can be alternately wired for low impedance (military style) headsets.

An optional Garmin GTN-650 with an MB-10R Marker Beacon can be selected to function as the COM2/NAV2 /GPS2, replacing the standard KNR-634A and KTR-908, completing the Garmin COM/NAV/GPS upgrade on the 412EPI.

Display Units: The BasiX-Pro™ Multi-Function display units are "smart displays", which are NVG-ready^[1] and include the processing required to collect sub-system information and generate display formats and graphics for the following:

- All primary flight and navigation instrumentation
- Presentation of flight director and autopilot status
- Engine and rotor drive system indications
- Electrical, hydraulic, and fuel system monitoring
- Crew alerting system (warnings / cautions / advisories and aural alerts)
- Navigation route mapping display
- Presentation of optional Traffic Collision Avoidance Symbology (TCAS)
- Presentation of optional weather radar or search radar information
- Presentation of optional multi-sensor camera / Enhanced Vision Systems (EVS) video display (either NTSC or PAL standard)

Notes: [1] BasiX-Pro™ Display Units LCD displays are RTCA DO-275 compatible for night vision goggle use when selected to NVG backlight mode. NVG completion installs the overhead control switch required to enable NVG mode. Display Unit key legend and control lighting is NVG compatible as a standard feature. Full NVG compatibility requires all other light sources, including customization, be tested and modified if required.

Bell BasiX-Pro™ Integrated Avionics System

- Presentation of general color video display or digital map display (NTSC or PAL standard in either S-Video or Component RGB video)
- Presentation of electrical schematic, fuel schematic, and weight and balance summary information
- Presentation of automated power assurance, Category A performance, and hover performance calculations
- Presentation of maintenance and diagnostic data

The Bell BasiX-Pro™ system flight displays work with the current Bell 412EP LCR-100 Attitude and Heading Reference Systems (AHRS).

CONFIGURATION FLEXIBILITY TO MEET OPERATIONAL NEEDS

The BasiX-Pro™ includes built-in provisions to allow customized configuration of the following equipment:

- Alternate FMS / GPS systems
- Alternate ARINC-429 radio nav aids
- 2nd Radar Altimeter
- UHF / VHF Direction Finder or second ADF
- Weather / Search Radar
- Multi-sensor camera / EVS display (either NTSC or PAL standard)
- Designator Control Panel (allows FLIR or radar cursor designated positions to be captured as waypoints)
- General color video display or digital map display
- Velocity Sensor (for hover cues and / or search and rescue approach options)
- Programmable CAS messages (cautions / warnings / advisories)

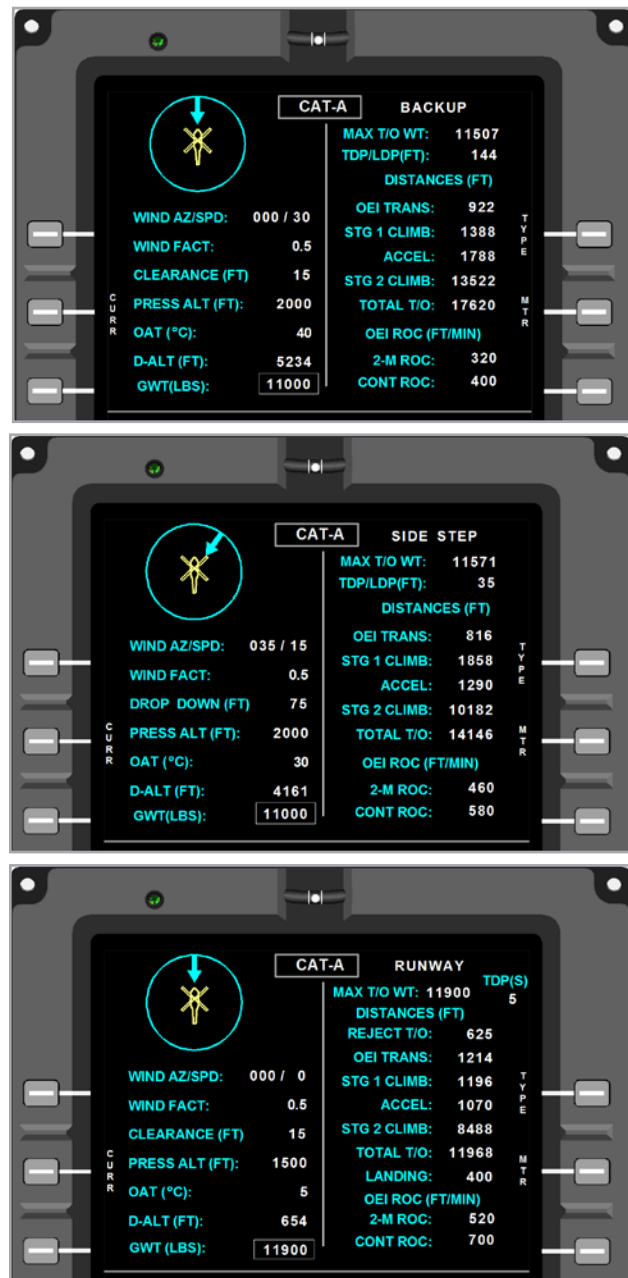

The Bell BasiX-Pro™ integrated avionics system displays automated performance calculators for quicker planning.

Automatic Flight Control System

The Bell 412EPI utilizes the Honeywell SPZ-7600 digital Automatic Flight Control System (AFCS), providing 3-axis or 4-axis flight director capability. The Bell 412EPI readily allows upgrade to 4-axis which provides the additional features of yaw trim, altitude pre-select, simultaneous vertical and speed coupling, automatically decelerating approaches, radar altitude hover hold, and hover velocity assist.

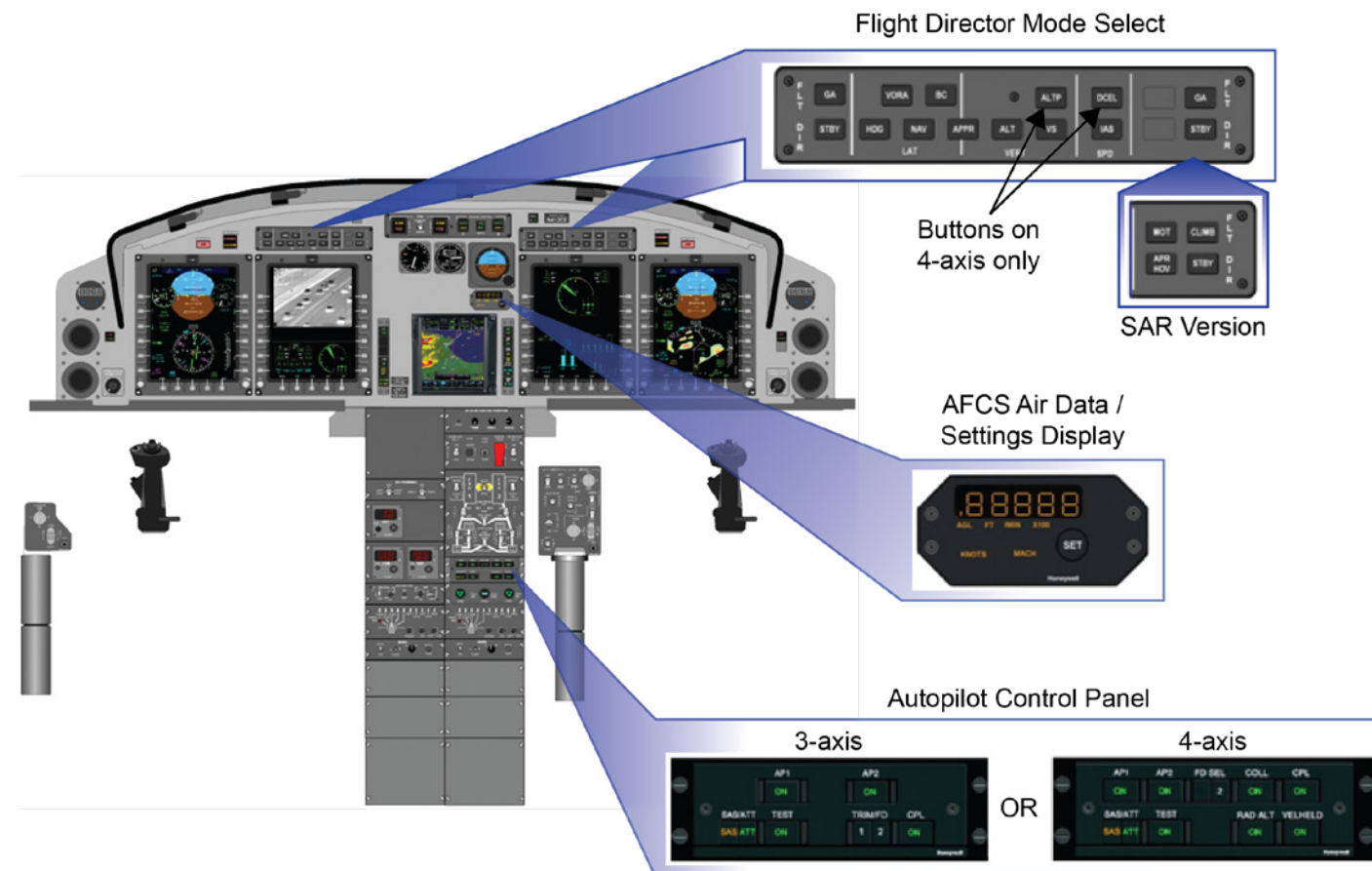

The Bell 412EPI standard flight director modes for the 3-axis AFCS include airspeed hold, altitude hold, VS hold, heading hold, coupled navigation modes, coupled approach modes, and go around.

Safety Enhancements

Bell is at the forefront in providing multiple ways of satisfying evolving requirements in helicopter traffic management, flight following and terrain awareness safety. The Bell 412EPI provides fully-coupled LPV WAAS (Localizer Precision with Vertical guidance Wide Area Augmentation System) approaches allowing precision instrument flight operation into more airports and heliports. The Bell BasiX-Pro™ Integrated Avionics System concentrates on providing true operational capabilities and flexibility to our customers to address rapidly changing regulatory requirements and technologies, with an open architecture and flexible avionics systems solutions.

The enhancements available for the Bell 412EPI through optional accessory kits and customizing include the Traffic Advisory System and Helicopter Terrain Awareness and Warning Systems / Enhanced Ground Proximity Warning System.

Traffic Advisory System (TAS): Two TAS systems available can present on either the BasiX-Pro™ Display Units (in PFD or MFD format) or on the GTN-750:

- **Avidyne TAS605 (recommended)** features:
 - 13 nm range
 - 5,500 ft vertical separation
 - 55,000 ft service ceiling
 - Will be upgradable to Avidyne TAS605A for ADS-B available from Avidyne
- **Avidyne TAS620** features:
 - 21 nm range
 - 10,000 foot vertical separation maximum
 - 55,000 foot service ceiling.
 - Upgradable to Avidyne TAS620A for ADS-B



TAWS displayed on MFD Map/Radar page

Helicopter Terrain Awareness and Warning System/ Enhanced Ground Proximity Warning System: Three EGPWS H-TAWS options are available:

- **Honeywell Mark XXI EGPWS H-TAWS** – System available as STC on EPI:
 - Installation with or without weather radar
 - Displays on BasiX-Pro™ Display Units, underlaid on PFD HSI format or MFD Map / Radar format
 - Radar / H-TAWS independently pilot / copilot selectable
 - Provides only one TAWS image (one range setting only)
- **Honeywell Mark XXII EGPWS H-TAWS** – System available as STC adds the following features:
 - Interfaces with ADC and Rad Alt
 - Provides dual TAWS images with independent range control
- **Garmin HTAWS upgrade to the GTN-750**
 - Lightest Weight, Lowest Cost solution for terrain warning
 - Displays on the GTN-750 only

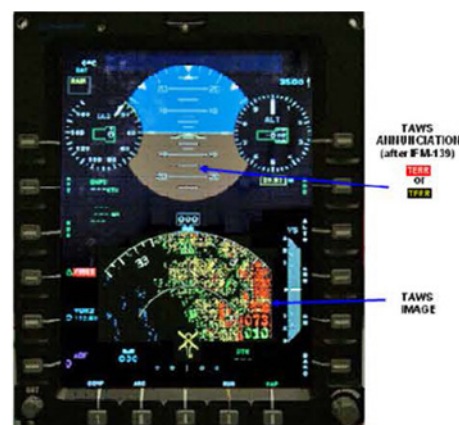

TAWS displayed as HSI underlay on PFD



Garmin HTAWS

Lighting and Controls

Interior Lighting and Controls: The Bell 412EPI standard cockpit controls and panels are illuminated by high-reliability LED (light emitting diode) lighting that is NVG-ready, greatly reducing the impact of completing an NVG compatible cockpit. LEDs illuminate:

- All EPI-specific cockpit push-button annunciators
- Flight Director Mode Select panel (FDMS), and Engine Control & Fire Suppression panel
- Overhead switch panels and circuit breaker panels
- Collective head control panels
- AFCS Actuator Position Indicator Panel
- Autopilot Control Panel (less push buttons)
- Miscellaneous Control Panel, Fuel Control Panel, Miscellaneous Nav Panel, AHRS Control panels, OEI training Panel, and ICS panels
- Cockpit secondary instrument lights, Cockpit Utility lights

Exterior Lighting: The six exterior navigation lights and the two red anti-collision lights are high-reliability LED assemblies.

Courtesy Lighting and External Power: The Bell 412EPI incorporates a cockpit switch to control application of external power so that aircraft systems are not powered unnecessarily when no flight crew is aboard. When external power is applied but switched off via the cockpit control, a "courtesy lighting" feature is provided. This feature provides power to the baggage compartment lights, passenger step / external utility lights, cabin dome lights, and cockpit secondary instrument lights. This feature facilitates pre-flight / post-flight loading and unloading. The same courtesy lighting feature is provided from aircraft battery power for 5 minutes after all main aircraft power is switched off. If courtesy lights on battery power are desired at pre-flight, the 5-minute interval can be started or extended using the push button located on the sloped panel on the pilot's side of the pedestal.

Extended Hover Performance (EHP) Kit

The Extended Hover Performance (EHP) kit removes the 5-minute time restriction imposed on the takeoff power transmission limit for operations at 60 KIAS or less. There is no TBO reduction associated with this kit. It is also compatible with the IGW and 9 Passenger Seats or Less configurations.

Refer to BHT-412-FMS-80.5 for more information.

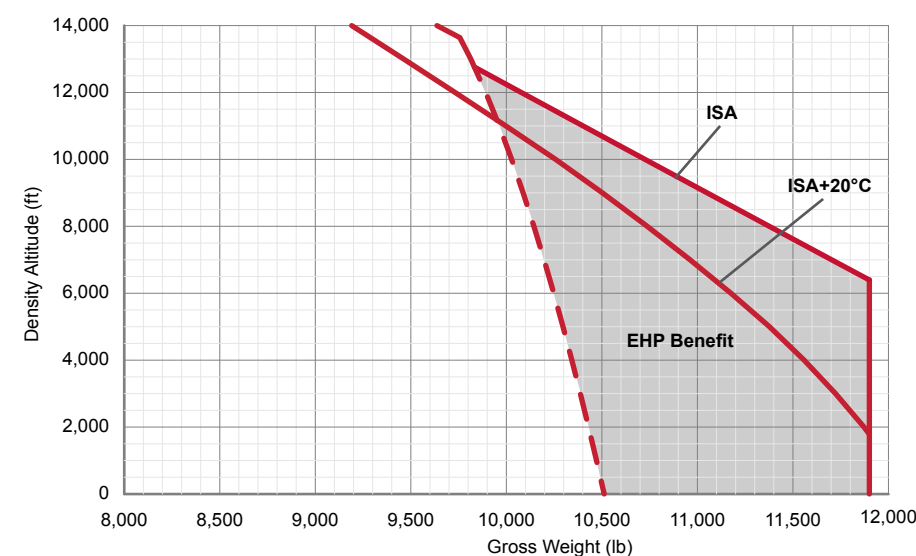

OGE Hover Capability at Maximum Continuous Power

BLR Strake and FastFin®

Bell has partnered with BLR Aerospace to provide its performance, safety and efficiency-enhancing FastFin® system as a standard feature on new Bell 412EPI aircraft orders. The system incorporates two parallel stall strips along the tail boom and a reshaped vertical fin. These modifications combine to optimize airflow around the tail boom, improving the handling, stability and lifting capacity of the Bell 412EPI in all environments, especially high and hot conditions.

The FastFin® system is a combination of two separate modifications, one to the vertical fin and the other to the tailboom. For clarity, the term FastFin® refers to the BLR modification that changes the shape and contour of the vertical fin. The term FastFin® System refers to the combined FastFin® and Dual Tail Boom Strake installation.

The performance benefits of this system include increased tail rotor effectiveness and higher crosswind speed tolerance at hover in certain conditions. In conditions where the aircraft is currently tail rotor limited the FastFin® System results in increased Weight-Altitude-Temperature (WAT) capability for takeoff, landing and in-ground-effect maneuvers, providing substantial improvement in useful load for hot/high operation.



Bell 412EPI FastFin® System.

Increased Gross Weight (IGW) Kit

The Increased Gross Weight (IGW) kit raises the internal and external maximum gross weight to 12,200 lb (5534 kg) with no increase to empty weight [1]. This provides an additional 300 lbs of useful load. The kit is approved for Category B operations as well as Category A operations using the Runway profile. Additionally, WAT capability for takeoff, landing and in-ground-effect maneuvers is increased for altitudes up to 11,000 ft density altitude.

Refer to BHT-412-FMS-74.5 for more information.

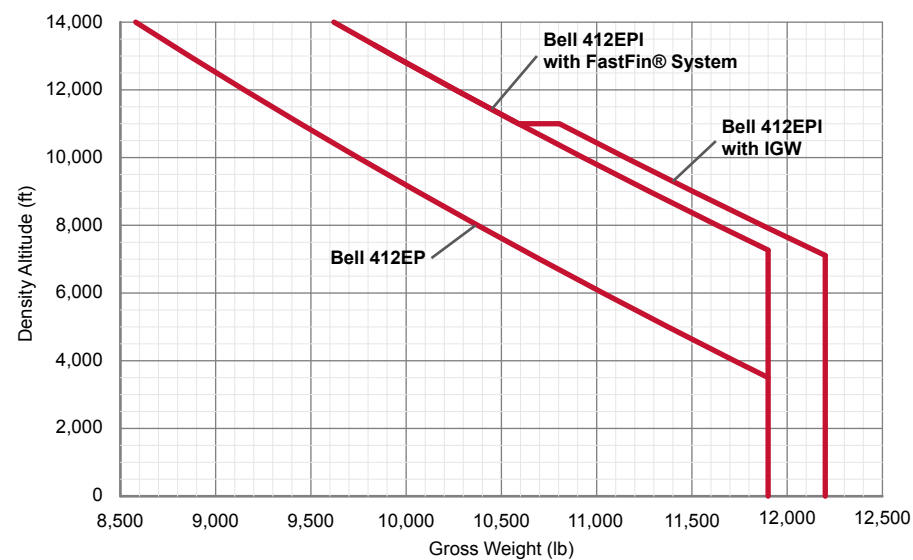

Bell 412EPI IGE Hover WAT Improvement with FastFin® System and IGW

Note: [1] When prerequisite kits are installed

Seating and Interiors

SEATS

Crew Seats: Two individual energy attenuating seats, fore/aft and up/down adjustable, each equipped with seat belt, double strap shoulder harness and inertia reel. Available with grey, blue, or tan upholstery which will match that selected for the cabin.

Passenger Seats: 13 seats offered in three options. (NOTE: Seating option 1 meets the criteria required by FAA regulations for installation in U.S. registered helicopters. Seating Options 2 and 3 require the addition of the STC Alpine 412 Passenger Shoulder Harness Kit for installation in U.S. registered helicopters.)

SEATING CHOICES

- Standard Seating:** Fabric covered high-backed folding seats with individual seat belts and single strap shoulder harness and inertia reel, arranged with one row of four (two 2-place benches) forward facing seats, and one row of five forward facing seats, and two outward facing two place benches (one on either side of the transmission). Available with Grey, Blue, Black, or Tan upholstery with Black seat belts. Seats are also available in all vinyl at additional cost. (214.5 lb [97.3 kg] included in the standard configuration weight.)
- Utility Seating:** Utility Seating - Available for U.S. registered helicopters ONLY with addition of STC Alpine 412 Passenger Shoulder Harness Kit. Nylon covered bench type seating arranged with one row of four rearward facing seats (behind the crew seats), one row of five forward facing seats (in front of the transmission), and two outward facing two place benches (one on either side of the transmission). Each seat has an individual seat belt. Available in Tan or Black. The Utility Seating decreases the standard configuration weight (-95.7 lb [-43.4 kg], with Alpine STC Shoulder Harness -61.4 lb [-27.9 kg]).
- Cushioned Utility Seating:** Available for U. S. registered helicopters ONLY with addition of STC Alpine 412 Passenger Shoulder Harness Kit. As in 2) above with the addition of fabric covered cushions, available in the same colors as the Standard Seating. The Cushioned Utility Seating decreases the standard configuration weight (-53.0 lb [-24.9 kg], with Alpine STC Shoulder Harness -18.7 lb [-8.5 kg]).



Standard Seating shown with Standard Interior Trim and Floor Covering. (Utility seating options 2 and 3 not illustrated.)

Seating and Interiors

INTERIOR TRIM CHOICES

1. **Standard Interior Trim:** The Standard Interior Trim is provided as a NO COST OPTION, but is not included in the Standard Configuration Empty Weight. Included are: Plastic closeouts on upper sidewalls, window reveals, and cabin headliner; Padded vinyl or economic loop pile carpeting covering the floor and padded vinyl lower door panels; Lower aft bulkhead covered with padded vinyl blankets. The hard plastic headliner and closeouts are off-white in color, and the padded bulkhead blankets and floor covering are color coordinated to match the seat color selection. The Standard Interior Trim increases the standard configuration empty weight (165.7 lb [75.2 kg]).
2. **Utility Interior Trim:** The Utility Interior Trim consists of: Light beige vinyl covered headliner and bulkhead blankets; Doors painted light beige; Floor painted brown. The Utility Interior Trim is included in the standard configuration empty weight (33.3 lb [15.1 kg]).

CUSTOMIZED INTERIORS

Custom designed interiors are available from aircraft completion centers to meet the needs of Corporate or Emergency Medical Service customers.



Example Customized Interior shown with Corporate Club Seating and Interior Trim.

Mission Profiles

ENERGY

From powerlines to oil platforms the Bell 412EPI is a daily workhorse. The expansive cabin accommodates varying needs in a safe and reliable platform. Optional mission equipment for an energy configuration further enhances the Bell 412EPI's capability. Options include emergency floats with life rafts that mount to the skid gear in the event of a water landing, a radar that provides weather awareness and avoidance alerts, and a belly-mounted high intensity search light that provides night visibility.



Energy

PARAPUBLIC

The Bell 412EPI is as versatile as your daily requirements. As one of the roomiest, most flexible and cost-effective aircraft on the market, the Bell 412EPI can be configured to an airborne command center, an air ambulance platform, special operations or a homeland security base. It can be equipped with an optional hoist and cargo hook for increased multi-mission capability, including search and rescue, fire fighting, HEMS and mass evacuations.



Parapublic

Mission Profiles

CORPORATE

It's all about getting there on time. When business requires you to travel in extreme conditions, look to the Bell 412EPI to always get you there and back. The board of directors can be accommodated on the Bell 412EPI with its spacious, configurable, 220 ft³ (6.2 m³). You can also tote your guest's luggage easily with the Bell 412EPI's large, 28 ft³ (0.8 m³) baggage compartment.



Corporate.

HEMS

Extraordinary measures demand extraordinary resources. When it's critical that you get there, you need the Bell 412EPI. The cabin features space to carry four medical attendants and up to six patients or two critical patients. The 7.7 ft (2.3 m) sliding doors on both sides of the Bell 412EPI and an industry leading 53" (135 cm) ceiling height allow for fast and easy patient loading and unloading.



HEMS

External Paint Schemes



For more color options, please visit www.BellHelicopter.com or speak with a Sales Representative.

- Notes:
1. Color renderings (original) must be provided for any deviation to the standard schemes (all models).
 2. Custom paint schemes to customer specification are available, and a price quote will be provided on request. Please provide as much detail as possible when describing special instructions and custom paint schemes.
 3. The danger arrow is always applied on the tail boom between the horizontal stabilizer and the tail rotor, not withstanding any other illustrations.
 4. Unless clearly specified (location, dimension, color), registration markings will be applied per FAA regulations (all models).
 5. Metallic paint can not be applied over RADOME areas when a radar is installed.
 6. Placement of Bell model logos is effected by individual paint schemes, and will be applied at the discretion of Bell unless otherwise specified by the customer.

Basic Bell 412EPI Configuration

AIRFRAME

Aluminum alloy fuselage (over 240 ft ³ [6.8 m ³]) loading space
Glass windshields
Tinted overhead windows
Dual windshield wipers
Fresh air ventilators with adjustable outlets (8 cockpit and 12 aft cabin)
Bleed air heater and defroster with air noise suppression
Cargo tie-down fittings (51 aft cabin floor)
Map and data case
Cabin fire extinguisher (2)
Swing-out jettisonable doors (2 for forward cabin)
Sliding doors (2 for aft cabin access with 2 emergency exit panels on each door)
Swing-out panels for extended access to aft cabin (2)
Fixed step on skids for entry to forward cabin (2)
Retractable steps for aft cabin access (2)
Baggage compartment in tail boom (over 28 ft ³ [0.8 m ³], 400 lb [181 kg] capacity)
Skid-type landing gear with replaceable wear shoes
Mooring and jacking fittings (4)
External attachment fittings (16)
Semi-monocoque tailboom
Elevator (airspeed / spring-cartridge controlled)
Tail Skid
Cargo hook provisions
Baggage compartment fire and smoke detector
BLR Strake and FastFin®

COMMUNICATIONS and NAVIGATION

Nav#1 / Comm#1 / GPS: VOR / LOC / GS / COMM/ GPS with WAAS (Wide Area Augmentation System), touch screen control. Digital maps with terrain, 8.33 KHz or 25 KHz spaced 16 W Comm (Garmin GTN 750)
Transponder: ELS compliant Mode S with ADS-B reporting (Garmin GTX 33H ES controlled via GTN-750)
Comm #2: VHF-AM 20 W Transceiver (KTR-908)
Nav receiver #2: VOR/LOC/GS/MB (KNR-634A)
Distance Measuring Equipment (DME) (KDM-706)
Automatic Direction Finder (ADF) (KDF-806)

COMMUNICATIONS and NAVIGATION (continued)

Four (4) NAT N301A Intercommunication Systems (ICS) panels, pilot & copilot in the cockpit, two in the cabin
2 Headsets – high impedance (pilot & copilot)

CREW ALERTING

Dedicated Annunciators:
CAUTION/WARNING (2)
RPM (2)
LIMIT/LTD OP (2)
Engine FIRE/ARM (2)
Engine Control AUTO/MAN (2) MGT/TRQ matching
Attention tone (occurs for warning, caution, impending exceedance or OEI limited time zone entry)
Audio Alerting:
RPM alarm
VNE alarm
Altitude Setting departure alert (voice)
Decision Height alert (voice)
100 feet or 150 feet radar altitude call out (voice)

ELECTRICAL

DC Generators (2) 28 volt, 200 ampere starter/generator
Inverters (2), (250VA volt ampere single phase, solid state)
40-Amp Hour NiCad
Generator control units/voltage regulators (2)
External power receptacle, with in-cockpit activation switch
Lighting:
Anticollision lights (2) (Red LED)
Baggage compartment light
Cockpit secondary instrument/storm lights (5) (LED)
Cockpit utility lights (2) (LED) corded & detachable
Cabin dome lights (3)
Courtesy lighting feature
Landing light, retractable (600 watt)
Map/approach plate holder lights (2)
Navigation lights (6) (LED)
Passenger step/exterior utility lights (2)
Steerable search light (450 watt)
Signs:
Self-illuminating seat belt / No Smoking signs (3)
Tritium lighted emergency exit signs

Basic Bell 412EPI Configuration

FLIGHT and ENGINE INSTRUMENTS

EFIS/EICAS (Electronic Flight Instruments System/ Engine Indicating & Crew Alerting System):
Four 6" × 8" color LCD display unit (DU) with interface provisions for future kits and customized equipment installations, each with video display capability
Aircraft Data Interface Unit, Dual Channel
Course/Heading Select Panel (CHSP)
Electronic Data Recorder embedded in the Integrated Avionics System Displays Units (non-crashworthy)
Attitude & Heading Reference Systems (LCR-100 AHRS) (2)
Air Data Computers (ADC) (2)
Dual Pitot static system with electric heat
Clocks, digital quartz chronometer (Pilot/ Copilot)
Radar altimeter #1 (KRA-405B)
Standby instruments:
Standby attitude indicator
Standby altimeter and airspeed indicator
Magnetic compass, pilot's/copilot's standby
Free air temperature indicator
Standby instrument battery with use annunciator
Dual Digital Automatic Flight Control System (AFCS) with 3-axis autopilot and nav-coupled flight director
Pilot / Copilot Flight Director Mode Select (3-axis version)
AL-300 Air Data & Settings Display
PC-700 Autopilot Control Panel (3-axis version)
Instrument (integral) lights (white/green)

INTERIOR

Choice of Interior Trim:
Standard Interior Trim: Rigid three-piece headliner in cabin, padded fiberglass floor covering, bulkheads, trimmed with cream-colored plastic and color-coordinated vinyl coated fiberglass, cabin doors trimmed with plastic, special soundproofing, seat upholstered with foam and fabric. Selection of fabric colors. Not included in base aircraft empty weight, increases empty weight 165.6 pounds (75.1 kilograms) when installed.

INTERIOR (continued)

Utility Interior Trim: Beige / Gray soundproofing blankets on bulkheads and overhead; doors painted beige, floor painted brown. Included in base aircraft empty weight (approximately 32.6 pounds, 14.8 kilograms)

LOOSE EQUIPMENT (not included in empty weight)

Covers, tail pipe, turbine air inlet, and pitot tube
Flight bag
Ground handling wheels, hydraulically activated
Tie-down assemblies, main rotor and tail rotor
Operating manuals:
Flight manual
Aircraft log book
Engine log book
Aircraft maintenance manuals are available on ePubs located here: http://www.bellhelicopter.net
Diagnostic and Maintenance Information Transfer System (DMITS) harness & DMITS Software
PT6T-9 Data Collection Unit (DCU) maintenance harness & software

PAINT

Markings for high visibility M / R blades (white and orange) and T / R blades (black and white)
3-color external paint

POWERPLANT

Pratt and Whitney of Canada PT6T-9 "Twin Pac"
Electronic Engine Control Units (EEC / ECU) (2)
Data Collection Units (DCU) (2)
Fuel Management Module (FMM) (2)
Ignition and Starting System (2)
Fuel System (330.5 U.S. Gal [1,251 liter]) (rupture resistant cells and breakaway vent fitting)
Pumps on engines and submerged in fuel tanks
Fuel filter assembly
Oil coolers (2)
Fire detection system (2)
Fire extinguisher system (2)
Mechanical manual back-up engine control system
Hinged cowling

Basic Bell 412EPI Configuration

POWERPLANT (continued)

Engine inlet particle separator system (2)
Combining gearbox with chip detector
Separate firewall protection for each engine
Overriding clutches (2)
Extended engine exhaust deflectors

ROTORS AND CONTROLS

Soft-in-plane flex beam hub with four fiberglass blades
Main rotor droop restraint
Pendulum vibration absorbers
Semi-rigid, two bladed, all-metal tail rotor
All controls hydraulically boosted (dual systems for main rotor)
Force trim system and artificial feel (electrically set)
Dual controls
Cyclic stick centering
Electronically controlled RPM - 100%, 103% or Auto
Rotor brake

TRANSMISSION DRIVE SYSTEM

Main rotor transmission with 4 chip detectors / 2 debris collectors with automatic debris burn and history logging
Vibration isolation / suspension mounts (4)
Main lift link (single point suspension)
42° gearbox (sight gage and magnetic drain plug with monitored chip detector, automatic debris burn and logging)
90° gearbox (sight gage and magnetic drain plug with monitored chip detector, automatic debris burn and logging)
Hydraulic pumps for controls (2 independent systems)
Transmission oil cooler

Bell 412EPI Optional Accessories

Refer to notes for kit compatibility. Additional kits and STC items may be available for factory installation. Please consult sales or contract personnel regarding special needs prior to selection of final configuration.

OPTIONAL ACCESSORIES

Kit Description	Weight		Notes
	lb	kg	
AIRFRAME (Bell kits)			
Fixed Step Left Hand	11.6	5.3	1, 2
Fixed Step Right Hand	11.6	5.3	1, 2
Heavy Duty High Skid Gear without Steps	18.5	8.4	1, 3
Emergency Floats (provisions)	51.0	23.2	4
Emergency Floats / Reservoir and Nose	97.5	44.2	4
Emergency Floats (Landing Gear with Floats and Power Steps)	168.8	76.6	1, 4
Heated Windshield	9.8	4.4	1
Fuel Kit - Manifold Drain	0.3	0.1	
Aux Fuel Provisions	5.4	2.5	5
Aux Fuel, 16.3 gal L/H	20.2	9.1	5
Aux Fuel, 16.3 gal R/H	20.2	9.1	5
Aux Fuel, 81.7 gal L/H (requires removal of 2 outboard-facing passenger seats)	50.3	22.8	5
Aux Fuel, 81.7 gal R/H (requires removal of 2 outboard-facing passenger seats)	50.3	22.8	5
AVIONICS (Bell kits and Aeronautical Accessories STCs)			
4-axis AFCS and Flight Director Upgrade Kit	26.4	12.0	
Increased Gross Weight - 12,200 lbs MGW	0.0	0.0	
Extended Hover Performance (IMCP)	0.0	0.0	
Garmin GTN-650 COM2/NAV2/GPS2 with MB	.3	.14	
CV/FDR Combined Unit with RIPS (AA STC)	19.3	8.7	
CV/FDR Combined Unit with RIPS with QAR (AA STC)	20.2	9.2	
H-TAWS Honeywell Mark XXII EGPWS (AA STC)	12.1	5.5	
H-TAWS Honeywell Mark XXI EGPWS (AA STC)	9.7	4.4	
H-TAWS Garmin GTN Upgrade (BHT STC)	.4	.18	
Bell 412EPI Helicopter Vibration Monitoring System (HVMS BHT/AA STC)	33.0	15.0	
Traffic Advisory System – Avidyne TAS-605 or 605A W ADSB (AA STC)	12.0	5.4	
Emergency Locator Transmitter (ELT) ARTEX C406N-HM (AA STC)	6.0	2.7	
AVIONICS (Aeronautical Accessories compatible customizing or STCs)			
13-position Cabin Intercom System with Cabin Isol./Call	10.0	4.5	6
Weather Radar (Honeywell ART/RDR-2000) - Displays on GTN	40.0	18.2	
Weather Radar (Honeywell Primus 660) - Displays on DU's	40.0	18.2	7
Search, Rescue and Weather Avoidance Radar (Telephonics RDR-1600)	68.0	30.8	
ENVIRONMENT			
Heavy Duty Heater	10.3	4.7	1, 8

Bell 412EPI Optional Accessories

OPTIONAL ACCESSORIES

Kit Description	Weight		Notes
	lb	kg	
EQUIPMENT			
Litter Provisions - 6 Place (Non-FAA)	-180.6	-81.9	1, 9
Cargo Hook Equipment (provisions are part of basic ship build)	33.8	15.4	10
External Hoist Provisions and Equipment - 600 lb, capacity	185.3	84.1	
Internal Hoist	172.3	78.2	11, 12
Internal Hoist Sling Only	10.1	4.6	
Gross Weight Towing Puller Equipment (Loose)	N/A	N/A	
3-place Litter Kit (FAA Aircraft) plus Attendant Seat (airline passenger seats removed)	-54.8	-29.4	1, 13
Internal Hoist Provisions	8.9	4.0	11
Hoist Cable Guard (for Internal hoist)	5.2	2.4	
Gross Weight Towing Puller Provisions	2.9	1.3	
Crew Door Mirror	0.3	0.1	
INTERIOR			
Utility Seats (Rag and Tube - Not FAA, removes standard airline seats)	-93.3	-42.3	1, 15
Seat Cushions (for Rag and Tube Seats)	12.2	5.5	
One Man Seat (2 forward-facing, replaces 4 LH/RH outboard-facing)	-2.5	-1.1	1
Std Deluxe Interior (hard plastic)	165.7	75.2	1
OTHER STC EQUIPMENT			
Alpine Shoulder Harness Kit (for utility seats)	33.8	15.3	15
Wire Strike Protection System (WSPS) - Recommended kit	19.2	8.7	16
CREDIT, EQUIPMENT			
No Ground Handling Wheels	180.0	81.6	
No Electrical Powered Steps	-21.0	-9.53	
No Passenger Seats - Airline	-210.0	-95.2	1
PAINT			
No Exterior Paint	0.0	0.0	
White Paint Only	0.0	0.0	
Low Visibility Main Rotor Blade Paint	0.0	0.0	17

EXPLANATORY NOTES

For commonality, notes shown below are identical in Product Specification and Price List.

- Price and/or Weight includes credit for basic ship hardware removed.
- FAA requires either standard electric powered steps or fixed steps to conduct passenger carrying operations. Weight change is for replacement of low skid gear powered steps. Fixed step actual weight 11.7 lb (5.3 kg) each. Fixed steps not compatible with emergency pop out floats or rescue hoist.

Bell 412EPI Optional Accessories

- FAA requires either standard electric powered steps or fixed steps to conduct passenger carrying operations. For powered passenger steps add 21.5 lb (9.8 kg); for fixed steps add 23.4 lb (10.6 kg).
 - For a complete installation of Emergency Floats (412-706-004-153, -163, and -165) are required.
 - Aux Fuel Provision Kit (412-706-112-101) must be installed prior to or concurrently with installation of kits (412-706-112-103, -104, -105, and -106). Aux fuel tank kits can be installed in any combination with maximum of two per aircraft (one per side). Total auxiliary fuel volumes possible are 81.7, 163.4, 98.0, 32.6, and 16.3 gallons.
 - Accommodates up to 13 cabin headsets; headset weight not included; headsets are priced separately.
 - Customizable Radars: The Bell BasiX-Pro™ system is engineered to display information from the Honeywell Primus 440/660/880 series of weather radars or the Telephonics RDR-1600 Search/Weather radar. A radar with 2.5 nm max range display or less (P660 or RDR-1600) is required for approvable off-shore radar approaches.
 - Note that operation of the heavy duty heater imposes a larger performance reduction than the standard heater. Relative performance of the two heater options is as shown in the figure, right.
 - The 205-706-047 6-place Litter Provisions Kit is not FAA certified. Kit is provisions only; does not include cots or attendant seats. Weight is for all standard airline seats removed.
 - Cargo Hook Provisions (212-706-103-103) must be installed prior to Cargo Hook Equipment (212-706-103-119).
 - Internal rescue hoist (214-706-003-107) requires installation of provisions (412-706-011-105), Cable Guard (412-706-017-113), and must be installed concurrently with an approved aft cabin intercom system.
 - Internal rescue hoist (214-706-003-107) requires installation of provisions (412-706-011-105) and Cable Guard (412-706-017-113). Required seat removals dependent on hoist position installation. Seat removal not included in weight.
 - The 412-706-006-105 3 Place Litter Kit is FAA certified. Weight includes removal of Row 1 and Row 2 standard airline seats, and one attendant seat installed.
 - Battery-driven engine starts with the standard 40 Amp Hour NiCad battery are limited to aircraft cold-soak temperatures above 0 °C (32 °F) For battery-driven engine starts down to aircraft cold-soak temperatures of -25 °C (-13 °F) a 53 Amp-Hour battery is required.
 - Utility Seating is available on U. S. registered helicopters ONLY with the addition of the STC'd Alpine 412 Passenger Shoulder harness Kit.
 - The Wire Strike Kit is a RECOMMENDED extra cost option. The customer must specify on the Purchase Agreement for the WSPS Kit NOT to be installed.
 - Low Visibility or High Visibility Main Rotor Blade Paint to be specified by Sales Order.
- STC Kits: Select Supplemental Type Certificated Optional Equipment Kits are available for installation at the Bell Textron Inc. factory. Please contact your Bell Sales Representative for availability and pricing information.

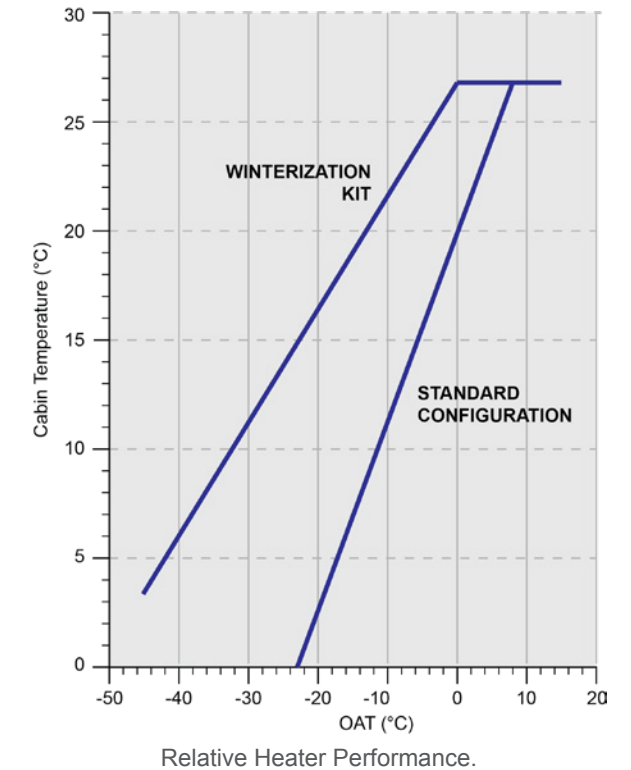

Helicopter Performance Charts

IGE Hover Performance and OGE Hover Performance charts are presented in a revised format which should simplify the comparison of Weight Altitude Temperature (WAT) limited Take Off and Landing Capability and the Hover Capability for known favorable wind conditions.



Helicopter Performance Charts

IGE HOVER PERFORMANCE, COMBINED WAT LIMITED AND HOVER CAPABILITY

Conditions:

- 10 or more passenger seats, BLR Strake and FastFin® and 9 or less passenger seats
- AEO takeoff power
- Heater off
- 100% RPM

Compare hover capability (found in the top chart) with WAT limitations (found in the bottom chart). The correct hover performance is the lower of the two gross weights determined.

Example:

- Wanted: IGE hover weight for the 9 or less passenger seat configuration
- Known: Pressure Altitude = 10,000 ft, OAT = 20 °C

Method:

1. To determine the IGE hover weight, enter the IGE hover capability chart at a pressure altitude of 10,000 ft. Move horizontally to the right to intersect the 20 °C line. Move vertically down to read a hover capability of 11,000 lb.
2. To determine the WAT limited gross weight, enter the IGE WAT limitation chart at 20 °C. Drop vertically down to intersect the 10,000 ft pressure altitude line. Move horizontally to the right to intersect the 9 or less passenger seats WAT line. Move vertically up to read 10,140 lb. This is the WAT limited gross weight.
3. The lower of Step 1 and Step 2 will result in a correct IGE hover weight of 10,140 lb.

For IGW hover performance refer to BHT-412-FMS-74.5

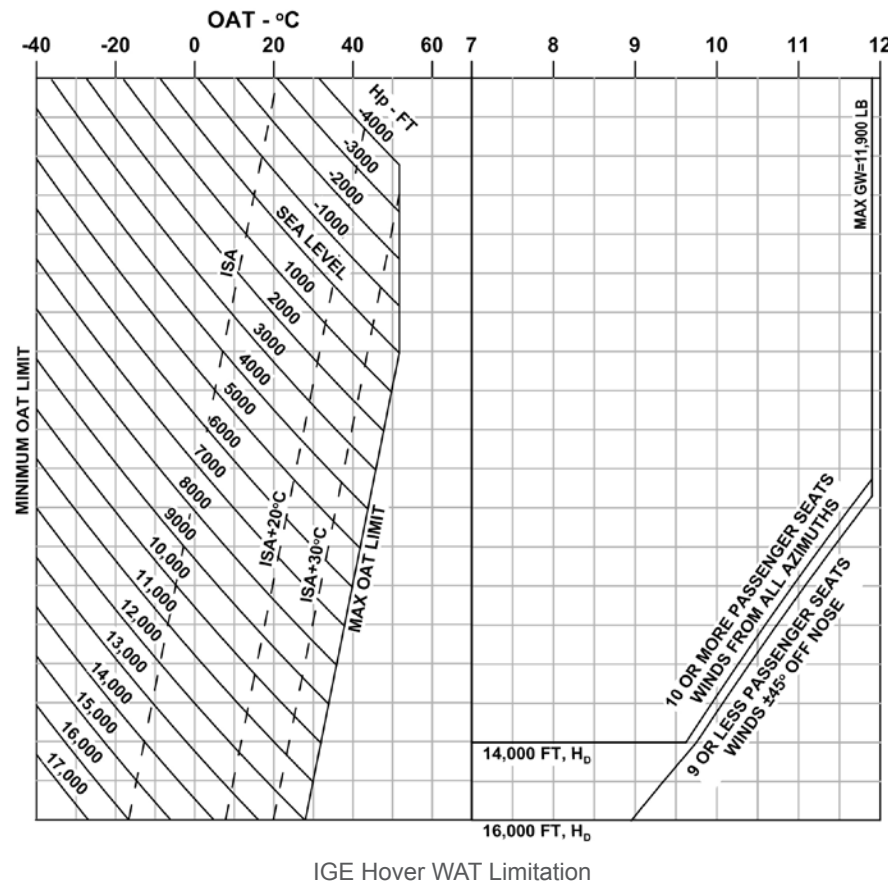
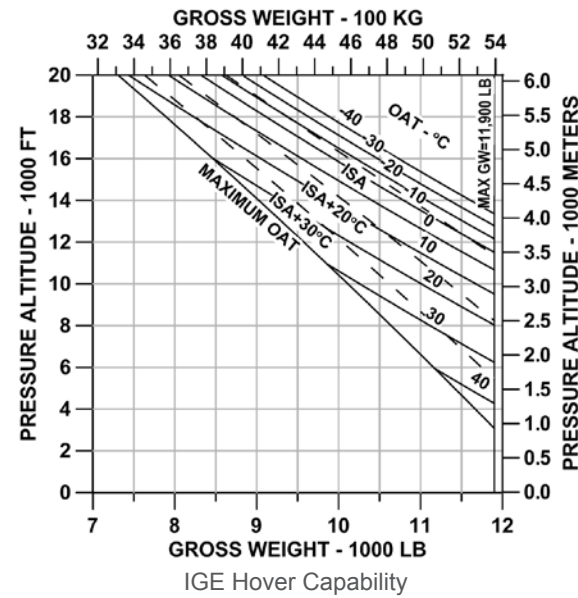

Helicopter Performance Charts

OGE HOVER PERFORMANCE, COMBINED WAT LIMITED AND HOVER CAPABILITY

Conditions:

- 10 or more passenger seats, BLR Strake and FastFin® and 9 or less passenger seats
- AEO takeoff power
- Heater off
- 100% RPM

Compare hover capability (found in the top chart) with WAT limitations (found in the bottom chart). The correct hover performance is the lower of the two gross weights determined.

Example:

- Wanted: OGE hover weight for the 9 or less passenger seat configuration
- Known: Pressure Altitude = 10,000 ft, OAT = 20 °C

Method:

1. To determine the OGE hover weight, enter the OGE hover capability chart at a pressure altitude of 10,000 ft. Move horizontally to the right to intersect the 20 °C line. Move vertically down to read a hover capability of 9,300 lb.
2. To determine the WAT limited gross weight, enter the OGE WAT limitation chart at 20 °C. Drop vertically down to intersect the 10,000 ft pressure altitude line. Move horizontally to the right to intersect the 9 or less passenger seats WAT line. Move vertically up to read 9,550 lb. This is the WAT limited gross weight.
3. The lower of Step 1 and Step 2 will result in a correct OGE hover weight of 9,300 lb.

For IGW hover performance refer to BHT-412-FMS-74.5

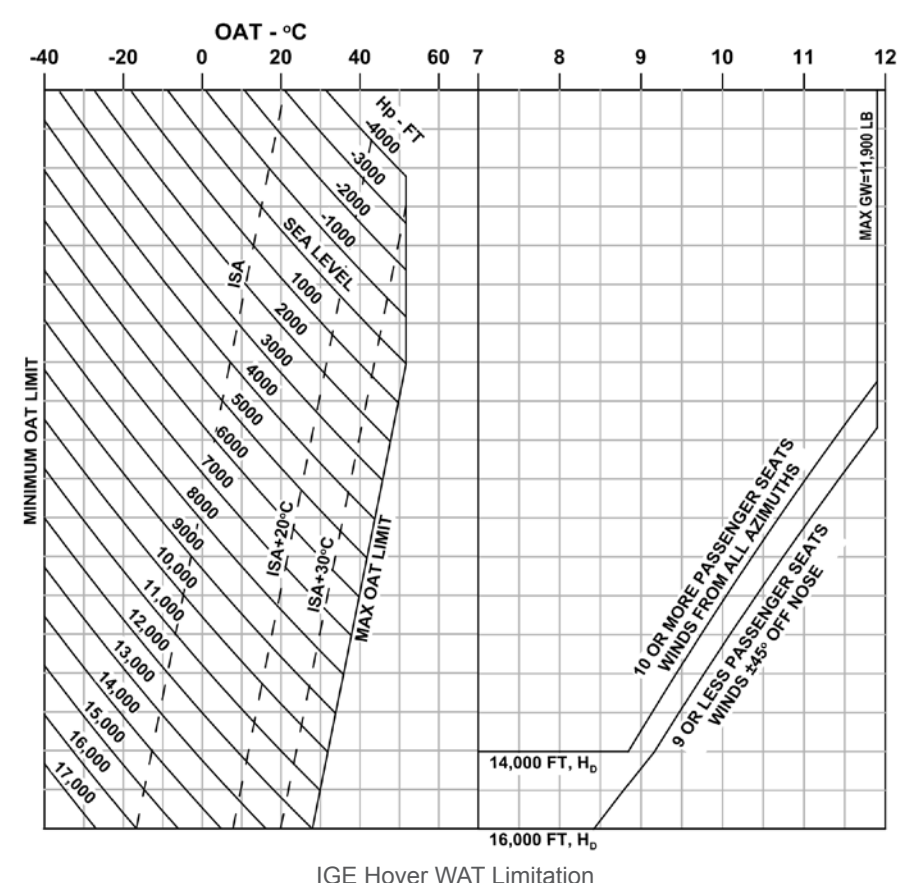
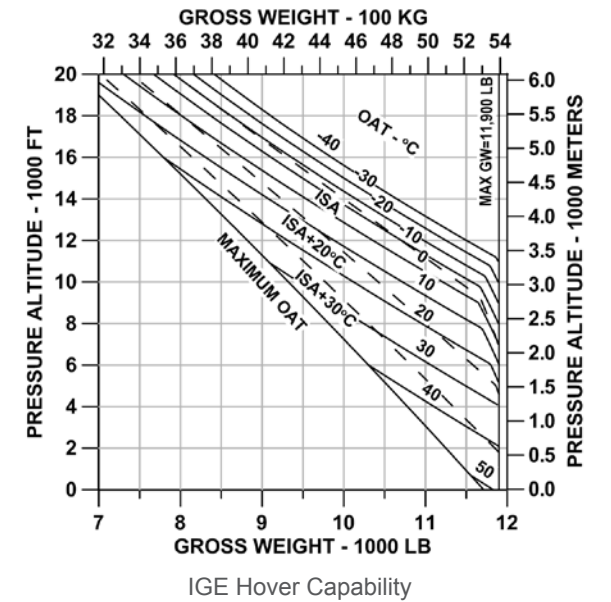

Helicopter Performance Charts

SERVICE CEILING

Conditions:

- Twin engine operation at maximum continuous power

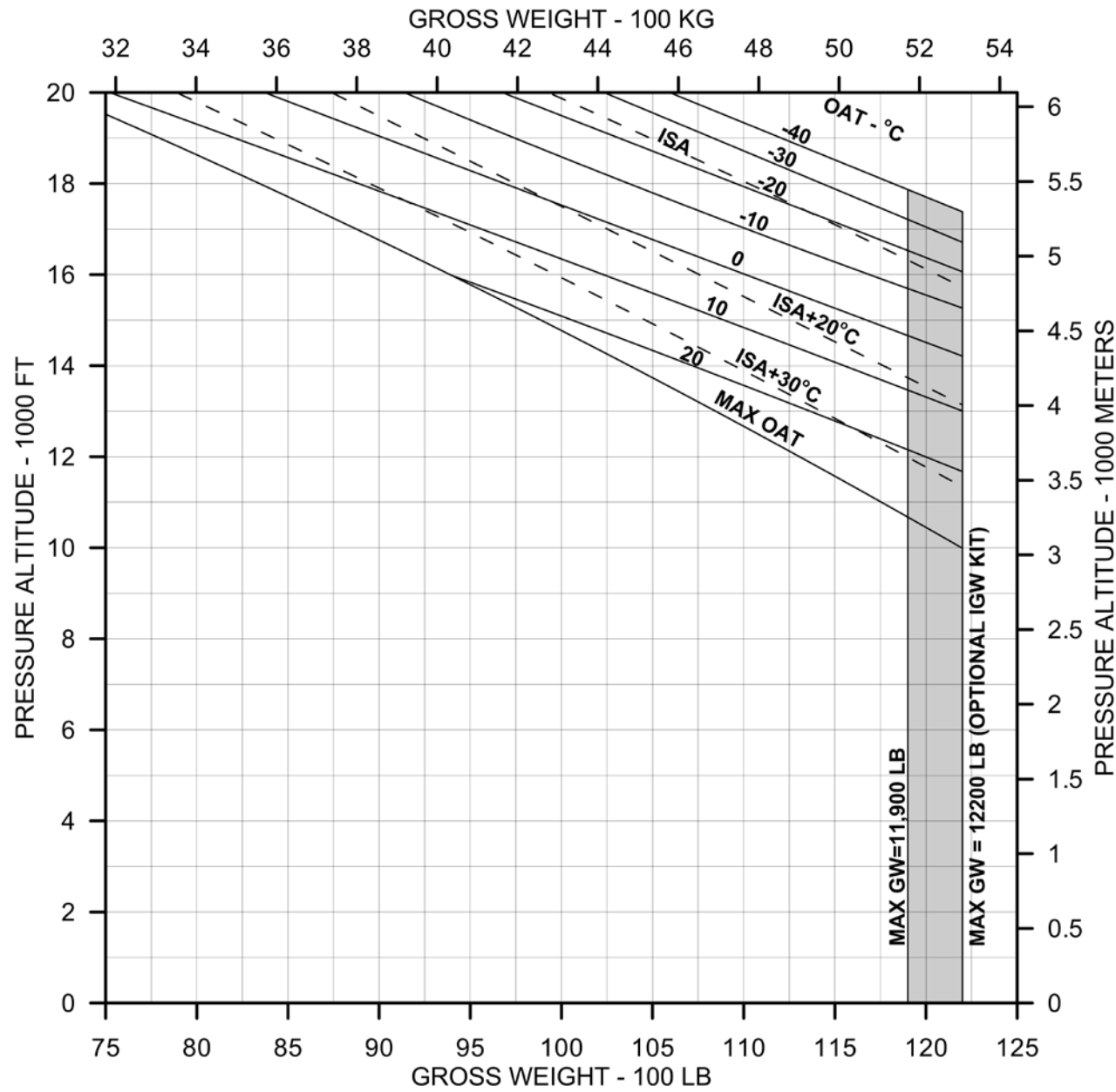

Helicopter Performance Charts

SERVICE CEILING

Conditions:

- Single engine operation at continuous OEI power

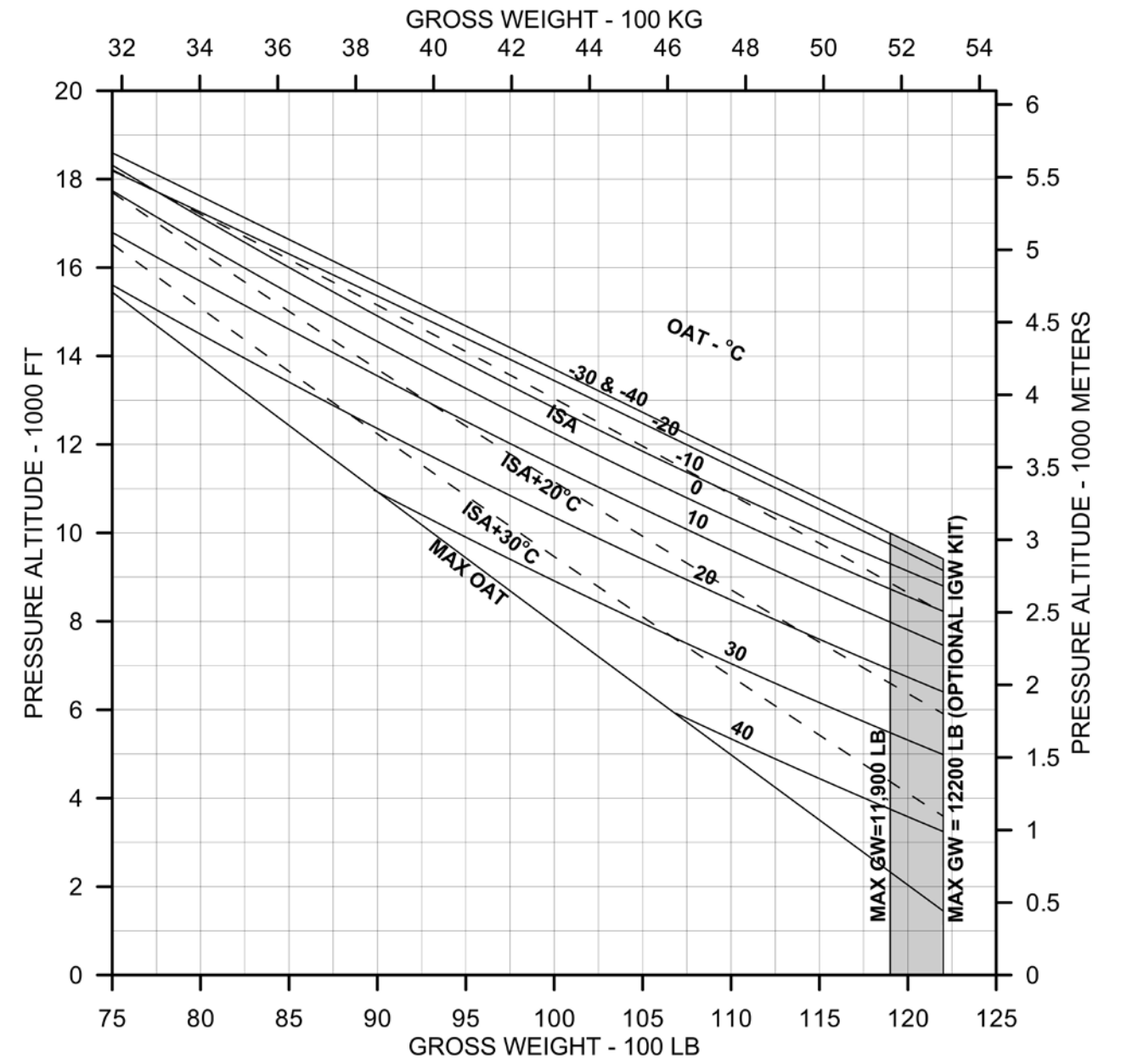

Helicopter Performance Charts

CATEGORY "A" PERFORMANCE

Conditions:

- Backup Profile - for ground level helipads or elevated helipads where no drop-down below the takeoff surface is allowed.
- Side Step Profile - for elevated helipads with allowable drop down
- Runway Profile - for runways and short fields

Equipment required (installed and functional) to perform Category A operations:

All profiles

- Radar altimeter (visible to both pilots)

Side Step Profile only

- Dual Controls
- Copilot instruments
- Pilot and Copilot ICS

Note: Category A operations using all three profiles may be flown single (right seat only) or dual pilot.

Information on the following pages provides a brief explanation of Category A Operation capability for the Bell 412EPI with the P&WC PT6T-9. The WAT charts included may be used to determine takeoff or landing weight capability. Additional information is available in the FAA approved rotorcraft flight manual supplement, BHT-412-FMS-62.5.

DEFINITIONS

Category "A" Takeoff	Operation of the helicopter in such a manner that if one Engine fails at any time after the start of the takeoff the Helicopter can: <ol style="list-style-type: none"> 1. Prior to the Takeoff Decision Point (TDP), return to and safely stop on the takeoff area; or 2. At or after the TDP, climb out from the point of failure and attain single engine forward flight.
Category "A" Landing	Operation of the helicopter in such a manner that if one engine fails at any time during the landing approach the Helicopter can: <ol style="list-style-type: none"> 1. At or prior to the Landing Decision Point (LPD), climb out from the point of failure and attain single engine forward flight; or 2. After the LPD, safely stop on the landing area.

Helicopter Performance Charts

CATEGORY "A" NORMAL TAKEOFF - BACKUP PROFILE

Conditions:

- Category A Backup Profile Normal takeoff (AEO) from ground level and elevated helipads with all engines operating

BACKUP PROFILE EXPLANATION

Backup Profile Takeoff Profile (Day and Night)	The takeoff technique consists of a vertical/rearward takeoff to the TDP (100 ft or higher based on density altitude); then acceleration and subsequent climbout at V_y (70 kias), to 1,000 ft.
Ground Level or Elevated Helipad	For a ground level or elevated helipad the associated takeoff and landing limit chart assures 15 ft (4.6 m) ground level clearance in case of an engine failure at or after TDP. The minimum helipad is a circular landing pad 60 ft (18.3 m) in diameter.

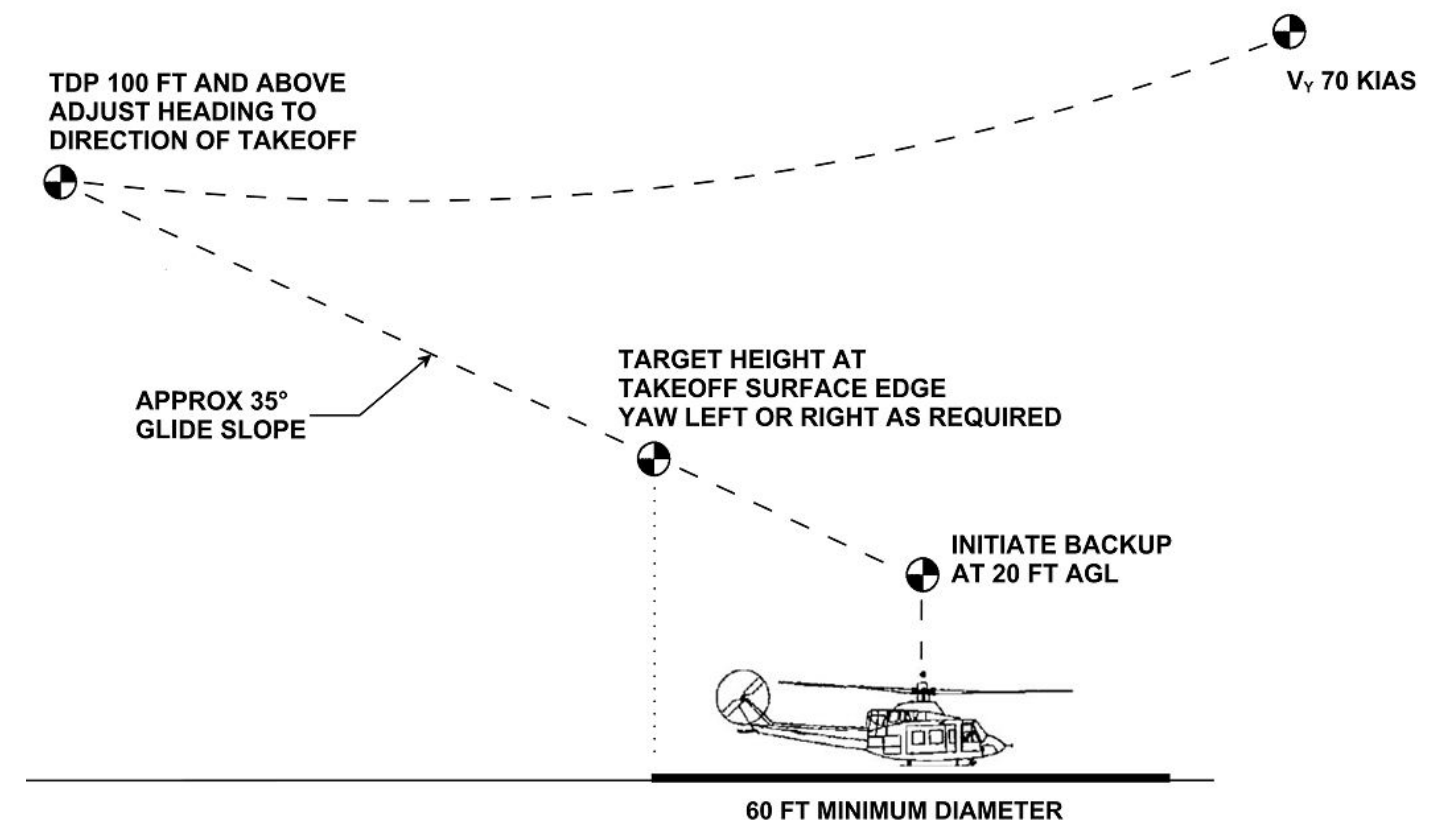

Normal takeoff (AEO) with all engines operating.

Helicopter Performance Charts

CATEGORY "A" NORMAL LANDING - BACKUP PROFILE

Conditions:

- Normal landing (AEO) to ground level or elevated helipad with all engines operating

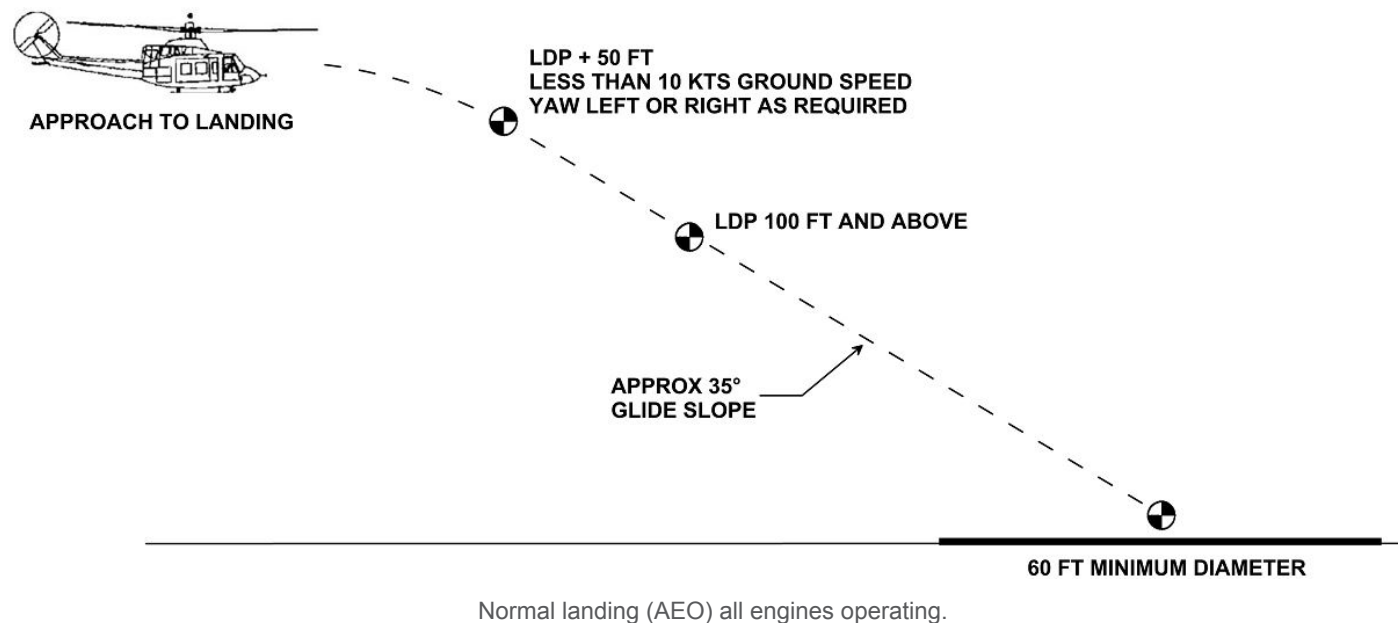

CATEGORY "A" EMERGENCY TAKEOFF OR LANDING - BACKUP PROFILE

Conditions:

- One Engine Inoperative (OEI)
- V_{ROT} = Rotate speed (velocity where airspeed indicator has perceptible motion).

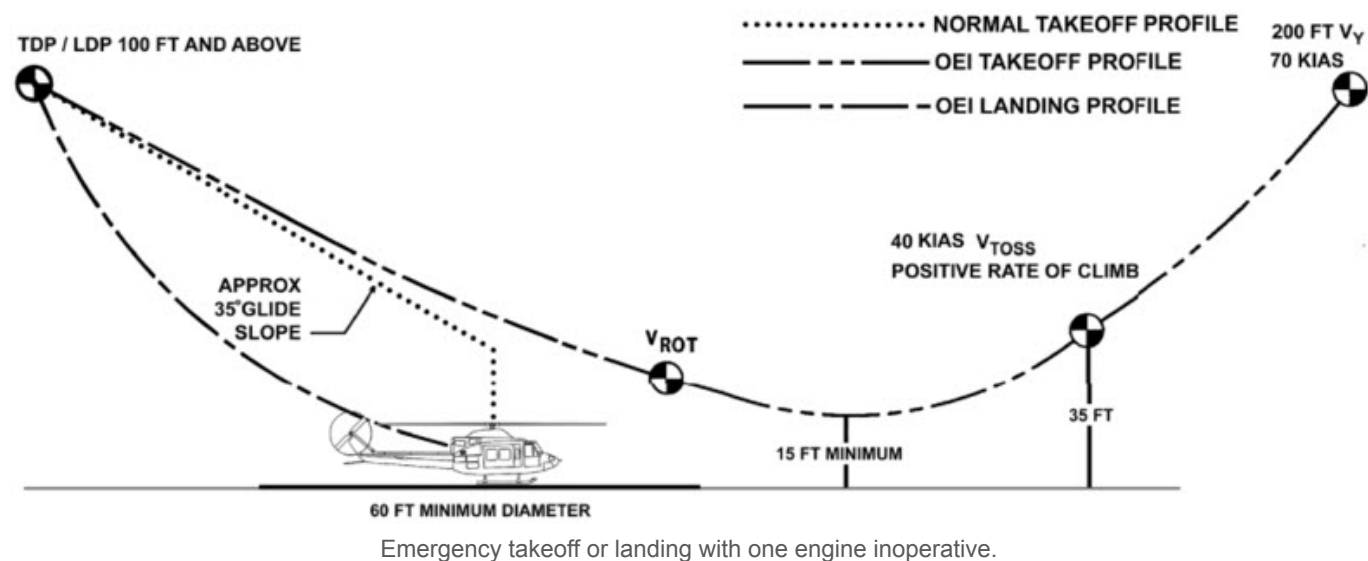

Helicopter Performance Charts

CATEGORY "A" TAKEOFF AND LANDING LIMIT - BACKUP PROFILE

Conditions:

- Ground level or elevated helipad (day and night)
- 103% rotor RPM (AEO)

Method:

1. Enter the chart at the pressure altitude of the takeoff / landing helipad
2. Follow the graph line horizontally to the appropriate OAT (outside air temperature) trend line.
3. Follow the graph line vertically to the appropriate gross weight capability with zero headwind.
4. To account for headwind follow the graph line vertically from the zero headwind gross weight down to headwind chart, and follow guideline until appropriate headwind horizontal line is reached.
5. From that point move vertically downward to determine takeoff gross weight capability with unfactored headwind.

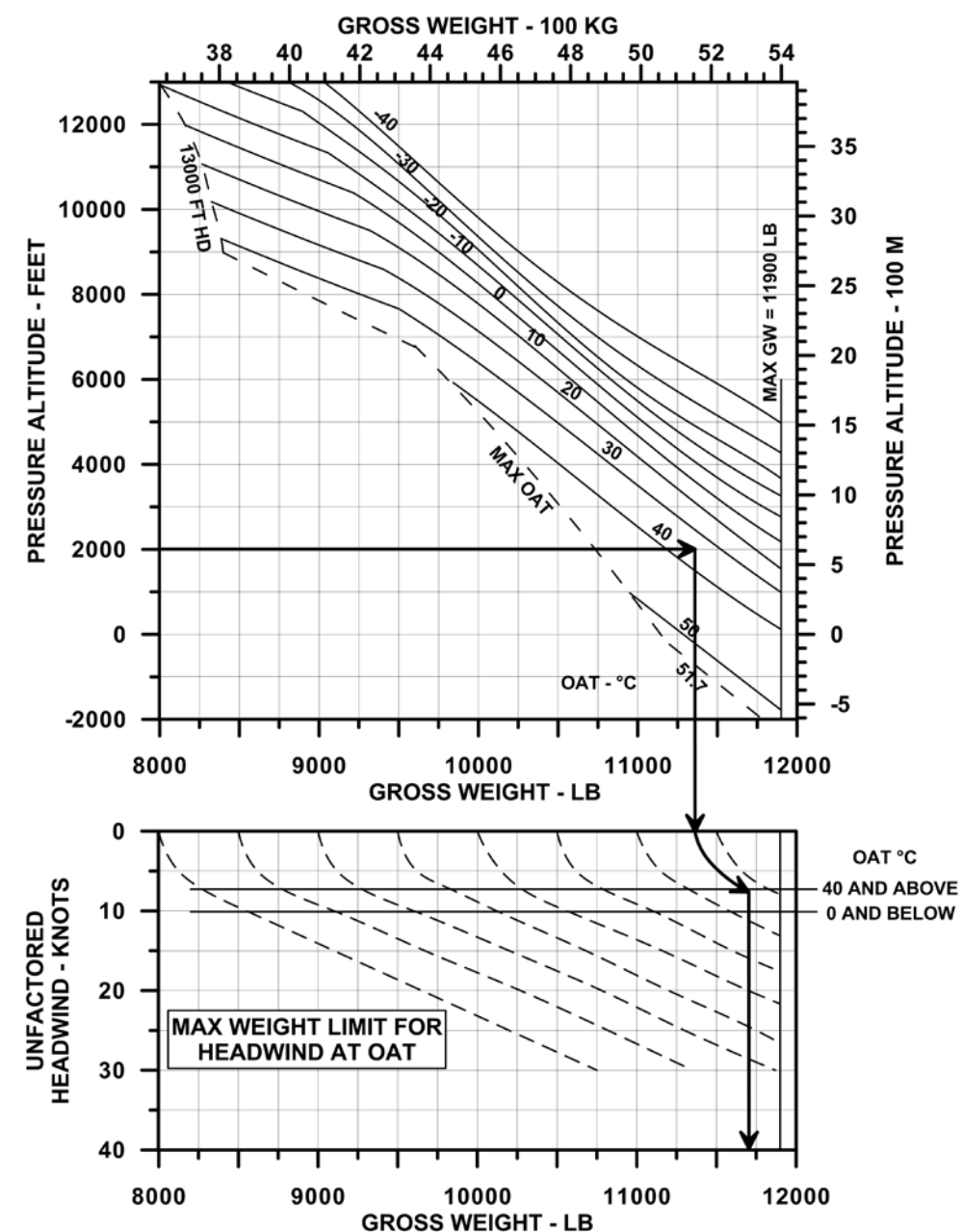

Note: Category A takeoff and landing using the Backup profile has not been demonstrated and is not approved above 13,000 ft (3,962 m) density altitude.

Helicopter Performance Charts

CATEGORY "A" NORMAL TAKEOFF - SIDE STEP PROFILE

Conditions:

- Normal takeoff (AEO) from elevated platform with all engines operating

SIDE STEP PROFILE EXPLANATION

Elevated Helipad Takeoff Profile (Day and Night)	The takeoff technique consists of a vertical takeoff to 35 ft, and lateral movement 35 ft from the center of the helipad to the TDP; then acceleration and subsequent climbout at V_y (70 kias), to 1,000 ft.
Elevated Helipad	For a helipad 105 ft (32 m) high or greater, the associated takeoff and landing limit chart assures 15 ft (4.6 m) vertical obstacle clearance after TDP. Additional charts are available in the rotorcraft flight manual supplement for reduced drop down height. The minimum elevated helipad dimensions are 60 x 60 ft (18.3 x 18.3 m) and must be positioned so that one edge is within 30 ft (9.1 m) of a vertical drop.

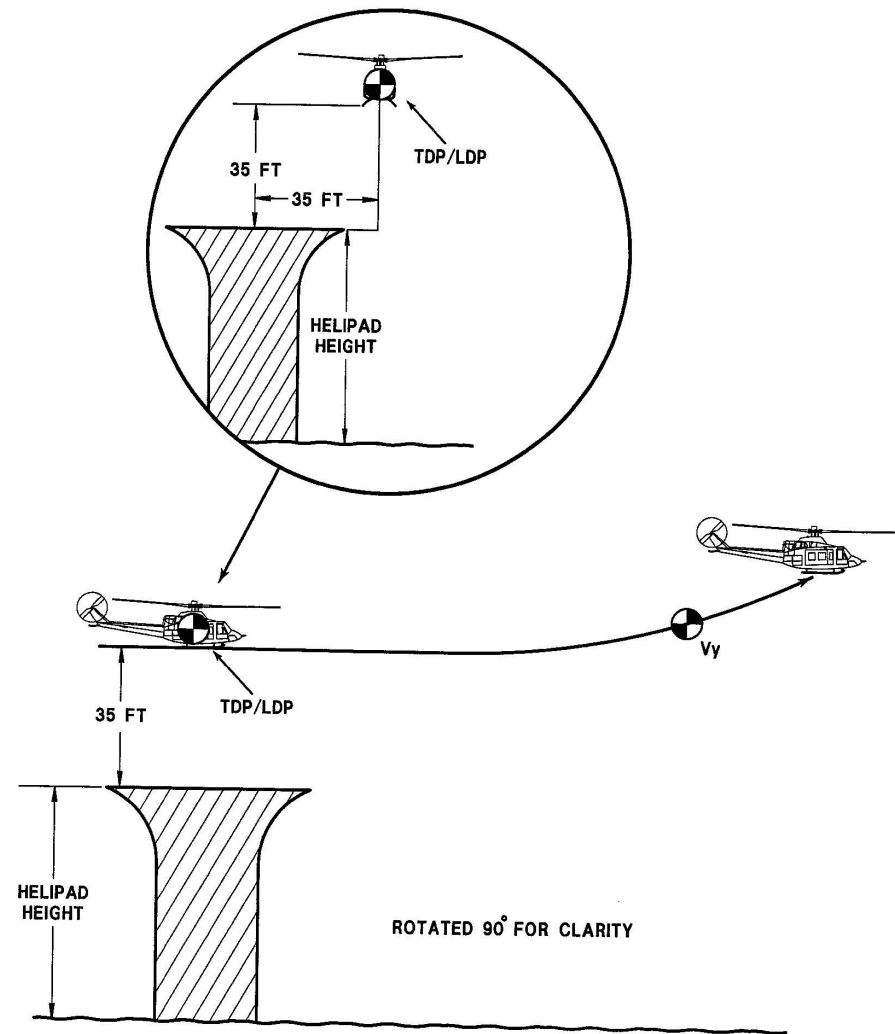

Normal takeoff (AEO) from elevated platform with all engines operating.

Helicopter Performance Charts

CATEGORY "A" EMERGENCY TAKEOFF - SIDE STEP PROFILE

Conditions:

- Emergency takeoff or landing (OEI) from elevated platform with one engine inoperative
- V_{ROT} = Rotate speed (velocity where airspeed indicator has perceptible motion).

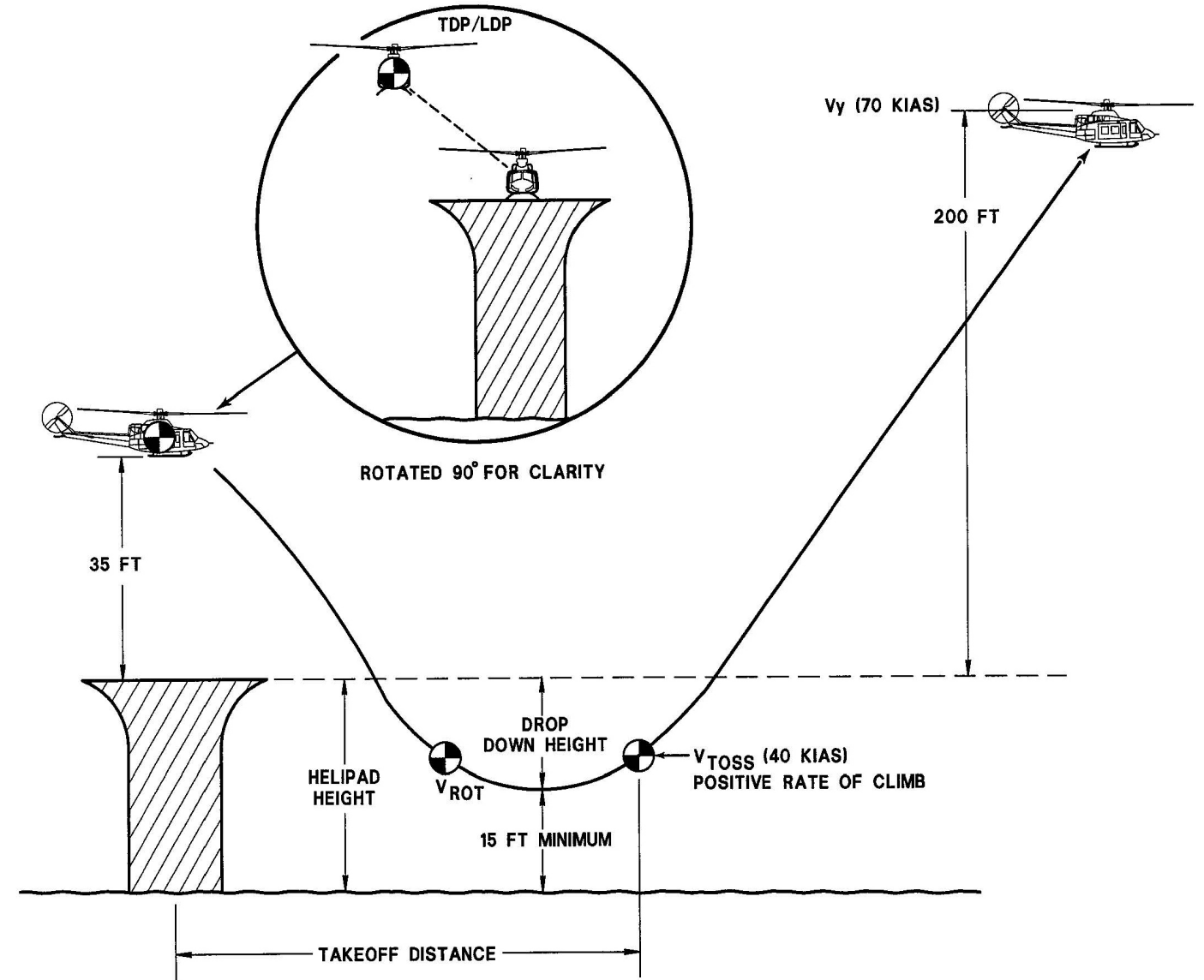

Emergency takeoff or landing (OEI) from elevated platform with one engine inoperative.

Helicopter Performance Charts

CATEGORY "A" TAKEOFF AND LANDING LIMIT - SIDE STEP PROFILE

Conditions:

- Elevated helipad (day and night) with at least 105 ft helipad elevation for a 15 ft minimum clearance. Additional performance is available for lower helipads in BHT-412-FMS-62.5 or using the Backup Profile.
- 103% rotor RPM (AEO)

Method:

- Enter the chart at the pressure altitude of the takeoff / landing helipad
- Follow the graph line horizontally to the appropriate OAT (outside air temperature) trend line.
- Follow the graph line vertically to the appropriate gross weight capability with zero headwind.
- To account for headwind follow the graph line vertically from the zero headwind gross weight down to headwind chart, and follow guideline until appropriate headwind horizontal line is reached.
- From that point move vertically downward to determine takeoff gross weight capability with unfactored headwind.

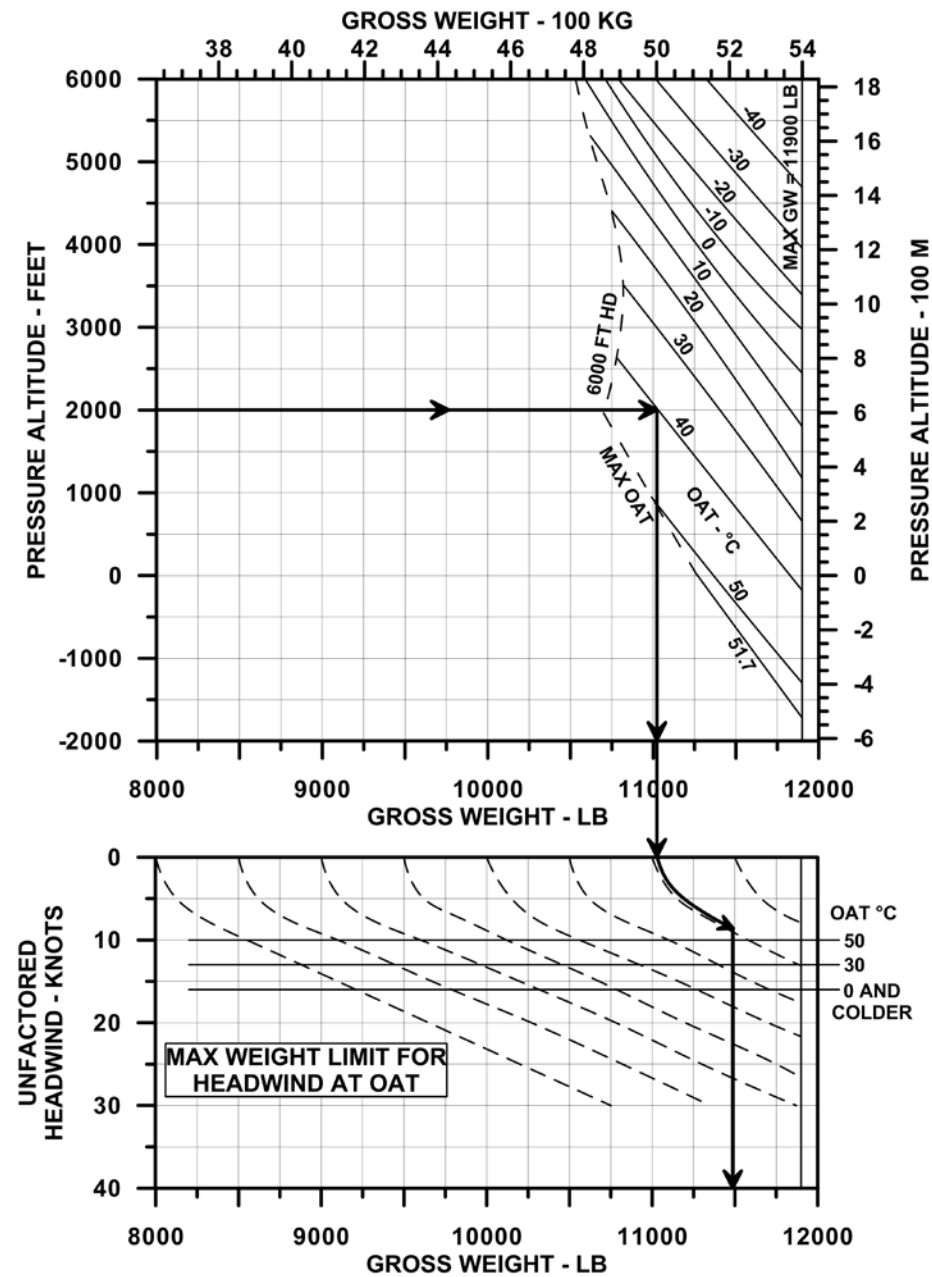

Note: Category A takeoff and landing with the side step profile has not been demonstrated and is not approved above 6,000 ft (1,829 m) density altitude.

Helicopter Performance Charts

CATEGORY "A" NORMAL TAKEOFF AND LANDING - RUNWAY PROFILE

Conditions:

- Normal takeoff (AEO) from runway or short field with all engines operating

RUNWAY PROFILE EXPLANATION

Runway Profile Takeoff (Day and Night)	The takeoff technique is initiated from a 10 ft hover and has a time based TDP that is variable with density altitude. Acceleration to V_{TOSS} (40 kias), with subsequent climb out at V_Y (70 kias), to 1,000 ft.
Runway Profile Landing (Day and Night)	The landing is a normal approach to the runway at V_{TOSS} and less than 500 feet per minute rate of descent.
Runway and Short Field	The Runway profile can be flown to a runway or short field with a minimum runway length of 625 ft (190.5 m). Longer runways may be required at higher density altitudes..

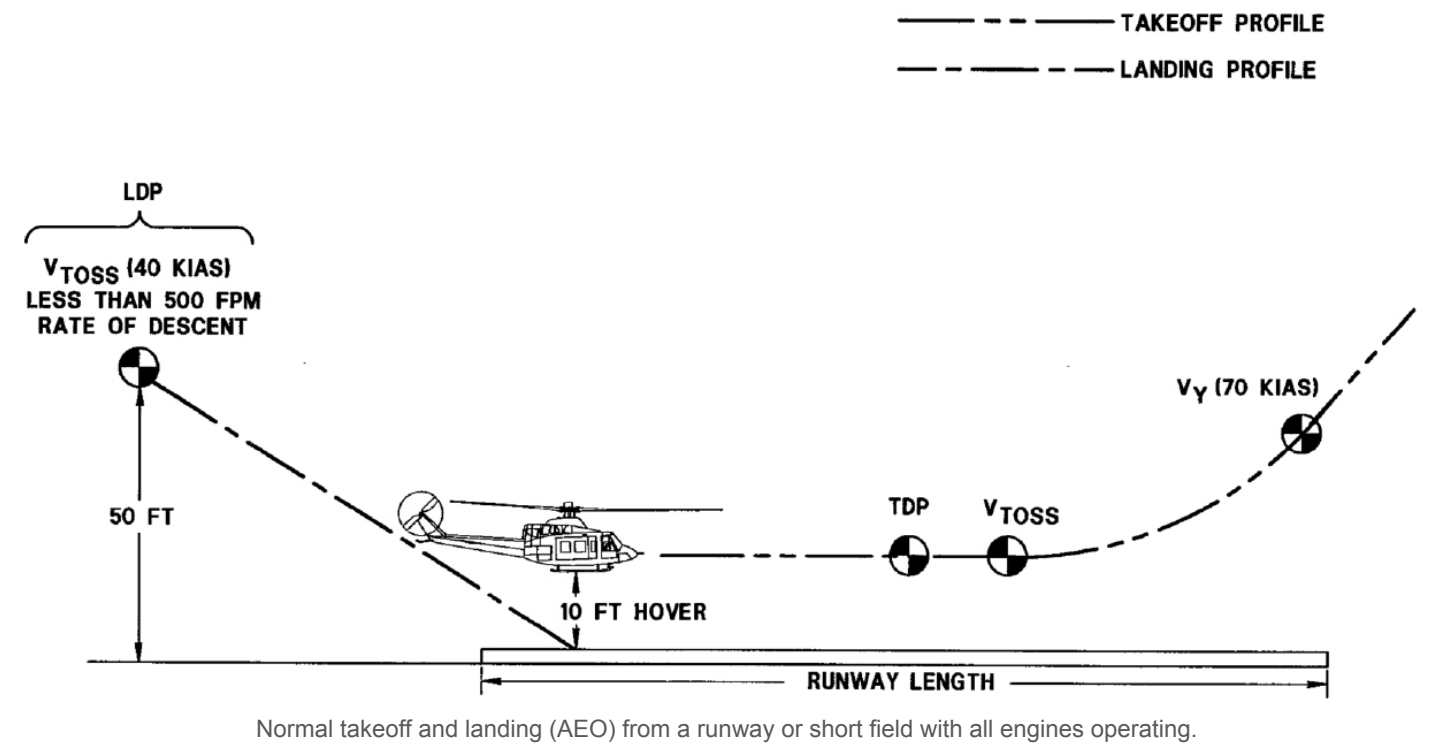

Normal takeoff and landing (AEO) from a runway or short field with all engines operating.

Helicopter Performance Charts

CATEGORY "A" EMERGENCY TAKEOFF AND LANDING - RUNWAY PROFILE

Conditions:

- Emergency takeoff or landing (OEI) from a runway or short field with one engine inoperative
- V_{ROT} = Rotate speed (velocity where airspeed indicator has perceptible motion).

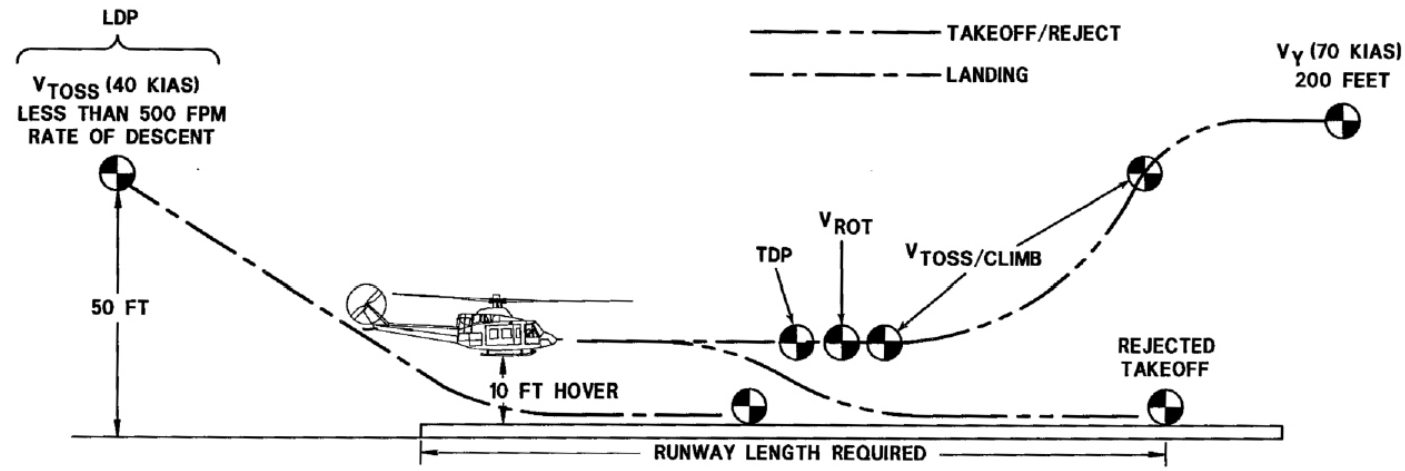

Emergency takeoff and landing (OEI) from a runway or short field with one engines inoperative.

Helicopter Performance Charts

CATEGORY "A" TAKEOFF AND LANDING - RUNWAY PROFILE

Conditions:

- Runway or short field (day and night)
- 103% rotor RPM (AEO)

Method:

1. Enter the chart at the pressure altitude of the takeoff / landing runway
2. Follow the graph line horizontally to the appropriate OAT (outside air temperature) trend line.
3. Follow the graph line vertically to the appropriate gross weight capability.

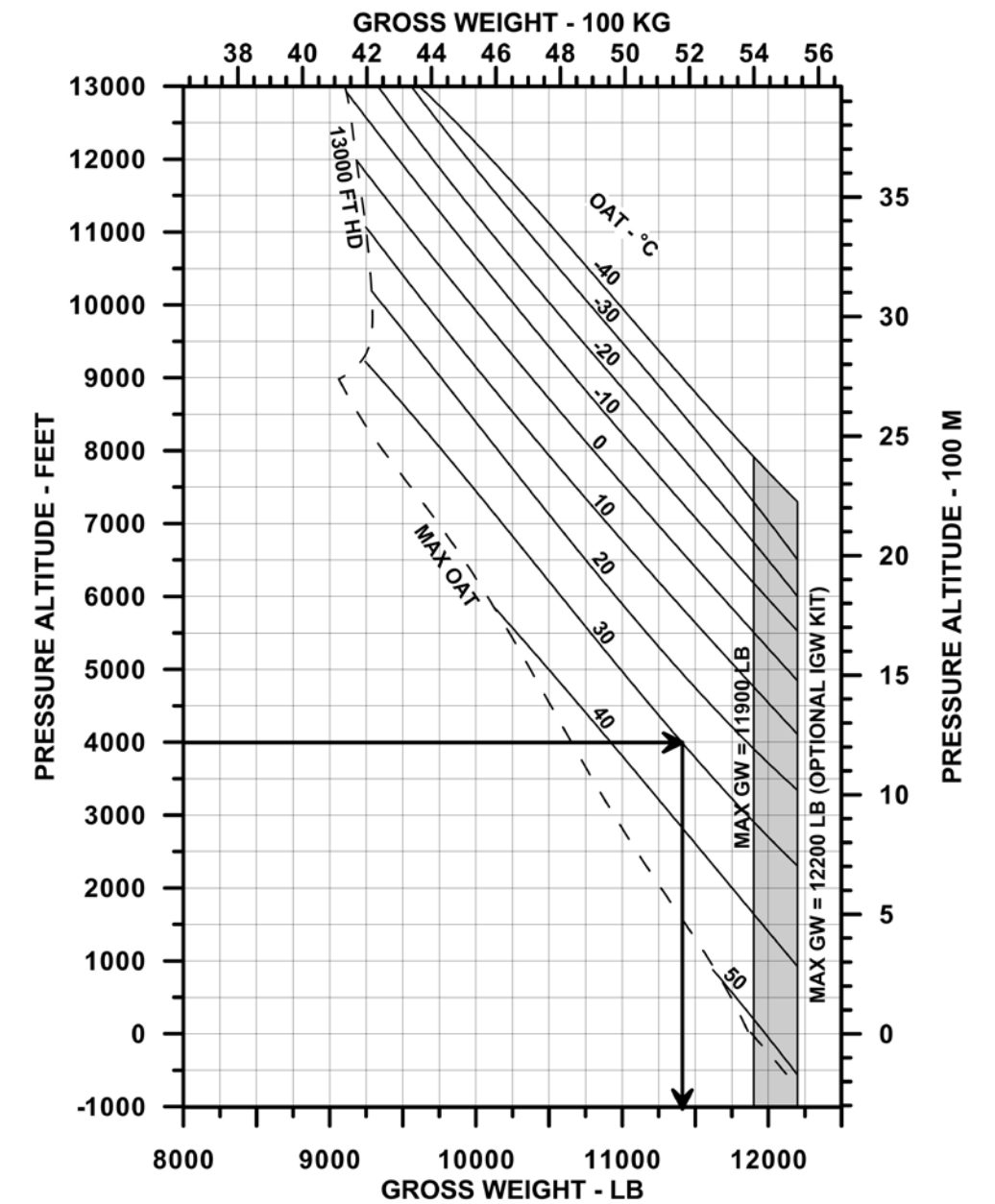

Note: Category A takeoff and landing with the runway profile has not been demonstrated and is not approved above 6,000 ft (1,829 m) density altitude.

Fuel Flow vs. Airspeed Charts

Fuel Flow vs. Airspeed chart data based on the following conditions:

- ISA & ISA+20°C
- Pratt & Whitney Canada PT6T-9 engine
- Heater off
- Zero wind
- AUTO RPM mode
- Performance at 12,200 lb is for the optional Increased Gross Weight Kit

Note: The best allowable cruise speed is either Long Range Cruise Speed (LRC) or when speed is limited by Maximum Continuous Cruise Power (MCP) or V_{NE} , the maximum speed permitted.



Fuel Flow vs. Airspeed

PRESSURE ALTITUDE = SEA LEVEL, OAT = 15°C (ISA)

Conditions:

- Twin engine operations (97% RPM)

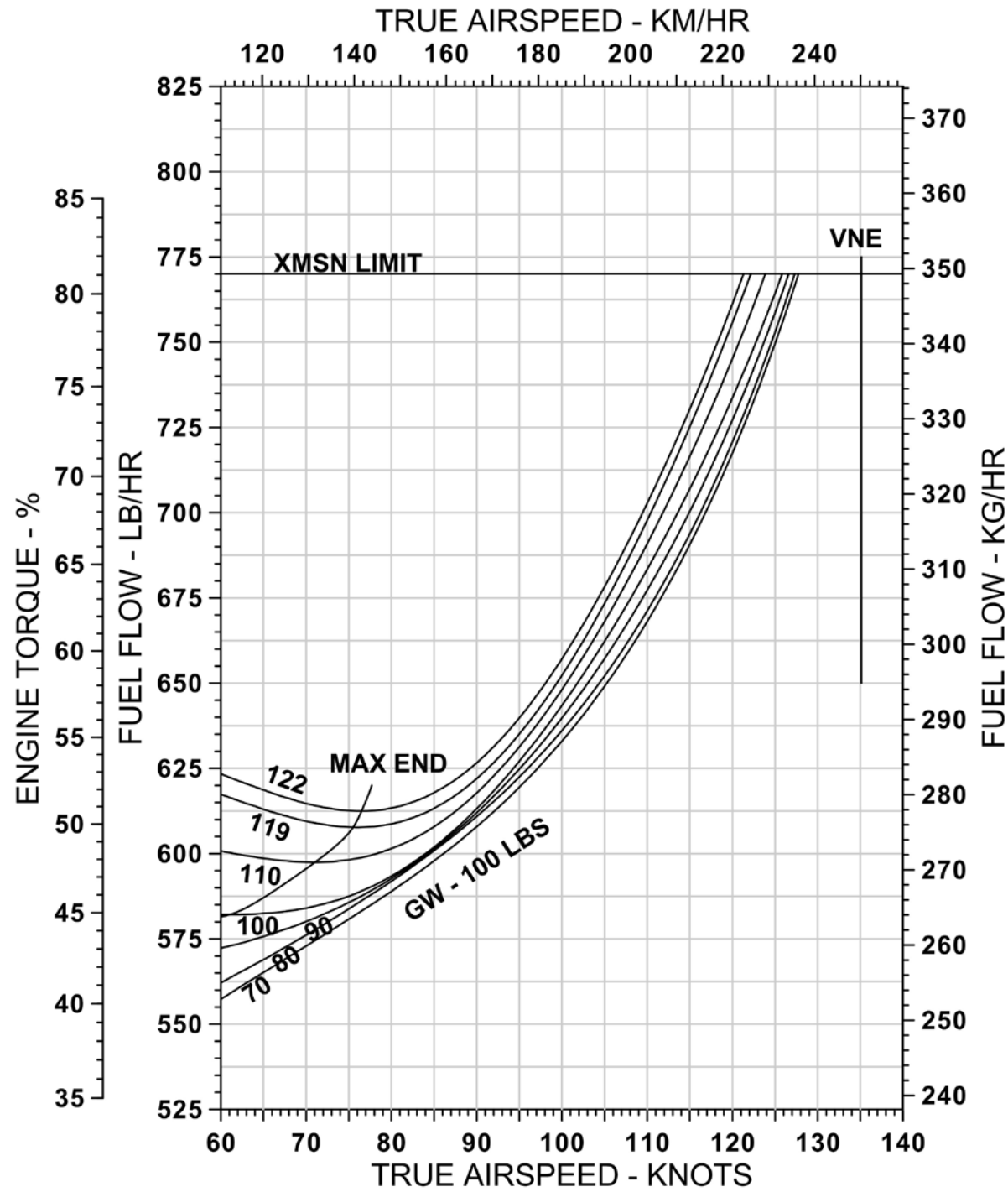

Fuel Flow vs. Airspeed

PRESSURE ALTITUDE = 4,000 FEET, OAT = 7 °C (ISA)

Conditions:

- Twin engine operations (97% RPM)

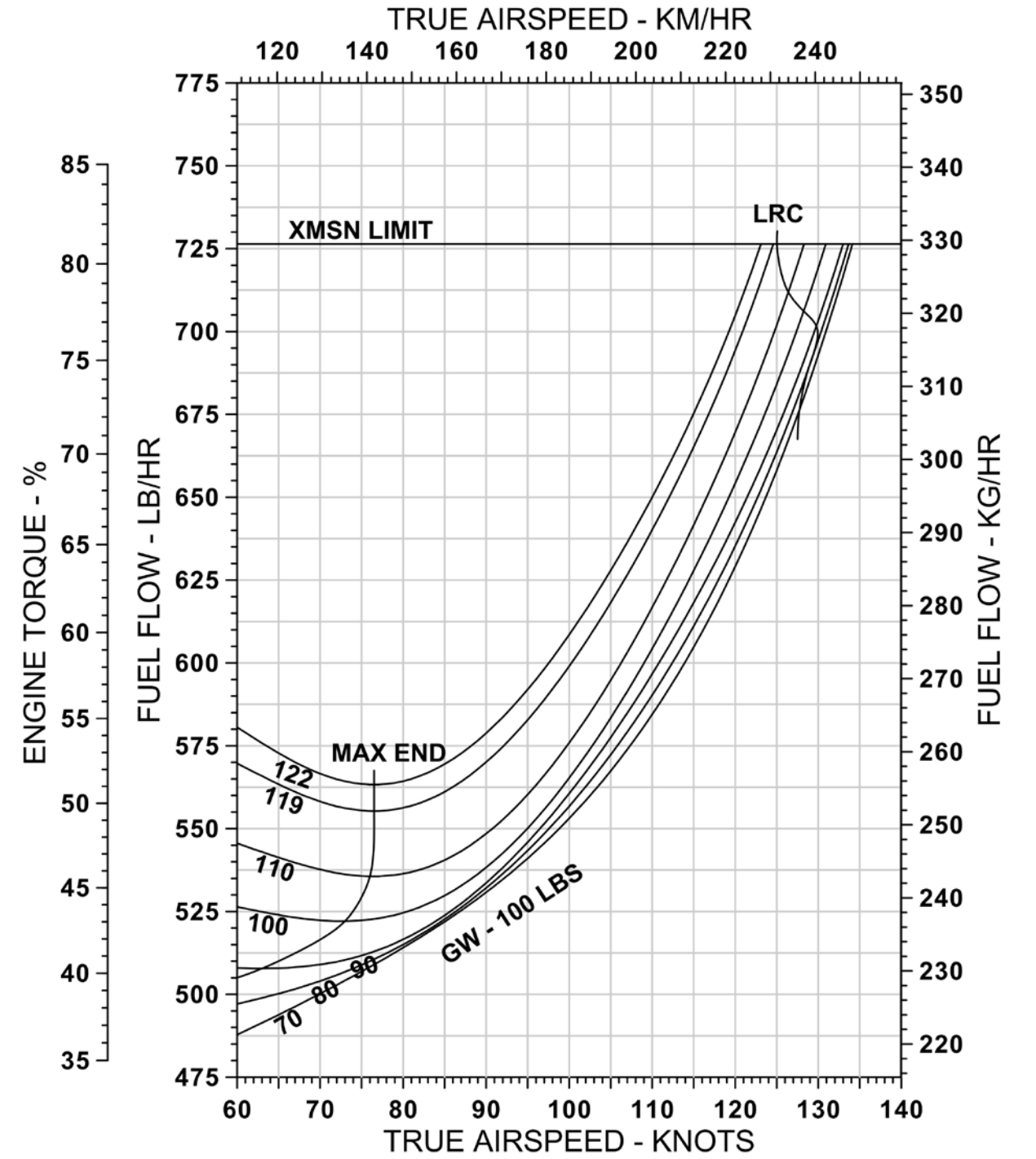

Fuel Flow vs. Airspeed

PRESSURE ALTITUDE = 8,000 FEET, OAT = -1 °C (ISA)

Conditions:

- Twin engine operations (100% RPM)

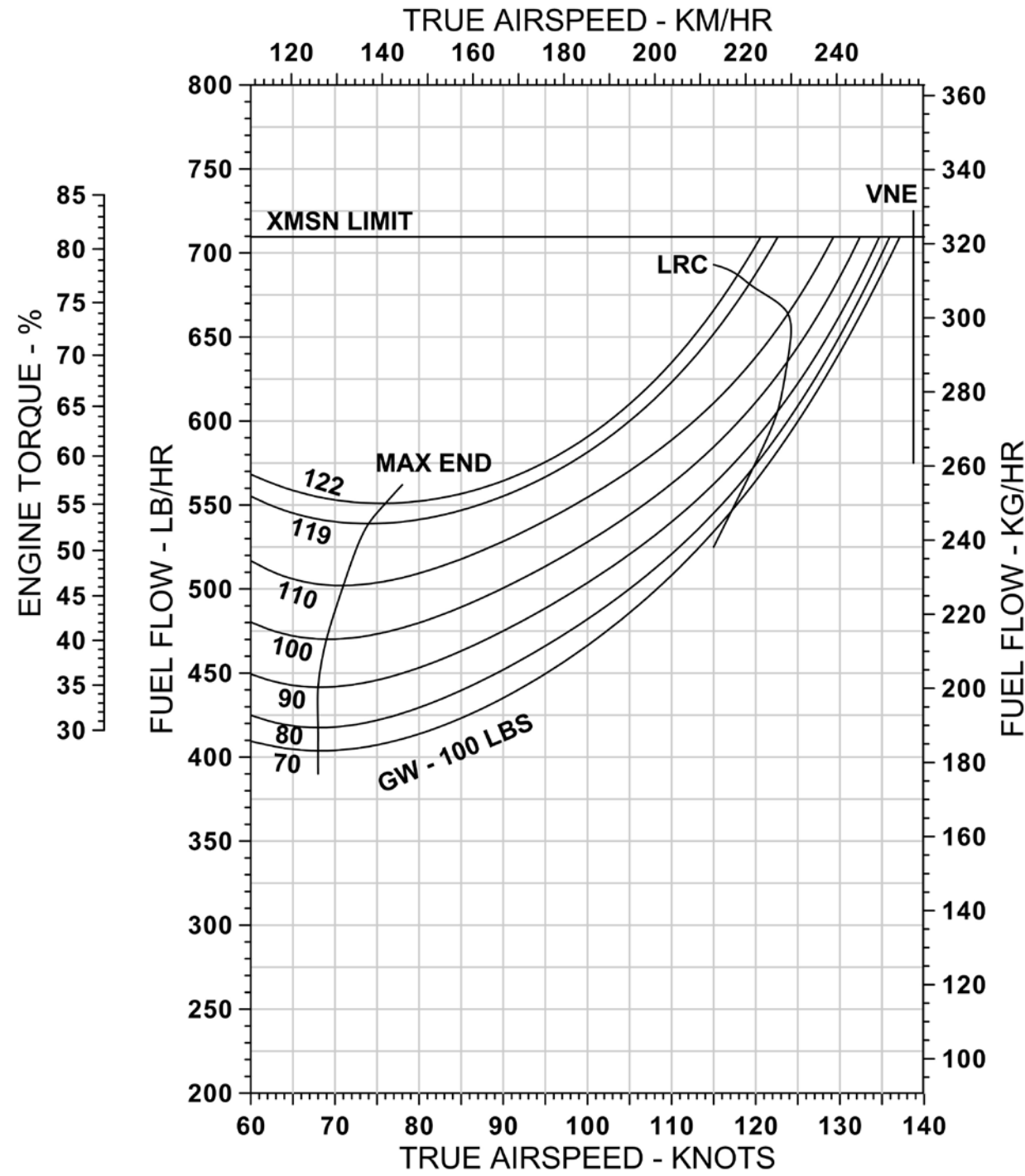

Fuel Flow vs. Airspeed

PRESSURE ALTITUDE = SEA LEVEL, OAT = 35 °C (ISA + 20)

Conditions:

- Twin engine operations (97% RPM)

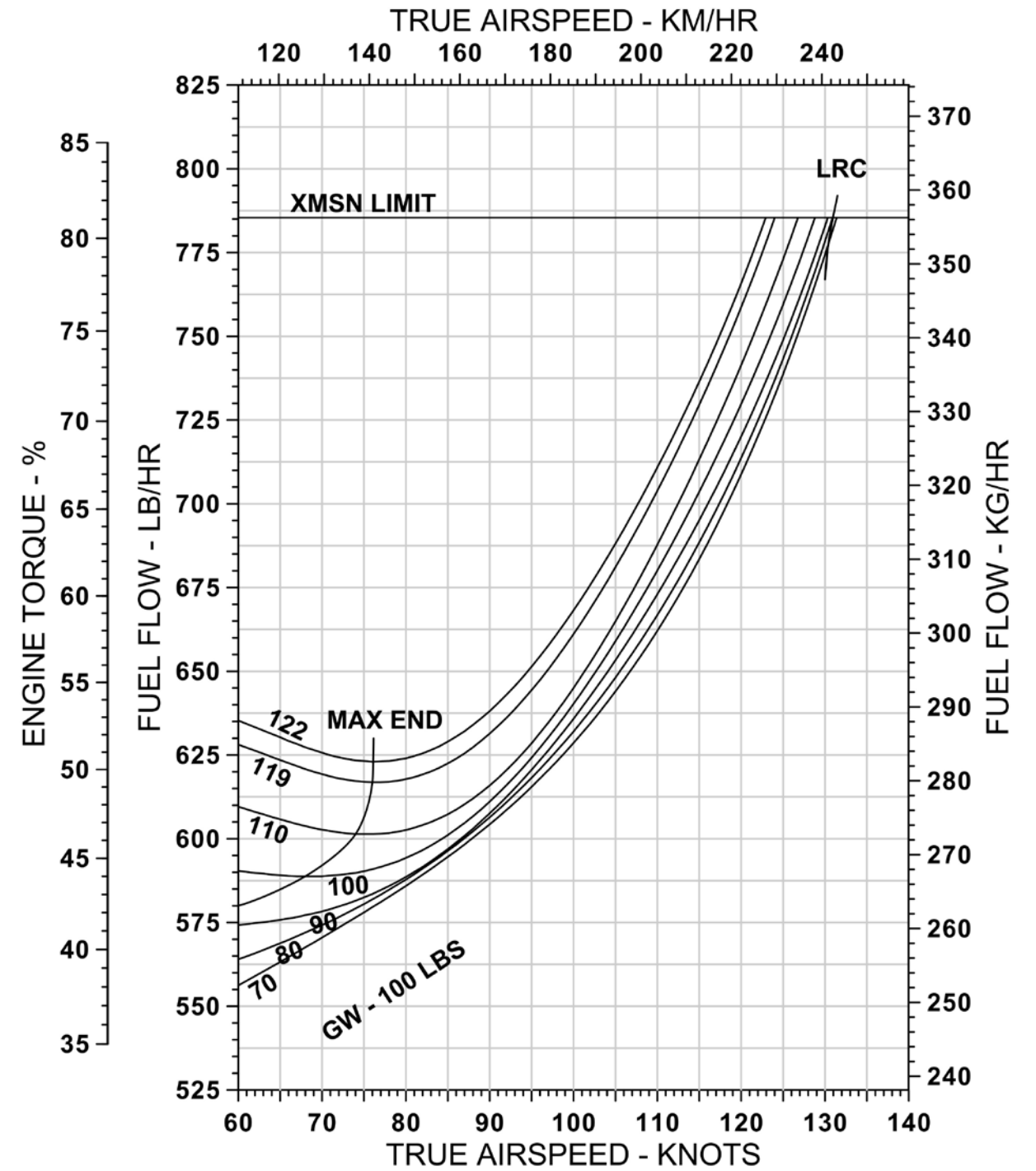

Fuel Flow vs. Airspeed

PRESSURE ALTITUDE = 4,000 FEET, OAT = 27 °C (ISA + 20)

Conditions:

- Twin engine operations (100% RPM)

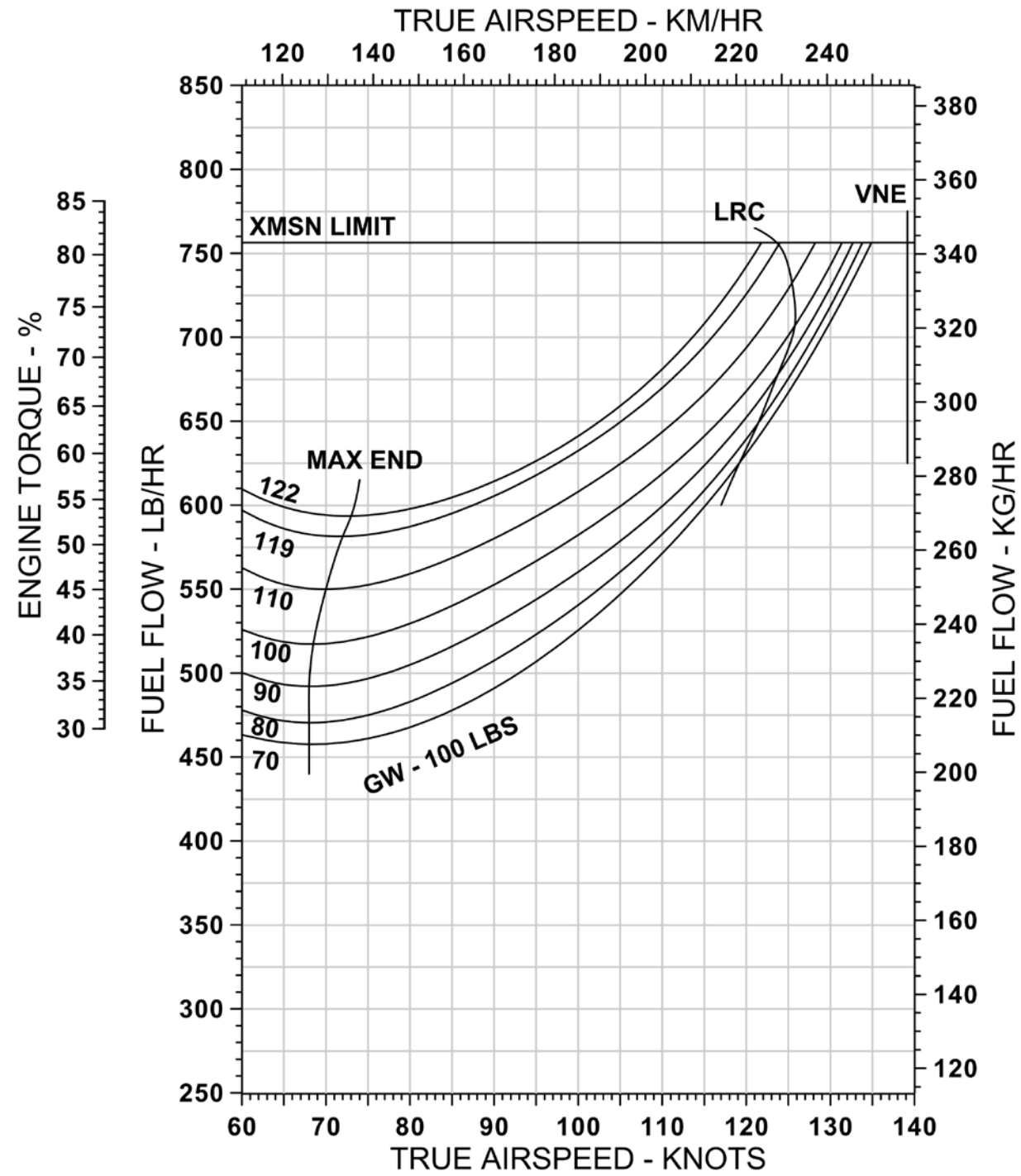

Fuel Flow vs. Airspeed

PRESSURE ALTITUDE = 8,000 FEET, OAT = 19 °C (ISA + 20)

Conditions:

- Twin engine operations (100% RPM)

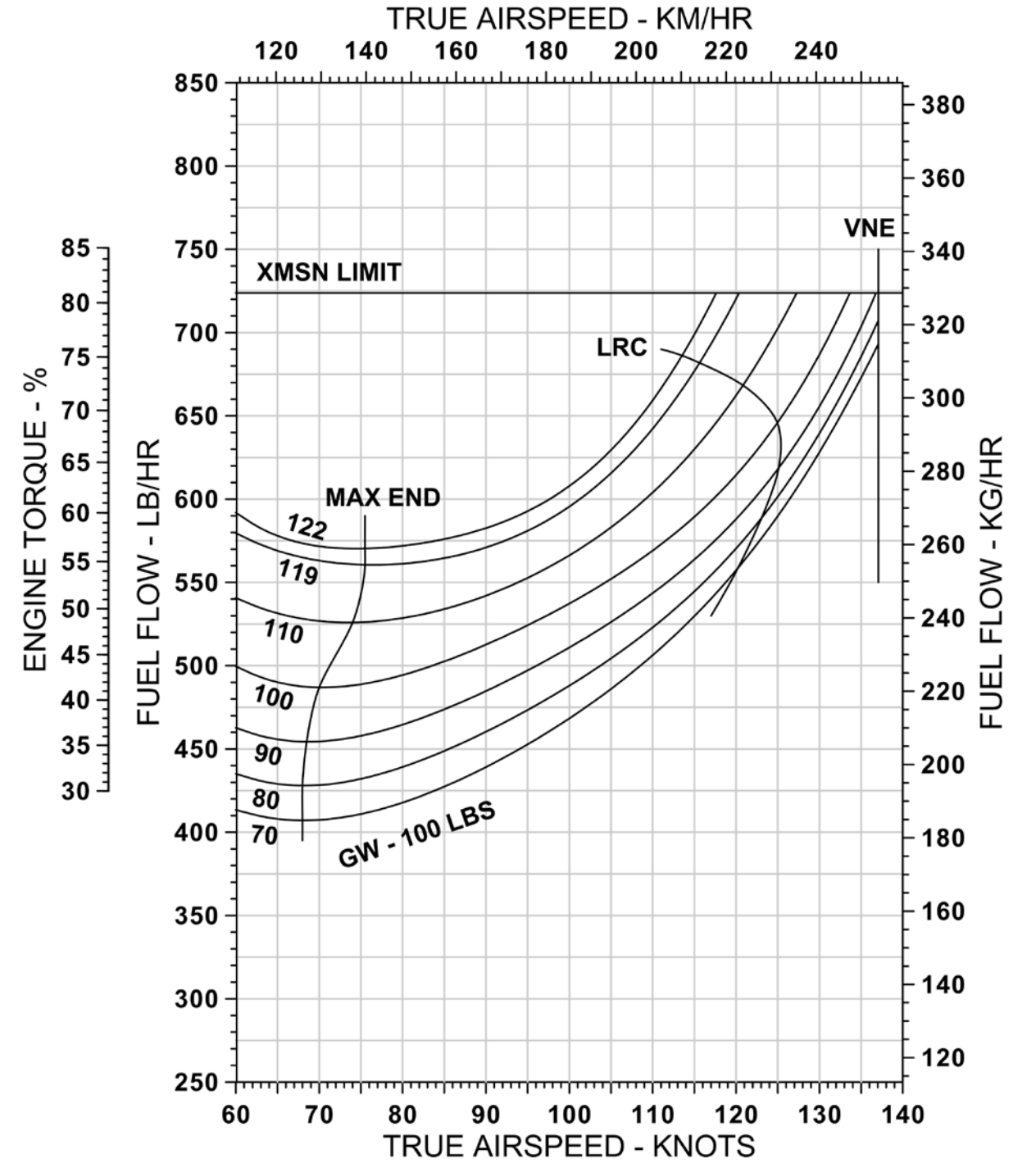

Cost of Operations

INTRODUCTION

Bell Textron Inc. cost of operations data for current production helicopters is based on information from Bell operators and service facilities. BHTI's Product Support organization accumulates cost data from a diverse group of operators - large, small; sub-polar, subtropical; inland, coastal; corporate, charter. This information is analyzed to generate sample data for each production model which are averages of the field experience. BHTI intends to continue monitoring actual costs and product improvements to enable annual updates of the data to maintain its currency. The following discussion is provided to review the variables involved in the helicopter's direct and indirect cost of operations as well as its cost of ownership.

The total cost of helicopter ownership and operation involves both direct and indirect costs. The direct costs are those which are incurred essentially by the flight hour and include:

- Fuel, Lubricants
- Basic Airframe Maintenance
- Powerplant Maintenance

The indirect costs are not directly dependent upon the number of hours flown and include:

- Insurance
- Facilities (hangar, workshop, etc.)
- Crew Compensation
- Financial Factors (depreciation, investment tax credit, financing costs, etc.)

Sample direct operating cost data is available for each current production model. Detailed estimates for total costs relating to specific operations are available through the BHTI regional marketing manager or corporate office using input data supplied by customer/prospect.

DIRECT COSTS

Fuel, Lubricants	A typical average value of fuel and lubricant costs is included in the sample data provided for each model. Fuel consumption depends upon speed, temperature, externally-mounted accessories, sling loads, etc. A band of approximately 10% more or less than sample value will cover these factors for normal operations. Fuel pricing varies considerably based on where the fuel is purchased geographically and whether it is purchased retail or in bulk. The sample cases use average retail purchase price prevalent at the time of the sample data are prepared.
Basic Airframe Maintenance	<p>Airframe maintenance is divided into four categories:</p> <ul style="list-style-type: none"> • Periodic Inspections • Overhauls • Replacement of Retirement Parts • Unscheduled <p><u>Periodic inspections</u> include those inspection tasks, with their part requirements, listed in the Maintenance Manual for each model. Man hours for periodic inspections can vary from the sample value provided because of differences in personal experience, tool and parts availability, facilities, environmental effects such as extremes in working temperatures. Man hour costs/hour are also variable among the Authorized Service Centers as a result of differences in local costs, overhead expenses and volume of work. The sample value is an average of costs per hour at Authorized Service Centers at the time of publication.</p>

Cost of Operations

DIRECT COSTS

Basic Airframe Maintenance (continued)	<p><u>Overhauls</u> include removal, disassembly, inspection, parts replacement, reassembly and reinstallation of certain components/assemblies at the periods stated in the BHTI Maintenance Manual. Overhaul man hour and parts requirements are subject to considerable variation depending upon the helicopter's operations and environments. The sample data reflect average values.</p> <p><u>Retirement parts</u> are those which are subject to disposal after an operating time stated in the Maintenance Manual. These are normally components of the rotors/control systems which are subject to oscillatory loads and are designed and tested for use over a finite number of flight hours rather than on their condition. The replacement at the required intervals requires some labor which is included in the man hour data in the sample.</p> <p><u>On-condition/Unscheduled maintenance</u> encompasses labor and parts replacement for major maintenance not covered under the formal Maintenance Manual requirements for scheduled part retirements, periodic inspections and overhauls. It also includes those additional maintenance requirements imposed by the manufacturer through issue of Service Bulletins.</p> <p>The sample data for periodic inspections provide for some minor unscheduled maintenance tasks resulting from the inspection.</p>
Powerplant Maintenance	The powerplant (engine) requires periodic inspection and overhauls. The overhaul periods are based on the number of operating hours or on the number of cycles, whichever is the first limit to be attained. Start cycles are a factor because thermal cycles are important in the design of the turbine engine's rotating components. Overhauls are performed by the engine manufacturer and/or at authorized facilities. Powerplant overhaul can be performed for the engine as a unit, or in some cases for individual modules. (Modules can be gearbox, compressor, turbine, for example.) Each module can have its own overhaul period. Modular overhaul can be cost-effective for some operations and its use should be evaluated. Engine or module exchanges can be made in lieu of overhaul. For details, contact the engine manufacturer or his authorized distributors/service centers. The sample costs are based on an average exchange. The powerplant may also require unscheduled maintenance (unscheduled removals for repair, parts replacement).

Cost of Operations

The following table is a sample of the Bell 412EPI direct cost of operations, in U.S. dollars per flight hour. This sample is developed by Bell using the *Guide for the Presentation of Helicopter Operating Cost Estimates* published in 2010 by Helicopter Association International.

SAMPLE BELL 412EPI DOC (PLUS FUEL ESTIMATE) SUMMARY SCHEDULE

	Parts	Labor ^[1]	Total
AIRFRAME MAINTENANCE			
Scheduled Inspections ^[2]	\$15.02	\$44.18	\$59.19
Scheduled Retirements ^[3]	\$100.43	\$0.38	\$100.81
Scheduled Overhauls ^[4]	\$84.99	\$14.39	\$99.38
Provision for Unscheduled Maintenance and Service Bulletins on above Components	\$24.51	\$2.18	\$26.69
On-condition Maintenance of Other Airframe Components	\$256.51	\$39.15	\$295.66
Subtotal	\$481.46	\$100.27	\$581.74
POWERPLANT - PRATT & WHITNEY PT6T-9 (QUANTITY 2) ^[7]			
Mfg. Estimate of Engine Cost - TBO 5,000 ^[6]			\$410.57
BHT Estimate of Additional Line Maintenance			\$34.67
Subtotal			\$445.24
Total DMC			\$1,026.98
FUEL AND LUBRICANTS			
Fuel ^[5]			\$534.49
Lubricants			\$5.34
Subtotal			\$539.83
Grand Total with Fuel			\$1,566.81

- Notes:
- [1] Labor rate figured at \$95.00 per hour.
 - [2] Based on 600 flight hours / year. 1.5 RIN/FLT HRS
 - [3] Based on 100% Life.
 - [4] Based on 100% TBO.
 - [5] Calculated at 113 GPH at \$4.73 per gallon.
 - [6] Engine estimate assumes utility application, 2 engine cycles per hour, benign environment (no allowance for severe operation, environment or conditional repairs).
 - [7] Includes "2" power sections (5,000 hrs O/H) and "1" combining gearbox (4,000 hrs O/H). Engine estimate assumes utility application, 2 engine cycles per hour, benign environment (no allowance for severe operation, environment or conditional repairs).

Other assumptions: Basic helicopter with no optional equipment installed;
Mature helicopter (no warranty considerations);

Cost of Operations

INDIRECT COSTS

Insurance	Insurance rates are based on a number of factors including claim experience, type of operations, and crew qualifications. Rates can be obtained from insurance agent/broker.
Facilities	Facilities can include hangar, workshop, parts storage area, tools, ground support equipment and administrative area as appropriate to the specific operation.
Crew Compensation	The number of aircrew personnel depends on the individual operation; i.e., whether the normal crew consists of one or two pilots, hours per day flown, backup requirements for illness, vacation, etc. Bell regional marketing managers can advise typical local costs for estimation purposes.
Financial Factors	Funding a helicopter purchase can be accomplished in a variety of ways, including cash, short term note, long term note, partnership, etc. For investment accounting, several depreciation methods also exist; straight line, double declining, sum of the years digits, etc. Value of resale is a significant factor.
Miscellaneous Factors	Staff expenses (other than aircrew and direct maintenance personnel), utilities, office expenses, etc.

OWNERSHIP ANALYSIS PROGRAM

Bell uses the most recently published edition of the Life Cycle Cost computer program provided by Conklin & de Decker Associates, Inc. to determine total ownership costs for an operators planned period of utilization for the aircraft. Conklin's Rotorcraft Analysis Office may be contacted at: Phone; (817) 277-6403 or Fax; (817) 277-6402.

Bell's regional marketing managers or corporate office personnel will be able to assist in preparing an ownership analysis which is customized for our customers specific individual conditions and needs.

Component Overhaul

COMPONENT OVERHAUL INTERVALS

Component	Hours	Component	Hours	Component	Hours
Collective Lever	2,500	Main Drive Shaft	3,000	Transmission	6,000
Driveshaft Couplings (2)	5,000	M/R Pitch Links (2 ea)	2,500	T/R Driveshaft Hangar	3,000
Hub & Sleeve Assy	2,500	Rotor Brake Quill	3,000	T/R Hub	2,500
Hydraulic Actuator (2)	2,500	Starter Generator (2)	1,000	T/R Hub Assembly	2,500
Intermediate Gearbox	5,000	Swashplate & Support	2,500	T/R Gearbox	5,000
Mast Assembly	6,000				

Limited Life Components

Part Number	Component	Life in Flight Hours	Life in RIN	Qty Per Aircraft
MAIN ROTOR COMPONENT				
412-010-101-129	Yoke Assembly	5,000		2
412-010-190-105	Spindle	10,000		4
412-010-149-111	Pitch Horn	15,000		4
412-010-124-109	Retention Bolt	5,000		4
412-010-137-103	Retention Bolt	5,000		4
412-010-185-109	Damper Bridge, Upper	15,000		4
412-010-111-103	Fitting	5,000		4
412-010-170-105	Damper Bridge, Lower	10,000		4
MAIN ROTOR CONTROLS				
412-010-425-129	Pitch Link Tube	5,000		2
412-010-406-117	Swashplate Link Assy	5,000		2
412-010-403-117	Rephasing Lever Assy	5,000		2
412-010-405-111	Drive Link Assy	5,000		2
412-010-407-117	Swashplate Outer Ring	10,000		1
412-010-453-105	Swashplate Support Assy	15,000		1
204-010-404-001	Gimbal Ring Assy	9,000		1
204-011-408-107	Collective Sleeve	9,000		1
412-010-408-101	Collective Lever Assy ^[2]	10,000		1
PROPULSION and DRIVE SYSTEM				
412-040-101-129A	Main Rotor Mast ^[1]	10,000	60,000	1
412-010-171-101	Cap Retention	10,000		1
412-010-165-101	Cone	10,000		1
412-010-166-101	Drive Pin	10,000		8
412-010-186-103	Upper Cone Seat	10,000		1
412-010-177-117	Splined Plate Assy ^[1]	10,000	60,000	1
412-018-056-105	Lower Cone Seat	10,000		1
412-010-179-105	Cone	10,000		1
TAIL ROTOR CONTROLS				
212-011-702-001	Tail Rotor Yoke	5,000		1
212-010-750-133	Tail Rotor Blade	5,000		2

Limited Life Components

LIMITED LIFE COMPONENTS (continued)

Part Number	Component	Life in Flight Hours	Life in RIN	Qty Per Aircraft
OTHER				
412-704-112-105	Bolt Kit	2,500		1
EWB0420D-7-36	Bracket Bolt	15,000		16
20-057-5-24D	Bolt	2,500		3

- Notes:
- (1) Mast and spline plate has a retirement life of 10,000 hours or 60,000 RIN, whichever occurs first. Assuming ten torque events per hour, an operator would retire the mast and spline plate due to the RIN limitation. The cost per hour therefore, is based on RIN not flight hours.
 - (2) Collective Lever Assy has a retirement life of 5,000 hours when installed on an aircraft with the Strake and FastFin® System

Customer Support and Services

At Bell, we understand that our responsibility to our customers extends far beyond the aircraft sale. We are committed to providing the resources necessary to ensure the safe and reliable operation of our products, and we will be with you at every step of your aircraft's lifecycle. Consistently voted the #1 Customer Support & Services organization in the industry, Bell offers a wide range of products and services to support your mission requirements.



SUPPORT AND SERVICE OFFERINGS

- 2** Straightforward Customer Advantage Plans (CAP) covering basic aircraft configuration with optional coverage for non-standard kits
- 8** Bell service centers around the world with wide ranging maintenance, repair and overhaul capabilities
- 80+** Bell Training Academy employees with extensive experience, offering the most advanced pilot and maintenance courses

- 4,000** Parts offered through the Aeronautical Accessories brand
- and**
- 1,200** Unique Supplemental Type Certificates (STCs), all of which comply with FAA regulations and meet rigorous internal quality standards
- 100+** Bell authorized Customer Service Facilities (CSFs) with the ability to perform a wide range of aircraft services

Customer Support and Services

CUSTOMER ADVANTAGE PLANS (CAP)

Customer Advantage Plans (CAP) safeguard your direct maintenance costs and provide the ultimate in cost predictability. The plans protect your investment and provide confidence of knowing you're backed by the industry leader in customer support. With coverage options for non-standard kits, our customers experience the Bell Advantage.

SIMPLE COMPREHENSIVE PLANS

Bell offers two simple Customer Advantage Plan options: Standard and Premier Plans.

Both offer holistic coverage of the standard helicopter configuration, with optional coverage for non-standard kits. Standard and Premier Plans are both designed to provide peace-of-mind that your aircraft is protected from day one of your aircraft ownership. Why overcomplicate your OEM support?

**Don't just think you're covered...
Know it.**

CUSTOMER ADVANTAGE PLAN FEATURES

		Premier	Standard
Typical Customer	Aircraft ownership	New aircraft or fleet customers	New aircraft only
	Years of aircraft ownership	5+	<5
	Annual flight hours	High	Low
Coverage	Standard helicopter configuration parts	<input checked="" type="checkbox"/>	<input checked="" type="checkbox"/>
	Optional coverage for kits installed by Bell	<input checked="" type="checkbox"/>	<input checked="" type="checkbox"/>
	Optional OEM engine coverage	Varies by model	
	Parts used for scheduled maintenance	<input checked="" type="checkbox"/>	
	Parts used for unscheduled maintenance	<input checked="" type="checkbox"/>	<input checked="" type="checkbox"/>
	Life-limited component coverage	<input checked="" type="checkbox"/>	
	Overhauls	<input checked="" type="checkbox"/>	
	OEM-original or authorized parts	<input checked="" type="checkbox"/>	<input checked="" type="checkbox"/>
Alert Service Bulletins	<input checked="" type="checkbox"/>	<input checked="" type="checkbox"/>	

Program Benefits

- DMC competitive
- Optional non-standard kit coverage
- Preferred rates for aircraft serviced by any of the 100+ Bell Customer Service Facilities (CSFs)
- Streamlined budgeting
- Residual value protection
- Improved financing terms
- Transferable upon aircraft resale*
- Fleet customers may be eligible for no "Buy-Ins"

Bell Global Network Advantage

Bell has the largest and highest rated service network in the industry. CAP members who use a Customer Service Facility for their local maintenance are rewarded with preferred "in-network" rates for their aircraft.

Premier Access to Increase Aircraft Availability

Customer Advantage Plan members have preferred access to Bell's dedicated rotatable pool of parts. This inventory reduces traditional repair or replace turnaround times.

*Upon sale of aircraft, any remaining funds in the aircraft's Premier CAP account may be transferred with execution of new contract.

CUSTOMER ADVANTAGE PLAN FEATURES

		Premier	Standard
Contract	Minimum annual flight hours	No minimum	No minimum
	Renewable	☑	☑ **
	Transferable	☑ *	☐
	Preferred rates for using Bell Authorized Customer Service Facilities	☑	☑
	Choice pricing under warranty	☑	☑
Support	Access to Bell Customer Portal	☑	☑
	On-site technical assistance	☑	☑
	24/7/365 Aircraft on Ground (AOG) support	☑	☑

* Upon sale of aircraft, any remaining funds in the aircraft's Premier CAP account may be transferred with execution of a new contract.

** Conditions may apply

NEW AIRCRAFT COVERAGE

The Customer Advantage Plan provides the confidence of knowing you're backed by the industry leader in customer support. For new aircraft, the plans are designed to provide peace-of-mind that your aircraft is protected from day one of your aircraft ownership.

KEY BENEFITS



LOWER RATES DURING WARRANTY



SAVINGS ON OVERALL AIRCRAFT SUPPORT



RESIDUAL VALUE PROTECTION ON AIRCRAFT

WARRANTY AND CAP OPTIONS

CAP COVERAGE (In Network)

3 YEARS/
**2000 HR WARRANTY
+
*3 YEARS LABOR

CAP COVERAGE (Out of Network)

3 YEARS/
**2000 HR WARRANTY
+
*2 YEARS LABOR

STANDARD WARRANTY

3 YEARS/
**1000 HR WARRANTY
+
*1 YEAR LABOR

* year(s) total or time out on aircraft | **with CAP purchased at point of sale

To learn more about how Customer Advantage Plans can assist you with your aircraft operations, please contact CAP@bellflight.com or contact your Bell Sales Representative.

Service Centers

The wide-ranging capabilities of our Customer Support and Services organization provides complete and seamless support - offering Bell customers the advantages of a one-stop helicopter services experience - worldwide.

With services ranging from state-of-the art helicopter customization, aircraft refurbishment and helicopter accessory options to unparalleled maintenance, repair and overhaul solutions, combined with personalized service offerings, Bell provides you with local support in every corner of the world.

VALUE ADDED SERVICES

		Piney Flats	Miami	Ozark	Singapore	Prague	Broussard	RBI Hawker (UAE)	RBL (United Kingdom)
Component Repair & Overhaul Capabilities	Expanded repair	•		•					
	Transmission	•		•	•				
	Hubs	•		•	•				
	Avionics	•		•		•			
	Rotor blades						•	•	•
	Composite panels						•		
Additional Capabilities	Aircraft customizing	•		•	•	•			
	Aircraft refurbishment	•	•	•	•	•			
	Maintenance, repair & overhaul	•	•	•	•	•			
	Upgrades & mods install	•	•	•	•	•			
	Approved installer of Aeronautical Accessories parts & accessories	•	•	•	•	•			
	Paint service	•		•	•	•			
	Field maintenance & repair	•	•		•	•	•		
	Bell maintenance training	•			•				
	Bell warranty work	•	•	•	•	•	•	•	•

Customer Support and Services

CUSTOMER SERVICE FACILITIES (CSF)

At Bell, we understand the importance of maintaining the readiness of your aircraft. That is why we are committed to providing the helicopter industry's premier global customer support network. With more than 100 authorized facilities globally, the award-winning Bell Customer Service Facility (CSF) network is there to ensure your aircraft is ready—whenever or wherever you need it.

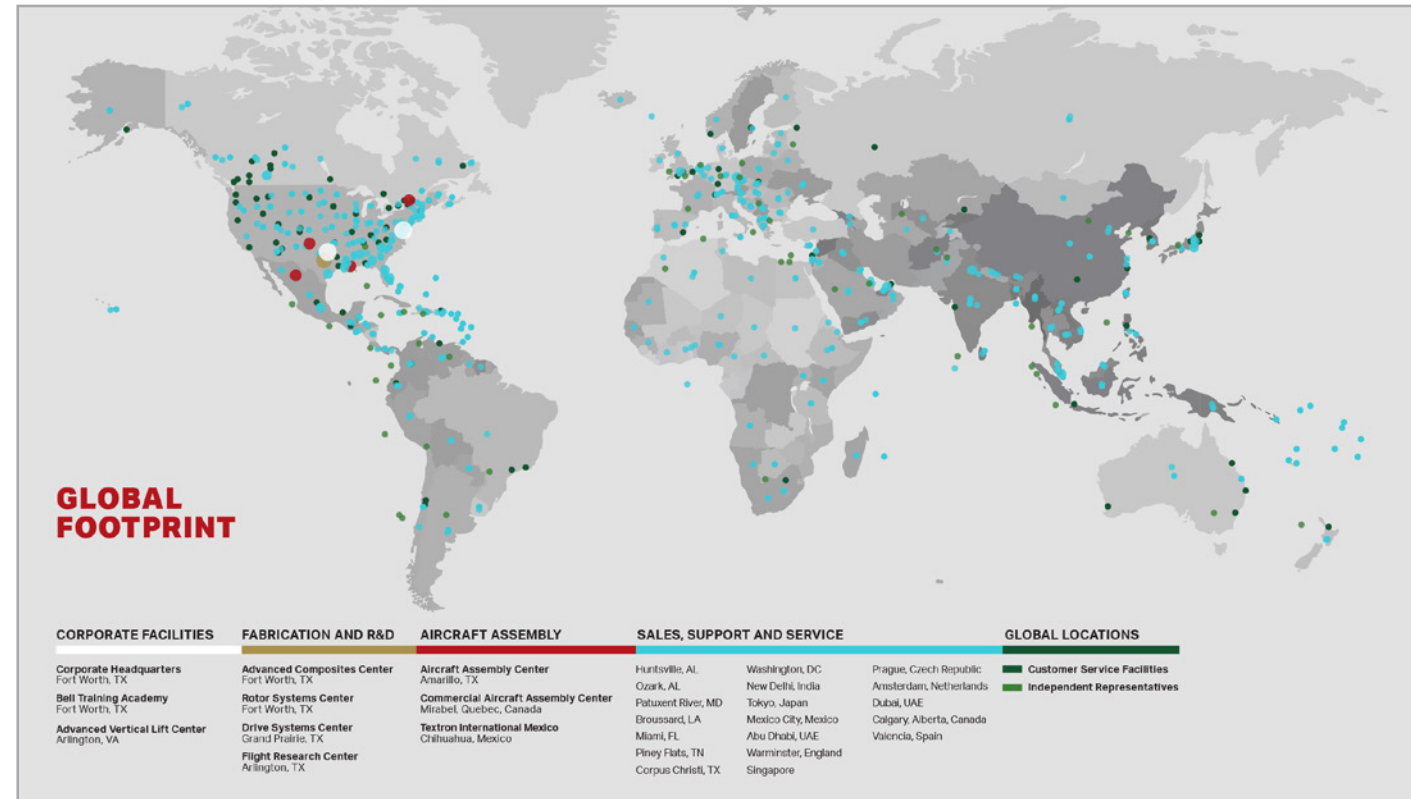

QUALITY ASSURED AND OEM APPROVED

Customers who choose an authorized CSF for maintenance, repair and overhaul work can be assured that both the staff members and the facility itself meet Bell's stringent internal standards for quality and safety. Authorized CSFs have factory-trained maintenance technicians and are equipped with the training and expertise required to process Bell warranty claims. In addition, these facilities maintain guaranteed parts inventories to service aircraft and possess the most up-to-date technical and safety information available. All of this combines to provide in-region support you can trust.

Training

BELL TRAINING ACADEMY (BTA)

Bell's global training solutions are designed to equip customers with the knowledge and skills necessary to safely and efficiently perform their missions. Since 1946, the Bell Training Academy (BTA) has been committed to providing industry leading training programs that create better, safer flight operations. The BTA staff of highly skilled professional pilot and technical instructors leverages OEM data and expertise to deliver the finest helicopter training in the world. We continue to develop innovative programs that will take our customers' pilot and technical skills to a whole new level.

Pilot and maintenance training is complimentary with each new aircraft purchase. Supplemental, training courses are available at an additional cost.

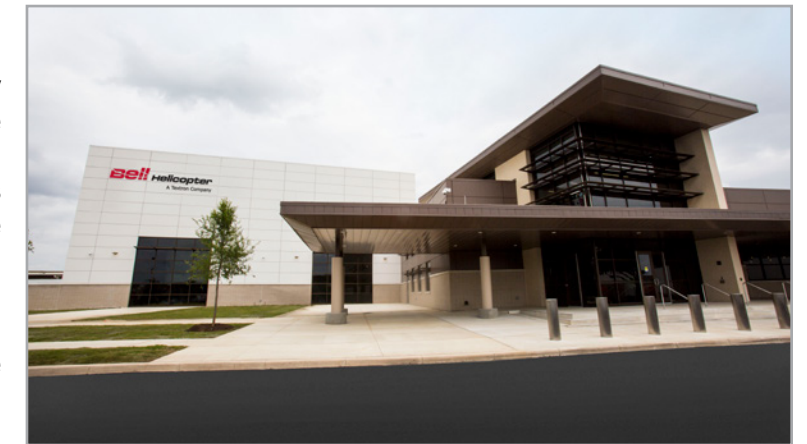

The Bell Training Academy at Bell's headquarters in Fort Worth, Texas.

STATE-OF-THE-ART TRAINING RESOURCES

Based at the Bell headquarters in Fort Worth, Texas, the BTA combines a track record of excellence with a wide variety of industry-leading amenities.

#1	Pilot and maintenance training consistently ranked #1 the industry.	375+	Years combined experience among Bell's technical instructors
25,000+	Square foot maintenance hangar	8,500	Average instructor pilot flight hours
200,000+	Pilot and maintenance technicians trained	134+	Countries represented by customers in every market segment
2	Full Flight Simulators for the Bell 407GX and Bell 525	6	Advanced Flight Training Devices (FTD) designed to train on seven models

Training

The BTA's 80+ staff members welcome students from all over the world, and are eager to share the knowledge gained from decades of hands-on experience within the military and across other professions. Instruction can be provided in English or Spanish. Language translation is available for an additional cost.

Recognized by the European Aviation Safety Agency (EASA) as an Approved Training Organization (ATO), the BTA has the authorization to provide Part-FCL flight training courses to European customers for the 407, 212/412, 429, and 505 models, including the use of Flight Training Devices (FTD) for the Bell 407 and 429 models. A Performance Based Navigation (PBN) Generic Non-Type or 412/429 Type Rating Specific courses are also approved.

The BTA is also authorized by various international regulatory agencies for type-specific technical training of engineers / mechanics. These agencies include the Civil Aviation Authority of Singapore (CAAS), Transport Canada (TC), European Aviation Safety Agency (EASA), Australian Civil Aviation Safety Authority (CASA), Civil Aviation Administration of China (CAAC), Director General Civil Aviation of India (DGCA), and the UAE General Civil Aviation Authority (GCAA).

GLOBAL TRAINING NETWORK

With nearly 70 percent of our commercial aircraft delivered internationally, Bell understands the need for training to be readily available where our customers perform their missions. Our training centers are equipped and certified to meet the needs of our customers around the globe. We are committed to having resources where our customers operate and are investing to provide world-class, global training solutions to meet a growing customer demand.

Europe: All pilot training classes at Bell Training Academy (BTA) – Valencia, powered by TRU Simulation + Training are instructed upon the Bell 429 EASA-certified Level D Full Flight Simulator (FFS). The Bell 429 FFS by TRU offers the largest standard visual field of view and the largest standard dome radius of any simulator on the market today. Additionally the FFS offers industry-leading motion performance with high-fidelity superior accelerations, smoothness, and responsiveness powered by REALFEEL® Control Loading System and REALVibe™ Secondary Cueing System.

Bell Training Academy (BTA), Valencia, powered by TRU Simulation + Training offers three courses with plans for additional class offerings in the coming years. BTA-Valencia offers a 10-day Bell 429 EASA initial type rating and a Bell 429 recurrent course to reinforce the initial type rating. Additionally, BTA-Valencia offers wet and dry leasing that is custom tailored to each operator. For more information on wet and dry leasing please visit www.bellflight.com/training.

Singapore: BTA Singapore is approved by the Civil Aviation Authority of Singapore (CAAS), European Aviation Safety Agency (EASA), Australian Civil Aviation Safety Authority (CASA), and Director General Civil Aviation of India (DGCA), and the UAE General Civil Aviation Authority (GCAA). BTA Singapore offers regulatory classes for maintenance theory and practical training on all current Bell models and select legacy aircraft. Available courses include avionics maintenance, field maintenance and refresher courses, cable and connector training, and vibration monitoring system training.



Bell training at BHT Singapore.

Training

GENERAL INFORMATION

The operator and maintenance training provided by BTA establishes a foundation that supports mission tasks with aircraft pilot qualification.

Pilot Operator Training: Our pilot training program includes basic academics and initial flight training to transition current pilots into Bell aircraft. All training is conducted by certified Bell instructor pilots.

Maintenance Technician Training: Experience is important, however, instruction received in the classroom and training lab provides an undeniable enhancement. Facilitating more efficient maintenance manpower and improving logistics supportability ensures that the customer's Bell is operational and maintainable in all types of climate and terrain.

Academic training includes both state-of-the-art instructor-led computer presentations and hands-on maintenance training. Mechanical, electrical, and avionics training takes place in a temperature controlled shop and will include use of composite maintenance trainers and avionics bench trainers. The BTA also has operational cutaway mockups, a composite repair room, and an electrical/avionics lab. Over half of the maintenance training is hands-on, skill enhancing, and performance focused instruction. Training is determined complete, as defined by Bell, after each student demonstrates an ability to perform to the course standards for actual maintenance and operation of the equipment referencing technical manuals.

Training Aircraft: The Bell Training Academy conducts flight training in Bell OEM-owned or newly delivered customer aircraft.

Training Materials and Language: Bell provides each maintenance and pilot training candidate a hard-copy course notebook in the English language for each course conducted by BTA instructor personnel. The training materials will be sufficient to train maintenance technicians and pilots who meet the course prerequisites in the maintenance and operation of the applicable model helicopters. Course instructional electronic media, syllabi, course outlines, and company intellectual property will be considered non-deliverables.

Training Technology: Bell is leading the industry in its use of engineering technology to more effectively teach pilots and maintainers around the world. The use of 3-D rendered, high-fidelity, interactive graphics provide students an authentic representation of each component. Smart Board technology allows for independent media manipulations such as assembly and disassembly of system subassemblies and replication maintenance actions without leaving the classroom. The adoption of 3-D modeling of aircraft components and system assemblies has greatly improved training efficiency by enhancing student retention.

Student Registration: The customer is responsible for submitting an enrollment request for each training candidate via Bell's on-line registration process at www.bellflight.com/training. It is encouraged that all training be scheduled at least ninety (90) days prior to the start of each established course date to ensure space and instructor availability.

Cancellation Policy: The customer agrees to comply with the Bell Training Academy cancellation policy as set forth at www.bellflight.com/training.

Trainee Visas: Applying for and receiving a visa for students in a timely manner is the responsibility of the customer. To ensure timely approvals, students must register early.

Trainee Expenses: Arrangements and expenses associated with training, including but not limited to, air travel, ground transportation (car rental/taxi), meals, and lodging for each designated trainee will be the responsibility of the customer.

Training

TRAINING COURSES

The following table summarizes the complimentary training provided with each purchased Bell 412EPI. Additional training options are available at www.bellflight.com/training

BELL 412EPI TRAINING COURSE SUMMARY

Course	Complimentary	Duration
Pilot Training		
Bell 412EPI Initial Ground, Simulator and Transition Flight Procedures	2	2 weeks
Maintenance Training		
Bell 412EPI Field Maintenance	1	4 weeks
Integrated Avionics System	1	4 weeks

COURSE DESCRIPTIONS

Please visit our website at bellflight.com/training for complete course descriptions.



Our Aeronautical Accessories brand offers more than 4,000 parts and 1,200 unique supplemental type certificates (STCs), allowing you to upgrade your aircraft to meet the latest mission requirements. Aeronautical Accessories offers a broad selection of competitively priced, proven replacement parts and accessories with the best and most respected customer service in the rotorcraft aftermarket industry.

INNOVATION RELIABILITY & PERFORMANCE

In aviation, innovation must be accompanied by a stringent focus on compliance to ensure your safety and that of your crew and passengers. To deliver on that commitment, Aeronautical Accessories places an uncompromising focus on safety and quality. Our components meet FAA requirements as well as exacting internal standards and are backed by an exceptional warranty—a benefit of being part of the Bell brand. In addition, we are registered under Bell as a certified ISO 9001 with AS9100 Revision D facility.

GLOBAL AVAILABILITY OF PRODUCTS

Through our global distribution and modern inventory management system, we minimize customer downtime for repairs, refurbishments and completions. Aeronautical Accessories is your solution for:

- Windows
- Interior and trim
- Landing gear
- Composites
- Safety and mission equipment
- Doors and seating
- Lighting and vision
- Fuel systems and filtration
- Floats
- Ground handling equipment

To view the full range of Aeronautical Accessories product offerings, please visit www.aero-access.com. To reach Sales & Support, please call 800.251.7094 or by email at sales@aero-access.com.

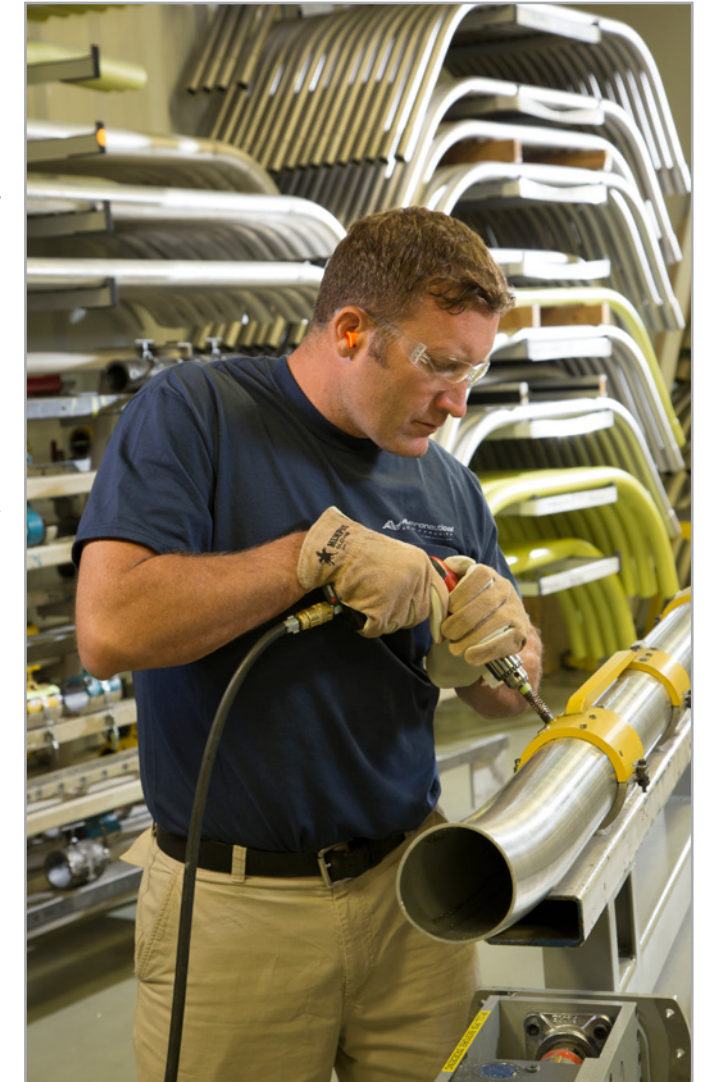

BELL 412 FEATURED PRODUCTS

Bell Vibration Monitoring (BHVM) Kit and Altair Engine Trend Monitor System

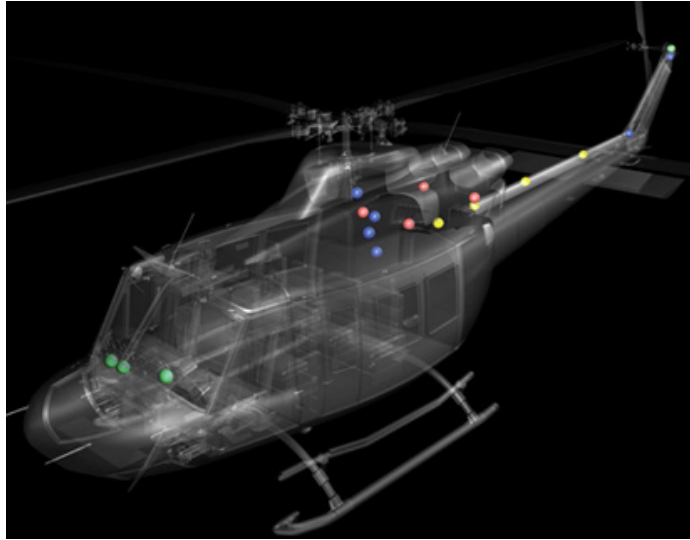

- Provide drive train health and engine monitoring to improve aircraft serviceability and maintainability between regularly scheduled inspections and overhaul periods
- Control head located in the pedestal provides the primary flight crew interface to the BHVM
- Pedestal mounted USB port allows the flight crew to transfer data between the aircraft and a PC-based ground support station
- Ethernet connection provides means for maintenance personnel to connect to the ground support station
- BHVM diagnostics facilitate vibration-related maintenance functions such as main rotor track and balance, tail rotor balancing, main input drive shaft balancing and tuning of the instrument panel Frahm absorber

- Enhanced vibration diagnostics allow maintenance personnel to detect faults within the main rotor system, tail rotor drive system, engine accessory gearbox and combining gearbox
- Built-in test features simplify system troubleshooting

Cockpit Voice and Flight Data Recorder



- “On-condition,” line-replaceable unit that simultaneously records both cockpit voice and flight data
- Capable of recording a minimum of 25 hours of flight data and two hours of audio, and audio inputs are provided from four separate channels
- Simultaneously records all four channels, converts the audio into a digital format and stores the data in solid-state memory
- Flight data is recorded in flash memory and segregated from the cockpit voice data, and can be downloaded to ground station equipment in approximately five minutes

- Ground support equipment interface connector is provided and easily accessible
- Pedestal-mounted cockpit control unit enables bulk erasure of the CV/FDR audio data
- Recorder is JAR-OPS 3 approved

