

**SPECTRUM SENSING
&
SIGNAL IDENTIFICATION
USING RTL-SDR**

Name : Akshaya Kumar Nayak

Roll : 111EC0180

Guided by

Prof. Shrishail Hiremath



Department of Electronics & Communication Engineering

National Institute of Technology Rourkela

Rourkela – 769008, Odisha, India

SPECTRUM SENSING
&
SIGNAL IDENTIFICATION
USING RTL-SDR

*A thesis submitted in partial fulfilment
Of the requirements of the degree of*

“Bachelor of Technology”

In

Electronics and Communication Engineering

By

Akshaya Kumar Nayak

Roll: 111EC0180

Under the guidance

Of

Prof. Shrishail Hiremath



Department of Electronics & Communication Engineering

National Institute of Technology Rourkela

Rourkela – 769008, Odisha , India



Department of Electronics & Communication Engineering
National Institute of Technology Rourkela
Rourkela – 769008, Odisha, India

CERTIFICATE

This is to certify that the work in the thesis entitled “ **Spectrum Sensing & Signal Identification using RTL-SDR**” by Akshaya Kumar Nayak, with roll number 111EC0180, is an original record of research work done by him under my supervision and guidance in partial fulfilment of the requirements for the of the degree of Bachelor of Technology in Electronics and Communication Engineering.

Neither this thesis nor any part of it has been submitted for any degree or academic award elsewhere.

Prof. Shrishail Hiremath

Department of Electronics & Communication Engineering
National Institute of Technology Rourkela
Rourkela – 769008, Odisha, India

Acknowledgment

This dissertation, though work of an individual, has benefited in various ways from several people. Whilst it would be simple to name them all, it would not be easy to thank them enough.

The enthusiastic guidance and support of Prof. Shrishail Hiremath inspired me to stretch beyond my limits. His motivating insight has guided my thinking to improve the in my work. My solemnest gratefulness to him.

Finally, my heartfelt thanks to my family and friends for their unconditional love and support. Words fail me to express my gratitude to my beloved parents, who sacrificed their comfort for my betterment.

Akshaya Kumar Nayak

Abstract

Cognitive radio is one of the modern techniques in the field of wireless communication in order to solve the spectrum scarcity problem. Spectrum scarcity occurs due to the rapid increase of the applications in wireless communication which results in the problem of bandwidth. Hence in order to solve this problem cognitive radio follows the cognitive cycle in which spectrum sensing acts as a major procedure. Spectrum sensing largely focus on the effective and efficient utilization of the spectrum. The spectrum allocation plays an important role in this. There are two type users primary user (PU) and secondary user (SU) .Primary user those who are legally allotted to use the spectrum but for secondary user without license to use the spectrum avoiding interference can be done by spectrum sensing. In this key factor is to find the spectrum holes then allocate those to the secondary user. For this purpose energy detection and cyclostationary detection two procedure, are followed here, to determine spectrum holes. Here the analysis to find the white spaces are done by collecting the real time signal with RTL-SDR and experimented on the platforms like matlab, Simulink, GNU radio and spectrum analyzer. Finally the comparison between the methods are stated with a complementary ROC plot. Finally P25 analysis is also done for C4FM, CQPSK which are phases of project 25. This idea is to improve the efficiency of the spectrum utilization.

CONTENTS

1. Introduction.....	1
2. Motivation.....	2
3. Literature Review.....	3
4. Cognitive Radio.....	4
4.1 Cognitive cycle.....	5
4.2 Software defined radio.....	6
4.3 GNU radio.....	7
5. Methods used in spectrum sensing.....	8
5.1 RTL-SDR.....	9
5.1.1. RTL-SDR results.....	9
5.2 GNU radio.....	12
5.2.1 GNU radio results.....	12
5.3 Energy detection.....	16
5.3.1 Energy detection results.....	17
5.4 Cyclostationary detection.....	20
5.4.1 Cyclostationary results.....	23
6. P25 spectrum sensing.....	26
7. Conclusion & Future work.....	29
8. Bibliography.....	30

1. INTRODUCTION

Now a days as the time passes new technologies evolve every day. Hence with the new inventions it also brings the problems as in communication field spectrum scarcity which is now becoming a very major problem as man invents applications every day. Each application require spectrum to operate but we have limited amount of spectrum available .For the solution of spectrum scarcity we go for cognitive radio. With the help of cognitive radio we can eliminate the spectrum scarcity problem. Major reasons for spectrum scarcity are inefficient and ineffective utilization of the spectrum available. In the process for the solution of this problem we go for spectrum sensing. Here we mainly work on two types of user primary users (PU) and secondary users (SU), primary user means the user which has license to use the spectrum and secondary user which doesn't have license to use the spectrum. The solution of spectrum scarcity we have to identify the spectrum holes. Spectrum holes are those which are created when primary users are not using the allotted spectrum to them at that particular time. Hence our aim is to identify the spectrum holes or white spaces and allot them to the secondary users so that spectrum can be efficiently utilized. Now we know spectrum scarcity is due to inefficient utilization hence cognitive radio should have following properties such as flexibility, reconfigurable, awareness, adaptability, intelligence. Cognitive radio has to be flexible while operating within radio environment, reconfigurable means it has to be reprogrammable .With each operation cognitive radio should be aware of the effect of environment and it should learn to adapt with the changes in the radio environment. Also we expect the cognitive radio to perform better with each iteration. This paper is based upon how we have implemented the spectrum sensing procedure using RTL-SDR with the methods of spectrum sensing like energy detection, cyclostationary detection.

2. MOTIVATION

The objective of the cognitive radio is the effective and efficient utilization of the spectrum. Allocation of spectrum plays an important role for primary and secondary user. Here the target is to find the spectrum holes or white spaces and allot that bandwidth to the secondary user. Cognitive radio operations are based upon cognitive cycle. Hence cognitive radio should have the advantages like flexibility, reconfigurable, adaptivity, intelligence. Cognitive radio also includes software defined radio which is a software having the same advantages of hardware with more benefits. This also satisfies properties of cognitive radio hence easy to use. Spectrum sensing is done by various signal classification methods like energy detection, cyclostationary detection to find the presence of primary user. But here we will mainly focus on the energy detection method and its advantages and disadvantages which can be removed by cyclostationary detection. As cyclostationary detector responds better to the low snr values whereas energy detection can't. This is a feature based detection hence also has better processing gain. The demand for spectrum in wireless communication field due to the development of applications are the major reason behind the better utilization of spectrum. Spectrum sensing can also help to increase the efficiency of the spectrum available and the methods used for this are energy detection, matched filter, cyclostationary detection. Hence the use of cyclostationary detection method is more popular as per the demand of spectrum and it is not affected by low snr values. . Hence our aim is to identify the spectrum holes or white spaces and allot them to the secondary users so that spectrum can be efficiently utilized. Now we know spectrum scarcity is due to inefficient utilization hence cognitive radio should have following properties such as flexibility, reconfigurable, awareness, adaptability, intelligence. Cognitive radio has to be flexible while operating within radio environment, reconfigurable means it has to be reprogrammable.

3. LITERATURE REVIEW

The development of software defined radio was first proposed by Mitola J which suggests the implementation which is the alternate of the hardware in the paper “The software radio architecture”(1995). Joseph Mitola (2000) developed this SDR in “An Integrated Agent Architecture for Software Defined Radio”. S. Maleki et al. (in 2013) designed a censored truncated sequential technique for spectrum sensing as an energy-saving approach. To design this technique, average energy consumption of each sensor is minimized to a lower bound of probability of detection and an upper bound of false alarm rate to control the interference to the PU due to miss detection and the network throughput as a result of a low false alarm rate. Lastly, the performance of the proposed scheme is compared with a fixed sample size censoring scheme under different cases and it is shown that that for low-power cognitive radios, proposed technique outperforms existing technique. Alexander M. Wyglinski then took it to the next level with networking & wireless communication system in “Cognitive radio communications and networks”(2010). K.J.R. Liu et al. (in 2011) studied the effect of errors in the spectrum sensing process on the performance of the multiple access layers of both primary and secondary networks and concluded that using different designs for spectrum sensing and the channel access mechanisms can affect the performance of both primary and secondary networks. So in this paper a joint design of spectrum sensing and channel access mechanisms is proposed which uses binary hypothesis testing to check the reliability of outcome. Proposed technique achieves significant improvement in throughput of both PU and SU networks. GNU radio application in the field of spectrum sensing came into the communication field by Amor Nafkha (2014). Energy detection is used in spectrum sensing with GSM band by Maheshkumar S. Pandit(2014). The radio configuration and environment sensing are configured by the cognitive radio engine by accessing the software defined radio via cognitive radio interface. Performance results and radio behavior of a communication system can be observed by implementing the learning engine and policy based engine in SDR by Mitola J. As mentioned by Mitola J. radio environment sensing can be done by software defined radio which is an important part of the cognitive radio. Allen Ginsberg (2006) has experimentally verified the Cognitive Radio Architecture as well as Integrating Knowledge Representation with Software defined Radio Technologies.

4. COGNITIVE RADIO

Cognitive radio is one of the most important emerging technologies in wireless communication. The aim of the use of cognitive radio for the solution of bandwidth problems we face for rapid increase of applications in our world. Cognitive radio should have to be reconfigurable, intelligent, and reprogrammable for which its operation to remove spectrum scarcity will be possible. The idea of cognitive radio was first given by Mitola J. which was next developed to determine spectrum holes. Cognitive radio works on the principle of cognitive cycle. Our objective is to find the spectrum holes or white spaces and allot them to the SUs. Spectrum sensing methods like matched filter, energy detection, cyclostationary detection are used in communication world. Here we have implemented energy detection and cyclostationary detection methods and compared both methods. Cognitive radio technology can help us to increase data rate as well as bandwidth can be effectively utilized.

4.1 COGNITIVE CYCLE

Cognitive radio is an evolving technology for the solution of spectrum scarcity. With the properties like flexibility and adaptability it is widely used now a days. In the year 2000, Mitola first gave the idea of cognitive radio with the help of cognitive cycle. Then CR is developed by Haykin (2006) which is more designed according to the real world signals. It basically observes the real world with the cognitive cycle. For each cycle this adjusts the changes in the cycle to gain the required result. If it is required to change the waveform for the goal the cognitive cycle should be able to that also. By each cycle the cognitive cycle should learn about the users and the requirements for the better results in each case of spectrum sensing through cognitive cycle. . But here we will mainly focus on the energy detection method and its advantages and disadvantages which can be removed by cyclostationary detection. As cyclostationary detector responds better to the low SNR values whereas energy detection can't. This is a feature based detection hence also has better processing gain. The demand for spectrum in wireless communication field due to the development of applications are the major reason behind the better utilization of spectrum. Spectrum sensing can also help to increase the efficiency of the spectrum available and the methods used for this are energy detection, matched filter, cyclostationary detection. Hence the use of cyclostationary detection method is more popular as per the demand of spectrum and it is not affected by low SNR values. Cognitive cycle is main part of the cognitive radio which can be given by

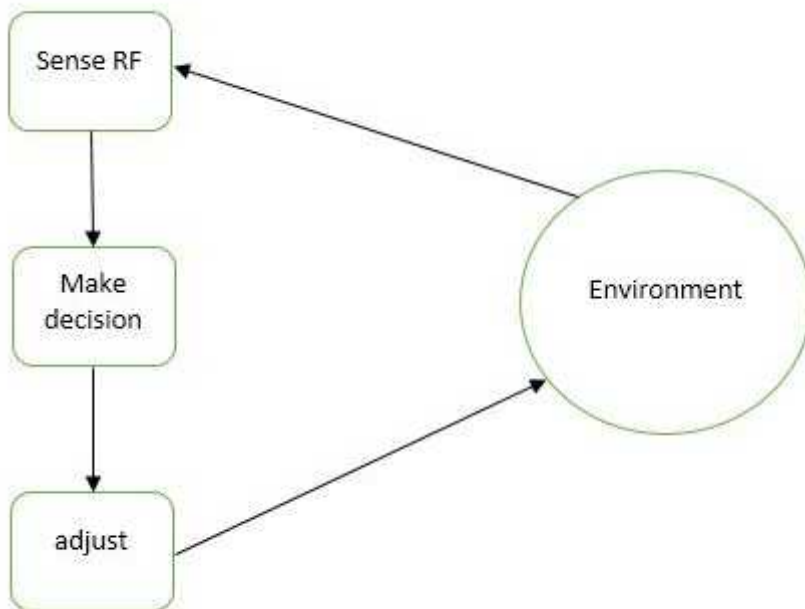
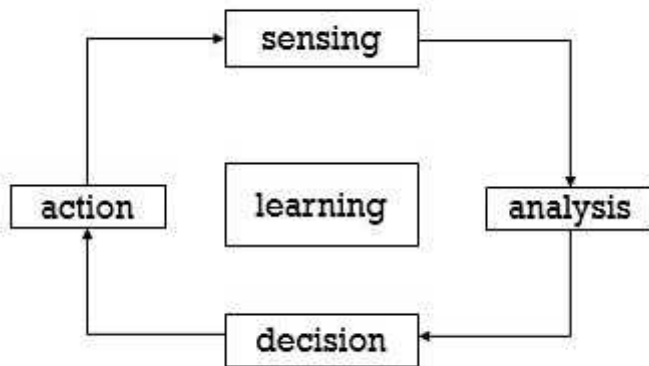

4.2 SOFTWARE DEFINED RADIO

Software defined radio is an important component in cognitive radio where it converts all analog part into digital and perform all the required work on software. It performs modulation and demodulation of NFM, WFM, AM, SSB, USB, LSB on the software itself. In software defined radio all the radio hardware are already present no need of further tedious tasks those are like mixer, filter, modulator and demodulator. As we expect the cognitive radio to be reconfigurable, here the contents after the test can be reprogrammable. Hence here individual can do their experiments without the costly hardware and get the same result after several simulation.

SDR works in three steps first the input real time signal is passed through the RF section next it goes to the signal processing unit and next to the user interface system.

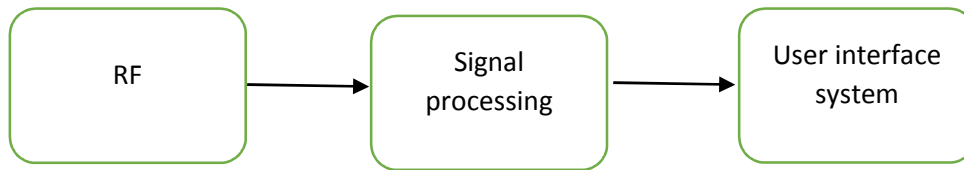

RTL-SDR collects the data from antenna and then passed through a filter known as E4000 tuner chip and next through an ADC RTL2832U then the output of ADC fed to the computer.



After this with the help of Zadig software we can see the waterfall diagram and the FFT plot of the signal we set through the software with the help of RTL-SDR. This is an efficient use RTL-SDR dongle to capture real time data and apply spectrum sensing to it.

4.3 GNU RADIO

GNU Radio can also be used as software defined radio, it is an open source software used to collect signal from free space through RTL-SDR to analyze these through blocks in it. Here the signal processing block are written in C++ and the line which connects them is working with the help of python. Here we can also use USRP for collection and analysis of the real time signal. As cyclostationary detector responds better to the low snr values whereas energy detection can't. This is a feature based detection hence also has better processing gain. The demand for spectrum in wireless communication field due to the development of applications are the major reason behind the better utilization of spectrum. GNU radio will be very helpful in the implementation of the energy detection as well as cyclostationary detection but we prefer cyclostationary detection for its advantages of this over energy detection.

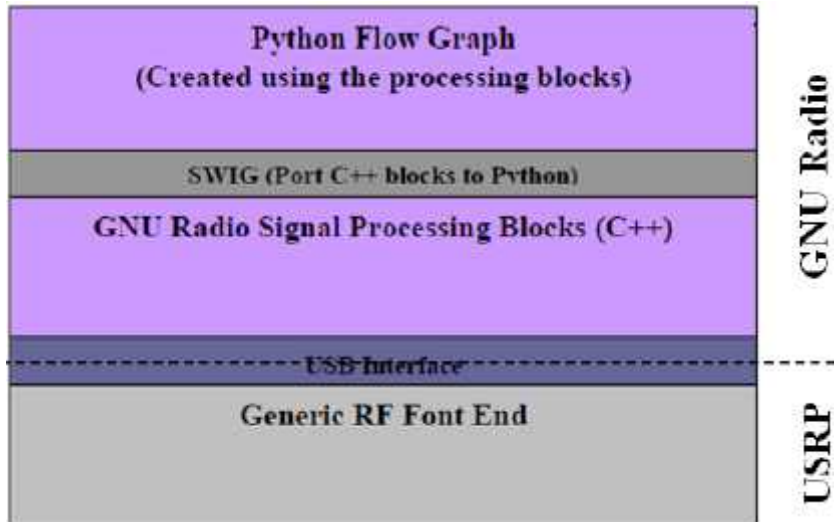

As mentioned in the above diagram GNU Radio collects the signal either from RTL-SDR antenna or USRP based antenna then tries to analyze it with the building blocks within it.

5. METHODS USED IN SPECTRUM SENSING

Spectrum sensing methods are the procedure to find the presence of primary user (PU). With the development in the field of technology and various applications come to use hence spectrum scarcity occurs where the need of efficient utilization is required. Our aim is the find the PU and at the particular time & frequency if one channel is vacant or there is a spectrum hole then secondary user can use those channel hence spectrum can be efficiently utilized as well as efficiency of the network will increase. But here we will mainly focus on the energy detection method and its advantages and disadvantages which can be removed by cyclostationary detection. As cyclostationary detector responds better to the low snr values whereas energy detection can't. This is a feature based detection hence also has better processing gain. The demand for spectrum in wireless communication field due to the development of applications are the major reason behind the better utilization of spectrum. Spectrum sensing can also help to increase the efficiency of the spectrum available and the methods used for this are energy detection, matched filter, cyclostationary detection. Hence the use of cyclostationary detection method is more popular as per the demand of spectrum and it is not affected by low snr values.

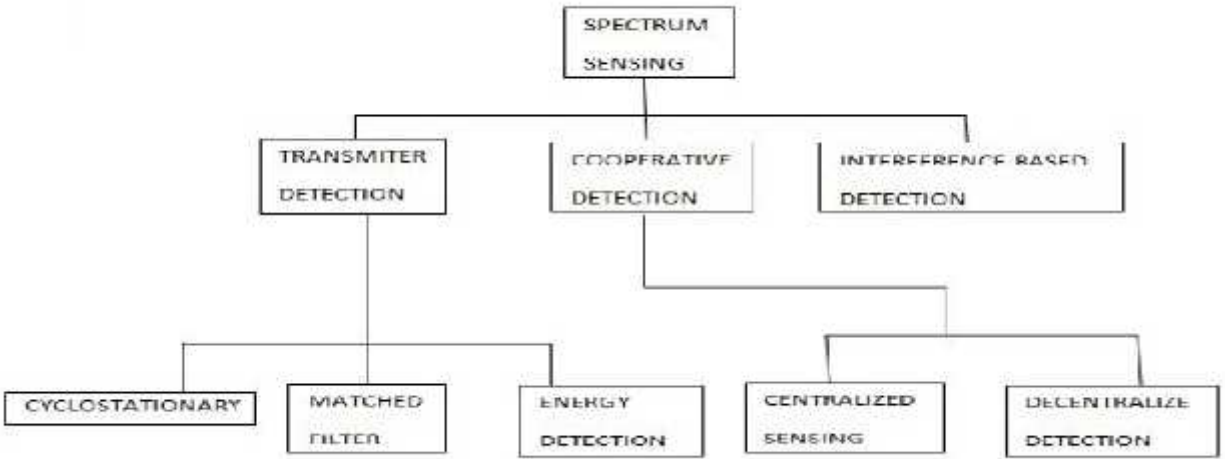

Now we need to identify the presence of PU. Hence we followed these following methods for the detection.

(1)Energy detection Method

(2)Cyclostationary Method

In the energy detection we need to find the signal power by passing through a low pass filter followed by the FFT block to estimate the signal power then we have to compare this result to te predefined detection threshold to obtain appropriate hypothesis to find where the primary is present or not according to the information of power. Cyclostationary is based upon feature based detection. This method is better than energy detection method due is ineffectiveness towards noise as this can also work in low snr values. . But here we will mainly focus on the energy detection method and its advantages and disadvantages which can be removed by cyclostationary detection. As cyclostationary detector responds better to the low snr values whereas energy detection can't. This is a feature based detection hence also has better processing gain. The demand for spectrum in wireless communication field due to the development of applications are the major reason behind the better utilization of spectrum. Spectrum sensing can also help to increase the efficiency of the spectrum available and the methods used for this are energy detection, matched filter, cyclostationary detection. Hence the use of cyclostationary detection method is more popular as per the demand of spectrum and it is not affected by low snr values.

5.1 RTL-SDR:

RTL-SDR dongle collects the input from antenna. Then the collected signal is down sampled by E4000 tuner chip. Next it is passed to RTL2832U which is an ADC then the output is sent to the computer through USB. In the computer filtering and demodulation process is done with the audio output that we can get from speakers. Next we can see the output like FFT plot and waterfall diagram on our screen.

5.1.1 RTL-SDR RESULTS:

Below is the collected data with the help of RTL-SDR and procedure to get them is described.

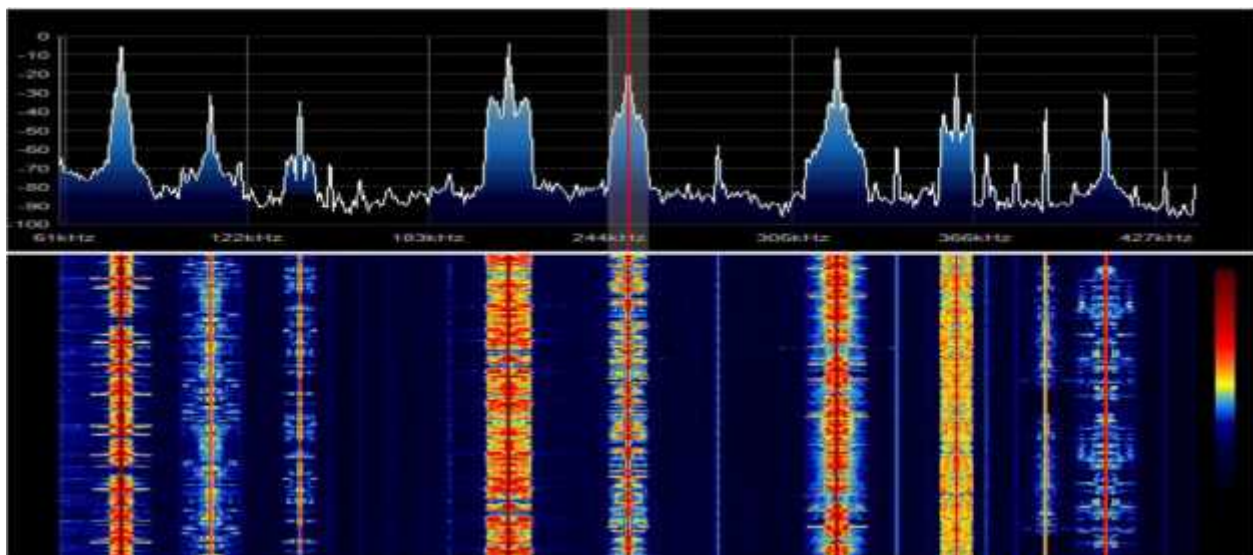

First we have to connect the dongle with the laptop then the antenna is connected to dongle .After that we have to install zadig to collect the spectrum. Now on our screen we can observe the FFT spectrum as above with waterfall plot as below, before this we should set the frequency where we want to analyze.

Here the red part shows the strong signal whereas blue parts are weaker from waterfall plot.

Below the first image on the screen when there is no setup, after we set the frequency the FFT and waterfall diagram will appear where we can observe the strong and weak signal with the color codes as mentioned.

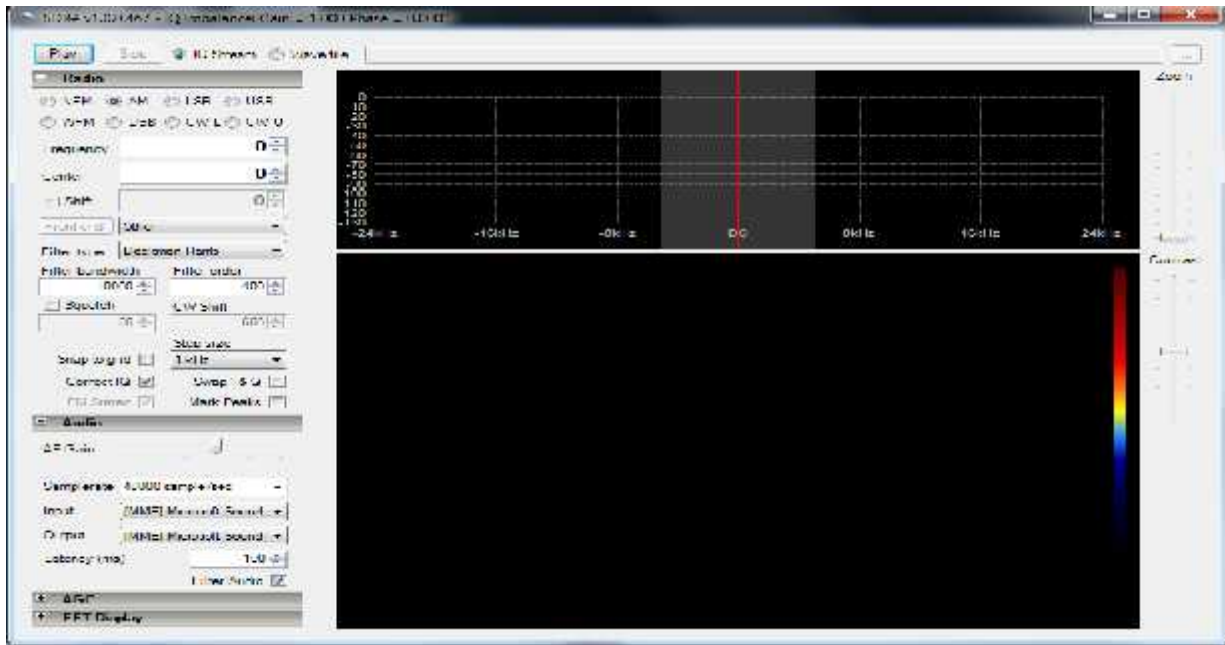

Above diagram when there is no input from RTL-SDR.

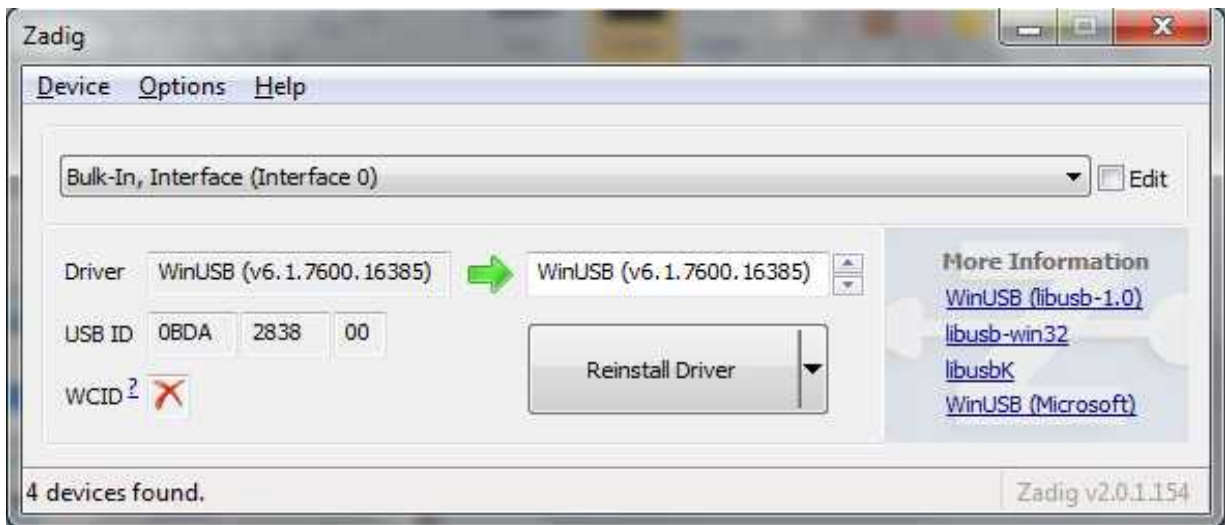

Where we can set the RTL-SDR to view the FFT and waterfall diagram.

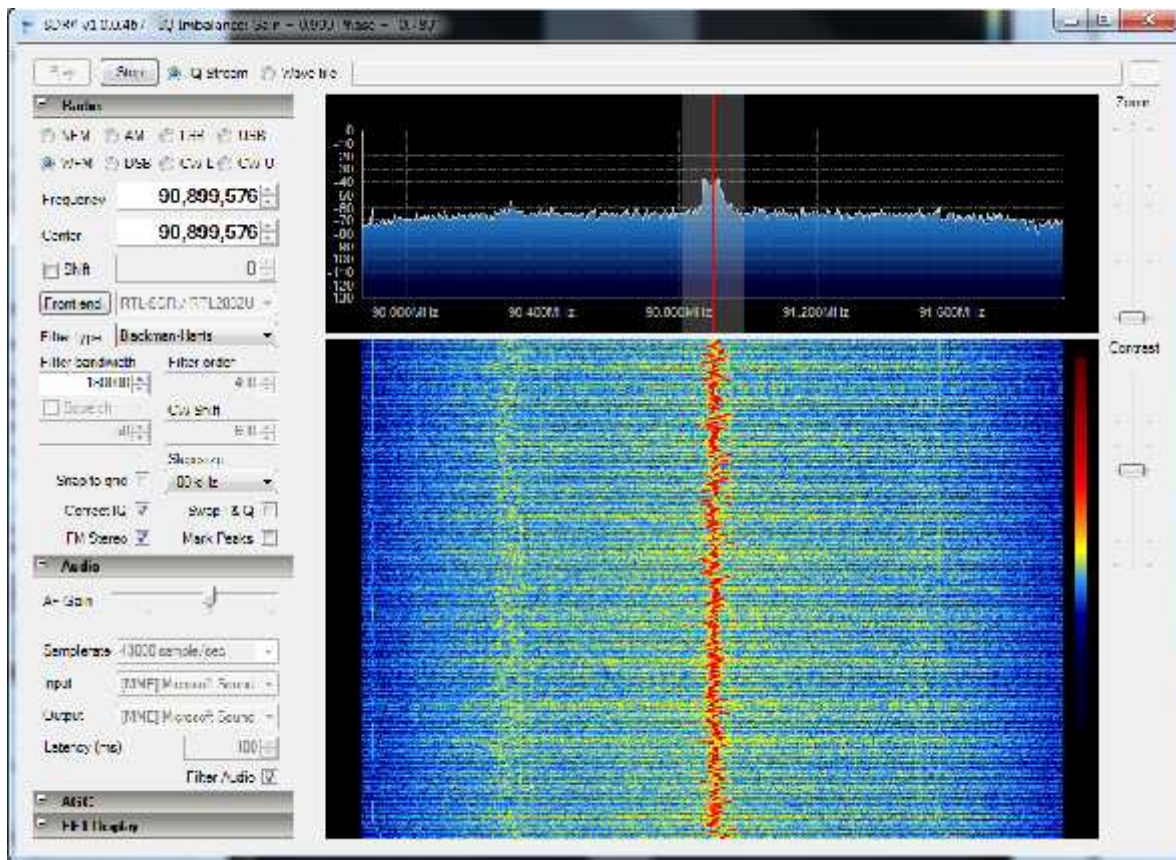

From the above image we can clearly observe that there is rise in FFT plot as well as red waterfall diagram. Where the color code tells us that black is no signal and from weaker to stronger signal as we move from blue to red. This plot appears after we press IQ stream.

RTL-SDR is a very useful modern device which helps us detecting the signal strength and the spectrum usage after we follow various process. Advantages of this is we can avoid various hardware difficulties and can use software for the same purpose like modulation, demodulation etc.

5.2 GNU RADIO:

GNU radio is based on python and c++. For enhancing the speed c++ is used. This is very easy to use whereas block diagram are also like signal flow graph. Using RTL-SDR collection signal can be done through the GNU radio software where there is a RTL-SDR receiver to capture the real time data. USRP can also be used for the same collection of real time data. GNU can process the signal easily much more less costly than the hardware way. Hence we can have cost free experience.

5.2.1 GNU RADIO RESULTS:

Using GNU radio we can also obtain FFT and waterfall plot as well as spectrum analysis can be done. Here first we have to make set up like below to obtain our desired result.

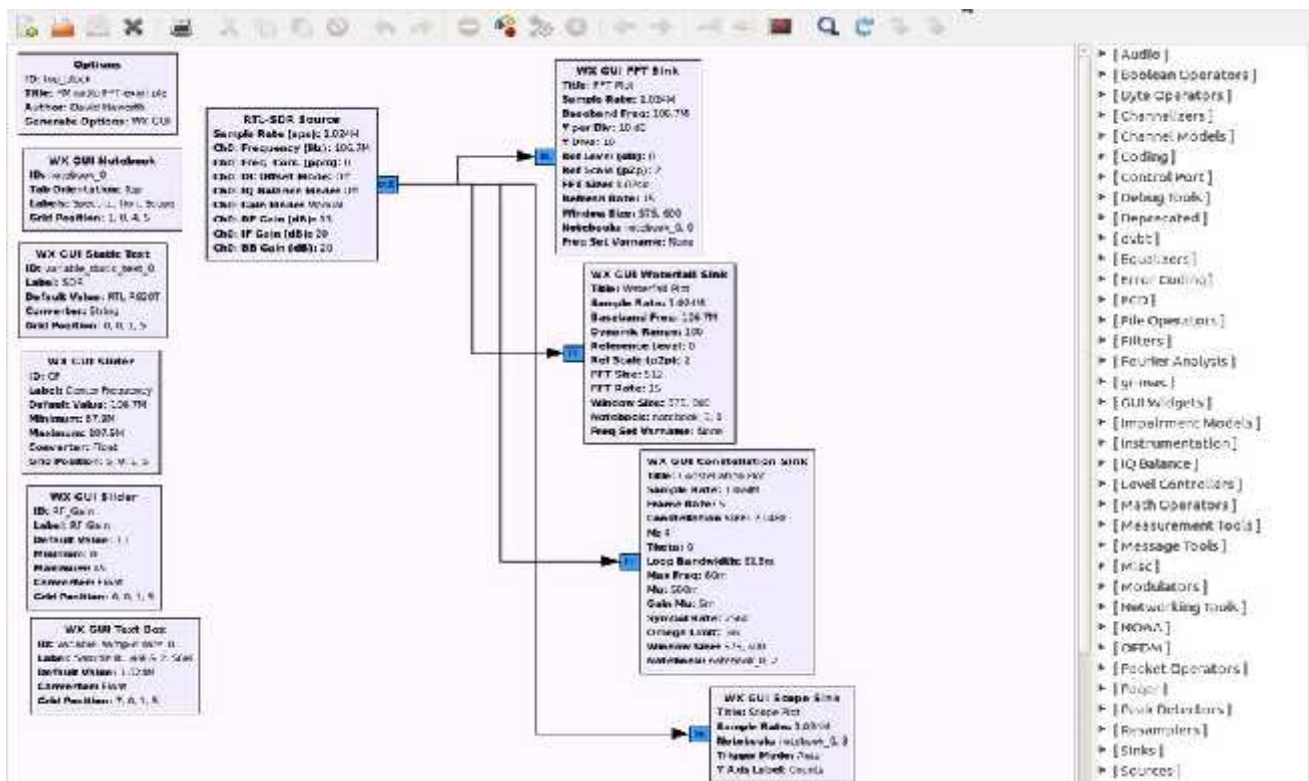

As in the figure the RTL-SDR source captures the real time signal with the dongle then according to the block connection it will show the output. First FFT block which will show us the FFT plot of the received signal. The next block will show the waterfall plot and we also can observe the constellation diagram of the received signal.

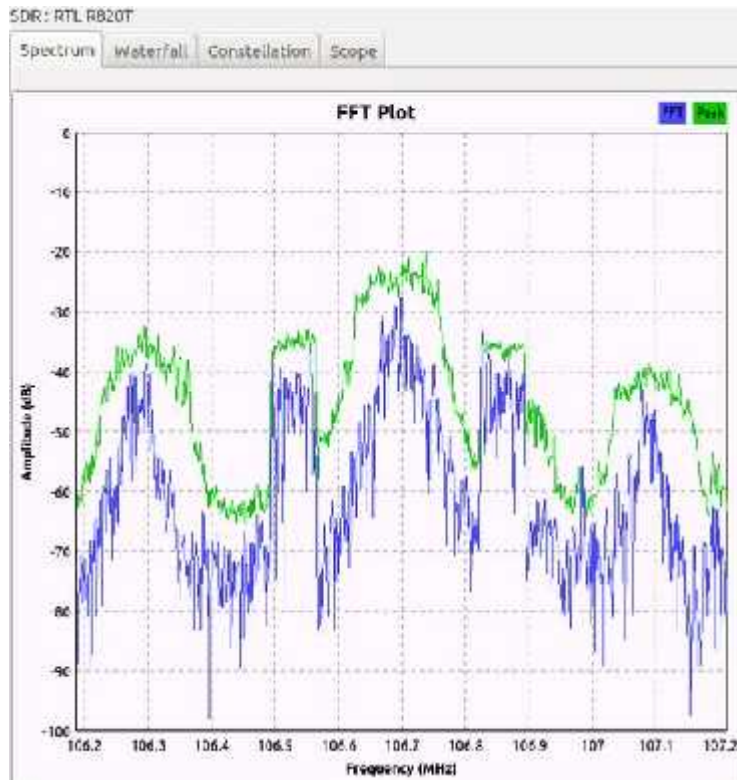

Here the green points are the peak points of the varying signal where the blue points are the signal at that time.

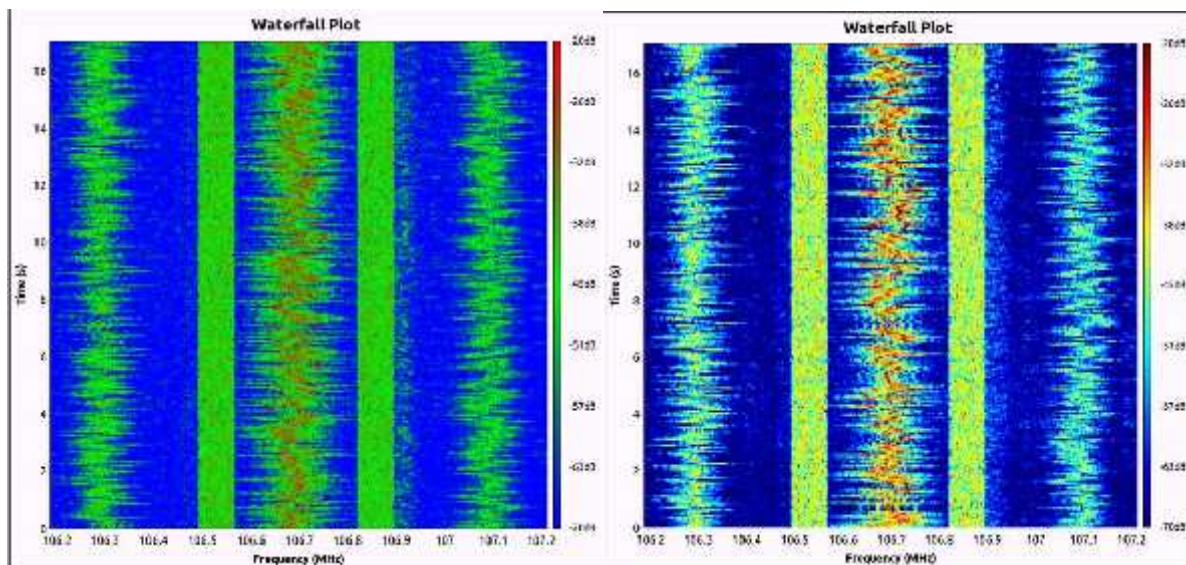

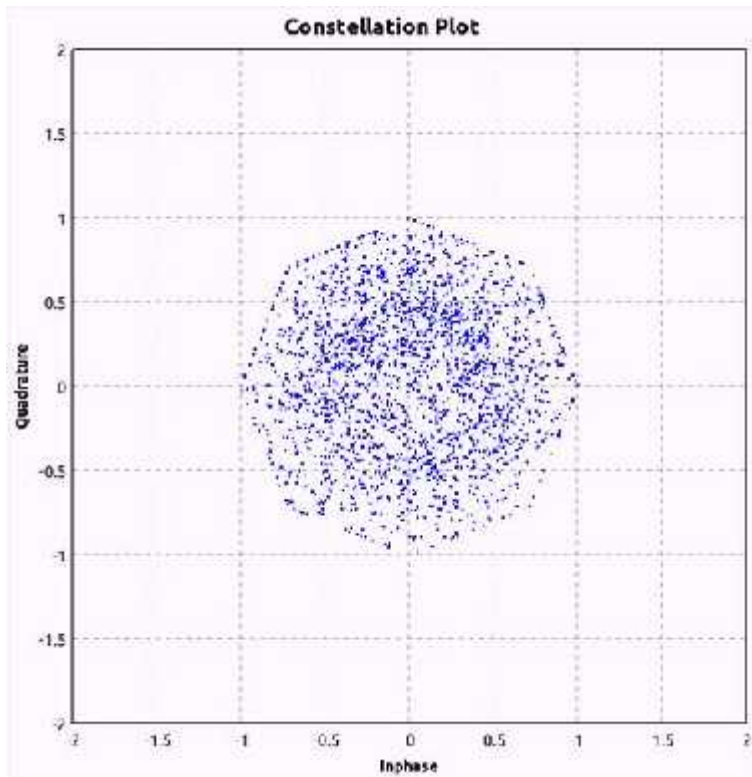
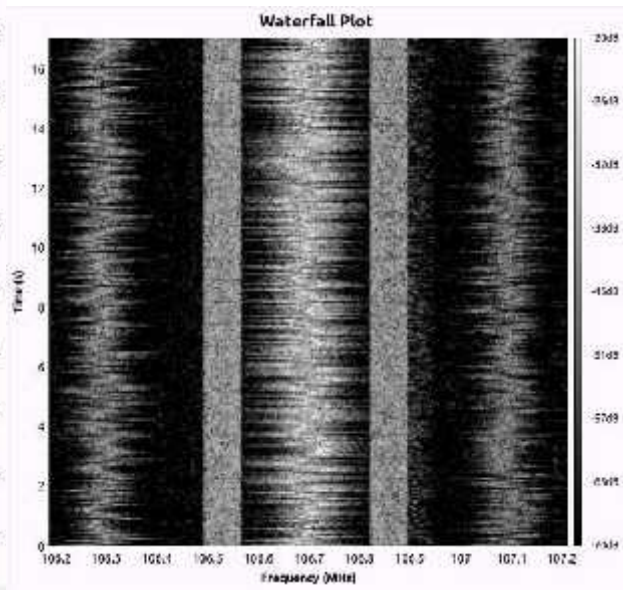
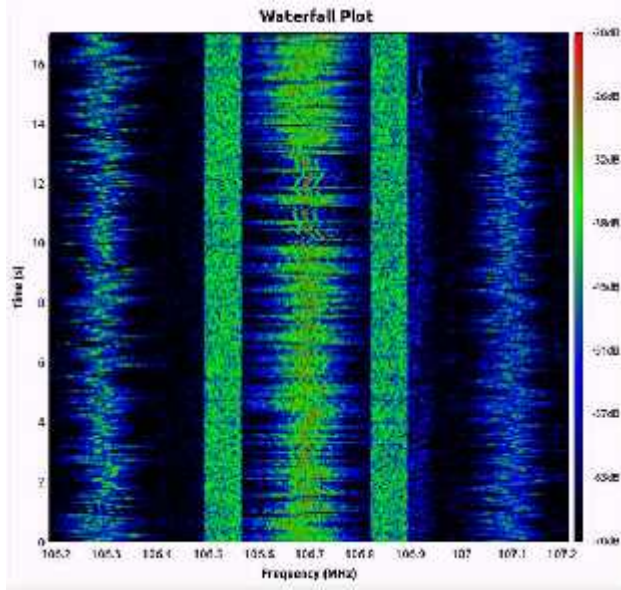

Constellation point figure

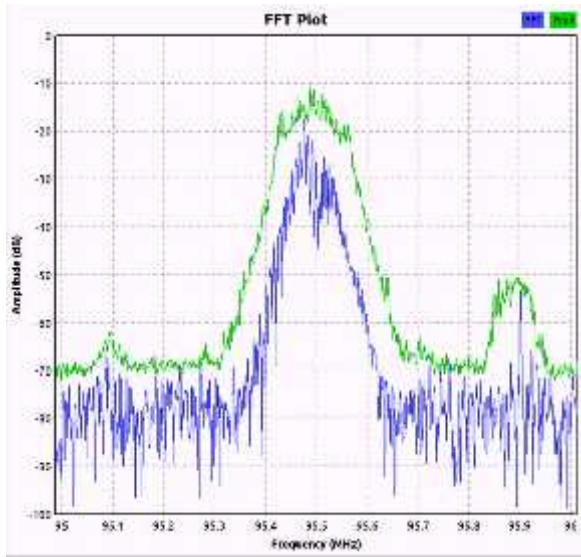

FFT plot

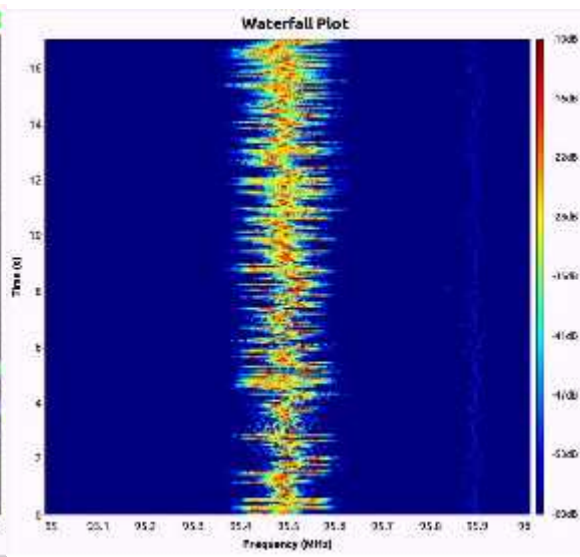

waterfall plot

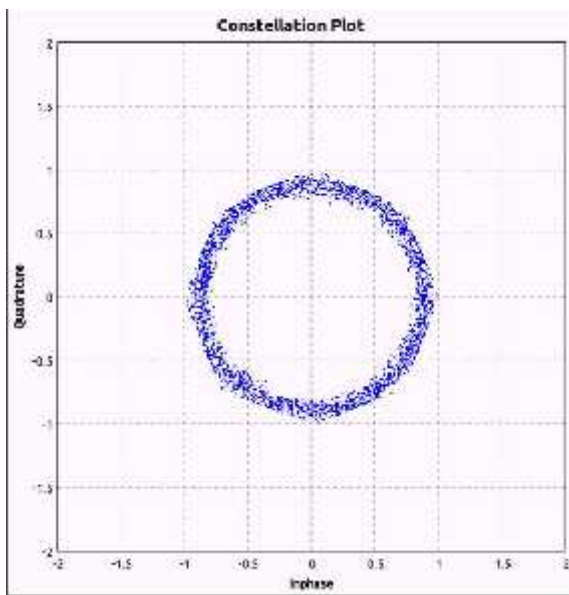

Constellation plot

5.3 ENERGY DETECTION METHOD

This is one of the techniques used for spectrum sensing. Here extraction of input signal power with normalized noise power is done very easily. Energy detection is used due to low processing cost and simplicity. This also can be used to find the spectrum holes and whether the bandwidth is occupied or not. In this method the presence and absence of primary signal is determined using the energy as it refers all signals as noise.

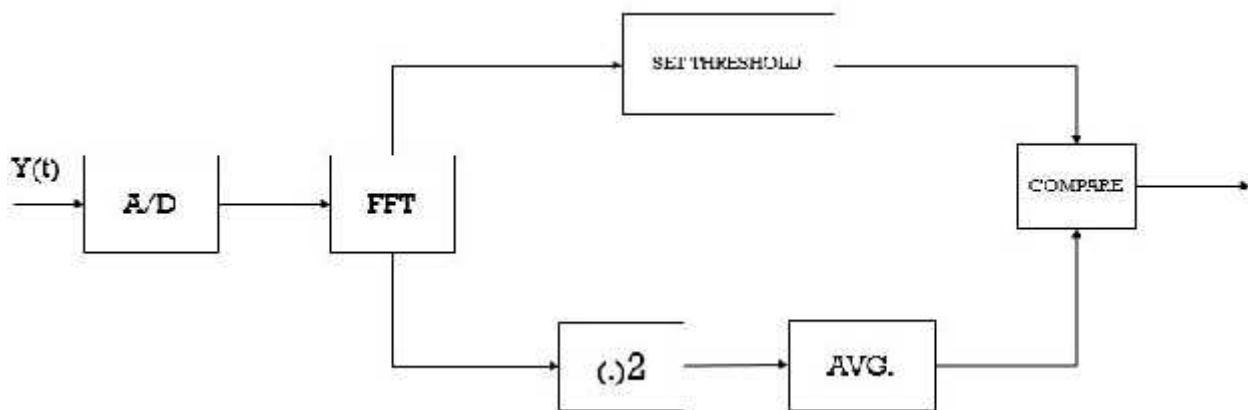

Here the input is passed through FFT then squaring of the coefficient with average is calculated. Then it is compared with threshold to obtain the presence of primary user.

The Simulink design for energy detection where input is passed through a band pass filter then two absolute values are taken followed by windowed integrator. Then the output of the integrator is passed through edge detector then the output of edge detector is compared with the constant value to observe the output on a scope.

5.3.1 ENERGY DETECTION RESULTS:

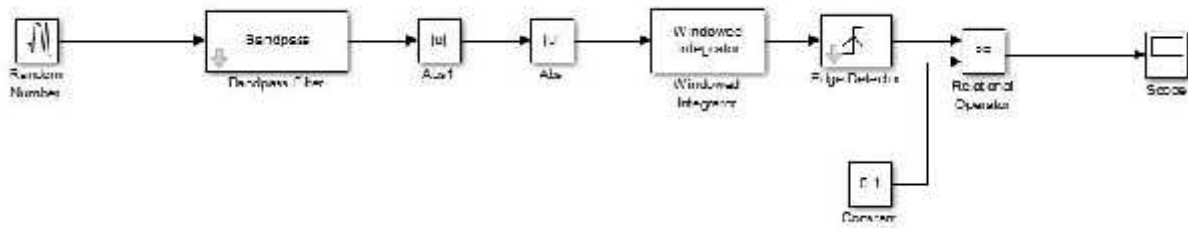

Simulink based energy detection

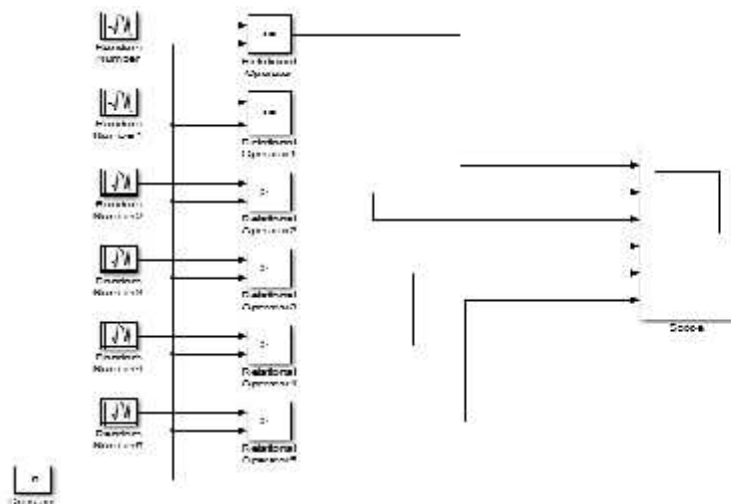

Figure shows the comparison of 6 users with a threshold value and output is shown in scope



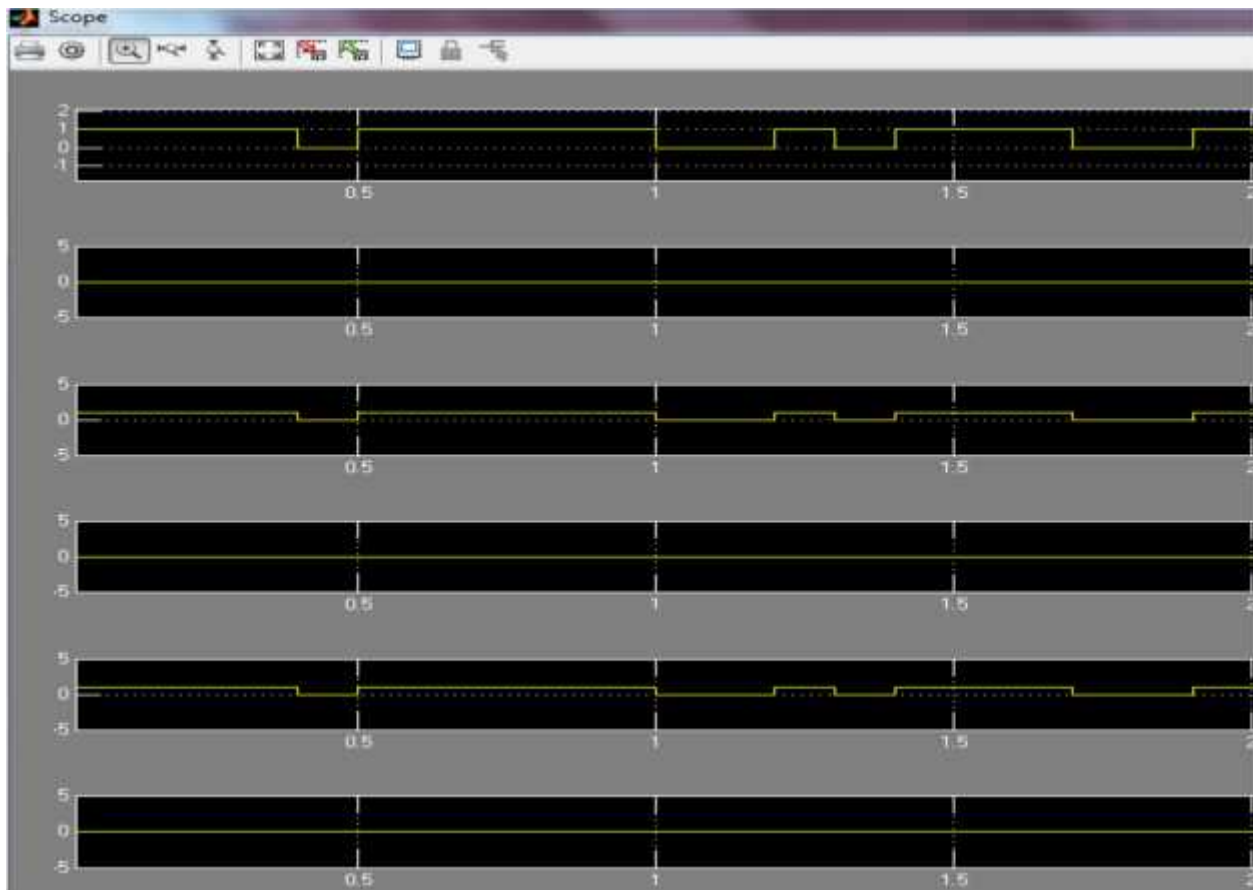

Fig. for Scope output f 6 users

Mathematical Analysis:

$$\text{Primary signal } Y(t) = \left\{ \begin{array}{ll} n(t) & H_0 \\ hs(t)+n(t) & H_1 \end{array} \right\}$$

H_0 =primary user absent

H_1 =primary user present

False Alarm Probability

$$P_f = P(Y > \lambda | H_0)$$

Miss Detection Probability

$$P_m = P(Y < \lambda | H_1)$$

USING RTL-SDR SIMULINK BASED ENRGY DETECTION OF REAL TIME SIGNAL

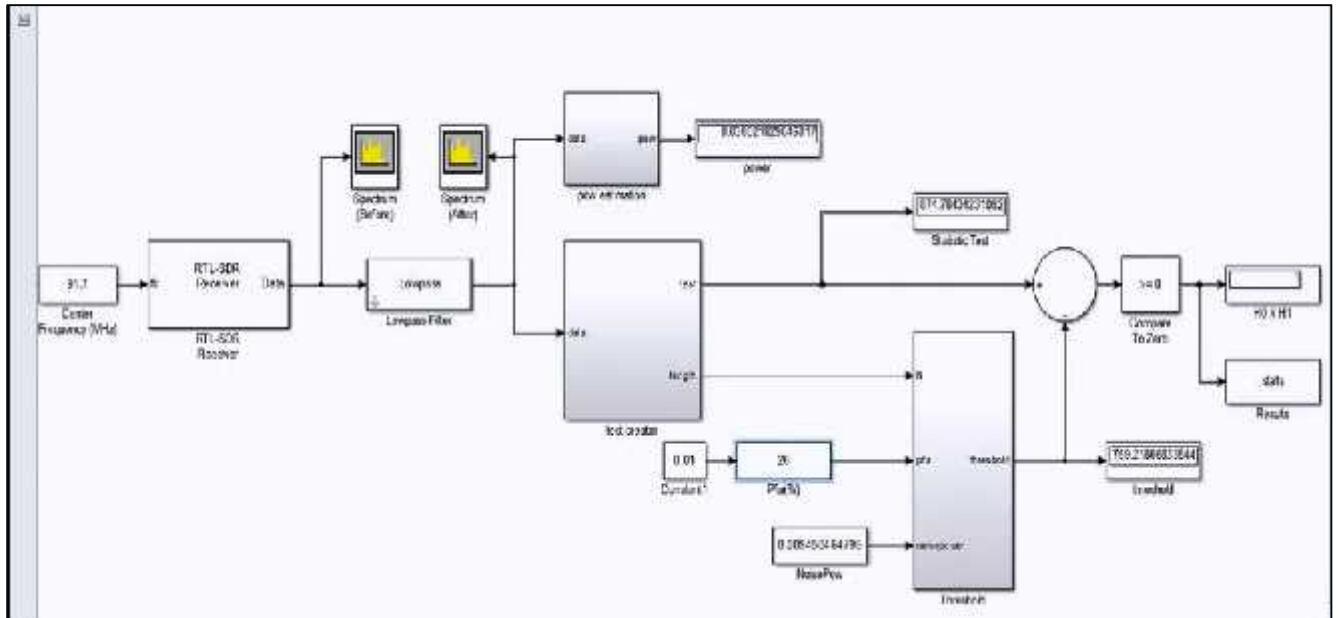

Here using RTL-SDR receiver collection of real time signal is done after that it is passed through a low pass filter. Next the collected data is given to power estimator as well as to the test creator. Same length is given to threshold whose probability of false alarm is 0.2 with a noise power, after the comparison we can get the hypothesis. For H_0 primary user is absent for H_1 primary user is present.

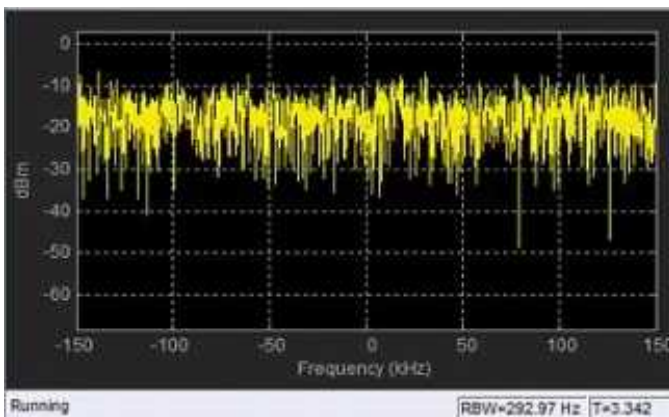

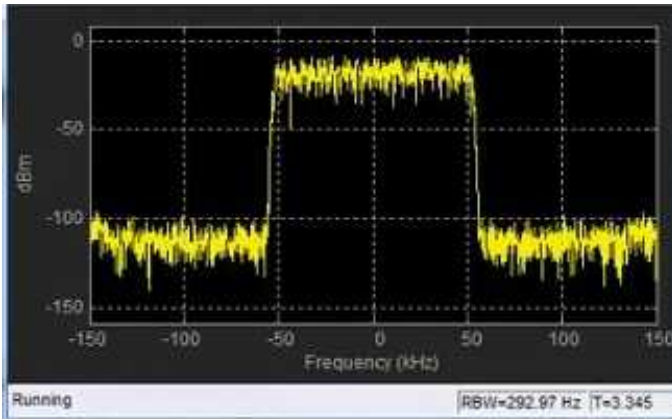

5.4 Cyclostationary Detection

A random process $x(t)$ is known as wide sense stationary if its mean and autocorrelation are periodic with time and both have same period. Mathematically

$$E x(t) = \mu(t + mT_0)$$

$$R_x(t, \tau) = \mu(t + mT_0, \tau)$$

Where t = time index

τ = lag in ACF

m = integer

in terms of Fourier series

$$R_x(t, \tau) = \sum_{\alpha=-\infty}^{\infty} R_x^{\alpha} e^{2j\alpha\tau t}$$

$$\text{Where } R_x^{\alpha}(\tau) = \lim_{T_0 \rightarrow \infty} \frac{1}{T_0} \int_{T_0} x(t - \frac{\tau}{2}) x(t + \frac{\tau}{2}) \exp(-2\pi j\alpha t) dt$$

Now cyclic power spectrum is given by

$$S_x^{\alpha}(\tau) = \int_{-\infty}^{\infty} R_x^{\alpha}(\tau) \exp(-2\pi j\alpha t) dt$$

Next the detection technique is based on hypothesis test

$$H_0^u : r_u(t) = v_u(t)$$

$$H_1^u : r_u(t) = hs(t) + v_u(t)$$

Where $r_u(t)$ = signal sensed

$v_u(t)$ = mean zero bandlimited Gaussian noise

Hypothesis in terms of CPS is given by

$$H_0^u : S_r^\alpha(f) = S_v^\alpha(f)$$

$$H_1^u : S_r^\alpha(f) = S_s^\alpha(f) + S_v^\alpha(f)$$

Test static after deriving will be

$$z_T = \sum_{\alpha} \int_{-f_s/2}^{f_s/2} S_r^\alpha(f) \tilde{S}_r^\alpha(f) df$$

Now detector will be given by

$$H_0^u : z_T < \lambda$$

$$H_1^u : z_T \geq \lambda$$

EXPERIMENTAL SETUP:

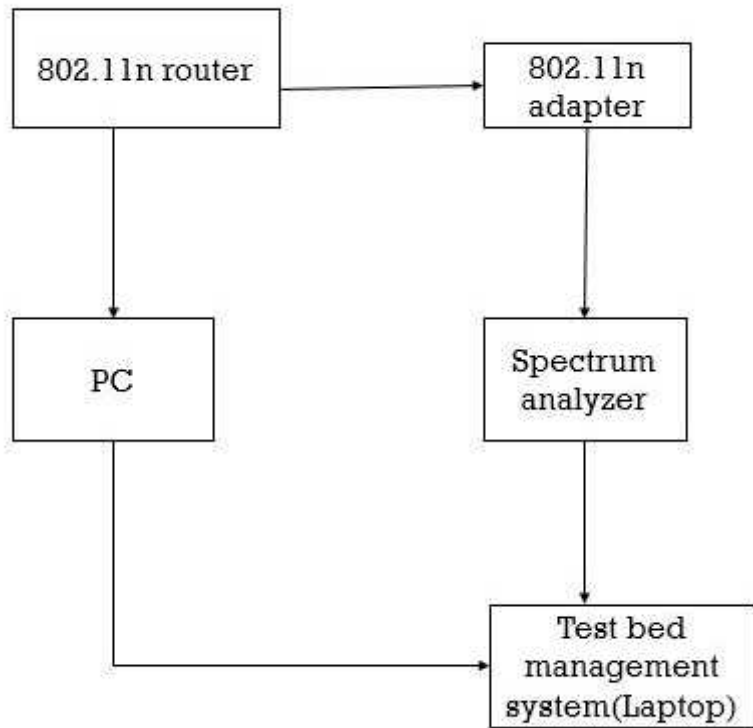

Here in the above figure for cyclostationary detection we have taken 802.11n into consideration. According to the setup 802.11n router is connected to the PC and one adapter is connected to the spectrum analyzer. Both spectrum analyzer and PC are connected to the test bed management system with laptop. The result of the measurement are saved. These IQ format data with the large number of samples from the router collected and compared. Then the next set up made for the LOS and NLOS conditions, whose results are also compared with antenna and router. After the cyclostationary detection we can get the following outputs where cyclic autocorrelation function is plotted vs cyclic frequency and frequency. The setup is tested in two environment those are for line of sight communication and non-line of sight. Both ways real time signals are captured where 802.11n router is placed at two different places. Line of sight means router is placed in front of the antenna and non-line of sight means there is no line of sight communication hence here fading occurs. Here for both cases cyclic auto correlation function vs frequency and cyclic frequency are plotted. Hence by observing the tip of the cyclostationary detector we can identify the signal strength for one cyclic frequency and frequency.

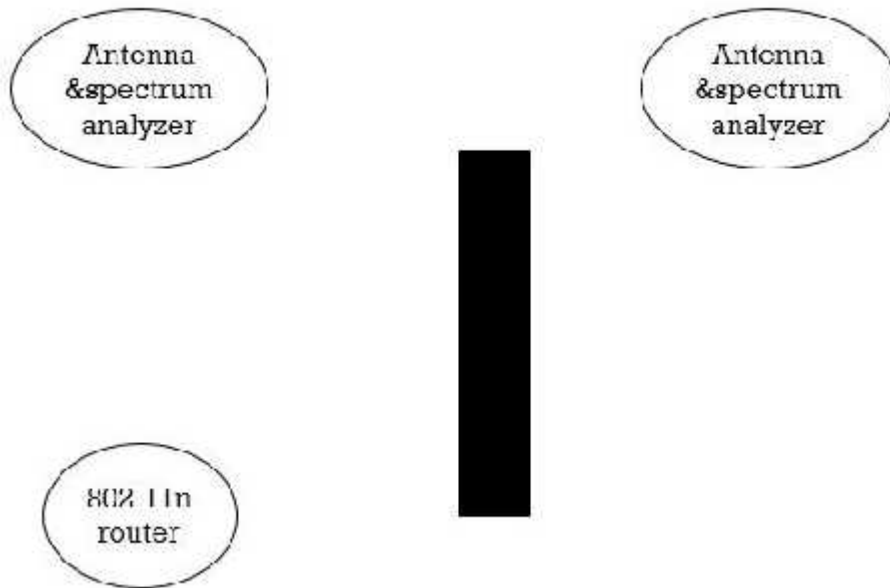

Set up for LOS and NLOS

5.4.1 CYCLOSTATIONARY DETECTION RESULTS:

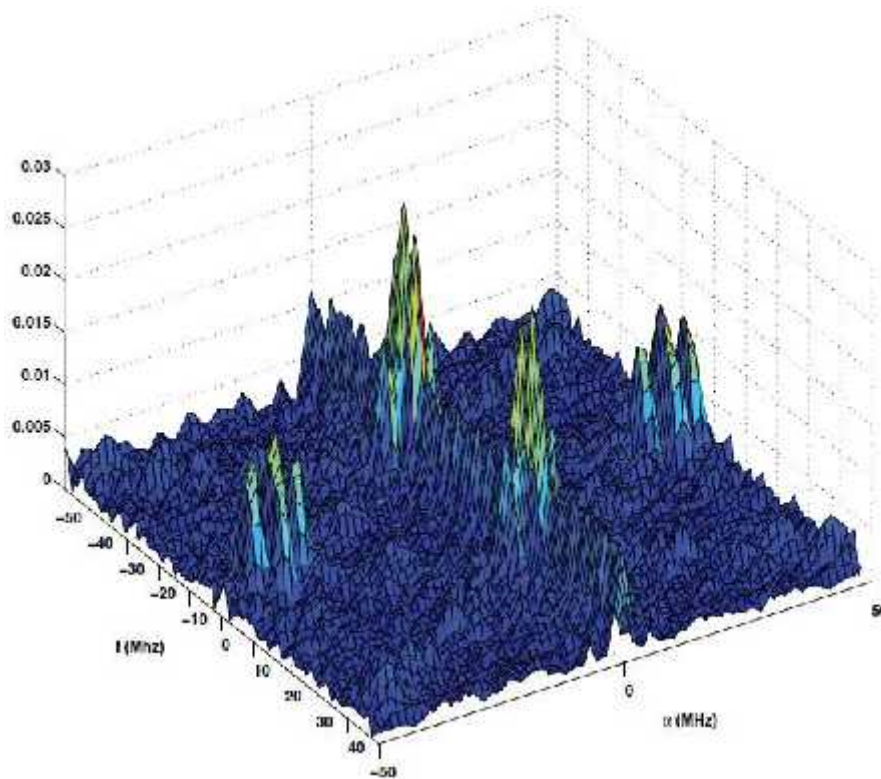

$B = 1.8B_w$
 $B_w = 20\text{MHz}$
 $\text{SNR} = 36\text{dB}$

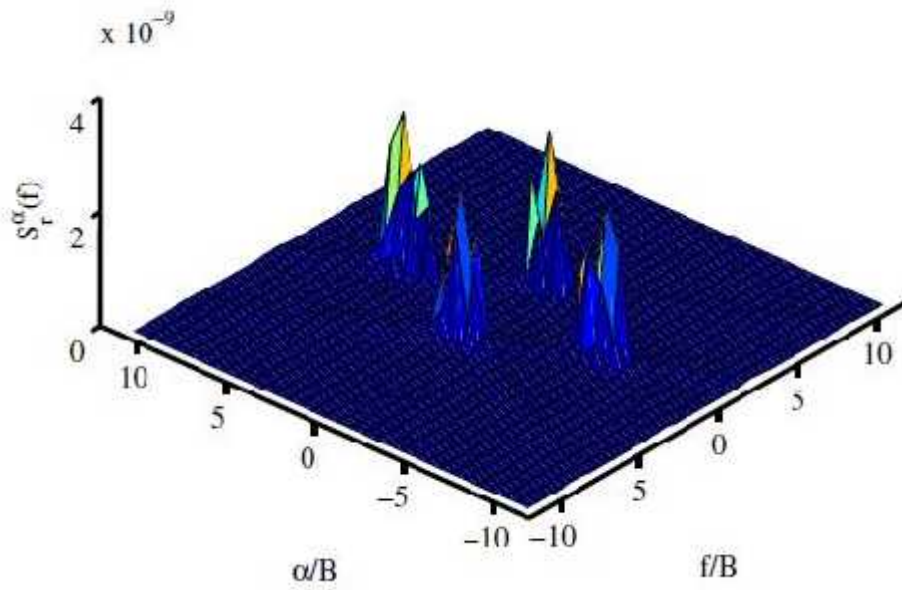

$B_w = 20\text{MHz}$
 $\text{SNR} = 16.3\text{dB}$

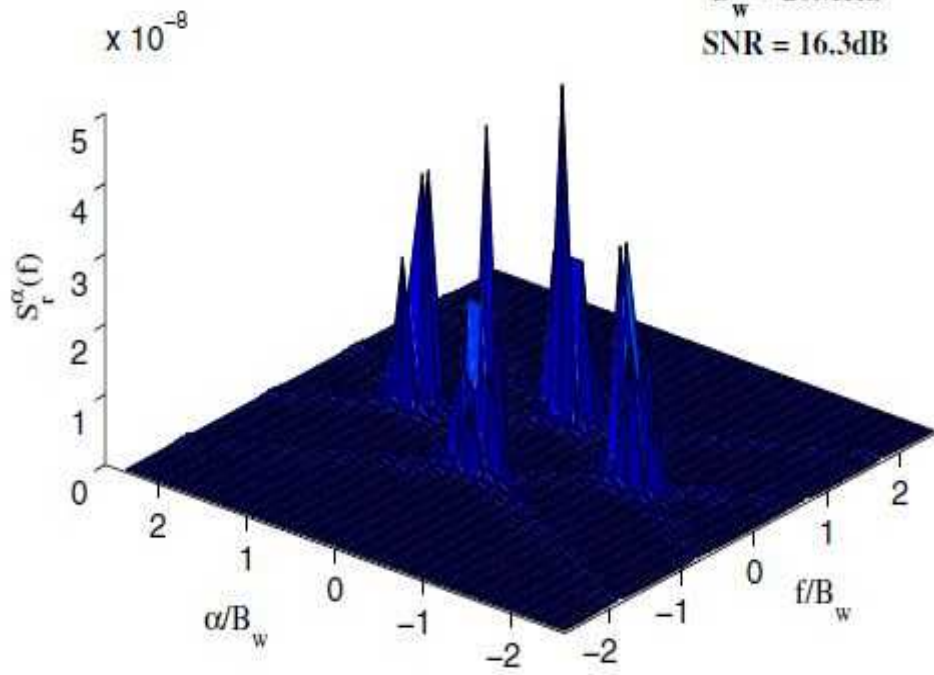

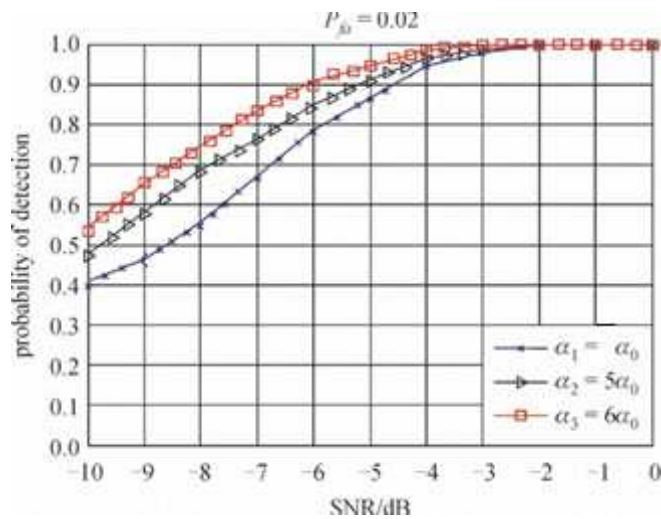
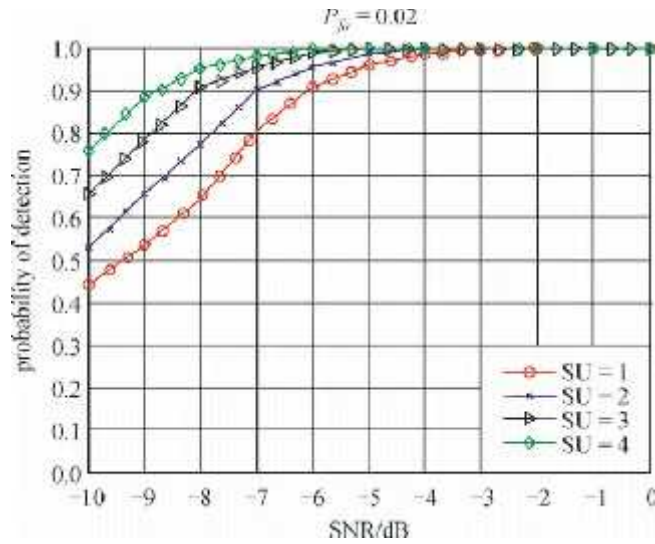

Here probability of detection varies according to the variation in secondary users as well as change in detection probability for variation in cyclic frequencies. For low SNR the probability of detection is higher for high cyclic frequency. As shown in the above figure, the probability of detection varies with respect to a certain probability of false alarm, where they are all dependent upon SNR/dB values. For low SNR values, cyclostationary detection is working fine as we can observe. Unlike the energy detection method, this is not dependent on noise as it is mostly dependent upon the cyclostationary property of the signal. Line of sight means the router is placed in front of the antenna, and non-line of sight means there is no line of sight communication, hence here fading occurs. Here, for both cases, cyclic auto-correlation function vs frequency and cyclic frequency are plotted. Hence, by observing the tip of the cyclostationary detector, we can identify the signal strength for one cyclic frequency and frequency.

Comparison between ED and CFD with ROC plot:

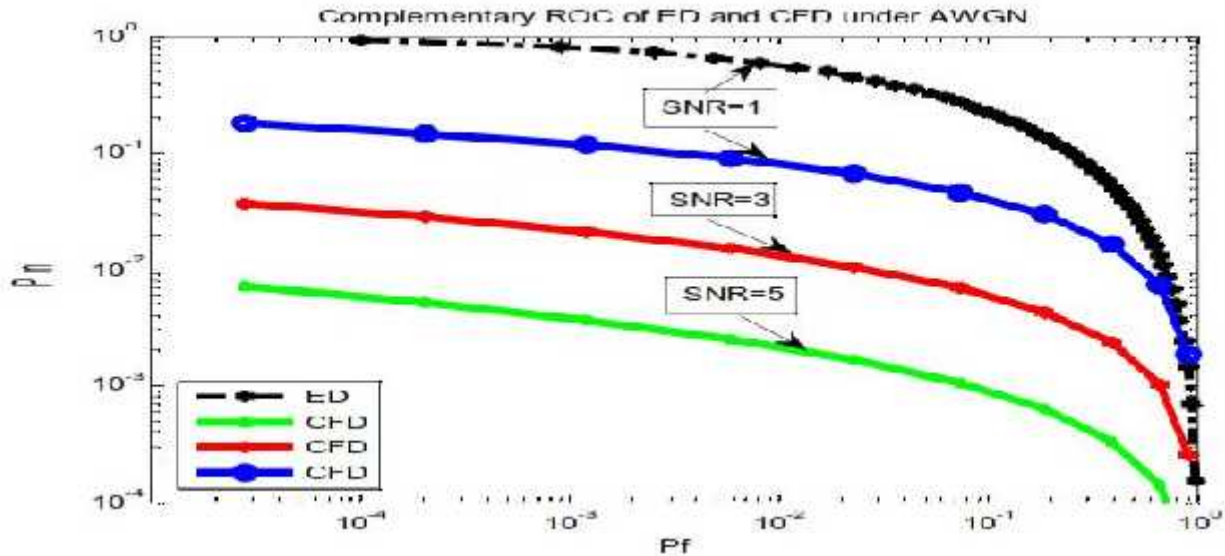

As shown in the above plot the for certain SNR for example SNR = 1 probability of miss detection is reduced for cyclostationary detection as compared to the energy detection method. Hence we have plotted complementary ROC curves for different SNR values.

6. P25 spectrum sensing:

Project 25 (P25) is used by govt. agencies for safety purposes. This is very helpful in case of public safety as well as when emergency arises. Another name of P25 is TETRA (Terrestrial trunked radio). P25 works in two phase where C 4FM plays important role in phase one as 4 frequency shift keying is done. In phase two CQPSK is obtained after raised cosine filter followed by LUP. P25 can be tested for synthesized data as well as captured data to obtain the graph between cyclic auto correlation coefficient vs frequency and cyclic frequency. In first phase it is passed through 12.5 KHz channel and in the second phase it is passed through 6.25 KHz channel. Here symmetric encoding is done with phase differences of -135 degrees, -45 degrees, +45 degrees and +135 degrees. Here the next states are shown in different colors where the can come one after another according to their phase shifts. Cyclostationary process is a stationary process. It also varies cyclically with respect to time. The scanning process is done first followed by modulation. Then

coding is done to identify the given signal. This due to its cyclic nature it can operate in very low signal to noise ratio environment.

In the first case we calculated for the noise case where the graph between autocorrelation function vs the frequency as well as the cyclic frequency is done. Where alpha varies from -1 to 1 which is the cyclic frequency and frequency varies from -0.5 to 0.5.

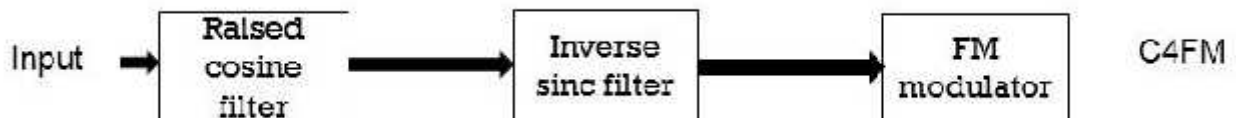
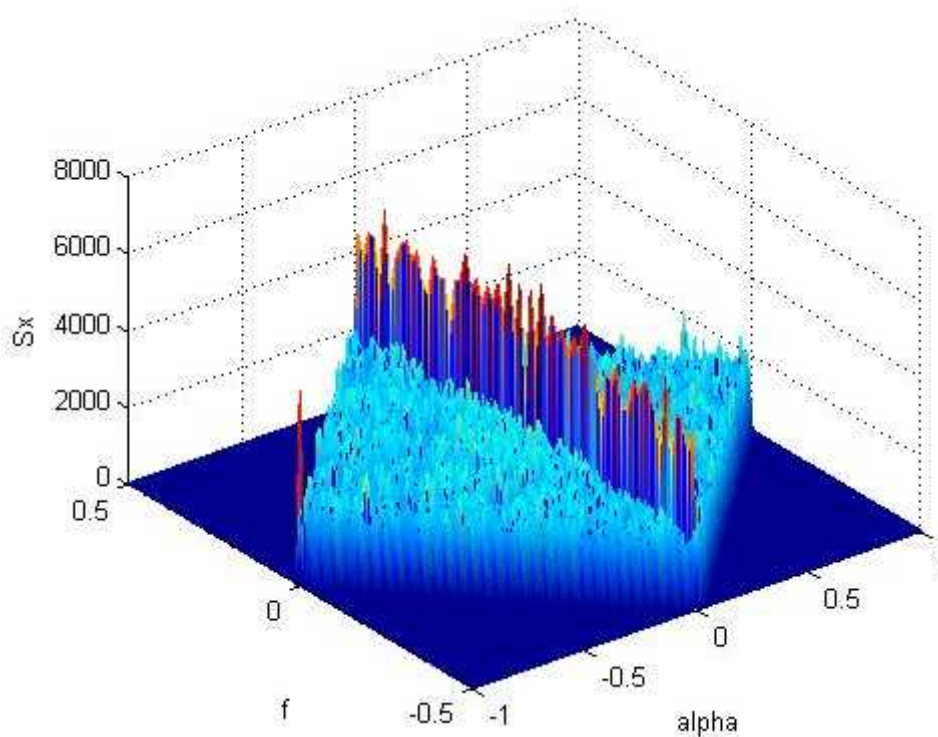

As shown in the above diagram the input is first passed through the raised cosine filter where it satisfies Nyquist pulse shaping criterion. We use this condition to eliminate the ISI (Inter symbol Interference). Here the upsampling factor of four and the roll off factor is 0.2. The sinc response provided before can be eliminated by inverse sinc filter then it is passed through FM modulator to get C4FM output, which completes the phase one.

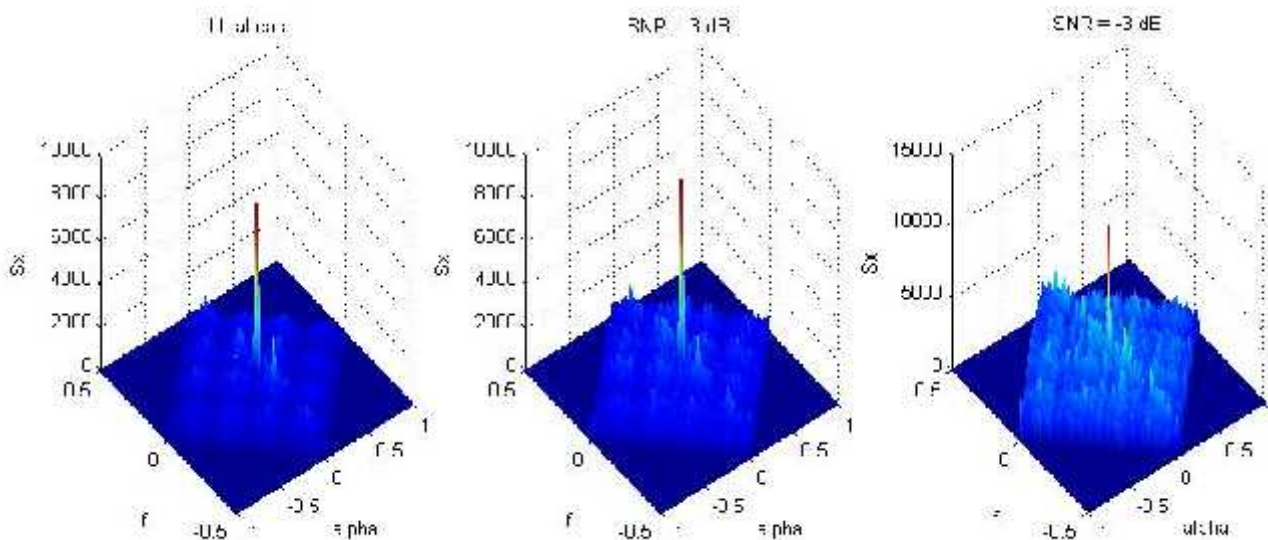

Here the LUP gives the in phase and quadrature terms. This block is basically a DQPSK after which the output is passed through a raised cosine filter which also eliminates the ISI which causes the similar problem as noise. There are three cases here one is ideal one and the other two are varying the snr. The look up table here converts the data inputs into 5 level I/Q points then raised cosine filter used to remove inter symbol interference as this works upon Nyquist criterion to remove ISI. Inter symbol interference arises due the effect of previously transmitted bits upon current received bit generally. This raised cosine filter is basically like a low pass filter. In the next stage we have varied the snr to get the desired output and observed that cyclostationary detection method is independent of signal to noise ratio as it works based upon the cyclic stationary property.

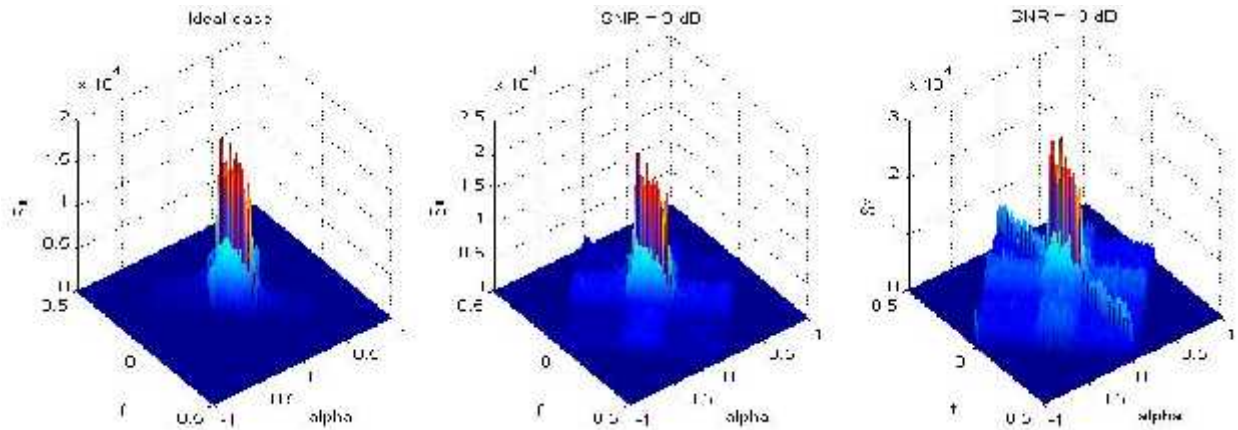

P25 has two phases those are simulated above for C4FM and CQPSK and we have also varied the SNR to get the results and found that cyclostationary feature based detection methods independence from noise makes it a better detection method from energy detection method. After observing the plot for different snr as well as for ideal case we confirmed that cyclostationary detection works fine with the low snr detections.

7. CONCLUSION & FUTURE WORK

In this thesis we have evaluated various spectrum sensing techniques to use the spectrum effectively such as energy detection method & cyclostationary method by collecting the real time signal with help of RTL-SDR. With the method of spectrum sensing problem arising due to low data rate can be solved. Determination of TV white spaces and use that to increase the data rate by avoiding the interference caused by users. Energy detection method is affected by noise which can be solved by cyclostationary detection method. At low SNR value also cyclostationary detector will work fine. Hence cognitive radio can perform well without degrading the performance of licensed user by assigning the white spaces to the secondary users. With this method high data rate and high quality can be achievable.

8. BIBLIOGRAPHY

- [1] Experimental Study of Energy Detection Based Spectrum Sensing in Cognitive Radio: GSM Band Maheshkumar S. Pandit, Arjav A. Bavarva 3rd World Conference on Applied Sciences, 27 sept. 2014
- [2] Experimental Spectrum Sensing Measurements using USRP Software Radio Platform and GNU-Radio Amor Nafkha, Malek Naoues, Krzysztof Cichon, 9th international conference on cognitive radio 2014
- [3] Energy Detection Sensing based on GNU Radio and USRP: An Analysis Study Mohd Adib Sarijari, Arief Marwanto, Norsheila Fisal, Sharifah Kamilah Syed Yusof, Rozeha A. Rashid, Muhammad Haikal Satria 2009 IEEE 9th Malaysia International Conference on Communications 15 -17 December 2009 Kuala Lumpur Malaysia
- [4] Alexander M. Wyglinski, Maziar Nekovee and Y. Thomas Hou Cognitive radio communications and networks, pp 199-221, publisher Academic Press, Nov 2009
- [5] Mitola J., and Maguire, G. Cognitive radio: Making software radios more personal". IEEE Personal Communications, Vol. 6, pp 16-18, 2004
- [6] Allen Ginsberg and William D.Horne, "Towards Cognitive Radio Architecture, Integrating Knowledge Representation with Software defined Radio Technologies," IEEE Military Communication Conference (MILCOM) 2006, pp 3-6, 2006
- [7] Wayne Stark and Pierre de Vries, "Detection of White Spaces in a Cognitive Radio Architecture", IEEE 3rd international Conference on Cognitive Radio Oriented Wireless networks and Communication, 2008.
- [8] Mohammad Z. Ahmed and Mosa A. Abu Rgheff, "Probabilities of Detection and False Alarm in Spectrum Sensing for Cognitive Radio", IEEE conference on Communication systems, pp.579-583, 2010.
- [9] Cognitive radio communications and Network by alexander M. Wyglinsky.
- [10] Cognitive radio, software defined radio, and adaptive wireless systems By H.Arslan
- [11] S. Maleki and G. Leus. "Censored Truncated Sequential Spectrum Sensing for Cognitive Radio Networks," IEEE Journal on selected areas in communications, vol. 31, no. 3, pp. 364-378, 2013.

[12] S. Haykin, Cognitive radio: “brain-empowered wireless communications”, IEEE Journal on Selected Areas in Communications, Vol 23, No.2 Feb 2005.

[13] Allen Ginsberg and William D.Horne, ”Towards Cognitive Radio Architecture, Integrating Knowledge Representation with Software defined Radio Technologies,” IEEE Milatray Communication Conference (MILCOM) 2006, pp 3-6, 2006

[14] Farrukh Javed and Asas Mahmood, “The Use of Time Frequency Analysis For spectrum Sensing in Cognitive Radio”, IEEE signal processing and communication systems, ISBN: 9781424479085, pp 2-4, Dec 2010.

[15] Alexander M. Wyglinski, Maziar Nekovee and Y. Thomas Hou Cognitive radio communications and networks, pp 199-221, publisher Academic Press, Nov 2009.