

SmartFan[®] Nimbus

Speed Control for AC Fans, Pumps and Motors

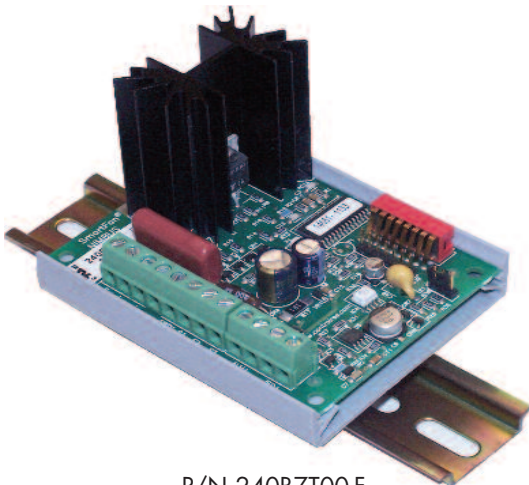

P/N 240B7T00-F
with DIN350-F DIN rail mount kit (sold separately).

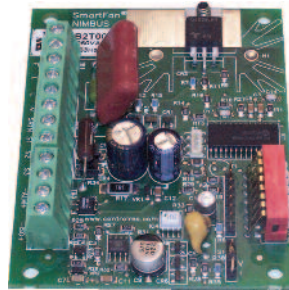

P/N 240B2T00-F

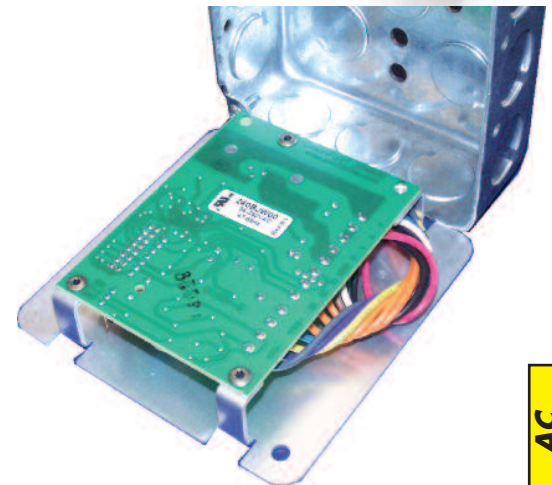

P/N 240BJW00-F
with 4x4 Job Box (not supplied) in background.

AC
Controls

SmartFan Nimbus is a compact, TRIAC based fan & motor control designed for OEM applications in HVAC, electronic and industrial control markets. The Nimbus automatically controls single phase motors that have been approved for voltage control by the motor manufacturer. Typical applications include: humidity control, clean room pressurization, equipment cooling, ceiling fans, exhaust ventilators, pumps, duct fans & blowers. The Nimbus regulates motor speed from a control signal (2-10 VDC, 4-20 mA), humidity sensor, pressure transducer, flow transducer or up to 3 remote temperature sensors. Automatic voltage and frequency detection, current ratings up to 7.5A and 3 mounting and connection configurations, including DIN rail mount and "4x4 job box" mount, make this microprocessor based design extremely flexible and economical.

FEATURES

- Controls fan/motor speed based on:
 - 4-20 mA control signal
 - 2-10 VDC control signal
 - Remote temperature sensors (supplied separately)
 - Remote transducer (humidity, pressure, flow etc.)
 - On board pressure transducer
- Power source: 95-250 VAC, automatically detected
- Frequency: 47-64 Hz, automatically detected
- Fan On/Off threshold selectable by DIP Switch
- AC Motor Type Compatibility: PSC (Permanent Split Capacitor) or Shaded Pole, automatically detected.
- Full voltage start pulse
- RoHS (6/6) compliant
- UL recognized to UL508, CSA-C22.2, File E100344



SELECTABLE OPTIONS

- Current ratings: 2.5A to 7.5A (at 40C still air)
- Mounting Options: PCB mount, DIN Rail mount, 4x4 electrical job box mount
- 4 selectable temperature settings
- 10 selectable pressure settings
- 64 selectable fixed speed settings
- Temperature alarm and lost signal alarm
- Accepts up to 3 temperature sensors
- Selectable idle speeds and control temperature slope

SmartFan® Nimbus

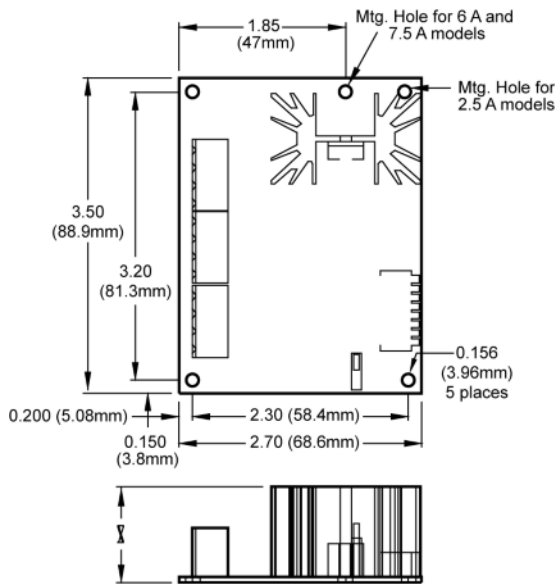

X = 0.86(21.8) at 2.5 A
 X = 1.06(26.9) at 6 A
 X = 2.06(52.3) at 7.5 A

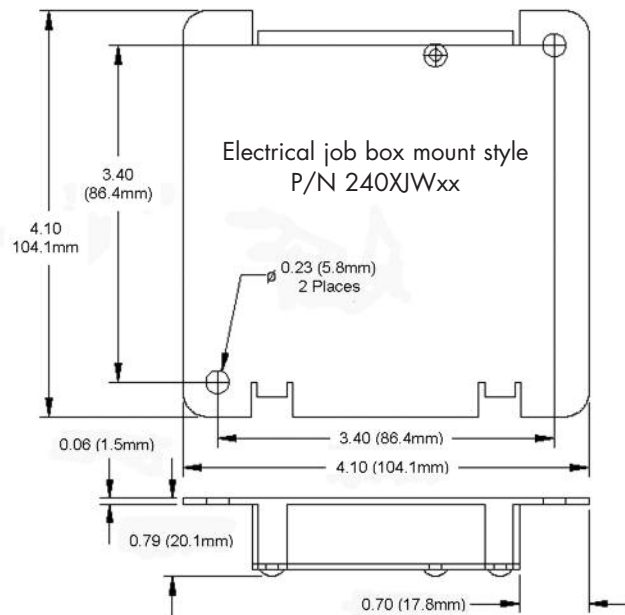

PART NUMBERING SYSTEM¹

Nimbus	Control Mode ²	Current Rating / Packaging ⁴	Connector	Special Features	RoHS Compliant
240	B = Current, Voltage, Temp., Remote Transducer or Fixed Speed T = Temperature & Transducer only ³	2 = .15 - 2.5A 3 = .15 - 3.0A (Job Box only) 6 = .50 - 6.0A 7 = .50 - 7.5A J = .50 - 7.0A (Job Box only)	T = Terminal Block W = 18 AWG Wires (Job Box only)	00 = Standard	-F = 6/6 RoHS Compliant
DIN350-F	Din Rail Kit				

¹Confirm TRIAC (voltage) controllability with the fan/motor manufacturer before ordering.

²When used in the temperature or remote transducer control mode (T), a sensor (sold separately) is required. Choose a compatible SmartFan Sensor shown in the CRI catalog or website at www.controlres.com or control via your own transducer.

³A minimum order of 50 units is required to supply T models.

⁴40°C, still air, max current rating. Maximum surge current not to exceed 24 Amps

Nimbus Datasheet

CONFIRM FAN/MOTOR COMPATIBILITY

Confirm TRIAC (voltage control) compatibility with the fan/motor manufacturer before installation.
Attempting to control a motor that is not compatible could cause excessive heating and permanent damage.

SETTING CONTROL MODES (switches #7,8)

Unless otherwise specified, the Nimbus is factory set to control fans in the Temperature Control mode. To control via a current or voltage source, remote powered transducer or fixed speed setting, set switches 7 and 8 as shown below, then refer to the control mode section you have selected to customize the Nimbus for your application. For on board pressure control models, (2401xx00 and 2405xx00) refer to "USING PRESSURE CONTROL MODELS" section.

Control Via	DIP switch	
	7	8
Current or Voltage	ON	OFF
Remote Powered Transducer	OFF	ON
Temperature	OFF	OFF
Fixed Speed	ON	ON

USING CURRENT OR VOLTAGE CONTROL MODE

Unless otherwise specified, the Nimbus is factory set to control fans in the "Temperature Control" mode. To switch to controlling fan speed via a "Control Signal", refer to table 2. Select the type of control signal you are using [I for 0-20mA (30mA Max.) or V for 0-10VDC (12VDC max.)] using the jumper on header J1. The Nimbus can also be customized to accept other control schemes, contact customer service for details.

Setting Idle Speed (switch #2,3): The idle speed is the minimum voltage (as a % of supply voltage) supplied to the fan. The Nimbus is factory set for idle speeds of 30, 40, 50 and 60% by setting DIP switches 2 and 3. The default idle setting is 50%. Other idle speeds can be supplied, contact customer service for details.

% of supply Voltage	DIP switch	
	2	3
30%	ON	OFF
40%	OFF	ON
50%	OFF	OFF
60%	ON	ON

Fan On / Fan Off Feature (switch #1): To turn fan(s) off below the set idle speed (see table 3), set switch #1 to the ON position. To keep fans running at idle speed below the set idle speed, set switch #1 to the OFF position.

Control Signal Loss Options (switch #6): If the control signal is lost, (less than 4mA in I mode, less than 2VDC in V mode) when switch 6 is OFF fans will continue to idle or remain off. To send fans to full speed if the control signal is lost (less than 4mA in I mode, less than 2VDC in V mode) set switch 6 to the ON position.

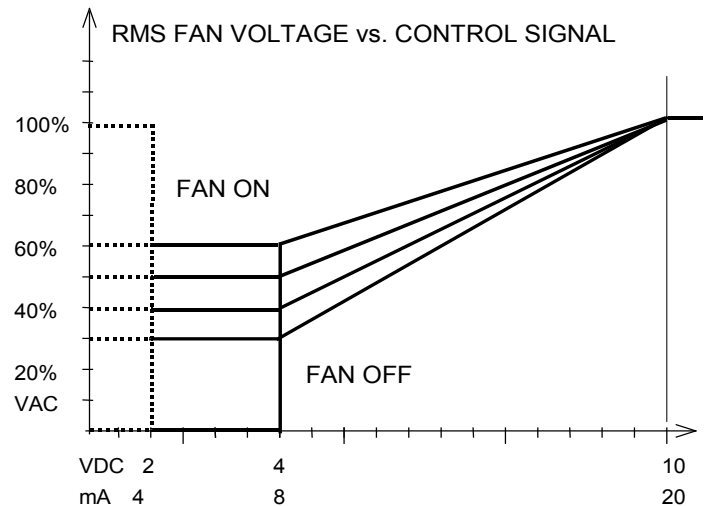

Figure 6

USING TEMPERATURE CONTROL MODE

The Nimbus can automatically control temperature (air, liquid or surface) by proportionately increasing or decreasing fan speed as required. Up to 3 sensors can be used to sense temperature. When more than one sensor is used, the hottest sensor will control fan speed. To set the Nimbus to temperature control mode refer to table 2.

Control Temperature (switch #4,5): The control temperature is the point above which fans will run at full speed (T_c). The Nimbus is factory set to control fans at 30, 35, 40 or 45°C by setting DIP switches 4 and 5. The default setting is 35°C. Other temperature setting can be supplied, contact customer service for details.

Control Temperature (T_c)		DIP switch	
T_c (°C)	T_c (°F)	4	5
30	86	OFF	ON
35	95	OFF	OFF
40	104	ON	OFF
45	113	ON	ON

Nimbus Datasheet

Setting Idle Speed (switch #2,3): The idle speed is the minimum voltage (as a % of supply voltage) supplied to the fan. The Nimbus is factory set for idle speeds of 30, 40, 50 and 60% by setting DIP switches 2 and 3, see table #3. The default setting is at 50%. Other idle speeds can be supplied, contact customer service for details. See figure 7.

Temperature Slope (switch #6): The temperature slope (T_s) is the temperature difference between idle speed and full speed. The slope can be set at 4°C or 10°C by using DIP switch #6. The default setting is 4°C. Other slopes can be supplied, contact customer service for details. See figure 7.

Setting Control Parameters (switch #3,4,5,6): To customize the control slope to your transducer, use DIP switches 3 & 4 to set idle or minimum speed voltage, use switches 5 & 6 to set full speed control voltage. See table 6, and figure 8 for details.

DIP switch		VDC (min)	Dip Switch		VDC (max)
3	4		5	6	
OFF	OFF	0.5	OFF	OFF	3.0
ON	OFF	1.0	ON	OFF	3.5
OFF	ON	1.5	OFF	ON	4.0
ON	ON	2.0	ON	ON	4.5

Temp. Slope (T_s)		DIP switch
T_s (°C)	T_s (°F)	6
4	7	OFF
10	18	ON

Fan On / Fan Off Feature (switch #1): To turn fans off automatically when temperatures drop below the set idle temperature ($T_c - T_s$), set switch #1 to the ON position. To keep fans running at idle speed below the set idle temperature, set switch #1 to the OFF position. See figure 7.

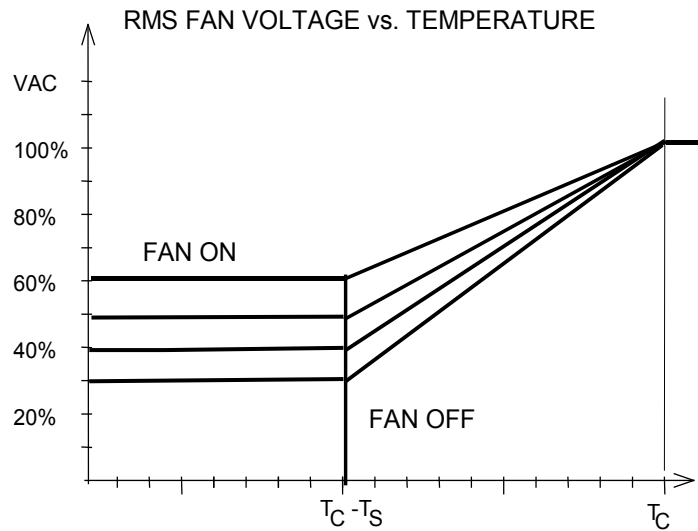

Figure 7

USING REMOTE POWERED TRANSDUCER MODE

When used in the remote transducer mode, the Nimbus can power and control from most 0-5VDC transducers (humidity, pressure, flow etc.) with a maximum supply current of 5mA. To set the Nimbus to remote transducer mode, see table 2.

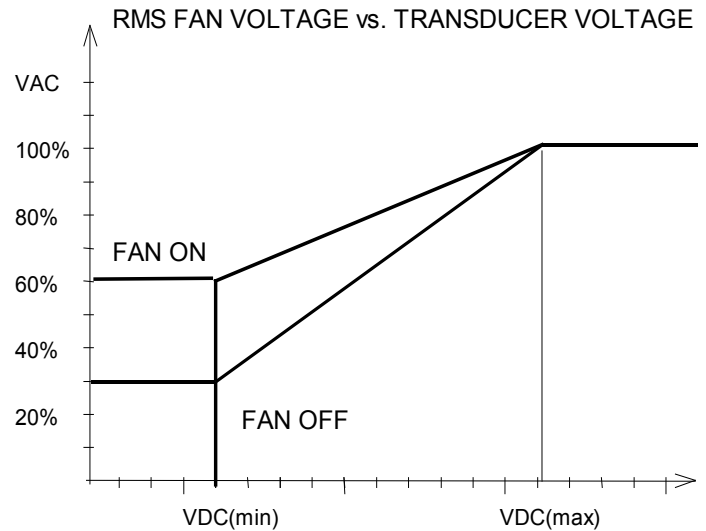

Figure 8

Fan On / Fan Off Feature (switch #1): To turn fans off automatically when transducer voltage drops below VDC (min), set switch #1 to the ON position. To keep fans running at idle speed below the VDC(min), set switch #1 to the OFF position. See figure 8.

Setting Idle Speed (switch #2): The idle speed is the minimum voltage (as a % of supply voltage) supplied to the fan. When used in the remote transducer mode, the Nimbus can be set for idle speeds of 30% by setting DIP switch #2 to OFF or 60% by setting DIP switch #2 to ON. Other idle speeds can be supplied, contact customer service for details. See figure 8.

USING FIXED SPEED MODE

Automatic speed control can be overridden in the fixed speed mode. To set the Nimbus to fixed speed mode, see table 2. In the fixed speed mode, the user can select motor voltages from 27% to 99% (in 1% or 2% increments) of supply voltage using DIP switches 1 through 6, see table 7.

Nimbus Datasheet

Table 7: Fixed Speed Settings						
% voltage	DIP switch settings					
	1	2	3	4	5	6
27%	OFF	OFF	OFF	OFF	OFF	OFF
28%	ON	OFF	OFF	OFF	OFF	OFF
30%	OFF	ON	OFF	OFF	OFF	OFF
32%	ON	ON	OFF	OFF	OFF	OFF
33%	OFF	OFF	ON	OFF	OFF	OFF
35%	ON	OFF	ON	OFF	OFF	OFF
36%	OFF	ON	ON	OFF	OFF	OFF
37%	ON	ON	ON	OFF	OFF	OFF
39%	OFF	OFF	OFF	ON	OFF	OFF
40%	ON	OFF	OFF	ON	OFF	OFF
41%	OFF	ON	OFF	ON	OFF	OFF
42%	ON	ON	OFF	ON	OFF	OFF
43%	OFF	OFF	ON	ON	OFF	OFF
44%	ON	OFF	ON	ON	OFF	OFF
45%	OFF	ON	ON	ON	OFF	OFF
47%	ON	ON	ON	ON	OFF	OFF
48%	OFF	OFF	OFF	OFF	ON	OFF
49%	ON	OFF	OFF	OFF	ON	OFF
50%	OFF	ON	OFF	OFF	ON	OFF
51%	ON	ON	OFF	OFF	ON	OFF
53%	OFF	OFF	ON	OFF	ON	OFF
54%	ON	OFF	ON	OFF	ON	OFF
55%	OFF	ON	ON	OFF	ON	OFF
56%	ON	ON	ON	OFF	ON	OFF
57%	OFF	OFF	OFF	ON	ON	OFF
58%	ON	OFF	OFF	ON	ON	OFF
60%	OFF	ON	OFF	ON	ON	OFF
61%	ON	ON	OFF	ON	ON	OFF
62%	OFF	OFF	ON	ON	ON	OFF
63%	ON	OFF	ON	ON	ON	OFF
64%	OFF	ON	ON	ON	ON	OFF
65%	ON	ON	ON	ON	ON	OFF
67%	OFF	OFF	OFF	OFF	OFF	ON
68%	ON	OFF	OFF	OFF	OFF	ON
69%	OFF	ON	OFF	OFF	OFF	ON
70%	ON	ON	OFF	OFF	OFF	ON
71%	OFF	OFF	ON	OFF	OFF	ON
72%	ON	OFF	ON	OFF	OFF	ON
74%	OFF	ON	ON	OFF	OFF	ON
75%	ON	ON	ON	OFF	OFF	ON
76%	OFF	OFF	OFF	ON	OFF	ON
77%	ON	OFF	OFF	ON	OFF	ON
78%	OFF	ON	OFF	ON	OFF	ON
79%	ON	ON	OFF	ON	OFF	ON
80%	OFF	OFF	ON	ON	OFF	ON
81%	ON	OFF	ON	ON	OFF	ON
82%	OFF	ON	ON	ON	OFF	ON
83%	ON	ON	ON	ON	OFF	ON
84%	OFF	OFF	OFF	OFF	ON	ON
85%	ON	OFF	OFF	OFF	ON	ON

Table 7: Fixed Speed Settings (continued)						
voltage	DIP switch settings					
	1	2	3	4	5	6
86%	OFF	ON	OFF	OFF	ON	ON
87%	ON	ON	OFF	OFF	ON	ON
88%	OFF	OFF	ON	OFF	ON	ON
89%	ON	OFF	ON	OFF	ON	ON
90%	OFF	ON	ON	OFF	ON	ON
91%	ON	ON	ON	OFF	ON	ON
92%	OFF	OFF	OFF	ON	ON	ON
93%	ON	OFF	OFF	ON	ON	ON
94%	OFF	ON	OFF	ON	ON	ON
95%	ON	ON	OFF	ON	ON	ON
96%	OFF	OFF	ON	ON	ON	ON
97%	ON	OFF	ON	ON	ON	ON
98%	OFF	ON	ON	ON	ON	ON
99%	ON	ON	ON	ON	ON	ON

Humidity and Pressure Sensor Options: Special versions of the Nimbus can be used with Measurement Specialties (www.meas-spec.com) humidity sensor P/N HM1500LF or an on-board pressure sensor factory set to 0.10" to 1.00" or 0.50 to 5.00 H²O. Contact customer service for details.

MOUNTING

Electrical "job box" mount (Fig 3): The Nimbus can be supplied in circuit board form or with a cover, ready to mount in a standard 4x4x1.5 electrical job box. When supplied in the job box form, part number 240_JW__ or 240_3W__, connections are made through 4.0" (10cm), 18AWG wires. Wires should be terminated using wire nuts (not included) according to local electrical codes. Unused wires may be cut off at the circuit board or can be depopulated at the factory for production orders. **Caution:** bundling unused wires together may cause a short and damage the unit.

Circuit Board Form: When supplied in the circuit board form, a spacing of 1/4" (6.3mm) should be maintained between the circuit board and chassis ground and 5/16" (8mm) to any uninsulated secondary circuits to satisfy safety agency requirements. To enable part numbers 240x6xxx or 240x7xxx to pass HI-POT testing, avoid making connection to ground at the mounting hole closest to the heatsink, H1. See Figure 4.

DIN Rail Option (Fig 1): Units supplied in circuit board form may be mounted on a DIN rail using DIN rail kit CRI #DIN350-F.

Nimbus Datasheet

CONNECTIONS

WARNING: Dangerous voltages are present on the circuit board when connected to the power line. Power must be removed before making any connections or adjustments to avoid electrical shock or damage to the unit.

Power Connections: It is recommended that an adequately sized circuit breaker be connected between the power service and the control to permit fail-safe removal of power before making adjustments or connections. Connect line power (white) to location N. Connect line power (black) to location L. When using an electrical “job box” mount version secure any ground (green) wire to a steel electrical box or consult local electrical codes.

The Nimbus is not compatible with Uninterruptible Power Supplies (UPS) that generate a square wave.

Fan Connections: Connect fan or fans to positions marked F (red) and L (black). Any number of fans may be controlled in parallel from one unit as long as the total current does not exceed the current rating. See table 1 and figure 9.

Temperature Sensor Selection and Connection: The Nimbus will accept signals from up to 3 temperature sensors and control fan speed based on the hottest sensor. Choose an air, surface or liquid temperature sensor from the CRI catalog or website at www.controlres.com. Each sensor, S1, S2, S3 shares a common return marked SRTN. **CAUTION: SRTN is a non-isolated input; use CRI sensor P11-F or other sensor with a jacketed cable if installing temperature sensors in a dwelling.** When fewer than 3 sensors are used, sensors may be hooked up to S1, S2 or S3. In “Temperature mode”, if no sensors are connected or all sensors read below -25°C, fans will run at full speed and the temperature alarm will activate. The Nimbus can also be supplied with a board mount sensor, contact customer service for details. See wiring diagram, figure 9.

Remote Powered Transducer Connections: When used in the remote transducer mode, the Nimbus can power and control from any 0-5VDC transducer (humidity, pressure, flow etc.) with a maximum supply current of 5mA. Connect the + lead to SRTN, connect – to S1, connect Vout to S2.

Refer to “USING REMOTE POWERED TRANSDUCER MODE” section to set control parameters for your transducer.

Over Temperature and Loss of Signal Alarm Connection (for 240Bxxx models only): When used in the temperature control mode, (see table 2) an over-temperature alarm can be triggered when the temperature goes 10°C (18°F) above the control temperature (T_C) or below -25°C. When used in the Voltage or Current signal mode a “loss of signal” alarm can be triggered when DIP switch #6 is in the ON position. Alarm connections are made at –ALM+

The alarm output is a normally open, optically isolated MOS Relay. When no alarm condition is present, the relay is closed and can conduct up to 100 ma. AC or DC, of load current. When the alarm is triggered, the relay opens, and can support up to 300 Volts AC or DC across its terminals. Other alarm trigger points can be supplied, contact customer service for details. See figure 9, 9a, 9b or 9c for possible alarm configurations.

Current or Voltage Control Signal Connections: When used in the current or voltage control mode (see table 2), connect a 0-10VDC or 0-20mA control signal to –ISO+ as shown in figure 9.

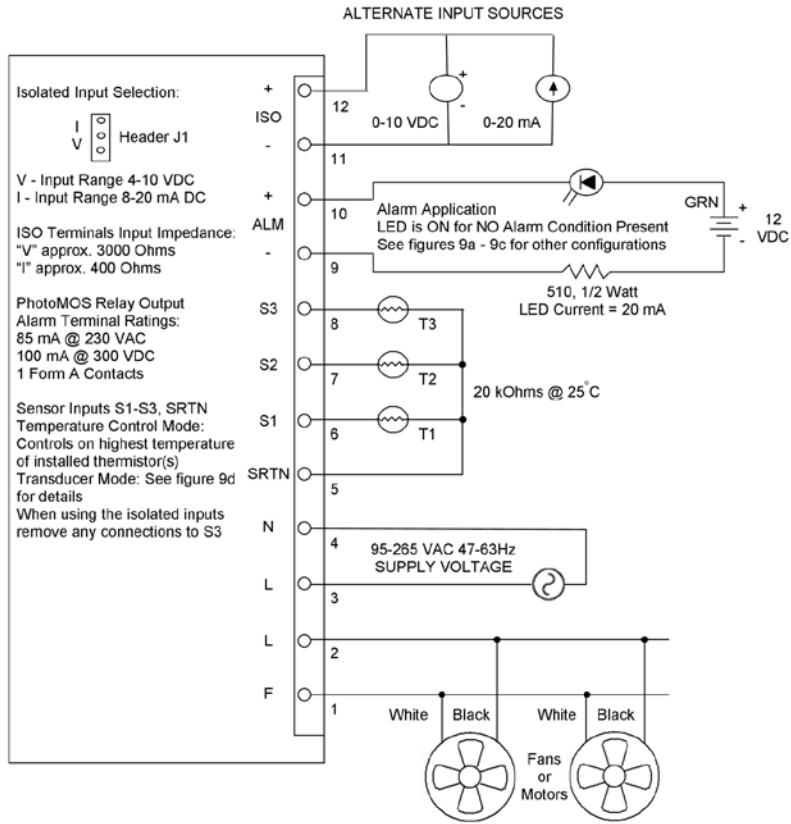

Figure 9: Wiring Diagram

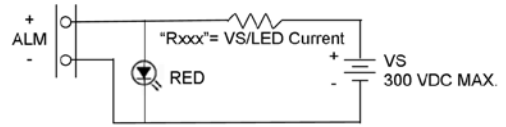

Figure 9a: Driving an LED with DC Voltage, "ON" for Alarm Condition Present

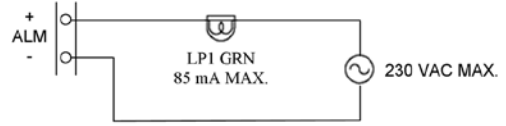

Figure 9b: AC Lamp, "OFF" for Alarm Condition Present

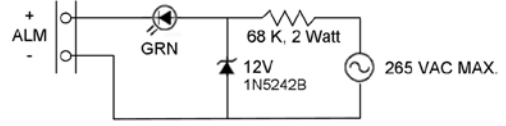

Figure 9c: Driving an LED with AC Voltage, "OFF" for Alarm Condition Present

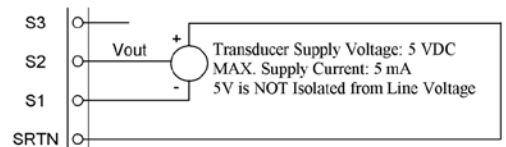

Figure 9d: Controlling with a Voltage Output Transducer

Figure 9a.-d.: Examples of Alternate Alarm and Control Input Configurations

Table 8: Pin-out and Connection Options

Pin-outs		Connection Options	
Board Reference	Description	Terminal Block (T)	4" (100mm) Wire (W)
F:TB1 (pin 1)	Fan	14 – 24 AWG Screw Clamp	18 AWG Red
L: TB1	Fan		18 AWG Black
L: TB1	Line Power		18 AWG Black
N: TB1	Line Power		18 AWG White
SRTN-: TB2 (pin 1)	Sensor (return)		18 AWG Brown
S1: TB2	Sensor #1		18 AWG Orange
S2: TB2	Sensor #2		18 AWG Orange
S3: TB2	Sensor #3		18 AWG Orange
- ALM: TB3 (pin 1)	- Temp. Alarm		18 AWG Blue
ALM +: TB3	+ Temp. Alarm		18 AWG Yellow
- ISO: TB3	- Control Signal		18 AWG Violet
ISO +: TB3	+ Control Signal		18 AWG Gray

Nimbus Datasheet

TESTING & TECHNICAL DATA

Fan Compatibility: The Nimbus is compatible with many PSC (Permanent Split Capacitor) and shaded pole motors. The Nimbus is not compatible with capacitor start motors. Confirm TRIAC controllability with the motor manufacturer before installation. Attempting to control a fan that is not compatible could cause excessive heating and could permanently damage the fan motor.

Control Accuracy and Hysteresis: The standard Nimbus is accurate to within $\pm 1.5^{\circ}\text{C}$ in the temperature control mode and $\pm 0.4\text{VDC}$, $\pm 0.8\text{mA}$ in the control signal mode. If your application requires greater accuracy, contact customer service. For most single-phase AC fans, there is direct correlation between fan speed and voltage. For some fans however, this will not be the case. To prevent fans (using fan ON/OFF feature) and alarms from cycling on and off, a certain amount of hysteresis has been built in to the Nimbus. That is, fans will shut off 2-3% below the set point and turn back on 2-3% above the set point. Alarms will turn on at the set point and turn off 1-2 $^{\circ}\text{C}$ below or 5% above the set point.

Voltage Loss: For a typical fan, expect a voltage drop to the fan of about 2-4% at full voltage.

Changing Control Settings: With the exception of the "fixed speed mode", the Nimbus will not recognize any changes in switch or jumper settings made with power applied. Power must be turned OFF before changing any switch or jumper settings.

Minimum fan currents: Fans may not control properly if the total fan current is less than the minimum published current, see table 1.

Maximum fan currents: Some motors draw higher current at less than maximum voltage. Contact motor manufacturer for details.

Start Pulse: Some fans that run just fine at lower voltages will not start at these voltages; therefore the Nimbus will start fans at full voltage for 2 seconds before throttling back to the appropriate control speed.

Control Resources has been a leading provider of off-the-shelf and custom fan controls and alarms since 1984. Control Resources can offer DC Speed Controls, AC Speed Controls, Tach Alarms, Fan Trays, Lab Test Equipment and complete custom design and manufacturing services. With in house ISO 9001 design and manufacturing capabilities, CRI is the One-Stop-Shop for all your thermal design needs. For information on other CRI products, see our website at www.controlresources.com or contact Control Resources, Inc.

EMI: The amount of electrical noise emitted by the Nimbus increases as fan speed decreases. The amount of noise emitted is fan dependent. If the electrical noise is an issue, an AC Input Line Filter can be used. CRI recommends the following line filters from www.filterconcepts.com or equivalent.

Emissions class	0-3A load	0-7A load
EN55011, class A	Not required	Not required
EN55011, class B	LE5	LE10
FCC 47CFR part 15, class B	LX3	LX10

Current Derating: The Nimbus may be run above 40 $^{\circ}\text{C}$. However, the maximum current ratings will decline according to the chart below.

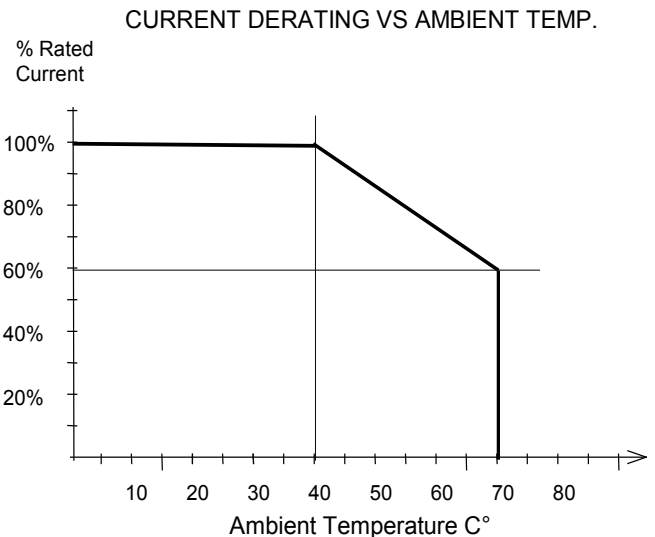

Figure 10

Specifications:

- **Power Source:** 95 – 250 VAC
- **Frequency:** 47-64 Hz
- **Current Ratings:** see table 1
- **Storage Temperature:** -40 $^{\circ}\text{C}$ to 125 $^{\circ}\text{C}$
- **Operating Temperature:** -25 $^{\circ}\text{C}$ to 70 $^{\circ}\text{C}$