



SpeedScrub Rider

Featuring



and Hygenic™ Tanks

Service Information

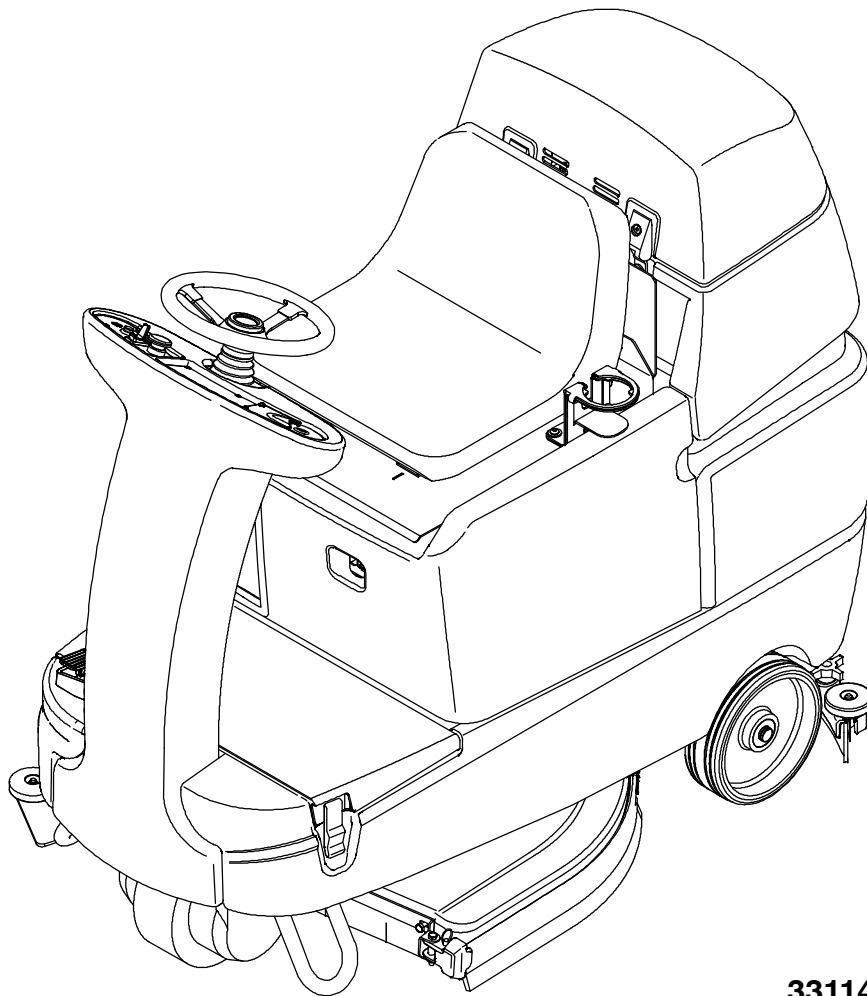

331145

Rev. 00





This manual provides service information for the NOBLES SpeedScrub Rider machine.

This machine will provide excellent service. However, the best results will be obtained at minimum costs if:

- The machine is operated with reasonable care.
- The machine is maintained regularly - per the maintenance instructions provided.
- The machine is maintained with NOBLES supplied or approved parts.

Manual Number - 331145

Revision: 00

Published: 12-04

Nobles and the FaST Foam Scrubbing Technology logo are United States registered trademarks of Tennant Company.

Copyright © 2004 NOBLES, Printed in U.S.A.

Table of Contents

Electrical Troubleshooting Information	1
Commonly Used Electrical Symbols & Terms.....	2
Ladder Schematic	3
Wire Harness Group.....	5
Key OFF, Operator NOT on Seat.....	9
Key OFF, Battery Charger Plugged In	10
Key ON, Operator on Seat	11
Tank Level Sensors.....	12
Horn & Hour Meter Systems	13
Propel Forward System.....	14
Propel Reverse System.....	15
Braking System	16
Scrub Head & Squeegee Actuator Systems	17
Scrub Brush Motors System.....	19
Vacuum Fan System	20
FaST System.....	21
Conventional Solution System.....	22
LED Locations & Descriptions.....	23
Operational Modes & Interlocks	24
Diagnostic & Fault Alarms	25
Alarm Codes	25
High Current Faults	25
Diagnostic & Configuration Modes	26
Display Software Revision Mode	27
Self Test Mode	28
Input Display Mode.....	29
Manual Mode.....	30
Propel / Brake Diagnostics	31
Battery Select Mode & Voltage Levels	32
Battery Select Mode.....	32
Voltage Levels.....	32
Reverse Alarm & Propel Speed Select Modes	33
Reverse Alarm Select Mode	33
Propel Speed Select Mode	33
Inputs & Outputs Table.....	34
Torque Standard.....	35
Inch Fasteners.....	35
METRIC Fasteners.....	37
Nylon Insert Lock Nuts	39
Nut-Hex Light THIN	39
Wheel Bolt and Nuts.....	40
Wheel Bearing Adjustment.....	40
Tightening Nuts on Tapered Shafts	41
Shoulder Bolts	42
Taper Lockr Bushings	43
Sequence Tightening	44

ELECTRICAL

Troubleshooting Information

BEFORE CONDUCTING TESTS:

- * Read and Follow ALL Safety Warnings and Precautions in Operator's Manual
- * Always use an ESD (Electrostatic Discharge) strap when working near the Control Board
- * Be cautious when working near Control Board – Battery voltage is always present, even with Key OFF
- * Always unplug Positive Battery Cable when removing or replacing components

DURING TESTS:

- * Call Technical Services if Diagnostic Time Exceeds One Hour With Unknown Cause or Course of Action

NOTE: Troubleshooting charts may be shown with optional equipment. The optional equipment may not be specified in these charts. Some machines may not be equipped with all components shown.

Commonly Used Electrical Symbols & Terms

NOTE: The term "NORMALLY" refers to the components' "at rest" or "de-energized" position

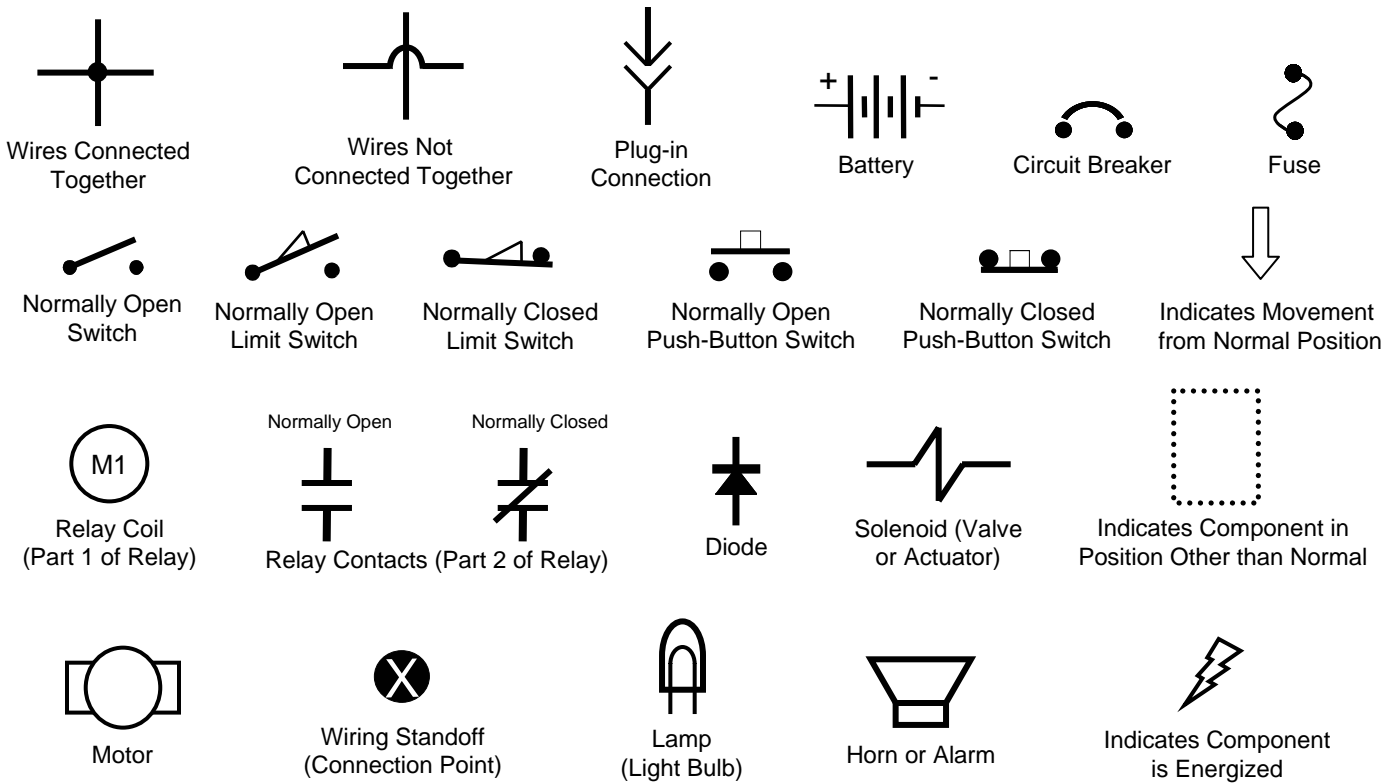

Terms & Abbreviations

BDI – Battery Discharge Indicator

Dynamic Braking – A method of using the generating nature of an electric motor to slow the machine

Hall Effect – A voltage developed as a result of current flow in the presence of a magnetic field

LED – Light Emitting Diode

PM – Permanent Magnet

PWM (Pulse Width Modulation) – A method of using controlled on/off times to regulate the voltage and current supplied to an electrical device

Example of Wiring Numbers & Colors:

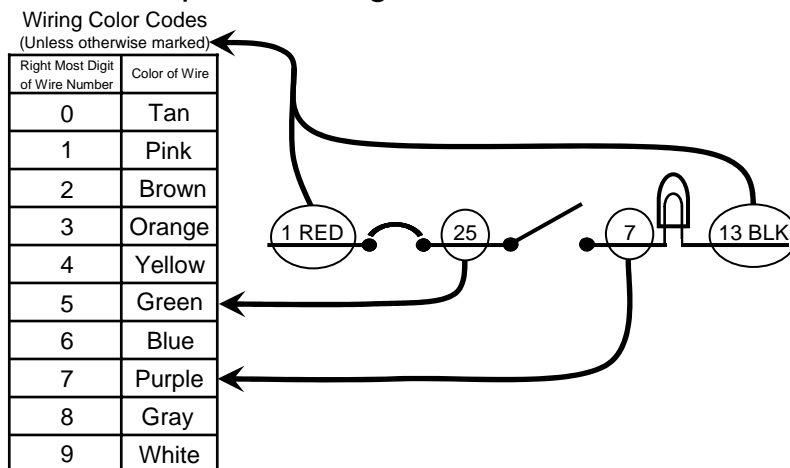

Speed Scrub – Ladder Schematic (page 2 of 2)

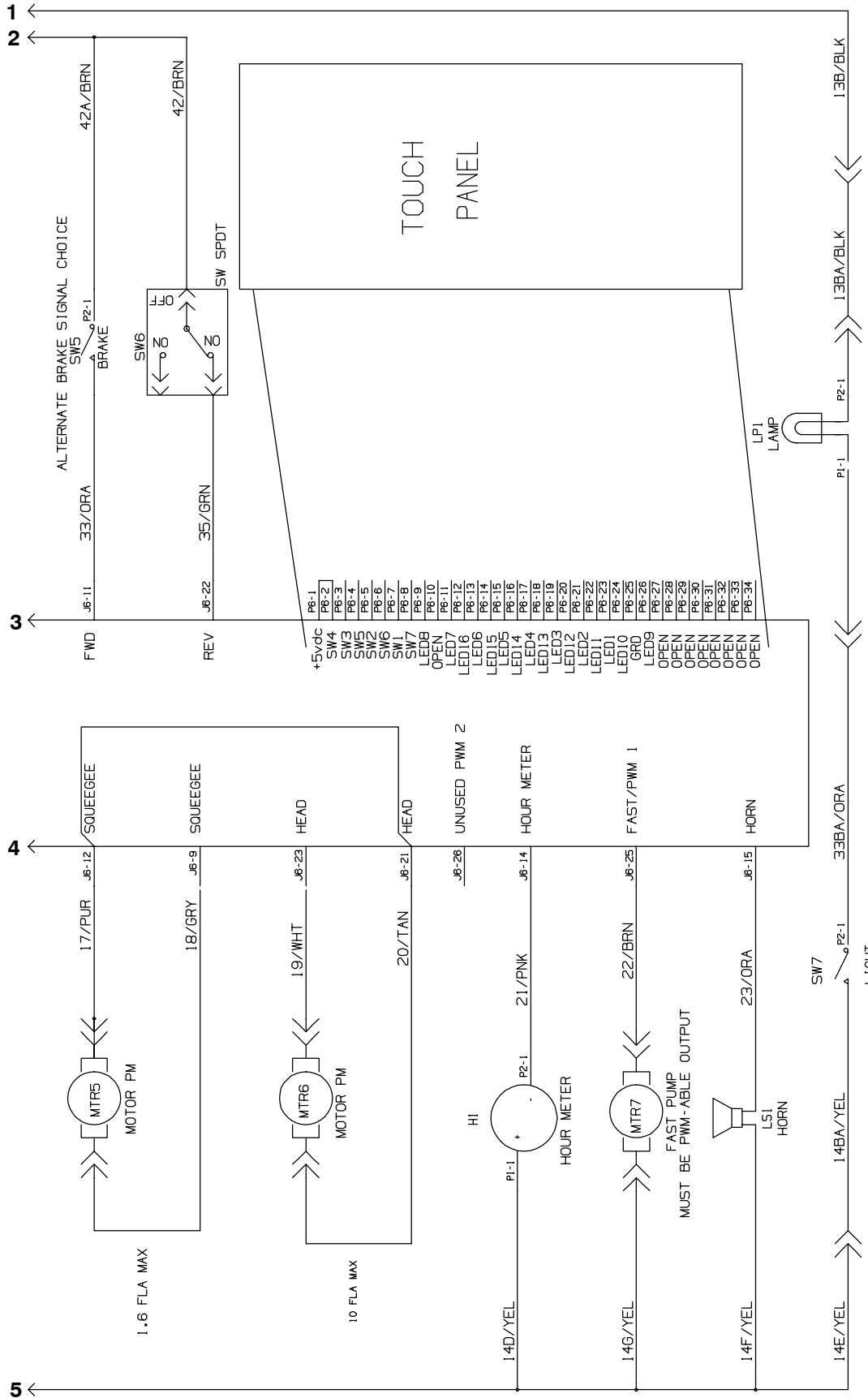

1. 1/RED and 13/BLK will remain as before.
2. All other wires will have a specific wire color based on the one's digit of the wire number as follows:

- x1=PNK(except 1/RED)
- x2=BRN
- x3=ORA(except 13/BLK)
- x4=YEL
- x5=GRN
- x6=BLU
- x7=PUR
- x8=GRY
- x9=WHT
- x10=TAN

Speed Scrub – Wire Harness Group (page 1 of 4)

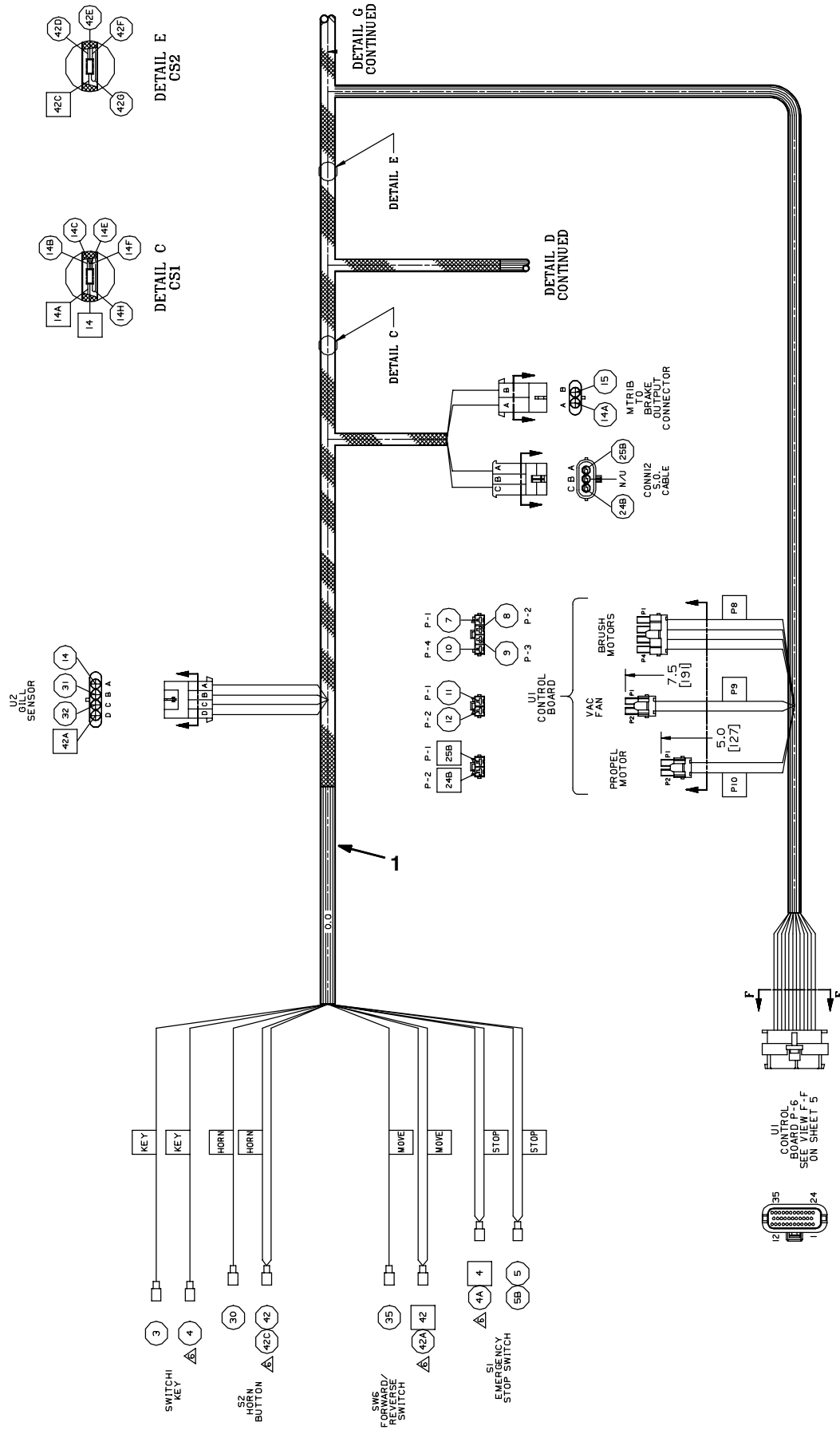

Speed Scrub – Wire Harness Group (page 2 of 4)

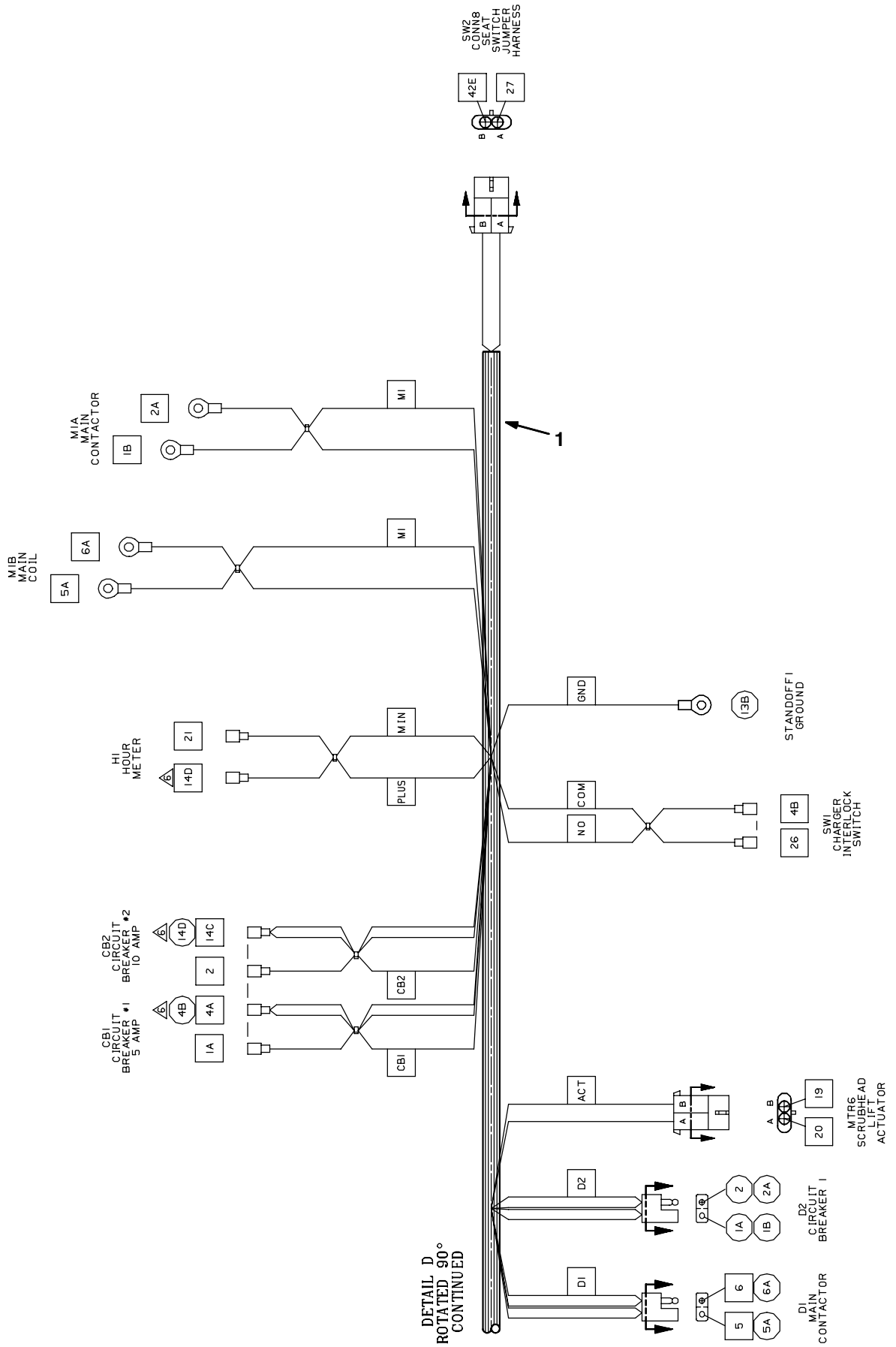

Speed Scrub – Wire Harness Group (page 3 of 4)

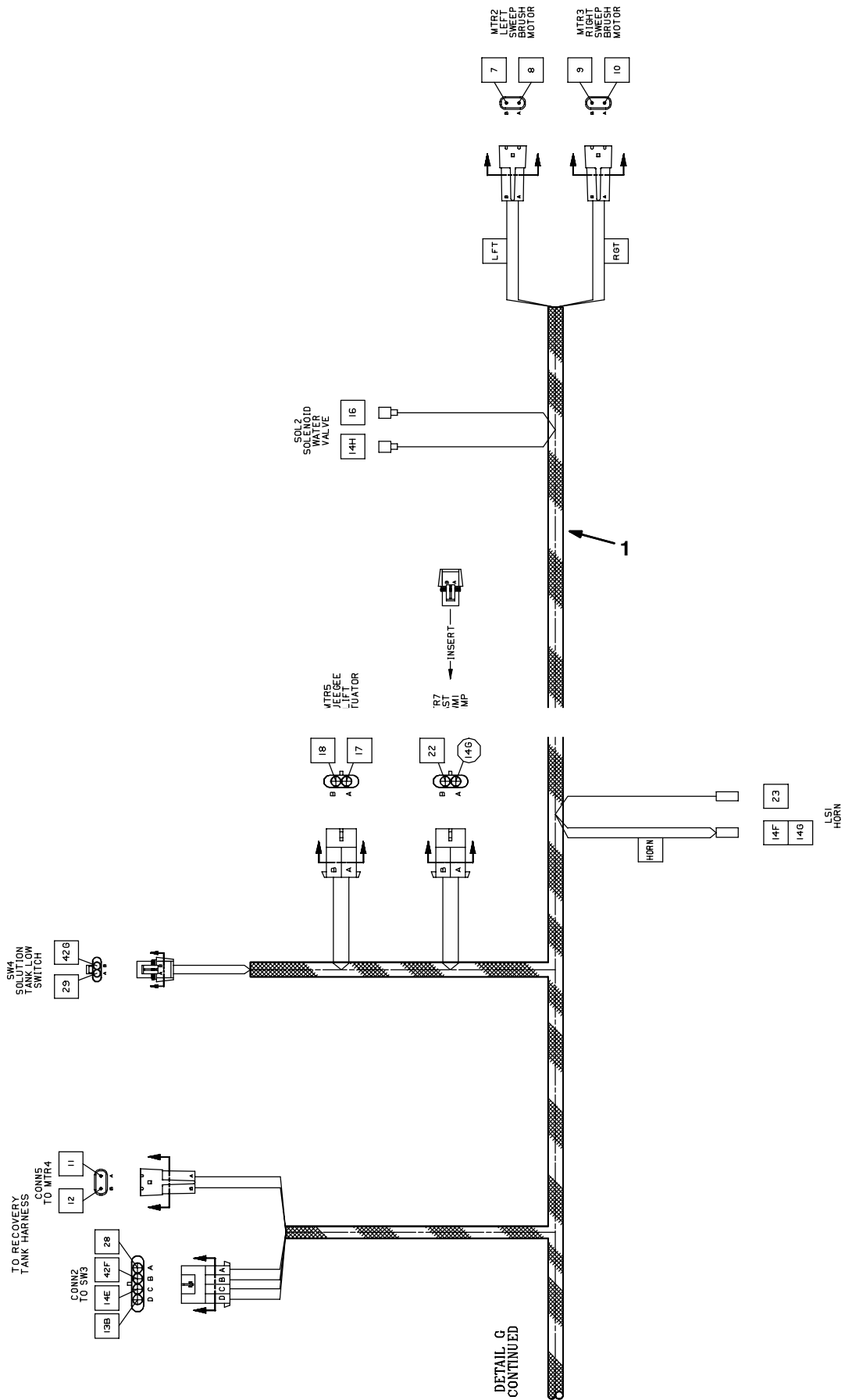

Speed Scrub – Wire Harness Group (page 4 of 4)

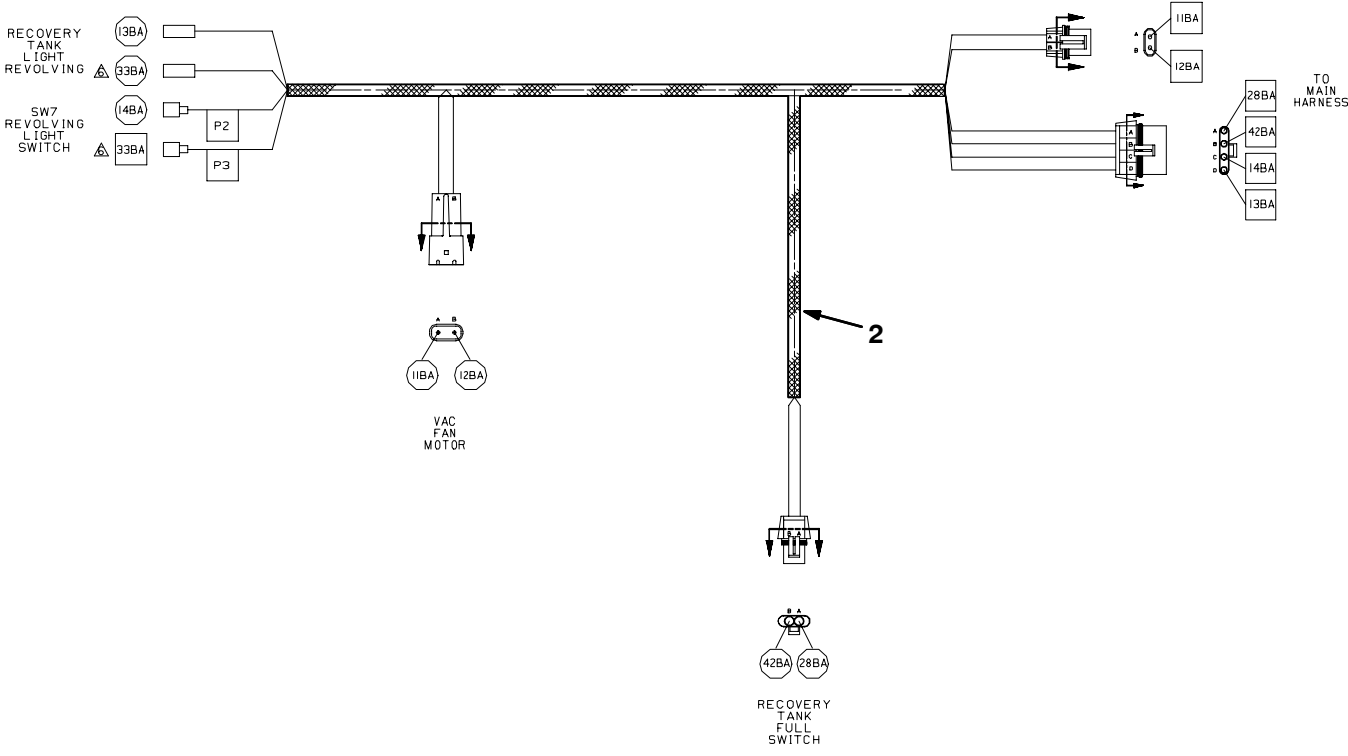

Speed Scrub - Key OFF, Battery Charger Plugged In

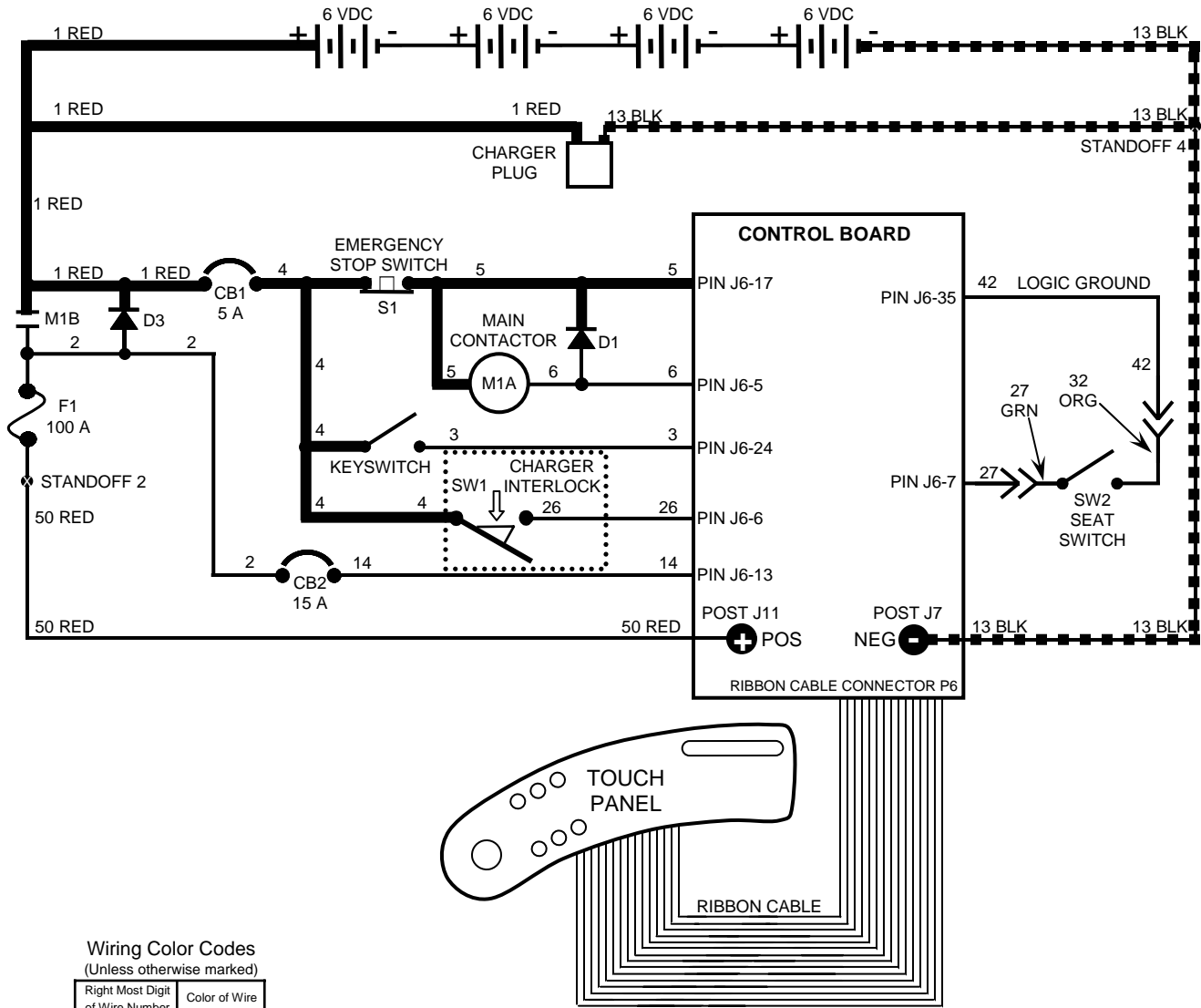

Wiring Color Codes
(Unless otherwise marked)

Right Most Digit of Wire Number	Color of Wire
0	Tan
1	Pink
2	Brown
3	Orange
4	Yellow
5	Green
6	Blue
7	Purple
8	Gray
9	White

----- = Battery Negative or Logic Ground

————— = Battery Positive or Positive Output

Speed Scrub - Key ON, Operator on Seat

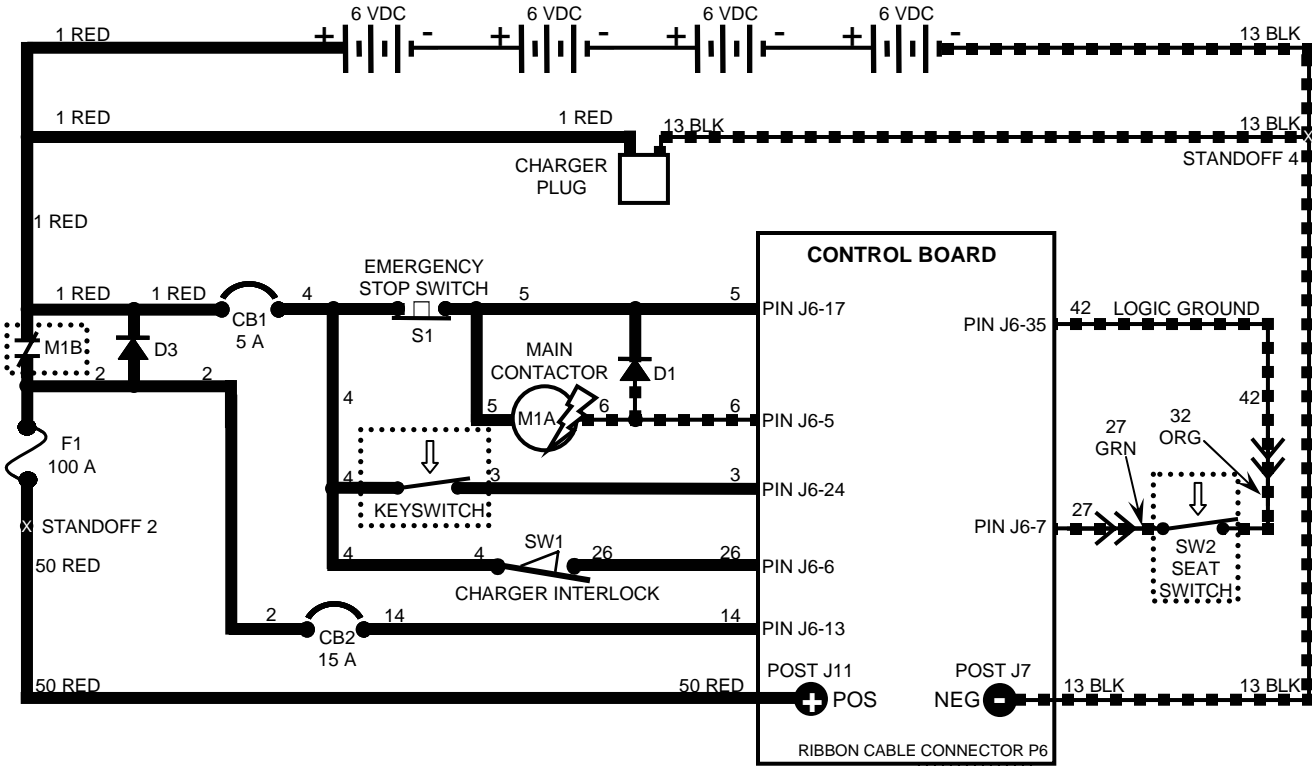

 Indicates Component is Energized

Wiring Color Codes (Unless otherwise marked)

Right Most Digit of Wire Number	Color of Wire
0	Tan
1	Pink
2	Brown
3	Orange
4	Yellow
5	Green
6	Blue
7	Purple
8	Gray
9	White

--- = Battery Negative or Logic Ground
 — = Battery Positive or Positive Output

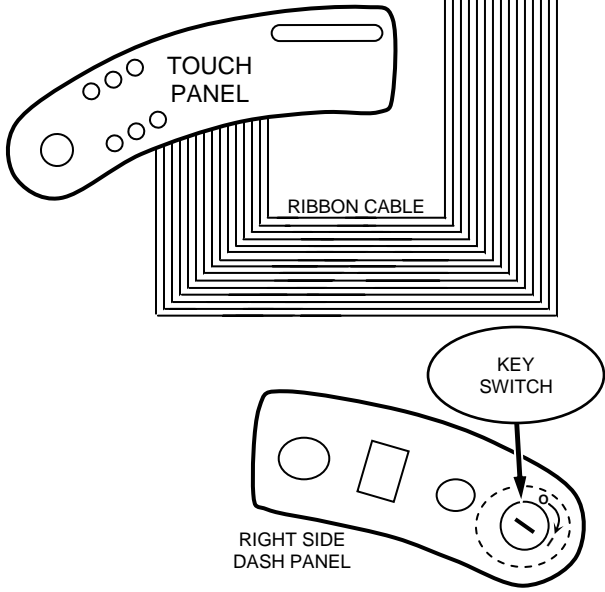

Speed Scrub – Tank Level Switches

CONDITIONS: **key ON**

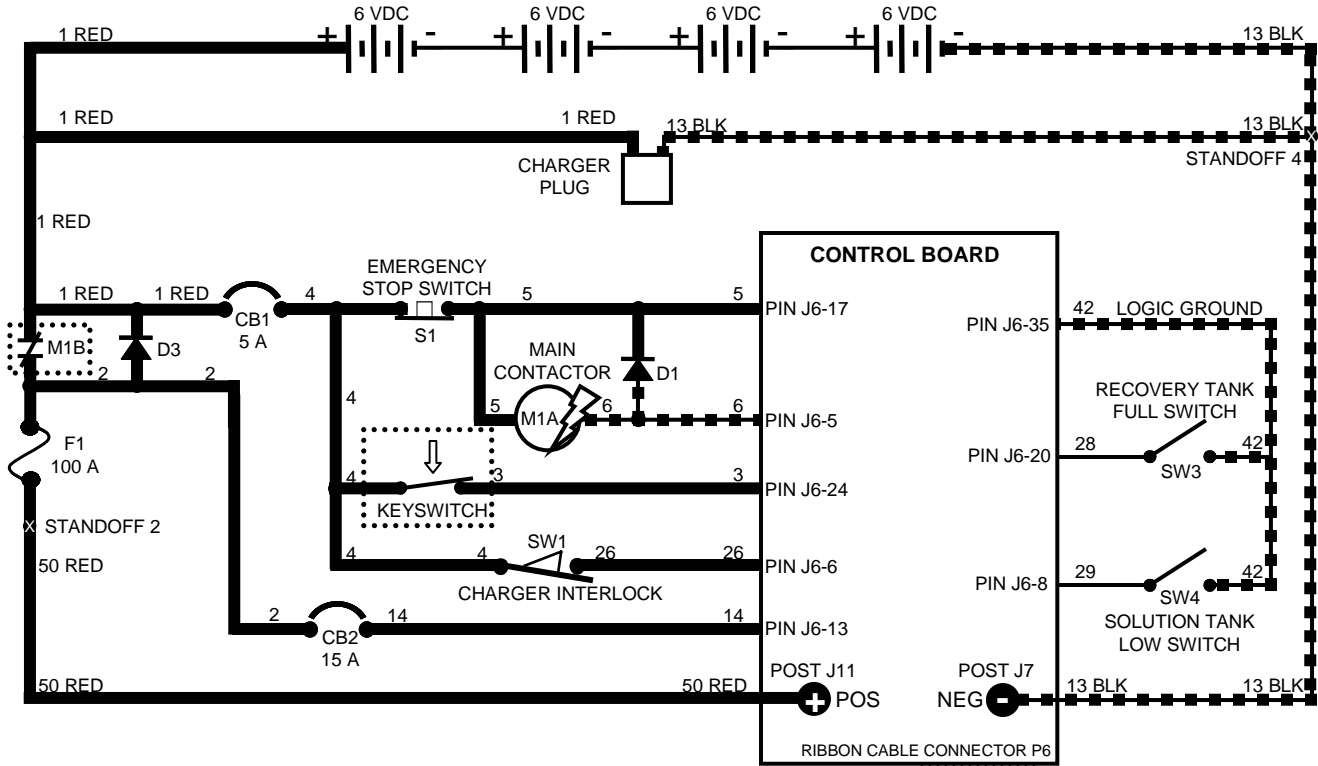

Indicates Component is Energized

Wiring Color Codes
(Unless otherwise marked)

Right Most Digit of Wire Number	Color of Wire
0	Tan
1	Pink
2	Brown
3	Orange
4	Yellow
5	Green
6	Blue
7	Purple
8	Gray
9	White

= Battery Negative or Logic Ground
 = Battery Positive or Positive Output

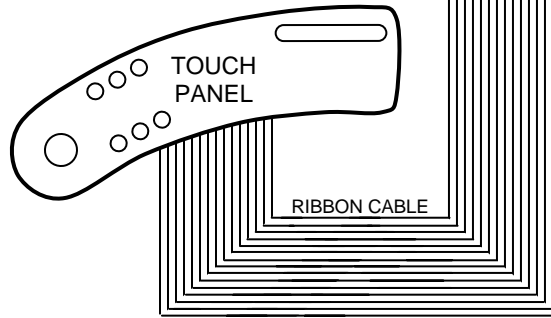

Tank Level Switches Logic Chart

switch	tank full	tank empty	switch OPEN	switch CLOSED	indicator
Solution Tank	X			X	Solution Tank Empty LED OFF
		X	X		Solution Tank Empty LED ON
Recovery Tank	X			X	Recovery Tank Full LED ON
		X	X		Recovery Tank Full LED OFF



Recovery Tank Full Switch ***closes*** when recovery tank is full

Solution Tank Low Switch ***opens*** when solution tank is low

Tank Level Switches are ALWAYS in the OPEN position with low or empty tank

Tank Level Switches are ALWAYS in the CLOSED position with full tank

Speed Scrub – Horn & Hour Meter Systems

CONDITIONS: key ON, operator on seat, in motion OR Vacuum Fan running (for Hour Meter)

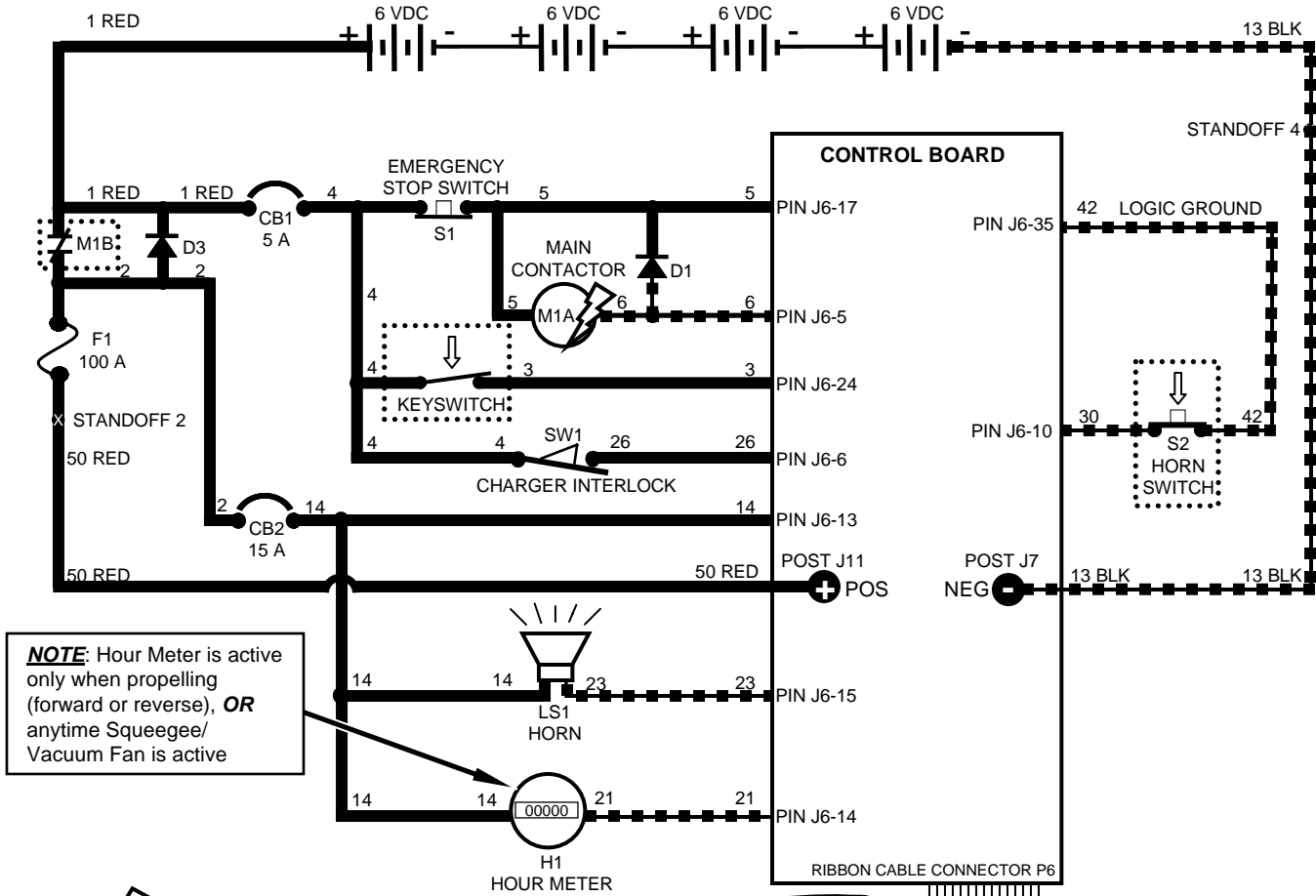

NOTE: Hour Meter is active only when propelling (forward or reverse), **OR** anytime Squeegee/Vacuum Fan is active



Indicates Component is Energized

Wiring Color Codes (Unless otherwise marked)

Right Most Digit of Wire Number	Color of Wire
0	Tan
1	Pink
2	Brown
3	Orange
4	Yellow
5	Green
6	Blue
7	Purple
8	Gray
9	White

--- = Battery Negative or Logic Ground
 — = Battery Positive or Positive Output

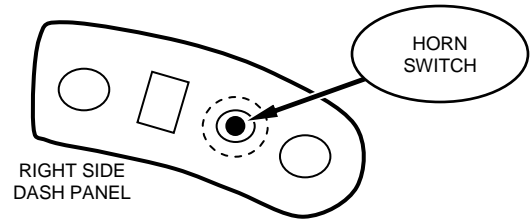
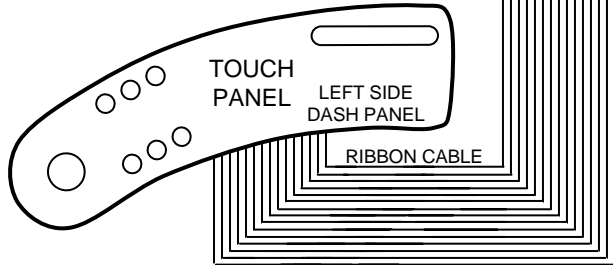

i Horn pulses ON & OFF when Directional Switch is in REVERSE
 Hour Meter is ON only when propelling (forward or reverse), or anytime Squeegee/Vacuum Fan is ON
 Horn pulses when a fault is detected (Directional Switch must be in FORWARD Position) – refer to “Diagnostic/Beep Code” chart

Speed Scrub – Propel Forward System

CONDITIONS: **key ON, operator on seat, propel pedal depressed**

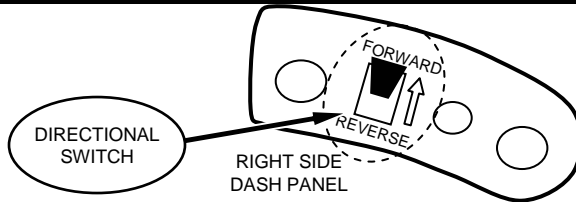
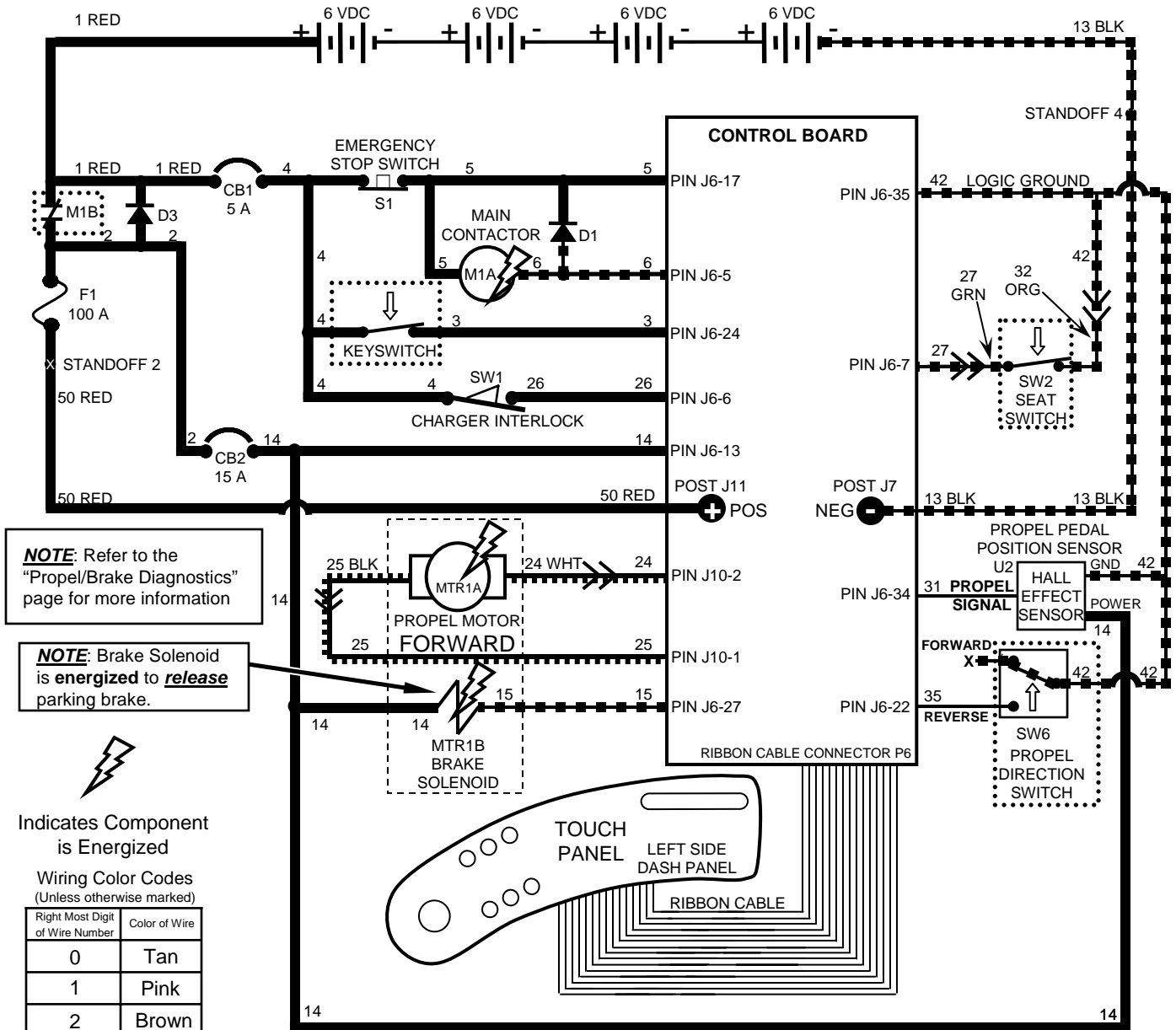

 Typical Propel Motor Current Draw: 1 to 20 Amps in motion, higher at start-up
 Propel Motor Voltage: 0 to 24 VDC - FORWARD
 Approx. 0 to 17 VDC - REVERSE
 Propel Motor is controlled by PWM (Pulse Width Modulation)
 The Propel Pedal Position HALL EFFECT Sensor sends a varying voltage signal (1 to 4 Volts) to control board, based upon position of the propel pedal

Speed Scrub – Propel Reverse System

CONDITIONS: **key ON, operator on seat, propel pedal depressed**

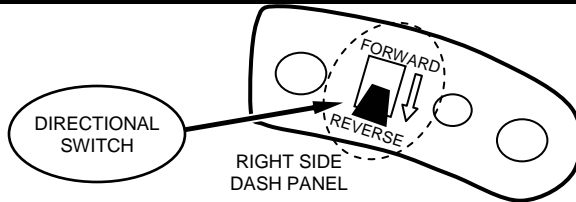
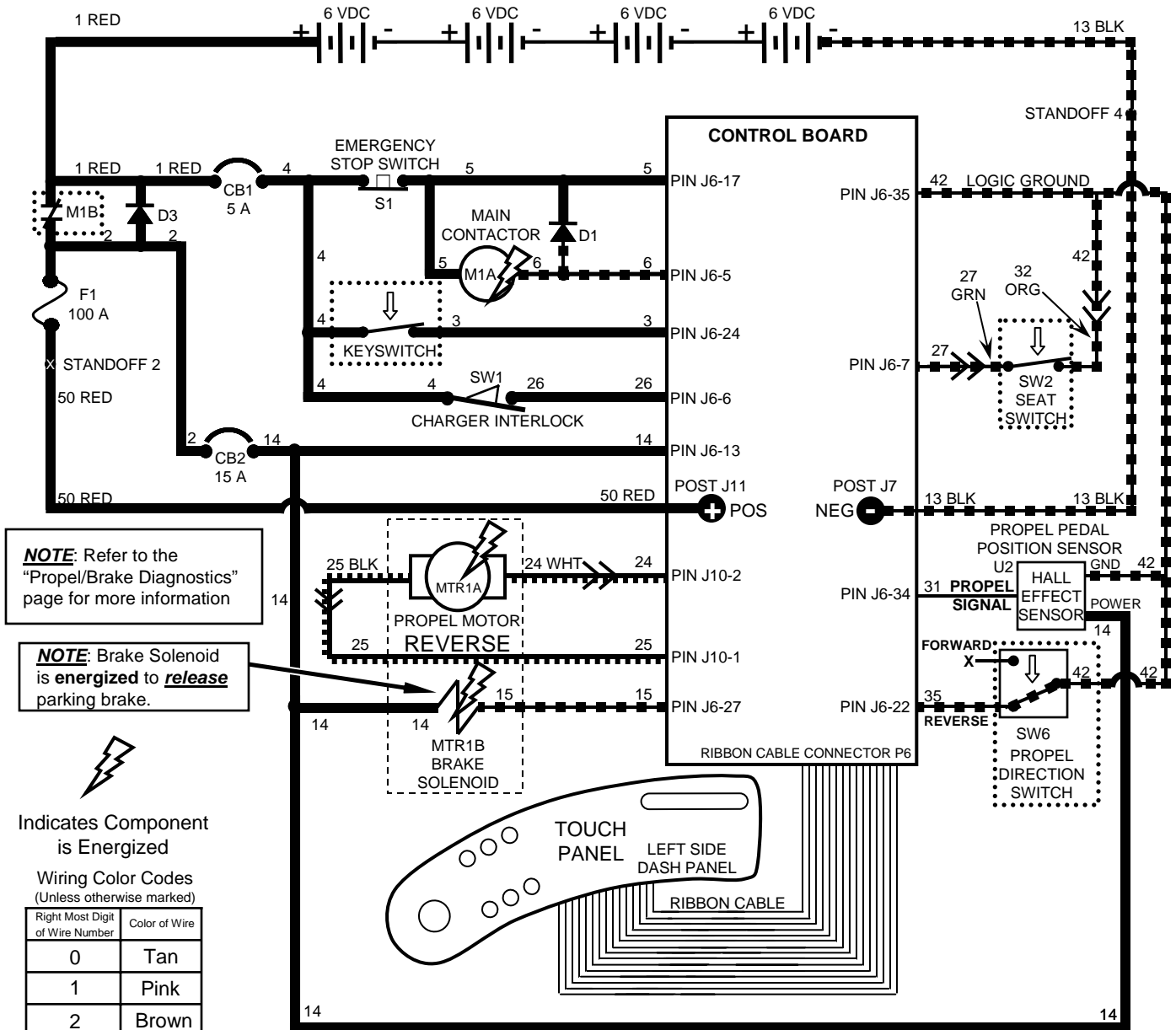

 Typical Propel Motor Current Draw: 1 to 20 Amps in motion, higher at start-up
 Propel Motor Voltage: 0 to 24 VDC - FORWARD
 Approx. 0 to 17 VDC - REVERSE
 Propel Motor is controlled by PWM (Pulse Width Modulation)
 The Propel Pedal Position HALL EFFECT Sensor sends a varying voltage signal (1 to 4 Volts) to control board, based upon position of the propel pedal

Speed Scrub – Braking System

CONDITIONS: key ON, operator on seat, brake pedal depressed

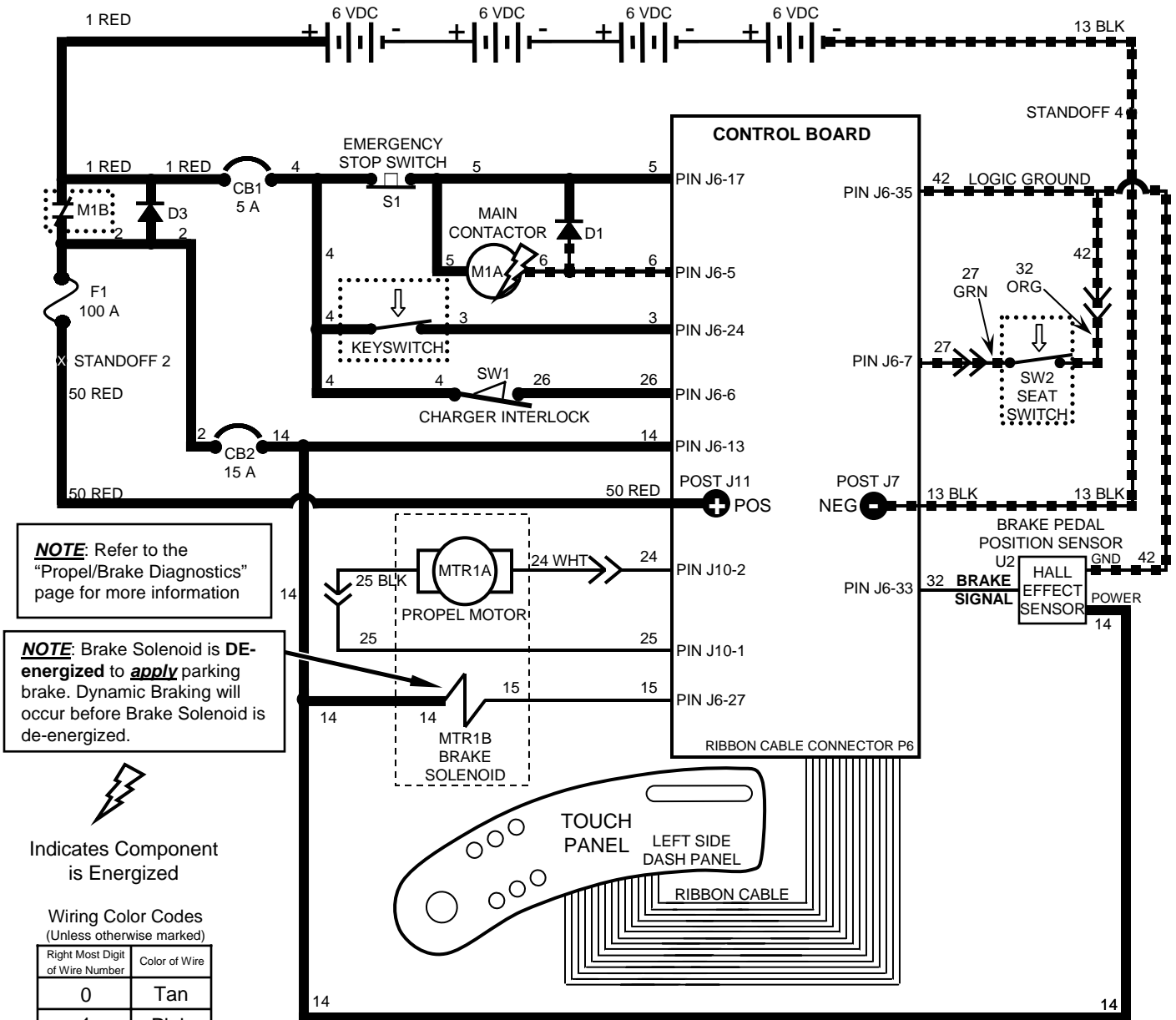

NOTE: Refer to the "Propel/Brake Diagnostics" page for more information

NOTE: Brake Solenoid is **DE-energized** to **apply** parking brake. Dynamic Braking will occur before Brake Solenoid is de-energized.



Indicates Component is Energized

Wiring Color Codes
(Unless otherwise marked)

Right Most Digit of Wire Number	Color of Wire
0	Tan
1	Pink
2	Brown
3	Orange
4	Yellow
5	Green
6	Blue
7	Purple
8	Gray
9	White

--- = Battery Negative or Logic Ground
 — = Battery Positive or Positive Output

i The brake pedal position HALL EFFECT sensor sends a varying voltage signal (1 to 4 Volts) to control board, based upon position of the brake pedal
 Brake Solenoid is **DE-energized** to **apply** brake.
 Dynamic Braking will occur before Brake Solenoid is de-energized.

Speed Scrub – Scrub Head & Squeegee Actuator Systems

(page 1 of 2)

CONDITIONS: key ON, operator on seat, forward travel, propel pedal depressed, One Step Scrub Button pressed

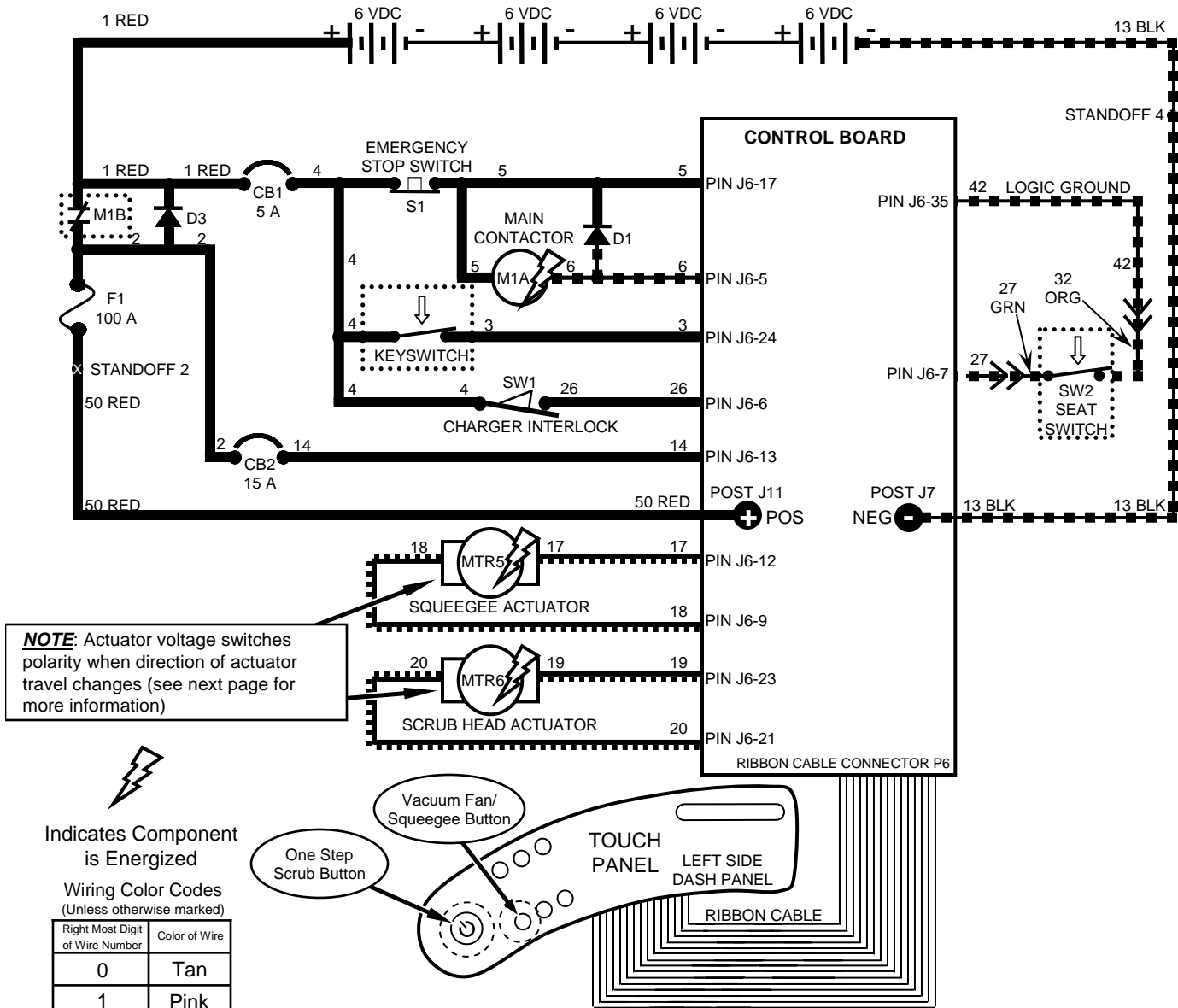

NOTE: Actuator voltage switches polarity when direction of actuator travel changes (see next page for more information)

Indicates Component is Energized

Wiring Color Codes (Unless otherwise marked)

Right Most Digit of Wire Number	Color of Wire
0	Tan
1	Pink
2	Brown
3	Orange
4	Yellow
5	Green
6	Blue
7	Purple
8	Gray
9	White

- = Battery Negative or Logic Ground
- = Battery Positive or Positive Output
- = Output that can Change Polarity

i Pressing the "One Step Scrub Button" will lower the squeegee and scrub head

Only one actuator will be energized at any given time – squeegee is lowered first, then the scrub head

Squeegee actuator uses internal limit switches to stop travel in upward and downward travel

Scrub head actuator travel is controlled by monitoring actuator current in upward travel and brush motor current in downward travel

Squeegee actuator can also be operated by pressing the "Vacuum Fan/Squeegee Button", without operating scrub brushes

Speed Scrub – Scrub Head & Squeegee Actuator Systems

(page 2 of 2)

Actuator Voltage Data

Actuator	Travel Direction	Wire #	Color	Polarity	Notes
Squeegee	DOWN	17	Purple	-	Voltage at actuator connector will be approx. 24 VDC for 2 seconds, then approx. 12 VDC for 2 seconds for both UP & DOWN travel
		18	Gray	+	
	UP	17	Purple	+	
		18	Gray	-	
Scrub Head	DOWN	19	White	-	Voltage at actuator connector will be approx. 24 VDC for 4 seconds
		20	Tan	+	
	UP	19	White	+	Voltage at actuator connector will be approx. 24 VDC for 4 seconds, then approx. 11 to 12 VDC for 2 to 4 seconds
		20	Tan	-	



Pressing the “One Step Scrub Button” will lower the squeegee and scrub head

Only one actuator will be energized at any given time – squeegee is lowered first, then the scrub head

Squeegee actuator uses internal limit switches to stop travel in upward and downward travel

Scrub head actuator travel is controlled by monitoring actuator current in upward travel and brush motor current in downward travel

Squeegee actuator can also be operated by pressing the “Vacuum Fan/ Squeegee Button”, without operating scrub brushes

Speed Scrub – Scrub Brush Motors System

CONDITIONS: **key ON, operator on seat, forward travel, propel pedal depressed, One Step Scrub Button pressed**

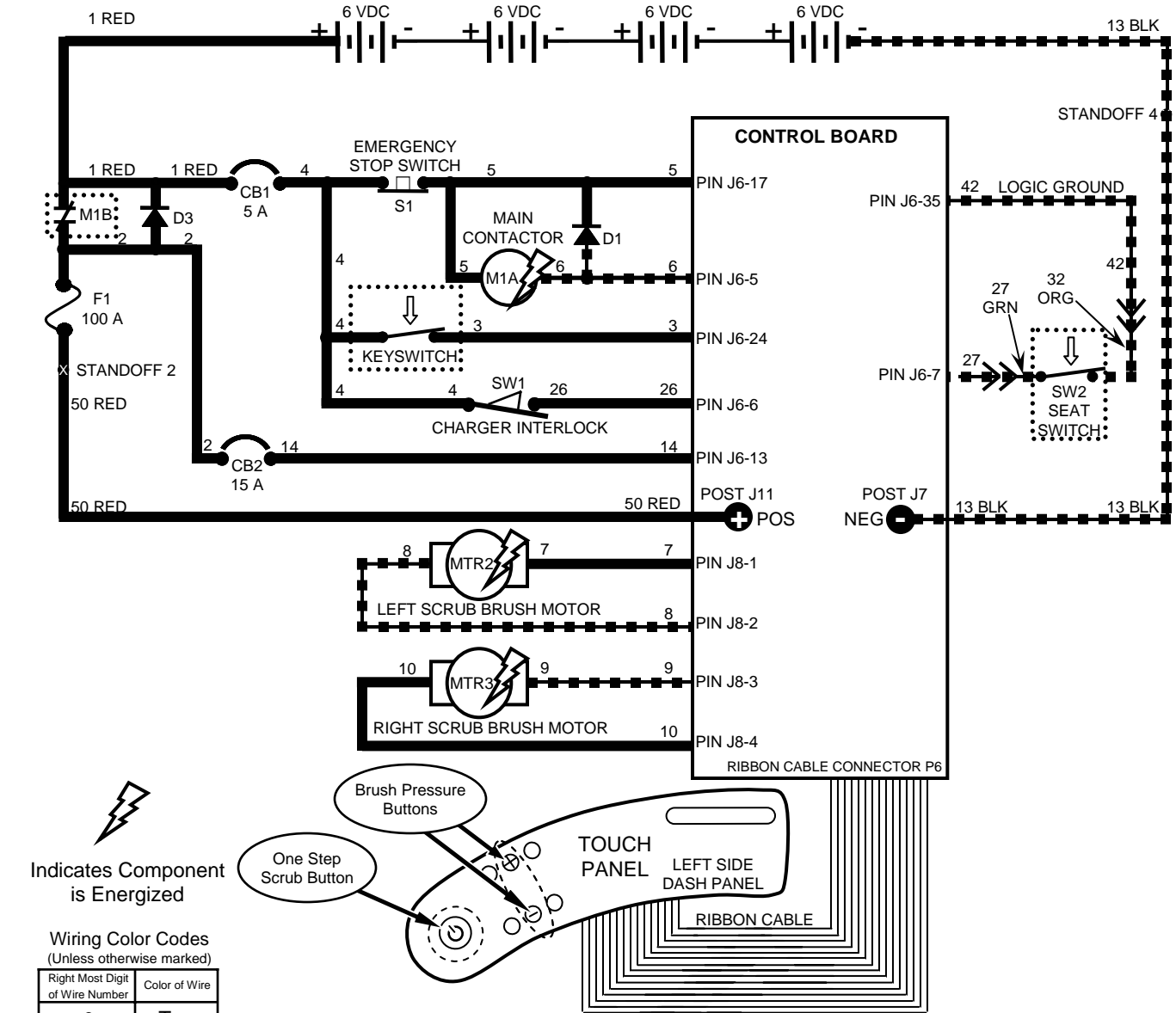

Indicates Component is Energized

Wiring Color Codes
(Unless otherwise marked)

Right Most Digit of Wire Number	Color of Wire
0	Tan
1	Pink
2	Brown
3	Orange
4	Yellow
5	Green
6	Blue
7	Purple
8	Gray
9	White

= Battery Negative or Logic Ground
 = Battery Positive or Positive Output

Brush Motor Current Draw: Approx. 10 to 20 Amps per motor, varying upon selected brush pressure setting

Brush Motor Voltage: Approx. 18 VDC in Economy Mode
Approx. 21.5 VDC in All Other Modes

Scrub Brush Motors are controlled by PWM (Pulse Width Modulation)

Pressing the “One Step Scrub Button” will turn on the Scrub Brush Motors (after lowering squeegee and scrub head)

Scrub Brush Motors will function only when propelling either forward or reverse

Scrub Brush Pressure is controlled by monitoring brush motor current

Speed Scrub – Vacuum Fan System

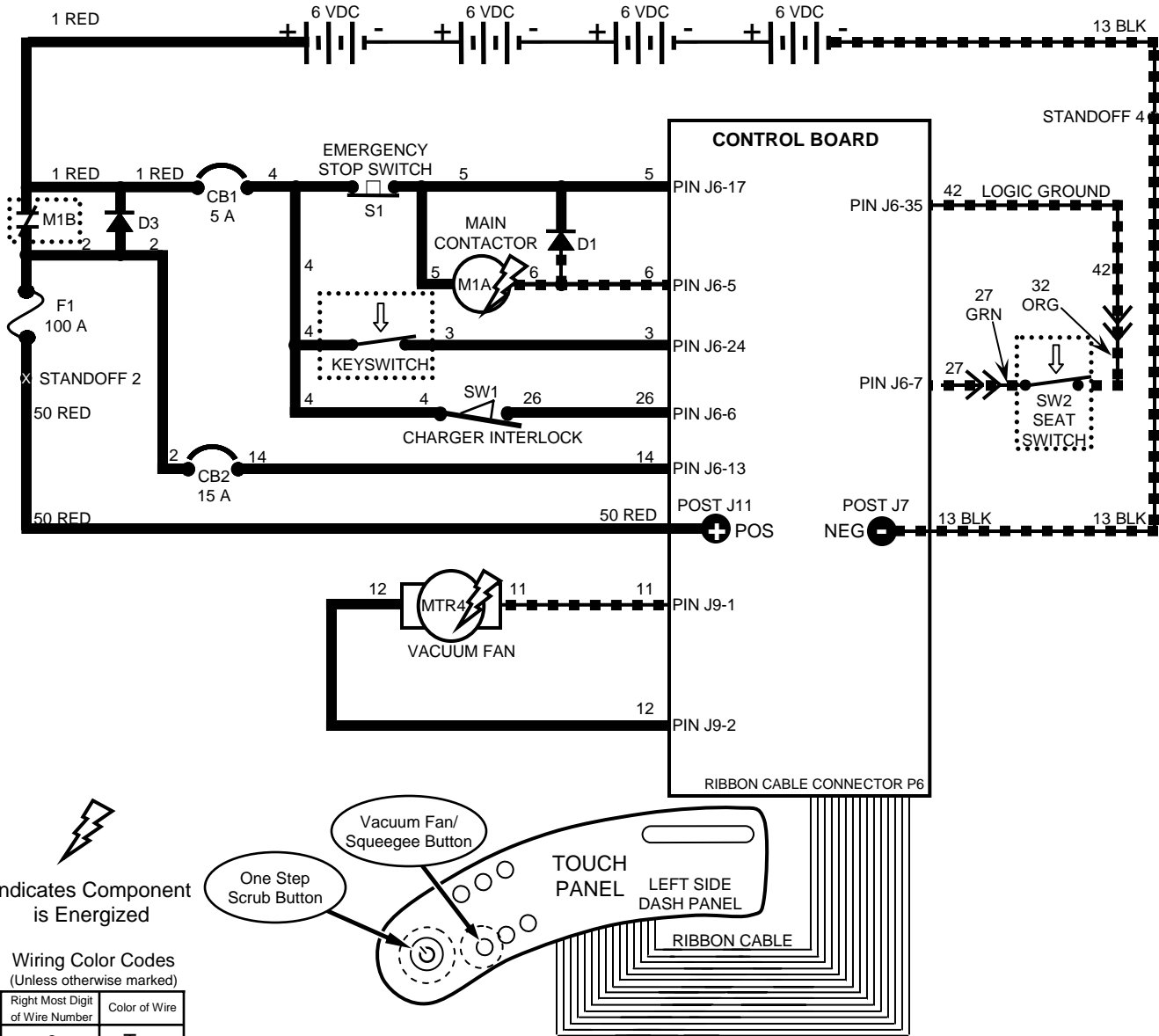

CONDITIONS: key ON, operator on seat, forward travel, One Step Scrub Button pressed





 Indicates Component is Energized

Wiring Color Codes
(Unless otherwise marked)

Right Most Digit of Wire Number	Color of Wire
0	Tan
1	Pink
2	Brown
3	Orange
4	Yellow
5	Green
6	Blue
7	Purple
8	Gray
9	White

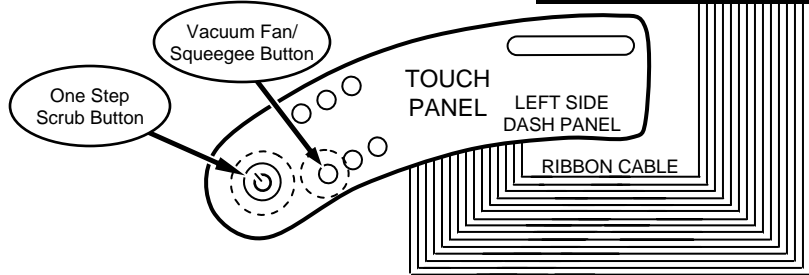
 = Battery Negative or Logic Ground
 = Battery Positive or Positive Output



 Vacuum Fan Motor Current Draw: Approx. 18 to 21 Amps
 Vacuum Fan Motor Voltage: Approx. 18 VDC in Economy Mode
 Approx. 21.5 VDC in All Other Modes
 Vacuum Fan Motor is controlled by PWM (Pulse Width Modulation)
 Pressing the "One Step Scrub Button" will activate Vacuum Fan
 Vacuum Fan can also be operated by pressing the "Vacuum Fan/Squeegee Button", without operating scrub brushes

Speed Scrub – FaST System

CONDITIONS: **key ON**, operator on seat, forward travel, propel pedal depressed, **One Step Scrub Button** pressed

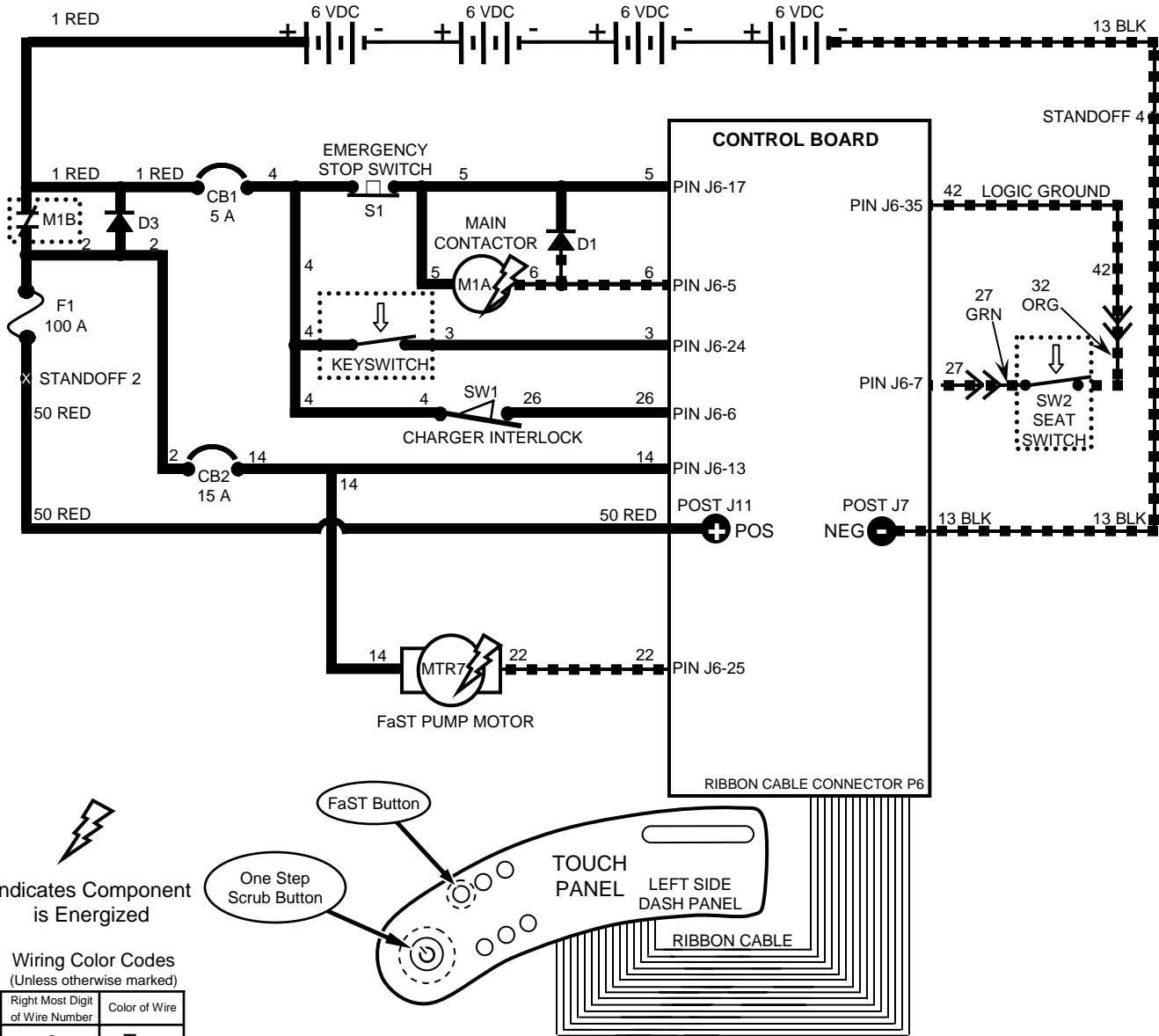

Indicates Component is Energized

Wiring Color Codes
(Unless otherwise marked)

Right Most Digit of Wire Number	Color of Wire
0	Tan
1	Pink
2	Brown
3	Orange
4	Yellow
5	Green
6	Blue
7	Purple
8	Gray
9	White

= Battery Negative or Logic Ground
 = Battery Positive or Positive Output

Pressing the “One Step Scrub Button” will activate FaST Pump Motor **OR** Solution Solenoid Valve as Scrub Brush Motors engage
 Pressing the FaST button will toggle from FaST scrubbing to Conventional scrubbing
 FaST system will operate **ONLY** if FaST LED is ON
 Solution Volume Control Buttons will **NOT** operate & Solution Volume Control LED’s will be **OFF** during FaST scrubbing

Speed Scrub – Conventional Solution System

CONDITIONS: key ON, operator on seat, forward travel, propel pedal depressed, One Step Scrub Button pressed

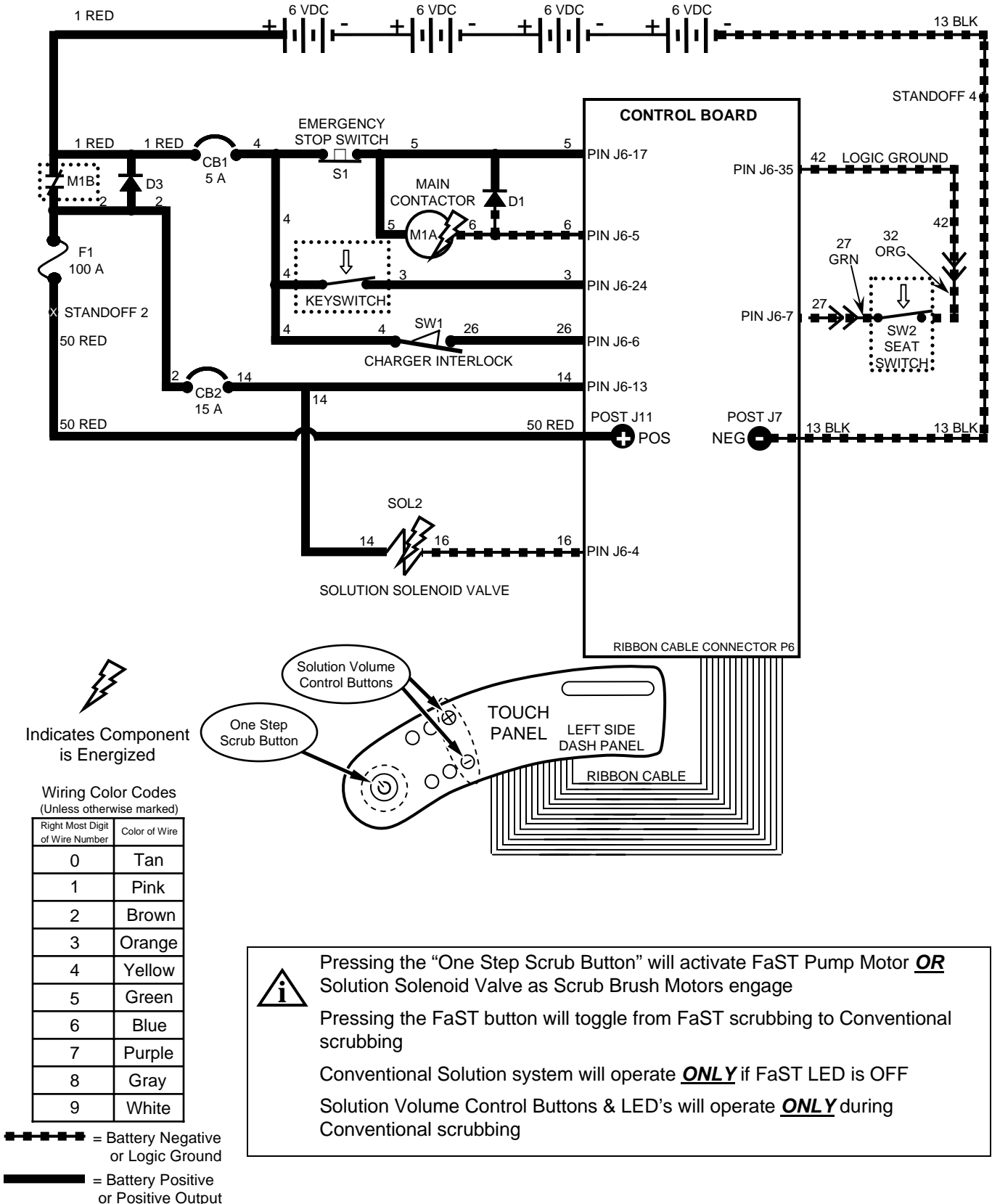

Speed Scrub – LED Locations & Descriptions

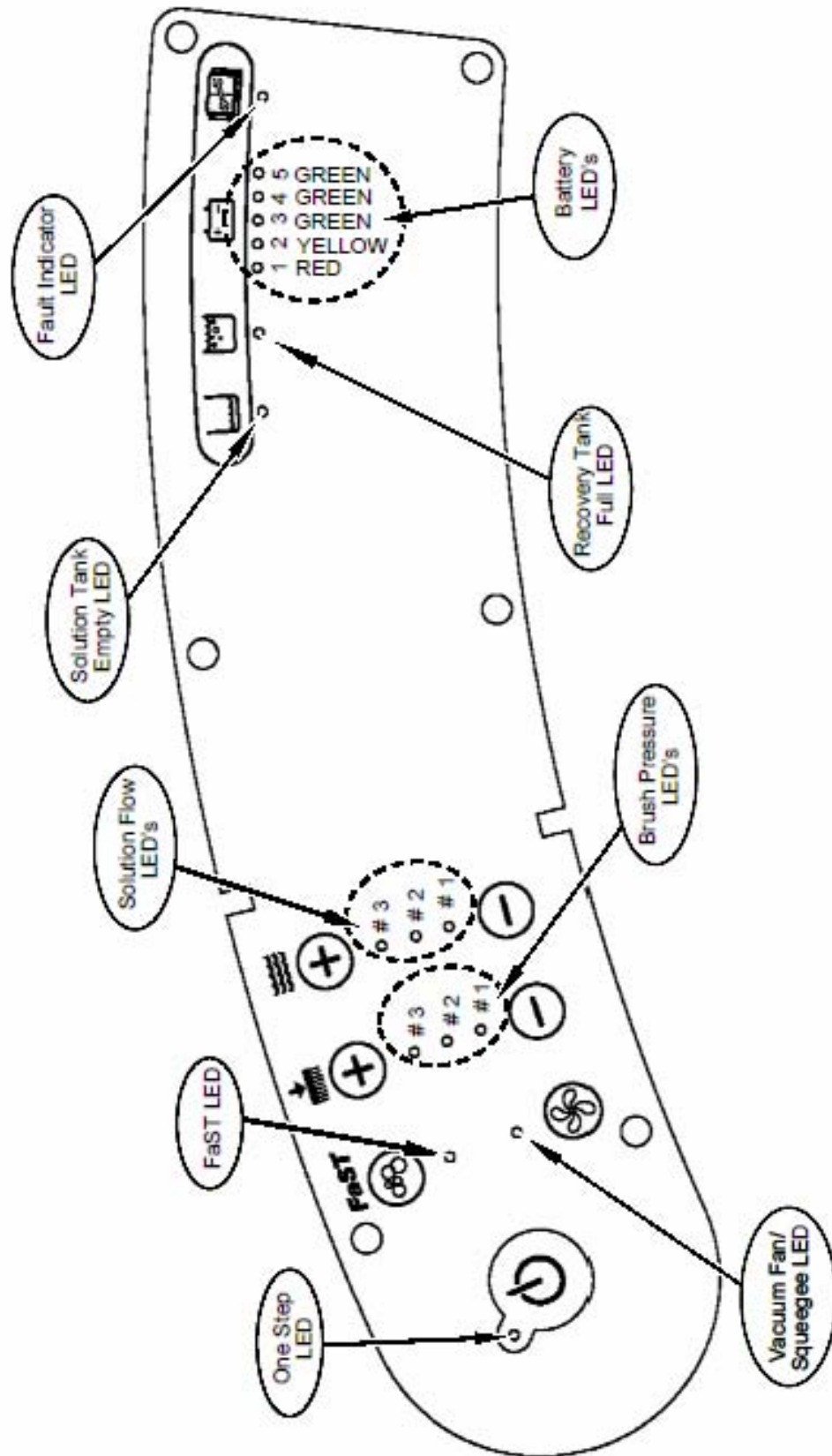

Speed Scrub – Operational Modes & Interlocks

Mode	Entry Sequence	Indicator	Function
Forward	-Directional Switch Forward -Propel Pedal Depressed	-Directional Switch in Forward position	Forward movement of machine
Reverse	-Directional Switch Reverse -Propel Pedal Depressed	-Directional Switch in Reverse position -Horn Sounding continuously ON & OFF (except in "Hospital" mode)	Reverse movement of machine
Scrub Mode	-Press One Step Scrub Button (ON)	-One Step Scrub LED ON	Activate Scrub Brush, Squeegee, Vacuum Fan & Solution Flow operations
FaST Mode	-Press One Step Scrub Button (ON) -Press FaST Button (ON)	-One Step Scrub & FaST LED's ON -Solution Flow LED's OFF	Activate FaST foam solution flow when scrub and propel are engaged
Conventional Solution Mode	-Press One Step Scrub Button (ON) -Press FaST Button (OFF)	-One Step Scrub & Solution Flow LED(s) ON -FaST LED OFF	Activate Conventional solution flow when scrub and propel are engaged
Double Scrub (no water pickup)	-Press One Step Scrub Button (ON) -Press Vacuum Fan/Squeegee Button (OFF)	-One Step Scrub LED ON -Vacuum Fan/Squeegee LED OFF	Apply cleaning solution with no water pickup
Water pickup (no Scrub)	-Press Vacuum Fan/Squeegee Button (ON)	-One Step Scrub LED OFF -Vacuum Fan/Squeegee LED ON	Collect solution on floor with squeegee, without scrubbing floor
Low Power Mode	-Press Brush Pressure Decrease (-) to one LED -Press Solution Flow Decrease (-) to one LED	-Lower Brush Pressure (#1) LED ON; Middle (#2) & Upper (#3) LED's OFF -Lower Solution Flow (#1) LED ON; Middle (#2) & Upper (#3) LED's OFF	Reduce Scrub Brush and Fan speeds (to prolong battery life, reduce noise, lower water usage)
Low Power Mode w/ FaST	-Press Brush Pressure Decrease (-) to one LED -Press FaST Button (ON)	-Lower Brush Pressure (#1) LED ON; Middle (#2) & Upper (#3) LED's OFF -FaST LED ON (Solution Flow LED's OFF)	Reduce Scrub Brush and Fan speeds (to prolong battery life, reduce noise, lower water usage)
Solution Tank Empty	-Solution Tank Empty (Float Switch Open)	-Solution Tank Empty LED ON	Disable Scrub function (Operator can get an additional minute of operation by re-engaging scrub system with One Step button)
Recovery Tank Full	-Recovery Tank Full (Float Switch Closed)	-Recovery Tank Full LED ON	Disable Scrub function (Operator can get an additional minute of operation by re-engaging scrub system with One Step button)
Battery Discharged	-Battery voltage at or below full discharge voltage	-Red LED (on Battery Gauge) blinking	Disable Scrub function (Operator can get an additional minute of operation by re-engaging scrub system with One Step button)
Accessory Motor High Current Fault	-Controller sensed an Over Current condition in the Scrub Brush Motors or Vacuum Fan Motor	-Fault LED ON and any one or more of the following: Lower Brush Pressure (#1) LED ON (Right Motor) Upper Brush Pressure (#3) LED ON (Left Motor) Upper Solution Flow (#3) LED ON (Vacuum Fan)	Prevent damage to Scrub Brush Motors or Vacuum Fan Motor – Scrub function shuts off

Speed Scrub – Diagnostic & Fault Alarms

Alarm Codes

Mode	Directional Switch	Entry Sequence	Alarm Sequence	Function
Back-Up Alarm	REVERSE	Directional switch placed in REVERSE	Horn sounds 1 beep cycle (repeats)	Alerts nearby persons of machine backward movement (Note: Back-up alarm will not sound when machine is placed in "Hospital" mode)
Propel Interlock: Seat Switch Released	FORWARD	Propel Pedal depressed with operator NOT on seat	Horn sounds 2 beep cycle (repeats)	Prevents movement of machine when operator not in place
Propel Interlock: High Pedal Disable	FORWARD	Key switch turned ON with Propel Pedal engaged	Horn sounds 4 beep cycle (repeats)	Prevents movement of machine when key switched ON while throttle depressed
Propel Interlock: Throttle Fault	FORWARD	Controller sensed an out-of range Throttle signal	Horn sounds 5 beep cycle (repeats) (Also FAULT and FaST LED's blink)	Prevents movement of machine with invalid throttle voltage. Scrub function shuts off.
Propel Interlock: Parking Brake Fault	FORWARD	Controller sensed an out-of range Brake signal	Horn sounds 6 beep cycle (repeats) (Also FAULT and Vacuum Fan/Squeegee LED's blink)	Prevents movement of machine with invalid brake voltage. Scrub function shuts off.
Propel Interlock: Parking Brake Unplugged	FORWARD	Controller sensed open circuit on parking brake	Horn sounds 7 beep cycle (repeats) (Also FAULT and Lower Solution Flow LED's blink)	Prevents movement of machine with ineffective parking brake. Scrub function shuts off.
Propel Interlock: E-STOP Switch Activated	FORWARD	Controller sensed open circuit on Emergency Stop Switch circuit	Horn sounds 8 beep cycle (repeats) (When in Input Display Mode, FAULT LED will also blink)	Disables all functions (Note: To reset, key switch must be cycled OFF and ON after the E-STOP switch has closed)
Propel Interlock: Charger Plugged In	FORWARD	Battery charger plugged into machine with Key Switch ON	Horn sounds 9 beep cycle (repeats)	Prevents movement of the machine with charger plugged in

High Current Faults

Fault	Entry Sequence	Indicator
Excessive Propel Motor Current	Propel Motor Current Higher than 40 Amps for 15 min. <u>OR</u> Higher than 55 Amps for 6 min. <u>OR</u> Higher than 68 Amps for 4 min.	Blinking FAULT LED, Propel disabled
Excessive Left Brush Motor Current	Left brush motor current higher than 30 Amps	Blinking FAULT LED, Blinking Brush Pressure LED #3
Excessive Right Brush Motor Current	Right brush motor current higher than 30 Amps	Blinking FAULT LED, Blinking Brush Pressure LED #1
Excessive Vacuum Fan Motor Current	Vacuum Fan Motor current higher than 27 Amps	Blinking FAULT LED, Blinking Vacuum Fan/Squeegee LED

Speed Scrub – Diagnostic & Configuration Modes

Mode	Entry Sequence	Indicator	Function
Display Software Revision Mode	Press and hold One Step Button, turn key switch ON, wait 10 seconds, release One Step Button	Upper Brush Pressure LED blinks Tens of days of month, Upper Solution Flow LED blinks Single day of month Middle Brush Pressure LED blinks Tens of month, Middle Solution Flow LED blinks Single month Lower Brush Pressure LED blinks Tens of year, Lower Solution Flow LED blinks out Single year	Blinking Brush Pressure and Solution Flow LED's indicate revision date
Self Test Mode	Press and hold FaST and Vacuum Fan/Squeegee Buttons, turn key switch ON, wait 10 seconds, release buttons	Start of test - Left Scrub Brush turns ON End of test - Horn sounds	Solid lit One Step LED indicates OK, A Flashing LED indicates an OPEN Fault, A Solid lit LED (other than One Step) indicates a SHORT Fault
Input Display Mode	Press and hold Decrease Solution Flow (-) Button, turn key switch ON, release button after fourth battery LED starts to blink	Fourth battery LED blinks	Shows state of control board inputs from various switches and sensors
Manual Mode	Press and hold Decrease Brush Pressure (-) Button, turn key switch ON, release after Lowest Brush Pressure LED starts to blink.	Lowest down pressure LED will blink	Allows operation of individual functions without the safety interlocks affecting or controlling them
Propel/Brake Diagnostic Mode	Press and hold FaST and Increase Brush Pressure (+) Buttons, turn key switch ON, release after battery LED's are OFF	FaST LED ON if in Forward OR Vacuum Fan/Squeegee LED ON if in Reverse - Solution Flow LED's display position of Propel Pedal, Brush Pressure LED's display position of Brake Pedal, Battery LED's display Propel Motor current level	Provides information regarding brake pedal signal, propel pedal signal, and propel motor current
Battery Select Mode	Press and hold the Increase Solution Flow (+) Button, turn key switch ON, release after one Battery LED starts to blink	Any one of lower 4 battery LED's blinks	Allows selection of battery type. See "Battery Select Mode Settings" table.
Reverse Alarm Select Mode	Put directional switch in Reverse, press & hold Horn Button, turn key switch ON	Horn sounds or is silent	Allows enable/disable of Backup alarm (Hospital Mode)
Propel Speed Selection Mode	Press and hold FaST Button, turn key switch ON, release after selecting desired Brush Pressure LED setting	Brush Pressure Lower, Middle, and Upper LED's represents LOW, MEDIUM and HIGH maximum Forward Propel Speed selection	Allows selection of maximum forward speed during scrubbing LOWER (#1) LED = 2.0 mph / 3.2 kph MIDDLE (#2) LED = 2.7 mph / 4.3 kph UPPER (#3) LED = 3.5 mph / 5.5 kph

Speed Scrub – Display Software Revision Mode

TO ENTER:

- Press and hold One Step Button
- Turn key switch ON, wait 10 seconds
- Release One Step Button

READING THE SOFTWARE REVISION:

- Upper Brush Pressure LED blinks TENS of DAYS of MONTH, Upper Solution Flow LED blinks SINGLE DAY of MONTH
- Middle Brush Pressure LED blinks TENS of MONTH, Middle Solution Flow LED blinks SINGLE MONTH
- Lower Brush Pressure LED blinks TENS of YEAR, Lower Solution Flow LED blinks SINGLE YEAR

Example	Brush Pressure LED's	# of Blinks	Solution Flow LED's	# of Blinks	Revision Date
Day	# 3 (Upper)	2	# 3 (Upper)	6	26th
Month	# 2 (Middle)	1	# 2 (Middle)	1	November
Year	# 1 (Lower)	0 (LED OFF)	# 1 (Lower)	4	2004

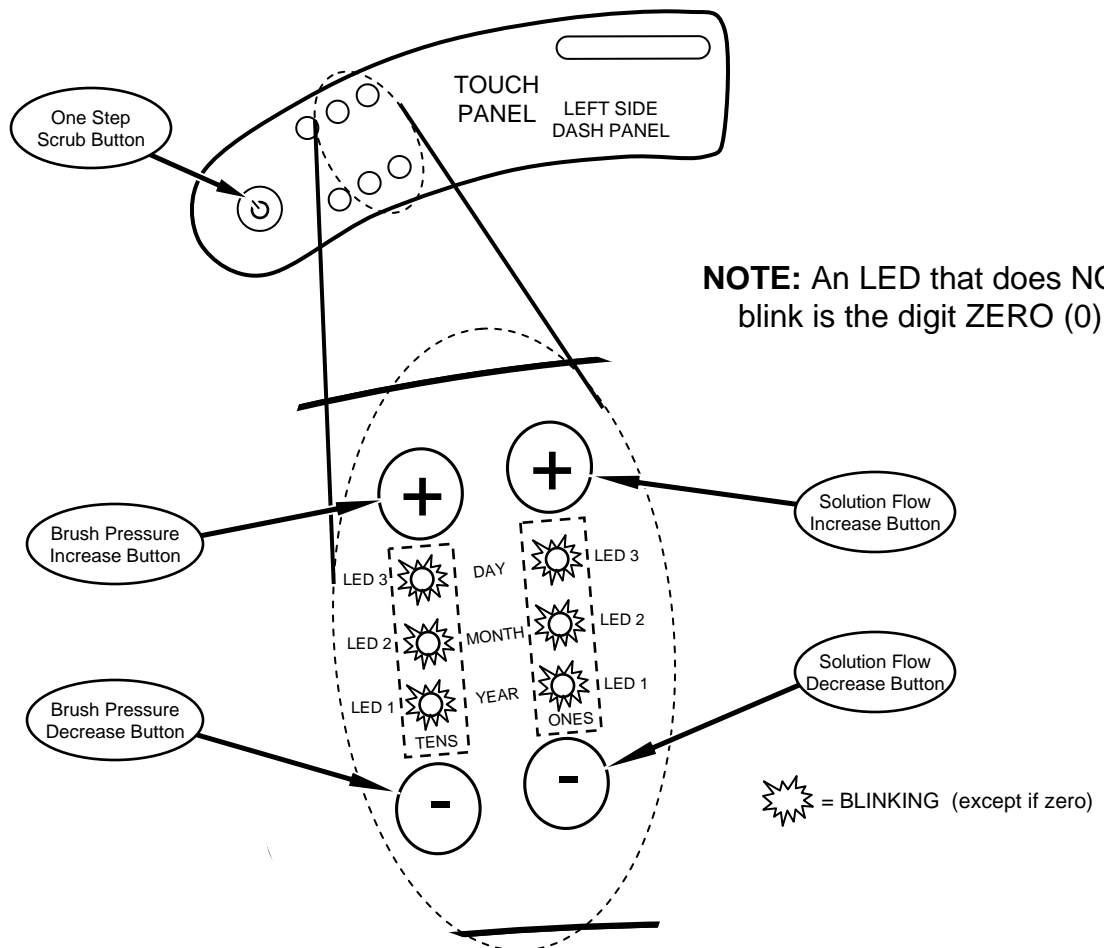

Speed Scrub – Self Test Mode

TO ENTER:

- Press and hold FaST & Vacuum Fan/Squeegee Buttons
- Turn key switch ON, wait 10 seconds
- Release Buttons
- The entire Self Test takes approximately 40 seconds

AFTER THE SELF TEST IS COMPLETE:

- If the One Step LED is lit solid, NO FAULTS were found
- If any LED is blinking, an OPEN FAULT was found – refer to table below
- If any LED (other than One Step) is lit solid, a SHORT FAULT was found – refer to table below

Self Test Results

LED (Flashing = OPEN, Solid = SHORT)	System at Fault
One Step LED	No Faults Found
FaST LED	Fast Pump
Vacuum Fan/Squeegee LED	Vacuum-Fan
# 3 (Upper) Brush Pressure LED	Right Brush
# 2 (Middle) Brush Pressure LED	Left Brush
# 1 (Lower) Brush Pressure LED	Head Actuator
# 3 (Upper) Solution Flow LED	Water Valve
# 2 (Middle) Solution Flow LED	Squeegee Actuator
# 1 (Lower) Solution Flow LED	Brake
Recovery Tank Full LED	Horn/Back-up Alarm

Speed Scrub – Input Display Mode

The purpose of the Input Display Mode is to show the condition of various control board inputs

TO ENTER:

- Press and hold the Decrease Solution Flow (-) Button
- Turn key switch ON
- Release Button after the # 4 Battery LED blinks

INPUT	ASSOCIATED LED	LED IS ON WHEN:	LED IS OFF WHEN:	NOTES
Charger Interlock Switch	FaST LED	Battery charger IS NOT plugged in (switch is CLOSED)	Battery charger IS plugged in (switch is OPEN)	FaST system will still operate, but without indicator
Seat Switch	# 5 (Green) Battery LED	Operator IS NOT sitting on seat (switch is OPEN)	Operator IS sitting on Seat (switch is CLOSED)	
Recovery Tank Float Switch	Recovery Tank Full LED	Recovery tank IS FULL (switch must be CLOSED for 5 to 7 seconds after One Step Button is activated)	Recovery tank IS NOT FULL (switch is OPEN)	Opening switch and pushing the the One Step Button turns LED off again
Solution Tank Float Switch	Solution Tank Empty LED	Solution tank IS EMPTY (switch must be OPEN for 5 to 7 seconds after One Step Button is activated)	Solution tank IS NOT EMPTY (switch is CLOSED)	Closing switch and pushing the the One Step Button turns LED off again
Emergency Stop Switch	Fault Indicator LED (Blinking)	Emergency Stop Switch IS ACTIVATED (switch is OPEN)	Emergency Stop Switch IS NOT ACTIVATED (switch is CLOSED)	Horn will repeat 8 beep cycle when Emergency Stop Switch is activated
One Step Button	One Step LED	Scrub system IS ACTIVATED	Scrub system IS NOT ACTIVATED	
Vacuum Fan/Squeegee Button	Vacuum Fan/Squeegee LED	Vacuum Fan & Squeegee ARE ACTIVATED	Vacuum Fan & Squeegee ARE NOT ACTIVATED	
Battery Voltage	# 1 (Red) Battery LED	Battery needs charging (LED is BLINKING)	Battery has sufficient charge level	

Left Scrub Brush

Low Pressure	# 1 (Lower) Brush Pressure LED	LOW scrub brush current sensed	Scrub system IS NOT ACTIVATED
Medium Pressure	# 2 (Middle) Brush Pressure LED	MEDIUM scrub brush current sensed	
High Pressure	# 3 (Upper) Brush Pressure LED	HIGH scrub brush current sensed	

Right Scrub Brush

Low Pressure	# 1 (Lower) Solution Flow LED	LOW scrub brush current sensed	Scrub system IS NOT ACTIVATED
Medium Pressure	# 2 (Middle) Solution Flow LED	MEDIUM scrub brush current sensed	
High Pressure	# 3 (Upper) Solution Flow LED	HIGH scrub brush current sensed	



NOTE: For Propel & Brake signal troubleshooting, refer to the Propel Diagnostics Mode page

Speed Scrub – Manual Mode

The purpose of the Manual Mode is to allow functioning of the individual systems on the machine without regard of most safety interlocks

TO ENTER:

- Press and hold the Decrease Brush Pressure (-) Button
- Turn key switch ON
- Release Button after # 1 (Lower) Brush Pressure LED blinks

FUNCTION	BUTTON	ACTION	INDICATOR	NOTES
Lower Scrub Head	One Step	Press & Hold	One Step LED ON	Scrub head will continue to lower as long as button is held
 CAUTION: Do not hold One Step Button down too long - actuator stall will occur, possibly damaging actuator or control board				
Operate Scrub Brushes	One Step	Release button after lowering scrub head	One Step LED ON	Scrub head stops lowering after One Step Button is released
Turn OFF Scrub Brushes and Raise Scrub Head	One Step	Press & Release	One Step LED OFF	Scrub head raises to top of stroke and stops
Turn ON Vacuum Fan and Lower Squeegee	Vacuum Fan/Squeegee	Press & Release	Vacuum Fan/Squeegee LED ON	In this mode, pressing the One Step Button during lowering of the squeegee will stop squeegee travel
 CAUTION: In this mode, automatic raising of the squeegee when in REVERSE is disabled				
Turn OFF Vacuum Fan and Raise Squeegee	Vacuum Fan/Squeegee	Press & Release	Vacuum Fan/Squeegee LED OFF	In this mode, pressing the One Step Button during raising of the squeegee will stop squeegee travel
Turn ON FaST pump	FaST	Press & Release	FaST LED ON	
Turn OFF FaST pump	FaST	Press & Release	FaST LED OFF	
Increase Solution Flow Rate	Increase Solution Flow (+)	Press & Release	Solution Flow LED's	In this mode, the Solution Flow automatic ON/OFF interlock is disabled
Decrease Solution Flow Rate	Decrease Solution Flow (-)	Press & Release	Solution Flow LED's	In this mode, the Solution Flow automatic ON/OFF interlock is disabled
ADDITIONAL NOTES				
• When the Recovery Full switch is grounded for a short time, the Recovery Full LED will light				
• When the Solution Empty switch is un-grounded for a short time, the Solution Empty LED will light				
• If the Recovery Full LED or the Solution Empty LED is ON, and the Scrub System or Vacuum Fan/Squeegee system is activated, the Recovery Full LED and Solution Empty LED will turn OFF and the sensing of both switches will be disabled for about a minute				
• With the Directional Switch in REVERSE, the Back-up Alarm will sound but automatic raising of the squeegee is disabled				
• For safety considerations, the "High Pedal Disable" and "Seat Switch Disable" interlocks & alarms are still active in Manual Mode				

Speed Scrub – Propel/Brake Diagnostics

TO ENTER:

- Press and hold FaST & Increase Brush Pressure (+) Buttons
- Turn key switch ON
- Release Buttons after FaST LED (if in Forward) or Vacuum Fan/Squeegee LED (if in Reverse) is lit

TEST	ACTION	INDICATOR	NOTES
Directional Switch - Forward	Place Directional Switch in Forward Propel position	FaST LED ON	LED will be illuminated if the controller senses the Directional Switch in Forward Position - Machine will not propel if any of the Brake LED's are illuminated
Directional Switch - Reverse	Place Directional Switch in Reverse Propel position	Vacuum Fan/Squeegee LED ON	LED will be illuminated if the controller senses the Directional Switch in Reverse Position - Machine will not propel if any of the Brake LED's are illuminated
Brake Pedal	Depress Brake Pedal	Brush Pressure LED's	LED's will display the sensed position of the brake pedal - No LED's indicate pedal is released, 3 LED's indicate that the pedal is fully depressed
Accelerator Pedal	Depress Accelerator Pedal	Solution Flow LED's	LED's will display the sensed position of the accelerator pedal - No LED's indicate the pedal is released, 3 LED's indicate that the pedal is fully depressed
Propel Motor Current	Depress Accelerator Pedal	Battery LED's	Battery gauge LED's display the current level being drawn by the Propel Motor - Each LED represents 7 Amps of current (ex: 3 LED's = 21 Amps)

Propelling System Data

Direction	Wire #	Color	Polarity	Notes	
Forward	25	Green	-	Voltage during FORWARD travel will vary between 0 to 24 VDC	Releasing the Propel Pedal will initiate Dynamic Braking; As machine slows to a halt, the Brake solenoid is De-energized, applying the Parking Brake
	24	Yellow	+		
Reverse	25	Green	+	Voltage during REVERSE travel will vary between approximately 0 to 17 VDC	
	24	Yellow	-		

Propel & Brake Pedal Data

Pedal	LED group	Lit LED's	Pedal Position	Input Voltage Level	Notes
Propel	Solution Flow	0	Released	below 1.35 VDC	Machine must be in Propel Diagnostic Mode when testing; LED's will display the sensed position of the pedal; No LED's indicate pedal is released; 3 LED's indicate pedal is fully depressed
		1	Slightly Depressed	1.35 to 1.89 VDC	
		2	Halfway Depressed	1.89 to 2.27 VDC	
		3	Fully Depressed	2.27 to 4.0 VDC	
Brake	Brush Pressure	0	Released	below 1.5 VDC	
		1	Slightly Depressed	1.5 to 1.89 VDC	
		2	Halfway Depressed	1.89 to 2.27 VDC	
		3	Fully Depressed	2.27 to 4.0 VDC	

Speed Scrub – Battery Select Mode & Voltage Levels

Battery Select Mode

TO ENTER:

- Press and hold Increase Solution Flow (+) Button
- Turn key switch ON
- Release Button after one of the Battery LED's begins blinking

Location / Type	BDI Indicator LED's
Worldwide / Wet	
Europe** / Wet	
TNV** / Wet	
Worldwide / Gel	

LED's: R=RED Y=YELLOW G=GREEN x=OFF =BLINKING

**Used only under instruction of battery manufacturer

Voltage Levels*

Battery Level	Worldwide Voltage (Wet)	European** Voltage (Wet)	TNV** Voltage (Wet)	Worldwide Voltage (Gel)	BDI Indicator LED's
Full Battery Voltage	24.5	24.5	24.5	24.5	
Level 4	23.8	23.9	23.9	24.0	
Level 3	23.1	23.2	23.3	23.5	
Level 2	22.4	22.6	22.7	23.0	
Level 1	21.7	21.9	22.1	22.6	
Full discharge	21.0	21.3	21.6	22.2	

LED's: R=RED Y=YELLOW G=GREEN x=OFF =BLINKING

*Voltage measured at circuit board - Assume 0.5 Volts higher at batteries (under load)

**Used only under instruction of battery manufacturer

Speed Scrub – Reverse Alarm & Propel Speed Select Modes

Reverse Alarm Select Mode

Reverse Alarm Select Mode allows enabling or disabling of the Backup Alarm

TO ENTER:

- Put directional switch in Reverse
- Press & Hold Horn Button
- Turn key switch ON
- If Back-up Alarm is silent, Hospital (Quiet) Mode has been selected
- If Back-up Alarm is sounding, Normal mode has been selected
- Cycle key switch OFF, then ON again
- Verify correct mode has been chosen

Propel Speed Select Mode

Propel Speed Select Mode allows selection of maximum forward speed during scrubbing

TO ENTER:

- Press and hold FaST Button
- Turn key switch ON
- Release Buttons after selecting desired Brush Pressure LED
- Refer to table below for speed selection

BRUSH PRESSURE LED	MAXIMUM SCRUB SPEED
# 1 (Lower) LED	2.0 mph / 3.2 kph
# 2 (Middle) LED	2.7 mph / 4.3 kph
# 3 (Upper) LED	3.5 mph / 5.5 kph

Speed Scrub – Inputs & Outputs Table

Inputs and the Outputs they Control	Inputs													
	Key Switch (ON)	Seat Switch (Operator on seat)	Charger Switch (Charger plugged in to machine)	Emergency Stop Switch (Pressed)	One Step Switch (ON)	FaST Switch (ON)	Vacuum Fan/Squeegee Switch (ON)	Recovery Tank Full Switch (Tank Full)	Solution Tank Empty Switch (Tank Empty)	Directional Switch Forward	Directional Switch Reverse	Throttle Input (Pedal pressed)	Brake Input (Pedal pressed)	Horn Button (Pressed)
Main Contactor	E		D	D										
Propel Forward	E	E	D	D					E	D	E	D		
Propel Reverse	E	E	D	D					D	E**	E	D		
Dynamic Braking Force - Increase	E	E		D								E		
Parking Brake			E	E							D	E***		
Scrub Motors	E		D	D	E			D	D		E	D		
Scrub Head Pressure Control	E		D	D	E			D	D		E	D		
Vacuum Motor	E		D	D			E	D	D					
Squeegee Down	E		D	D			E	D	D	E	D			
FaST System	E		D	D	E	E		D	D		E	D		
Solution Solenoid	E		D	D	E									
Hour Meter Operation	E						E*				E*			
Horn	E									E**				E
Battery Gauge Reset			E											

E = Input that will ENABLE Output

D = Input that will DISABLE Output

* Activating Vacuum Fan **OR** Propelling machine will enable the Hour Meter

** Horn will sound when Directional Switch is selected for Reverse (**except** in Hospital Mode)

*** Parking Brake activated after timer has expired

Torque Standard





Inch Fasteners

Thread Size	SAE Grade 1	SAE Grade 2 Carriage Bolts	Thread Cutting Thread Rolling	SAE Grade 5 Socket and Stainless Steel	SAE Grade 8	Headless Socket Set Screws	Square Head Set Screws	I N C H P O U N D S
4 (.112)	(5)–(6.5)					(4)–(6)		
5 (.125)	(6)–(8)					(9)–(11)		
6 (.138)	(7)–(9)		(20)–(24)			(9)–(11)		
8 (.164)	(12)–(16)		(40)–(47)			(17)–(23)		
10 (.190)	(20)–(26)		(50)–(60)			(31)–(41)		
1/4 (.250)	4–5	5–6	7–10	7–10	10–13	6–8	17–19	
5/16 (.312)	7–9	9–12	15–20	15–20	20–26	13–15	32–38	
3/8 (.375)	13–17	16–21		27–35	36–47	22–26	65–75	
7/16 (.438)	20–26	26–34		43–56	53–76	33–39	106–124	
1/2 (.500)	27–35	39–51		65–85	89–116	48–56	162–188	
5/8 (.625)		80–104		130–170	171–265		228–383	
3/4 (.750)		129–168		215–280	313–407		592–688	
1 (1.000)		258–335		500–650	757–984		1281–1489	

Torque Foot Pounds (Inch Pounds) Zinc Plated

Torque Standard

Inch Fasteners

Fastener Identification	Type	Material	Nominal Size	Mechanical Properties		
				Proof Load (PSI)	Yield Strength Min (PSI)	Tensile Strength Min (PSI)
	SAE Grade 1 Machine Screws	Low or Medium Carbon Steel	#2 Thru #10			55,000
			1/4 Thru 1 1/2	33,000	36,000	60,000
	SAE Grade 2 Carriage Bolts	Low or Medium Carbon Steel	1/4 Thru 3/4	55,000	57,000	74,000
			Over 3/4 Thru 1 1/2	33,000	36,000	60,000
	Stainless Steel	18-8 Austenitic Stainless Steel			50,000	90,000
	SAE Grade 5	Medium Carbon Steel Quenched Tempered	1/4 Thru 1	85,000	92,000	120,000
			Over 1 to 1 1/2	74,000	81,000	105,000
	Socket Screws	High Carbon Alloy Steel Quenched Tempered		136,000		160,000
	SAE Grade 8	Medium Carbon Alloy Quenched Tempered	1/4 Thru 1 1/2	120,000	130,000	150,000

Torque Standard

METRIC Fasteners

Thread Size	CENTIMETERS				
	4.8/5.6	8.8 Stainless Steel	10.9	12.9	Set Screws
M3	43–56 Ncm	99–128 Ncm	139–180 Ncm	166–215 Ncm	61–79 Ncm
M4	99–128 Ncm	223–290 Ncm	316–410 Ncm	381–495 Ncm	219–285 Ncm
M5	193–250 Ncm	443–575 Ncm	624–810 Ncm	747–970 Ncm	427–554 Ncm
M6	3.3–4.3 Nm	7.6–9.9 Nm	10.8–14 Nm	12.7–16.5 Nm	7.5–9.8 Nm
M8	8.1–10.5 Nm	18.5–24 Nm	26.2–34 Nm	31–40 Nm	18.3–23.7 Nm
M10	16–21 Nm	37–48 Nm	52–67 Nm	63–81 Nm	
M12	28–36 Nm	64–83 Nm	90–117 Nm	108–140 Nm	
M14	45–58 Nm	102–132 Nm	142–185 Nm	169–220 Nm	
M16	68–88 Nm	154–200 Nm	219–285 Nm	262–340 Nm	
M20	132–171 Nm	300–390 Nm	424–550 Nm	508–660 Nm	
M22	177–230 Nm	409–530 Nm	574–745 Nm	686–890 Nm	
M24	227–295 Nm	520–675 Nm	732–950 Nm	879–1140 Nm	

Zinc Plated

Conversion Tables

Ncm to Inch Pound x 0.08851



Inch Pound to Ncm x 11.2982

Nm to Foot Pound x 0.7376

Foot Pound to Nm x 1.3558

Torque Standard

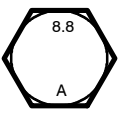
METRIC Fasteners

Fastener Identification	Type Class	Material	Nominal Size	Mechanical Properties		
				Yield Stress (Min) MPa	Yield Point .2% Elongati (Min) MPa	Tensile Strength (Min) MPa
	3.6/4.6 Carriage Bolts	Low or Medium Carbon Steel		190 (27,550 PSI) 240 (34,800 PSI)		330 (47,850 PSI) 400 (58,000 PSI)
	4.8 Pan Head Machine Screws	Low or Medium Carbon Steel		340 (49,300 PSI)		420 (60,900 PSI)
	A2-70 Stainless Steel	Austenitic Stainless Steel		450 (65,300 PSI)		700 (101,000 PSI)
	8.8 Hex Head (Grade 5)	Medium Carbon Steel Quenched Tempered	≤ M16		640 (92,800 PSI)	800 (116,000 PSI)
			> M16		660 (95,700 PSI)	830 (120,350 PSI)
	10.9 Hex Head Flat Head (Grade 8)	Medium Carbon Steel Quenched Tempered			940 (136,300 PSI)	1040 (150,800 PSI)
	12.9 Socket Head	Alloy Steel			1100 (159,500 PSI)	1220 (176,900 PSI)

Conversion Table

Mega Pascals to Pounds per Square Inch x 145.138

Fasteners and Torque Control (1-01)

Torque Standard

**Nylon Insert Lock Nuts
Nut-Hex Light THIN
(Cad or Zinc Plated)**

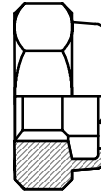

Size	Grade 2 Bolt	Grade 5 Bolt
1/4-20	5-8	7-8
1/4-28	4-6	5-6
5/16-18	8-14	13-14
5/16-24	9-14	13-14
3/8-16	12-18	15-18
3/8-24	12-18	16-18
1/2-13	26-40	37-40
1/2-20	27-42	41-42
5/8-11	58-89	73-89
5/8-18	60-92	82-92

Torque in Foot Pounds

Torque Standard



Wheel Bolt and Nuts

Stud or Bolt Size and Thread	Recommended Torque in Foot Pounds
7/16-20	75-85
1/2-20	75-85
9/16-18	80-90
5/8-18	140-170

Wheel Bearing Adjustment

1. Tighten the spindle nut to 12 ft lbs while turning the wheel assembly forward by hand to fully seat the bearings.
2. Back off the nut to the “just loose” position.
3. Hand tighten the spindle nut. Loosen the spindle nut until either hole in the spindle lines up with a slot in the nut. (Not more than 1/2 flat.)
4. Install the cotter pin. Bend the ends of the cotter pin against the nut, cut off extra length to ensure ends will not interfere with the dust cap.

Tightening Nuts on Tapered Shafts

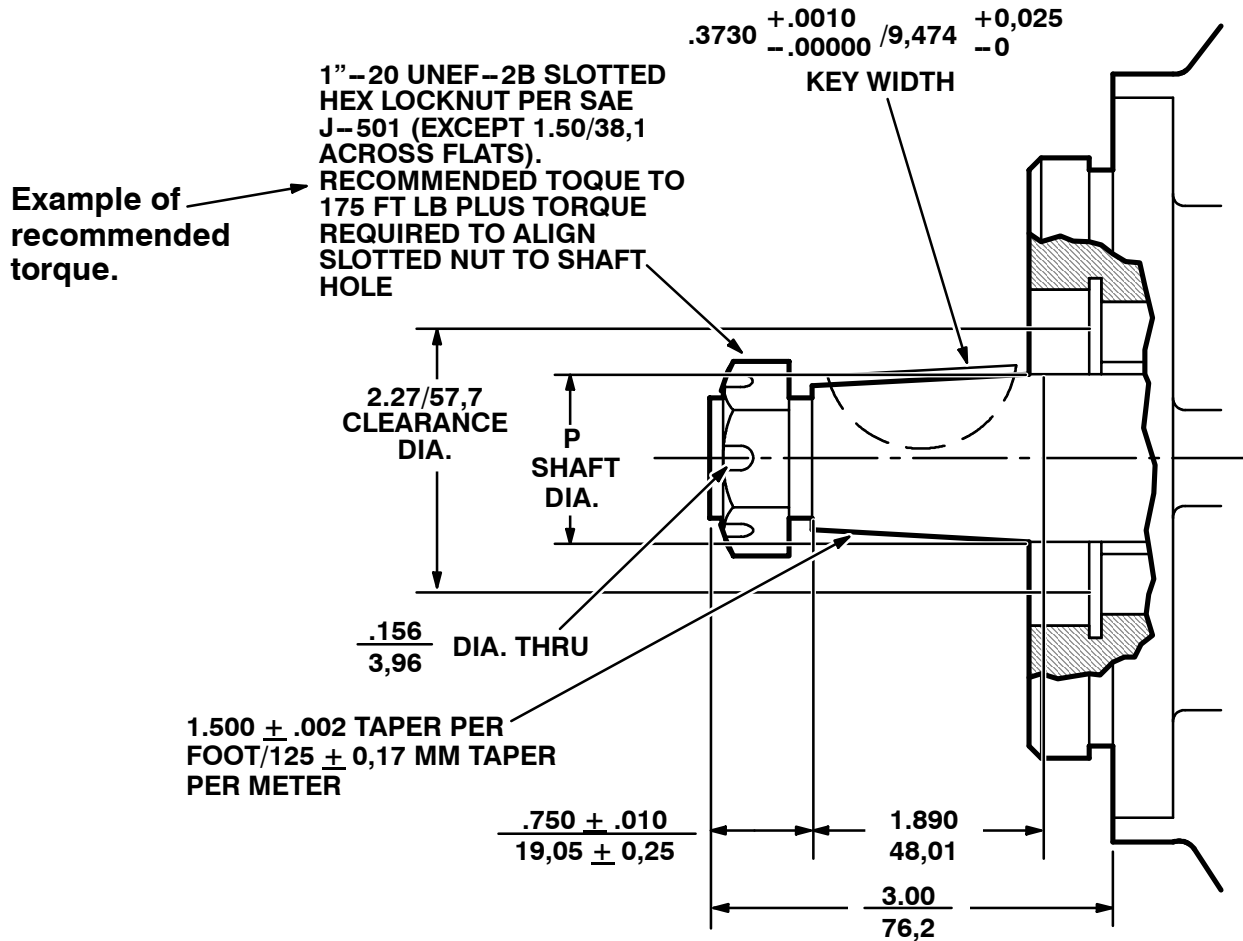

Check with the manufacturer to see what the recommended maximum torque is. Tighten the slotted nut to a lower torque, and then tighten the nut to align the cotter pin hole with the slot on the nut. Do not exceed the recommended torque. Do not back off the nut to align the holes.

Motor	Tapered Shaft	Nut Info.	Torque Specification Recommendations
A&H Series	1.00 dia.	.75-16 UNF 1.107 Hex	150 ft lb dry 125 ft lb lubricated Plus torque to align for pin
2000 Series	1.25 dia.	1-20 UNEF 1.44 Hex	225 ft lb dry 225 ft lb lubricated PLUS torque to align for pin
4000 Series	1.625 dia.	1.25-18 UNEF 2.187 Hex	475 ft lb dry 375 ft lb lubricated PLUS torque to align for pin
6000 Series	1.75 dia.	1.25-18 UNEF 2.187 Hex	475 ft lb dry 375 ft lb lubricated PLUS torque to align for pin

Torque Standard

Shoulder Bolts

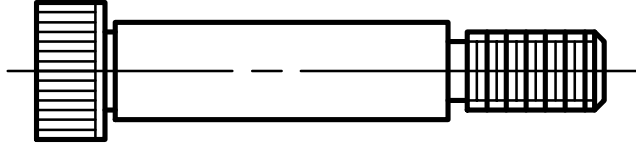

Nominal Diameter	Thread Size	Recommended Seating Torque
.250	10-24	45 In Lbs
.312	1/4-20	9 Ft Lbs
.375	5/16-18	19 Ft lbs
.500	3/8-16	32 Ft Lbs
.625	1/2-13	82 Ft Lbs
.750	5/8-11	164 Ft Lbs

Metric

Nominal Diameter	Thread Size	Recommended Seating Torque
6	M5x0.8	7 Nm
8	M6x1.0	12 Nm
10	M8x1.25	29 Nm
12	M10x1.5	57 Nm
16	M12x1.75	100 Nm

Taper Lock® Bushings

IMPORTANT: Follow all these instructions carefully. This is necessary to insure satisfactory performance.

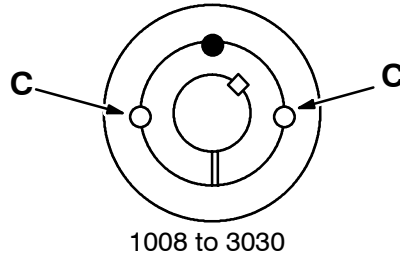

To Install

1. Clean shaft, bore and outside of bushing, and hub bore of all oil, lacquer, and dirt.
2. Insert bushing in hub. Match the hole pattern, not threaded holes (each hole will be threaded on one side only).
3. Oil setscrews and thread into those half threaded holes indicated by C on above diagram.
4. Alternately torque setscrews to recommended torque setting in chart below.
5. Using a block, sleeve, or drift, hammer large end of bushing (do not hammer bushing directly).
6. Repeat steps 4 and 5 until torque wrench reading after hammering is the same as before hammering.
7. Fill all unoccupied holes with grease.

To Remove

1. Remove all setscrews.
2. Insert setscrews in holes indicated by ● on the diagram. Loosen bushing by alternately tightening setscrews.
3. To reinstall, complete all seven (7) steps installation steps.

Recommended Wrench Torque

Bushing No.	Screws	Wrench Torque (Pound-Inch)	Hammer Size
1008, 1108	1/4" Setscrews	55	6 lb
1210, 1215, 1310	3/8" Setscrews	175	6 lb
1610, 1615	3/8" Setscrews	175	6 lb
2012	7/16" Setscrews	280	6 lb
2517, 2525	1/2" Setscrews	430	6 lb
3020, 3030	5/8" Setscrews	800	6 lb

If two bushings are used on same component and shaft, fully tighten one bushing before working on the other.

Sequence Tightening

On some assemblies, it is advisable to use a crisscross pattern. Always avoid starting in one spot and tightening one after another in a row. Remember that the object is to tighten the parts in such a manner that even stress is set up throughout, at the same time allowing the parts to be drawn together so that their mating surfaces will contact.

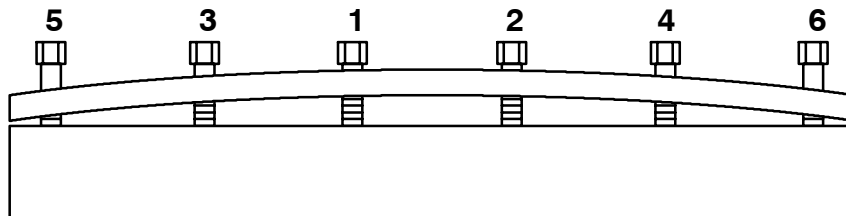
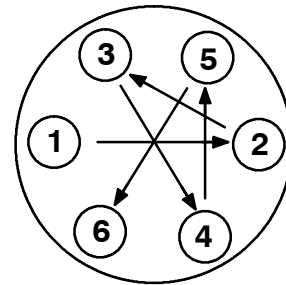
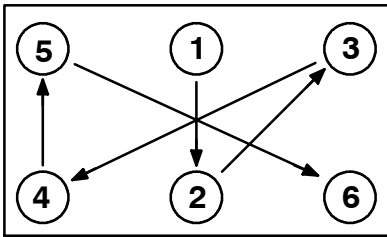

Torque in Steps

1. Run each fastener, in proper sequence, up to the recommended torque.
2. Repeat the process of running up each fastener, in proper sequence, up to the recommended torque.
3. If necessary, repeat step two until all the fasteners are tightened to the recommended torque.