



RESEARCH FOUNDATION

RESEARCH FOR THE NFPA MISSION

Sprinkler Protection Guidance for Lithium-Ion Based Energy Storage Systems

FINAL REPORT BY:

**R. Thomas Long, Jr., P.E., CFEI
Amy M. Misera, CFEI**

Exponent, Inc.
Bowie, MD, USA

June 2019

© 2019 Fire Protection Research Foundation

1 Batterymarch Park, Quincy, MA 02169-7417, USA
Email: foundation@nfpa.org | Web: nfpa.org/foundation

FOREWORD

The 2016 Fire Protection Research Foundation project “*Fire Hazard Assessment of Lithium Ion Battery Energy Storage Systems*” identified gaps and research needs to further understand the fire hazards of lithium ion battery energy storage systems. There is currently limited data available on the fire hazard of energy storage systems (ESS) including two full-scale open-air tests from the 2016 Foundation project and a separate project that included intermediate scale fire testing conducted at the module level to evaluate the performance of fire suppressants. The fire protection and fire service communities need guidance on protection requirements for these systems in a building.

The Research Foundation initiated this project to determine sprinkler protection guidance for grid-connected lithium-ion battery based ESS for commercial occupancies. This report includes a summary of the small-scale and large-scale experimental testing undertaken for this project and the resulting protection recommendations.

The Fire Protection Research Foundation expresses gratitude to the report authors R. Thomas Long, Jr., P.E., CFEI, and Amy M. Misera, who are with Exponent, Inc. located in Bowie, MD, USA. The Research Foundation appreciates the guidance provided by the Project Technical Panelists, the funding provided by the Property Insurance Research Group (PIRG), and all others that contributed to this research effort. The Foundation also expresses gratitude to NEC Energy Solutions, Inc. and Retrieval Technologies for their donations to support the project.

Special thanks are expressed to FM Global who donated their resources to complete the fire testing. A separate FM Global report containing the results from this experimental effort, as well as additional test results and expanded data analysis, can be found at: <https://www.fmglobal.com/research-and-resources/research-and-testing/research-technical-reports>.

The content, opinions and conclusions contained in this report are solely those of the authors and do not necessarily represent the views of the Fire Protection Research Foundation, NFPA, Technical Panel or Sponsors. The Foundation makes no guaranty or warranty as to the accuracy or completeness of any information published herein.

About the Fire Protection Research Foundation

The [Fire Protection Research Foundation](#) plans, manages, and communicates research on a broad range of fire safety issues in collaboration with scientists and laboratories around the world. The Foundation is an affiliate of NFPA.



About the National Fire Protection Association (NFPA)

Founded in 1896, NFPA is a global, nonprofit organization devoted to eliminating death, injury, property and economic loss due to fire, electrical and related hazards. The association delivers information and knowledge through more than 300 consensus codes and standards, research, training, education, outreach and advocacy; and by partnering with others who share an interest in furthering the NFPA mission.



[All NFPA codes and standards can be viewed online for free.](#)

NFPA's [membership](#) totals more than 65,000 individuals around the world.

Keywords: energy storage systems, energy storage, li-ion battery, lithium-ion, ESS, fire hazard of ESS, sprinkler protection of ESS

Report number: FPRF-2019-06-REV

PROJECT TECHNICAL PANEL

Jim Biggins, Global Risk Consultants
Andrew Blum, Fisher Engineering
Tom De Lucia, NEC Energy Solutions
Laurie Florence, UL
Kevin Fok, LG Chem
Jan Gromadzki, Tesla
Kevin Marr, University of Texas
Dirk Long, Renewable Energy Systems (RES)
Celina Mikolajczak, Uber
Erin Minear, Energy Storage Integration Council
Leo Subbarao, FDNY
Nick Warner, Warner Energy Storage Solutions and ESG
Brian O'Connor, NFPA

PROJECT SPONSORS

Property Insurance Research Group (PIRG):

AIG
CNA Insurance
FM Global
Liberty Mutual Insurance
Tokio Marine America
Travelers Insurance
Verisk
Zurich Insurance Group

Exponent[®]

Thermal Sciences

**Sprinkler Protection
Guidance for Lithium-Ion
Based Energy Storage
Systems**





Sprinkler Protection Guidance for Lithium-Ion Based Energy Storage Systems

Prepared for:

Fire Protection Research Foundation
One Batterymarch Park
Quincy, MA 02169

Prepared by:

R. Thomas Long, Jr., P.E., CFEI
Amy M. Misera, CFEI
Exponent, Inc.
17000 Science Drive
Suite 200
Bowie, MD 20715

May 29, 2019

© Exponent, Inc.

Contents

	<u>Page</u>
List of Figures	iv
List of Tables	v
Acronyms and Abbreviations	vi
Limitations	vii
Executive Summary	viii
1 Introduction	1
2 Existing ESS Sprinkler Protection Guidance Documents	2
3 Battery Description and Test Set Up	3
3.1 Commodity/Battery Descriptions	3
3.2 Test Facility and Set Up	4
4 Small-Scale Free Burn Tests	5
4.1 Small-Scale Free Burn Test Set Up	5
4.2 Small-Scale Free Burn Test Results	5
5 Intermediate-Scale Free Burn Tests	7
5.1 Intermediate-Scale Free Burn Test Set up	7
5.2 Intermediate-Scale Free Burn Test Results	7
6 Large-Scale Free Burn Tests	10
6.1 Large-Scale Free Burn Test Set up	10
6.2 Large-Scale Free Burn Test Results	11
7 Large-Scale Sprinklered Tests	15
7.1 Large-Scale Sprinklered Test Set up	15
7.1.1 Sprinkler layout	16
7.2 Large-Scale Sprinklered Test Results	16
7.2.1 Sprinkler Performance	19
8 Applications to Sprinkler Protection Guidance	21

9	Conclusions	25
10	Recommendations	27
11	Possible Future Work	28
12	Acknowledgements	29
11	References	30

List of Figures

	<u>Page</u>
Figure 1. Battery cell description.	3
Figure 2. LFP and LNO/LMO battery chemistry mass and energy information.	4
Figure 3. Small-scale free burn test set up.	5
Figure 4. Intermediate-scale free burn test set up.	7
Figure 5. Large-scale free burn test set up.	10
Figure 6. LFP fire development during large-scale free burn test.	12
Figure 7. LNO/LMO fire development during large-scale free burn test.	12
Figure 8. LFP full-scale free burn HRR.	13
Figure 9. LNO/LMO full-scale free burn HRR.	14
Figure 10. Large-scale sprinklered test set up.	15
Figure 11. Large-scale sprinklered test set up.	16
Figure 12. LFP fire development during large-scale sprinklered test.	17
Figure 13. LNO/LMO fire development during large-scale sprinklered test.	17
Figure 14. LFP large-scale sprinklered test HRR curve.	18
Figure 15. LNO/LMO large-scale sprinklered test HRR curve.	19
Figure 16. Sprinkler layout and operation overview for LFP (left) and LNO/LMO (right).	20
Figure 17. LFP and LNO/LMO free burn and sprinklered HRR comparison.	21
Figure 18. LFP and LNO/LMO free burn and sprinklered threshold comparison.	22
Figure 19. Diagram of three primary rack configurations.	23

List of Tables

Table 1. Summary of small-scale free burn testing results.

Table 2. Summary of intermediate-scale free burn testing results.

Table 3. Summary of large-scale free burn testing results.

Acronyms and Abbreviations

ESS	Energy Storage System
FPC	Fire Products Collector
FPRF	Fire Protection Research Foundation
HRR	Heat Release Rate
LFP	Lithium Iron Phosphate
NFPA	National Fire Protection Association
LNO/LMO	Lithium Nickel Oxide and Lithium Manganese Oxide
PIRG	Property Insurance Research Group
QR	Quick Response
RTI	Response Time Index
SR	Standard Response

Limitations

At the request of the Fire Protection Research Foundation (FPRF), Exponent has reported on the development of sprinkler protection guidance for lithium-ion based energy storage systems. This report summarizes small- to large-scale free burn fire test and large-scale sprinklered test results from two battery chemistries. The scope of services performed during this assessment of the test data may not adequately address the needs of other users of this report, and any re-use of this report or its findings, conclusions, or recommendations presented herein are at the sole risk of the user.

The tests and any recommendations made are strictly limited to the test conditions included in this report. The combined effects (including, but not limited to) of different energy storage configurations and designs, ceiling heights, protection system design, battery density, state of charge, battery chemistry, and battery type, etc. are yet to be fully understood and may not be inferred from these test results alone.

The findings formulated in this review are based on observations and information available at the time of writing. The findings presented herein are made to a reasonable degree of engineering certainty. If new data becomes available or there are perceived omissions or misstatements in this report, we ask that they be brought to our attention as soon as possible so that we have the opportunity to fully address them.

Executive Summary

This summary report describes the results and fire protection recommendations developed through testing, small- to large-scale free burn tests on lithium-ion battery energy storage systems (ESS). Subsequent large-scale sprinklered tests were conducted to determine performance of water-based fire protection systems. All data, test descriptions, data analysis and figures in this report were graciously provided by FM Global. Exponent has relied on the FM Global testing report, “Development of Sprinkler Protection Guidance for Lithium Ion based Energy Storage Systems” [1] Further details are provided in the FM Global report.

This project was conducted in conjunction with the Property Insurance Research Group (PIRG) and was directed through FPRF. This project is Phase II of a larger project with the goal to develop safe installation practices, fire protection guidance, and appropriate emergency response tactics for ESS. Phase I used literature review and full-scale free burn fire tests to create a fire hazard assessment of ESS in an effort to develop safe installation practices.

All tests were performed on donated battery modules of two different chemistries; lithium iron phosphate (LFP) and lithium nickel oxide (LNO) and lithium manganese oxide (LMO). The predominant difference in the hazard was the battery chemistry and energy density. The small-scale tests were conducted to determine if thermal runaway could be induced. Intermediate-scale testing was conducted to determine the effect of system capacity and thermal exposure. The large-scale tests involved two racks each with 16 modules. The tests were conducted to establish the overall hazard of the ESS. The full-scale sprinklered tests were used to determine the performance of a water-based fire protection system typically found in a commercial occupancy where an ESS could be installed.

All tests showed ignition of a single module was sufficient to produce thermal runaway and allow for fire spread to all modules in a single rack. In all tests, the LNO/LMO modules presented a greater fire hazard than the LFP modules. Due to different battery chemistries and limited understanding of how other factors affect the fire hazard of an ESS, the results of these tests cannot be applied to ESS comprised of modules with a different battery chemistry.

1 Introduction

Lithium-ion batteries and ESS are becoming more common in the world. Unlike other common batteries and energy storage systems, the biggest hazard associated with lithium-ion batteries is the potential for thermal runaway. There have been multiple studies on battery characteristics and cause of thermal runaway of a single battery cell, but there is a lack of research on the subsequent propagation of thermal runaway in adjacent battery cells in a multiple cell module. [2,3]

The research detailed in this report is part of a multi-phase project conducted in conjunction with PIRG and in partnership with the FPRF. The overall project goal is to develop safe installation practices, fire protection guidance, and appropriate emergency response tactics for ESS. The first phase of the project completed in 2016, involved a literature review and gap analysis related to lithium-ion battery ESS and the development and implementation of full-scale free burn fire testing of two 100 kWh ESS's. The literature review and fire test results were used to create a fire hazard assessment of ESS to develop safe installation practices. [4] The goal for this phase of the project was to determine the performance of water-based fire protection systems leading to the development of sprinkler protection guidance for lithium-ion battery ESS.

Separately, tests were conducted at the module level by DNV-GL to evaluate the performance of different fire suppressants such as water, wet chemical, and dry chemical. [5] The tests concluded that water was the most effective fire suppressant. These results were supported by the findings of large-scale testing by FM Global. [6] The recent studies provide confidence that sprinklers can be effective protecting ESS in commercial occupancies, but there is limited real scale data to support sprinkler protection guidance.

This project was directed by FPRF. All resources associated with conducting the tests, as well as compiling the data and results, were generously donated by FM Global. The Foundation expresses gratitude to NEC Energy Solutions, Inc. and Retrie Technologies for their donations to support the project.

2 Existing ESS Sprinkler Protection Guidance Documents

Today there is limited guidance on the installation and protection of ESS in any occupancy. At this point, the ESS protection guidance is for installation of ESS in non-storage buildings, covered in the NFPA 13 Standard for the Installation of Sprinkler Systems [7], and various FM Global documents. Currently, the NFPA 855 Standard for the Installation of Stationary Energy Storage Systems is in the development stage. [8] There is also similar guidance expected to be included in FM Global Property Loss Prevention Data Sheet 5-33, Electrical Energy Storage. [9] The documents listed provide installation and protection guidance for lithium-ion battery based ESS.

3 Battery Description and Test Set Up

The FM Global report focused on the large-scale sprinklered tests to determine performance of water-based fire protection systems leading to the development of sprinkler protection guidance for lithium-ion battery ESS.

3.1 Commodity/Battery Descriptions

Two different types of batteries were donated and used for this project. While it is not possible to test every type of battery, testing two different chemistries provides useful information on how they each react and behave. The two chemistries used were lithium iron phosphate (LFP) and lithium nickel oxide (LNO) and lithium manganese oxide (LMO). Figure 1 below provides more specific information on each battery chemistry tested.

Specification	LFP	LNO/LMO
Battery Description		
Chemistry	Lithium iron phosphate (LFP)	Lithium nickel oxide (LNO) and lithium manganese oxide (LMO)
Capacity (Ah)	20	32.5
Voltage (VDC)	3.3	3.75
Format	Prismatic	Prismatic
Nominal Dimensions, L×W×H (mm [in.])	227 × 161 × 7.25 (8.9 × 6.3 × 0.3)	290 × 216 × 7 (11.5 × 8.5 × 0.3)
Module Description		
Capacity (Ah)	120	130
Voltage (VDC)	42.9	60
Power (kWh)	5.2	7.8
Battery Layout (S= series, P= parallel)	13S6P	16S4P
Battery Quantity (#)	78	64
Nominal Dimensions*, L×W×H [mm (in.)]	700 × 270 × 180 (27.5 × 10.75 × 7)	650 × 320 × 240 (25.5 × 12.75 × 9.5)
Mass, kg (lb)	49 (108)	75 (166)
Rack Description		
Capacity (Ah)	120	130
Voltage (VDC)	686 (16 modules)	960 (16 modules)
Rack Layout (i.e., module configuration)	2 wide × 8 tall	2 wide × 8 tall
Enclosure	Open front, solid sides	Open front, solid sides
Nominal Dimensions, W×D×H [mm (in.)]	660 × 770 × 1,760 (26 × 30.25 × 69.25)	760 × 768 × 2,400 (30 × 30.25 × 94.5)

Figure 1. Battery cell description. Courtesy of FM Global.

Before testing, each battery was balanced within ± 200 mV and the modules were charged to at least 95% state-of-charge, such that with the decay rate the modules would be at least 90%

charged at the time of testing. The total combustible load per the modules and racks differed for each type. Figure 2 provides further information on the individual battery chemistries.

Material	LFP Module		LNO/LMO Module	
	Mass	Energy*	Mass	Energy*
	kg (lb)	MJ (BTU×10 ³)	kg (lb)	MJ (BTU×10 ³)
Electrolyte	2.6 (5.7)	73 ± 7 (69 ± 7)	3.6 (7.9)	100 ± 10 (95 ± 9)
Plastic	4.9 (10.9)	188 ± 19 (178 ± 18)	10 (22.1)	381 ± 38 (361 ± 36)
Electrical Energy [†]	n/a	18.5 ± 2 (17.5 ± 2)	n/a	28 ± 3 (27 ± 3)
Total [1 Module]	7.5 (16.5)	279 ± 28 (265 ± 26)	13.6 (30.0)	509 ± 51 (482 ± 48)
Rack Total [16 modules]	120 (265)	4,464 ± 446 (4,233 ± 423)	218 (480)	8,142 ± 814 (7,719 ± 772)
*Energy is calculated using a ΔH _c for electrolyte = 28 MJ/kg (12.0 BTU/lb) [20] and unexpanded plastic = 38 MJ/kg (16.3 BTU/lb) [21].				
†Electrical energy in MJ calculated from the module power rating as P (kWh) × 3.6 s.				

Figure 2. LFP and LNO/LMO battery chemistry mass and energy information. Courtesy of FM Global.

3.2 Test Facility and Set Up

The tests were performed at the FM Global Research campus in West Glocester, Rhode Island. The facility includes multiple indoor test areas equipped with different sized combustion hoods and height adjustable ceilings for sprinklered fire tests.

Thermocouples were attached to the modules in each test to monitor the spread of the fire through the modules and heat flux gauges were used to measure the thermal exposure to other objects. The heat release rate data was measured from the collection of combustion gases to compare the fire development, overall magnitude, and total energy release. For each of the free burn tests, theoretical calculations were performed to predict sprinkler activation for both Quick Response (QR) and Standard Response (SR) sprinklers. The sprinklers used for the prediction calculations had a thermal link activation temperature of 74°C (165°F). The Response Time Index (RTI) for the QR sprinkler was 27.6 m^{1/2}s^{1/2} (50 ft^{1/2}s^{1/2}) and 170 m^{1/2}s^{1/2} (309 ft^{1/2}s^{1/2}) for the SR sprinkler. Sprinkler operation predictions were calculated for three different ceiling heights; 4.6 m, 6 m, and 7.6 m (15 ft, 20 ft, and 25 ft). For each height, the sprinkler head was located 0.3 m (1 ft) from ceiling, which corresponds with the maximum allowed distance in both NFPA 13 and FM Global Data Sheet 2-0.

4 Small-Scale Free Burn Tests

4.1 Small-Scale Free Burn Test Set Up

For the test, a single module was used with two thermocouples attached on each side of the module. Ignition was achieved with three flat bar heating elements (See Figure 3).



Figure 3. Small-scale free burn test set up. Courtesy of FM Global.

4.2 Small-Scale Free Burn Test Results

The external heating source caused thermal runaway reactions in the batteries for both module chemistries. The time of the observed battery venting was comparable for both chemistries. The LFP module was observed at 2,790 seconds and the LNO/LMO module was 2,820 seconds. For both modules the highest temperature was recorded by the bottom front thermocouple at the time of venting. The LFP module reached 295°C (563°F) and the LNO/LMO module reached 143°C (290°F). An element that was repeated in testing stages was the faster time to ignition in the LFP modules compared to the LNO/LMO modules due to closer contact with the heater and the modules and was not related to the batteries. Similarly, both modules reached peak heat release rate (HRR) around the same time. The LFP peaked at 4,620 seconds and the LNO/LMO peaked at 4,260 seconds. A noticeable difference between the two chemistries occurred in the aftermath of the batteries venting. The sparks from the LNO/LMO module were able to self-ignite the vent gases while the LFP module required a supplemental flame to ignite the vent gases consistently, for all stages of testing sometimes the gases did ignite and sometimes they did not. The HRR data for the LFP module shows a more gradual fire growth and a quicker decay phase, while the LNO/LMO module had almost non-existent fire growth until the time of peak HRR and then had a

longer decay phase. The LFP module reached a peak chemical HRR of 413 kW, while the LNO/LMO module had peak HRR over two times that of the LFP reaching 1,023 kW. Similarly, the total energy produced for the LNO/LMO module was twice as much as the LFP module, 204 MJ and 101 MJ respectively. See Table 1 for a summary of the test results. Full results can be found in the FM Global report.

Table 1. Summary of small-scale free burn testing results. Courtesy of FM Global.

	LFP	LNO/LMO
Ignition	2,790 seconds	2,820 seconds
Peak Chemical HRR	413 kW	1,023 kW
Peak Convective HRR	214 kW	450 kW
Total Chemical Energy Release	143 MJ	315 MJ
Total Convective Energy Release	101 MJ	204 MJ
Nominal Fire Duration	600 seconds	1,700 seconds
Burn out (HRR < 100 kW)	4,925 seconds	5,905 seconds

5 Intermediate-Scale Free Burn Tests

The intermediate-scale tests were conducted as a screening tool to evaluate the propensity for involvement of the module exposed to the ignition source and subsequent spread to adjacent modules. The intermediate-scale tests were conducted following the same approach as the small-scale tests.

5.1 Intermediate-Scale Free Burn Test Set up

A single test was performed on each battery chemistry. The test set up included a rack of 6 battery modules and 4 mock modules to record thermal exposure (See Figure 4). To collect the desired information, 23 thermocouples and 4 heat flux gauges were used.



Figure 4. Intermediate-scale free burn test set up. Courtesy of FM Global.

5.2 Intermediate-Scale Free Burn Test Results

Two intermediate-scale free burn tests were conducted following the approach established in the small-scale testing. In both tests, ignition of a single module was sufficient to spread the fire to all modules in the rack. Though the modules in the tests had the same set up, the modules burned differently effecting the time to peak HRR. In addition, the fire in the LFP modules spread vertically over the ignition point before spreading horizontally to the adjacent modules,

resulting in a longer fire duration but lower peak HRR. The fire in the LNO/LMO modules spread horizontally and then vertically, resulting in a shorter fire duration but a higher hazard in terms of fire intensity and thermal exposure. The LFP modules presented sustained flames at 2,970 seconds and reached near peak heat release rate at 7,996 seconds. At the time of peak HRR, the flames extended approximately 0.6 meters (2 ft). Similar to how it spread during the decay phase, the left side of the rack burned out before the right side. The fire lasted for over 9,000 seconds and at time 12,736 seconds a hose was used to manually extinguish the remaining flames. The first observed flames for the LNO/LMO rack occurred at 3,420 seconds with flames visible on the face of the ignition module. The fire reached peak HRR around 7,996 seconds and at that point the flames extended approximately 1.5 m (5 ft). During the decay phase, all modules continued to burn. At time 7,140 seconds the lower modules burned out and all modules were burned out by 7,907 seconds. Although the fire burned out without manual intervention, it was evident that modules contained heat as they maintained an orange glow until time 12,210 seconds. For both tests, the modules reached a peak temperature in the range of 400-600°C (750-1,000°F) and the peak rack temperature for both exceeded 900°C (1,650°F).

Similar to the small-scale results, in the intermediate-scale tests the LNO/LMO modules resulted in higher HRR and total energy compared to the LFP modules. The LNO/LMO module reached a peak chemical HRR of 1,890 kW and a total chemical energy of 2,030 MJ, compared to the LFP modules which reached peak chemical HRR of 500 kW and total chemical energy of 1,152 MJ. The LFP module had an extended growth phase starting around time 3,000 seconds, after the first flames had been observed. The HRR reached a peak of 500 kW around 7,800 seconds. After reaching peak, the HRR had a steady decrease leading to extinguishment at 11,400 seconds. The LNO/LMO modules fire developed differently from the LFP modules. The LNO/LMO modules HRR had a couple peaks and decays until it reached the real peak HRR of 1,890 kW around time 5,520 seconds. After reaching peak HRR, the HRR dropped and fell to under 40 kW by 8,000 seconds. See Table 2 for a summary of the test results. Full results can be found in the FM Global report.

Table 2. Summary of intermediate-scale free burn testing results. Courtesy of FM Global.

	LFP	LNO/LMO
Ignition	2,974 seconds	3,420 seconds
Peak Chemical HRR	500 kW	1,890 kW
Peak Convective HRR	312 kW	1,020 kW
Total Chemical Energy Release	1,152 MJ	2,034 MJ
Total Convective Energy Release	758 MJ	1,435 MJ
Nominal Fire Duration	6,000 seconds	3,300 seconds
Burn out (HRR < 100 kW)	11,600 seconds	7,581 seconds

6 Large-Scale Free Burn Tests

The large-scale free burn tests were conducted with the LFP and LNO/LMO equipment to evaluate the overall fire hazard and performance of sprinkler protection, similar to the previous tests. The two large-scale free burn tests were conducted with full ESS racks located in an indoor open-air environment under a 20-MW fire products collector (FPC). This approach allowed for real-time measurement of the chemical and convective heat release rate from the fire and magnitude of radiant exposure to surrounding objects, which was used to compare the relative hazard of the LFP and LNO/LMO systems.

6.1 Large-Scale Free Burn Test Set up

The large-scale tests included a rack of 16 modules and a mock rack on either side to measure the exposure hazard to adjacent equipment. In addition, faux structural walls were placed 2.7 m (9 ft) away on either side to measure exposure to surrounding objects (See Figure 5). To measure the data, 38 thermocouples and 7 heat flux gauges were used.

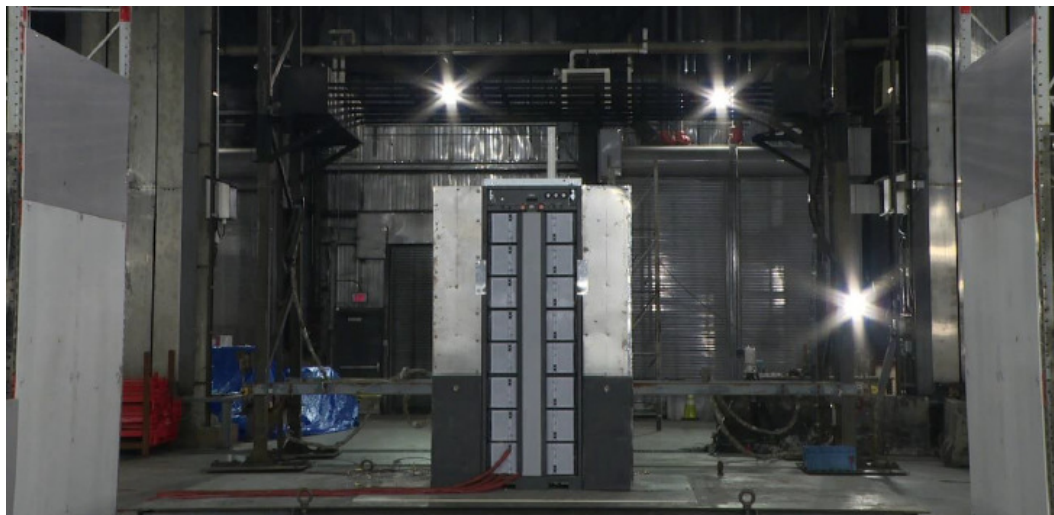

Figure 5. Large-scale free burn test set up. Courtesy of FM Global.

6.2 Large-Scale Free Burn Test Results

Similar to the small- and intermediate-scale tests, the LNO/LMO equipment presented a higher hazard than the LFP equipment in terms of fire intensity and thermal exposure to the surroundings. The LNO/LMO modules exhibited an unusually extended decay phase. The LFP modules exhibited a more traditional decay phase leading to burn out. The LFP modules burned at a nominal temperature range between 400-600°C (750-1,100°F) until the fire self-extinguished. The LNO/LMO modules reached similar temperatures as the LFP module until around 8,000 seconds when the fire transitioned to ‘furnace like’ combustion within the rack and reached temperatures exceeding 1,000°C (1,800°F). The fire progression through the modules was able to be tracked by monitoring when the thermocouples exceeded the temperature threshold. The thermocouple threshold temperature was set as 66°C (150°F) because it was the highest temperature before the noisy portion of the data on most channels. The noisy portion of the data was believed to occur as a result of leakage current from damaged batteries, more information is available in Section 3.4.2 of the FM Global report. Using this method, it was determined in the LFP modules rack the fire started with the initial module on the bottom left side and spread vertically allowing hot gases to collect and heat the top modules before spreading to the adjacent modules (See Figure 6). The LNO/LMO modules fire spread started with the ignition module and quickly spread vertically up both racks simultaneously (See Figure 7). Considering the size of the fires, the thermal exposure to the surroundings was of interest. Three heat flux gauges were placed 2.7 m (9 ft) away to record near field heat fluxes and a single heat flux gauge was placed 11.6 m (38 ft) away to record far field heat flux values. Heat flux gauge values were used to later to determine the thermal exposure at different separation distances.



Photos of LFP fire development during large-scale free burn test: near time of ignition (left), near time of predicted sprinkler operation (middle), peak heat release rate (right).

Figure 6. LFP fire development during large-scale free burn test. Courtesy of FM Global.

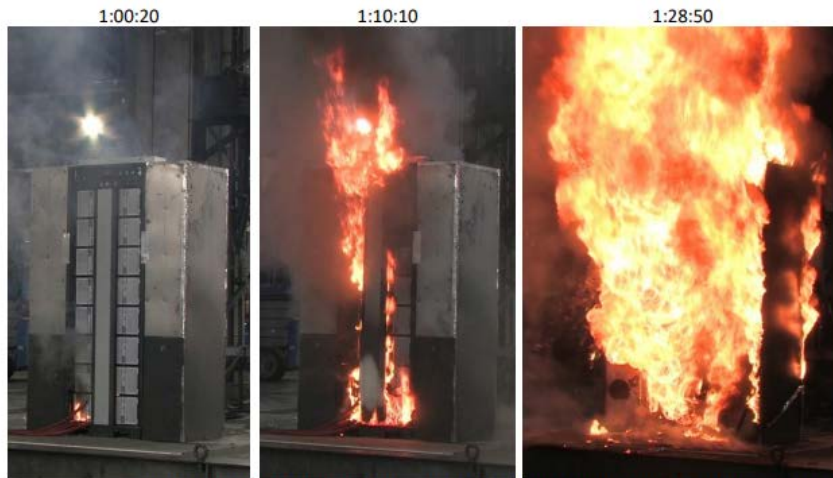

Photos of LNO/LMO fire development during large-scale free burn test: near time of ignition (left), near time of predicted sprinkler operation (middle), peak heat release rate (right).

Figure 7. LNO/LMO fire development during large-scale free burn test. Courtesy of FM Global.

Consistent with the small- and intermediate-scale tests, the LNO/LMO modules presented a significantly higher fire hazard with respect to energy release during the fire. In the full rack tests, the LNO/LMO modules reached a peak chemical HRR of 10,660 kW, which is almost five times higher than the LFP modules which reached a peak HRR of 2,450 kW. The LNO/LMO modules produced 6,390 MJ of total chemical energy, almost doubling the 3,810 MJ of total chemical energy produced by the LFP modules. For the LFP module racks, flames were first

observed around 2,280 seconds. After the initial flames, the HRR started to increase reaching the peak chemical HRR between 4,800-5,040 seconds. After reaching the peak, the HRR fell to under 1,000 kW almost instantly and was below 500 kW by 6,000 seconds. During the LNO/LMO modules test, flames were first observed around 3,500 seconds but the HRR did not register above 500 kW until after 4,200 seconds. From that point, the HRR increased at an accelerated rate reaching the peak of 10,660 kW before 5,400 seconds. Similar to the LFP modules, after reaching the peak the LNO/LMO HRR fell quickly registering under 1,000 kW by 5,880 seconds. Full HRR curves can be seen in Figure 8 and Figure 9. See Table 3 for a summary of the test results. Full results can be found in the FM Global report.

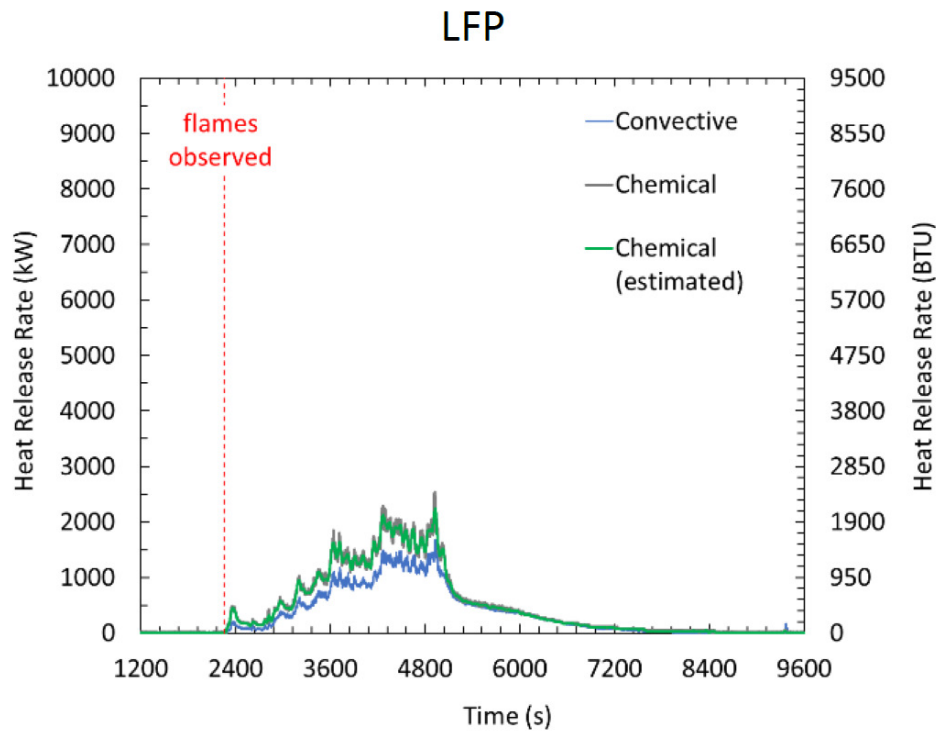

Figure 8. LFP full-scale free burn HRR. Courtesy of FM Global.

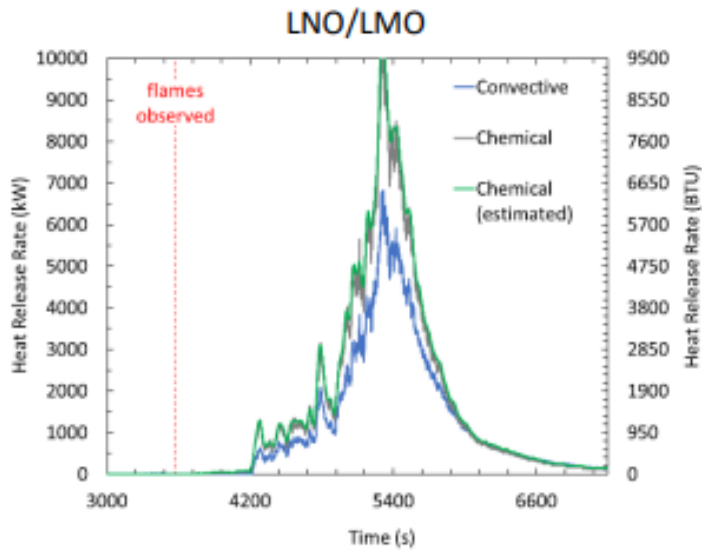

Figure 9. LNO/LMO full-scale free burn HRR. Courtesy of FM Global.

Table 3. Summary of large-scale free burn testing results. Courtesy of FM Global.

	LFP	LNO/LMO
Ignition	2,250 seconds	3,565 seconds
Peak Chemical HRR	2,540 kW	10,660 kW
Peak Convective HRR	1,680 kW	6,840 kW
Total Chemical Energy Release	3,810 MJ	6,390 MJ
Total Convective Energy Release	2,770 MJ	4,668 MJ
Nominal Fire Duration	4,750 seconds	3,000 seconds
Burn out (HRR < 100 kW)	7,100 seconds	7,270 seconds

7 Large-Scale Sprinklered Tests

After seeing the results of the large-scale free burn tests and the predicted sprinkler operation, two large-scale sprinklered fire tests were conducted under an unconfined and unobstructed ceiling to represent an ESS installation in a large open area.

7.1 Large-Scale Sprinklered Test Set up

Similar to the large-scale free burn tests, the sprinklered tests had a main rack that included 16 battery modules. In addition, a target rack with 16 battery modules was placed to the left of the main rack to measure fire spread. The modules were placed 0.9 m (3 ft) away from the faux corner and walls. Overall 56 thermocouples, 4 heat flux gauges and 4 radiometers were used to collect data, in addition there were over 180 ceiling level instruments to measure gas temperature, velocity, and sprinkler operation times. Refer to Figure 10 and Figure 11 to see the test set up and placement of data collection equipment. More information can be found in the FM Global report.

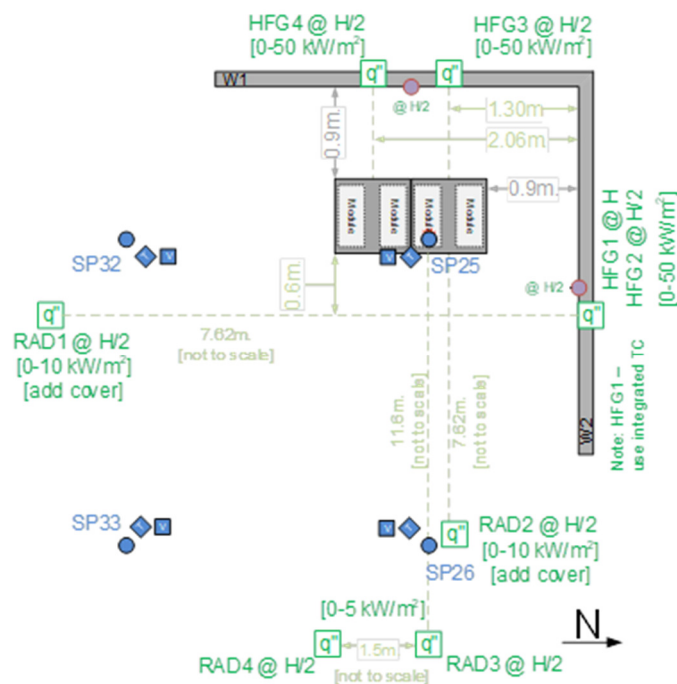

Figure 10. Large-scale sprinklered test set up. Courtesy of FM Global.

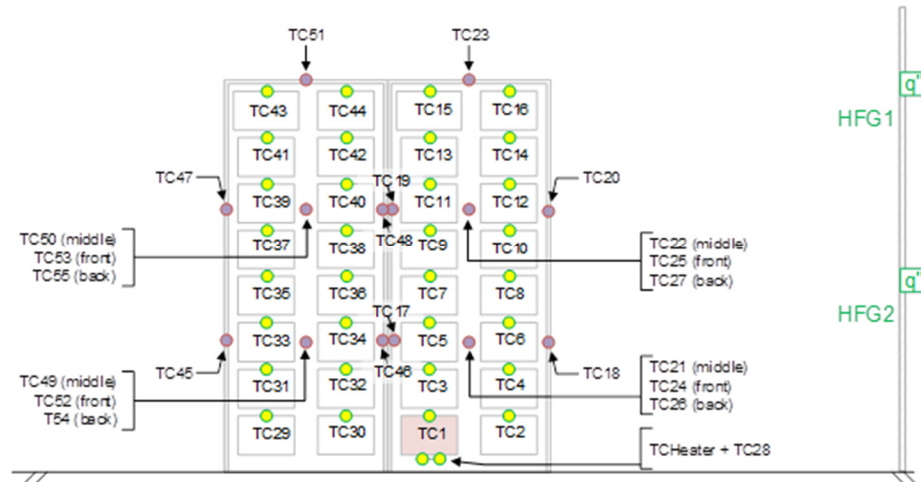

Figure 11. Large-scale sprinklered test set up. Courtesy of FM Global.

7.1.1 Sprinkler layout

For the sprinkler tests, water charged sprinklers were used that matched the qualities used in the sprinkler prediction calculations. The sprinklers used were K81 L/min/bar^{1/2} (K5.6 gpm/psi^{1/2}), QR, nominal 74°C (165°F) temperature rated sprinklers. Using a worst case scenario design, the sprinklers were installed with 3 m x 3 m (10 ft x 10 ft) spacing and the sprinkler link was located 0.3 meters (1 ft) below the ceiling. The design area included 49 sprinklers, 4 were active and could produce water if activated, the remaining 45 were used to indicate operation without discharging water.

7.2 Large-Scale Sprinklered Test Results

Both the LFP and LNO/LMO tests show that ceiling-level sprinkler protection can reduce the overall fire intensity but does not adequately cool the modules within the rack to suppress the fire. Within the sprinklered tests, both the module and rack temperatures were recorded and compared. For both the LFP and LNO/LMO module rack tests, the modules were consistent with the other tests recording peak temperatures in the range of 400-600°C (750-1,110°F). Separately, the racks recorded higher temperatures. During the LNO/LMO test, the rack temperatures peaked in the range of 800-900°C (1,470-1,650°F) and the LFP rack exceeded 900°C (1,650°F) in some locations. The lower temperature in the modules could be a result of minimal open space between the modules. Overall, the LFP module was controlled by a single sprinkler and did not

spread to the target racks (See Figure 12). The LNO/LMO modules activated four sprinklers which were unable to prevent the spread and reignition of the target racks after the sprinklers were shut off (See Figure 13).

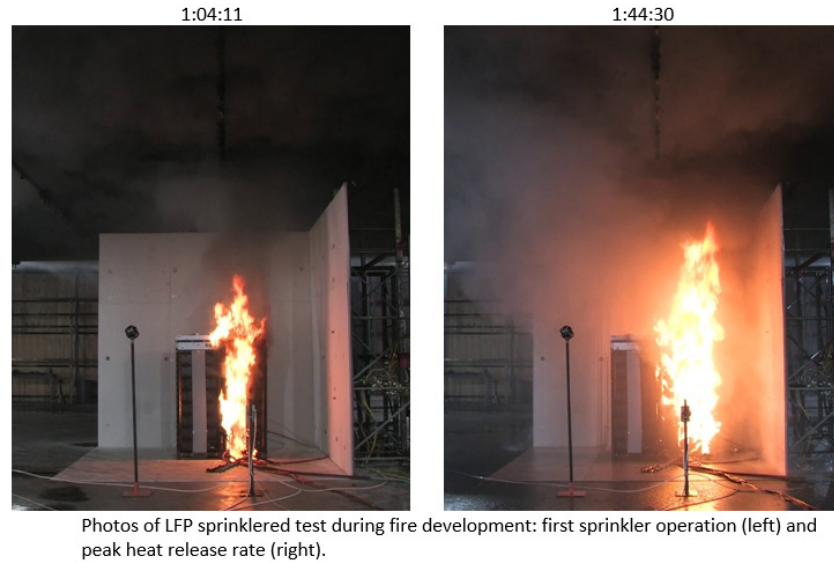

Figure 12. LFP fire development during large-scale sprinklered test. Courtesy of FM Global.

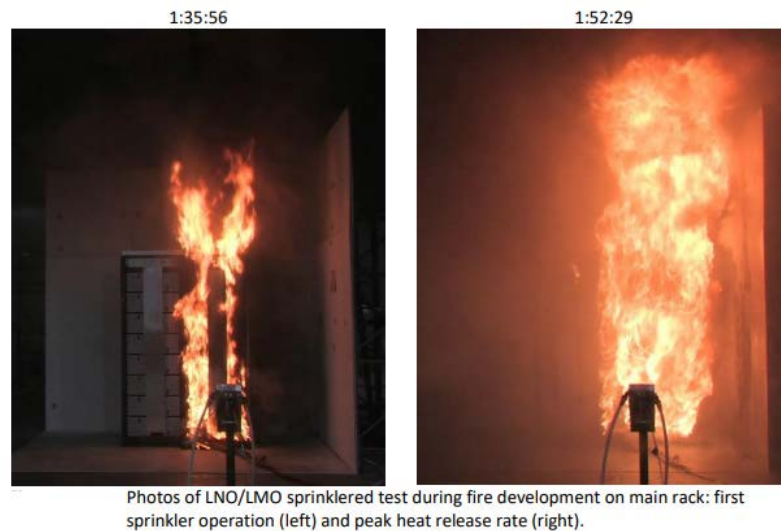

Figure 13. LNO/LMO fire development during large-scale sprinklered test. Courtesy of FM Global.

In the LFP module rack test, the first flames were observed around 2,400 seconds and a single sprinkler operated at 3,667 seconds. After sprinkler operation, the HRR of the main rack

continued to increase until reaching a peak of 1,880 kW around 5,520 seconds. After reaching the peak, the HRR fell until the instruments failed around 7,200 seconds. The target rack was never involved in the fire and no HRR was recorded from the target racks. Full HRR curves can be seen in Figure 14.

The LNO/LMO modules and fire development behaved differently. The first flames were observed around 5,040 seconds and a single sprinkler activated at time 5,756 seconds, followed by three other active sprinklers and 36 indication sprinklers. The sprinklers were allowed to operate until 9,000 seconds and in that time the HRR of the main rack peaked at 6,690 kW. After the peak, the HRR fell and the sprinklers were turned off once no flames were observed. Once the smoke cleared the lab, small flames were observed in the target rack. Around time 11,160 seconds the HRR of the target rack began to increase and peaked reaching 4,900 kW, once the rack was fully involved the sprinklers were turned back on at 11,520 seconds. After the sprinklers were turned back on, the HRR dropped to around 1,000 kW before increasing to over 4,000 kW. With the use of sprinklers and a manual hose the fire was eventually extinguished. Full HRR curves can be seen in Figure 15.

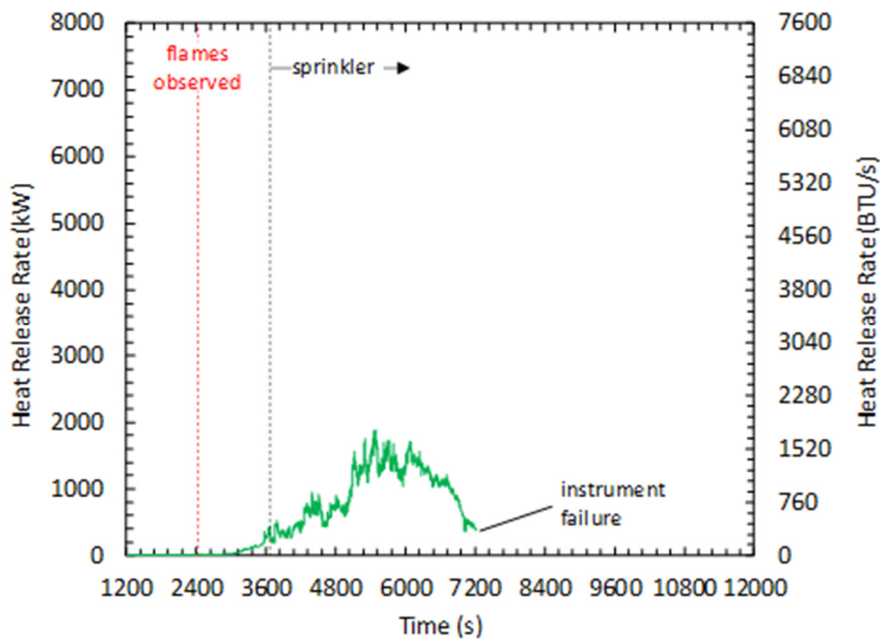

Figure 14. LFP large-scale sprinklered test HRR curve. Courtesy of FM Global.

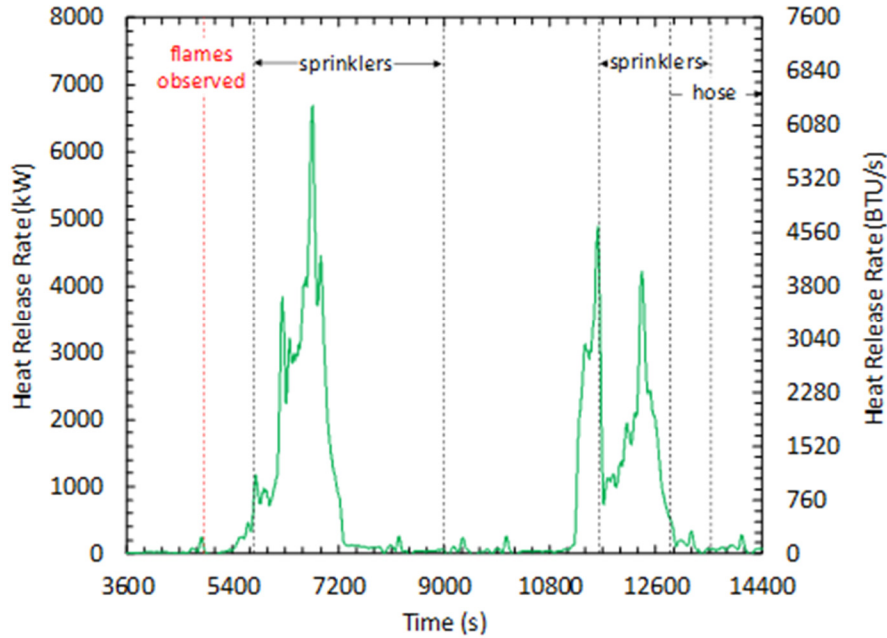
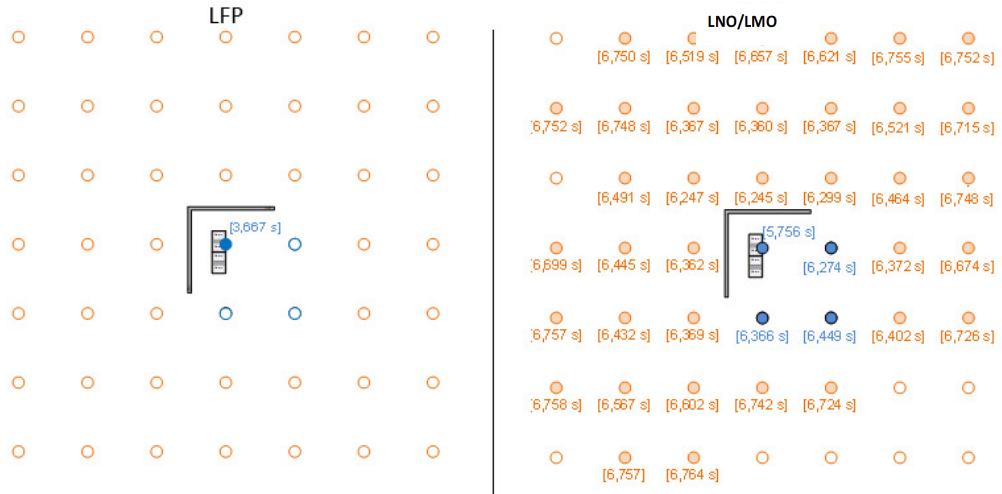

Figure 15. LNO/LMO large-scale sprinklered test HRR curve. Courtesy of FM Global.

7.2.1 Sprinkler Performance

Figure 16 depicts the activation of sprinklers and the time of operation. As mentioned above, during the LFP test a single sprinkler operated at 3,667 seconds and was able to contain the fire to the main rack and stop the spread to the target rack. The LNO/LMO test resulted in the operation of 4 active sprinklers and 36 indicator sprinklers. The first sprinkler in the LNO/LMO test operated at 5,756 seconds. The three other active sprinklers operated between 6,274-6,449 seconds, and the indicator sprinklers operated between 6,245-6,764 seconds. The LNO/LMO fire was able to activate sprinklers on the perimeter of the 230 m² (2,500 ft²) design area which indicates if a fire were to occur in a non-enclosed area it is possible a larger water area would be necessary to control the fire.



Sprinkler operation overview for LFP (left) and LNO/LMO (right) tests. Sprinklers that operated are shown as solid circles. Blue circles represent active sprinklers that could discharge water and orange circles represent indicator sprinklers that could not.

Figure 16. Sprinkler layout and operation overview for LFP (left) and LNO/LMO (right). Courtesy of FM Global.

8 Applications to Sprinkler Protection Guidance

Large-scale tests have shown sprinklers can control fire spread and reduce the hazard of an ESS fire. For the tests performed, the overall hazard of an ESS fire in a commercial occupancy was assessed by the reduction of fire intensity, potential for damage to the surroundings, and containment of the fire in the origin rack. As seen in the above-mentioned tests, HRR is a suitable way to measure the hazard of an unprotected fire. By using far field heat flux gauge values, it is possible to compare the results from the large-scale free burn and sprinklered tests. The sprinklers made an impact in the HRR of both LFP and LNO/LMO modules as seen in Figure 17. In Figure 17, times were offset to align data for comparison. During the sprinklered test, the LFP modules peak HRR decreased 45% and the LNO/LMO modules peak HRR decreased 34%.

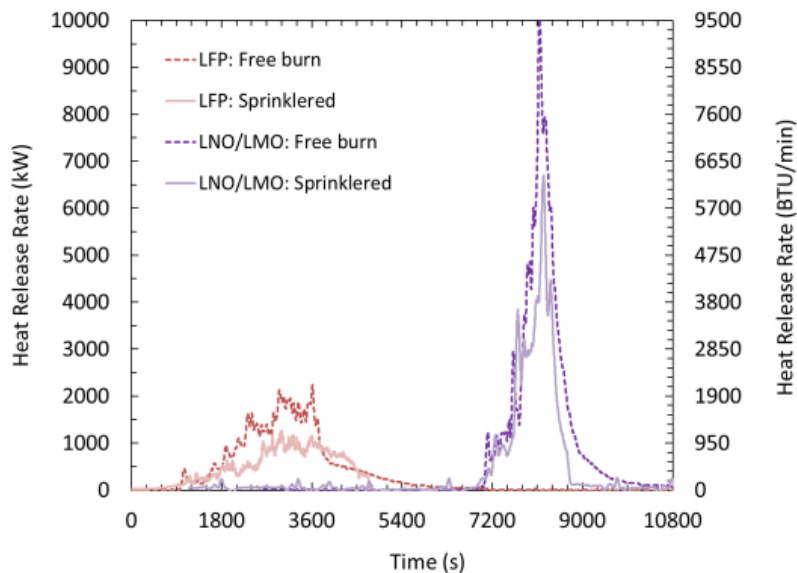

Figure 17. LFP and LNO/LMO free burn and sprinklered HRR comparison. Courtesy of FM Global.

From this data, ceiling sprinkler protection can control an ESS fire, but alone is not sufficient to fully extinguish an ESS fire. One method to aid the sprinkler in ESS protection is the application of physical thermal barriers or clearance space. Separating module racks from each other and from combustible and non-combustible materials can reduce and even prevent fire spread. Looking at the heat flux data from both free burn and sprinklered large-scale tests, the distance thresholds were determined for combustible and non-combustible materials (See Figure

18). Overall the LNO/LMO modules require a larger separation distance, but it is evident that sprinklers make a difference in the distance required.

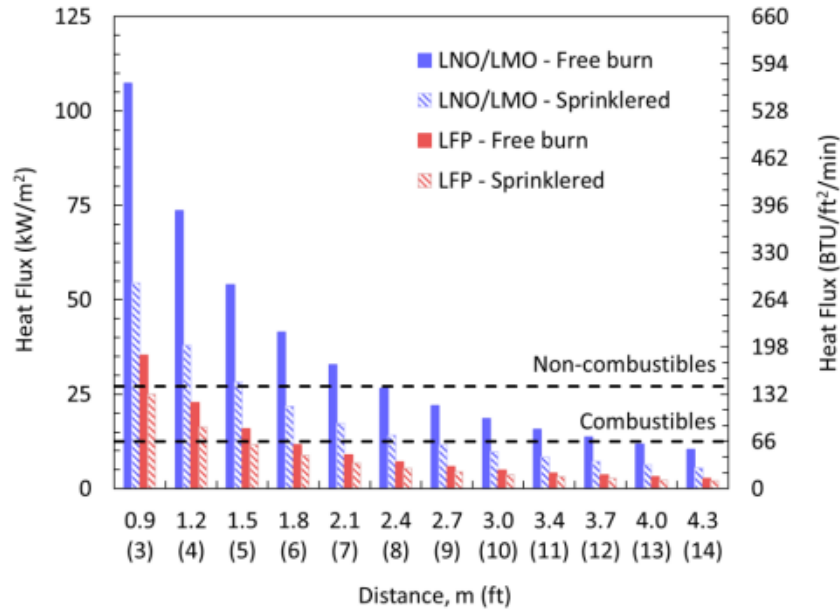

Figure 18. LFP and LNO/LMO free burn and sprinklered threshold comparison. Courtesy of FM Global.

With sprinkler protection, the LFP modules can be located 0.9 m (3 ft) meters from non-combustible materials and 1.5 m (5 ft) from combustible materials. The LNO/LMO modules would have to be located 1.8 m (6 ft) from non-combustible materials and 2.7 m (9 ft) from combustible materials to be considered safely separated. In addition to test data, FM Global Property Loss Data Sheet 1-20 (DS 1-20) Protection Against Exterior Fire Exposure [10] and NFPA 80A Recommended Practice for Protection of Buildings from Exterior Fire Exposures both provide guidance on separation distance and were the sources for the combustible and non-combustible threshold values. [11]

Another factor that was considered during the tests was the effect of ceiling height. If there is not enough distance between the top of a rack and the ceiling it can allow for flame impingement or collection of hot gases at the ceiling. Documents DS 1-20 and NFPA 5000, Building Construction and Safety Code [12] recommend that ceilings in the range of 3 m (10 ft) to 7.6 m (25 ft) should have a 1-hour fire rating. The fire rating on the ceiling can help reduce

and prevent damage, in the same manner thermal barriers such as spray-on foams and fire rated barriers can reduce the damage potential.

In addition to structural factors and surrounding materials, the configuration of the module racks can greatly affect the fire spread and hazard. Configurations can vary greatly, but there are three primary configurations used when multiple racks are stored in the same area (See Figure 19). The configurations include a) separate non-combustible cabinets, b) multiple racks together but separated by non-combustible cabinets, or c) a shared non-combustible cabinet housing multiple racks.

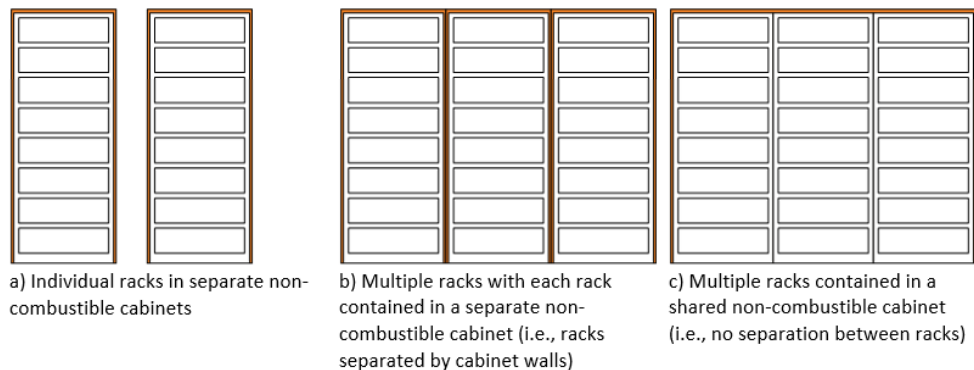

Figure 19. Diagram of three primary rack configurations. Courtesy of FM Global.

The configuration best for a certain ESS depends on which batteries are used. The LFP modules could use both configuration “a” and “b” and disregard the suggested separation distance because the fire did not spread from the origin rack in the sprinklered tests. The LNO/LMO modules could use configuration “a” and “b” as well but would need to adhere to the separation distance requirements to avoid fire spread from one rack to the next. For both LFP and LNO/LMO, multiple rack installations as described in configuration “c” is beyond the scope of this project.

Sprinkler systems can assist with reducing the fire hazard of an ESS if designed properly. Critical factors when designing a sprinkler system include, water demand, the number of sprinklers expected to operate, and the duration of the fire event. The water demand is typically calculated based on the number of sprinklers needed to provide adequate protection during a large-scale fire plus a safety factor of 50%. The large-scale testing performed used the common

criterion of an area of 3 m x 3 m (10 ft x 10 ft) and less than 16 sprinklers operating. In the LFP modules test a single sprinkler operated and the temperature and fire spread were controlled meaning the protection was acceptable. The LNO/LMO module test had multiple sprinklers activate and represented a demand area of over 230 m² (2,500 ft²). The larger demand area and observed fire spread among side-by-side racks deems it reasonable to base the sprinkler demand area on the entire room being protected. For a fire that did not spread to other racks such as with the LFP modules, the time of the fire plus a safety factor can be used as the basis for time of water duration. For the LNO/LMO modules, the observed fire spread makes it necessary to multiply the fire duration of the first rack by the number of adjacent racks in the total configuration.

The design considerations and requirements above can be helpful when developing a fire protection system for an ESS, but the type of battery being stored is important to consider. The batteries tested for this research had similar construction but diverse chemistries which created different results and hazards. Beyond what was tested, the effects of rack design, construction materials, and battery specific features and chemistries are not widely known. A different rack design could reduce or increase the hazard of either battery type. Given the lack of information known, it is not possible to apply the results of the LFP and LNO/LMO battery tests to other batteries or systems that are different. Large-scale testing would be necessary when there is a question on the impact a design change would have on the system hazard.

9 Conclusions

Small- to large-scale free burn tests and a large-scale sprinklered test were conducted on two different types of lithium-ion battery energy storage systems, lithium iron phosphate (LFP) and lithium nickel oxide (LNO) and lithium manganese oxide (LMO). The tests were conducted to evaluate the impact of installation in regard to proximity of combustible and non-combustible material objects and the performance of sprinkler protection common to commercial facilities where ESS are installed.

Every test level showed for both battery chemistries that ignition of a single module was sufficient to involve all modules within the rack tested. Comparing the two battery types, all stages of testing showed the LFP modules presented a lower fire hazard risk than the LNO/LMO modules. During the LFP test, a single sprinkler operated and was able to control the fire spread to the origin rack. In the LNO/LMO test, multiple sprinklers activated resulting in a demand area of over 230 m² (2,500 ft²), and the fire spread from the origin rack to the target rack.

Based on the experimental results, the following conclusions were made:

1. The ESS comprised of LFP batteries under a 4.6 m (15 ft) ceiling was adequately protected by the target sprinkler protection. The water supply should be based on a minimum 230 m² (2,500 ft²) demand area with a duration of at least 90 minutes. The conclusions are based on a single sprinkler operation controlling the fire to the rack of origin with no involvement of the target rack.
2. The ESS comprised of LNO/LMO batteries under a 4.6 m (15 ft) ceiling can be adequately protected by the target sprinkler protection. However, excessive ceiling sprinklers operated during the test conservatively representing a demand area > 230 m² (2,500 ft²). In addition, fire spread from the origin rack to the adjacent target rack indicating that ESS racks installed side-by-side in a row could eventually be involved in the fire.
3. Large-scale free burn tests as described in Section 6.1 of the FM Global report are recommended to determine adequate space separation distances to prevent fire spread to nearby combustibles or damage to non-combustibles when sprinkler protection is not

provided. Large-scale free burn testing is also necessary whenever there is doubt regarding the potential impact a change in an ESS design feature may have on the system hazard.

4. Large-scale sprinklered tests as described in Section 6.2 of the FM Global report are recommended to determine adequate space separation distances to prevent fire spread to nearby combustibles or damage to non-combustibles, as well as sprinkler protection design including discharge density/area and water supply duration.

Other ESS's representing a hazard outside the above listed conditions, including design features, installation arrangement, and power rating, may require a more robust protection scheme to account for unknowns that can negatively affect protection system effectiveness. Additional large-scale sprinklered fire tests are necessary to establish a protection scheme that can adequately protect buildings and surroundings.

A fire watch should be present until all potentially damaged ESS equipment containing lithium-ion batteries is removed from the area following a fire event. Fires involving lithium-ion batteries are known to reignite. Lithium-ion batteries involved in fires should be adequately cooled in order to prevent reignition. This project has not addressed explosions hazards or any mitigation strategies that may be necessary during an ESS fire event, or firefighting efforts.

The data collected indicates that ESS fires will require lengthy hose stream water durations for final extinguishment. The geometry and installation arrangement of ESS's will affect hose stream water demand and duration potentially beyond/exceeding traditional code requirements for hose streams. At this time, the data does not allow for the further guidance on expected values for water demands for hose streams. While manual firefighting tactics are beyond the scope of the project, firefighting personnel or others considering utilizing manual hose streams on ESS fires should proceed with caution given the concerns associated with off-gassing/venting and potential explosion hazards, as well as exposure conditions.

10 Recommendations

General protection recommendations for lithium-ion battery based ESS located in commercial occupancies were developed through fire testing. The following recommendations are derived from the results of the specific tests discussed in this report and the FM Global report:

For the tested LFP system:

- Without fire protection, the minimum space separation from any part of the ESS is 1.2 m (4 ft) from non-combustible objects and 1.8 m (6 ft) from combustible objects.
- With sprinkler protection, the minimum space separation from any part of the ESS is 0.9 m (3 ft) from non-combustible objects and 1.5 m (5 ft) from combustible objects. The sprinkler system water supply should be designed for a minimum 230 m² (2,500 ft²) demand area and a duration of at least 90 minutes.

For the tested LNO/LMO system:

- Without fire protection, the minimum space separation from any part of the ESS is 2.4 m (8 ft) from non-combustible objects and 4.0 m (13 ft) from combustible objects.
- With sprinkler protection, the minimum space separation from any part of the ESS is 1.8 m (6 ft) from non-combustible objects and 2.7 m (9 ft) from combustible objects. The sprinkler system water supply should be designed for the total room area where the ESS is located, and the water supply should be calculated as 45 minutes times the number of adjacent racks.

11 Possible Future Work

The following possible future work is suggested to further understand protection requirements for Energy Storage Systems:

- Investigate and provide guidance on the effectiveness of different thermal barriers installed between adjacent ESS racks to reduce the risk of fire spread.
- Determine the fire hazard and sprinkler protection criteria for ESS multiple rack installations.
- Conduct additional sprinklered fire testing to reduce the sprinkler demand, area, water duration, and separation distances.
- Conduct additional sprinklered fire testing to evaluate the design of rack enclosures, materials of construction, and its effect on fire development and effectiveness of sprinkler protection.
- Conduct additional sprinklered fire testing to evaluate the relationship between fire hazard and variables such as battery or module design, including chemistries, capacities, and/or format.
- Conduct full-scale testing to evaluate durations and flows associated with hose stream use as well as potential hazards for firefighting personnel utilizing manual hose streams as well as any potential environmental concerns associated with water runoff.
- Consider testing with sprinklers protecting the modules in a configuration as in “in rack sprinkler protection” for rack storage.

12 Acknowledgements

The authors would like to thank Benjamin Ditch and the entire FM Global Research campus crew for their significant efforts in setting up, instrumenting, and conducting the fire and sprinkler tests and providing access to the data and analysis gathered during the testing.

The Foundation expresses gratitude to NEC Energy Solutions, Inc. and Retrieval Technologies for their donations to support the project.

11 References

- [1] B. Ditch, D. Zeng, "Development of Sprinkler Protection Guidance for Lithium Ion based Energy Storage Systems" FM Global Technical Report March 2019.
- [2] J. Lamb, C. J. Orendorff, L. A. Steele, and S. W. Spangler, "Failure propagation in multi-cell lithium ion batteries," Journal of Power Sources, vol. 283, pp. 517-523, June 2015. DOI: 10.1016/j.jpowsour.2014.10.081.
- [3] H. Webster. (May, 2012, accessed 12-13-2018) Full Scale Battery Fire Test Plan Update. presentation. [Online]. <https://www.fire.tc.faa.gov/pdf/systems/May12Meeting/Webster-0512-FullScaleBatteryTestPlanUpdate.pdf>.
- [4] A. Blum and R. T. Long, "Hazard Assessment of Lithium Ion Battery Storage Systems," Final Report prepared for Fire Protection Research Foundation February, 2016.
- [5] DNV-GL, "Considerations for ESS Fire Safety," Consolidated Edison New York, NY, Final Report OAPUS301WIKO(PP151895), Rev. #, 2017.
- [6] B. Ditch, "Development of Protection Recommendations for Li-ion Battery Bulk Storage: Sprinklered Fire Test," FM Global, Technical Report 3053291, 2016.
- [7] National Fire Protection Association Standard 13, Standard for the Installation of Sprinkler Systems, 2010.
- [8] National Fire Protection Association Standard 855, Standard for the Installation of Stationary Energy Storage Systems, Proposed Standard, anticipate issuance in 2019.
- [9] FM Global Property Loss Prevention Data Sheets 5-33, Electrical Energy Storage, January 2017.
- [10] FM Global Property Loss Prevention Data Sheets 1-20, Protection Against Exterior Fire Exposure, Interim Revision, October 2016.
- [11] National Fire Protection Association Standard 80A, Recommended Practice for Protection of Buildings from Exterior Fire Exposures, 2017.
- [12] National Fire Protection Association Code 5000, Building Construction and Safety Code, 2018.