



NOVA CONTROLS
LEADING THE WAY
A Hydro Systems Company

SPRITE WAREWASH DISPENSING SYSTEM



Reference Manual DM-400 Series

Table of Contents

1 Description of Features	
Overview	1-1
2 Mechanical Installation	
Overview	2-1
Wall Mounting	2-2
Probe Mounting	2-2
Rinse Injection Fitting	2-3
Detergent Bulkhead Fitting	2-3
Rinse and Detergent Supply and Discharge Tubes	2-4
Solenoid Water Feed	2-4
3 Electrical Installation	
Overview	3-1
Probe Wiring	3-2
Electrical Connections	3-2
Main Power Wiring	3-3
115 VAC	3-3
208/240 VAC	3-3
230 VAC	3-3
Detergent Signal Wiring	3-3
Detergent Signal Wiring – Probe Mode	3-3
Detergent Signal Wiring – Probeless Mode	3-4
Rinse Signal Wiring	3-4
4 Description of Controls	
Overview	4-1
Key Description	4-1
5 User Mode Operation	
Overview	5-1
Display Indicators	5-1
User Mode Menus	5-2
Guide to Icons	5-2
Visual Alarm Displays	5-2
Rack Counter (Menu 11)	5-2
Detergent Prime (Menu 12)	5-3
Rinse Prime (Menu 13)	5-3
De-Lime (Menu 14)	5-3
Live Conductivity Display	5-3
Alarms (Probe Mode Only)	5-4
Low Detergent Alarm	5-4
Detergent Overfeed Stop Alarm	5-4
Manual Initial Charge	5-4
Password Access to Program Mode	5-4

6 Program Mode Operation

Overview	6-1
Program Mode Access	6-1
Configuration Settings	6-3
Detergent Control (Menu 21)	6-3
Machine Type (Menu 22)	6-3
Detergent Type (Menu 23.1)	6-4
Pulse Feed – Capsule Detergent Only (Menu 23.2)	6-4
Alarm Volume (Menu 24)	6-4
Rack Time in Rinse (Menu 25)	6-4
Initial Charge - Probeless Only (Menu 26)	6-5
Manual Initial Charge	6-5
Automatic Initial Charge	6-5
Change Installer Password (Menu 27)	6-5
Demo Mode (Menu 28)	6-5
Adjustments—Probe Mode (Menu 3)	6-6
Detergent Tank Reading (Menu 31)	6-6
Detergent Set Point (Menu 32.1)	6-6
Live Conductivity Display (Menu 32.2)	6-7
Rinse Pump Speed (Menu 33)	6-7
Low Detergent Alarm Delay (Menu 34)	6-7
Rinse Feed Option (Menu 35)	6-7
Rinse Delay Time (Menu 36)	6-8
Adjustments—Probeless Mode (Menu 4)	6-8
Detergent Initial Charge (Menu 41)	6-9
Detergent Dose (Menu 42)	6-9
Detergent Dose Interval (Menu 43)	6-9
Rinse Pump Speed (Menu 44)	6-10
Rinse Feed Option (Menu 45)	6-10
Rinse Delay Time (Menu 46)	6-10

7 Troubleshooting

Overview	7-1
Alarms and Indicators	7-1
Preliminary Checks	7-1
Dead Unit (No Display)	7-1
No Detergent Feed	7-2
Excess Detergent Consumption	7-2
No Rinse Feed	7-2

8 Maintenance and Service

Overview	8-1
Maintenance	8-1
Pump Tube Replacement	8-1
Service Disassembly	8-2
Spare Parts	8-3

9 Specifications

Limited Warranty	9-2
Limitation of Liability	9-2

Index

Description of Features

Overview

This chapter describes the features of the Sprite Warewash Dispensing System.

Advanced Design

The SPRITE uses miniaturized electronics to provide powerful features in a small package. A digital readout allows simple, three-button programming of all options.

Reliability

The gasket-enclosed SPRITE Warewash Dispenser is highly water resistant and the electronics are further protected within the enclosure. The readout gives confirmation of detergent and rinse feeds.

Versatility

The SPRITE can be configured as a conductivity probe controlled unit or as a probeless, time-based dispenser. It can accept a 100-115VAC nominal to 200-249VAC nominal (+/- 10% fluctuation) main power input at 50 or 60 Hz. Rinse and Detergent control signals are universal “machine interface” types that are capable of accepting any voltage from 24 to 240 VAC nominal (+/- 10% fluctuation) or 24 VDC (+/- 20% fluctuation). SPRITE can control either capsule or liquid detergents.

Cost Savings

A special Rinse Saver Feature prevents rinse additive waste during fills of the washer. Digital electronics ensure accurate detergent control and minimize overuse.

Intelligence

The SPRITE includes a rack counter as a “standard” feature. A unique “De-Lime” mode allows for safe washer cleaning without detergent waste.

Choice of Options

A full range of programmable options are included, such as rinse delay, variable alarm volume, and manual prime for both rinse and detergent.

Easy Service/Repair

The SPRITE features convenient front access for all servicing. No internal access to the cabinet is required for installation and routine maintenance. In the unlikely event that repairs are required, spare parts are available in modular form for fast and convenient service.

Mechanical Installation

Overview

This chapter describes the hardware installation of the Sprite. In this chapter, you will:

- Wall-mount the Sprite
- Mount and Install Probe (if applicable)
- Mount and Install Rinse Injection Fitting
- Mount and Install Detergent Bulkhead Fitting
- Install Rinse and Detergent Supply and Discharge Tubes
- Install Solenoid (if applicable)

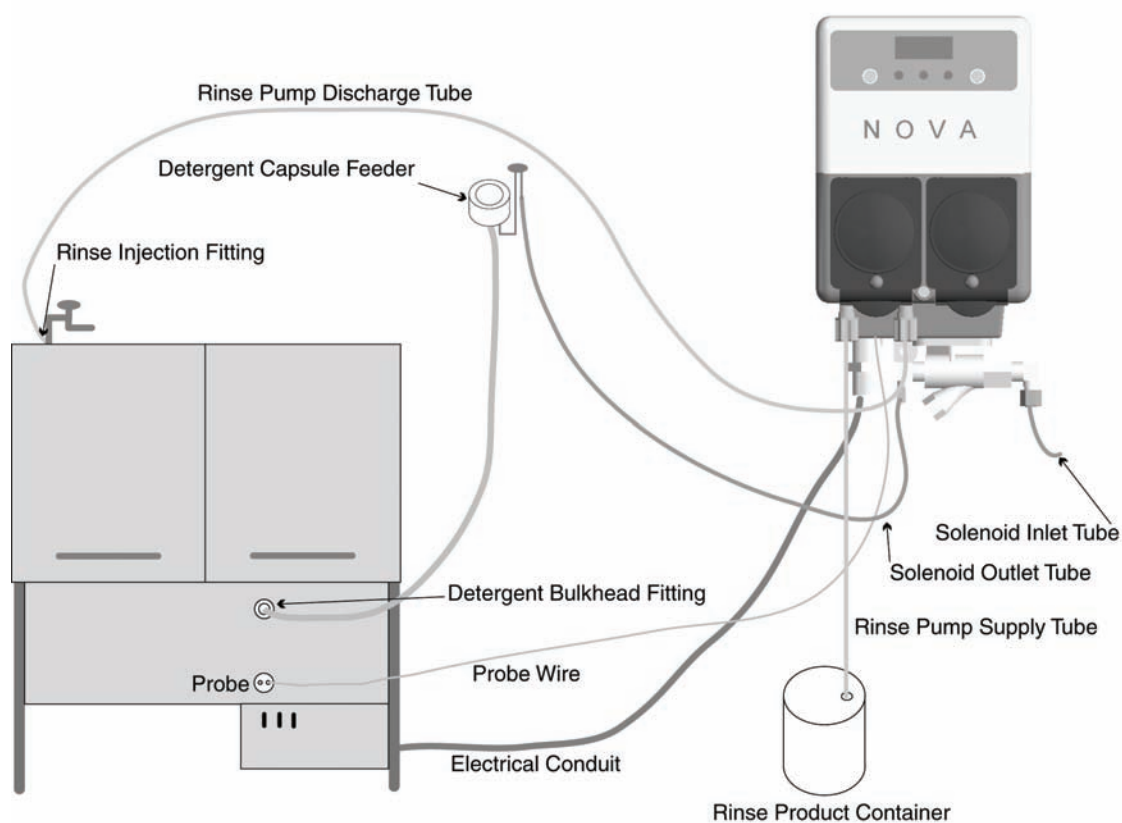



Figure 2-1 System Diagram

Wall Mounting

Warning 	The Sprite dispensing system is intended to be installed by experienced installers, in accordance with all applicable electrical and plumbing codes. All dish machine and dispenser power must be disconnected during installation and/or any time the dispenser cabinet is opened.
---	---

Choose an installation location that is:

- Close to the product containers.
 - At a reasonable height for easy maintenance access.
 - Away from any direct sources of steam, water spray, and high temperatures.
 - Close enough to the dish machine electrical control panel to allow dispenser wiring without use of an external junction box (not provided) wherever possible.
1. Using mounting bracket as a template, mark holes to drill into mounting surface. For sheet metal mounting with screws and nuts, drill 1/4" (6 mm) holes. For wall anchors, drill holes as appropriate for anchors used.
 2. Attach mounting bracket to mounting surface with hardware provided.
 3. Hang unit on bracket. Optional: Drill hole and attach lower mounting hole to mounting surface.

Mounting Bracket



Back of Unit

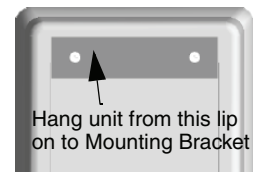

Figure 2-2 Mounting Bracket

Probe Mounting (Probe Operation Only)

The probe senses the detergent concentration. Correct probe placement is critical for accurate detergent concentration control. Always use the new probe provided with the dispenser.

When choosing a mounting location, make sure that the probe will be completely immersed in the wash tank solution, in an area that has a good flow of solution, and close to the product entry point.

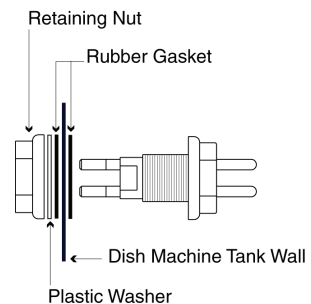



Figure 2-3 Probe Mounting

Many dish machines will have knockouts provided for probe installation and/or will have existing probes. Previously punched probe holes may be suitable, but always confirm that the probe will be immersed in the wash tank solution before installing. The following steps describe probe installation.

If a probe hole is present, skip to Step 2.

1. Drill a 3/8" hole in the center of the probe location. Use a Greenlee (or similar) 7/8" hole punch to cut the final hole.
2. Remove the probe retaining nut.
3. From inside the dish machine tank wall, insert probe (with rubber gasket) into hole.
4. From outside the dish machine tank wall, install second rubber gasket, plastic washer and probe retaining nut. Tighten finger-tight only.

Warning 	Do not over-tighten the retaining nut!
---	--

Rinse Injection Fitting

Install the rinse injection fitting at least 6" below the dish machine rinse plumbing vacuum breaker to conform to plumbing codes. The injection fitting threads into 1/8" NPT female threads. If the dish machine rinse plumbing is thin-wall pipe, use a saddle clamp with a 1/8" NPT threaded hole. If an optional pressure switch will be used, thread the injection fitting into one side of the pressure switch water source fitting pipe tee. **If the machine already has a tapped hole to accommodate the fitting, skip to Step 3.**

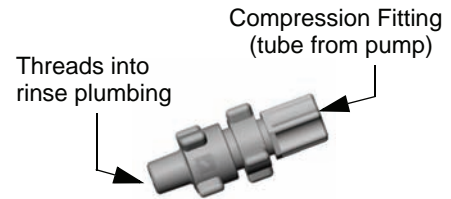



Figure 2-4 Rinse Injection Fitting

Choose a location for the rinse injection fitting that is at least 6" downstream from the solenoid valve and vacuum breaker. On continuous rack, flight, or conveyor machines, be sure this location is downstream from any rinse makeup water.

1. Drill a 7/32" hole in the rinse plumbing injection location.
2. Tap the hole drilled in Step 1 with a 1/8" NPT tap.
3. Install the injection fitting. Use thread sealant to ensure a leak-free assembly.

Detergent Bulkhead Fitting (Liquid Detergent Only)

Caution 	Follow the instructions provided with your solid, powder, or slurry feed system for solenoid equipped units instead of using the following section.
--	---

Correct placement of the detergent bulkhead fitting is critical for accurate detergent concentration control (in probe mode only). When choosing a mounting locating, make sure that the detergent bulkhead fitting is:

- Above the water line in the tank.
- Close to the probe location (when possible).
- Discharging detergent directly into the wash tank and not on top of any shelf areas or other obstacles that could prevent detergent from falling directly into the wash tank.

Previously punched holes may be suitable, but always confirm that the fitting is correctly placed.

If a hole is present, skip to Step 2.

1. Drill a 3/8" hole in the center of the detergent inlet location. Use a Greenlee (or similar) 7/8" hole punch to cut the final hole.
2. Remove the detergent bulkhead fitting retaining nut.
3. From inside the machine, insert detergent bulkhead fitting (with rubber gasket) into hole.
4. From outside the machine, install second rubber gasket, plastic washer and plastic retaining nut. Tighten finger-tight only.

CAUTION: Do not over-tighten the retaining nut.

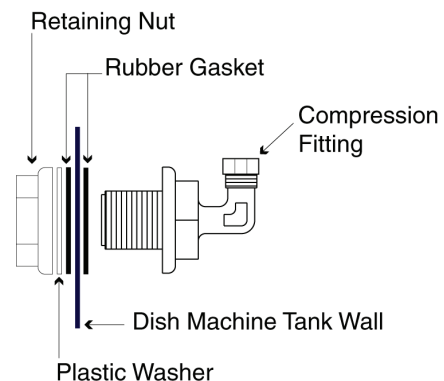



Figure 2-5 Detergent Bulkhead Fitting

Rinse and Detergent Supply and Discharge Tubes

Note 	Supply and discharge tubes are not included with the standard unit.
--	---

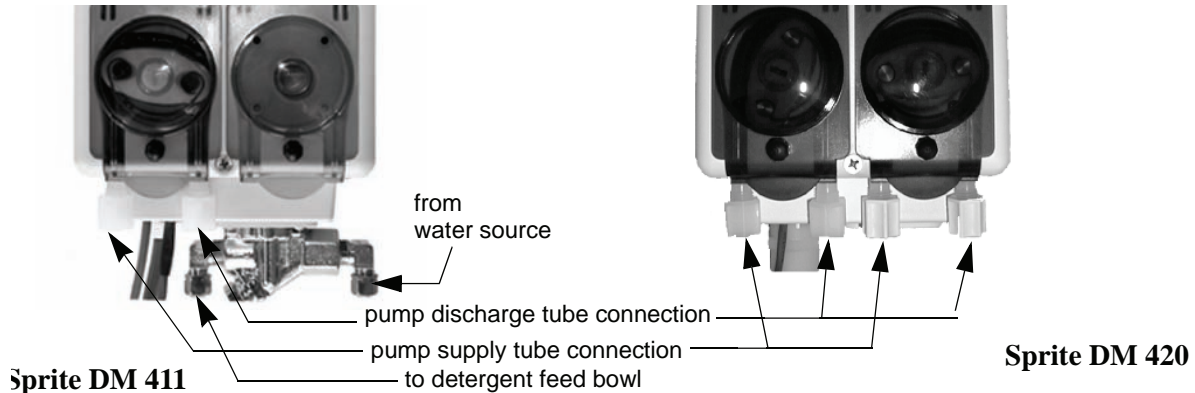

Figure 2-6 Dispensing System

1. Route pump supply tubes from supply containers to the inlet sides (left) of each respective pump. Slip the tube through the compression nut into fitting and tighten.
2. Route pump discharge tubes to the outlet sides (right) of each respective pump. Slip the tube through compression nut into fitting and tighten.
3. Route other end of rinse pump discharge tube to rinse injection fitting installed in “*Rinse Injection Fitting*” on page 2-3. Slip the tube through compression nut into fitting and tighten.
4. Route other end of detergent pump discharge tube to the detergent bulkhead fitting (installed in “*Detergent Bulkhead Fitting*” on page 2-3). Slip tube through compression nut into fitting and tighten.

Solenoid Water Feed

(Solenoid Equipped Units Only)

If you are using a solid, powder or slurry feed system, you will need a water source for the dispenser solenoid valve. This water supply may be hot or cold but, for safety reasons, should not come from the boosted temperature rinse water line on high temperature dish machines.

The dispenser solenoid valve fittings are 1/4" (6mm) compression. Typically, a saddle clamp is used for the solenoid valve water source. If the plumbing is steel or brass, drill a 7/32" hole and tap for 1/8" NPT threads.

Caution 	If the water source is hot, use only copper tubing; DO NOT use poly tubing.
---	---

1. Install petcock valve to water source plumbing. Connect 1/4" copper or plastic tube to the valve.
2. Route tube to dispenser solenoid valve. Slide tube into water inlet side compression fitting and tighten.
3. Connect another 1/4" tube to the outlet side of the dispenser solenoid valve and route to the water inlet connection for the feed system.
4. Confirm that all compression fittings are tight.
5. Be sure to turn on water source valve prior to adjusting dispenser settings.

Electrical Installation

Overview

This chapter describes the electrical connections of the Sprite. In this chapter, you will connect:

- Probe Wiring
- Electrical Connections
- Main Power Wiring
- Detergent Signal Wiring (Probe and Probeless modes)
- Rinse Signal Wiring

<p>Note</p> 	<p>All electrical connections (except the probe) must be in either the dish machine control circuit panel or an external junction box.</p> <p>The dispenser is pre-wired with a multi-conductor electrical cable that must be run through a conduit to the location where hard-wired connections are made on the dish machine.</p> <p>Use a 1/2" (13 mm) ID water tight conduit meeting all local and national codes. A conduit fitting is present on the bottom of the dispenser where the power cable exits.</p> <p>The probe wire is also pre-wired and should be routed to the probe location and cut to length if a probe is used.</p>
--	---

Probe Wiring

1. Route the probe wire to the probe location and cut to fit. If you need to extend the probe wire, use high quality, corrosion resistant (waterproof is best) butt splices with a good quality crimping tool.
2. Strip wire ends and crimp on the ring lugs provided.
3. Connect the ring lugs to the probe with nuts and star washers provided. Be sure that connections are tight and secure.

Electrical Connections

Table 3-1 90-130 VAC Main Power

Wire Colors	Circuit Voltage	Function
Gray/Violet	90-130 VAC 50/60 Hz	Main AC Power
Black	90-130 VAC 50/60 Hz	Main AC Power
Brown	No Connection - Insulate!	Warning - Live!
Yellow	24-249 VAC, +24 VDC	Detergent Signal
Yellow/White	24-249 VAC, -24 VDC	Detergent Signal
Violet	24-249 VAC, +24 VDC	Rinse Signal
White/Violet	24-249 VAC, -24 VDC	Rinse Signal

Table 3-2 200-249 VAC Main Power

Wire Colors	Circuit Voltage	Function
Gray/Violet	200-249 VAC 50/60 Hz	Main AC Power
Brown	200-249 VAC 50/60 Hz	Main AC Power
Black	No Connection - Insulate!	Warning - Live!
Yellow	24-249 VAC, +24 VDC	Detergent Signal
Yellow/White	24-249 VAC, -24 VDC	Detergent Signal
Violet	24-249 VAC, +24 VDC	Rinse Signal
White/Violet	24-249 VAC, -24 VDC	Rinse Signal

Table 3-3 230 VAC Main Power

Wire Colors	Circuit Voltage	Function
Lt. Blue	200-249 VAC 50/60 Hz	Main AC Power
Brown	200-249 VAC 50/60 Hz	Main AC Power
Yellow	24-249 VAC, +24 VDC	Detergent Signal
Yellow/White	24-249 VAC, -24 VDC	Detergent Signal
Violet	24-249 VAC, +24 VDC	Rinse Signal
White/Violet	24-249 VAC, -24 VDC	Rinse Signal

Main Power Wiring

115 VAC

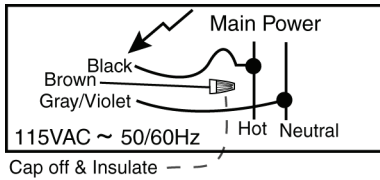

Connect the gray with violet stripe wire to the neutral source. Connect the black wire to the 115 line. Cap off and insulate the brown wire (Wire nut provided).

208/240 VAC

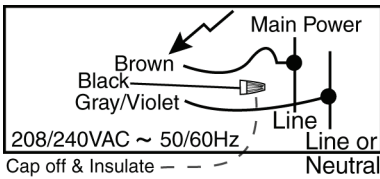

Connect the gray with violet stripe wire to one side of the voltage source. Connect the brown wire to the other line of the voltage source. Cap off and insulate the black wire (Wire nut provided).

230 VAC

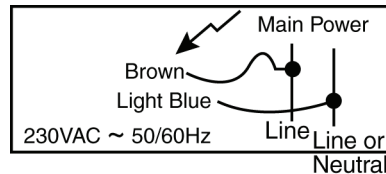

Connect the light blue wire to one side of the voltage source (Neutral, if available). Connect the brown wire to the other side of the voltage source.

Detergent Signal Wiring

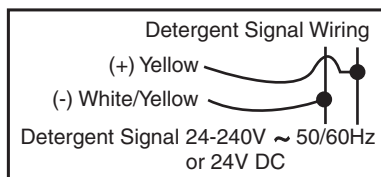

Figure 3-1 Detergent Signal Wiring Diagram—Probe or Probeless Mode

The detergent signal input is an optically isolated signal input that draws no more than 20 mA. It is a universal voltage input that accepts any voltage between 24 and 240 VAC nominal (+/- 10% fluctuation), or 24 VDC nominal (+/- 20% fluctuation).

Detergent Signal Wiring – Probe Mode

Typical wiring locations are dispenser detergent power source or the wash motor contacts in the dish machine control panel. This power source is on when the dishwasher is running the wash pump.

- Connect yellow (DC +) and white/yellow (DC -) colored wires to detergent power source.

Detergent Signal Wiring – Probeless Mode

On conveyor type dishwashers, the detergent signal must occur only once per dish machine fill/drain occurrence—beginning when the dish machine fills. Typical wiring locations are an “on light” or an electrical tank heat circuit between the tank heater switch and the thermostat. Each time this power source comes on, and stays on for 10 seconds, the dispenser will feed the detergent initial charge amount (with probeless and automatic initial charge modes set).

On door-type dishwashers, connect this signal input to the dispenser detergent power source or the wash motor contacts in the dish machine control panel. This power source is on when the dishwasher is running the wash pump.

- Connect yellow (DC +) and white/yellow (DC -) colored wires to initial charge power source.

Rinse Signal Wiring

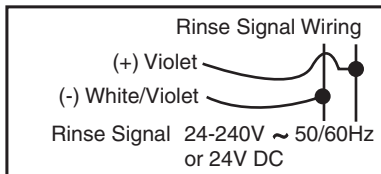



Figure 3-2 Rinse Signal Wiring Diagram

The rinse signal input is an optically isolated signal input that draws no more than 20 mA. It is a universal voltage input that accepts any voltage between 24 and 240 VAC nominal (+/- 10% fluctuation), or 24 VDC nominal (+/- 20% fluctuation). Typical wiring locations are dispenser rinse power source or the rinse solenoid valve circuit in the dish machine control panel. This power source is live whenever the dishwasher is rinsing. When no suitable rinse signal connection is available, an optional pressure switch may be used with a constant power source instead.

- Connect violet (DC +) and white/violet (DC -) colored wires to rinse power source (or constant power for pressure switch installations).

Probeless Mode Note 	Certain dishwasher designs require that the rinse aid be dispensed upon the detergent signal, rather than the rinse signal. In this case, you must still connect the rinse signal input to either the fill solenoid or the rinse solenoid circuit of the dishwasher to enable the automatic initial charge function in probeless mode.
---	--

Description of Controls

Overview

The Sprite makes use of only three buttons and a 3-digit LED display for all dispenser operation and programming.

Key Description

Use the menu screen illustrations as a guide when learning to program the Sprite. Use the Next key to move to all available main menu screens in Program mode.

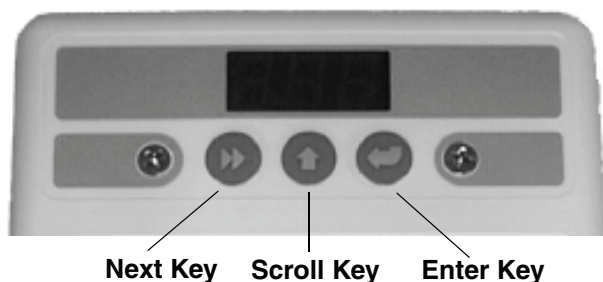

Next Key

Use the Next key to move to the next menu or task. The tasks under the Next key are:

- User Mode - Moves through User Mode menu screens.
- Program Mode - Moves through the Program Mode menu screens.
- Input Screens - Moves blinking digit to the right.

Scroll Key

Use the Scroll key to change the blinking digit's value. The tasks under the Scroll key are:

- User Mode - Changes the values of blinking digits. Activates Probeless Manual Initial Detergent Charge. See "*Manual Initial Charge*" on page 5-4.
- Program Mode - Changes value of blinking digits. Selects menu group.
- Input Screens - Changes value of blinking digits.

Enter Key

Use the Enter key to perform a task or set a value. The tasks under the Enter key are:

- User Mode - Starts and stops rinse pump and detergent prime. Accesses Password input screen (press and hold for two seconds). Performs actions as prompted in User Mode menu screens.
- Program Mode - Accesses all input screens from main menu loop (via Next key).
- Input Screens - Sets displayed value in all input screens (via Scroll key). Exits back to main menu.

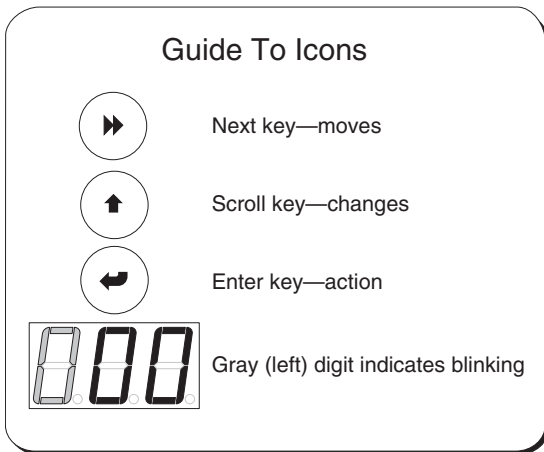

Figure 4-1 Guide to Icons

User Mode Operation

Overview

This chapter describes the features of User Mode operation. In this chapter, you will learn about:

- Display Indicators
- User Mode menus
 - Rack Counter
 - Detergent Prime
 - Rinse Prime
 - De-Lime
 - Live Conductivity Display
- Password Access to Program Mode
- Alarms (Probe Mode)
 - Low Detergent Alarm (Probe Mode)
 - Detergent Overfeed Stop Alarm (Probe Mode)
- Manual Initial Charge (Probeless Mode)

Display Indicators

In User Mode, the dispenser's operating status is indicated in the following displays (combinations of these displays occur during normal operation):

- Idle Home Screen (Center Digit): Dash in center digit indicates that power is on.
- Detergent Feed On (Right Digit): One segment continuously rotates clockwise.
- Rinse Pump On (Left Digit): One segment continuously rotates clockwise.
- Alarms (To see these alarms, go to “*Visual Alarm Displays*” on page 5-2):
 - Low Detergent Visual Alarm (Probe Mode Only): Bottom segments flash on all three digits.
 - Detergent Overfeed Stop Alarm: Bottom segments flash and the right digit displays a zero.

User Mode Menus

Press **NEXT** to access and move through the User Mode menu loop. The circular menu loop allows you to return to all screens. All menu screens are numeric; no text appears in any menu screens.

After 30 seconds of inactivity, User Mode automatically returns to either the home screen or, if Live Conductivity is enabled, User Mode returns to the Live Conductivity display.

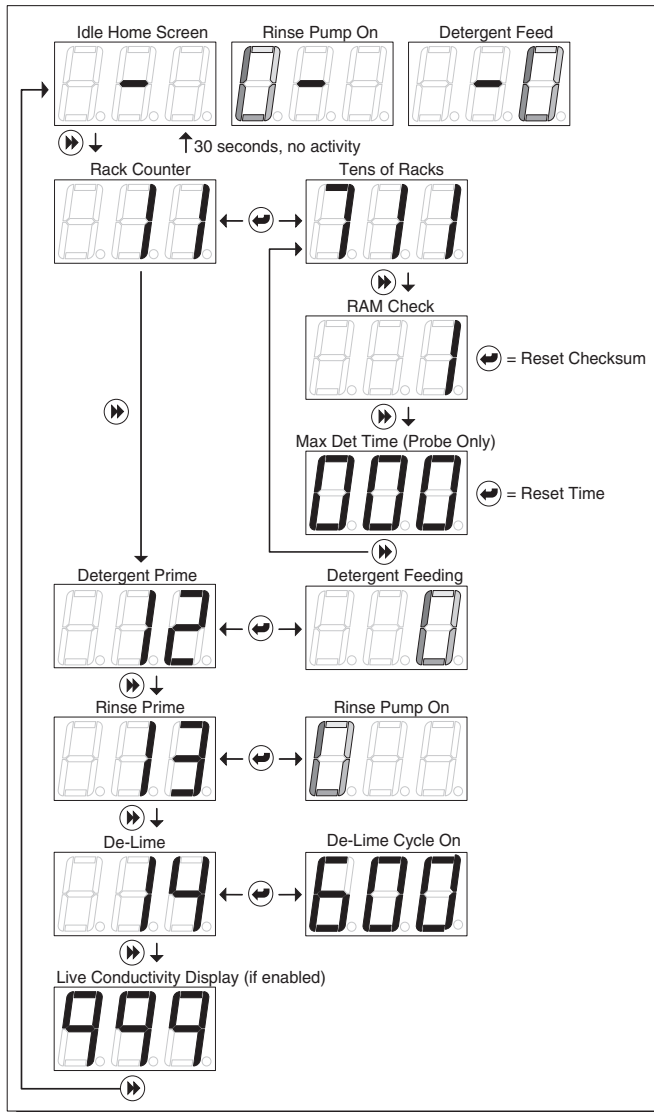

Visual Alarm Displays

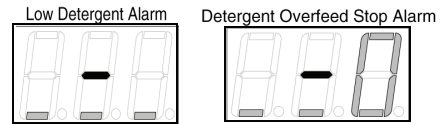

Guide to Icons

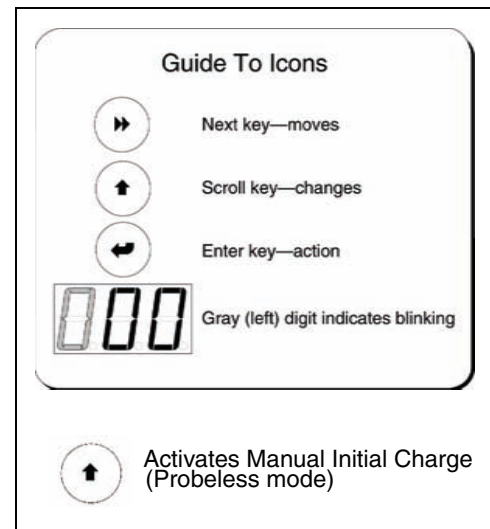

Figure 5-1 User Mode Menus and Displays

Rack Counter (Menu 11)

1. Press **NEXT** to display **11**.
2. Press **ENTER** to display racks washed. The rack counter counts by tens.
3. Press **ENTER** to return to the main menu loop, or wait 30 seconds for the display to automatically return to the home screen.

RAM Check and Max Det Time (Menu 11)

To access the system RAM check and “Max Det Time” screens:

1. From the rack counter screen, press **NEXT** once for RAM Check or twice for Max Det Time.
 - At the “Ram Check” screen, press **ENTER**. **1** will display if the RAM check is okay.
 - At the “Max Det Time” screen, press **ENTER** to display the longest amount of time that detergent feed has run to satisfy the set point (probe mode only). Make note of this time after a new installation. See “*Troubleshooting*” on page 7-1 for more information on using this feature.

Detergent Prime (Menu 12)

1. Press **NEXT** to display **12**.
2. Press **ENTER** to start detergent feed.
3. Press **ENTER** again to stop detergent feed and return to the main menu loop.

Note 	Prime functions automatically stop after 30 seconds.
--	--

Rinse Prime (Menu 13)

1. Press **NEXT** to display **13**.
2. Press **ENTER** to start the rinse pump.
3. Press **ENTER** again to stop the rinse pump and return to the main menu loop.

Note 	Prime functions automatically stop after 30 seconds.
--	--

De-Lime (Menu 14)

1. Press **NEXT** to display **14**.
2. Press **ENTER** to start the De-Lime Cycle (10 minutes). During this time, all dispenser operation is stopped.
3. Press **ENTER** to stop the De-Lime Cycle early, and return to the main menu loop.

Live Conductivity Display

The current conductivity reading is displayed, if enabled.

Note 	This is a continuous display. It does not time out after 30 seconds.
--	--

Alarms (Probe Mode Only)

Low Detergent Alarm

The low detergent alarm (audible and visual) occurs if the detergent concentration does not increase when the detergent feeds within a preset number of racks washed (as programmed in “*Low Detergent Alarm Delay (Menu 34)*” on page 6-7 of Program Mode). The low detergent alarm resets itself when the dispenser senses an increase in the detergent concentration in the wash tank.

Visual Alarm—Flashing lower lines on the display.

Audible Alarm—Beeps three times per rack.

Detergent Overfeed Stop Alarm

If a low detergent alarm condition continues for twice the preset number of racks washed (as programmed in “*Low Detergent Alarm Delay (Menu 34)*” on page 6-7 of Program Mode), the detergent feed stops and the audible and visual alarms change to indicate that the detergent feed has stopped.

Visual Alarm—Flashing lower lines and right zero of the LED display.

Audible Alarm—Sounds continually in three sets of three beeps.

Note 	Overfeed stop can be reset (e.g., to initiate detergent feed after changing the product container) by pressing any key.
---	---

Manual Initial Charge

Note 	This function is available in Probeless mode, Manual Initial Charge setting only.
--	---

1. From the home screen, press **SCROLL** to activate manual initial charge.
2. Press **SCROLL** again to terminate manual initial charge early.

Password Access to Program Mode

1. Press and hold **ENTER** for 2 seconds to access the Password input screen.
The password factory setting is **123**.
2. Press **SCROLL** to change the blinking digit to the desired value.
3. Press **NEXT** to move the blinking digit.
4. Press **ENTER** to set all numbers and exit to the Program Mode.
An incorrect password entry returns you to the home screen.

Program Mode Operation

Overview

This chapter describes the settings of Program Mode, which consists of three circular main menu loops. The Configuration Settings loop (Menu 2) is always available. One of the two Adjustment Menus is also available. The available Adjustment Menu is determined by the *Detergent Control* selection of either Probe (Menu 3) or Probeless (Menu 4).

In this chapter, you will learn about:

- Program Mode Access
- Configuration Settings (Menu 2)

Plus either:

- Adjustments – Probe Mode (Menu 3) or
- Adjustments – Probeless Mode (Menu 4)

<p>Note</p> 	<p>When programming the dispenser for a new installation, always set Configuration Settings first; these settings determine which Adjustment Menu displays.</p> <p>After you have configured the dispenser for Probe or Probeless Mode (in the Detergent Control, Menu 21), set the dispenser adjustments in the Adjustment Menu loop. Maintenance adjustments will also typically be performed in this Adjustment Menu.</p>
--	--

Program Mode Access

Input the Installer Password as described in “*Password Access to Program Mode*” on page 5-4. The factory preset password is **123**.

Once you are in Program Mode, move through the circular menu loops with the three-button controls as described in “*Key Description*” on page 4-1:

1. Press **SCROLL** to change the blinking digit from **2** (Configuration Settings Menu) to either:
 - **3** (Adjustments—Probe Menu) or
 - **4** (Adjustments—Probeless Menu) or
 - – (dash) to exit Program Mode.
2. Press **NEXT** to move through main menu loops 2 and 3 or 4. Press **ENTER** to exit Program Mode at the blinking dash screen (Exit Program Mode).

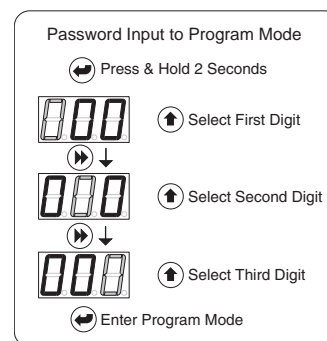



Figure 6-1 Program Mode Access

<p>Note</p> 	<p>Program Mode automatically returns to the User Mode screen after five minutes of inactivity.</p>
--	---

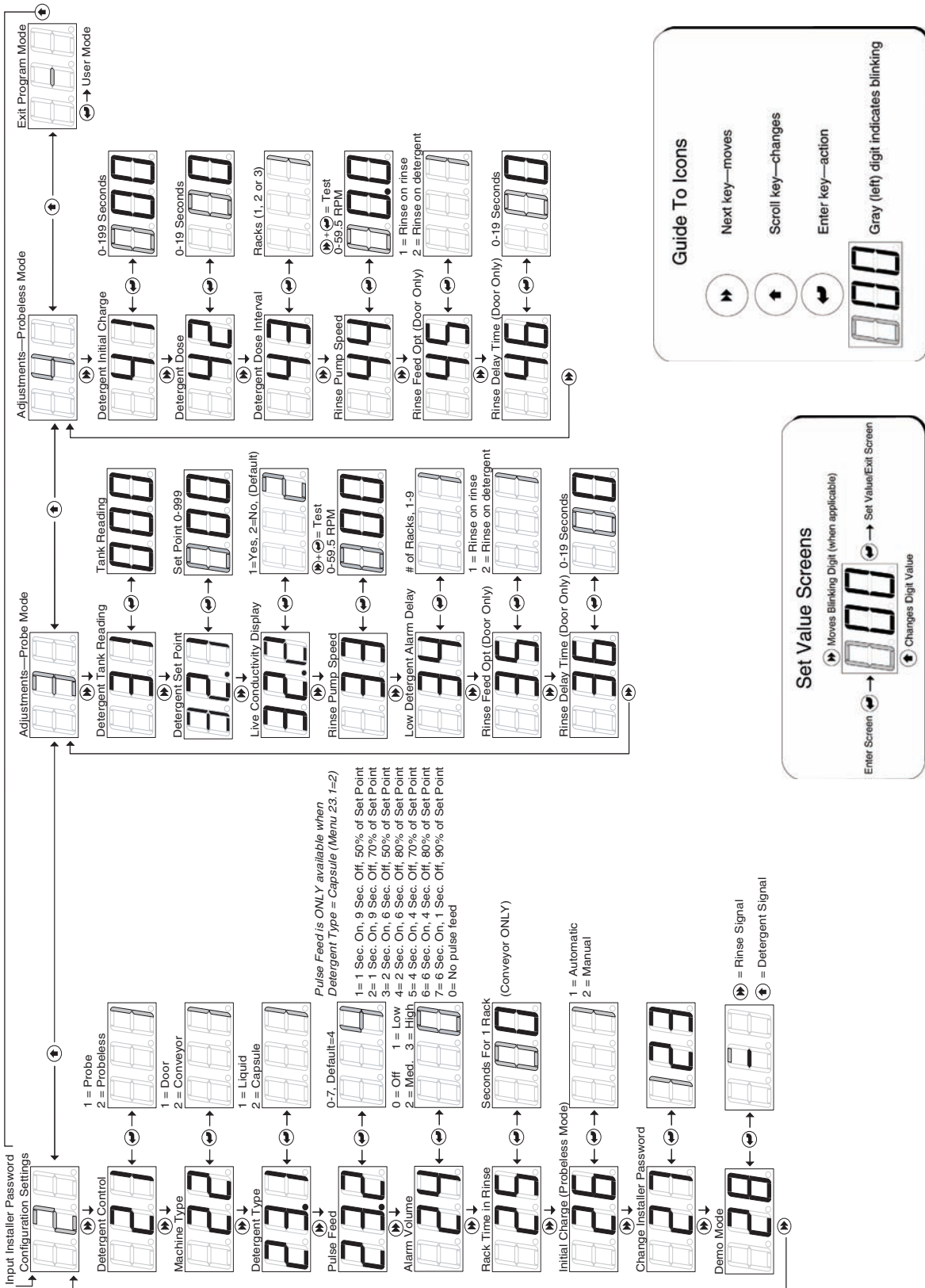

Figure 6-2 Program Mode Screens

Configuration Settings

The Configuration Settings Menu loop is always available. To simplify programming, only one Adjustment Menu loop is accessible once a Detergent Control selection has been made in Menu 21.

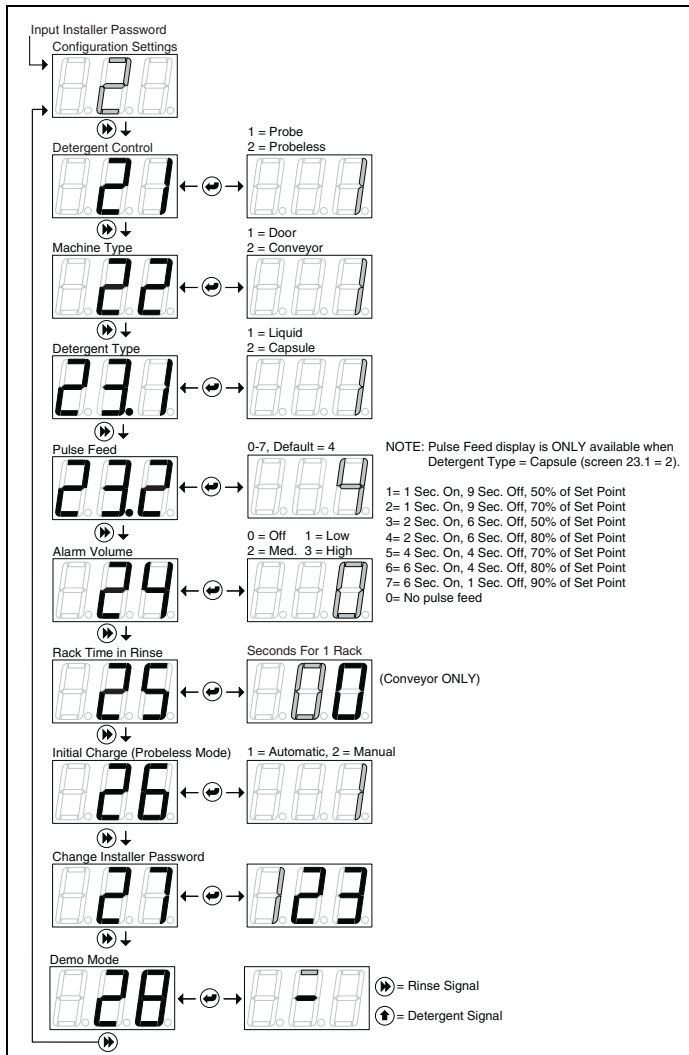

Figure 6-3 Configuration Settings (Menu 2)

Detergent Control (Menu 21)

This selection determines whether the Probe or Probeless Adjustment Menu is available.

1. Press **ENTER** to view/change this setting.
2. Press **SCROLL** to select between **1** (Probe) or **2** (Probeless) detergent control.
3. Press **ENTER** to set the value and return to the main menu loop.

Machine Type (Menu 22)

1. Press **ENTER** to view/change this setting.
2. Press **SCROLL** to select between **1** (Door) or **2** (Conveyor) machine type.
3. Press **ENTER** to set the value and return to the main menu loop.

Detergent Type (Menu 23.1)

1. Press **ENTER** to view/change this setting.
2. Press **SCROLL** to select the detergent type. Select **1** (Liquid) or **2** (Capsule). This sets the feed and read ratio when the concentration is within 20% of set point. The detergent set points are:
 - **1** (Liquid) = 3 seconds on/3 seconds off
 - **2** (Capsule) = 2 seconds on/6 seconds off
3. Press **ENTER** to set the value and return to the main menu

Note 	If 1 (Liquid) is selected and the unit is equipped with a solenoid valve, the display indicates a pump jam condition and the dispenser will not activate the solenoid valve.
--	--

Pulse Feed – Capsule Detergent Only (Menu 23.2)

This screen is displayed only if screen 23.1 (Detergent type) is set to **2** (Capsule). Use this menu to adjust the length of time that the detergent feeds (the pulse) and the interval between pulses, based upon detergent strength and the distance between the product container and dish machine.

1. Press **ENTER** to view/change this setting.
2. Press **SCROLL** to change the value (0-7).
The settings are as follows:
 - 1 = 1 Second on, 9 Seconds off, @ 50% of set point
 - 2 = 1 Second on, 9 Seconds off, @ 70% of set point
 - 3 = 2 Seconds on, 6 Seconds off, @ 50% of set point
 - 4 = 2 Seconds on, 6 Seconds off, @ 80% of set point (Default)
 - 5 = 4 Seconds on, 4 Seconds off, @ 70% of set point
 - 6 = 6 Seconds on, 4 Seconds off, @ 80% of set point
 - 7 = 6 Seconds on, 1 Second off, @ 90% of set point
 - 0 = No pulse feed
3. Press **ENTER** to set the value and return to the main menu loop.

Alarm Volume (Menu 24)

1. Press **ENTER** to view/change this setting.
2. Press **SCROLL** to select between **0** (Off), **1** (Low), **2** (Medium), or **3** (High) alarm volume.
A half-second beep will sound for each level as the Scroll key is pressed.
3. Press **ENTER** to set the value and return to the main menu loop.

Rack Time in Rinse (Menu 25)

Note 	This menu applies only to conveyor-type dishwashers. The value that is set is used to count racks and determine detergent dose intervals, if set to Probeless Mode.
--	---

To determine this value, time the number of seconds it takes the dish machine conveyor to move one rack a single rack length's distance through one complete rinse cycle. Input that time in Menu 25.

1. Press **ENTER** to view/change this setting.
2. Press **SCROLL** to change the value of the blinking center digit (tens).
3. Press **NEXT** to move to the right digit (ones), which then begins blinking.

4. Press **SCROLL** to change the value of the blinking right digit (ones). The range is 0 - 29 seconds.
5. Press **ENTER** to set the value and return to the main menu loop.

Initial Charge - Probeless Only (Menu 26)

Note 	This menu applies only to probeless detergent control. and has no effect when probe detergent control is selected in menu 21.
--	---

This setting determines whether the Initial Charge is Manual or Automatic. To set the initial charge:

1. Press **ENTER** to view/change this setting.
2. Press **SCROLL** to select between **1** (Automatic) or **2** (Manual) initial detergent charge.
3. Press **ENTER** to set the value and return to the main menu loop.

Manual Initial Charge

To start a Manual Initial Charge from the User Mode, press **SCROLL**.

Automatic Initial Charge

In a **door-type dishwasher**, the Automatic Initial Charge occurs each time the dispenser receives a rinse signal that was not preceded by a detergent signal within 90 seconds prior (i.e. on an initial fill). When this condition occurs, the dispenser detects an Automatic Initial Charge, disables the rinse feed, and feeds detergent for the time that is set in Menu 41. (See “*Detergent Initial Charge (Menu 41)*” on page 6-9 for more information.) Normal rinse signal activations (within 90 seconds after a detergent signal) will not generate an initial charge.

A five minute lockout timer begins at the start of initial charge; this prevents an additional initial charge from occurring if multiple rinse signals are detected during fill.

In a **conveyor-type dishwasher**, the Automatic Initial Charge occurs each time the dispenser detects a detergent signal input that has been present for 10 seconds continuously. Then, the rinse pump is turned off for 90 seconds (or Detergent Initial Charge time, if longer), and the detergent feeds for the time that is set in Menu 41(see “*Detergent Initial Charge (Menu 41)*” on page 6-9 for more information.)

It is important to note that this will happen each time a detergent signal occurs, so the source of this signal must remain on for the entire time the tank is full, or not occur more than one time per machine fill. (See Chapter 2 “*Electrical Installation*” for more information.)

Change Installer Password (Menu 27)

Caution 	Be sure to note the new password if you change it from the factory setting (123). If your password is lost, contact Nova Controls Customer Service.
---	---

1. Press **ENTER** to view/change this setting. Any three-digit number may be input.
2. Press **SCROLL** to change the blinking digit to the desired value.
3. Press **NEXT** to move the blinking digit. Repeat for all digits.
4. Press **ENTER** to set the value and return to the main menu loop.

Demo Mode (Menu 28)

This menu is used to test or demonstrate dispenser functions.Press **ENTER** to access or exit demo mode. Press **NEXT** to simulate Rinse Signal or **SCROLL** to simulate Detergent Signal.

Adjustments—Probe Mode (Menu 3)

Note 	This menu is only available when Detergent Control (menu 21) is set to 1 (Probe).
--	---

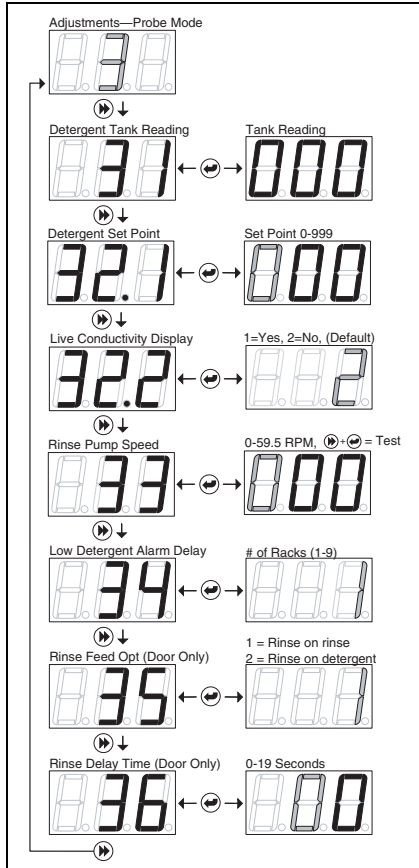

Figure 6-4 Adjustments - Probe Mode (Menu 3)

Detergent Tank Reading (Menu 31)

Prepare for this reading by manually adding product to proper concentration, then test via titration or measured volume. The dishwasher tank solution must be well mixed (wash pump running) and at operating temperature.

Press **ENTER** to view this number, which is an average that is updated every 0.1 seconds. Make note of the tank reading displayed. This is your set point.

Detergent Set Point (Menu 32.1)

1. Press **ENTER** to view/change this setting and to input the number noted in *Menu 31*:
2. Press **SCROLL** to change the blinking digit to the desired value.
3. Press **NEXT** to move the blinking digit. Repeat for all three digits. The range is 0 - 999.
4. Press **ENTER** to set the value and return to the main menu.

Note 	It is good practice to run a few racks through the dish machine & retest concentration with a titration kit. If the concentration is not at the desired level, adjust accordingly.
--	--

Live Conductivity Display (Menu 32.2)

1. Press **ENTER** to view/change this setting.
2. Select **1** to enable the Live Conductivity Display and **2** to disable this display.
The default is **2** (disabled).

Rinse Pump Speed (Menu 33)

Note 	Adjust the rinse pump speed for appropriate amount of product needed for good results on wares.
--	---

To determine this adjustment, note the amount of rinse product per unit of water (check the dish machine specifications for rinse water flow rate per minute) or observe the sheeting action of the product on wares. With the standard rise pump tube, the Sprite will dispense 0.5 ml per revolution.

To test run or view the rinse pump speed, press and hold the Next key, followed by the Enter key. The pump will run at the current speed setting.

To change the rinse pump speed:

1. Press **ENTER** to view/change this setting.
2. Press **SCROLL** to change the blinking digit to the desired value.
3. Press **NEXT** to move the blinking digit. Repeat for all digits.
The range of this adjustment is from 0 to 59.5 RPM in 0.5 RPM steps.
4. Press **ENTER** to set the value and return to the main menu loop.

Low Detergent Alarm Delay (Menu 34)

This setting determines how many racks can run before the Low Detergent Alarm is activated.

1. Press **ENTER** to view/change this setting.
2. Press **SCROLL** to select the number of racks (1-9) allowed to run with a low detergent concentration.
3. Press **ENTER** to set the value and return to the main menu loop.

Note 	The low detergent alarm will occur only if there is no increase in detergent concentration and the unit is below set point for the number of racks set. The low detergent alarm resets itself when it detects a rise in detergent concentration.
--	---

Rinse Feed Option (Menu 35)

The setting determines when the rinse feed is activated.

1. Press **ENTER** to view/change this setting.
2. Press **SCROLL** to select rinse feed option (1 or 2).
3. Select option **1** to run the rinse pump each time the rinse signal activates (for the duration of time the signal is present).
4. Select option **2** to run the rinse pump for a fixed time of 12 seconds each time the detergent signal activates.
5. Press **ENTER** to set the value and return to the main menu loop.

Rinse Delay Time (Menu 36)

Note 	This menu is available only when: • 1 (Door) is selected in menu 22 (Machine Type) and • 1 (Rinse on rinse) is selected in menu 35 (Rinse Feed Option)
--	--

Use this feature to minimize rinse product waste by injecting product only during the last few seconds of each rack.

1. Press **ENTER** to view/change this setting.
2. Press **SCROLL** to change the blinking digit to the desired time in seconds.
3. Press **NEXT** to move the blinking digit. Repeat for both digits.
The range of this adjustment is from 0 - 19 seconds.
4. Press **ENTER** to set the value and return to the main menu loop.

Adjustments—Probeless Mode (Menu 4)

Note 	This menu is available only when menu 21 (Detergent Control) is set to 2 (Probeless).
--	---

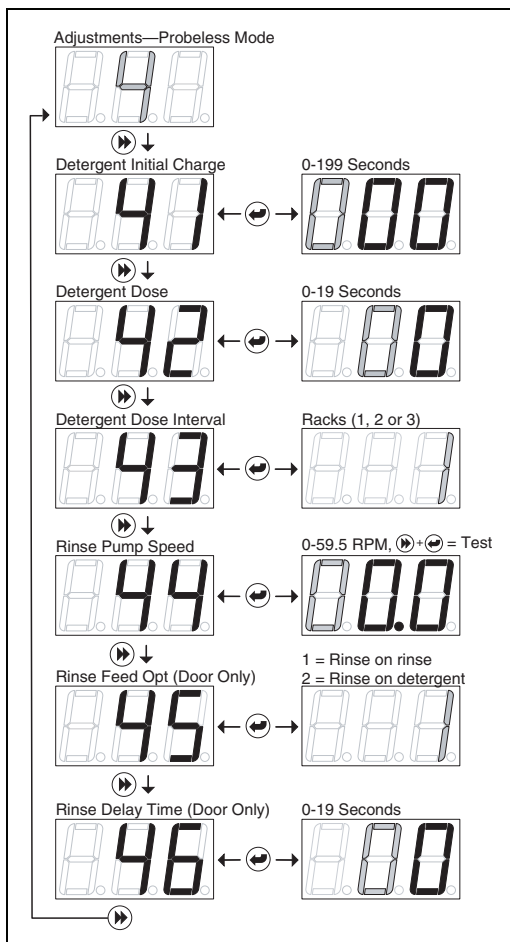



Figure 6-5 Adjustments - Probeless Mode

Detergent Initial Charge (Menu 41)

Note 	Prepare for this reading by determining the detergent feed time (in seconds) required to charge the wash tank to the correct concentration on an initial fill.
--	--

1. Press **ENTER** to view/change this setting and to input the initial charge detergent feed time.
2. Press **SCROLL** to change the blinking digit to the desired value.
3. Press **NEXT** to move the blinking digit. Repeat for all three digits. The range is 0 - 199 seconds.
4. Press **ENTER** to set the value and return to the main menu loop.

Detergent Dose (Menu 42)

Note 	The detergent dose time depends on the detergent dose interval set in Menu 43. The available dose intervals are every rack, every second rack, or every third rack.
--	---

This setting determines the amount of detergent that is dispensed in each dose.

1. Press **ENTER** to view or input the detergent recharge dose feed time.
2. Press **SCROLL** to change the blinking digit to the desired value.
3. Press **NEXT** to move the blinking digit. Repeat for all three digits. The range is 0 - 19 seconds.
4. Press **ENTER** to set the value and return to the main menu loop.

Detergent Dose Interval (Menu 43)

This setting determines when a detergent dose occurs.

In **conveyor-type dishwashers**, a detergent dose will occur when the accumulated Rinse On time (whether the time accrues continuously or with interruptions) is equal to the rack time multiplied by the detergent dose interval selected by the user. In conveyor-type dishwashers, the rack time is set in "*Rack Time in Rinse (Menu 25)*" on page 6-4.

In **door-type dishwashers**, a "rack" is counted each time the door is opened and closed.

1. Press **ENTER** to view/change this setting.
2. Press **SCROLL** to select the rack interval between detergent doses.
The available dose intervals are: every rack; every second rack; or every third rack.
3. Press **ENTER** to set the value and return to the main menu loop.

Rinse Pump Speed (Menu 44)

Note 	Adjust rinse pump speed for the appropriate amount of product required to achieve good results on wares.
--	--

To determine this adjustment, note the amount of rinse product per unit of water (check the dish machine specifications for rinse water flow rate per minute), or observe the sheeting action of the product on wares. With the standard size rinse pump tube, the Sprite will dispense 0.5 ml per revolution.

To test run/view the rinse pump speed, press and hold **NEXT**, followed by **ENTER**, and the pump will run at the current speed setting.

1. Press **ENTER** to view/change this setting.
2. Press **SCROLL** to change the blinking digit to the desired value.
3. Press **NEXT** to move the blinking digit. Repeat for all digits.
The range is 0 - 59.5 RPM in 0.5 RPM steps.
4. Press **ENTER** to set the value and return to the main menu loop.

Rinse Feed Option (Menu 45)

This setting determines when rinse product will be dispensed.

1. Press **ENTER** to view/change this setting.
2. Press **SCROLL** to select rinse feed option (either **1** or **2** as described below).
 - Select **1** to run the rinse pump (and detergent dose on the selected dose intervals) each time the rinse signal activates (for the entire time the signal is present).
 - Select **2** to run the rinse pump for a fixed time of 12 seconds (and detergent dose on the selected dose intervals) each time the detergent signal activates.
3. Press **ENTER** to set the value and return to the main menu loop.

Rinse Delay Time (Menu 46)

This feature minimizes waste by injecting rinse product only during the last few seconds of each rack.

Note 	This menu is available only when: <ul style="list-style-type: none">• 1 (Door) is selected in menu 22 (Machine Type) and• 1 (Rinse on rinse) is selected in menu 35 (Rinse Feed Option).
--	---

1. Press **ENTER** to view/change this setting.
2. Press **SCROLL** to change the blinking digit to the desired time in seconds.
3. Press **NEXT** to move the blinking digit. Repeat for both digits. The range of this adjustment is from 0 to 19 seconds.
4. Press **ENTER** to set the value and return to the main menu loop.

Troubleshooting

Overview

This chapter describes the troubleshooting displays and methods for the Sprite, including:

- Alarms and Indicators
- Preliminary Checks
- No Display
- No Detergent Feed (Probe and Probeless Modes)
- Excess Detergent Consumption (Probe and Probeless Modes)
- No Rinse Feed (Probe and Probeless Modes)

Alarms and Indicators

The following display indicators, seen in the User Mode, provide useful information for troubleshooting purposes:

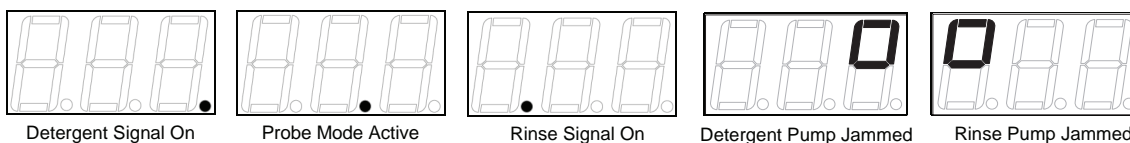

Figure 7-1 User Mode Alarms and Status Indicators

Preliminary Checks

If unit is dead, no display, go directly to *Dead Unit (No Display)*. Otherwise, check the indicators and alarms for information about the dispenser.

Dead Unit (No Display)

- Confirm main power connection voltage with a volt meter.
- Check fuse if optional fuse kit is installed.
- Substitute transformer followed by the printed circuit board to determine fault

No Detergent Feed

- For either Probe or Probeless Modes, confirm that detergent type (screen 23) is set correctly.

Probe Mode

- Temporarily disconnect probe wire (with detergent signal on) to force detergent feed.
 - If detergent feeds, check for probe scaling and check detergent setpoint setting.
 - If detergent does not feed, replace pump motor (or solenoid coil), then printed circuit board.

Probeless Mode

- Confirm that unit is in a detergent feed condition as determined by rinse/initial charge signal inputs and initial charge/dose adjustments.
- If detergent does not feed, substitute pump motor (or solenoid coil), followed by the printed circuit board to determine fault.

Excess Detergent Consumption

Probe Mode

- Check probe for scaling.
- Measure wash solution via titration kit or other means. If detergent is at proper concentration, check the dish machine for clogged drains, excessive fresh water feedback, etc.

Probeless Mode

- Confirm that initial charge is dispensed only one time per initial fill. If you experience multiple initial charge feeds (Automatic/Conveyor mode only), review initial charge wiring connection.
- All other modes, adjust initial charge and dose adjustments accordingly.

No Rinse Feed

The unit is programmed to lock out the rinse feed under certain conditions. Check for the following conditions:

- Probeless/Door/Automatic Initial Charge modes—Rinse is locked out after Initial Charge begins until the following rack (rinse signal) occurs.
- Probe Mode—Detergent signal did not occur within 90 seconds prior to rinse signal (Rinse Saver feature).

If the problem is not in one of the above conditions and rinse does not feed, substitute pump motor, followed by the printed circuit board, to determine fault.

Maintenance and Service

Overview

This chapter describes the maintenance and service for the Sprite, including a list of spare parts:

- Routine Maintenance
- Maintenance Visits
- Pump Tube Replacement
- Service Disassembly
- Lower Cabinet Front Removal
- Upper Cabinet Front Removal
- Diagram of Unit Parts
- Spare Parts Listing

Maintenance

Routine maintenance on the Sprite unit includes:

- Keeping the probe clean (probe mode operation only)
- Keeping pump tubes fresh
- Keeping the unit clean

Repairs to the unit involves modular component replacement. This minimizes spare parts inventory requirements and speeds up the service process in the field.

Every Maintenance Visit

- Titrate the wash tank solution to verify that unit is holding accurate concentration.
- Clean probe, if required.
- Clean the unit cabinet with a damp cloth.
- Check the pump tube's condition and replace, if needed.

Pump Tube Replacement

Replace pump tubes at regular maintenance intervals, well before the tube fails and ruptures. If the tube does rupture, clean all product from the pump with a damp cloth.

- Loosen the pump front captive screw and remove the pump front.
- Remove the old tube with barbed connectors.
- Install the new tube with barbed connectors oriented with flat sides facing towards the front.
- Insert new tube from left side of pump, with pump spinner oriented in an 11/1 o'clock position.
- Turn the spinner clockwise, using a screwdriver, as you press the pump tube in place.

Service Disassembly

Warning



Disconnect all power while performing this service or any time unit is opened.

Sprite service parts consist of three major assemblies: pump parts, tubes, and the solenoid valve. The three major field replacement assemblies are:

- Upper Cabinet Front—includes printed circuit board, cabinet front, and cables
- Lower Cabinet Front—includes pump motor(s)
- Cabinet Rear—includes power transformer

Upper Cabinet Front Removal

1. Remove the three front phillips-head screws.
2. Lift upper cabinet front off of unit complete with power and probe wires. (Disconnect solenoid valve plug from printed circuit board on solenoid equipped units.)
3. Unplug power transformer plug from printed circuit board and remove upper cabinet front.

Lower Cabinet Front Removal

1. Remove the lower front phillips-head screw.
2. Open lower cabinet front by lifting out at the bottom.
3. Lift off front assembly and disconnect motor wire plug(s) from the printed circuit board and remove Lower Cabinet Front.

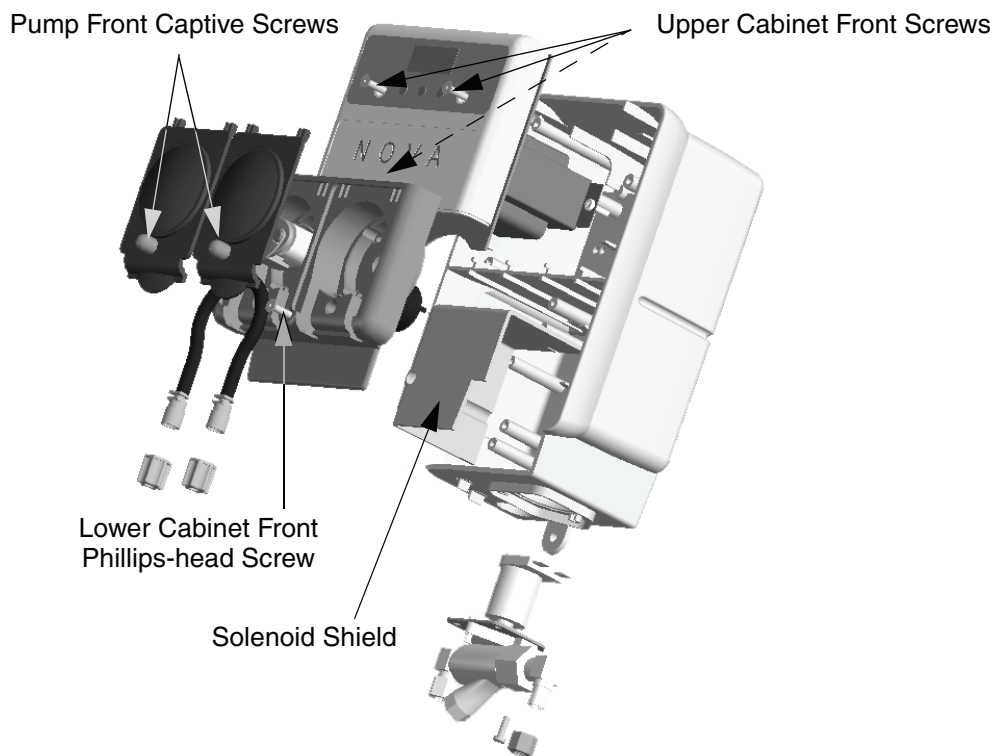

Figure 8-1 Sprite Cabinet Assembly

Spare Parts

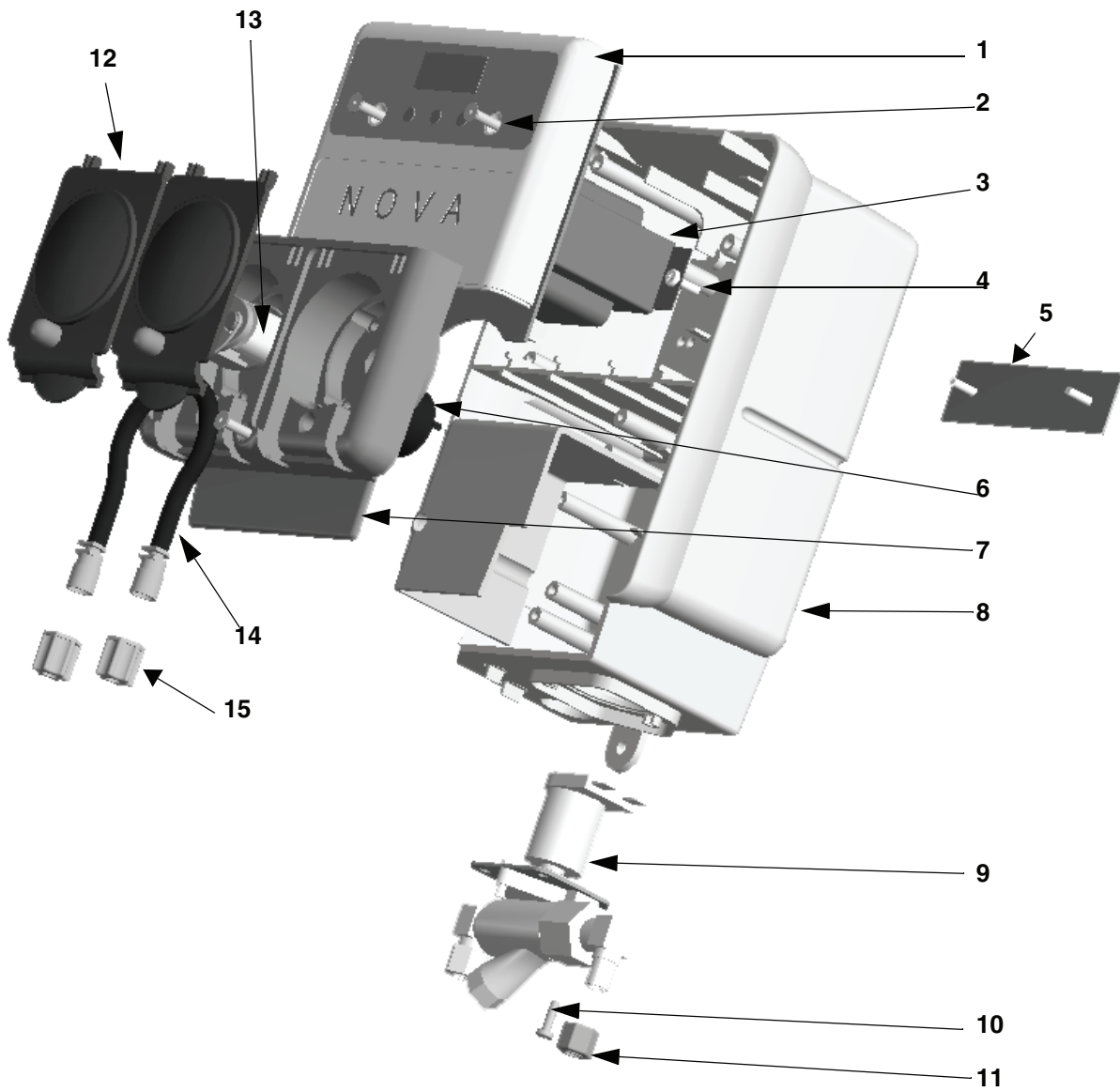

Figure 8-2 Spare Parts Listing

Table 8-1 Spare Parts Listing

Ref. Number	Part Number	Description
1	13-06393-00	Printed Circuit Board, includes Cabinet Front and Terminal Barriers
1	13-06393-01	Printed Circuit Board (European Wire Colors), includes Cabinet Front and Terminal Barriers
2	30-06358-0832	Cabinet Front Screw
3	13-06394-00	Transformer
4	30-06359-0605	Transformer Screw
5	03-03570-039	Wall Mount Hanger
6	13-06523-01	Pump Motor, Rinse
6	13-06524-01	Pump Motor, Detergent
7	13-06525-00	Lower Cabinet Front (Pump Housing Front)
8	13-06526-00	Cabinet Rear (No On/Off Switch)
8	13-06527-00	Cabinet Rear (With On/Off Switch)
9	13-06397-00	Solenoid Valve Kit, 1/4" Fittings
9	13-06397-01	Solenoid Valve Kit, 6 mm Fittings
9	13-06397-02	Solenoid Valve Kit, 5/16" (8 mm) Fittings
10	30-06359-0605	Solenoid Valve Screw
11	13-06528-00	Solenoid Valve Nut w/ Sleeve, 1/4", 10 Pack
11	13-06528-01	Solenoid Valve Nut w/ Ferrule, 6mm, 10 Pack
11	13-06528-02	Solenoid Valve Nut w/ Sleeve, 5/16" (8mm), 10 Pack
12	13-06398-00	Pump Front (Includes Captive Screw)
13	13-06396-00	Pump Spinner
14	13-06395-10	Pump Tube, Rinse, EPDM (Includes 1/4" Barb Fittings), 10 pack
14	13-06395-20	Pump Tube, Rinse, EPDM (Includes 1/4" and 1/8" Barb Fittings), 10 Pack
14	13-06395-30	Pump Tube, Rinse, EPDM (Includes 1/8" Barb Fittings), 10 Pack
14	13-06928-10	Pump Tube, Rinse, Silicone (Includes 1/4" Barb Fittings), 10 Pack
14	13-06928-20	Pump Tube, Rinse, Silicone (Includes 1/4" and 1/8" Barb Fittings), 10 Pack
14	13-06928-30	Pump Tube, Rinse, Silicone (Includes 1/8" Barb Fittings), 10 Pack
14	13-06399-10	Pump Tube, Detergent, EPDM (Includes 1/4" Barb Fittings), 10 Pack
15	13-06563-00	Pump Tube Compression Nut w/ Sleeve, 1/4" (10 pack)
15	13-06563-01	Pump Tube Compression Nut w/ Sleeve, 6 mm (10 pack)
15	13-06563-02	Pump Tube Compression Nut and Ferrule, 1/8" or 3 mm (10 pack)
*	13-06529-00	Rinse Injection Fitting, Straight, Kynar, 1/8" NPT x 1/4" Tube
*	13-06529-01	Rinse Injection Fitting, Straight, Kynar, 1/8" NPT x 1/8" (3 mm) Tube
*	13-06529-02	Rinse Injection Fitting, Straight, Kynar, 1/8" NPT x 6 mm Tube
*	13-06531-00	Rinse Injection Fitting, 90° Elbow, Kynar, 1/8" NPT x 1/4" Tube
*	13-06531-01	Rinse Injection Fitting, 90° Elbow, Kynar, 1/8" NPT x 1/8" (3 mm) Tube
*	13-06531-02	Rinse Injection Fitting, 90° Elbow, Kynar, 1/8" NPT x 6 mm Tube

* Denotes items not shown.

9

Specifications

Note 	Specifications subject to change without notice.
--	--

Dimensions	
Size	6" W x 10.75" H (w/solenoid) x 4.88" D (15.24 cm W x 27.31 cm H x 12.38 cm D)
Weight	6 lbs. (2.72 kg)
Power Requirements	
Total Amperage draw during operation	90 to 130 VAC nominal, 50/60 Hz., 0.5 amps (max.) 200 to 249 VAC nominal, 50/60 Hz., 0.3 amps (max.)
General	
Rinse Pump Flow Rate	0.5 mls/revolution
Detergent Pump Flow Rate	5.25 oz./min. (156 mls/min)
Environmental	
Pollution	2
Installation Category	II
Temperature	10° to 49° C (50° to 120° F) (max.)
Humidity	95% relative humidity (max.)
Indoor Installation	Approved for indoor use only. Must not be installed outdoors.
Altitude	Install at or below 6,500 ft. (2000m) max.

Limited Warranty

SELLER warrants solely to BUYER the Products will be free from defects in material and workmanship under normal use and service for a period of one year from the date of completion of manufacture. This limited warranty does not apply to (a) hoses; (b) and products that have a normal life shorter than one year; or (c) failure in performance or damage caused by chemicals, abrasive materials, corrosion, lightning, improper voltage supply, physical abuse, mishandling or misapplication. In the event the Products are altered or repaired by BUYER without SELLER'S prior written approval, all warranties will be void.

NO OTHER WARRANTY, ORAL, EXPRESS OR IMPLIED, INCLUDING ANY WARRANTY OF MERCHANTABILITY OR FITNESS FOR ANY PARTICULAR PURPOSE, IS MADE FOR THESE PRODUCTS, AND ALL OTHER WARRANTIES ARE HEREBY EXPRESSLY EXCLUDED.

SELLER'S sole obligation under this warranty will be, at SELLER'S option, to repair or replace F.O.B. SELLER'S facility in Watsonville, California any Products found to be other than as warranted.

Limitation of Liability

SELLER'S WARRANTY OBLIGATIONS AND BUYERS REMEDIES ARE SOLELY AND EXCLUSIVELY AS STATED HEREIN. SELLER SHALL HAVE NO OTHER LIABILITY, DIRECT OR INDIRECT, OF ANY KIND, INCLUDING LIABILITY FOR SPECIAL, INCIDENTAL, OR CONSEQUENTIAL DAMAGES OR FOR ANY OTHER CLAIMS FOR DAMAGE OR LOSS RESULTING FROM ANY CAUSE WHATSOEVER, WHETHER BASED ON NEGLIGENCE, STRICT LIABILITY, BREACH OF CONTRACT OR BREACH OF WARRANTY.

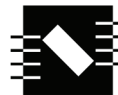

NOVA CONTROLS
LEADING THE WAY

A **Hydro** Systems Company

225 WESTRIDGE DRIVE
WATSONVILLE
CALIFORNIA
95076-4168 U.S.A.

TEL 831.786.1470

FAX 831.786.1650

Index

A

Adjustments - Probe Mode 6-6
Adjustments - Probeless Mode 6-8
Alarms & Indicators 7-1
Alarms (Probe Mode Only) 5-4
Altitude, allowable for unit 9-1
Automatic Initial Charge 6-5

B

Bulkhead Fitting 2-3, 2-4

C

Cabinet Disassemble 8-2
Cabinet Disassembly 8-2
Change password 6-5
Changing tubes 8-1
Circuit Voltage chars 3-2
Configuration Settings, diagram of screens 6-3
Conveyor-type Dishwashers, initial charge 6-5
Count racks 6-4

D

De-Lime 1-1, 5-3
Detergent 2-2, 6-5, 6-7, 6-8, 6-9, 6-10
 concentration 6-7
 consumption 7-2
 dose intervals 6-4
 pump flow rate 9-1
 set point 6-6
 setting control 6-3
 setting the type 6-4
Dimensions 9-1
Discharge 2-4
Door-type Dishwashers, initial charge 6-5

E

External junction box 2-2

H

Humidity, allowable for unit 9-1

I

Initial Charge 3-4, 6-5, 6-9
 probeless 6-5
Input Screen 4-1, 5-4
Installation Category 9-1

K

Key Description 4-1

L

Leak-free assembly 2-3
Live Conductivity Display 5-3, 6-7
Low Detergent Alarm 5-4

M

Machine Type, setting 6-3
Maintenance 8-1
Manual Initial Charge 5-4, 6-5
motor 3-3

N

Next Key 4-1

O

Overfeed 5-1

P

Parts, listing of 8-3
Password 5-4, 6-1
Password, changing 6-5
Pollution category 9-1
Power Requirements 9-1
Prime 5-3
Probe 2-2, 3-2, 6-3
 adjustment menu 6-6
 detergent signal wiring 3-3
 maintenance 8-1
 placement 2-2
 wire 3-1
Probeless 6-8
 detergent signal wiring 3-4
Program Mode 4-1, 5-4, 6-1
 access with password 6-1
 menu screens 6-2
 use of keys 4-1
Pump
 flow rate 9-1
 speed 6-7, 6-10
 tube replacement 8-1
Pump Jam display 7-1

R

Rack Counter 5-2
Replacing tubes 8-1
Rinse 6-7
 delay 6-8
 feed 6-5, 6-7, 6-10
 injection 2-4
 injection installation 2-3
Rinse Pump 5-1, 6-5, 9-1
 discharge tube 2-4
 flow rate 9-1
 prime 5-3
 set run time 6-7
 speed 6-7
Rinse Saver 1-1, 6-10
Rinse Signal 6-5, 6-7, 6-10
 wiring 3-4

S

Scroll key 4-1, 5-4, 6-3, 6-5
set point 6-4
Setting password 6-1
Signal Wiring 3-3
Size of unit 9-1
Solenoid Water Feed installation 2-4
Spare Parts listing 8-3, 8-4
Specifications 9-1
System Diagram 2-1

T

Temperature, allowable for unit 9-1
Titration 8-1
Total Amperage draw 9-1
troubleshooting 7-1
tube connection 2-4
Tube rupture, cleaning 8-1
Tubes, replacing 8-1

U

User Mode 5-1
 menus 5-2
 use of keys 4-1

W

Wall Mount 2-2
Water supply, with solenoid 2-4
Weight of unit 9-1
Wiring 3-2, 3-3
 charts 3-2
 connections 3-1
 main power diagrams 3-3

Configuration Settings

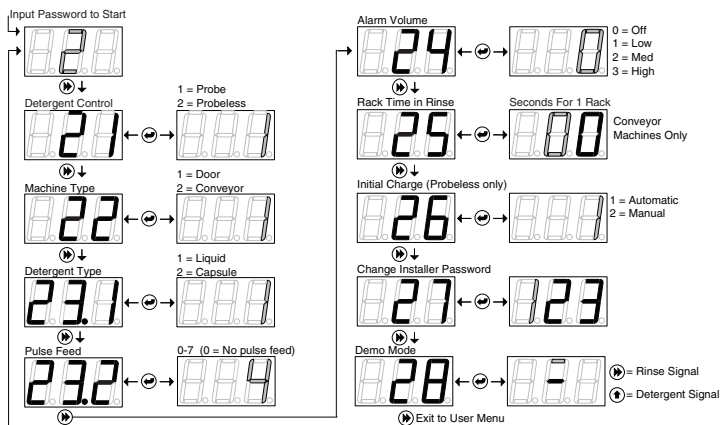

NOTE: Pulse Feed display is ONLY available when Detergent Type = Capsule (screen 23.1 = 2).

- 1= 1 Second On, 9 Seconds Off, 50% of Set Point
- 2= 1 Second On, 9 Seconds Off, 70% of Set Point
- 3= 2 Seconds On, 6 Seconds Off, 50% of Set Point
- 4= 2 Seconds On, 6 Seconds Off, 80% of Set Point (Default)
- 5= 4 Seconds On, 4 Seconds Off, 70% of Set Point
- 6= 6 Seconds On, 4 Seconds Off, 80% of Set Point
- 7= 6 Seconds On, 1 Second Off, 90% of Set Point



NOVA CONTROLS
 LEADING THE WAY
 A Hydro Systems Company
 225 WESTRIDGE DRIVE
 WATSONVILLE
 CALIFORNIA
 95076-4188 U.S.A.
 TEL 831.786.1470
 FAX 831.786.1650

20-06270-00N

SPRITE Warewash Programming Card

