

ST 800 and ST 700 Standard SmartLine Pressure Transmitter Quick Start Installation Guide

34-ST-25-36, Revision 5, December 2016

This document provides descriptions and procedures for the Quick Installation of Honeywell's family of SmartLine Pressure Transmitters.

The SmartLine Pressure Transmitter is available in a variety of models for measuring Differential Pressure (DP), Gauge Pressure (GP), and Absolute Pressure (AP). For full details refer to the manuals listed below for protocols, human interface (HMI), Operation, Installation, Configuration, Calibration, Maintenance, Parts, Safety and Approvals etc. including options.

Various other support documents are available on the CD supplied with your shipment. Documents in hardcopy can also be ordered.

Copyrights, Notices and Trademarks

Copyright 2012 by Honeywell
Revision 4 –March 2016
Revision 5 –December 2016

Trademarks

SFC, SmartLine, ST 800 and ST 700 are U.S. registered trademarks of Honeywell Inc.

HART® and FOUNDATION™ are trademarks of the FieldComm Group™

References

The following list identifies all documents that may be sources of reference for material discussed in this publication.

Document Title	Document #
ST 700 Basic SmartLine Transmitter Quick Start Guide	34-ST-25-57
ST 800 SmartLine Transmitter User's Manual ST 700 SmartLine Transmitter User's Manual	34-ST-25-35 34-ST-25-44
ST 800 SmartLine Transmitter HART/DE User Manual ST 700 SmartLine Transmitter HART/DE User Manual	34-ST-25-38 34-ST-25-47
ST 800 Foundation Fieldbus Manual ST 700 Foundation Fieldbus Manual	34-ST-25-39 34-ST-25-48
ST 800 / ST 700 FF Function Blocks Manual	34-ST-25-42
ST 800 Safety Manual	34-ST-25-37
MC Toolkit User Manual (MCT202) MC Toolkit User Manual (MCT404)	34-ST-25-20 34-ST-25-50

Table of Contents

Installation	3
Mounting the Transmitter	3
Bracket Mounting	4
Optional Mounting Bracket.....	4
Existing Mounting Bracket.....	5
Rotating Transmitter Housing.....	6
Leveling Transmitters with Small Absolute or Differential Pressure Spans	7
Flange Mounting	8
Flush Mounting.....	9
Remote Seal Mounting.....	10
Conduit Entry Plugs and Adapters	11
Wiring Connections and Power Up.....	13
Wiring Variations	14
Explosion-Proof Conduit Seal	15
Trim the Transmitter	16
Procedure to Trim the Transmitter	16
Set the Jumpers For HART/DE.....	17
Setting Failsafe Direction and Write Protect Jumpers	17
Write Protect Jumper on Foundation Fieldbus (FF).....	19
Configuration Guide	20

Tables

Table 1 - Conduit Entry Plugs	11
Table 2 - Conduit Adapters	12
Table 3 - Jumper Settings	18
Table 4 - Fieldbus Write Protect.....	19
Table 5 – Basic Display Configuration (ST 700Std/ST800 only)	20
Table 6 – Advanced Display Configuration (ST 800 only)	21
Table 7 - Simple Display Menu (ST 700 Std only).....	22

Figures

Figure 1: Mounting Brackets	3
Figure 2: Angle Mounting Bracket	4
Figure 3: LGP and LAP models.....	5
Figure 4: Rotating Transmitter Housing.....	6
Figure 5: Using level to mount transmitter	7
Figure 6: Flange mounting	8
Figure 7: Flush Mounting.....	9
Figure 8: Remote Seal mounting.....	10
Figure 9: Electronic Housing Conduit Entries.....	12
Figure 10: Two-wire power/current loop	13
Figure 11: Terminal Block and Grounding Screw location.....	14
Figure 12: Jumper Location HART/DE	18

INSTALLATION

Evaluate the site selected for the Transmitter installation with respect to the process system design specifications and Honeywell's published performance characteristics for your particular model.

Temperature extremes can affect display quality. The display can become unreadable at temperature extremes; however, this is only a temporary condition. The display will again be readable when temperatures return to within operable limits.

MOUNTING THE TRANSMITTER

Transmitter models, except flush mounts and those with integral flanges, can be attached to a two-inch (50 millimeter) vertical or horizontal pipe using Honeywell's optional angle or flat mounting bracket; alternately you can use your own bracket. Flush-mount models are attached directly to a process pipe or tank by a one-inch weld nipple. Models with integral flanges are supported by the flange connection.

Typical Bracket mounted and Flange Mounted Installations

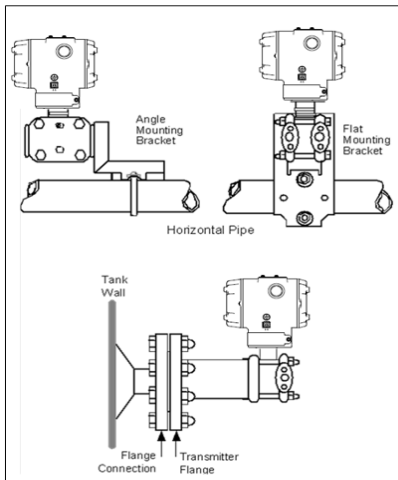

Figure 1: Mounting Brackets

Bracket Mounting

- Optional mounting bracket, see Figure 2
- Existing mounting bracket, see Figure 3
- Rotate the transmitter housing, see Figure 4

Level a transmitter with small absolute or differential pressure spans, see Figure 5.

Optional Mounting Bracket

Position the bracket on a 2-inch (50.8mm) and install "U" bolt around pipe and through holes in bracket. Secure with nuts and lock washers provided.

Figure 2 Example - Angle mounting bracket secured to horizontal or vertical pipe.

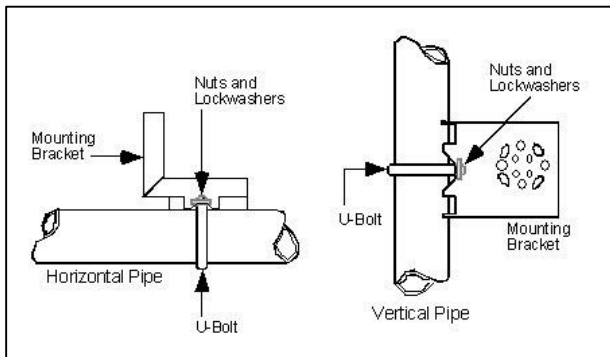

Figure 2: Angle Mounting Bracket

Existing Mounting Bracket

Align appropriate mounting holes in transmitter with holes in bracket and secure with bolts and washers provided.

Note: If the meter body is hexagonal, you must use the additional bracket supplied. If meter body is round, discard the bracket.

Example – LGP model transmitter mounted to optional angle mounting bracket.

If Transmitter is....	Then....
DP, Dual Head GP, Dual Head AP and DP Remote Seals.	Use alternate mounting holes in end of heads.
In-line GP and AP (LGP model) or GP/AP Remote Seal	Use smaller "U" bolt provided to attach meter body to bracket. See Figure 3 .

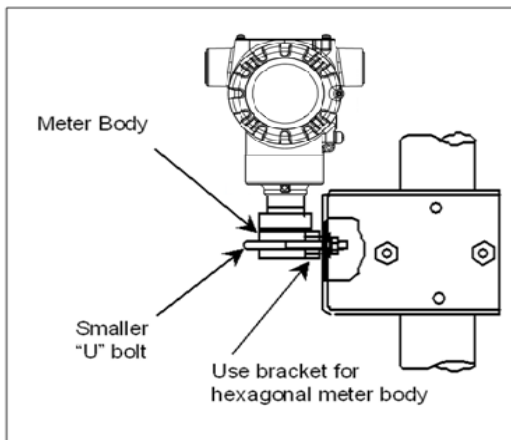

Figure 3: LGP and LAP models

Rotating Transmitter Housing

Loosen set screw on outside neck of transmitter one full turn. Rotate Transmitter housing in maximum of 180 degree increment in left or right direction from center to position you require and tighten set screw (1.46 to 1.68Nm/13 to 15lb-in).

Figure 4 Example – Rotating Transmitter Housing.

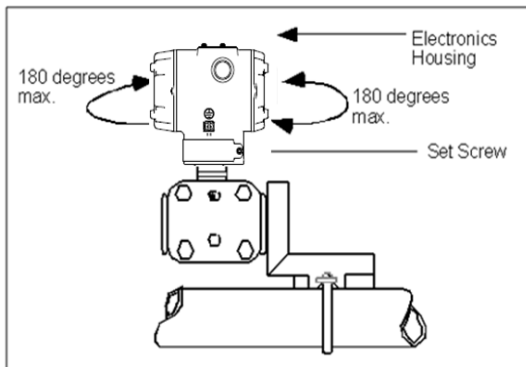

Figure 4: Rotating Transmitter Housing

Leveling Transmitters with Small Absolute or Differential Pressure Spans

Mounting position of these transmitters is critical due to the smaller transmitter spans.

To minimize these positional effects on calibration (zero shift), take the appropriate mounting precautions that follow for the given transmitter model.

See Figure 5 for suggestions on how to level the transmitter using a spirit balance.

To perform a **Zero Trim** after leveling, refer to **Trim the Transmitter** on page 16.

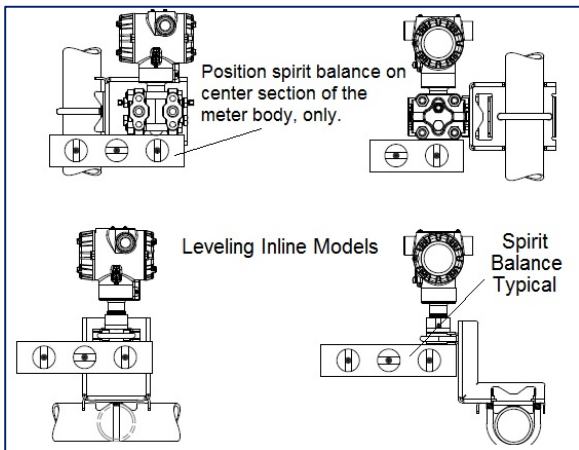

Figure 5: Using level to mount transmitter

For model STA840, STA822, STA740 or STA722 transmitters, you must ensure that the transmitter is vertical when mounting it. You do this by leveling the transmitter side-to-side and front-to-back.

Mount transmitter vertically to assure best accuracy. Position the spirit balance on the pressure connection surface of AP body.

Flange Mounting

To mount a flange mounted transmitter model, bolt the transmitter's flange to the flange pipe on the wall of the tank.

On insulated tanks, remove enough insulation to accommodate the flange extension. It is the End User's responsibility to provide a flange gasket and mounting hardware that are suitable for the transmitter's service condition.

To prevent degradation of performance in Flush-Mounted Flanged Transmitters, exercise care to ensure that the internal diameter of the flange gasket does not obstruct the sensing diaphragm.

To prevent degradation of performance in Extended Mount Flanged Transmitters, ensure that there is sufficient clearance in front of the sensing diaphragm body.

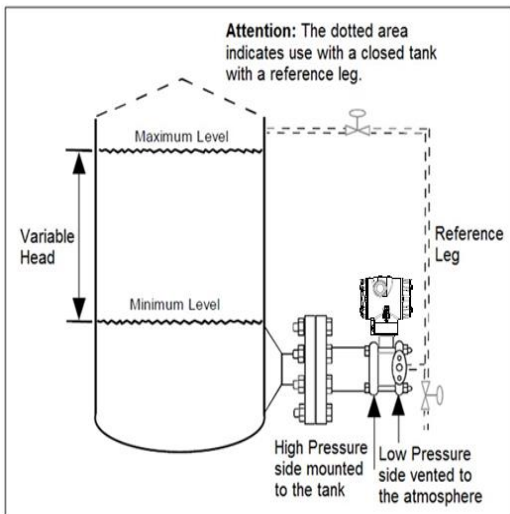

Figure 6: Flange mounting

Flush Mounting

To mount a flush mounted transmitter model, cut a hole for a 1-inch standard pipe in the tank or pipe where the transmitter is to be mounted. See Figure 7

Weld the 1-inch mounting sleeve to the wall of the tank or to the hole cut on the pipe. Insert the meter body of the transmitter into the mounting sleeve and secure with the locking bolt. Tighten the bolt to a torque of $6.4\text{Nm} \pm 0.30\text{Nm}$ [4.7ft.-lbs. $\pm 0.2\text{ft.-lbs.}$]

Once the transmitter is mounted, the transmitter housing can be rotated to the desired position. See Figure 7.

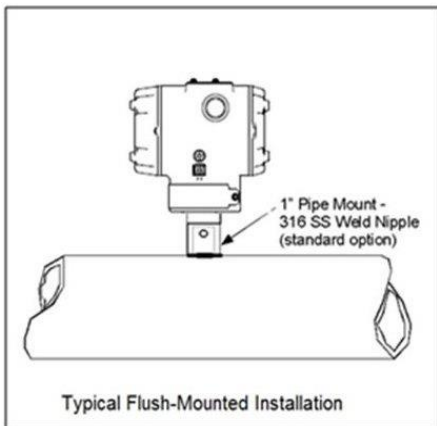

Figure 7: Flush Mounting

Remote Seal Mounting

Mount the transmitter at a remote distance determined by length of capillary tubing.

Note: The combination of tank vacuum and high pressure capillary head effect should not exceed 9psi (300mm Hg) absolute.

On insulated tanks, remove enough insulation to accommodate the mounting sleeve.

Figure 8 Example – Typical Remote Seal Transmitter installation.

Note: For Sanitary 3-A installations, only mount the transmitter outside of the Non-Product Contact area where incidental contact with the process material is unlikely, use a minimum capillary length of 1.5m (5ft.)

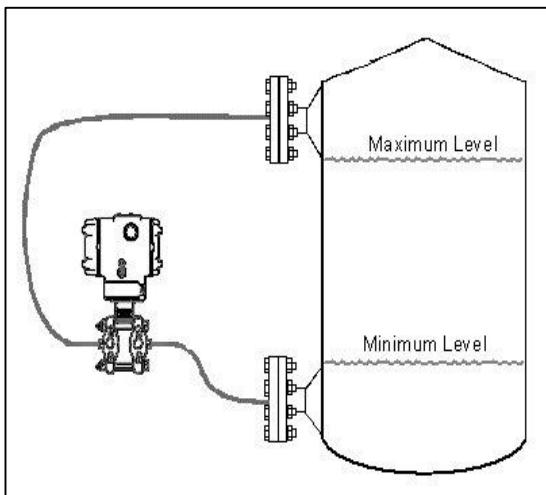

Figure 8: Remote Seal mounting

CONDUIT ENTRY PLUGS AND ADAPTERS

Procedures

It is the User/Installer's responsibility to install the Transmitters in accordance with national and local code requirements. Conduit entry plugs and adapters shall be suitable for the environment, shall be certified for the hazardous location when required and acceptable to the authority having jurisdiction for the plant.

CONDUIT ENTRY PRECAUTIONARY NOTICE

THE CONDUIT/CABLE GLAND ENTRIES OF THIS PRODUCT ARE SUPPLIED WITH PLASTIC DUST CAPS WHICH ARE NOT TO BE USED IN SERVICE. IT IS THE USER'S RESPONSIBILITY TO REPLACE THE DUST CAPS WITH CABLE GLANDS, ADAPTORS AND/OR BLANKING PLUGS WHICH ARE SUITABLE FOR THE ENVIRONMENT INTO WHICH THIS PRODUCT WILL BE INSTALLED. THIS INCLUDES ENSURING COMPLIANCE WITH HAZARDOUS LOCATION REQUIREMENTS AND REQUIREMENTS OF OTHER GOVERNING AUTHORITIES AS APPLICABLE.

Use the following procedures for installation:

Table 1 - Conduit Entry Plugs

Step	Action			
1	Remove the protective plastic cap from the threaded conduit entry.			
2	To ensure the environmental ingress protection rating on tapered threads (NPT), a non-hardening thread sealant may be used.			
3	Thread the appropriate size conduit plug (M20 or ½" NPT) into the conduit entry opening. Do not install conduit entry plugs in conduit entry openings if adapters or reducers will be used.			
4	Tighten adapters according to the following table.			
	Description	Tool	Torque	
	M20 Conduit Entry	10mm Hex Wrench	32Nm	24Lb-ft
	½" NPT Conduit Entry	10mm Hex Wrench	32Nm	24Lb-ft

Table 2 - Conduit Adapters

Step	Action		
1	Remove the protective plastic cap from the threaded conduit entry.		
2	To ensure the environmental ingress rating on tapered threads (NPT), a non-hardening thread sealant may be used.		
3	Thread the appropriate size adapter (M20 or ½ NPT) into the conduit entry opening		
4	Tighten adapters according to the following table.		
	Description	Tool	Torque
	½ to ¾ NPT Adapter	1 ¼" Wrench	32Nm 24Lb-ft

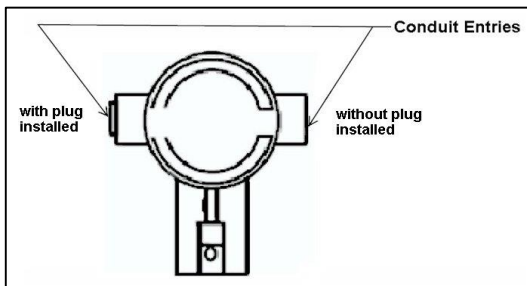
**Figure 9: Electronic Housing Conduit Entries**

Note. No plugs come installed in the housings. All housings come with temporary plastic dust protectors (red) installed and are not certified for use in any installation

WIRING CONNECTIONS AND POWER UP

Summary

The transmitter is designed to operate in a two-wire power/current loop with loop resistance and power supply voltage within the operating range shown in Figure 10

Loop wiring is connected to the transmitter by simply attaching the positive (+) and negative (-) loop wires to the positive (+) and negative (-) SIGNAL screw terminals on the terminal block in the transmitter's electronics housing shown in Figure 11. Each transmitter includes an internal terminal to connect it to earth ground. Also a ground terminal can be optionally added to the outside of the electronics housing. While it is not necessary to ground the transmitter for proper operation, doing so tends to minimize the possible effects of noise on the output signal and affords protection against lightning and static discharge.

An optional lightning terminal block can be installed in place of the non-lightning terminal block for Transmitters that will be installed in an area that is highly susceptible to lightning strikes.

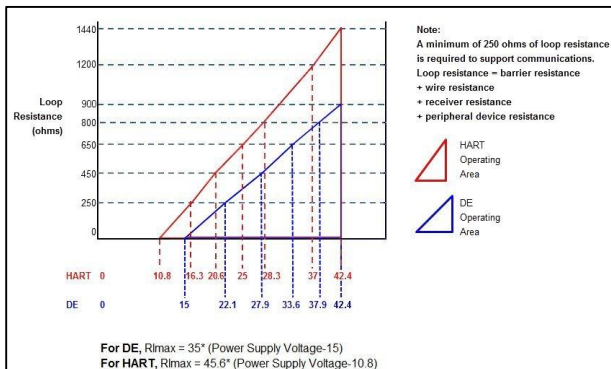

Figure 10: Two-wire power/current loop

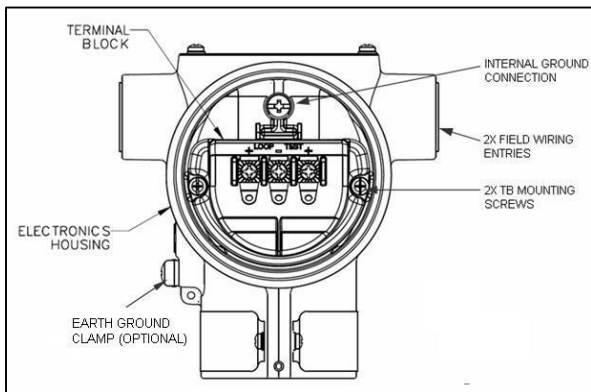

Figure 11: Terminal Block and Grounding Screw location

Note: The right hand terminal is for loop test and is not applicable for the Fieldbus option.

Wiring Variations

The above procedures are used to connect power to a Transmitter. For loop wiring and external wiring, detailed drawings are provided for Transmitter installation in non-intrinsically safe areas and for intrinsically safe loops in hazardous area locations. This procedure shows the steps for connecting power to the transmitter.



Wiring must comply with local codes, regulations and ordinances. Grounding may be required to meet various approval body certification, for example CE conformity. Refer to the *SmartLine Transmitter User's Manual*, Documents # 34-ST-25-35 (ST 800) or 34-ST-25-44 (ST 700) for details.

EXPLOSION-PROOF CONDUIT SEAL



When installed as explosion proof in a Division 1 Hazardous Location, keep covers tight while the Transmitter is energized. Disconnect power to the Transmitter in the non-hazardous area prior to removing end caps for service.

When installed as non-incendive equipment in a Division 2 hazardous location, disconnect power to the Transmitter in the non-hazardous area, or determine that the location is non-hazardous before disconnecting or connecting the Transmitter wires.

Transmitters installed as explosion proof in Class I, Division 1, Group A Hazardous (classified) locations in accordance with ANSI/NFPA 70, the US National Electrical Code, require a LISTED explosion proof seal to be installed in the conduit, within 18 inches (457.2mm) of the Transmitter. Crouse-Hinds type EYS/EYD or EYSX/EYDX are examples of LISTED explosion proof seals that meet this requirement.

Transmitters installed as explosion proof in Class I, Division 1, Group B, C or D hazardous (classified) locations do not require that explosion proof seal be installed in the conduit.

Step	Action
1	See Figure 11, above, for parts locations.
2	Remove the end cap cover from the terminal block end of the Electronics Housing
3	Feed loop power leads through one end of the conduit entrances on either side of the Electronics Housing. The Transmitter accepts up to 16 AWG wire.
4	Plug the unused conduit entrance as specified in Table 1.
5	Connect the positive loop power lead to the positive (+) terminal and the negative loop power lead to the negative (-) terminal. Note that the Transmitter is not polarity-sensitive.
6	Replace the end cap, and secure it in place using a 1.5mm hex wrench.

TRIM THE TRANSMITTER

Procedure to Trim the Transmitter

For a transmitter with a small differential pressure span, you must ensure that the transmitter is vertical when mounting it. You do this by leveling the transmitter side-to-side and front-to-back. See Figure 5 for suggestions on how to level the transmitter using a spirit balance. You must also zero the transmitter by following the steps in this table.

Step	Action
1	Attach the transmitter to the mounting bracket but do not completely tighten the mounting bolts
2	Connect a tube between the input connections in the high pressure (HP) and low pressure (LP) heads to eliminate the effects of any surrounding air currents.
3	Connect 24Vdc power to the transmitter. For HART/DE connect a digital voltmeter to monitor the PV output.
4	Use applicable communicator to establish communications with the transmitter. For DE transmitter use SFC, SCT, or MCT. For Hart, use MCT or other Hart Communicator with applicable Honeywell DD's. For Fieldbus, use NI FBUS tools with applicable Honeywell DD's.
5	While reading the transmitter's output on a communication tool or a voltmeter, position the transmitter so the output reading is at or near zero, and then completely tighten the mounting bolts.
6	The Local Display or applicable communicator can be used to perform the Zero Corrects. This corrects the transmitter for any minor error that may occur after the mounting bolts are tightened.
7	Remove the tube from between the input connections, the power, and the digital voltmeter or communication tool.

SET THE JUMPERS FOR HART/DE

Setting Failsafe Direction and Write Protect Jumpers

The SmartLine Pressure Transmitter (DE or HART) provides two jumpers to set the desired failsafe action and Write Protect option. See

The top jumper on the electronics module sets the Failsafe direction. The default setting is up-scale failsafe.

Up Scale drives the loop to a value greater than 21mA while Down Scale drives the loop to a value less than 3.8mA.

You can change the failsafe direction by moving the Failsafe Jumper (top jumper) to the desired position (UP or DOWN).

If your transmitter is operating in DE mode, the upscale failsafe action will cause the transmitter to generate a “+ infinity” digital signal, while a downscale failsafe will cause the transmitter to generate a “- infinity” digital signal.

The bottom jumper sets the Write Protect. The default setting is OFF (Unprotected).

When set to the ON (Protected) position, Changed configuration parameters cannot be written to the transmitter.

When set to the OFF (Unprotected) position, Changed configuration parameters can be written to the transmitter.

	<p>ATTENTION: <i>Electrostatic Discharge (ESD) hazards. Observe precautions for handling electrostatic sensitive devices</i></p>													
	<table border="1"> <thead> <tr> <th data-bbox="503 394 586 428">Step</th> <th data-bbox="586 394 907 428">Action</th> </tr> </thead> <tbody> <tr> <td data-bbox="503 428 586 481">1</td> <td data-bbox="586 428 907 481">Turn OFF Transmitter power.</td> </tr> <tr> <td data-bbox="503 481 586 605">2</td> <td data-bbox="586 481 907 605">Loosen the end-cap lock, and unscrew the end cap from the Electronics side of the Transmitter housing.</td> </tr> <tr> <td data-bbox="503 605 586 864">3</td> <td data-bbox="586 605 907 864"> <p>If applicable, carefully depress the tabs on the sides of the Display Module and pull it off.</p> <p>If necessary, move the interface connector from the Communication Module to the display module to provide the preferred orientation of the display module in the window.</p> </td> </tr> <tr> <td data-bbox="503 864 586 1086">4</td> <td data-bbox="586 864 907 1086">Set the Failsafe Jumper (top jumper) to the desired action (UP or DOWN). And the Write Protect jumper (Bottom jumper) to the desired behavior (Protected or Unprotected) See Table for jumper positioning.</td> </tr> <tr> <td data-bbox="503 1086 586 1163">5</td> <td data-bbox="586 1086 907 1163">Screw on the end cap and tighten the end-cap lock.</td> </tr> <tr> <td data-bbox="503 1163 586 1211">6</td> <td data-bbox="586 1163 907 1211">Turn ON Transmitter power.</td> </tr> </tbody> </table>	Step	Action	1	Turn OFF Transmitter power.	2	Loosen the end-cap lock, and unscrew the end cap from the Electronics side of the Transmitter housing.	3	<p>If applicable, carefully depress the tabs on the sides of the Display Module and pull it off.</p> <p>If necessary, move the interface connector from the Communication Module to the display module to provide the preferred orientation of the display module in the window.</p>	4	Set the Failsafe Jumper (top jumper) to the desired action (UP or DOWN). And the Write Protect jumper (Bottom jumper) to the desired behavior (Protected or Unprotected) See Table for jumper positioning.	5	Screw on the end cap and tighten the end-cap lock.	6
Step	Action													
1	Turn OFF Transmitter power.													
2	Loosen the end-cap lock, and unscrew the end cap from the Electronics side of the Transmitter housing.													
3	<p>If applicable, carefully depress the tabs on the sides of the Display Module and pull it off.</p> <p>If necessary, move the interface connector from the Communication Module to the display module to provide the preferred orientation of the display module in the window.</p>													
4	Set the Failsafe Jumper (top jumper) to the desired action (UP or DOWN). And the Write Protect jumper (Bottom jumper) to the desired behavior (Protected or Unprotected) See Table for jumper positioning.													
5	Screw on the end cap and tighten the end-cap lock.													
6	Turn ON Transmitter power.													

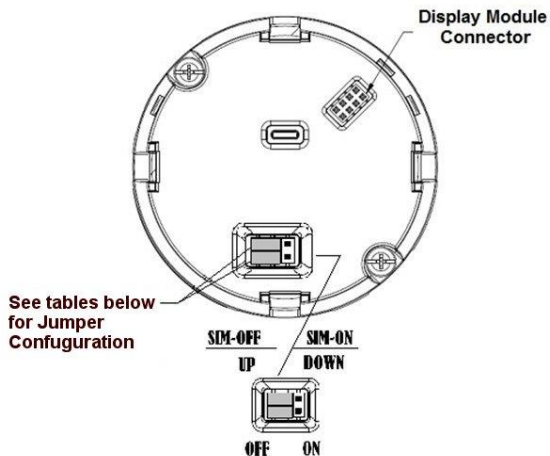

Figure 12: Jumper Location HART/DE

Table 3 - Jumper Settings

Jumper Settings	Description
	<i>Failsafe = UP (High)</i> <i>Write Protect = OFF (Not Protected)</i>
	<i>Failsafe = DOWN (Low)</i> <i>Write Protect = OFF (Not Protected)</i>
	<i>Failsafe = UP (High)</i> <i>Write Protect = ON (Protected)</i>
	<i>Failsafe = DOWN (Low)</i> <i>Write Protect = ON (Protected)</i>

WRITE PROTECT JUMPER ON FOUNDATION FIELDBUS (FF)

On Foundation Fieldbus transmitters there is no Failsafe jumper selection but there is a Write Protect jumper.

The bottom jumper sets the Write Protect. The default setting is OFF (Unprotected).

When set to the ON (Protected) position, changes to configuration parameters cannot be written to the transmitter.

When set to the OFF (Unprotected) position, changes to configuration parameters can be written to the transmitter.





	ATTENTION: Electrostatic Discharge (ESD) hazards. Observe precautions for handling electrostatic sensitive devices.
	WARNING! PERSONAL INJURY: Risk of electrical shock. Disconnect power before proceeding. HAZARDOUS LIVE voltages greater than 30Vrms, 42.4Vpeak, or 60VDC may be accessible. Failure to comply with these instructions could result in death or serious injury.
Step	Action
1	Turn OFF Transmitter power.
2	Loosen the end-cap lock, and unscrew the end cap from the Electronics side of the Transmitter housing.
3	If applicable, carefully depress the tabs on the sides of the Display Module and pull it off.
4	Set the Write Protect jumper (Bottom jumper) to the desired behavior (Protected or Unprotected). See Error! Reference source not found.
5	Screw on the end cap and tighten the end-cap lock.
6	Turn ON Transmitter power.

Table 4 - Fieldbus Write Protect

Image	Description
	Fieldbus SIM Mode = OFF Write Protect = OFF (Not Protected)
	Fieldbus SIM Mode = OFF Write Protect = ON (Protected)
	Fieldbus SIM Mode = ON Write Protect = OFF (Not Protected)

CONFIGURATION GUIDE

The SmartLine Pressure transmitters has 3 display options:

- Basic LED Display: 2 lines, 16 characters (ST 700 Std/800 only) - Table 5
- Advanced LED Display: Multi-line display (ST 800 only) - Table 6
- Simple LED Display: 2 lines, 6 character (ST 700 Std only) - Table 7

Table 5 – Basic Display Configuration (ST 700Std/ST800 only)

Parameter	Applicability	Locally Writable
LCD Contrast	Always	Yes
Rotation Time	FF Only	Yes
PV Display	HART/DE	Yes
PV Decimals	HART/DE	Yes
Pressure Units	HART/DE	Yes
Range/Cal Units	FF Only	Yes
Zero Correct	Always	Yes
LRV Correct	HART/DE	Yes
URV Correct	HART/DE	Yes
Reset Corrects	HART/DE	Yes
DAC Zero Trim	HART/DE	Yes
DAC Span Trim	HART/DE	Yes
Loop Test	HART/DE	Yes
LRV	Always	HART/DE
URV	Always	HART/DE
Damping	Always	HART/DE
NAMUR	HART/DE	Yes
Filter Perf	HART only	Yes
Transfer Func	HART/DE DP Only	Yes
Flow Cutoff	HART/DE DP Only	Yes
Flow Breakpoint	HART/DE DP Only	Yes
Tag ID	HART/DE	Yes
Install Date	HART/FF	HART Only
Firmware	Always	No
Protocol	Always	No
Model Key	Always	No
Exit Menu	Always	n/a

Table 6 – Advanced Display Configuration (ST 800 only)

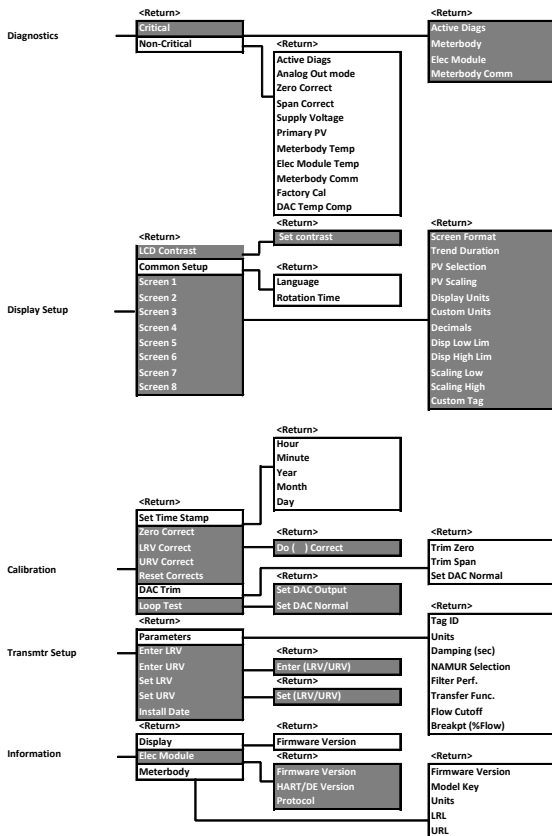

Table 7 - Simple Display Menu (ST 700 Std only)

UNITS Set Pressure Units	Visible for all PV except Flow	Yes
FLUNITS Set Flow Units	Visible where PV is Flow	Yes
SCLLOW Scaling Low	Visible where PV is Flow	Yes
SCLHIG Scaling High		
ENTLRV / ENTURV Set Lower Range Value / Upper Range Value (Numeric Value)	Always	Yes
ZEROTR DAC Zero Trim	Always	Yes
SPANTR DAC Span Trim	Always	Yes
LPTEST Loop Test	Always	Yes
SETLRV / SET URV Set Lower Range Value / Upper Range Value (PV Value)	Always	Yes
CNTRST Set LCD Contrast	Always	Yes
EXIT	Always	N/A

Sales and Service

For application assistance, current specifications, pricing, or name of the nearest Authorized Distributor, contact one of the offices below.

<p>ASIA PACIFIC (TAC) hfs-tac-support@honeywell.com Australia Honeywell Limited, Phone: +(61) 7-3846 1255, FAX: +(61) 7-3840 6481 Toll Free 1300-36-39-36, Toll Free Fax: 1300-36-04-70 China – PRC – Shanghai, Honeywell China Inc. Phone: (86-21) 5257-4568, Fax: (86-21) 6237-2826 Singapore, Honeywell Pte Ltd. Phone: +(65) 6580 3278. Fax: +(65) 6445-3033 South Korea, Honeywell Korea Co Ltd. Phone:+(822)799 6114. Fax:+(822) 792 9015</p>
<p>EMEA, Phone: + 80012026455 or +44 (0)1202645583. FAX: +44 (0) 1344 655554 Email: (Sales) sc-cp-apps-salespa62@honeywell.com or (TAC) hfs-tac-support@honeywell.com</p>
<p>AMERICAS, Honeywell Process Solutions, Phone: (TAC) 1-800-423-9883 or 215/641-3610. (Sales) 1-800-343-0228. Email: (Sales) FP-Sales-Apps@Honeywell.com or (TAC) hfs-tac-support@honeywell.com</p>

WARRANTY/REMEDY

Honeywell warrants goods of its manufacture as being free of defective materials and faulty workmanship. Contact your local sales office for warranty information.

If warranted goods are returned to Honeywell during the period of coverage, Honeywell will repair or replace without charge those items it finds defective. The foregoing is Buyer's sole remedy and is **in lieu of all other warranties, expressed or implied, including those of merchantability and fitness for a particular purpose.**

Specifications may change without notice. The information we supply is believed to be accurate and reliable as of this printing. However, we assume no responsibility for its use.

While we provide application assistance personally, through our literature and the Honeywell web site, it is up to the customer to determine the suitability of the product in the application.



For more information

To learn more about SmartLine Transmitters, visit www.honeywellprocess.com

Or contact your Honeywell Account Manager

Process Solutions
Honeywell
1250 W Sam Houston Pkwy S
Houston, TX 77042

Honeywell Control Systems Ltd
Honeywell House, Skimped Hill Lane
Bracknell, England, RG12 1EB

Shanghai City Centre, 100 Jungi Road
Shanghai, China 20061

www.honeywellprocess.com

Honeywell

34-ST-25-36, Rev.5
December 2016

©2016 Honeywell International Inc.