

GUYED TOWERS

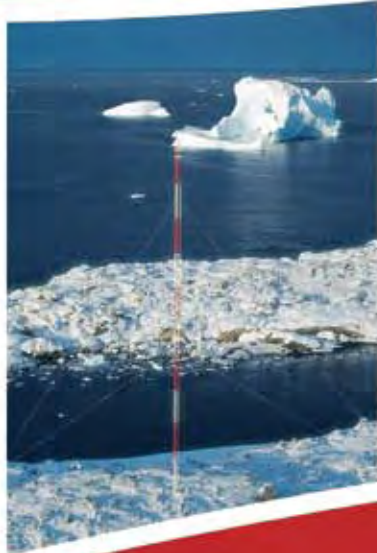

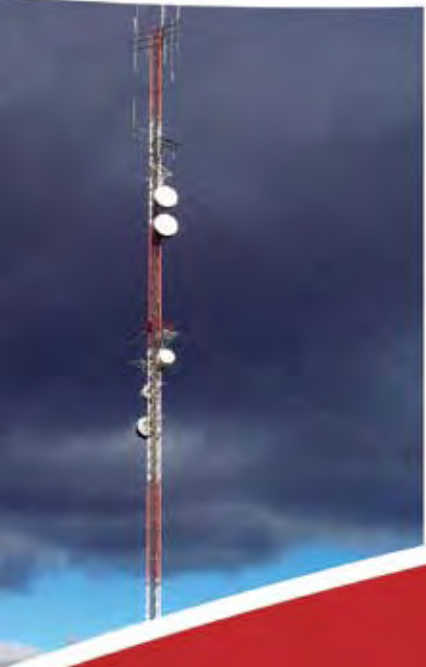

ROHN began manufacturing the G-Series line of towers in the early 1950's. Starting with the ROHN No. 5 tower, there was an ever present drive for a superior tower design. The No. 5 soon led to the ROHN No. 6 and continued through the No.10, 11, 20, 25, 30, 40 and 50 towers. ROHN originally coated the lightweight towers with a hot-dipped enamel coating called RohnKote. The alternative to RohnKote was hot-dipped galvanizing. The galvanized option was identified by the now famous "G" suffix added to the tower model. The G-Series was born! The numbers have settled to the four models listed below and hot-dip galvanizing is the coating of choice for towers today.

ROHN's G-Series towers are designed for strength and versatility. The towers are constructed with high strength steel tubing or solid round legs. ROHN's exclusive Zig-Zag solid-rod bracing provides exceptional strength. As they were in the 1950's, each ROHN G-Series tower continues to be hot-dip galvanized for corrosion protection.

25G | 45G | 55G | 65G

The 25G is a light weight tubular tower with solid braces. The tower sections are most often guyed, but can also be used in bracketed and self-supporting applications. Standard sections are 10' in length, but are also available in a 7' length, which is UPS shippable. This tower model has several top options, as well as a variety of tower accessories. The 25G has several base options, including: base cast in concrete, base plate with anchor bolts and also a hinged base.

Standard Design Tower Heights

Guyed: Up to 190'

Bracketed: Up to 100'

Self-Supporting: Up to 40'



25G | 45G | 55G | 65G

The 45G is a light weight tower, available with tubular or solid round legs with solid braces. The tower sections are most often guyed, but can also be used in bracketed and self-supporting applications. Standard sections are 10' in length, but are also available in a 20' length when ordering solid sections. This tower model has several top options, as well as a variety of tower accessories. The 45G has several base options, including: base cast in concrete, base plate with anchor bolts and also a hinged base. This tower is a true multi-use structure.

Standard Design Tower Heights

Guyed: Up to 300' [45G] and 350' [45GSR]

Bracketed: Up to 100'

Self-Supporting: Up to 45'



STANDARD 45G GUYED TOWER

ROHN 45G
The first. The original.



45G

GENERAL USE

The 45G is a true multi-use structure that provides excellent strength for applications up to 300'. It is offered with heavy steel round legs to satisfy a variety of needs under varied conditions.

FEATURES

- Completely hot-dip galvanized after fabrication
- Built on a 16 3/4" equilateral triangle design
- High strength tubular legs joined by Zig-Zag® cross members
- Each section contains all required nuts and bolts shipped with section
- Continuous solid round steel bracing

CAUTION

Mixing copies of ROHN towers with ROHN towers is dangerous and voids all engineering and warranty data supplied by ROHN. Materials used by others are not the same quality and have not been tested or engineered by ROHN. Mixing ROHN tower sections with non-ROHN products may cause tower failure or injury.

Per Rev G requirements, any structure greater than 10' requires a climber safety device. Please see page 65 for ordering information.





STANDARD 45G GUYED TOWER SECTIONS

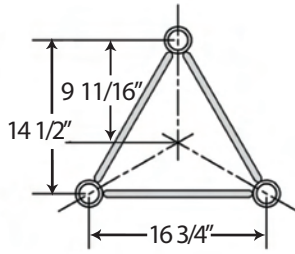

QUICK REFERENCE	
PARTS & ACCESSORIES	PAGES 63-65
GROUNDING INFORMATION	PAGE 66
FOUNDATION INFORMATION	PAGES 66-69

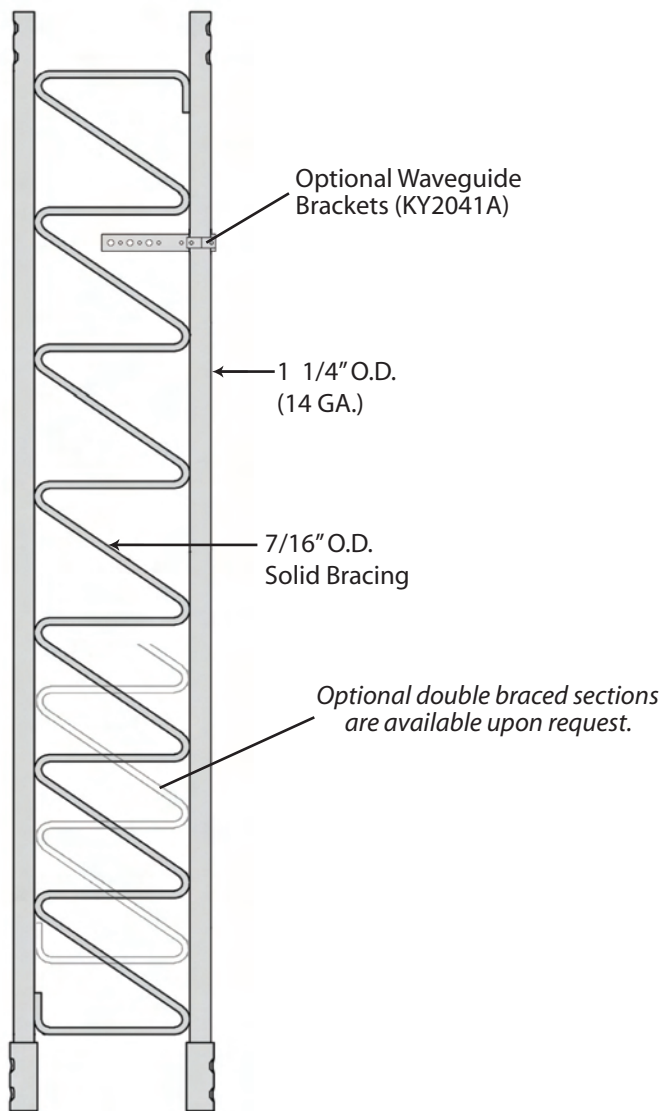

**STANDARD SECTION
45G - 10' Section**

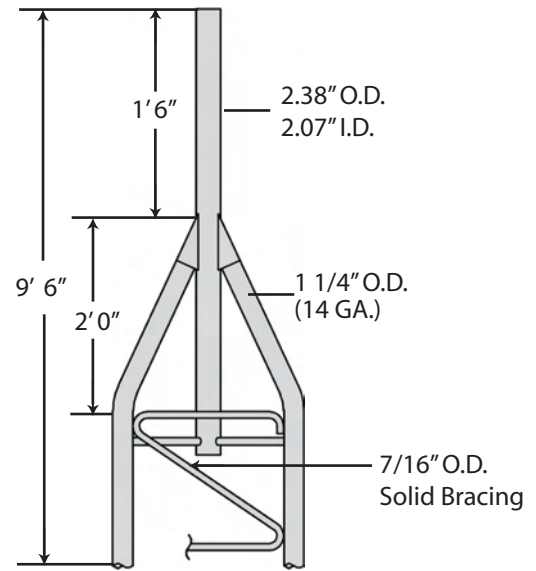

**STANDARD TOP SECTION
45AG2**

Additional 45G top sections are shown on page 63.

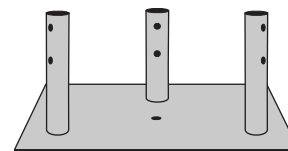

**CONCRETE BASE PLATE
BPC45G***

FOR USE WITH 3/4X12PP PIER PIN EMBEDDED IN CONCRETE.

Additional base sections are available, please see page 64.

* Towers mounted on these bases must be bracketed or guyed at all times. Temporary steel guying may also be necessary during installation and dismantling.



BUYERS GUIDE
STANDARD DESIGNS - 45G
90MPH REV. G [3-SECOND GUST]
70MPH REV. F [FASTEST MILE]

Design Criteria

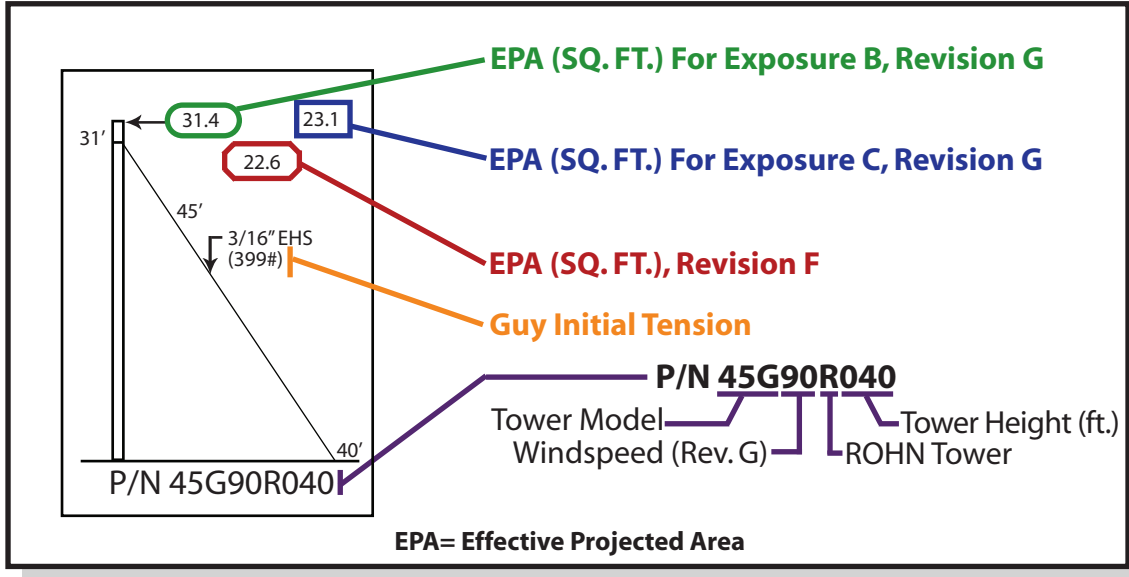

This document is to serve as a guide for sizing and purchasing the 45G tower. Tower and foundation installations should be performed by qualified and experienced personnel using assembly drawings provided with each tower.

DESIGN NOTES:

1. Tower designs are in accordance with ANSI/TIA-222-F and ANSI/TIA-222-G, Class I Structures, Topographic Category 1.
2. Design assumes towers are installed on level ground. Lower EPA values will apply for roof mounted towers or for sites located on unusual terrain.
3. Designs assume two 1/2" diameter lines on each tower face.
4. Anchor radius is from tower base to intersection of anchor rod with ground.
5. Guy chord lengths shown are based on level ground. Initial tensions for guys are shown in () in pounds at 60° Fahrenheit.
6. Antenna and mounts are assumed symmetrically placed at the tower top.

PARTS LIST NOTES:

1. Items listed are required for complete guyed towers.
2. Base and anchor foundations listed refer to standard foundation designations.
3. Guys provided with each standard tower are based on level ground conditions with an additional 6% length.
4. Rev G anchor grounding (AGK1GGX) and base grounding (BGK3GGX) are included with the tower material.
5. Assembly drawings and a safety package (P/N: ACWS) are included with each tower.
6. Parts lists are subject to change based on availability or revised design criteria.

FOR FOUNDATION INFORMATION, PLEASE SEE PAGES 66-69.

FOR GENERAL INSTALLATION INFORMATION, PLEASE SEE PAGES 147-153.



STANDARD DESIGN - 45G

90MPH REV. G, 70MPH REV. F

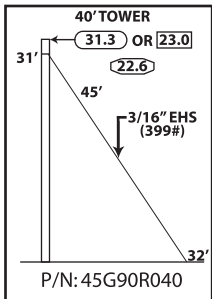

TOWER PARTS INCLUDED	45G	45AG2	BPC45G	GA45GD	FDNS	
					BASE	ANCHOR
	3	1	1	1	CB1G	AB2
GUYS & CONNECTIONS INCLUDED	3/16EHS	BG2142	5/16THH	1/2TBE&J	TBSAFETY	
	150'	6	6	3	3	
ANCHORS & GROUNDING INCLUDED	GAC3455TOP	AGK1GGX	BGK3GGX	CPC.5/.75	3/4x12PP	
	3	1	3	3	1	

40' ROHN 45G
All parts shown in table are included when ordering
Part No: 45G90R040

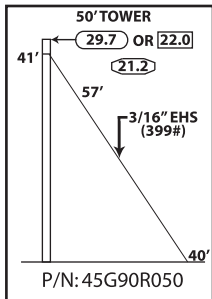

TOWER PARTS INCLUDED	45G	45AG2	BPC45G	GA45GD	FDNS	
					BASE	ANCHOR
	4	1	1	1	CB1G	AB2
GUYS & CONNECTIONS INCLUDED	3/16EHS	BG2142	5/16THH	1/2TBE&J	TBSAFETY	
	200'	6	6	3	3	
ANCHORS & GROUNDING INCLUDED	GAC3455TOP	AGK1GGX	BGK3GGX	CPC.5/.75	3/4x12PP	
	3	1	3	3	1	

50' ROHN 45G
All parts shown in table are included when ordering
Part No: 45G90R050

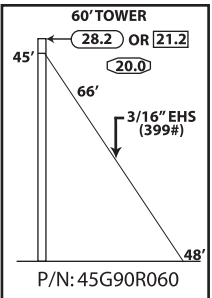

TOWER PARTS INCLUDED	45G	45AG2	BPC45G	GA45GD	FDNS	
					BASE	ANCHOR
	5	1	1	1	CB1G	AB2
GUYS & CONNECTIONS INCLUDED	3/16EHS	BG2142	5/16THH	1/2TBE&J	TBSAFETY	
	225'	6	6	3	3	
ANCHORS & GROUNDING INCLUDED	GAC3455TOP	AGK1GGX	BGK3GGX	CPC.5/.75	3/4x12PP	
	3	1	3	3	1	

60' ROHN 45G
All parts shown in table are included when ordering
Part No: 45G90R060

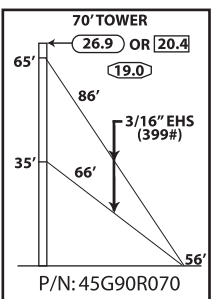

TOWER PARTS INCLUDED	45G	45AG2	BPC45G	GA45GD	FDNS	
					BASE	ANCHOR
	6	1	1	2	CB1G	AB2
GUYS & CONNECTIONS INCLUDED	3/16EHS	BG2142	5/16THH	1/2TBE&J	TBSAFETY	
	500'	12	12	6	3	
ANCHORS & GROUNDING INCLUDED	GAC3455TOP	AGK1GGX	BGK3GGX	CPC.5/.75	3/4x12PP	
	3	1	3	3	1	

70' ROHN 45G
All parts shown in table are included when ordering
Part No: 45G90R070

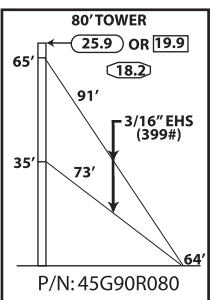

TOWER PARTS INCLUDED	45G	45AG2	BPC45G	GA45GD	FDNS	
					BASE	ANCHOR
	7	1	1	2	CB1G	AB2
GUYS & CONNECTIONS INCLUDED	3/16EHS	BG2142	5/16THH	1/2TBE&J	TBSAFETY	
	525'	12	12	6	3	
ANCHORS & GROUNDING INCLUDED	GAC3455TOP	AGK1GGX	BGK3GGX	CPC.5/.75	3/4x12PP	
	3	1	3	3	1	

80' ROHN 45G
All parts shown in table are included when ordering
Part No: 45G90R080



STANDARD DESIGN - 45G
90MPH REV. G, 70MPH REV. F

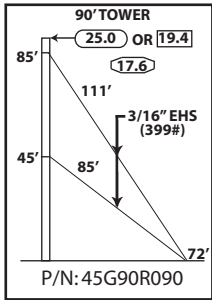

TOWER PARTS INCLUDED	45G	45AG2	BPC45G	GA45GD	FDNS	
					BASE	ANCHOR
	8	1	1	2	CB1G	AB2
GUYS & CONNECTIONS INCLUDED	3/16EHS	BG2142	5/16THH	1/2TBE&J	TBSAFETY	
	625'	12	12	6	3	
ANCHORS & GROUNDING INCLUDED	GAC3455TOP	AGK1GGX	BGK3GGX	CPC.5/.75	3/4x12PP	
	3	1	3	3	1	

90' ROHN 45G
All parts shown in table are included when ordering
Part No: 45G90R090

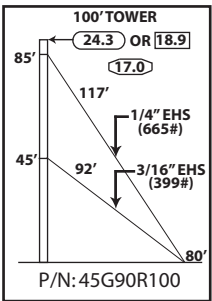

TOWER PARTS INCLUDED	45G	45AG2	BPC45G	GA45GD	FDNS		
					BASE	ANCHOR	
	9	1	1	2	CB1G	AB2	
GUYS & CONNECTIONS INCLUDED	3/16EHS	1/4EHS	BG2142	BG2144	5/16THH	3/8THH	1/2TBE&J
	300'	375'	6	6	6	6	6
ANCHORS & GROUNDING INCLUDED	GAC3455TOP	AGK1GGX	BGK3GGX	CPC.5/.75	3/4x12PP	TBSAFETY	
	3	1	3	3	1	3	

100' ROHN 45G
All parts shown in table are included when ordering
Part No: 45G90R100

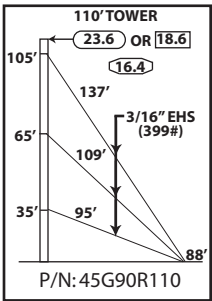

TOWER PARTS INCLUDED	45G	45AG2	BPC45G	GA45GD	FDNS	
					BASE	ANCHOR
	10	1	1	3	CB1G	AB2
GUYS & CONNECTIONS INCLUDED	3/16EHS	BG2142	5/16THH	1/2TBE&J	TBSAFETY	
	1100'	18	18	9	3	
ANCHORS & GROUNDING INCLUDED	GAC3455TOP	AGK1GGX	BGK3GGX	CPC.5/.75	3/4x12PP	
	3	1	3	3	1	

110' ROHN 45G
All parts shown in table are included when ordering
Part No: 45G90R110

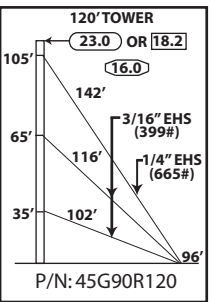

TOWER PARTS INCLUDED	45G	45AG2	BPC45G	GA45GD	FDNS		
					BASE	ANCHOR	
	11	1	1	3	CB1G	AB2	
GUYS & CONNECTIONS INCLUDED	3/16EHS	1/4EHS	BG2142	BG2144	5/16THH	3/8THH	1/2TBE&J
	700'	475'	12	6	12	6	9
ANCHORS & GROUNDING INCLUDED	GAC3455TOP	AGK1GGX	BGK3GGX	CPC.5/.75	3/4x12PP	TBSAFETY	
	3	1	3	3	1	3	

120' ROHN 45G
All parts shown in table are included when ordering
Part No: 45G90R120

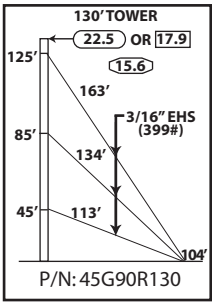

TOWER PARTS INCLUDED	45G	45AG2	BPC45G	GA45GD	FDNS	
					BASE	ANCHOR
	12	1	1	3	CB1G	AB2
GUYS & CONNECTIONS INCLUDED	3/16EHS	BG2142	5/16THH	1/2TBE&J	TBSAFETY	
	1325'	18	18	9	3	
ANCHORS & GROUNDING INCLUDED	GAC3455TOP	AGK1GGX	BGK3GGX	CPC.5/.75	3/4x12PP	
	3	1	3	3	1	

130' ROHN 45G
All parts shown in table are included when ordering
Part No: 45G90R130



STANDARD DESIGN - 45G 90MPH REV. G, 70MPH REV. F

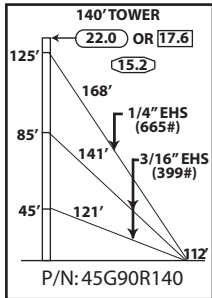

TOWER PARTS INCLUDED	45G	45AG2	BPC45G	GA45GD	FDNS		
	13	1	1	3	BASE CB1G	ANCHOR AB2	
GUYS & CONNECTIONS INCLUDED	3/16EHS	1/4EHS	BG2142	BG2144	5/16THH	3/8THH	1/2TBE&J
	850'	550'	12	6	12	6	9
ANCHORS & GROUNDING INCLUDED	GAC3455TOP	AGK1GGX	BGK3GGX	CPC.5/.75	3/4x12PP	TBSAFETY	
	3	1	3	3	1	3	

140' ROHN 45G
All parts shown in table are included when ordering
Part No: 45G90R140

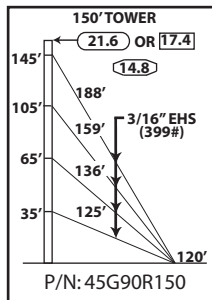

TOWER PARTS INCLUDED	45G	45AG2	BPC45G	GA45GD	FDNS	
	14	1	1	4	BASE CB1G	ANCHOR AB2
GUYS & CONNECTIONS INCLUDED	3/16EHS	BG2142	5/16THH	1/2TBE&J	TBSAFETY	
	1950'	24	24	12	3	
ANCHORS & GROUNDING INCLUDED	GAC3455TOP	AGK1GGX	BGK3GGX	CPC.5/.75	3/4x12PP	
	3	1	3	3	1	

150' ROHN 45G
All parts shown in table are included when ordering
Part No: 45G90R150

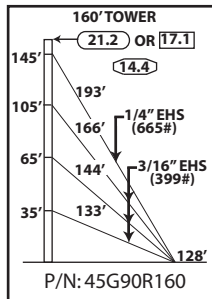

TOWER PARTS INCLUDED	45G	45AG2	BPC45G	GA45GD	FDNS		
	15	1	1	4	BASE CB1G	ANCHOR AB2	
GUYS & CONNECTIONS INCLUDED	3/16EHS	1/4EHS	BG2142	BG2144	5/16THH	3/8THH	1/2TBE&J
	1425'	625'	18	6	18	6	12
ANCHORS & GROUNDING INCLUDED	GAC3455TOP	AGK1GGX	BGK3GGX	CPC.5/.75	3/4x12PP	TBSAFETY	
	3	1	3	3	1	3	

160' ROHN 45G
All parts shown in table are included when ordering
Part No: 45G90R160

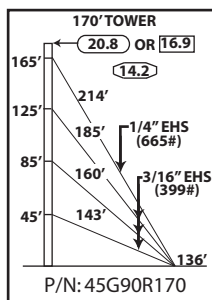

TOWER PARTS INCLUDED	45G	45AG2	BPC45G	GA45GD	FDNS		
	16	1	1	4	BASE CB1G	ANCHOR AB2	
GUYS & CONNECTIONS INCLUDED	3/16EHS	1/4EHS	BG2142	BG2144	5/16THH	3/8THH	1/2TBE&J
	1575'	700'	18	6	18	6	12
ANCHORS & GROUNDING INCLUDED	GAC3455TOP	AGK1GGX	BGK3GGX	CPC.5/.75	3/4x12PP	TBSAFETY	
	3	1	3	3	1	3	

170' ROHN 45G
All parts shown in table are included when ordering
Part No: 45G90R170

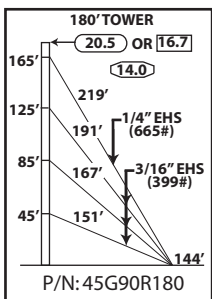

TOWER PARTS INCLUDED	45G	45AG2	BPC45G	GA45GD	FDNS		
	17	1	1	4	BASE CB1G	ANCHOR AB2	
GUYS & CONNECTIONS INCLUDED	3/16EHS	1/4EHS	BG2142	BG2144	5/16THH	3/8THH	1/2TBE&J
	1625'	700'	18	6	18	6	12
ANCHORS & GROUNDING INCLUDED	GAC3455TOP	AGK1GGX	BGK3GGX	CPC.5/.75	3/4x12PP	TBSAFETY	
	3	1	3	3	1	3	

180' ROHN 45G
All parts shown in table are included when ordering
Part No: 45G90R180



STANDARD DESIGN - 45G
90MPH REV. G, 70MPH REV. F

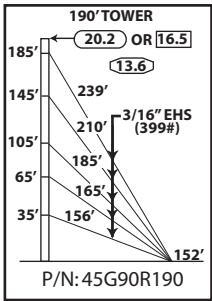

TOWER PARTS INCLUDED	45G	45AG2	BPC45G	GA45GD	FDNS	
					BASE	ANCHOR
	18	1	1	5	CB1G	AB2
GUYS & CONNECTIONS INCLUDED	3/16EHS	BG2142	5/16THH	1/2TBE&J	TBSAFETY	
	3050'	30	30	15	3	
ANCHORS & GROUNDING INCLUDED	GAC3455TOP	AGK1GGX	BGK3GGX	CPC.5/.75	3/4x12PP	
	3	1	3	3	1	

190' ROHN 45G
All parts shown in table are included when ordering
Part No: 45G90R190

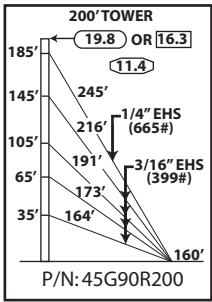

TOWER PARTS INCLUDED	45G	BPC45G	APL45G	GA45GD	FDNS		
					BASE	ANCHOR	
	20	1	1	5	CB1G	AB2	
GUYS & CONNECTIONS INCLUDED	3/16EHS	1/4EHS	BG2142	BG2144	5/16THH	3/8THH	1/2TBE&J
	2375'	800'	24	6	24	6	15
ANCHORS & GROUNDING INCLUDED	GAC3455TOP	AGK1GGX	BGK3GGX	CPC.5/.75	3/4x12PP	TBSAFETY	
	3	1	3	3	1	3	

200' ROHN 45G
All parts shown in table are included when ordering
Part No: 45G90R200

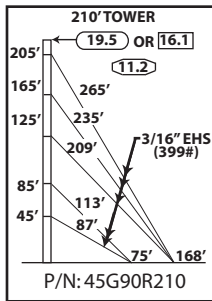

TOWER PARTS INCLUDED	45G	APL45G	BPC45G	GA45GD	BASE	INNER ANCHOR	OUTER ANCHOR
					21	1	1
GUYS & CONNECTIONS INCLUDED	3/16EHS	BG2142	5/16THH	1/2TBE&J	TBSAFETY		
	2900'	30	30	15	6		
ANCHORS & GROUNDING INCLUDED	GAC3455TOP	AGK1GGX	BGK3GGX	CPC.5/.75	3/4x12PP		
	6	2	3	6	1		

210' ROHN 45G
All parts shown in table are included when ordering
Part No: 45G90R210

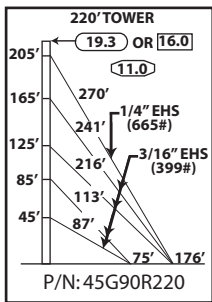

TOWER PARTS INCLUDED	45G	BPC45G	APL45G	GA45GD	BASE	INNER ANCHOR	OUTER ANCHOR
					22	1	1
GUYS & CONNECTIONS INCLUDED	3/16EHS	1/4EHS	BG2142	BG2144	5/16THH	3/8THH	1/2TBE&J
	2100'	875'	24	6	24	6	15
ANCHORS & GROUNDING INCLUDED	GAC3455TOP	AGK1GGX	BGK3GGX	CPC.5/.75	3/4x12PP	TBSAFETY	
	6	2	3	6	1	6	

220' ROHN 45G
All parts shown in table are included when ordering
Part No: 45G90R220

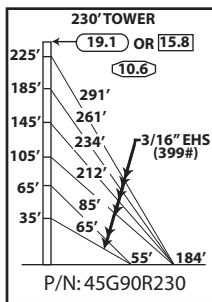

TOWER PARTS INCLUDED	45G	APL45G	BPC45G	GA45GD	BASE	INNER ANCHOR	OUTER ANCHOR
					23	1	1
GUYS & CONNECTIONS INCLUDED	3/16EHS	BG2142	5/16THH	1/2TBE&J	TBSAFETY		
	3675'	36	36	18	6		
ANCHORS & GROUNDING INCLUDED	GAC3455TOP	AGK1GGX	BGK3GGX	CPC.5/.75	3/4x12PP		
	6	2	3	6	1		

230' ROHN 45G
All parts shown in table are included when ordering
Part No: 45G90R230



STANDARD DESIGN - 45G

90MPH REV. G, 70MPH REV. F

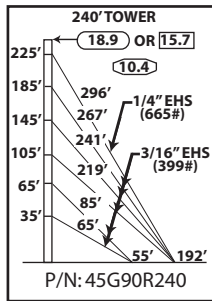

TOWER PARTS INCLUDED	45G	BPC45G	APL45G	GA45GD	BASE	INNER ANCHOR	OUTER ANCHOR
	24	1	1	6	CB2G	AB1	AB2
GUYS & CONNECTIONS INCLUDED	3/16EHS	1/4EHS	BG2142	BG2144	5/16THH	3/8THH	1/2TBE&J
	2800'	950'	30	6	30	6	18
ANCHORS & GROUNDING INCLUDED	GAC3455TOP	AGK1GGX	BGK3GGX	CPC.5/.75	3/4x12PP	TBSAFETY	
	6	2	3	6	1	6	

240' ROHN 45G
All parts shown in table are included when ordering
Part No: 45G90R240

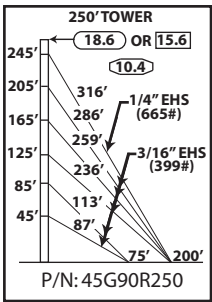

TOWER PARTS INCLUDED	45G	BPC45G	APL45G	GA45GD	BASE	INNER ANCHOR	OUTER ANCHOR
	25	1	1	6	CB2G	AB1	AB2
GUYS & CONNECTIONS INCLUDED	3/16EHS	1/4EHS	BG2142	BG2144	5/16THH	3/8THH	1/2TBE&J
	3125'	1025'	30	6	30	6	18
ANCHORS & GROUNDING INCLUDED	GAC3455TOP	AGK1GGX	BGK3GGX	CPC.5/.75	3/4x12PP	TBSAFETY	
	6	2	3	6	1	6	

250' ROHN 45G
All parts shown in table are included when ordering
Part No: 45G90R250

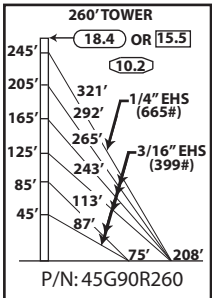

TOWER PARTS INCLUDED	45G	BPC45G	APL45G	GA45GD	BASE	INNER ANCHOR	OUTER ANCHOR
	26	1	1	6	CB3G	AB2	AB2
GUYS & CONNECTIONS INCLUDED	3/16EHS	1/4EHS	BG2142	BG2144	5/16THH	3/8THH	1/2TBE&J
	3200'	1025'	30	6	30	6	18
ANCHORS & GROUNDING INCLUDED	GAC3455TOP	AGK1GGX	BGK3GGX	CPC.5/.75	3/4x12PP	TBSAFETY	
	6	2	3	6	1	6	

260' ROHN 45G
All parts shown in table are included when ordering
Part No: 45G90R260

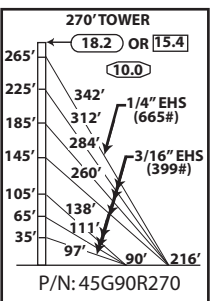

TOWER PARTS INCLUDED	45G	BPC45G	APL45G	GA45GD	BASE	INNER ANCHOR	OUTER ANCHOR
	27	1	1	7	CB3G	AB2	AB2
GUYS & CONNECTIONS INCLUDED	3/16EHS	1/4EHS	BG2142	BG2144	5/16THH	3/8THH	1/2TBE&J
	3825'	1100'	36	6	36	6	21
ANCHORS & GROUNDING INCLUDED	GAC3455TOP	AGK1GGX	BGK3GGX	CPC.5/.75	3/4x12PP	TBSAFETY	
	6	2	3	6	1	6	

270' ROHN 45G
All parts shown in table are included when ordering
Part No: 45G90R270

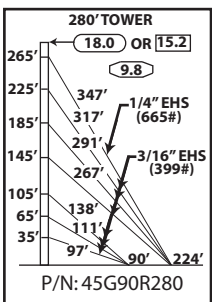

TOWER PARTS INCLUDED	45G	BPC45G	APL45G	GA45GD	BASE	INNER ANCHOR	OUTER ANCHOR
	28	1	1	7	CB3G	AB2	AB2
GUYS & CONNECTIONS INCLUDED	3/16EHS	1/4EHS	BG2142	BG2144	5/16THH	3/8THH	1/2TBE&J
	3900'	1125'	36	6	36	6	21
ANCHORS & GROUNDING INCLUDED	GAC3455TOP	AGK1GGX	BGK3GGX	CPC.5/.75	3/4x12PP	TBSAFETY	
	6	2	3	6	1	6	

280' ROHN 45G
All parts shown in table are included when ordering
Part No: 45G90R280



STANDARD DESIGN - 45G
90MPH REV. G, 70MPH REV. F

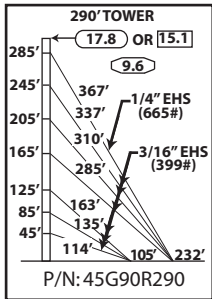

TOWER PARTS INCLUDED	45G	BPC45G	APL45G	GA45GD	BASE	INNER ANCHOR	OUTER ANCHOR
		29	1	1	7	CB3G	AB2
GUYS & CONNECTIONS INCLUDED	3/16EHS	1/4EHS	BG2142	BG2144	5/16THH	3/8THH	1/2TBE&J
	4275'	1175'	36	6	36	6	21
ANCHORS & GROUNDING INCLUDED	GAC3455TOP	AGK1GGX	BGK3GGX	CPC.5/.75	3/4x12PP	TBSAFETY	
	6	2	3	6	1	6	

290' ROHN 45G
All parts shown in table are included when ordering
Part No: 45G90R290

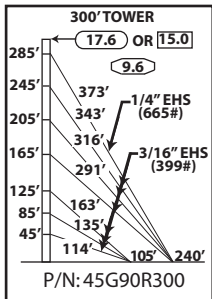

TOWER PARTS INCLUDED	45G	BPC45G	APL45G	GA45GD	BASE	INNER ANCHOR	OUTER ANCHOR
		30	1	1	7	CB3G	AB2
GUYS & CONNECTIONS INCLUDED	3/16EHS	1/4EHS	BG2142	BG2144	5/16THH	3/8THH	1/2TBE&J
	4350'	1200'	36	6	36	6	21
ANCHORS & GROUNDING INCLUDED	GAC3455TOP	AGK1GGX	BGK3GGX	CPC.5/.75	3/4x12PP	TBSAFETY	
	6	2	3	6	1	6	

300' ROHN 45G
All parts shown in table are included when ordering
Part No: 45G90R300



STANDARD DESIGN - 45G

110MPH REV. G, 90MPH REV. F

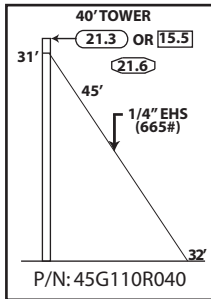

TOWER PARTS INCLUDED	45G	45AG2	BPC45G	GA45GD	FDNS	
	3	1	1	1	BASE CB1G	ANCHOR AB2
GUYS & CONNECTIONS INCLUDED	1/4EHS	BG2144	3/8THH	1/2TBE&J	TBSAFETY	
	150'	6	6	3	3	
ANCHORS & GROUNDING INCLUDED	GAC3455TOP	AGK1GGX	BGK3GGX	CPC.5/.75	3/4x12PP	
	3	1	3	3	1	

40' ROHN 45G
All parts shown in table are included when ordering
Part No: 45G110R040

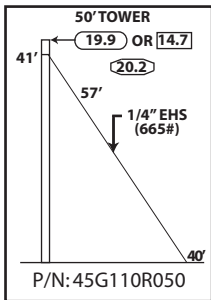

TOWER PARTS INCLUDED	45G	45AG2	BPC45G	GA45GD	FDNS	
	4	1	1	1	BASE CB1G	ANCHOR AB2
GUYS & CONNECTIONS INCLUDED	1/4EHS	BG2144	3/8THH	1/2TBE&J	TBSAFETY	
	200'	6	6	3	3	
ANCHORS & GROUNDING INCLUDED	GAC3455TOP	AGK1GGX	BGK3GGX	CPC.5/.75	3/4x12PP	
	3	1	3	3	1	

50' ROHN 45G
All parts shown in table are included when ordering
Part No: 45G110R050

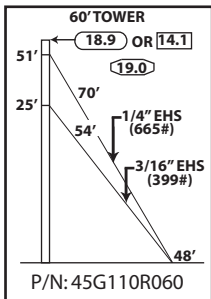

TOWER PARTS INCLUDED	45G	45AG2	BPC45G	GA45GD	FDNS		
	5	1	1	2	BASE CB1G	ANCHOR AB2	
GUYS & CONNECTIONS INCLUDED	3/16EHS	1/4EHS	BG2142	BG2144	5/16THH	3/8THH	1/2TBE&J
	175'	225'	6	6	6	6	6
ANCHORS & GROUNDING INCLUDED	GAC3455TOP	AGK1GGX	BGK3GGX	CPC.5/.75	3/4x12PP	TBSAFETY	
	3	1	3	3	1	3	

60' ROHN 45G
All parts shown in table are included when ordering
Part No: 45G110R060

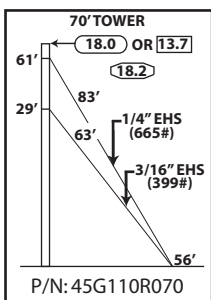

TOWER PARTS INCLUDED	45G	45AG2	BPC45G	GA45GD	FDNS		
	6	1	1	2	BASE CB1G	ANCHOR AB2	
GUYS & CONNECTIONS INCLUDED	3/16EHS	1/4EHS	BG2142	BG2144	5/16THH	3/8THH	1/2TBE&J
	225'	275'	6	6	6	6	6
ANCHORS & GROUNDING INCLUDED	GAC3455TOP	AGK1GGX	BGK3GGX	CPC.5/.75	3/4x12PP	TBSAFETY	
	3	1	3	3	1	3	

70' ROHN 45G
All parts shown in table are included when ordering
Part No: 45G110R070

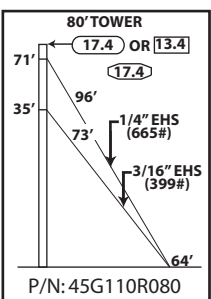

TOWER PARTS INCLUDED	45G	45AG2	BPC45G	GA45GD	FDNS		
	7	1	1	2	BASE CB1G	ANCHOR AB2	
GUYS & CONNECTIONS INCLUDED	3/16EHS	1/4EHS	BG2142	BG2144	5/16THH	3/8THH	1/2TBE&J
	250'	325'	6	6	6	6	6
ANCHORS & GROUNDING INCLUDED	GAC3455TOP	AGK1GGX	BGK3GGX	CPC.5/.75	3/4x12PP	TBSAFETY	
	3	1	3	3	1	3	

80' ROHN 45G
All parts shown in table are included when ordering
Part No: 45G110R080



STANDARD DESIGN - 45G
110MPH REV. G, 90MPH REV. F

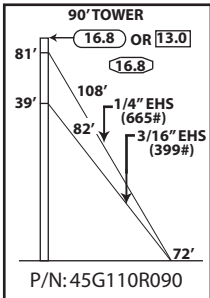

TOWER PARTS INCLUDED	45G	45AG2	BPC45G	GA45GD	FDNS		
					BASE	ANCHOR	
	8	1	1	2	CB1G	AB2	
GUYS & CONNECTIONS INCLUDED	3/16EHS	1/4EHS	BG2142	BG2144	5/16THH	3/8THH	1/2TBE&J
	275'	350'	6	6	6	6	6
ANCHORS & GROUNDING INCLUDED	GAC3455TOP	AGK1GGX	BGK3GGX	CPC.5/.75	3/4x12PP	TBSAFETY	
	3	1	3	3	1	3	

90' ROHN 45G
All parts shown in table are included when ordering
Part No: 45G110R090

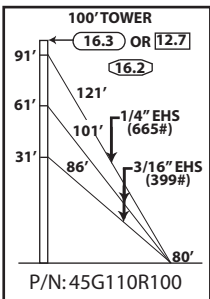

TOWER PARTS INCLUDED	45G	45AG2	BPC45G	GA45GD	FDNS		
					BASE	ANCHOR	
	9	1	1	3	CB1G	AB2	
GUYS & CONNECTIONS INCLUDED	3/16EHS	1/4EHS	BG2142	BG2144	5/16THH	3/8THH	1/2TBE&J
	600'	400'	12	6	12	6	9
ANCHORS & GROUNDING INCLUDED	GAC3455TOP	AGK1GGX	BGK3GGX	CPC.5/.75	3/4x12PP	TBSAFETY	
	3	1	3	3	1	3	

100' ROHN 45G
All parts shown in table are included when ordering
Part No: 45G110R100

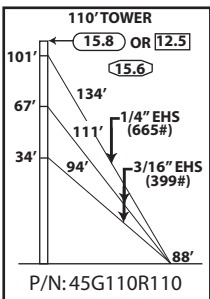

TOWER PARTS INCLUDED	45G	45AG2	BPC45G	GA45GD	FDNS		
					BASE	ANCHOR	
	10	1	1	3	CB1G	AB2	
GUYS & CONNECTIONS INCLUDED	3/16EHS	1/4EHS	BG2142	BG2144	5/16THH	3/8THH	1/2TBE&J
	675'	450'	12	6	12	6	9
ANCHORS & GROUNDING INCLUDED	GAC3455TOP	AGK1GGX	BGK3GGX	CPC.5/.75	3/4x12PP	TBSAFETY	
	3	1	3	3	1	3	

110' ROHN 45G
All parts shown in table are included when ordering
Part No: 45G110R110

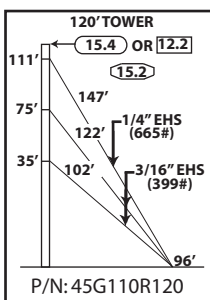

TOWER PARTS INCLUDED	45G	45AG2	BPC45G	GA45GD	FDNS		
					BASE	ANCHOR	
	11	1	1	3	CB1G	AB2	
GUYS & CONNECTIONS INCLUDED	3/16EHS	1/4EHS	BG2142	BG2144	5/16THH	3/8THH	1/2TBE&J
	725'	475'	12	6	12	6	9
ANCHORS & GROUNDING INCLUDED	GAC3455TOP	AGK1GGX	BGK3GGX	CPC.5/.75	3/4x12PP	TBSAFETY	
	3	1	3	3	1	3	

120' ROHN 45G
All parts shown in table are included when ordering
Part No: 45G110R120

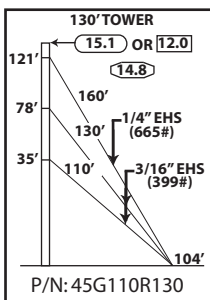

TOWER PARTS INCLUDED	45G	45AG2	BPC45G	GA45GD	FDNS		
					BASE	ANCHOR	
	12	1	1	3	CB1G	AB2	
GUYS & CONNECTIONS INCLUDED	3/16EHS	1/4EHS	BG2142	BG2144	5/16THH	3/8THH	1/2TBE&J
	775'	525'	12	6	12	6	9
ANCHORS & GROUNDING INCLUDED	GAC3455TOP	AGK1GGX	BGK3GGX	CPC.5/.75	3/4x12PP	TBSAFETY	
	3	1	3	3	1	3	

130' ROHN 45G
All parts shown in table are included when ordering
Part No: 45G110R130



STANDARD DESIGN - 45G

110MPH REV. G, 90MPH REV. F

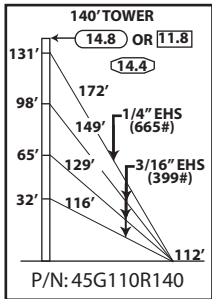

TOWER PARTS INCLUDED	45G	45AG2	BPC45G	GA45GD	FDNS		
	13	1	1	4	BASE CB1G	ANCHOR AB2	
GUYS & CONNECTIONS INCLUDED	3/16EHS	1/4EHS	BG2142	BG2144	5/16THH	3/8THH	1/2TBE&J
	1275'	550'	18	6	18	6	12
ANCHORS & GROUNDING INCLUDED	GAC3455TOP	AGK1GGX	BGK3GGX	CPC.5/.75	3/4x12PP	TBSAFETY	
	3	1	3	3	1	3	

140' ROHN 45G
All parts shown in table are included when ordering
Part No: 45G110R140

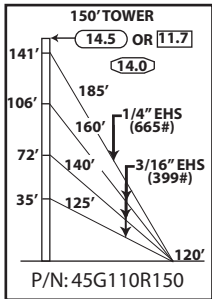

TOWER PARTS INCLUDED	45G	45AG2	BPC45G	GA45GD	FDNS		
	14	1	1	4	BASE CB1G	ANCHOR AB2	
GUYS & CONNECTIONS INCLUDED	3/16EHS	1/4EHS	BG2142	BG2144	5/16THH	3/8THH	1/2TBE&J
	1375'	600'	18	6	18	6	12
ANCHORS & GROUNDING INCLUDED	GAC3455TOP	AGK1GGX	BGK3GGX	CPC.5/.75	3/4x12PP	TBSAFETY	
	3	1	3	3	1	3	

150' ROHN 45G
All parts shown in table are included when ordering
Part No: 45G110R150

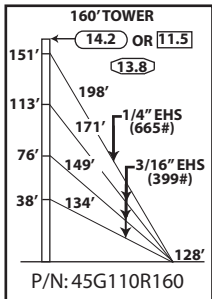

TOWER PARTS INCLUDED	45G	45AG2	BPC45G	GA45GD	FDNS		
	15	1	1	4	BASE CB2G	ANCHOR AB2	
GUYS & CONNECTIONS INCLUDED	3/16EHS	1/4EHS	BG2142	BG2144	5/16THH	3/8THH	1/2TBE&J
	1450'	650'	18	6	18	6	12
ANCHORS & GROUNDING INCLUDED	GAC3455TOP	AGK1GGX	BGK3GGX	CPC.5/.75	3/4x12PP	TBSAFETY	
	3	1	3	3	1	3	

160' ROHN 45G
All parts shown in table are included when ordering
Part No: 45G110R160

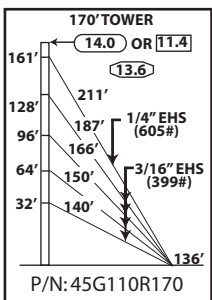

TOWER PARTS INCLUDED	45G	45AG2	BPC45G	GA45GD	FDNS		
	16	1	1	5	BASE CB2G	ANCHOR AB3	
GUYS & CONNECTIONS INCLUDED	3/16EHS	1/4EHS	BG2142	BG2144	5/16THH	3/8THH	5/8TBE&J
	2050'	675'	24	6	24	6	15
ANCHORS & GROUNDING INCLUDED	GAC5655TOP	AGK1GGX	BGK3GGX	CPC1/1.25	3/4x12PP	TBSAFETY	
	3	1	3	3	1	3	

170' ROHN 45G
All parts shown in table are included when ordering
Part No: 45G110R170

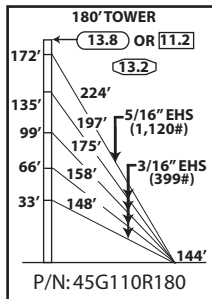

TOWER PARTS INCLUDED	45G	45GL2*	BPC45G	GA45GD	APL45G	FDNS	
	17	1	1	5	1	BASE CB2G	ANCHOR AB3
GUYS & CONNECTIONS INCLUDED	3/16EHS	142265	BG2142	BG2146	5/16THH	7/16THH	5/8TBE&J
	2175'	725'	24	6	24	6	15
ANCHORS & GROUNDING INCLUDED	GAC5655TOP	AGK1GGX	BGK3GGX	CPC1/1.25	3/4x12PP	TBSAFETY	
	3	1	3	3	1	3	

180' ROHN 45G
All parts shown in table are included when ordering
Part No: 45G110R180

* 45GL2 Lug section required for 5/16" guy



STANDARD DESIGN - 45G
110MPH REV. G, 90MPH REV. F

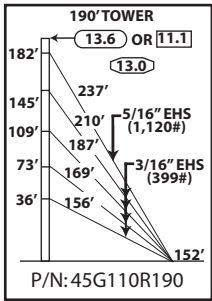

TOWER PARTS INCLUDED	45G	45GL2*	BPC45G	GA45GD	APL45G	FDNS	
	18	1	1	5	1	BASE	ANCHOR
GUYS & CONNECTIONS INCLUDED	3/16EHS	142265	BG2142	BG2146	5/16THH	7/16THH	5/8TBE&J
	2300'	725'	24	6	24	6	15
ANCHORS & GROUNDING INCLUDED	GAC5655TOP	AGK1GGX	BGK3GGX	CPC1/1.25	3/4x12PP	TBSAFETY	
	3	1	3	3	1	3	

190' ROHN 45G
All parts shown in table are included when ordering
Part No: 45G110R190

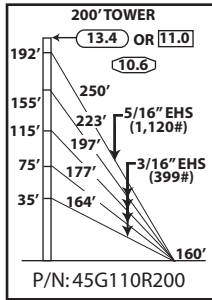

TOWER PARTS INCLUDED	45G	45GL2*	BPC45G	GA45GD	APL45G	FDNS	
	19	1	1	5	1	BASE	ANCHOR
GUYS & CONNECTIONS INCLUDED	3/16EHS	142265	BG2142	BG2146	5/16THH	7/16THH	5/8TBE&J
	2425'	800'	24	6	24	6	15
ANCHORS & GROUNDING INCLUDED	GAC5655TOP	AGK1GGX	BGK3GGX	CPC1/1.25	3/4x12PP	TBSAFETY	
	3	1	3	3	1	3	

200' ROHN 45G
All parts shown in table are included when ordering
Part No: 45G110R200

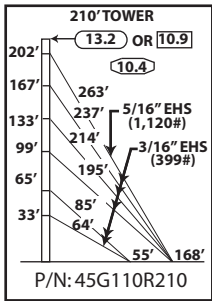

TOWER PARTS INCLUDED	45G	BPC45G	45GL2*	APL45G	GA45GD	BASE	INNER ANCHOR	OUTER ANCHOR
	20	1	1	1	6	CB3G	AB2	AB3
GUYS & CONNECTIONS INCLUDED	3/16EHS	142265	BG2142	BG2146	5/16THH			
	2550'	850'	30	6	30			
	7/16THH	1/2TBE&J	5/8TBE&J	TBSAFETY	3/4x12PP			
	6	6	12	6	1			
ANCHORS & GROUNDING INCLUDED	GAC5655TOP	GAC3455TOP	AGK1GGX	BGK3GGX	CPC.5/.75	CPC1/1.25		
	3	3	2	3	3	3		

210' ROHN 45G
All parts shown in table are included when ordering
Part No: 45G110R210

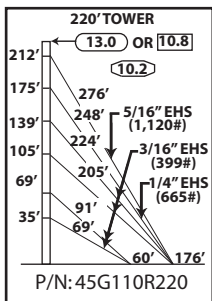

TOWER PARTS INCLUDED	45G	BPC45G	45GL2*	APL45G	GA45GD	BASE	INNER ANCHOR	OUTER ANCHOR
	21	1	1	1	6	CB3G	AB2	AB3
GUYS & CONNECTIONS INCLUDED	3/16EHS	1/4EHS	142265	BG2142	BG2144	BG2146		
	1875'	800'	900'	24	6	6		
	5/16THH	3/8THH	7/16THH	1/2TBE&J	5/8TBE&J	TBSAFETY		
	24	6	6	6	12	6		
ANCHORS & GROUNDING INCLUDED	GAC5655TOP	GAC3455TOP	AGK1GGX	BGK3GGX	CPC.5/.75	CPC1/1.25	3/4X12PP	
	3	3	2	3	3	3	1	

220' ROHN 45G
All parts shown in table are included when ordering
Part No: 45G110R220

* 45GL2 Lug section required for 5/16" guy



STANDARD DESIGN - 45G

110MPH REV. G, 90MPH REV. F

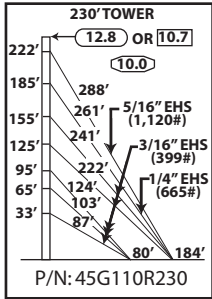

TOWER PARTS INCLUDED	45G	BPC45G	APL45G	GA45GD	45GL2*	BASE	INNER ANCHOR	OUTER ANCHOR
		22	1	1	7	1	CB3G	AB2
GUYS & CONNECTIONS INCLUDED	3/16EHS	1/4EHS	142265	BG2142	BG2144	BG2146		
	2475'	850'	925'	30	6	6		
	5/16THH	3/8THH	7/16THH	1/2TBE&J	5/8TBE&J	TBSAFETY		
	30	6	6	9	12	6		
ANCHORS & GROUNDING INCLUDED	GAC3455TOP	GAC5655TOP	AGK1GGX	BGK3GGX	CPC.5/.75	CPC1/1.25	3/4x12PP	
	3	3	2	3	3	3	1	

230' ROHN 45G
All parts shown in table are included when ordering
Part No: 45G110R230

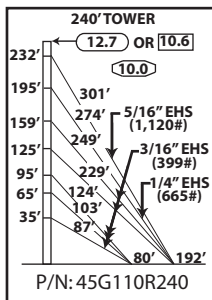

TOWER PARTS INCLUDED	45G	BPC45G	APL45G	GA45GD	45GL2*	BASE	INNER ANCHOR	OUTER ANCHOR
		23	1	1	7	1	CB3G	AB2
GUYS & CONNECTIONS INCLUDED	3/16EHS	1/4EHS	142265	BG2142	BG2144	BG2146		
	2525'	875'	975'	30	6	6		
	5/16THH	3/8THH	7/16THH	1/2TBE&J	5/8TBE&J	TBSAFETY		
	30	6	6	9	12	6		
ANCHORS & GROUNDING INCLUDED	GAC3455TOP	GAC5655TOP	AGK1GGX	BGK3GGX	CPC.5/.75	CPC1/1.25	3/4x12PP	
	3	3	2	3	3	3	1	

240' ROHN 45G
All parts shown in table are included when ordering
Part No: 45G110R240

* 45GL2 Lug section required for 5/16" guy



STANDARD DESIGN - 45G
130MPH REV. G, 110MPH REV. F

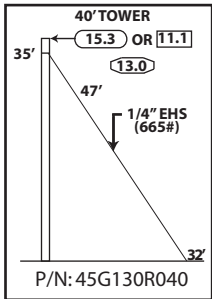

TOWER PARTS INCLUDED	45G	45AG2	BPC45G	GA45GD	FDNS	
					BASE	ANCHOR
	3	1	1	1	CB1G	AB2
GUYS & CONNECTIONS INCLUDED	1/4EHS	BG2144	3/8THH	1/2TBE&J	TBSAFETY	
	150'	6	6	3	3	
ANCHORS & GROUNDING INCLUDED	GAC3455TOP	AGK1GGX	BGK3GGX	CPC.5/.75	3/4x12PP	
	3	1	3	3	1	

40' ROHN 45G
All parts shown in table are included when ordering
Part No: 45G130R040

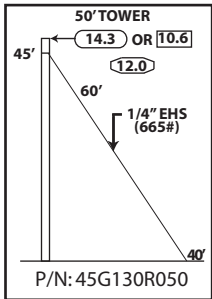

TOWER PARTS INCLUDED	45G	45AG2	BPC45G	GA45GD	FDNS	
					BASE	ANCHOR
	4	1	1	1	CB1G	AB2
GUYS & CONNECTIONS INCLUDED	1/4EHS	BG2144	3/8THH	1/2TBE&J	TBSAFETY	
	200'	6	6	3	3	
ANCHORS & GROUNDING INCLUDED	GAC3455TOP	AGK1GGX	BGK3GGX	CPC.5/.75	3/4x12PP	
	3	1	3	3	1	

50' ROHN 45G
All parts shown in table are included when ordering
Part No: 45G130R050

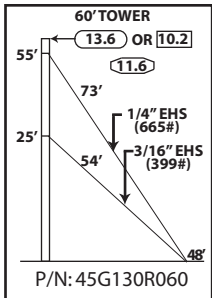

TOWER PARTS INCLUDED	45G	45AG2	BPC45G	GA45GD	FDNS		
					BASE	ANCHOR	
	5	1	1	2	CB1G	AB2	
GUYS & CONNECTIONS INCLUDED	3/16EHS	1/4EHS	BG2142	BG2144	5/16THH	3/8THH	1/2TBE&J
	175'	250'	6	6	6	6	6
ANCHORS & GROUNDING INCLUDED	GAC3455TOP	AGK1GGX	BGK3GGX	CPC.5/.75	3/4x12PP	TBSAFETY	
	3	1	3	3	1	3	

60' ROHN 45G
All parts shown in table are included when ordering
Part No: 45G130R060

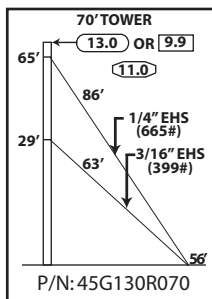

TOWER PARTS INCLUDED	45G	45AG2	BPC45G	GA45GD	FDNS		
					BASE	ANCHOR	
	6	1	1	2	CB1G	AB2	
GUYS & CONNECTIONS INCLUDED	3/16EHS	1/4EHS	BG2142	BG2144	5/16THH	3/8THH	1/2TBE&J
	225'	275'	6	6	6	6	6
ANCHORS & GROUNDING INCLUDED	GAC3455TOP	AGK1GGX	BGK3GGX	CPC.5/.75	3/4x12PP	TBSAFETY	
	3	1	3	3	1	3	

70' ROHN 45G
All parts shown in table are included when ordering
Part No: 45G130R070

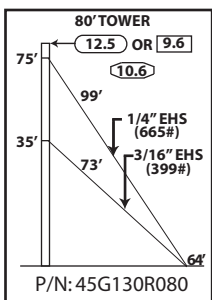

TOWER PARTS INCLUDED	45G	45AG2	BPC45G	GA45GD	FDNS		
					BASE	ANCHOR	
	7	1	1	2	CB1G	AB2	
GUYS & CONNECTIONS INCLUDED	3/16EHS	1/4EHS	BG2142	BG2144	5/16THH	3/8THH	1/2TBE&J
	250'	325'	6	6	6	6	6
ANCHORS & GROUNDING INCLUDED	GAC3455TOP	AGK1GGX	BGK3GGX	CPC.5/.75	3/4x12PP	TBSAFETY	
	3	1	3	3	1	3	

80' ROHN 45G
All parts shown in table are included when ordering
Part No: 45G130R080



STANDARD DESIGN - 45G

130MPH REV. G, 110MPH REV. F

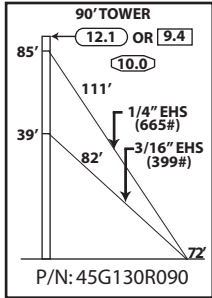

TOWER PARTS INCLUDED	45G	45AG2	BPC45G	GA45GD	FDNS		
					BASE	ANCHOR	
	8	1	1	2	CB1G	AB2	
GUYS & CONNECTIONS INCLUDED	3/16EHS	1/4EHS	BG2142	BG2144	5/16THH	3/8THH	1/2TBE&J
	275'	375'	6	6	6	6	6
ANCHORS & GROUNDING INCLUDED	GAC3455TOP	AGK1GGX	BGK3GGX	CPC.5/.75	3/4x12PP	TBSAFETY	
	3	1	3	3	1	3	

90' ROHN 45G
All parts shown in table are included when ordering
Part No: 45G130R090

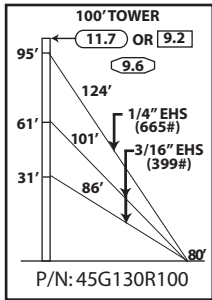

TOWER PARTS INCLUDED	45G	45AG2	BPC45G	GA45GD	FDNS		
					BASE	ANCHOR	
	9	1	1	3	CB1G	AB2	
GUYS & CONNECTIONS INCLUDED	3/16EHS	1/4EHS	BG2142	BG2144	5/16THH	3/8THH	1/2TBE&J
	600'	400'	12	6	12	6	9
ANCHORS & GROUNDING INCLUDED	GAC3455TOP	AGK1GGX	BGK3GGX	CPC.5/.75	3/4x12PP	TBSAFETY	
	3	1	3	3	1	3	

100' ROHN 45G
All parts shown in table are included when ordering
Part No: 45G130R100

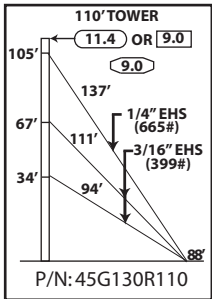

TOWER PARTS INCLUDED	45G	45AG2	BPC45G	GA45GD	FDNS		
					BASE	ANCHOR	
	10	1	1	3	CB1G	AB2	
GUYS & CONNECTIONS INCLUDED	3/16EHS	1/4EHS	BG2142	BG2144	5/16THH	3/8THH	1/2TBE&J
	675'	450'	12	6	12	6	9
ANCHORS & GROUNDING INCLUDED	GAC3455TOP	AGK1GGX	BGK3GGX	CPC.5/.75	3/4x12PP	TBSAFETY	
	3	1	3	3	1	3	

110' ROHN 45G
All parts shown in table are included when ordering
Part No: 45G130R110

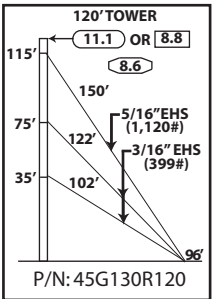

TOWER PARTS INCLUDED	45G	45GL5*	BPC45G	GA45GD	APL45G	FDNS		
						BASE	ANCHOR	
	11	1	1	3	1	CB1G	AB2	
GUYS & CONNECTIONS INCLUDED	3/16EHS	142265	BG2142	BG2146	5/16THH	7/16THH	1/2TBE&J	5/8TBE&J
	725'	500'	12	6	12	6	6	3
ANCHORS & GROUNDING INCLUDED	GAC3455TOP	AGK1GGX	BGK3GGX	CPC.5/.75	3/4x12PP	TBSAFETY		
	3	1	3	3	1	3		

120' ROHN 45G
All parts shown in table are included when ordering
Part No: 45G130R120

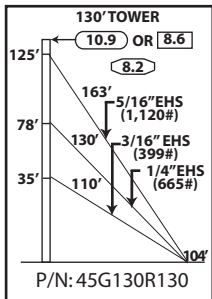

TOWER PARTS INCLUDED	45G	45GL5*	BPC45G	GA45GD	APL45G	FDNS	
						BASE	ANCHOR
	12	1	1	3	1	CB2G	AB3
GUYS & CONNECTIONS INCLUDED	3/16EHS	1/4EHS	142265	BG2142	BG2144	BG2146	
	350'	425'	525'	6	6	6	
	5/16THH	3/8THH	7/16THH	5/8TBE&J	TBSAFETY		
ANCHORS & GROUNDING INCLUDED	GAC3455TOP	AGK1GGX	BGK3GGX	CPC1/1.25	3/4x12PP		
	3	1	3	3	1		

130' ROHN 45G
All parts shown in table are included when ordering
Part No: 45G130R130

* 45GL5 Lug section required for 5/16" guy



STANDARD DESIGN - 45G
130MPH REV. G, 110MPH REV. F

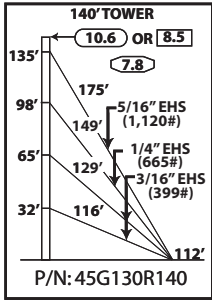

TOWER PARTS INCLUDED	45G	45GL5*	BPC45G	GA45GD	APL45G	FDNS	
						BASE	ANCHOR
	13	1	1	4	1	CB2G	AB3
GUYS & CONNECTIONS INCLUDED	3/16EHS	1/4EHS	142265	BG2142	BG2144	BG2146	
	800'	475'	575'	12	6	6	
	5/16THH	3/8THH	7/16THH	5/8TBE&J	TBSAFETY		
	12	6	6	12	3		
ANCHORS & GROUNDING INCLUDED	GAC5655TOP	AGK1GGX	BGK3GGX	CPC1/1.25	3/4x12PP		
	3	1	3	3	1		

140' ROHN 45G
All parts shown in table are included when ordering
Part No: 45G130R140

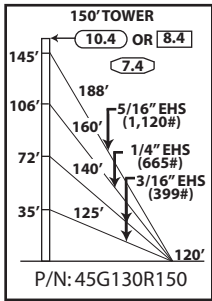

TOWER PARTS INCLUDED	45G	45GL5*	BPC45G	GA45GD	APL45G	FDNS	
						BASE	ANCHOR
	14	1	1	4	1	CB2G	AB3
GUYS & CONNECTIONS INCLUDED	3/16EHS	1/4EHS	142265	BG2142	BG2144	BG2146	
	850'	525'	600'	12	6	6	
	5/16THH	3/8THH	7/16THH	5/8TBE&J	TBSAFETY		
	12	6	6	12	3		
ANCHORS & GROUNDING INCLUDED	GAC5655TOP	AGK1GGX	BGK3GGX	CPC1/1.25	3/4x12PP		
	3	1	3	3	1		

150' ROHN 45G
All parts shown in table are included when ordering
Part No: 45G130R150

* 45GL5 Lug section required for 5/16" guy



PARTS & ACCESSORIES

<p>TOP SECTION 45AG</p>	<p>TOP SECTION 45AG1</p>	<p>TOP SECTION 45AG2</p>	<p>TOP SECTION 45AG3</p>
------------------------------------	-------------------------------------	-------------------------------------	-------------------------------------

<p>TOP SECTION 45AG4</p> <p>TOP PLATE HOLE PATTERN IS THE SAME AS BPL45G.</p>	<p>TOP SECTION 45AG5</p>	<p>BEARING PLATE BPL45G</p> <p>CONVERTS STANDARD SECTION TO A TOP SECTION. HOLE PATTERN FITS TB3 (2" O.D.) AND TB4 (3" O.D.) THRUST BEARINGS.</p>	<p>TOP PLATE APL45G</p> <p>FOR MOUNTING BEACON OR LIGHTNING ROD.</p>
--	-------------------------------------	--	---

	<p>TOP MOUNT</p> <p>45TDMKD - NO MAST 45TDM2S3KD - 2 3/8" O.D. MAST 45TDM2S3KD - 2 7/8" O.D. MAST 45TDM3S3KD - 3 1/2" O.D. MAST 45TDM3S3KD - 3 1/2" O.D. MAST 45TDM3S3KD - 4" O.D. MAST 45TDM4S3KD - 4 1/2" O.D. MAST</p> <p>MOUNTING TUBE PROVIDED IS 7" LONG.</p>	<p>ACCESSORY SHELF AS455G</p> <p>FOR MOUNTING MANY POPULAR ROTORS. FIELD DRILLING MAY BE NECESSARY FOR SOME ROTORS.</p>	<p>LIGHTNING ROD LRCL</p> <p>5' COPPER CLAD MOUNTS TO APL45G.</p>
--	--	--	--



PARTS & ACCESSORIES

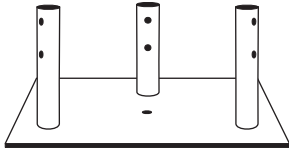

CONCRETE BASE PLATE
BPC45G*

FOR USE WITH 3/4X12PP PIER PIN
EMBEDDED IN CONCRETE.

CONCRETE BASE PLATE IS TO BE
USED FOR BRACKETED AND
GUYED APPLICATIONS ONLY.



PIER PIN
3/4X12PP

FOR USE WITH BPC45G
EMBEDDED IN CONCRETE.

PIER PIN MUST BE ORDERED
SEPARATELY, UNLESS BEING
PURCHASED AS PART OF
A COMPLETE TOWER KIT.

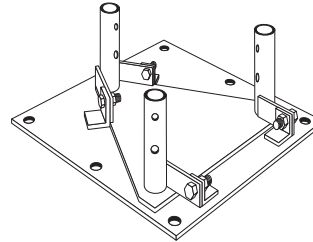

HINGED BASE PLATE
BPH45G*

FOR USE WITH 5/8X12BB BASE BOLTS
(ORDERED SEPARATELY).
HINGED TO ALLOW TOWER TO
BE ROTATED UP FROM BASE
DURING INSTALLATION.

HINGED BASE PLATE IS TO BE
USED FOR BRACKETED AND GUYED
APPLICATIONS ONLY.

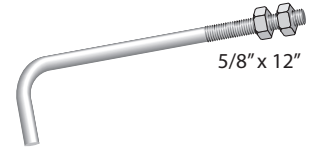

5/8" x 12"

BASE BOLT
5/8X12BB

FOR USE WITH BPH45G

(6) REQUIRED, ORDERED SEPARATELY.



TAPERED BASE
45TG*

CAN BE USED WITH A4197L
BASE INSULATOR OR WITH
3/4X12PP, ORDERED SEPARATELY.

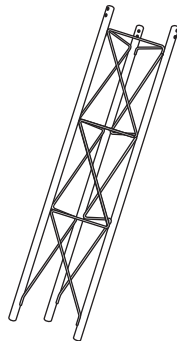

5' SHORT BASE
SB45G

FOR EMBEDMENT IN CONCRETE.

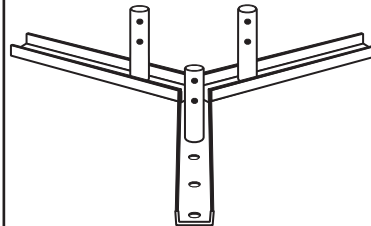

FLAT ROOF MOUNT
FR45G*

BOLTS DIRECTLY TO FLAT ROOF SURFACE.

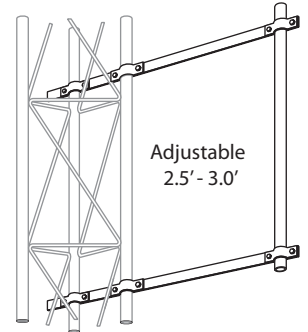

Adjustable
2.5' - 3.0'

SIDE ARM BRACKET
SA253UA

MOUNTING TUBE PROVIDED IS 3' LONG,
2 - 1/4" O.D.

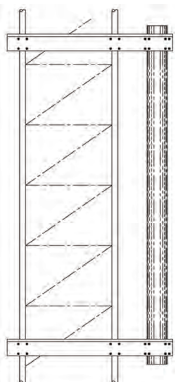

DISH MOUNT

VY4311A2 - 2 3/8" O.D.
VY4311A - 4 1/2" O.D.

MAST TUBE PROVIDED IS 5' LONG.

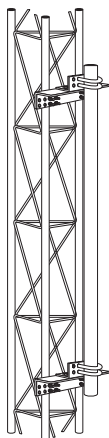

FACE MOUNT

DM45G2 - 2 3/8" O.D. 5' LONG
DM454 - 4 1/2" O.D. 5' LONG

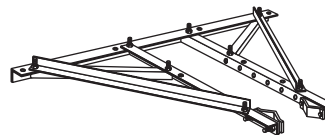

**HEAVY DUTY UNIVERSAL
HOUSE BRACKET**

HBUTVRO

ADJUSTABLE TO POSITION TOWER
18" - 36" FROM WALL.

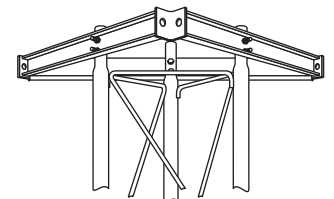

**TORQUE ARM STABILIZER
ASSEMBLY**

TA45

ANTI-TWIST DEVICE LOCATED IN THE
AREA OF ANTENNAS. PROVIDES SIX-WAY
GUYING. BOLTS TO TOWER AT ANY
SECTION JOINT. ATTACHED WITH
JOINT BOLTS. MUST BE INSTALLED AS
SECTIONS ARE JOINED TOGETHER.



* TOWERS MOUNTED ON THESE BASES MUST BE BRACKETED OR GUYED AT ALL TIMES. TEMPORARY STEEL GUYING MAY ALSO BE NECESSARY DURING INSTALLATION AND DISMANTLING.

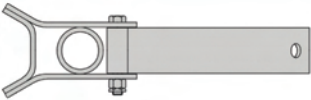
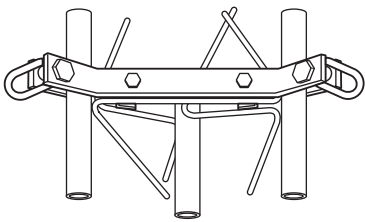
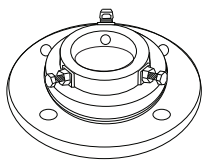
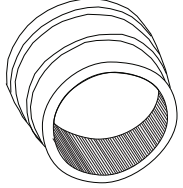

PARTS & ACCESSORIES

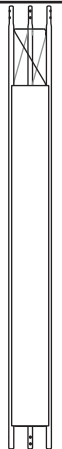
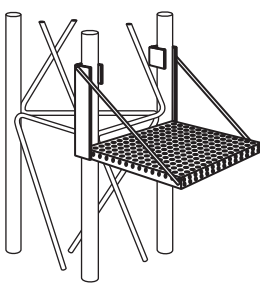
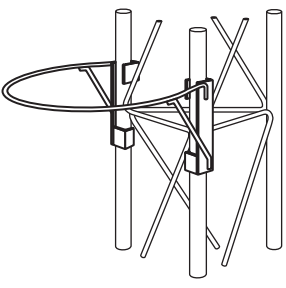
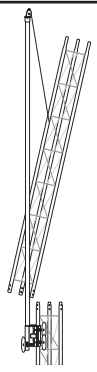
 <p>TORQUE BAR TB45D OPTIONAL, FOR USE WITH GA45GD. REQUIRES (1) 3/8" SHACKLE FOR EACH BAR.</p>	 <p>GUY BRACKET GA45GD MOUNTS TO TOWER AT ANY HORIZONTAL BRACE.</p>	 <p>THRUST BEARING TB3 - SUPPORTS UP TO 2" O.D. MAST. TB4 - SUPPORTS UP TO 3" O.D. MAST. MOUNTS TO BPL45G AND 45AG4.</p>	 <p>TOWER BUSHING TB50 - 1-1/4" I.D. X 2" O.D. TB75 - 1-1/2" I.D. X 2" O.D. FOR USE ON 45AG TOP SECTION</p>
---	---	---	---

 <p>ANTI-CLIMB PANELS VW913A THREE ANTI-CLIMB PANELS BOLT TO STANDARD TOWER SECTION.</p>	 <p>WORK PLATFORM WP45G SNAPS INTO PLACE AT ANY LEVEL. NO BOLTS REQUIRED.</p>	 <p>SAFETY RING SR245 SNAPS INTO PLACE AT ANY LEVEL. NO BOLTS REQUIRED.</p>	 <p>ERECTION FIXTURE EF2545 - 2 1/2" SHEAVE WITH 3/8" I.D. GROOVE. NOTE: ERECTION FIXTURES ARE FOR LIFTING ONE 10' SECTION AT A TIME AND ARE NOT INTENDED FOR THE LIFTING OF PERSONNEL.</p>
---	--	---	--

 <p>CLIMBING HARNESS TTFBH-4D JOURNEYMAN HARNESS TTFBH-C/P PROFESSIONAL HARNESS</p>	 <p>SAFETY CABLE SLIDER WITH CARABINEER TT-WG-500-W/SMC</p>	<p>SAFETY CABLE SYSTEM ORDERING INFORMATION</p> <table border="0"> <thead> <tr> <th>TOWER HEIGHT</th> <th>PART NUMBER</th> </tr> </thead> <tbody> <tr> <td>50'</td> <td>TT0504555</td> </tr> <tr> <td>100'</td> <td>TT1004555</td> </tr> <tr> <td>150'</td> <td>TT1504555</td> </tr> <tr> <td>200'</td> <td>TT2004555</td> </tr> <tr> <td>250'</td> <td>TT2504555</td> </tr> <tr> <td>300'</td> <td>TT3004555</td> </tr> <tr> <td>350'</td> <td>TT3504555</td> </tr> </tbody> </table> <p>SAFETY CABLE SLIDER AND CLIMBING HARNESS MUST BE ORDERED SEPARATELY.</p>	TOWER HEIGHT	PART NUMBER	50'	TT0504555	100'	TT1004555	150'	TT1504555	200'	TT2004555	250'	TT2504555	300'	TT3004555	350'	TT3504555
TOWER HEIGHT	PART NUMBER																	
50'	TT0504555																	
100'	TT1004555																	
150'	TT1504555																	
200'	TT2004555																	
250'	TT2504555																	
300'	TT3004555																	
350'	TT3504555																	



ANCHOR INFORMATION

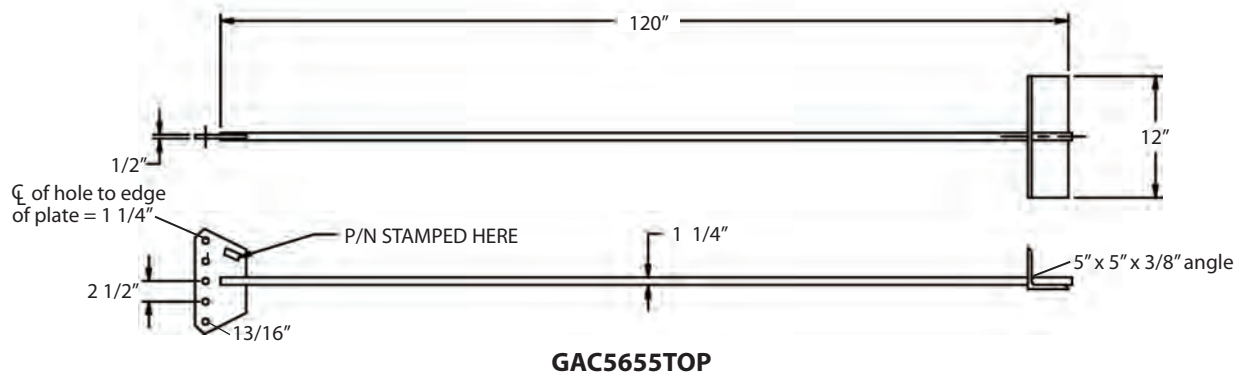
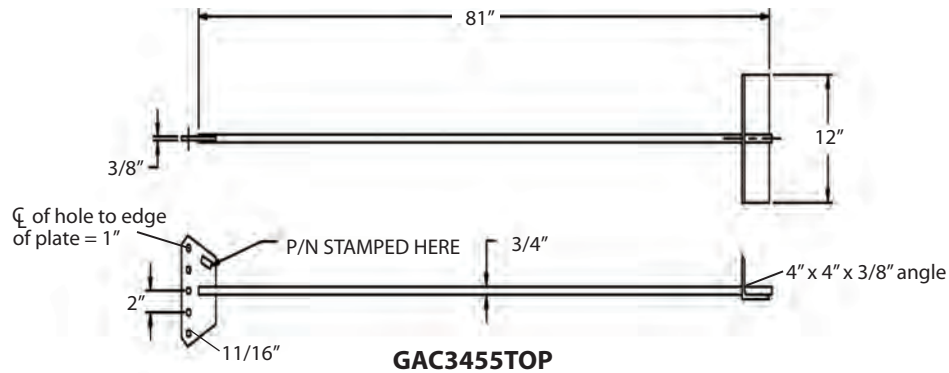

REV G ANCHOR GROUNDING AGK1GGX

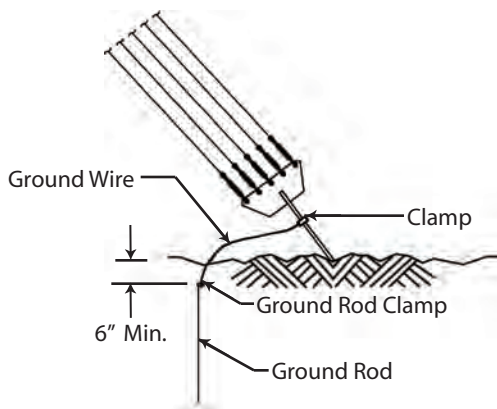

REV G BASE GROUNDING BGK3GGX

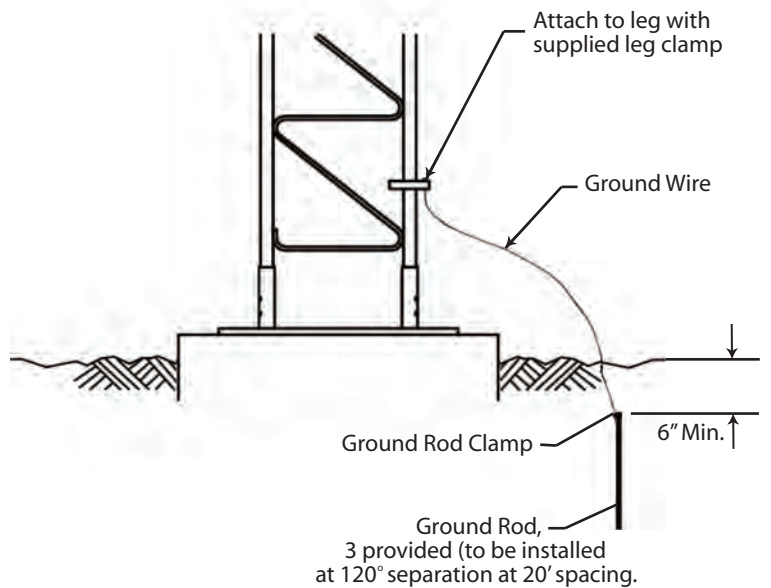



STANDARD ANCHOR BLOCKS

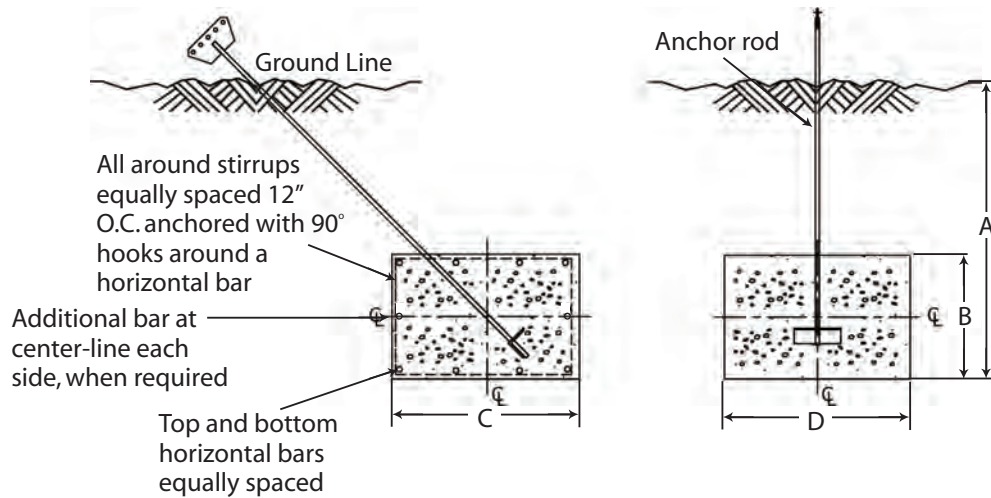

Refer to page 68 for anchor rod installation angles.

Block	Anchor Dimensions (in.)				Horizontal Bars (Qty. & Size)	Stirrup Size & Spacing	Concrete Vol. (Cu. Yds.)
	A	B	C	D			
AB2	4' - 0"	1' - 6"	4' - 0"	6' - 0"	(5) #6 Bars, Top Layer (5) #6 Bars, Bottom Layer (0) Additional Bar, Each Side	#3 @ 12" O.C.	1.33 Per Block 4.0 Total for 3
AB3	6' - 0"	1' - 6"	3' - 0"	6' - 0"	(4) #6 Bars, Top Layer (4) #6 Bars, Bottom Layer (0) Additional Bar, Each Side	#3 @ 12" O.C.	1.0 Per Block 3.0 Total for 3
AB4	6' - 0"	1' - 6"	4' - 0"	9' - 0"	(5) #6 Bars, Top Layer (5) #6 Bars, Bottom Layer (0) Additional Bar, Each Side	#4 @ 12" O.C.	2.0 Per Block 6.0 Total for 3
AB5	8' - 0"	2' - 0"	3' - 0"	10' - 0"	(4) #7 Bars, Top Layer (4) #7 Bars, Bottom Layer (1) Additional Bar, Each Side	#4 @ 12" O.C.	2.22 Per Block 6.7 Total for 3
AB6	8' - 0"	2' - 0"	4' - 0"	10' - 0"	(5) #7 Bars, Top Layer (5) #7 Bars, Bottom Layer (1) Additional Bar, Each Side	#4 @ 12" O.C.	2.96 Per Block 8.9 Total for 3



ANCHOR ROD INSTALLATION ANGLES

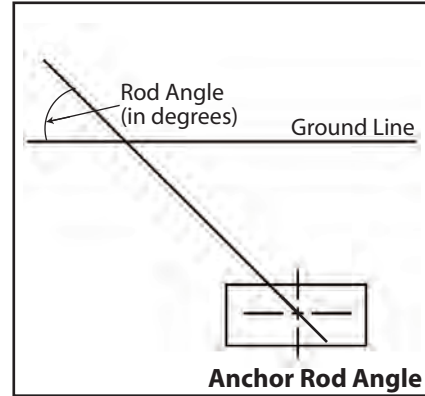
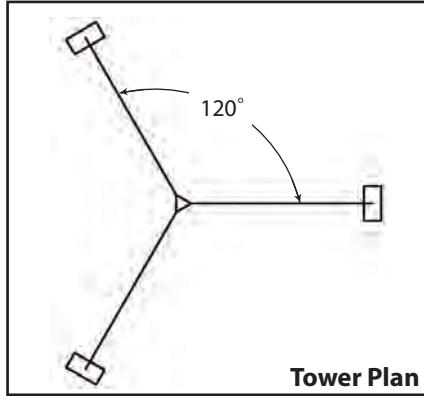

45G 90MPH				
Tower Height	Inner Rod Number	Inner Rod Angle	Outer Rod Number	Outer Rod Angle
40'	GAC3455TOP	45	-	-
50'	GAC3455TOP	46	-	-
60'	GAC3455TOP	43	-	-
70'	GAC3455TOP	43	-	-
80'	GAC3455TOP	41	-	-
90'	GAC3455TOP	42	-	-
100'	GAC3455TOP	42	-	-
110'	GAC3455TOP	40	-	-
120'	GAC3455TOP	39	-	-
130'	GAC3455TOP	40	-	-
140'	GAC3455TOP	39	-	-
150'	GAC3455TOP	38	-	-
160'	GAC3455TOP	37	-	-
170'	GAC3455TOP	38	-	-
180'	GAC3455TOP	38	-	-
190'	GAC3455TOP	36	-	-
200'	GAC3455TOP	36	-	-
210'	GAC3455TOP	40	GAC3455TOP	44
220'	GAC3455TOP	40	GAC3455TOP	44
230'	GAC3455TOP	42	GAC3455TOP	42
240'	GAC3455TOP	42	GAC3455TOP	41
250'	GAC3455TOP	40	GAC3455TOP	43
260'	GAC3455TOP	40	GAC3455TOP	42
270'	GAC3455TOP	38	GAC3455TOP	43
280'	GAC3455TOP	38	GAC3455TOP	43
290'	GAC3455TOP	38	GAC3455TOP	44
300'	GAC3455TOP	38	GAC3455TOP	43

45G 110MPH				
Tower Height	Inner Rod Number	Inner Rod Angle	Outer Rod Number	Outer Rod Angle
40'	GAC3455TOP	45	-	-
50'	GAC3455TOP	46	-	-
60'	GAC3455TOP	41	-	-
70'	GAC3455TOP	41	-	-
80'	GAC3455TOP	41	-	-
90'	GAC3455TOP	41	-	-
100'	GAC3455TOP	39	-	-
110'	GAC3455TOP	39	-	-
120'	GAC3455TOP	39	-	-
130'	GAC3455TOP	38	-	-
140'	GAC3455TOP	38	-	-
150'	GAC3455TOP	38	-	-
160'	GAC3455TOP	38	-	-
170'	GAC5655TOP	37	-	-
180'	GAC5655TOP	37	-	-
190'	GAC5655TOP	37	-	-
200'	GAC5655TOP	37	-	-
210'	GAC3455TOP	41	GAC5655TOP	42
220'	GAC3455TOP	41	GAC5655TOP	42
230'	GAC3455TOP	38	GAC5655TOP	43
240'	GAC3455TOP	39	GAC5655TOP	43

45G 130MPH		
Tower Height	Rod Number	Rod Angle
40'	GAC3455TOP	48
50'	GAC3455TOP	48
60'	GAC3455TOP	40
70'	GAC3455TOP	40
80'	GAC3455TOP	40
90'	GAC3455TOP	40
100'	GAC3455TOP	38
110'	GAC3455TOP	38
120'	GAC3455TOP	38
130'	GAC5655TOP	38
140'	GAC5655TOP	37
150'	GAC5655TOP	37



STANDARD BASE PIERS

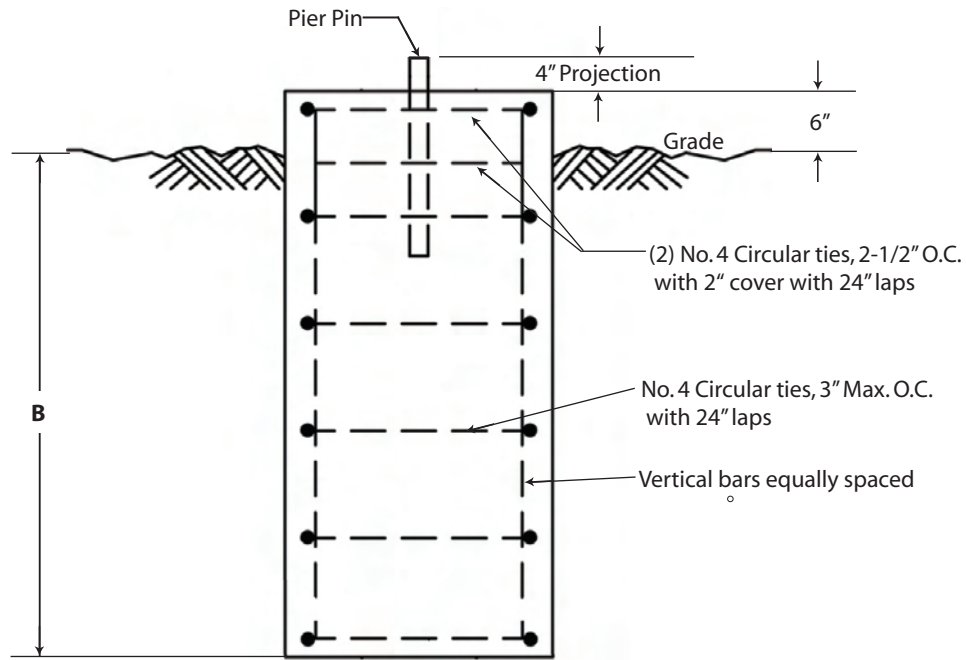

ELEVATION VIEW

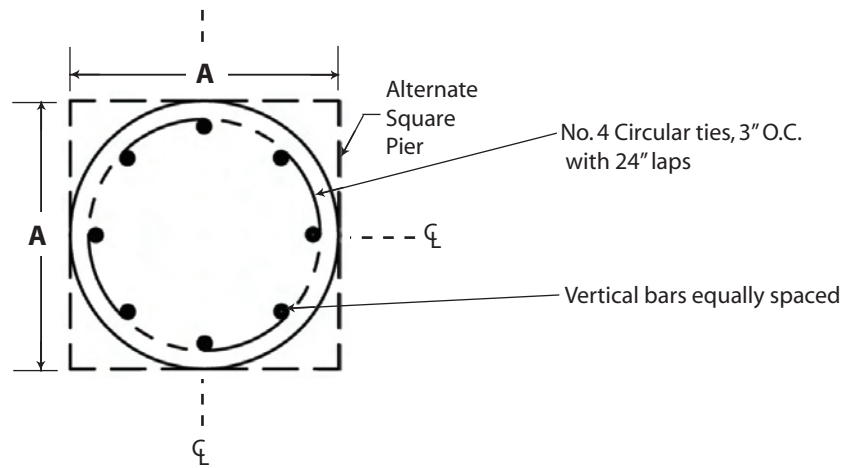

PLAN VIEW

Base	A	B	Concrete Vol. (Cu. Yds.) Round Pier	Vertical Bars (No. & Size)
CB1G*	2' - 6"	4' - 0"	1.0	(8) #7
CB2G	3' - 0"	4' - 0"	1.2	(10) #7
CB3G	3' - 6"	4' - 0"	1.6	(12) #7

* Square pier option must be used for CB1G.



STANDARD 45GSR GUYED TOWER

ROHN 45GSR
The first. The original.

45GSR

GENERAL USE

The 45GSR maintains the utility of the 45G and adds the strength of solid round steel legs. The 45GSR has a strong 4 bolt flange connection, giving connection joints superior strength over typical 1 bolt flange connection systems. The 45GSR is available in heights up to 340'.

FEATURES

- Completely hot-dip galvanized after fabrication
- Built on a 16 3/4" equilateral triangle design
- Heavy solid steel round legs joined by Zig-Zag® cross members
- Each section contains all required nuts and bolts shipped with section
- Continuous solid round steel bracing

CAUTION

Mixing copies of ROHN towers with ROHN towers is dangerous and voids all engineering and warranty data supplied by ROHN. Materials used by others are not the same quality and have not been tested or engineered by ROHN. Mixing ROHN tower sections with non-ROHN products may cause tower failure or injury.

Per Rev G requirements, any structure greater than 10' requires a climber safety device. Please see page 92 for ordering information.





STANDARD 45GSR GUYED TOWER SECTIONS

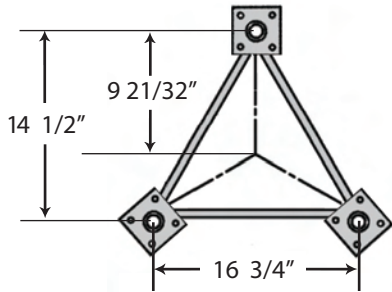

QUICK REFERENCE	
PARTS & ACCESSORIES	PAGE 92
GROUNDING INFORMATION	PAGE 93
FOUNDATION INFORMATION	PAGES 93-97

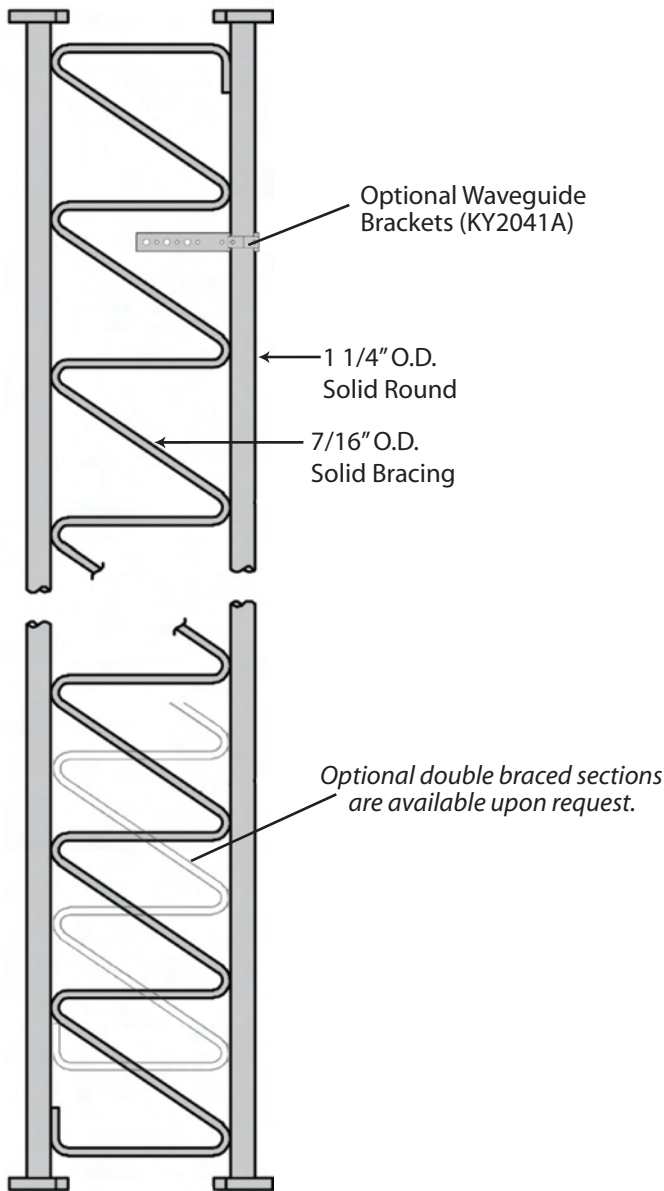

STANDARD SECTION
45GSR10 - 10' Section
45GSR20 - 20' Section

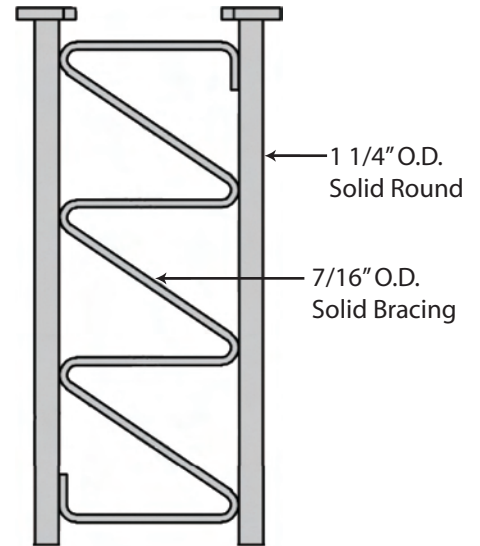

4.3' 45GSR SHORT BASE
45GSRSB

TO BE EMBEDDED IN CONCRETE.



BUYERS GUIDE
STANDARD DESIGNS - 45GSR
90MPH REV. G [3 SECOND GUST]

Design Criteria

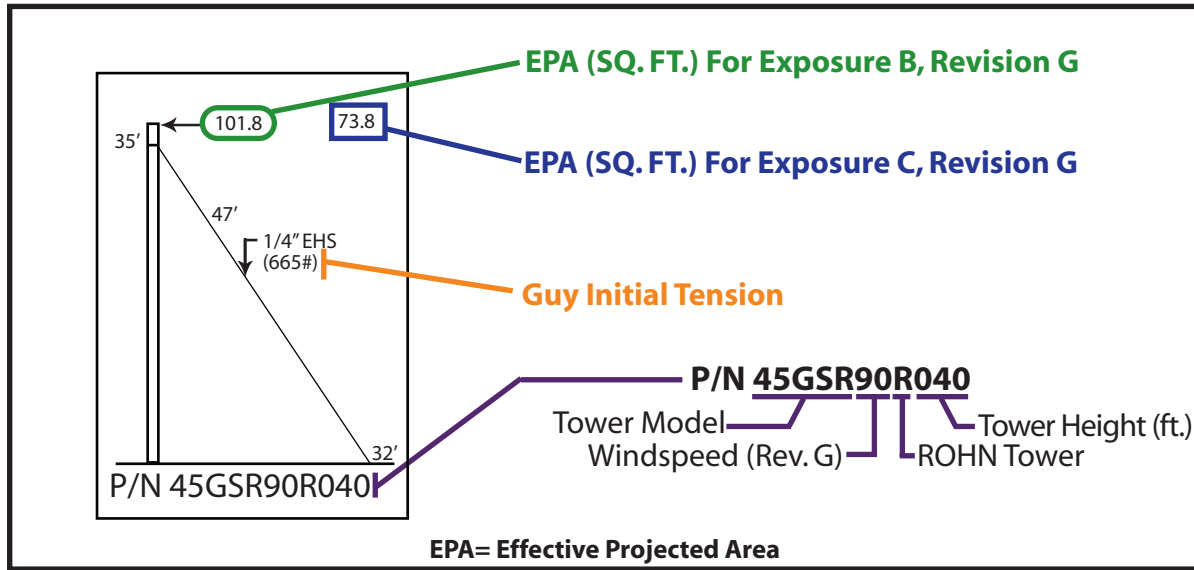

This document is to serve as a guide for sizing and purchasing the 45GSR tower. Tower and foundation installations should be performed by qualified and experienced personnel using assembly drawings provided with each tower.

DESIGN NOTES:

1. Tower designs are in accordance with ANSI/TIA-222-G, Class I Structures, Topographic Category 1.
2. Design assumes towers are installed on level ground. Lower EPA values will apply for roof mounted towers or for sites located on unusual terrain.
3. Designs assume two 7/8" diameter lines on each tower face.
4. Anchor radius is from tower base to intersection of anchor rod with ground.
5. Guy chord lengths shown are based on level ground. Initial tensions for guys are shown in () in pounds at 60° Fahrenheit.
6. Antenna and mounts are assumed symmetrically placed at the tower top.

PARTS LIST NOTES:

1. Items listed are required for complete guyed towers.
2. Base and anchor foundations listed refer to standard foundation designations.
3. Guys provided with each standard tower are based on level ground conditions with an additional 6% length.
4. Rev G anchor grounding (AGK1GGX) and base grounding (BGK3GGX) are included with the tower material.
5. Assembly drawings and a safety package (P/N: ACWS) are included with each tower.
6. Parts lists are subject to change based on availability or revised design criteria.

FOR FOUNDATION INFORMATION, PLEASE SEE PAGES 93-97.

FOR GENERAL INSTALLATION INFORMATION, PLEASE SEE PAGES 147-153.



STANDARD DESIGN - 45GSR
90MPH REV. G

45GSR
SOLID ROD

40' ROHN 45GSR
All parts shown in table are included when ordering
Part No: 45GSR90R040

50' ROHN 45GSR
All parts shown in table are included when ordering
Part No: 45GSR90R050

60' ROHN 45GSR
All parts shown in table are included when ordering
Part No: 45GSR90R060

70' ROHN 45GSR
All parts shown in table are included when ordering
Part No: 45GSR90R070

80' ROHN 45GSR
All parts shown in table are included when ordering
Part No: 45GSR90R080

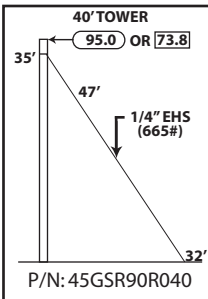

TOWER PARTS INCLUDED	45GSR20	45GSRSB	GA45GD	FDNS	
	2	1	1	BASE	ANCHOR
GUYS & CONNECTIONS INCLUDED	1/4EHS	BG2144	3/8THH	1/2TBE&J	TBSAFETY
	150'	6	6	3	3
ANCHORS & GROUNDING INCLUDED	GAC3455TOP	AGK1GGX	BGK3GGX	CPC.5/.75	
	3	1	3	3	

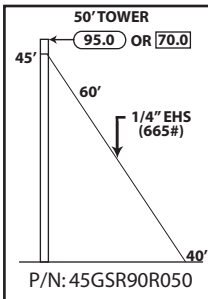

TOWER PARTS INCLUDED	45GSR20	45GSR10	45GSRSB	GA45GD	FDNS	
	2	1	1	1	FB1G	AB2
GUYS & CONNECTIONS INCLUDED	1/4EHS	BG2144	3/8THH	1/2TBE&J	TBSAFETY	
	200'	6	6	3	3	
ANCHORS & GROUNDING INCLUDED	GAC3455TOP	AGK1GGX	BGK3GGX	CPC.5/.75		
	3	1	3	3		

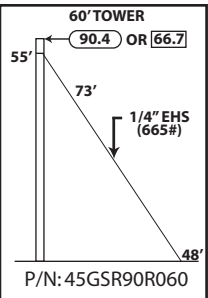

TOWER PARTS INCLUDED	45GSR20	45GSRSB	GA45GD	FDNS	
	3	1	1	FB1G	AB2
GUYS & CONNECTIONS INCLUDED	1/4EHS	BG2144	3/8THH	1/2TBE&J	TBSAFETY
	250'	6	6	3	3
ANCHORS & GROUNDING INCLUDED	GAC3455TOP	AGK1GGX	BGK3GGX	CPC.5/.75	
	3	1	3	3	

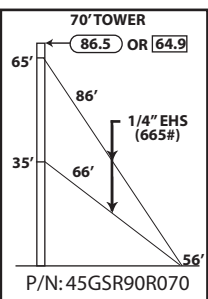

TOWER PARTS INCLUDED	45GSR20	45GSR10	45GSRSB	GA45GD	FDNS	
	3	1	1	2	FB1G	AB2
GUYS & CONNECTIONS INCLUDED	1/4EHS	BG2144	3/8THH	1/2TBE&J	TBSAFETY	
	500'	12	12	6	3	
ANCHORS & GROUNDING INCLUDED	GAC3455TOP	AGK1GGX	BGK3GGX	CPC.5/.75		
	3	1	3	3		

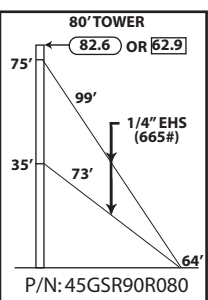

TOWER PARTS INCLUDED	45GSR20	45GSRSB	GA45GD	FDNS	
	4	1	2	FB1G	AB2
GUYS & CONNECTIONS INCLUDED	1/4EHS	BG2144	3/8THH	1/2TBE&J	TBSAFETY
	550'	12	12	6	3
ANCHORS & GROUNDING INCLUDED	GAC3455TOP	AGK1GGX	BGK3GGX	CPC.5/.75	
	3	1	3	3	



STANDARD DESIGN - 45GSR
90MPH REV. G

45GSR
SOLID ROD

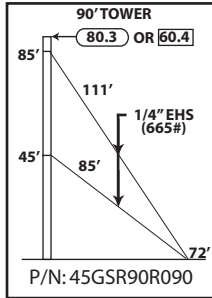

TOWER PARTS INCLUDED	45GSR20	45GSR10	45GSRSB	GA45GD	FDNS	
					BASE	ANCHOR
	4	1	1	2	FB1G	AB2
GUYS & CONNECTIONS INCLUDED	1/4EHS	BG2144	3/8THH	1/2TBE&J	TBSAFETY	
	625'	12	12	6	3	
ANCHORS & GROUNDING INCLUDED	GAC3455TOP	AGK1GGX	BGK3GGX	CPC.5/.75		
	3	1	3	3		

90' ROHN 45GSR
All parts shown in table are included when ordering
Part No: 45GSR90R090

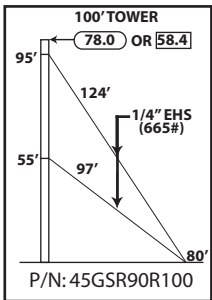

TOWER PARTS INCLUDED	45GSR20	45GSR10	45GSRSB	GA45GD	FDNS	
					BASE	ANCHOR
	5	1	1	2	FB1G	AB2
GUYS & CONNECTIONS INCLUDED	1/4EHS	BG2144	3/8THH	1/2TBE&J	TBSAFETY	
	725'	12	12	6	3	
ANCHORS & GROUNDING INCLUDED	GAC3455TOP	AGK1GGX	BGK3GGX	CPC.5/.75		
	3	1	3	3		

100' ROHN 45GSR
All parts shown in table are included when ordering
Part No: 45GSR90R100

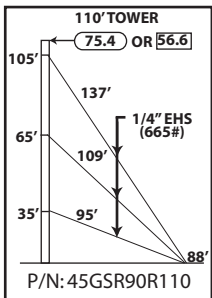

TOWER PARTS INCLUDED	45GSR20	45GSR10	45GSRSB	GA45GD	FDNS	
					BASE	ANCHOR
	5	1	1	3	FB1G	AB2
GUYS & CONNECTIONS INCLUDED	1/4EHS	BG2144	3/8THH	1/2TBE&J	TBSAFETY	
	1100'	18	18	9	3	
ANCHORS & GROUNDING INCLUDED	GAC3455TOP	AGK1GGX	BGK3GGX	CPC.5/.75		
	3	1	3	3		

110' ROHN 45GSR
All parts shown in table are included when ordering
Part No: 45GSR90R110

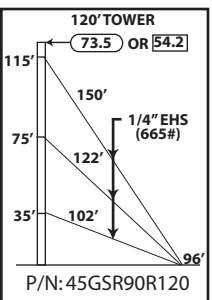

TOWER PARTS INCLUDED	45GSR20	45GSR10	45GSRSB	GA45GD	FDNS	
					BASE	ANCHOR
	6	1	1	3	FB1G	AB2
GUYS & CONNECTIONS INCLUDED	1/4EHS	BG2144	3/8THH	1/2TBE&J	TBSAFETY	
	1200'	18	18	9	3	
ANCHORS & GROUNDING INCLUDED	GAC3455TOP	AGK1GGX	BGK3GGX	CPC.5/.75		
	3	1	3	3		

120' ROHN 45GSR
All parts shown in table are included when ordering
Part No: 45GSR90R120

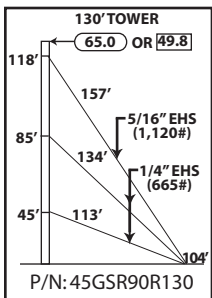

TOWER PARTS INCLUDED	45GSR20	45GSR10	45GSRSB	GA45GD	FDNS	
					BASE	ANCHOR
	6	1	1	3	FB1G	AB2
GUYS & CONNECTIONS INCLUDED	1/4EHS	142265	BG2144	BG2146		
	800'	500'	12	6		
	3/8THH	7/16THH	5/8TBE&J	1/2TBE&J		
	12	6	3	6		
ANCHORS & GROUNDING INCLUDED	GAC3455TOP	AGK1GGX	BGK3GGX	CPC.5/.75	TBSAFETY	
	3	1	3	3	3	

130' ROHN 45GSR
All parts shown in table are included when ordering
Part No: 45GSR90R130



STANDARD DESIGN - 45GSR
90MPH REV. G

45GSR
SOLID ROD

140' ROHN 45GSR

All parts shown in table are included when ordering
Part No: 45GSR90R140

150' ROHN 45GSR
All parts shown in table are included when ordering
Part No: 45GSR90R150

160' ROHN 45GSR
All parts shown in table are included when ordering
Part No: 45GSR90R160

170' ROHN 45GSR
All parts shown in table are included when ordering
Part No: 45GSR90R170

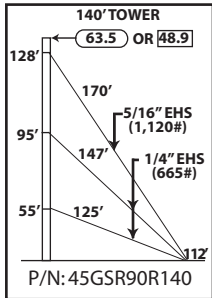

TOWER PARTS INCLUDED	45GSR20	45GSRSB	GA45GD	FDNS	
				BASE	ANCHOR
	7	1	3	FB1G	AB2
GUYS & CONNECTIONS INCLUDED	1/4EHS	142265	BG2144	BG2146	
	875'	550'	12	6	
	3/8THH	7/16THH	5/8TBE&J	1/2TBE&J	
	12	6	3	6	
ANCHORS & GROUNDING INCLUDED	GAC3455TOP	AGK1GGX	BGK3GGX	CPC.5/.75	TBSAFETY
	3	1	3	3	3

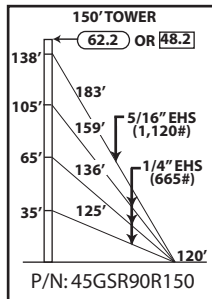

TOWER PARTS INCLUDED	45GSR20	45GSR10	45GSRSB	GA45GD	FDNS	
					BASE	ANCHOR
	7	1	1	4	FB1G	AB2
GUYS & CONNECTIONS INCLUDED	1/4EHS	142265	BG2144	BG2146		
	1350'	600'	18	6		
	3/8THH	7/16THH	5/8TBE&J	1/2TBE&J		
	18	6	3	9		
ANCHORS & GROUNDING INCLUDED	GAC3455TOP	AGK1GGX	BGK3GGX	CPC.5/.75	TBSAFETY	
	3	1	3	3	3	

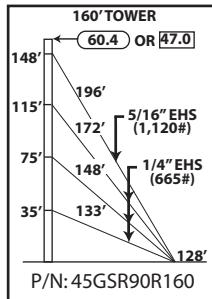

TOWER PARTS INCLUDED	45GSR20	45GSRSB	GA45GD	FDNS	
				BASE	ANCHOR
	8	1	4	FB1G	AB2
GUYS & CONNECTIONS INCLUDED	1/4EHS	142265	BG2144	BG2146	
	1450'	625'	18	6	
	3/8THH	7/16THH	5/8TBE&J	1/2TBE&J	
	18	6	3	9	
ANCHORS & GROUNDING INCLUDED	GAC3455TOP	AGK1GGX	BGK3GGX	CPC.5/.75	TBSAFETY
	3	1	3	3	3

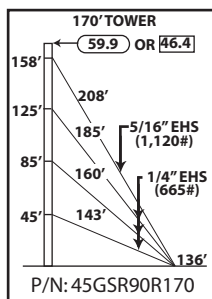

TOWER PARTS INCLUDED	45GSR20	45GSR10	45GSRSB	GA45GD	FDNS	
					BASE	ANCHOR
	8	1	1	4	FB1G	AB3
GUYS & CONNECTIONS INCLUDED	1/4EHS	142265	BG2144	BG2146		
	1575'	675'	18	6		
	3/8THH	7/16THH	5/8TBE&J	TBSAFETY		
	18	6	12	3		
ANCHORS & GROUNDING INCLUDED	GAC5655TOP	AGK1GGX	BGK3GGX	CPC1/1.25		
	3	1	3	3		





**STANDARD DESIGN - 45GSR
90MPH REV. G**

45GSR
SOLID ROD

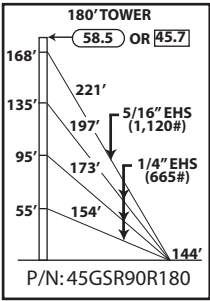

TOWER PARTS INCLUDED	45GSR20	45GSRSB	GA45GD	FDNS	
				BASE	ANCHOR
	9	1	4	FB1G	AB3
GUYS & CONNECTIONS INCLUDED	1/4EHS	142265	BG2144	BG2146	
	1675'	725'	18	6	
	3/8THH	7/16THH	5/8TBE&J	TBSAFETY	
	18	6	12	3	
ANCHORS & GROUNDING INCLUDED	GAC5655TOP	AGK1GGX	BGK3GGX	CPC1/1.25	
	3	1	3	3	

180' ROHN 45GSR
All parts shown in table are included when ordering
Part No: 45GSR90R180

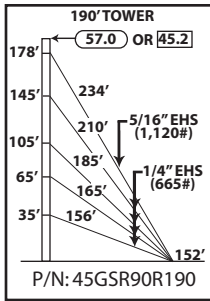

TOWER PARTS INCLUDED	45GSR20	45GSR10	45GSRSB	GA45GD	FDNS	
					BASE	ANCHOR
	9	1	1	5	FB1G	AB3
GUYS & CONNECTIONS INCLUDED	1/4EHS	142265	BG2144	BG2146		
	2300'	750'	24	6		
	3/8THH	7/16THH	5/8TBE&J	TBSAFETY		
	24	6	15	3		
ANCHORS & GROUNDING INCLUDED	GAC5655TOP	AGK1GGX	BGK3GGX	CPC1/1.25		
	3	1	3	3		

190' ROHN 45GSR
All parts shown in table are included when ordering
Part No: 45GSR90R190

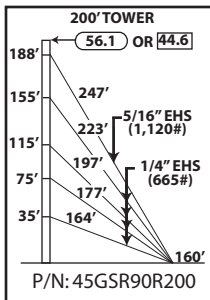

TOWER PARTS INCLUDED	45GSR20	45GSRSB	GA45GD	APL4A	FDNS	
					BASE	ANCHOR
	10	1	5	1	FB1G	AB3
GUYS & CONNECTIONS INCLUDED	1/4EHS	142265	BG2144	BG2146		
	2425'	800'	24	6		
	3/8THH	7/16THH	5/8TBE&J	TBSAFETY		
	24	6	15	3		
ANCHORS & GROUNDING INCLUDED	GAC5655TOP	AGK1GGX	BGK3GGX	CPC1/1.25		
	3	1	3	3		

200' ROHN 45GSR
All parts shown in table are included when ordering
Part No: 45GSR90R200

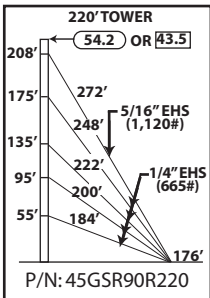

TOWER PARTS INCLUDED	45GSR20	45GSRSB	GA45GD	APL4A	FDNS	
					BASE	ANCHOR
	11	1	5	1	FB1G	AB3
GUYS & CONNECTIONS INCLUDED	1/4EHS	142265	BG2144	BG2146		
	2725'	875'	24	6		
	3/8THH	7/16THH	5/8TBE&J	TBSAFETY		
	24	6	15	3		
ANCHORS & GROUNDING INCLUDED	GAC5655TOP	AGK1GGX	BGK3GGX	CPC1/1.25		
	3	1	3	3		

220' ROHN 45GSR
All parts shown in table are included when ordering
Part No: 45GSR90R220



STANDARD DESIGN - 45GSR 90MPH REV. G

45GSR
SOLID ROD

240' ROHN 45GSR
All parts shown in table are included when ordering
Part No: 45GSR90R240

260' ROHN 45GSR
All parts shown in table are included when ordering
Part No: 45GSR90R260

280' ROHN 45GSR
All parts shown in table are included when ordering
Part No: 45GSR90R280

300' ROHN 45GSR
All parts shown in table are included when ordering
Part No: 45GSR90R300

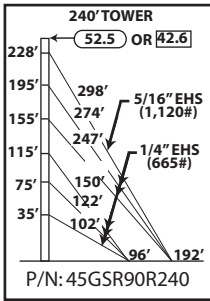

TOWER PARTS INCLUDED	45GSR20	45GSRSB	GA45GD	APL4A	BASE	INNER ANCHOR	OUTER ANCHOR
		12	1	6	1	FB1G	AB2
GUYS & CONNECTIONS INCLUDED	1/4EHS	142265	BG2144	BG2146			
	2850'	950'	30	6			
	3/8THH	7/16THH	5/8TBE&J	1/2TBE&J			
	30	6	3	15			
ANCHORS & GROUNDING INCLUDED	GAC3455TOP	AGK1GGX	BGK3GGX	CPC.5/.75	TBSAFETY		
	6	2	3	6	6		

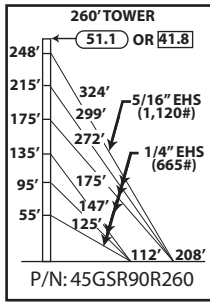

TOWER PARTS INCLUDED	45GSR20	45GSRSB	GA45GD	APL4A	BASE	INNER ANCHOR	OUTER ANCHOR
		13	1	6	1	FB1G	AB2
GUYS & CONNECTIONS INCLUDED	1/4EHS	142265	BG2144	BG2146			
	3250'	1050'	30	6			
	3/8THH	7/16THH	5/8TBE&J	1/2TBE&J			
	30	6	3	15			
ANCHORS & GROUNDING INCLUDED	GAC3455TOP	AGK1GGX	BGK3GGX	CPC.5/.75	TBSAFETY		
	6	2	3	6	6		

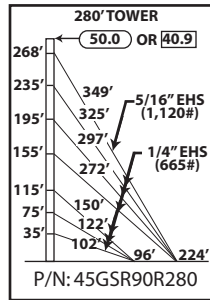

TOWER PARTS INCLUDED	45GSR20	45GSRSB	GA45GD	APL4A	BASE	INNER ANCHOR	OUTER ANCHOR
		14	1	7	1	FB1G	AB2
GUYS & CONNECTIONS INCLUDED	1/4EHS	142265	BG2144	BG2146	3/8THH		
	4050'	1125'	36	6	36		
	7/16THH	5/8TBE&J	1/2TBE&J	CPC.5/.75	CPC1/1.25		
	6	12	9	3	3		
ANCHORS & GROUNDING INCLUDED	GAC3455TOP	GAC5655TOP	AGK1GGX	BGK3GGX	TBSAFETY		
	3	3	2	3	6		

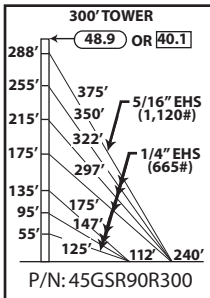

TOWER PARTS INCLUDED	45GSR20	45GSRSB	GA45GD	APL4A	BASE	INNER ANCHOR	OUTER ANCHOR
		15	1	7	1	FB1G	AB2
GUYS & CONNECTIONS INCLUDED	1/4EHS	142265	BG2144	BG2146	3/8THH		
	4525'	1200'	36	6	36		
	7/16THH	5/8TBE&J	1/2TBE&J	CPC.5/.75	CPC1/1.25		
	6	12	9	3	3		
ANCHORS & GROUNDING INCLUDED	GAC3455TOP	GAC5655TOP	AGK1GGX	BGK3GGX	TBSAFETY		
	3	3	2	3	6		



STANDARD DESIGN - 45GSR
90MPH REV. G

45GSR
SOLID ROD

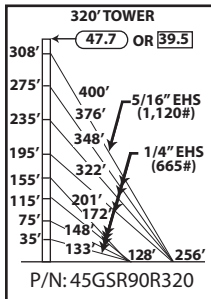

TOWER PARTS INCLUDED	45GSR20	45GSRSB	GA45GD	APL4A	BASE	INNER ANCHOR	OUTER ANCHOR
	16	1	8	1	FB1G	AB2	AB3
GUYS & CONNECTIONS INCLUDED	1/4EHS	142265	BG2144	BG2146	3/8THH		
	5450'	1275'	42	6	42		
	7/16THH	5/8TBE&J	1/2TBE&J	CPC.5/.75	CPC1/1.25		
	6	12	12	3	3		
ANCHORS & GROUNDING INCLUDED	GAC3455TOP	GAC5655TOP	AGK1GGX	BGK3GGX	TBSAFETY		
	3	3	2	3	6		

320' ROHN 45GSR
All parts shown in table are included when ordering
Part No: 45GSR90R320

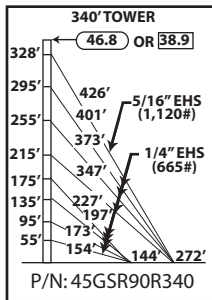

TOWER PARTS INCLUDED	45GSR20	45GSRSB	GA45GD	APL4A	BASE	INNER ANCHOR	OUTER ANCHOR
	17	1	8	1	FB1G	AB2	AB3
GUYS & CONNECTIONS INCLUDED	1/4EHS	142265	BG2144	BG2146	3/8THH		
	5975'	1375'	42	6	42		
	7/16THH	5/8TBE&J	1/2TBE&J	CPC.5/.75	CPC1/1.25		
	6	12	12	3	3		
ANCHORS & GROUNDING INCLUDED	GAC3455TOP	GAC5655TOP	AGK1GGX	BGK3GGX	TBSAFETY		
	3	3	2	3	6		

340' ROHN 45GSR
All parts shown in table are included when ordering
Part No: 45GSR90R340



STANDARD DESIGN - 45GSR
110MPH REV. G

45GSR
SOLID ROD

40' ROHN 45GSR
All parts shown in table are included when ordering
Part No: 45GSR110R040

50' ROHN 45GSR
All parts shown in table are included when ordering
Part No: 45GSR110R050

60' ROHN 45GSR
All parts shown in table are included when ordering
Part No: 45GSR110R060

70' ROHN 45GSR
All parts shown in table are included when ordering
Part No: 45GSR110R070

80' ROHN 45GSR
All parts shown in table are included when ordering
Part No: 45GSR110R080

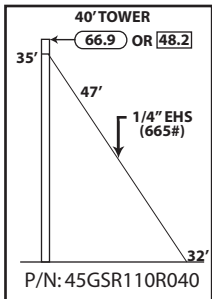

TOWER PARTS INCLUDED	45GSR20	45GSRSB	GA45GD	FDNS	
	2	1	1	BASE	ANCHOR
GUYS & CONNECTIONS INCLUDED	1/4EHS	BG2144	3/8THH	1/2TBE&J	TBSAFETY
	150'	6	6	3	3
ANCHORS & GROUNDING INCLUDED	GAC3455TOP	AGK1GGX	BGK3GGX	CPC.5/.75	
	3	1	3	3	

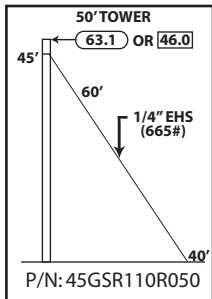

TOWER PARTS INCLUDED	45GSR20	45GSR10	45GSRSB	GA45GD	FDNS	
	2	1	1	1	BASE	ANCHOR
GUYS & CONNECTIONS INCLUDED	1/4EHS	BG2144	3/8THH	1/2TBE&J	TBSAFETY	
	200'	6	6	3	3	
ANCHORS & GROUNDING INCLUDED	GAC3455TOP	AGK1GGX	BGK3GGX	CPC.5/.75		
	3	1	3	3		

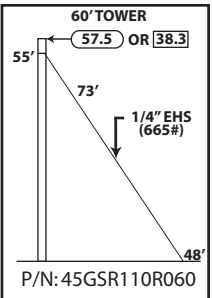

TOWER PARTS INCLUDED	45GSR20	45GSRSB	GA45GD	FDNS	
	3	1	1	BASE	ANCHOR
GUYS & CONNECTIONS INCLUDED	1/4EHS	BG2144	3/8THH	1/2TBE&J	TBSAFETY
	250'	6	6	3	3
ANCHORS & GROUNDING INCLUDED	GAC3455TOP	AGK1GGX	BGK3GGX	CPC.5/.75	
	3	1	3	3	

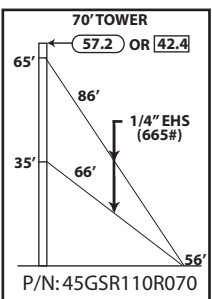

TOWER PARTS INCLUDED	45GSR20	45GSR10	45GSRSB	GA45GD	FDNS	
	3	1	1	2	BASE	ANCHOR
GUYS & CONNECTIONS INCLUDED	1/4EHS	BG2144	3/8THH	1/2TBE&J	TBSAFETY	
	500'	12	12	6	3	
ANCHORS & GROUNDING INCLUDED	GAC3455TOP	AGK1GGX	BGK3GGX	CPC.5/.75		
	3	1	3	3		

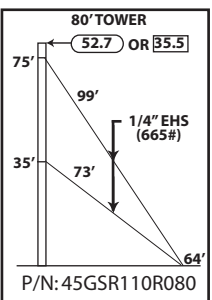

TOWER PARTS INCLUDED	45GSR20	45GSRSB	GA45GD	FDNS	
	4	1	2	BASE	ANCHOR
GUYS & CONNECTIONS INCLUDED	1/4EHS	BG2144	3/8THH	1/2TBE&J	TBSAFETY
	550'	12	12	6	3
ANCHORS & GROUNDING INCLUDED	GAC3455TOP	AGK1GGX	BGK3GGX	CPC.5/.75	
	3	1	3	3	



STANDARD DESIGN - 45GSR
110MPH REV. G

45GSR
SOLID ROD

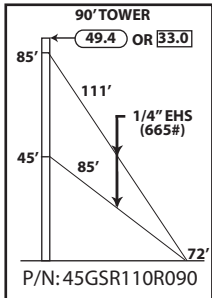

TOWER PARTS INCLUDED	45GSR20	45GSR10	45GSRSB	GA45GD	FDNS	
					BASE	ANCHOR
	4	1	1	2	FB2G	AB2
GUYS & CONNECTIONS INCLUDED	1/4EHS	BG2144	3/8THH	1/2TBE&J	TBSAFETY	
	625'	12	12	6	3	
ANCHORS & GROUNDING INCLUDED	GAC3455TOP	AGK1GGX	BGK3GGX	CPC.5/.75		
	3	1	3	3		

90' ROHN 45GSR
All parts shown in table are included when ordering
Part No: 45GSR110R090

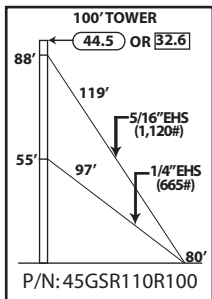

TOWER PARTS INCLUDED	45GSR20	45GSRSB	GA45GD	FDNS		
				BASE	ANCHOR	
	5	1	2	FB2G	AB2	
GUYS & CONNECTIONS INCLUDED	1/4EHS	142265	3/8THH	1/2TBE&J	5/8TBE&J	
	325'	400'	6	3	3	
	7/16THH	BG2144	BG2146	TBSAFETY		
	6	6	6	3		
ANCHORS & GROUNDING INCLUDED	GAC3455TOP	AGK1GGX	BGK3GGX	CPC.5/.75		
	3	1	3	3		

100' ROHN 45GSR
All parts shown in table are included when ordering
Part No: 45GSR110R100

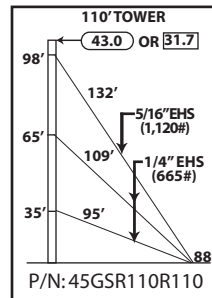

TOWER PARTS INCLUDED	45GSR20	45GSR10	45GSRSB	GA45GD	FDNS	
					BASE	ANCHOR
	5	1	1	3	FB2G	AB2
GUY WIRE & CONNECTION INCLUDED	1/4EHS	142265	3/8THH	1/2TBE&J	5/8TBE&J	
	650'	425'	12	6	3	
	7/16THH	BG2144	BG2146	TBSAFETY		
	6	12	6	3		
ANCHORS & GROUNDING INCLUDED	GAC3455TOP	AGK1GGX	BGK3GGX	CPC.5/.75		
	3	1	3	3		

110' ROHN 45GSR
All parts shown in table are included when ordering
Part No: 45GSR110R110

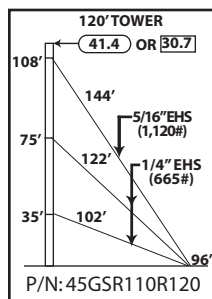

TOWER PARTS INCLUDED	45GSR20	45GSRSB	GA45GD	FDNS		
				BASE	ANCHOR	
	6	1	3	FB2G	AB2	
GUYS & CONNECTIONS INCLUDED	1/4EHS	142265	3/8THH	1/2TBE&J	5/8TBE&J	
	725'	475'	12	6	3	
	7/16THH	BG2144	BG2146	TBSAFETY		
	6	12	6	3		
ANCHORS & GROUNDING INCLUDED	GAC3455TOP	AGK1GGX	BGK3GGX	CPC.5/.75		
	3	1	3	3		

120' ROHN 45GSR
All parts shown in table are included when ordering
Part No: 45GSR110R120



STANDARD DESIGN - 45GSR
110MPH REV. G

45GSR
SOLID ROD

130' ROHN 45GSR
All parts shown in table are included when ordering
Part No: 45GSR110R130

140' ROHN 45GSR
All parts shown in table are included when ordering
Part No: 45GSR110R140

150' ROHN 45GSR
All parts shown in table are included when ordering
Part No: 45GSR110R150

160' ROHN 45GSR
All parts shown in table are included when ordering
Part No: 45GSR110R160

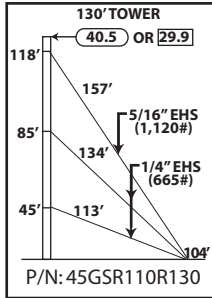

TOWER PARTS INCLUDED	45GSR20	45GSR10	45GSRSB	GA45GD	FDNS	
					BASE	ANCHOR
	6	1	1	3	FB2G	AB2
GUYS & CONNECTIONS INCLUDED	1/4EHS	142265	3/8THH	1/2TBE&J	5/8TBE&J	
	800'	500'	12	6	3	
	7/16THH	BG2144	BG2146	TBSAFETY		
	6	12	6	3		
ANCHORS & GROUNDING INCLUDED	GAC3455TOP	AGK1GGX	BGK3GGX	CPC.5/.75		
	3	1	3	3		

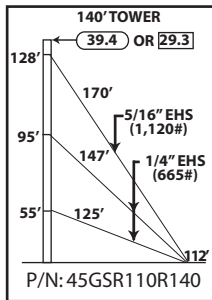

TOWER PARTS INCLUDED	45GSR20	45GSRSB	GA45GD	FDNS		
				BASE	ANCHOR	
	7	1	3	FB2G	AB2	
GUYS & CONNECTIONS INCLUDED	1/4EHS	142265	3/8THH	1/2TBE&J	5/8TBE&J	
	875'	550'	12	6	3	
	7/16THH	BG2144	BG2146	TBSAFETY		
	6	12	6	3		
ANCHORS & GROUNDING INCLUDED	GAC3455TOP	AGK1GGX	BGK3GGX	CPC.5/.75		
	3	1	3	3		

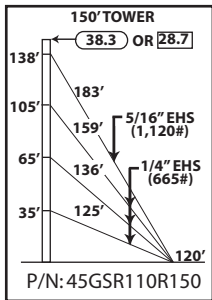

TOWER PARTS INCLUDED	45GSR20	45GSR10	45GSRSB	GA45GD	FDNS	
					BASE	ANCHOR
	7	1	1	4	FB2G	AB3
GUYS & CONNECTIONS INCLUDED	1/4EHS	142265	3/8THH	5/8TBE&J		
	1350'	600'	18	12		
	7/16THH	BG2144	BG2146	TBSAFETY		
	6	18	6	3		
ANCHORS & GROUNDING INCLUDED	GAC5655TOP	AGK1GGX	BGK3GGX	CPC1/1.25		
	3	1	3	3		

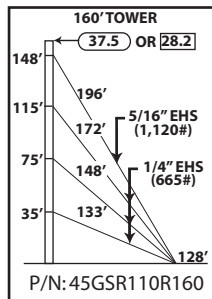

TOWER PARTS INCLUDED	45GSR20	45GSRSB	GA45GD	FDNS		
				BASE	ANCHOR	
	8	1	4	FB2G	AB3	
GUYS & CONNECTIONS INCLUDED	1/4EHS	142265	3/8THH	5/8TBE&J		
	1450'	625'	18	12		
	7/16THH	BG2144	BG2146	TBSAFETY		
	6	18	6	3		
ANCHORS & GROUNDING INCLUDED	GAC5655TOP	AGK1GGX	BGK3GGX	CPC1/1.25		
	3	1	3	3		



**STANDARD DESIGN - 45GSR
110MPH REV. G**

45GSR
SOLID ROD

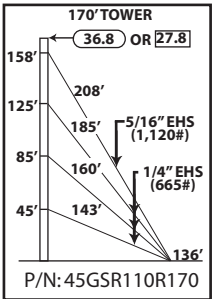

TOWER PARTS INCLUDED	45GSR20	45GSR10	45GSRSB	GA45GD	FDNS	
					BASE	ANCHOR
	8	1	1	4	FB2G	AB3
GUYS & CONNECTIONS INCLUDED	1/4EHS	142265	3/8THH	5/8TB&J		
	1575'	675'	18	12		
	7/16THH	BG2144	BG2146	TBSAFETY		
	6	18	6	3		
ANCHORS & GROUNDING INCLUDED	GAC5655TOP	AGK1GGX	BGK3GGX	CPC1/1.25		
	3	1	3	3		

170' ROHN 45GSR
All parts shown in table are included when ordering
Part No: 45GSR110R170

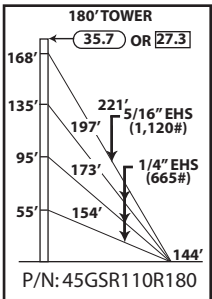

TOWER PARTS INCLUDED	45GSR20	45GSRSB	GA45GD	FDNS		
				BASE	ANCHOR	
	9	1	4	FB2G	AB3	
GUYS & CONNECTIONS INCLUDED	1/4EHS	142265	3/8THH	5/8TB&J		
	1675'	725'	18	12		
	7/16THH	BG2144	BG2146	TBSAFETY		
	6	18	6	3		
ANCHORS & GROUNDING INCLUDED	GAC5655TOP	AGK1GGX	BGK3GGX	CPC1/1.25		
	3	1	3	3		

180' ROHN 45GSR
All parts shown in table are included when ordering
Part No: 45GSR110R180

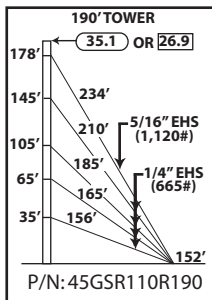

TOWER PARTS INCLUDED	45GSR20	45GSR10	45GSRSB	GA45GD	FDNS	
					BASE	ANCHOR
	9	1	1	5	FB2G	AB3
GUYS & CONNECTIONS INCLUDED	1/4EHS	142265	3/8THH	5/8TB&J		
	2300'	750'	24	15		
	7/16THH	BG2144	BG2146	TBSAFETY		
	6	24	6	3		
ANCHORS & GROUNDING INCLUDED	GAC5655TOP	AGK1GGX	BGK3GGX	CPC1/1.25		
	3	1	3	3		

190' ROHN 45GSR
All parts shown in table are included when ordering
Part No: 45GSR110R190

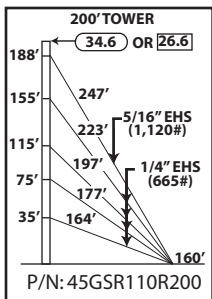

TOWER PARTS INCLUDED	45GSR20	45GSRSB	GA45GD	APL4A	FDNS	
					BASE	ANCHOR
	10	1	5	1	FB2G	AB4
GUYS & CONNECTIONS INCLUDED	1/4EHS	142265	3/8THH	5/8TB&J		
	2425'	800'	24	15		
	7/16THH	BG2144	BG2146	TBSAFETY		
	6	24	6	3		
ANCHORS & GROUNDING INCLUDED	GAC5655TOP	AGK1GGX	BGK3GGX	CPC1/1.25		
	3	1	3	3		

200' ROHN 45GSR
All parts shown in table are included when ordering
Part No: 45GSR110R200



STANDARD DESIGN - 45GSR 110MPH REV. G

45GSR
SOLID ROD

220' ROHN 45GSR
All parts shown in table
are included when ordering
Part No: 45GSR110R220

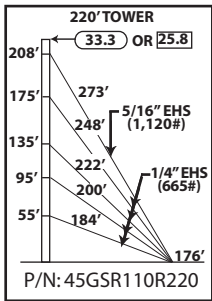

TOWER PARTS INCLUDED	45GSR20	45GSRSB	GA45GD	APL4A	FDNS	
	11	1	5	1	BASE	ANCHOR
GUYS & CONNECTIONS INCLUDED	1/4EHS	142265	3/8THH	5/8TBE&J		
	2725'	875'	24	15		
	7/16THH	BG2144	BG2146	TBSAFETY		
ANCHORS & GROUNDING INCLUDED	6	24	6	3		
	GAC5655TOP	AGK1GGX	BGK3GGX	CPC1/1.25		
	3	1	3	3		

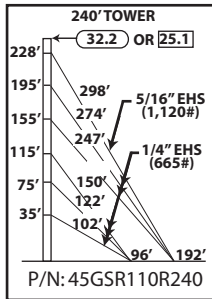

TOWER PARTS INCLUDED	45GSR20	45GSRSB	GA45GD	APL4A	BASE	INNER ANCHOR	OUTER ANCHOR
		12	1	6	1	FB2G	AB2
GUYS & CONNECTIONS INCLUDED	1/4EHS	142265	BG2144	BG2146	3/8THH		
	2850'	950'	30	6	30		
	7/16THH	5/8TBE&J	1/2TBE&J	CPC.5/.75	CPC1/1.25		
ANCHORS & GROUNDING INCLUDED	6	9	9	3	3		
	GAC3455TOP	GAC5655TOP	AGK1GGX	BGK3GGX	TBSAFETY		
	3	3	2	3	6		

240' ROHN 45GSR
All parts shown in
table are included
when ordering
Part No: 45GSR110R240

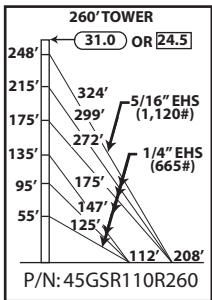

TOWER PARTS INCLUDED	45GSR20	45GSRSB	GA45GD	APL4A	BASE	INNER ANCHOR	OUTER ANCHOR
		13	1	6	1	FB2G	AB2
GUYS & CONNECTIONS INCLUDED	1/4EHS	142265	BG2144	BG2146	3/8THH		
	3250'	1050'	30	6	30		
	7/16THH	5/8TBE&J	1/2TBE&J	CPC.5/.75	CPC1/1.25		
ANCHORS & GROUNDING INCLUDED	6	9	9	3	3		
	GAC3455TOP	GAC5655TOP	AGK1GGX	BGK3GGX	TBSAFETY		
	3	3	2	3	6		

260' ROHN 45GSR
All parts shown in table
are included when ordering
Part No: 45GSR110R260

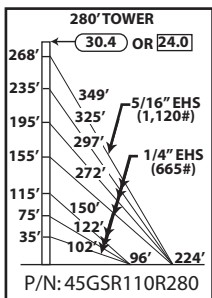

TOWER PARTS INCLUDED	45GSR20	45GSRSB	GA45GD	APL4A	BASE	INNER ANCHOR	OUTER ANCHOR
		14	1	7	1	FB2G	AB2
GUYS & CONNECTIONS INCLUDED	1/4EHS	142265	BG2144	BG2146	3/8THH		
	4050'	1125'	36	6	36		
	7/16THH	5/8TBE&J	1/2TBE&J	CPC.5/.75	CPC1/1.25		
ANCHORS & GROUNDING INCLUDED	6	12	9	3	3		
	GAC3455TOP	GAC5655TOP	AGK1GGX	BGK3GGX	TBSAFETY		
	3	3	2	3	6		

280' ROHN 45GSR
All parts shown in table
are included when ordering
Part No: 45GSR110R280



STANDARD DESIGN - 45GSR
110MPH REV. G

45GSR
SOLID ROD

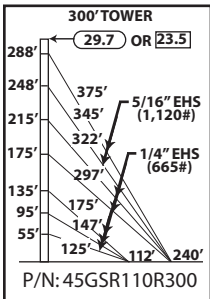

TOWER PARTS INCLUDED	45GSR20	45GSRSB	GA45GD	APL4A	BASE	INNER ANCHOR	OUTER ANCHOR
		15	1	7	1	FB2G	AB2
GUYS & CONNECTIONS INCLUDED	1/4EHS	142265	BG2144	BG2146	3/8THH		
	3400'	2300'	30	12	30		
	7/16THH	5/8TBE&J	1/2TBE&J	CPC.5/1.75	CPC1/1.25		
	12	12	9	3	3		
ANCHORS & GROUNDING INCLUDED	GAC3455TOP	GAC5655TOP	AGK1GGX	BGK3GGX	TBSAFETY		
	3	3	2	3	6		

300' ROHN 45GSR
All parts shown in table are included when ordering
Part No: 45GSR110R300

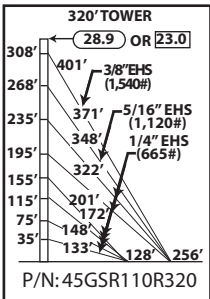

TOWER PARTS INCLUDED	45GSR20	45GSRSB	GA45GD	APL4A	BASE	INNER ANCHOR	OUTER ANCHOR
		15	1	7	1	FB2G	AB3
GUYS & CONNECTIONS INCLUDED	1/4EHS	142265	142261	BG2144	BG2146	BG2147	5/8S
	4225'	1200'	1300'	36	6	6	3
	1/2THH	3/8THH	7/16THH	5/8TBE&J	5/8S	45GSR20L82*	
	6	36	6	24	3	1	
ANCHORS & GROUNDING INCLUDED	GAC5655TOP	AGK1GGX	BGK3GGX	CPC1/1.25	TBSAFETY		
	6	2	3	6	6		

320' ROHN 45GSR
All parts shown in table are included when ordering
Part No: 45GSR110R320

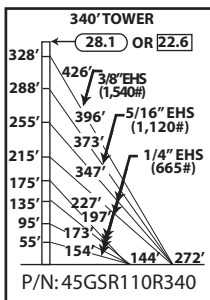

TOWER PARTS INCLUDED	45GSR20	45GSRSB	GA45GD	APL4A	BASE	INNER ANCHOR	OUTER ANCHOR
		16	1	7	1	FB2G	AB3
GUYS & CONNECTIONS INCLUDED	1/4EHS	142265	142261	BG2144	BG2146	BG2147	5/8S
	4700'	1275'	1375'	36	6	6	3
	1/2THH	3/8THH	7/16THH	5/8TBE&J	5/8S	45GSR20L82*	
	6	36	6	24	3	1	
ANCHORS & GROUNDING INCLUDED	GAC5655TOP	AGK1GGX	BGK3GGX	CPC1/1.25	TBSAFETY		
	6	2	3	6	6		

340' ROHN 45GSR
All parts shown in table are included when ordering
Part No: 45GSR110R340

* Guy lug sections required for 3/8" guys.



STANDARD DESIGN - 45GSR
130MPH REV. G

45GSR
SOLID ROD

40' ROHN 45GSR
All parts shown in table are included when ordering
Part No: 45GSR130R040

50' ROHN 45GSR
All parts shown in table are included when ordering
Part No: 45GSR90R050

60' ROHN 45GSR
All parts shown in table are included when ordering
Part No: 45GSR90R060

70' ROHN 45GSR
All parts shown in table are included when ordering
Part No: 45GSR130R070

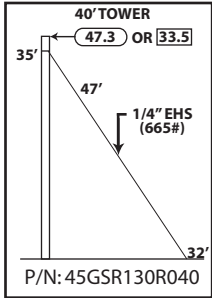

TOWER PARTS INCLUDED	45GSR20	45GSRSB	GA45GD	FDNS	
	2	1	1	BASE	ANCHOR
GUYS & CONNECTIONS INCLUDED	1/4EHS	BG2144	3/8THH	1/2TBE&J	TBSAFETY
	150'	6	6	3	3
ANCHORS & GROUNDING INCLUDED	GAC3455TOP	AGK1GGX	BGK3GGX	CPC.5/.75	
	3	1	3	3	

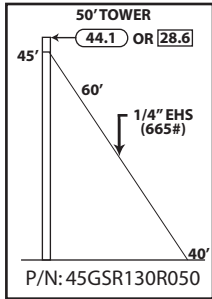

TOWER PARTS INCLUDED	45GSR20	45GSR10	45GSRSB	GA45GD	FDNS	
	2	1	1	1	BASE	ANCHOR
GUYS & CONNECTIONS INCLUDED	1/4EHS	BG2144	3/8THH	1/2TBE&J	TBSAFETY	
	200'	6	6	3	3	
ANCHORS & GROUNDING INCLUDED	GAC3455TOP	AGK1GGX	BGK3GGX	CPC.5/.75		
	3	1	3	3		

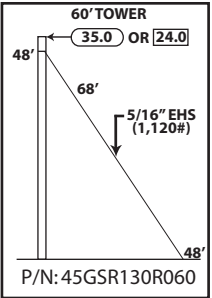

TOWER PARTS INCLUDED	45GSR20	45GSRSB	GA45GD	FDNS	
	3	1	1	BASE	ANCHOR
GUYS & CONNECTIONS INCLUDED	142265	BG2146	7/16THH	5/8TBE&J	TBSAFETY
	225'	6	6	3	3
ANCHORS & GROUNDING INCLUDED	GAC3455TOP	AGK1GGX	BGK3GGX	CPC.5/.75	
	3	1	3	3	

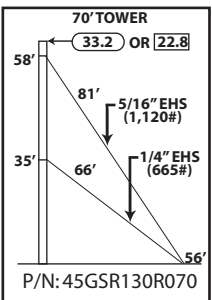

TOWER PARTS INCLUDED	45GSR20	45GSR10	45GSRSB	GA45GD	FDNS	
	3	1	1	2	BASE	ANCHOR
GUYS & CONNECTIONS INCLUDED	1/4EHS	142265	BG2144	BG2146	3/8THH	
	225'	275'	6	6	6	
	7/16THH	1/2TBE&J	5/8TBE&J	TBSAFETY		
	6	3	3	3		
ANCHORS & GROUNDING INCLUDED	GAC3455TOP	AGK1GGX	BGK3GGX	CPC.5/.75		
	3	1	3	3		



STANDARD DESIGN - 45GSR
130MPH REV. G

45GSR
SOLID ROD

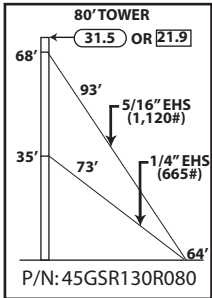

TOWER PARTS INCLUDED	45GSR20	45GSRSB	GA45GD	FDNS	
				BASE	ANCHOR
	4	1	2	FB2G	AB2
GUYS & CONNECTIONS INCLUDED	1/4EHS	142265	BG2144	BG2146	3/8THH
	250'	300'	6	6	6
	7/16THH	1/2TBE&J	5/8TBE&J	TBSAFETY	
	6	3	3	3	
ANCHORS & GROUNDING INCLUDED	GAC3455TOP	AGK1GGX	BGK3GGX	CPC.5/.75	
	3	1	3	3	

80' ROHN 45GSR
All parts shown in table are included when ordering
Part No: 45GSR130R080

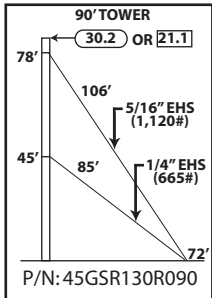

TOWER PARTS INCLUDED	45GSR20	45GSR10	45GSRSB	GA45GD	FDNS	
					BASE	ANCHOR
	4	1	1	2	FB2G	AB2
GUYS & CONNECTIONS INCLUDED	1/4EHS	142265	BG2144	BG2146	3/8THH	
	275'	350'	6	6	6	
	7/16THH	1/2TBE&J	5/8TBE&J	TBSAFETY		
	6	3	3	3		
ANCHORS & GROUNDING INCLUDED	GAC3455TOP	AGK1GGX	BGK3GGX	CPC.5/.75		
	3	1	3	3		

90' ROHN 45GSR
All parts shown in table are included when ordering
Part No: 45GSR130R090

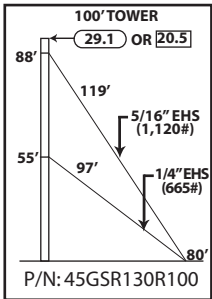

TOWER PARTS INCLUDED	45GSR20	45GSRSB	GA45GD	FDNS	
				BASE	ANCHOR
	5	1	2	FB2G	AB2
GUYS & CONNECTIONS INCLUDED	1/4EHS	142265	BG2144	BG2146	3/8THH
	325'	400'	6	6	6
	7/16THH	1/2TBE&J	5/8TBE&J	TBSAFETY	
	6	3	3	3	
ANCHORS & GROUNDING INCLUDED	GAC3455TOP	AGK1GGX	BGK3GGX	CPC.5/.75	
	3	1	3	3	

100' ROHN 45GSR
All parts shown in table are included when ordering
Part No: 45GSR130R100

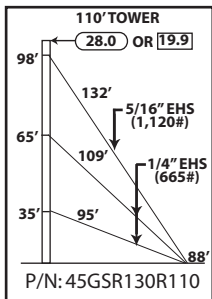

TOWER PARTS INCLUDED	45GSR20	45GSR10	45GSRSB	GA45GD	FDNS	
					BASE	ANCHOR
	5	1	1	3	FB2G	AB3
GUYS & CONNECTIONS INCLUDED	1/4EHS	142265	BG2144	BG2146		
	650'	425'	12	6		
	3/8THH	7/16THH	5/8TBE&J	TBSAFETY		
	12	6	9	3		
ANCHORS & GROUNDING INCLUDED	GAC5655TOP	AGK1GGX	BGK3GGX	CPC1/1.25		
	3	1	3	3		

110' ROHN 45GSR
All parts shown in table are included when ordering
Part No: 45GSR130R110



STANDARD DESIGN - 45GSR
130MPH REV. G

45GSR
SOLID ROD

120' ROHN 45GSR
All parts shown in table are included when ordering
Part No: 45GSR130R120

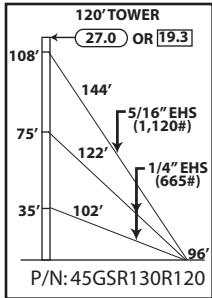

TOWER PARTS INCLUDED	45GSR20	45GSRSB	GA45GD	FDNS	
				BASE	ANCHOR
	6	1	3	FB2G	AB3
GUYS & CONNECTIONS INCLUDED	1/4EHS	142265	BG2144	BG2146	
	725'	475'	12	6	
	3/8THH	7/16THH	5/8TBE&J	TBSAFETY	
	12	6	9	3	
ANCHORS & GROUNDING INCLUDED	GAC5655TOP	AGK1GGX	BGK3GGX	CPC1/1.25	
	3	1	3	3	

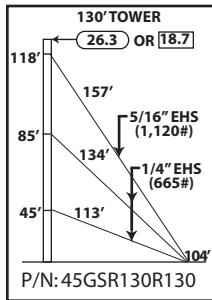

TOWER PARTS INCLUDED	45GSR20	45GSR10	45GSRSB	GA45GD	FDNS	
					BASE	ANCHOR
	6	1	1	3	FB2G	AB3
GUYS & CONNECTIONS INCLUDED	1/4EHS	142265	BG2144	BG2146		
	800'	500'	12	6		
	3/8THH	7/16THH	5/8TBE&J	TBSAFETY		
	12	6	9	3		
ANCHORS & GROUNDING INCLUDED	GAC5655TOP	AGK1GGX	BGK3GGX	CPC1/1.25		
	3	1	3	3		

130' ROHN 45GSR
All parts shown in table are included when ordering
Part No: 45GSR130R130

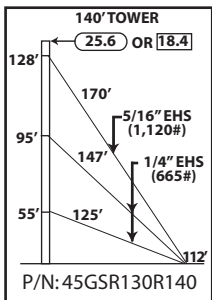

TOWER PARTS INCLUDED	45GSR20	45GSRSB	GA45GD	FDNS	
				BASE	ANCHOR
	7	1	3	FB2G	AB3
GUYS & CONNECTIONS INCLUDED	1/4EHS	142265	BG2144	BG2146	
	875'	550'	12	6	
	3/8THH	7/16THH	5/8TBE&J	TBSAFETY	
	12	6	9	3	
ANCHORS & GROUNDING INCLUDED	GAC5655TOP	AGK1GGX	BGK3GGX	CPC1/1.25	
	3	1	3	3	

140' ROHN 45GSR
All parts shown in table are included when ordering
Part No: 45GSR130R140

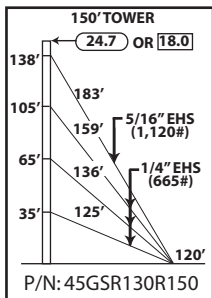

TOWER PARTS INCLUDED	45GSR20	45GSR10	45GSRSB	GA45GD	FDNS	
					BASE	ANCHOR
	7	1	1	4	FB2G	AB4
GUYS & CONNECTIONS INCLUDED	1/4EHS	142265	BG2144	BG2146		
	1350'	600'	18	6		
	3/8THH	7/16THH	3/4TBE&J	TBSAFETY		
	18	6	12	3		
ANCHORS & GROUNDING INCLUDED	GAC5755TOP	AGK1GGX	BGK3GGX	CPC1.5/2		
	3	1	3	3		

150' ROHN 45GSR
All parts shown in table are included when ordering
Part No: 45GSR130R150



STANDARD DESIGN - 45GSR
130MPH REV. G

45GSR
SOLID ROD

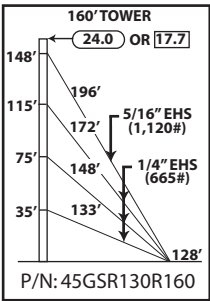

TOWER PARTS INCLUDED	45GSR20	45GSRSB	GA45GD	FDNS	
				BASE	ANCHOR
	8	1	4	FB2G	AB4
GUYS & CONNECTIONS INCLUDED	1/4EHS	142265	BG2144	BG2146	
	1450'	625'	18	6	
	3/8THH	7/16THH	3/4TBE&J	TBSAFETY	
	18	6	12	3	
ANCHORS & GROUNDING INCLUDED	GAC5755TOP	AGK1GGX	BGK3GGX	CPC1.5/2	
	3	1	3	3	

160' ROHN 45GSR
All parts shown in table are included when ordering
Part No: 45GSR130R160

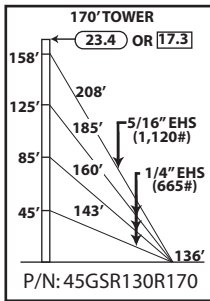

TOWER PARTS INCLUDED	45GSR20	45GSR10	45GSRSB	GA45GD	FDNS	
					BASE	ANCHOR
	8	1	1	4	FB2G	AB4
GUYS & CONNECTIONS INCLUDED	1/4EHS	142265	BG2144	BG2146		
	1575'	675'	18	6		
	3/8THH	7/16THH	3/4TBE&J	TBSAFETY		
	18	6	12	3		
ANCHORS & GROUNDING INCLUDED	GAC5755TOP	AGK1GGX	BGK3GGX	CPC1.5/2		
	3	1	3	3		

170' ROHN 45GSR
All parts shown in table are included when ordering
Part No: 45GSR130R170

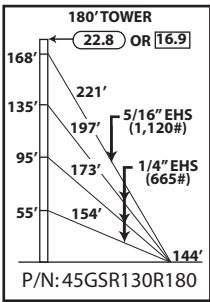

TOWER PARTS INCLUDED	45GSR20	45GSRSB	GA45GD	FDNS	
				BASE	ANCHOR
	9	1	4	FB2G	AB4
GUYS & CONNECTIONS INCLUDED	1/4EHS	142265	BG2144	BG2146	
	1675'	725'	18	6	
	3/8THH	7/16THH	3/4TBE&J	TBSAFETY	
	18	6	12	3	
ANCHORS & GROUNDING INCLUDED	GAC5755TOP	AGK1GGX	BGK3GGX	CPC1.5/2	
	3	1	3	3	

180' ROHN 45GSR
All parts shown in table are included when ordering
Part No: 45GSR130R180

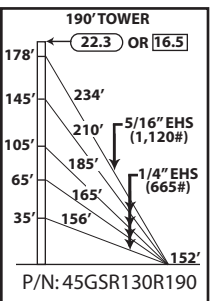

TOWER PARTS INCLUDED	45GSR20	45GSR10	45GSRSB	GA45GD	FDNS	
					BASE	ANCHOR
	9	1	1	5	FB2G	AB4
GUYS & CONNECTIONS INCLUDED	1/4EHS	142265	BG2144	BG2146		
	2300'	750'	24	6		
	3/8THH	7/16THH	3/4TBE&J	TBSAFETY		
	24	6	15	3		
ANCHORS & GROUNDING INCLUDED	GAC5755TOP	AGK1GGX	BGK3GGX	CPC1.5/2		
	3	1	3	3		

190' ROHN 45GSR
All parts shown in table are included when ordering
Part No: 45GSR130R190



STANDARD DESIGN - 45GSR 130MPH REV. G

45GSR
SOLID ROD

200' ROHN 45GSR
All parts shown in table
are included when ordering
Part No: 45GSR130R200

220' ROHN 45GSR
All parts shown in table
are included when ordering
Part No: 45GSR130R220

240' ROHN 45GSR
All parts shown in table
are included when ordering
Part No: 45GSR130R240

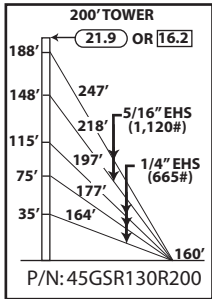

TOWER PARTS INCLUDED	45GSR20	45GSRSB	GA45GD	APL4A	FDNS	
	10	1	5	1	BASE	ANCHOR
GUYS & CONNECTIONS INCLUDED	1/4EHS	142265	BG2144	BG2146		
	1725'	1500'	18	12		
	3/8THH	7/16THH	3/4TBE&J	TBSAFETY		
	18	12	15	3		
ANCHORS & GROUNDING INCLUDED	GAC5755TOP	AGK1GGX	BGK3GGX	CPC1.5/2		
	3	1	3	3		

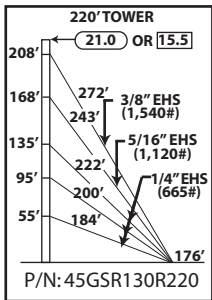

TOWER PARTS INCLUDED	45GSR20	45GSRSB	GA45GD	APL4A	FDNS	
	10	1	4	1	BASE	ANCHOR
GUYS & CONNECTIONS INCLUDED	1/4EHS	142265	142261	BG2144	45GSR20L82*	
	1950'	775'	875'	18	1	
	BG2146	BG2147	7/16THH	1/2THH		
	6	6	6	6		
	3/8THH	5/8S	3/4TBE&J	TBSAFETY		
	18	3	15	3		
ANCHORS & GROUNDING INCLUDED	GAC5755TOP	AGK1GGX	BGK3GGX	CPC1.5/2		
	3	1	3	3		

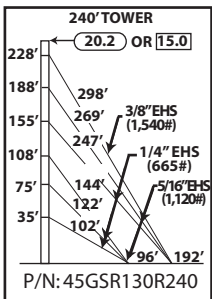

TOWER PARTS INCLUDED	45GSR20	45GSRSB	GA45GD	APL4A	BASE	INNER ANCHOR	OUTER ANCHOR
	11	1	5	1	FB2G	AB3	AB4
GUYS & CONNECTIONS INCLUDED	1/4EHS	142265	142261	BG2144	45GSR20L82*		
	1500'	1325'	950'	18	1		
	BG2146	BG2147	7/16THH	1/2THH			
	12	6	12	6			
	3/8THH	5/8S	5/8TBE&J	TBSAFETY			
	18	3	18	6			
ANCHORS & GROUNDING INCLUDED	GAC5655TOP	AGK1GGX	BGK3GGX	CPC1/1.25			
	6	2	3	6			

* Guy lug section required for 3/8" guys.



STANDARD DESIGN - 45GSR
130MPH REV. G

45GSR
SOLID ROD

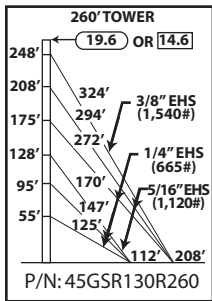

TOWER PARTS INCLUDED	45GSR20	45GSRSB	GA45GD	APL4A	BASE	INNER ANCHOR	OUTER ANCHOR
	12	1	5	1	FB2G	AB3	AB4
GUYS & CONNECTIONS INCLUDED	1/4EHS	142265	142261	BG2144	45GSR20.82"		
	1750'	1500'	1050'	18	1		
	BG2146	BG2147	7/16THH	1/2THH			
	12	6	12	6			
	3/8THH	5/8S	5/8TBE&J	TBSAFETY			
	18	3	18	6			
ANCHORS & GROUNDING INCLUDED	GAC5655TOP	AGK1GGX	BGK3GGX	CPC1/1.25			
	6	2	3	6			

260' ROHN 45GSR
All parts shown in table are included when ordering
Part No: 45GSR130R260

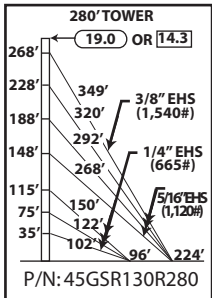

TOWER PARTS INCLUDED	45GSR20	45GSRSB	GA45GD	APL4A	BASE	INNER ANCHOR	OUTER ANCHOR
	13	1	6	1	FB2G	AB3	AB5
GUYS & CONNECTIONS INCLUDED	1/4EHS	142265	142261	BG2144	45GSR20.82"		
	1200'	2800'	1125'	18	1		
	BG2146	BG2147	7/16THH	1/2THH			
	18	6	18	6			
	3/8THH	5/8S	3/4TBE&J	TBSAFETY			
	18	3	21	6			
ANCHORS & GROUNDING INCLUDED	GAC5755TOP	AGK1GGX	BGK3GGX	CPC1.5/2			
	6	2	3	6			

280' ROHN 45GSR
All parts shown in table are included when ordering
Part No: 45GSR130R280

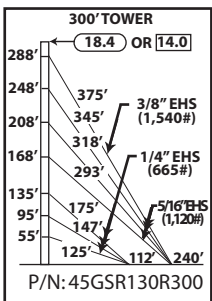

TOWER PARTS INCLUDED	45GSR20	45GSRSB	GA45GD	APL4A	BASE	INNER ANCHOR	OUTER ANCHOR
	14	1	6	1	FB3G	AB3	AB5
GUYS & CONNECTIONS INCLUDED	1/4EHS	142265	142261	BG2144	45GSR20.82"		
	1425'	3050'	1200'	18	1		
	BG2146	BG2147	7/16THH	1/2THH			
	18	6	18	6			
	3/8THH	5/8S	3/4TBE&J	TBSAFETY			
	18	3	21	6			
ANCHORS & GROUNDING INCLUDED	GAC5755TOP	AGK1GGX	BGK3GGX	CPC1.5/2			
	6	2	3	6			

300' ROHN 45GSR
All parts shown in table are included when ordering
Part No: 45GSR130R300

* Guy lug section required for 3/8" guys.



STANDARD DESIGN - 45GSR 130MPH REV. G

45GSR
SOLID ROD

320' ROHN 45GSR
All parts shown in table
are included when ordering
Part No: 45GSR130R320

340' ROHN 45GSR
All parts shown in table
are included when ordering
Part No: 45GSR130R340

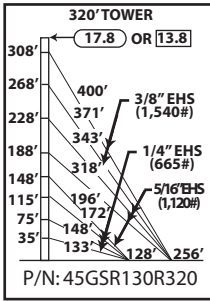

TOWER PARTS INCLUDED	45GSR20	45GSRSB	GA45GD	APL4A	BASE	INNER ANCHOR	OUTER ANCHOR
		14	1	6	1	FB3G	AB3
GUYS & CONNECTIONS INCLUDED	1/4EHS	142265	142261	BG2144	45GSR20L82*		
	1450'	2750'	2475'	18	2		
	BG2146	BG2147	7/16THH	1/2THH			
	18	12	18	12			
	3/8THH	5/8S	3/4TBE&J	TBSAFETY			
ANCHORS & GROUNDING INCLUDED	18	6	24	6			
	GAC5755TOP	AGK1GGX	BGK3GGX	CPC1.5/2			
	6	2	3	6			

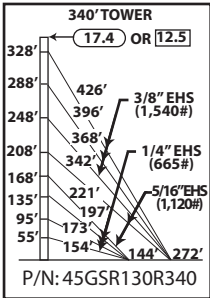

TOWER PARTS INCLUDED	45GSR20	45GSRSB	GA45GD	APL4A	BASE	INNER ANCHOR	OUTER ANCHOR
		14	1	5	1	FB3G	AB4
GUYS & CONNECTIONS INCLUDED	1/4EHS	142265	142261	BG2144	45GSR20L82*		
	1675'	1800'	3800'	18	3		
	BG2146	BG2147	7/16THH	1/2THH			
	12	18	12	18			
	3/8THH	5/8S	3/4TBE&J	TBSAFETY			
ANCHORS & GROUNDING INCLUDED	18	9	24	6			
	GAC5755TOP	AGK1GGX	BGK3GGX	CPC1.5/2			
	6	2	3	6			

* Guy lug section required for 3/8" guys.

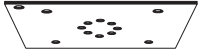
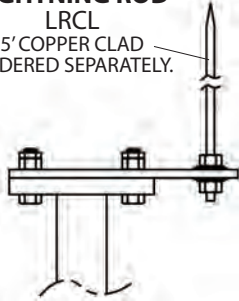
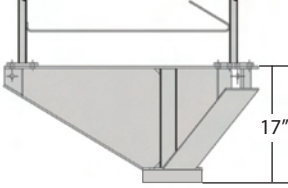
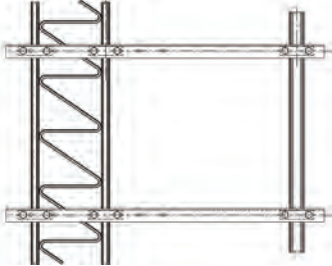
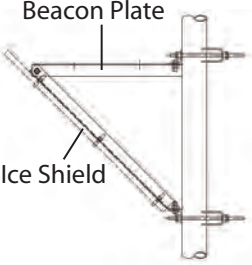
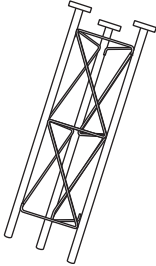

PARTS & ACCESSORIES

 <p>LEG MOUNTED BEACON PLATE KIT APL4A</p> <p>FOR MOUNTING BEACON OR LIGHTNING ROD. BOLTS TO TOP OF STANDARD SECTION. INCLUDES BEACON PLATE, (2) CAP PLATES, NUTS AND BOLTS.</p>	<p>LIGHTNING ROD LRCL 5' COPPER CLAD ORDERED SEPARATELY.</p>  <p>LIGHTNING ROD PLATE KIT VW132</p> <p>INCLUDES: LIGHTNING ROD PLATE, NUTS AND BOLTS.</p>	 <p>TAPERED BASE 45GSRTBPP*</p> <p>FOR USE WITH PIER PIN (3/4X12PP) AND BEARING PLATE (BP6) SOLD SEPARATELY.</p>	 <p>3' SIDE ARM WITH (2) TIE BACKS KY1653A</p> <p>MOUNTING TUBE PROVIDED IS 3' LONG, 2 - 3/8" O.D.</p>
 <p>MID BEACON PLATE / ICE SHIELD APL1258UM</p>	 <p>4.3' SHORT BASE 45GSRSB</p> <p>FOR EMBEDMENT IN CONCRETE.</p>		

Refer to pages 63-65 for the following accessories that also fit the 45GSR tower:

- Pier Pin (3/4x12PP)
- Side Arm Bracket (SA253UA)
- Dish Mount (VY4311A2 & VY4311A)
- Face Mount (DM45G2 & DM454)
- Universal House Bracket (HBUTVRO)
- Torque Bar (TB45D)
- Guy Bracket (GA45GD)
- Anti-Climb Panels (VW913A)
- Work Platform (WP45G)
- Safety Ring (SR245)
- Climbing Harness (TTFBH-4D & TTFBH-C/P)
- Safety Cable Slider (TT-WG-500-W/SMC)
- Safety Cable System (See page 65 for P/N)

* TOWERS MOUNTED ON THESE BASES MUST BE BRACKETED OR GUYED AT ALL TIMES. TEMPORARY STEEL GUYING MAY ALSO BE NECESSARY DURING INSTALLATION AND DISMANTLING.



ANCHOR INFORMATION

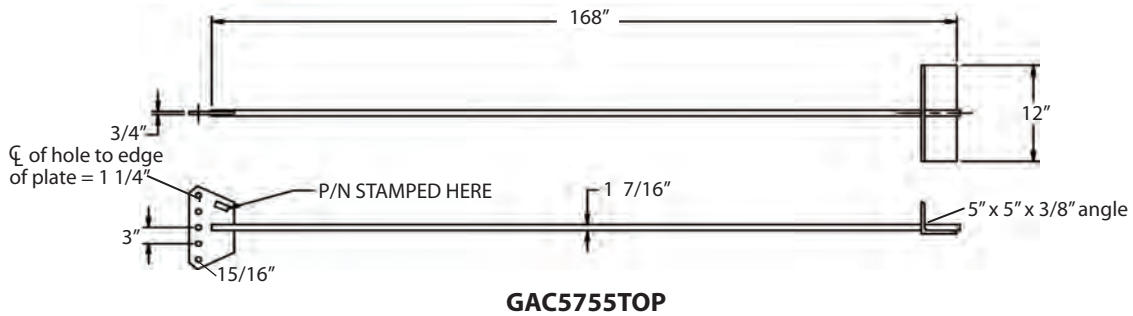
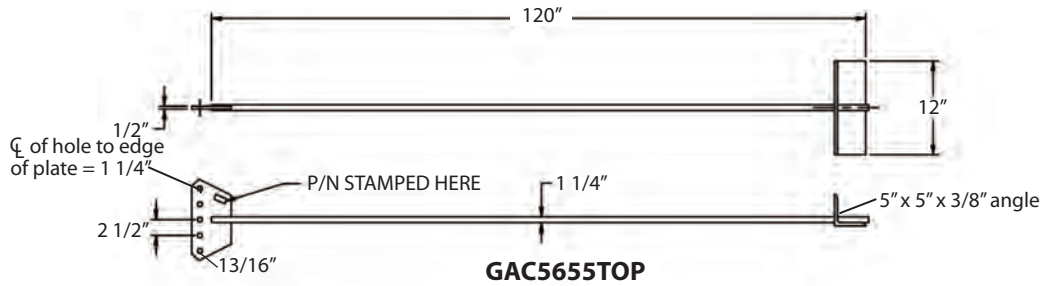
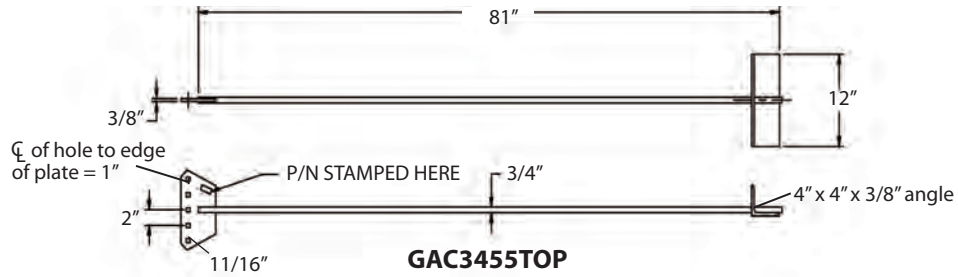

REV G
ANCHOR GROUNDING
AGK1GGX

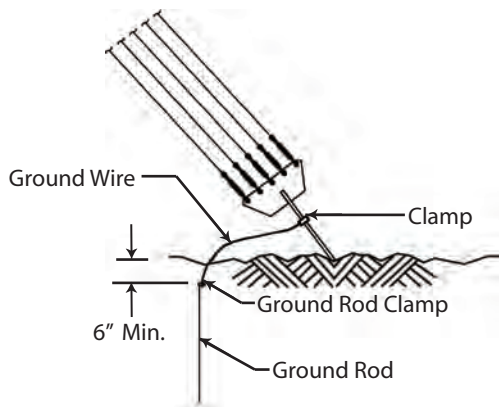

REV G
BASE GROUNDING
BGK3GGX

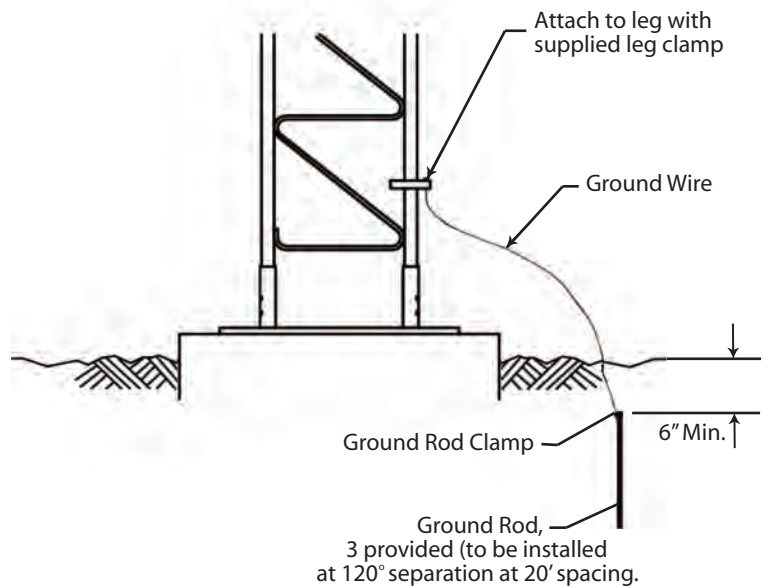

STANDARD ANCHOR BLOCKS

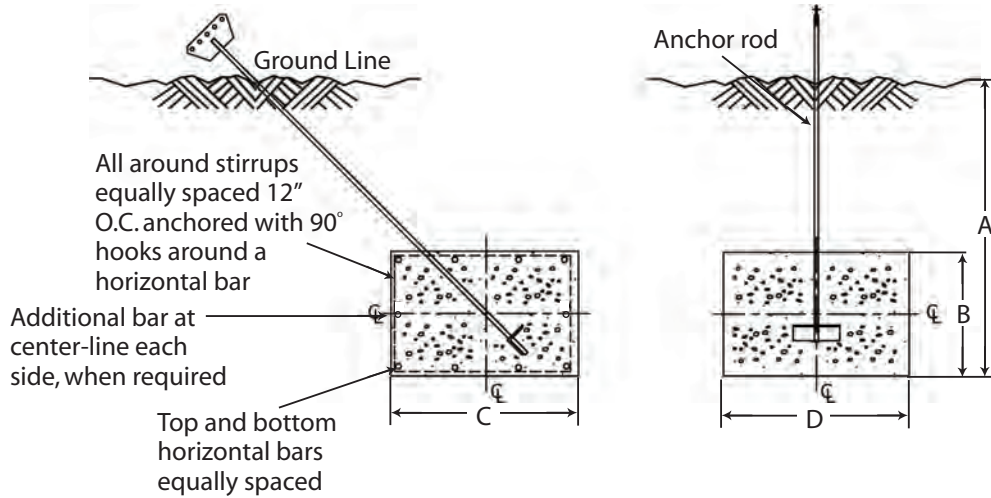

Refer to pages 95-96 for anchor rod installation angles.

Block	Anchor Dimensions (in.)				Horizontal Bars (Qty. & Size)	Stirrup Size & Spacing	Concrete Vol. (Cu. Yds.)
	A	B	C	D			
AB2	4' - 0"	1' - 6"	4' - 0"	6' - 0"	(5) #6 Bars, Top Layer (5) #6 Bars, Bottom Layer (0) Additional Bar, Each Side	#3 @ 12" O.C.	1.33 Per Block 4.0 Total for 3
AB3	6' - 0"	1' - 6"	3' - 0"	6' - 0"	(4) #6 Bars, Top Layer (4) #6 Bars, Bottom Layer (0) Additional Bar, Each Side	#3 @ 12" O.C.	1.0 Per Block 3.0 Total for 3
AB4	6' - 0"	1' - 6"	4' - 0"	9' - 0"	(5) #6 Bars, Top Layer (5) #6 Bars, Bottom Layer (0) Additional Bar, Each Side	#4 @ 12" O.C.	2.0 Per Block 6.0 Total for 3
AB5	8' - 0"	2' - 0"	3' - 0"	10' - 0"	(4) #7 Bars, Top Layer (4) #7 Bars, Bottom Layer (1) Additional Bar, Each Side	#4 @ 12" O.C.	2.22 Per Block 6.7 Total for 3
AB6	8' - 0"	2' - 0"	4' - 0"	10' - 0"	(5) #7 Bars, Top Layer (5) #7 Bars, Bottom Layer (1) Additional Bar, Each Side	#4 @ 12" O.C.	2.96 Per Block 8.9 Total for 3



ANCHOR ROD INSTALLATION ANGLES

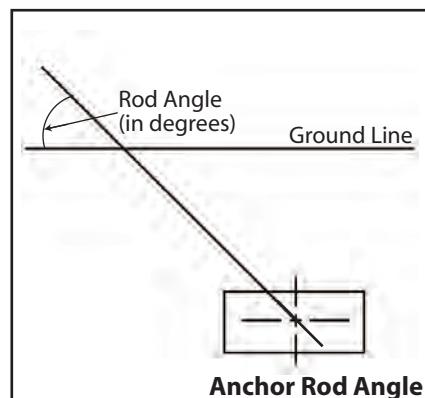
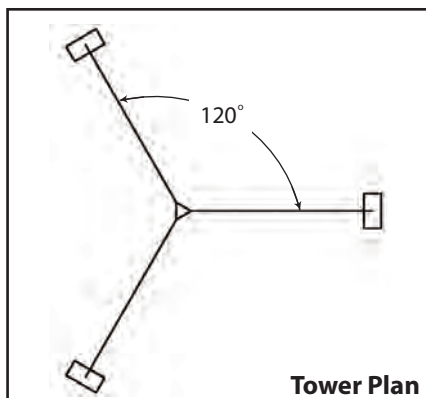

45GSR 90MPH				
Tower Height	Inner Rod Number	Inner Rod Angle	Outer Rod Number	Outer Rod Angle
40'	GAC3455TOP	48	-	-
50'	GAC3455TOP	49	-	-
60'	GAC3455TOP	49	-	-
70'	GAC3455TOP	44	-	-
80'	GAC3455TOP	43	-	-
90'	GAC3455TOP	44	-	-
100'	GAC3455TOP	44	-	-
110'	GAC3455TOP	42	-	-
120'	GAC3455TOP	42	-	-
130'	GAC3455TOP	42	-	-
140'	GAC3455TOP	42	-	-
150'	GAC3455TOP	40	-	-
160'	GAC3455TOP	40	-	-
170'	GAC5655TOP	40	-	-
180'	GAC5655TOP	41	-	-
190'	GAC5655TOP	40	-	-
200'	GAC5655TOP	40	-	-
220'	GAC5655TOP	40	-	-
240'	GAC3455TOP	38	GAC3455TOP	46
260'	GAC3455TOP	40	GAC3455TOP	46
280'	GAC3455TOP	38	GAC5655TOP	44
300'	GAC3455TOP	40	GAC5655TOP	44
320'	GAC3455TOP	37	GAC5655TOP	45
340'	GAC3455TOP	38	GAC5655TOP	45

45GSR 110MPH				
Tower Height	Inner Rod Number	Inner Rod Angle	Outer Rod Number	Outer Rod Angle
40'	GAC3455TOP	48	-	-
50'	GAC3455TOP	49	-	-
60'	GAC3455TOP	49	-	-
70'	GAC3455TOP	43	-	-
80'	GAC3455TOP	42	-	-
90'	GAC3455TOP	43	-	-
100'	GAC3455TOP	44	-	-
110'	GAC3455TOP	41	-	-
120'	GAC3455TOP	41	-	-
130'	GAC3455TOP	41	-	-
140'	GAC3455TOP	42	-	-
150'	GAC5655TOP	40	-	-
160'	GAC5655TOP	40	-	-
170'	GAC5655TOP	40	-	-
180'	GAC5655TOP	40	-	-
190'	GAC5655TOP	40	-	-
200'	GAC5655TOP	40	-	-
220'	GAC5655TOP	40	-	-
240'	GAC3455TOP	39	GAC5655TOP	45
260'	GAC3455TOP	40	GAC5655TOP	45
280'	GAC3455TOP	39	GAC5655TOP	43
300'	GAC3455TOP	40	GAC5655TOP	44
320'	GAC5655TOP	40	GAC5655TOP	44
340'	GAC5655TOP	40	GAC5655TOP	44

See the following page for 45GSR | 130mph anchor rod slopes.



ANCHOR ROD INSTALLATION ANGLES

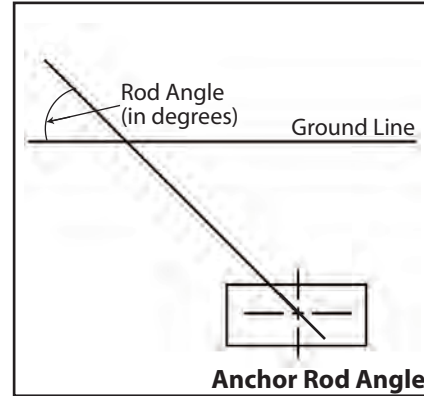
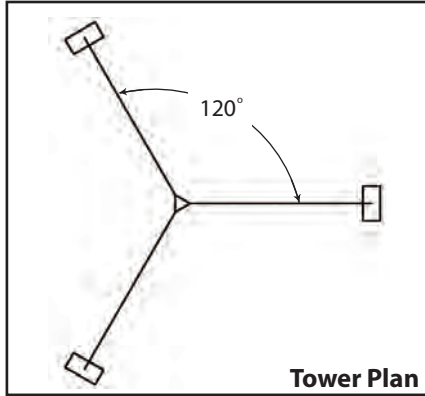

45GSR 130MPH				
Tower Height	Inner Rod Number	Inner Rod Angle	Outer Rod Number	Outer Rod Angle
40'	GAC3455TOP	48	-	-
50'	GAC3455TOP	48	-	-
60'	GAC3455TOP	45	-	-
70'	GAC3455TOP	42	-	-
80'	GAC3455TOP	42	-	-
90'	GAC3455TOP	43	-	-
100'	GAC3455TOP	43	-	-
110'	GAC5655TOP	40	-	-
120'	GAC5655TOP	40	-	-
130'	GAC5655TOP	41	-	-
140'	GAC5655TOP	41	-	-
150'	GAC5755TOP	39	-	-
160'	GAC5755TOP	38	-	-
170'	GAC5755TOP	39	-	-
180'	GAC5755TOP	39	-	-
190'	GAC5755TOP	37	-	-
200'	GAC5755TOP	38	-	-
220'	GAC5755TOP	38	-	-
240'	GAC5655TOP	40	GAC5655TOP	45
260'	GAC5655TOP	41	GAC5655TOP	45
280'	GAC5755TOP	38	GAC5755TOP	42
300'	GAC5755TOP	39	GAC5755TOP	43
320'	GAC5755TOP	37	GAC5655TOP	43
340'	GAC5755TOP	38	GAC5655TOP	43



STANDARD MAT FOUNDATION FOR 45GSR TOWERS

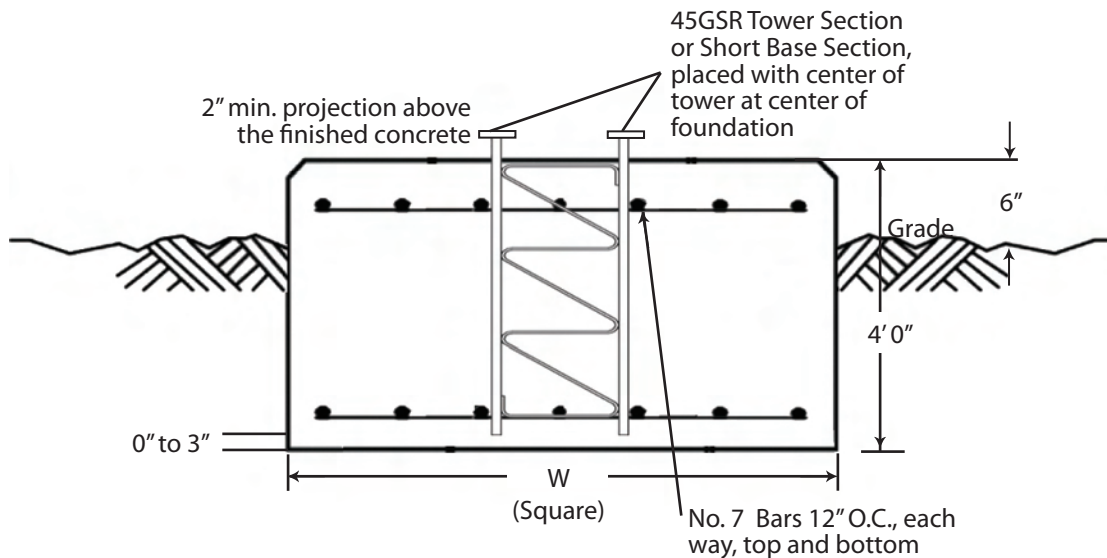

Base	Mat Width (W)	Concrete Vol. (Cu. Yds.)
FB1G	4' - 6"	3.0
FB2G	5' - 3"	4.1
FB3G	6' - 3"	5.8



STANDARD METEOROLOGICAL TOWERS

Complete Kit Includes:

- Assembly and foundation drawings
- All necessary tower sections
- Tower short base
- All guy wire and connectors
- All guy anchors
- Base and anchor grounding kits

60 m

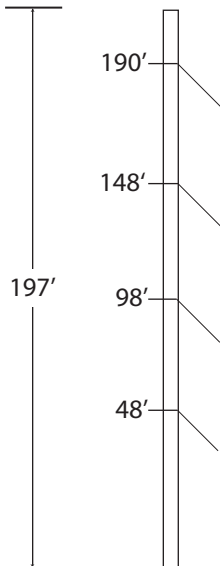
**60MMET**

- 4 Guy Elevations
- 1 Fixed Base Foundation
- 1 Anchor Radius

Boom Height	EPA / WT. (no ice)	EPA / WT. (3/4" radial ice)
40 m	9.00 sq. ft. / 200 lbs.	25.00 sq. ft. / 600 lbs.
50 m	9.00 sq. ft. / 200 lbs.	25.00 sq. ft. / 600 lbs.
60 m	9.00 sq. ft. / 200 lbs.	25.00 sq. ft. / 600 lbs.

ANSI/TIA-222-G
 110 MPH - 3 Second Gust (No Ice)
 50 MPH - 3 Second Gust (3/4" Radial Ice)
 Structure Class II
 Exposure Category C
 Topographic Category I

80 m

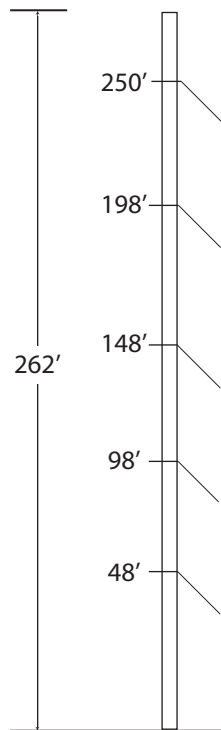
**80MMET**

- 5 Guy Elevations
- 1 Fixed Base Foundation
- 1 Anchor Radius

Boom Height	EPA / WT. (no ice)	EPA / WT. (3/4" radial ice)
60 m	9.00 sq. ft. / 200 lbs.	25.00 sq. ft. / 600 lbs.
70 m	9.00 sq. ft. / 200 lbs.	25.00 sq. ft. / 600 lbs.
80 m	9.00 sq. ft. / 200 lbs.	25.00 sq. ft. / 600 lbs.

ANSI/TIA-222-G
 110 MPH - 3 Second Gust (No Ice)
 50 MPH - 3 Second Gust (3/4" Radial Ice)
 Structure Class II
 Exposure Category C
 Topographic Category I

100 m

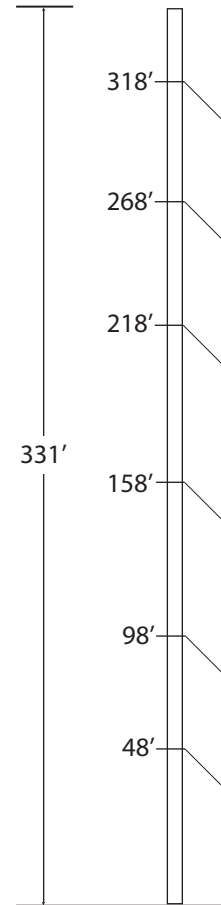
**100MMET**

- 6 Guy Elevations
- 1 Fixed Base Foundation
- 2 Anchor Radii

Boom Height	EPA / WT. (no ice)	EPA / WT. (3/4" radial ice)
50 m	9.00 sq. ft. / 200 lbs.	25.00 sq. ft. / 600 lbs.
75 m	9.00 sq. ft. / 200 lbs.	25.00 sq. ft. / 600 lbs.
100 m	9.00 sq. ft. / 200 lbs.	25.00 sq. ft. / 600 lbs.

ANSI/TIA-222-G
 110 MPH - 3 Second Gust (No Ice)
 50 MPH - 3 Second Gust (3/4" Radial Ice)
 Structure Class II
 Exposure Category C
 Topographic Category I

Tower design assumes (1) elevator track over height of structure.



STANDARD 45GSR METEOROLOGICAL TOWER

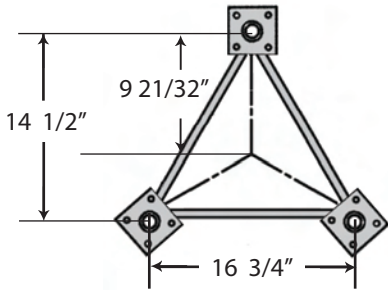

Tower Height (m)	Guy Radius (ft.) 120° separation	Base Foundation No.	Anchor Foundation No.
60	156	FB2G	AB4
80	210	FB3G	AB5
100	106 / 264	FB3G	AB2 / AB6

Refer to page 288 for anchor rod details.
FOR FOUNDATION INFORMATION, PLEASE SEE PAGES 94 & 97. FOR GENERAL INSTALLATION INFORMATION, PLEASE SEE PAGES 147-153.

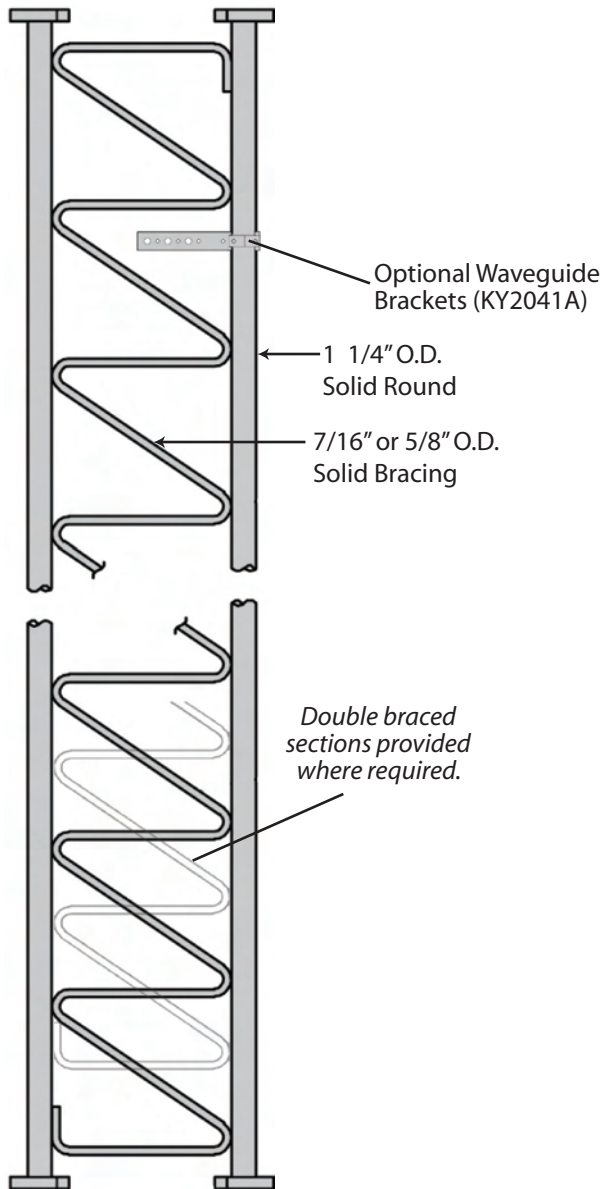

STANDARD SECTION
45GSR10 - 10' Section
45GSR20 - 20' Section

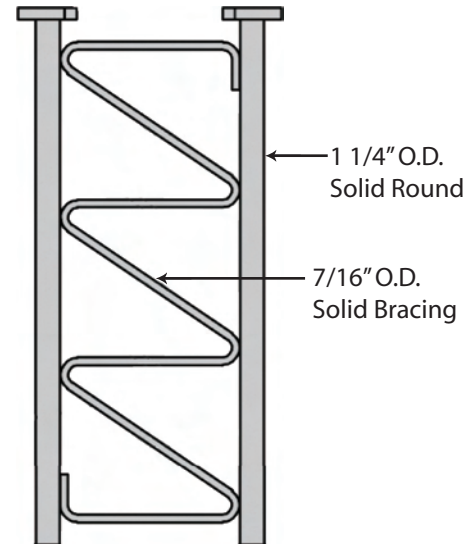

4.3' 45GSR SHORT BASE
45GSRSB

TO BE EMBEDDED IN CONCRETE.



STANDARD 55G GUYED TOWER

ROHN 55G
The first. The original.



55G



GENERAL USE

The 55G lends itself to a wide variety of uses, particularly where unusual wind loading and height requirements exist. The 55G was designed to provide excellent strength in heights up to 400'.

FEATURES

- Completely hot-dip galvanized after fabrication
- Built on a 17" equilateral triangle design
- High strength tubular legs joined by Zig-Zag® cross members
- Each section contains all required nuts and bolts shipped with section
- Continuous solid round steel bracing

CAUTION

Mixing copies of ROHN towers with ROHN towers is dangerous and voids all engineering and warranty data supplied by ROHN. Materials used by others are not the same quality and have not been tested or engineered by ROHN. Mixing ROHN tower sections with non-ROHN products may cause tower failure or injury.

Per Rev G requirements, any structure greater than 10' requires a climber safety device. Please see page 116 for ordering information.