

## STARFLEET EQUIPMENT

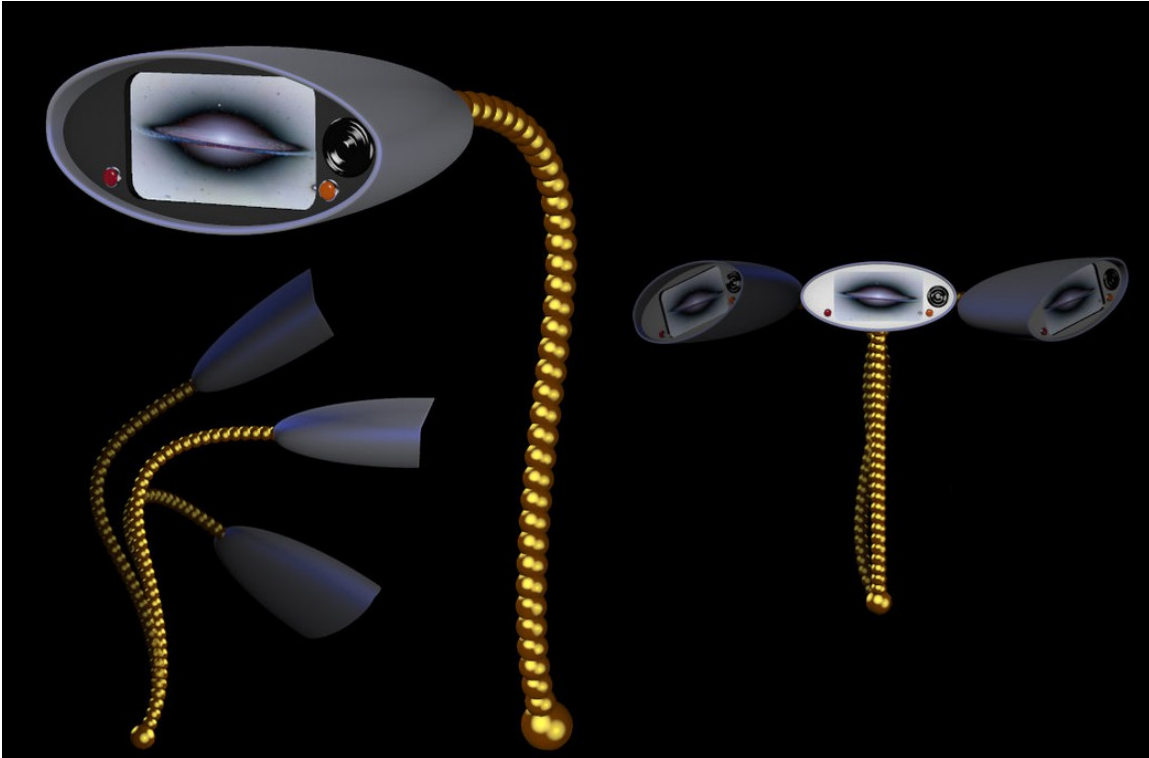

**MARS Viewer (Modular A/V Receiver System);** (c.2238-2265)

Specifications: approx. 31 cm in length; 1 kg

Duration/Energy: Unlimited

**Description:** These small audio/visual devices are generally mounted on bendable "goose/snake" necks and can be found everywhere on a starship from work stations to crew quarters. MARS Viewers can be removed or replaced using dedicated ports on almost any computer or work station. MARS Viewers have several methods of projection, they can either display an image on their 5.08 x 6.36 cm viewscreen or project it onto a surface within 2.4 meters. Similarly they can broadcast sound in a general area or pinpoint sound in a specific location.



Desktop Monitor (2243-2265)

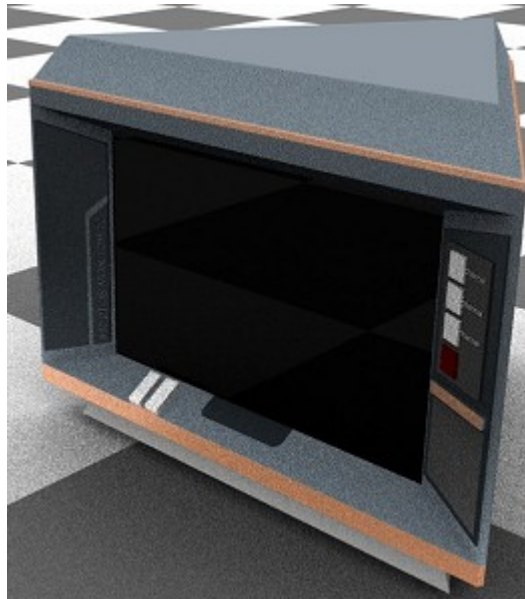

Three-Way Monitor (2243-2265)

**Note:** From 2255-2265 the MARS Viewer were being slowly but steadily removed from starship command chairs, helm, navigation, science and engineering stations on the bridge. Starting 2245 MARS Viewers were also being slowly replaced by the standard desktop monitor in crew quarters and other areas. The three-way monitor was also slowly replacing the large screen monitor in briefing rooms.

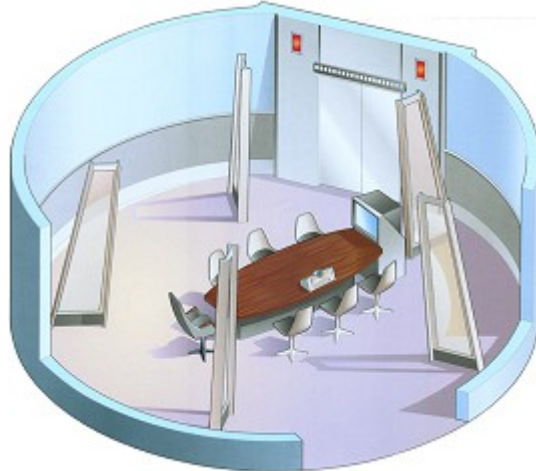

Briefing Room with Briefing Table 2241-2264

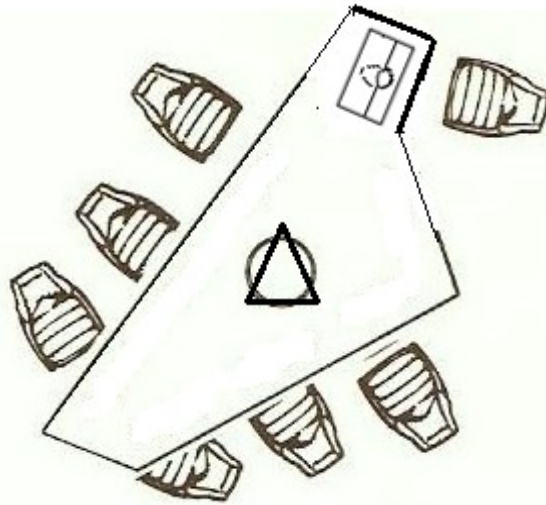

Briefing Room Table variant 2245-2263

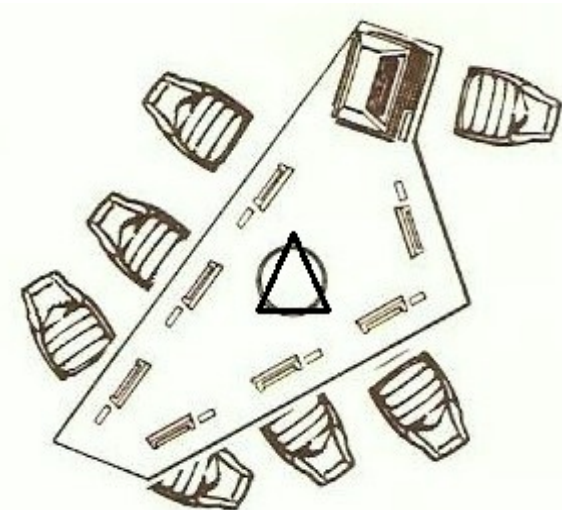

Briefing Room Table variant 2255-2270



**HEAVY SCANNER;** (2245-2277)

Specifications: 28 x 13 x 10 cm; 1 kg

Duration/Energy: With intermittent use a Heavy Scanner can be used roughly 700 hours or just under 30 hours continuous use.

Range: 5/15/150/1000/+0

**Description:** This Heavy Scanner is somewhat gun-shaped, the unit is pointed toward and object to be scanned. The scanner allows a character to ascertain a number of useful pieces of information not normally available. This scanner grants a +4 bonus to related tests when used, be it an Observe test or making a Science (Geology) test to carbon date a section of bedrock. Range modifiers apply as per page 250 of the Player's Guide. The Heavy Scanner can be used in conjunction with an LPE (portable Lab) with the scanner's range and scanning bonus replacing the scanning and recording equipment of the LPE.

**LPE (Landing Party Equipment - Portable Lab); (2245-2254\*)**

Specifications: 33 x 14 x 11 cm Case; 1 kg

Duration/Energy: With intermittent use a LPE (portable lab) can be used roughly 500 hours or just under 20 hours continuous use.

**Description:** An LPE (portable lab) is a rectangular black box-like case with a black shoulder strap. Landing parties who leave the ship for exploratory or investigative purposes were required to take along a variety of computational and scanning/recording equipment. This modular set of equipment can be modified for a variety of scientific uses.

**Rules:** LPE's enhance a character's ability to perform a number of tests (such as Investigate, Observe, and Science). The LPE (portable lab) scanning/recording equipment confers +3 bonus to most skill tests. The scanning equipment can range in overall size from 5 cm to 12 cm. The range for the scanning equipment is limited to 5 meters. LPE (portable lab) can be optimized (see *PG p.175*) but is limited to Science skills. In all other respects an LPE (portable lab) functions like a 23rd century tricorder.

---



**EC ("Electronic Clipboard"); (2245-2254\*)**

Specifications: 35 x 23 x 0.35 cm; 0.1 kg

Duration/Energy: 100 hours.

**Description:** This document holder consists of a thin metal board with a clip (for holding reports) at the top sometimes containing a cover. The electronic clipboard had a lid customised with the Earth-Federation logo and starship's name. "electronic clipboards"



were used on Starfleet ships and facilities for delivering reports. A "electronic clipboard" assists as an input/output device for a E-sheet (*see below*). You must have an e-sheet to use a "electronic clipboard". This clipboard can wirelessly interface with another clipboard or access shipboard library banks to send and/or access data. Although a "electronic clipboard" can store and processes several million characters of information, most specialists use computer terminals for direct access, leaving "electronic clipboards" primarily for yeomen and other administrative personnel. Usually "electronic clipboards" can hold up to two medium size e-sheets (or four small sized or one large size). Like the 23rd century PADD the "electronic clipboard" cannot access a ship's functions.

#### **E-SHEET (2245-2254\*)**

Specifications: Small (20.3 x 12 cm; negligible), Medium (20.3 x 27.94 cm; negligible); Large (27.94 x 40.64 cm; negligible)

Duration/Energy: unlimited (photo-electric)

**Description:** This is a portable computer technology employed through out the Federation. An E-sheet has the look and feel of ordinary paper but it is actually a controllable display surface. It combines the advantages of paper and screen. It's resolution is like a 21st century art book, and can change so quickly that it can display 2D video images in perfect quality. E-sheets have a fine latticework of sensors that it can detect the movement of a stylus. A standard E-sheet (medium size) has limited memory capacity of about one million characters and limited data processing capability. Starfleet procedure dictated that all log entries, sensor readings, and medical information, and other data be stored in the main computers memory, and as a "hard copy" on a medium sized E-sheet. An E-sheet does not necessarily need a "electronic clipboard" to be used. Like the 23rd century PADD a E-sheet cannot access a ship's functions. E-sheets can be "printed" out of a ship's library computer. Usually small sized E-sheets were used for this.

- Small E-sheet memory capacity ~30,000 characters.
- Medium E-sheet memory capacity ~ 1 million characters.
- Large E-sheet memory capacity ~ 1,250,000 characters.

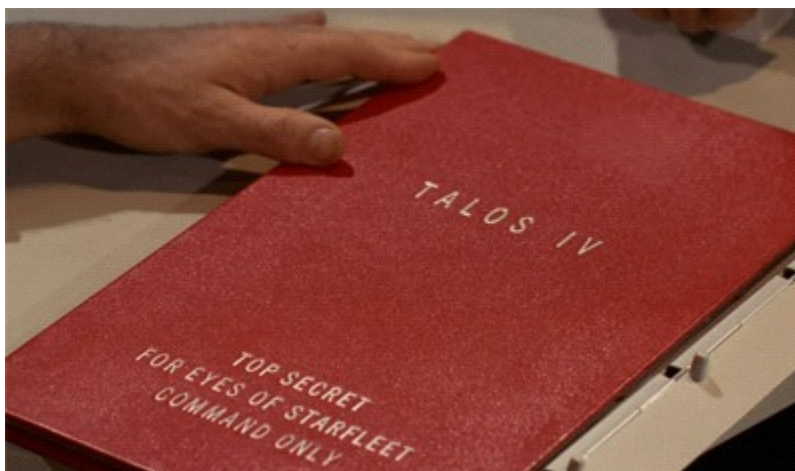

**Note:** Starfleet required that archiving of important documents be done via Smart Book. A Smart Book is a book who's pages are composed of E-sheets. These books have no

*processing power of their own being used for display only. A Smart Book can be linked to a computer.*

*\* The Tricorder, PADD, and Data Card/Data Module that has been the mainstay equipment for Starfleet in the years prior to 2253-2254 seems to be missing.- With the duotronics breakthrough in 2243, Starfleet decided to intergrate duotronics into this equipment. The re-evaluation, redesign and redistribution of these pieces equipment nearly took twelve years to complete. Starfleet in most cases, subsitituted these pieces of equipment with similar equipment such as: the "electronic clipboard", the landing party equipment-portable lab and the E-sheet. Although, not as durable or versatile as the later redesigned equipment, but were deemed by Starfleet to be relaible enough to be used in the interim.*

*From 2243-2254 prototypical equipment such as: the Model SC-445 MARK III Portable Scanner, Model TR-440 MARK I Tricorder, and a more advanced version of the PADD (similar to the PADD out of Star Trek: Enterprise but intergrated with duotronic circuitry), and other pieces of equipment, were being field tested on select ships and facilities during this time.*



**COMMUNICATOR;** (2245-2265)

*Specifications: 13 x 7 x 2.5 cm; 0.2 kg*

*see PG p.172; 23rd century Communicator for rulings*

**Note:** *Somewhat larger and bulkier than the communicator of the late 2260's.*

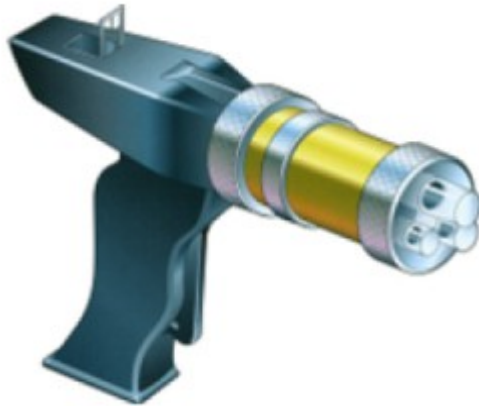

**TYPE 4 PHASE PISTOL** (Model: Marfak 1); (2245-2255)

*Specifications: 24 cm long, 0.72 liters in volume; 0.6 kg*

*Settings: 2,5,6,and 7; capable of overload see PG p.180 for rulings.*

**Note:** There are at least two rotating wheels on the barrel, controlling beam power and intensity. The forward one appears to rotate the whole muzzle assembly, giving a choice of three barrels - the longest one (chosen by rotating in an anti-clockwise direction as you hold it) seems to be the highest setting. The weapon is also capable of being manually overloaded, with a buildup effect similar to that of a phaser overload causing a 'force chamber explosion.' This was seen to be initiated by pulling back the second wheel and rotating it clockwise; the overload is cancelled by snapping the wheel through another quarter-turn - again clockwise.





**MARK 1 PHASER PISTOL** (Model: Atalskes II); (2256-2265)

Specifications: 24 cm long, 0.72 liters in volume; 0.6 kg

Settings: *see PG p.182; 23rd century Phaser II for rulings.*

**Note:** As with the Type 4 phase pistol, there are at least two rotating wheels on the barrel, controlling beam power and intensity. The forward one appears to rotate the whole muzzle assembly, giving a choice of three barrels - the longest one (chosen by rotating in an anti-clockwise direction as you hold it) seems to be the highest power.

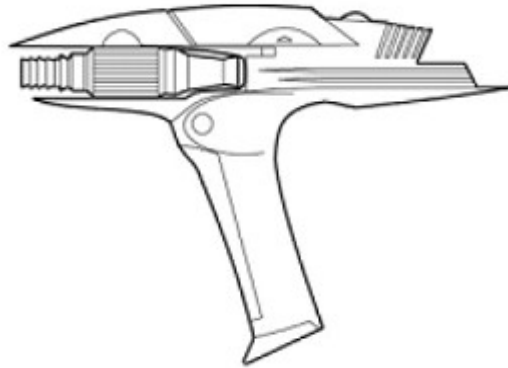

**PROTOTYPE PHASER PISTOL** (Model: Sestra 2-X); (c. 2258)

Specifications: 22 cm long, 0.71 liters in volume; 0.5 kg

Settings: 3 and 7; capable of overload *see PG p.180 for rulings.*

Duration/Energy: 200 charges

Range: 5/20/40/80/+20 meters

**Note:** Uses a dual-barrel firing system which rotates the required barrel forward depending on whether a Stun or Kill setting is required.

---

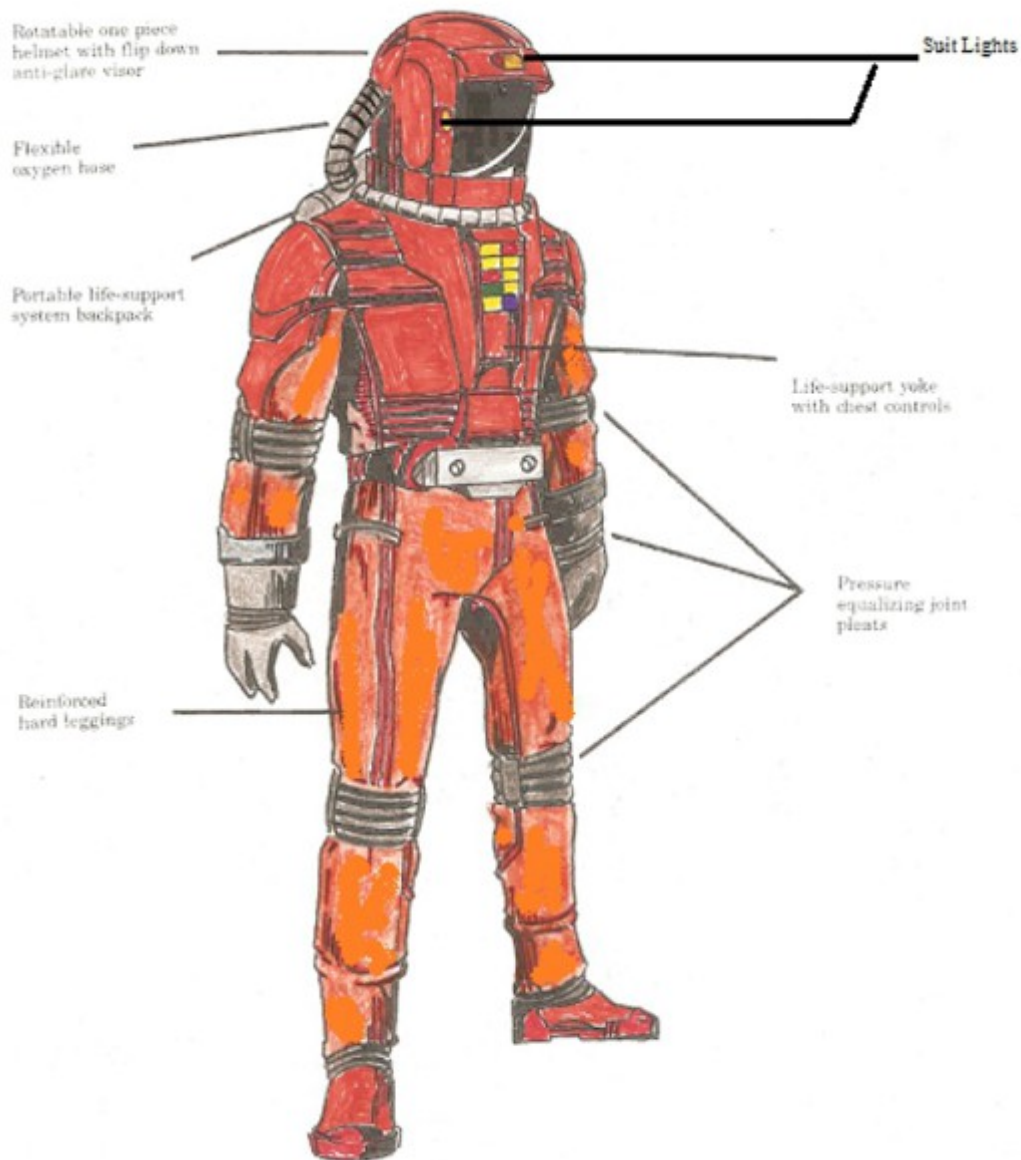

**EVA SUIT;** (2215-2265)

Specifications: Folded approx 15 liters; 9 kg without backpack and full consumables load, 13 kg with them.

**Description:** This suit consists of an orange full-body jumpsuit with removable gloves and helmet, as well as, gravitic boots allowing the user to walk normally on solid surfaces in zero-g. The suit's life support system is housed in the front part of the belt attachment. Using advanced chemical processing this life support system can purify air and recycle drinking water up to 4 hours (12 hours with backpack and full consumables load). Controls mounted on the wrists and belt attachment operate the gravitic boots and the suit's functions, the built-in communicator, and helmet mounted lights. *see PG p.173 for rulings.*



**TRICORDER** (Model TR-455 Mk 2 Type 1 and 2); (2255-2265)  
see PG p.175-176; 23rd century Tricorder for rulings.



**PADD** (2255-2265)

Specifications: 35 x 23 x 0.61 cm; 0.15 kg

Duration/Energy: 100 hours

**Description:** This version of the "Electronic Clipboard" became a PADD (see PG p.174 for rulings) This PADD has a slot for one Data Card.



**DATA CARDS** (aka Microtape, Record Tape, Data Tape); (Introduced: c.2243; came into inventory c.2255)

Specifications: 7 x 7 x 0.6 cm; (data disks are 3 x 3 x 0.5 cm); negligible

Duration/Energy: unlimited

**Description:** Data Cards are the standard recording medium in Starfleet, all communications to and from a starship are recorded on Data Cards, as are the Captain's logs and all sensor readings made by a starship. Even if a starship's computer is destroyed, Data Cards are highly durable and are likely to survive and reveal the fate of the ship. Data Cards are relatively large given the limits of Federation technology. However, the majority of the Data Card is merely an easy-to-handle square, flat casing.

The actual recording medium is a small data disk, identical to those used in both the science and medical tricorders. For ease of use, when a data disk is removed from the tricorder, it is audio/visual recordings, or around 100 million pages of illustrated text. Every viewer and computer work station has several slots for Data Cards. In an effort to improve efficiency and promote Federation unity, all Data Cards within the Federation conform to a uniform standard and maybe used in any computer manufactured in the Federation.

All Data Cards maybe erased and re-recorded multiple times. For security purposes and to prevent loss of important data, new procedure dictates all log entries, sensor readings, medical information, and other important data, be stored in the computers memory and on individual Data Cards.





## OTHER EQUIPMENT

### **MEDICAL KIT (2245-2270)**

Specifications: 30 x 12 x 17 cm case; 1kg

**Description:** This kit, usually carried on a shoulder strap, contains the following:

- Hypospray
- Anabolic Proplaser
- Spray Applicator
- Energy Scalpel
- Medical Scanner
- A supply of the most common drugs

### **ENGINEERING KIT (2245-2270)**

Much like the medical kit, the Engineering Kit contains a variety of basic tools for repairs and maintenance.

- One Covomm Recorder (20 x 15 x 3 cm; 0.6 kg) *Treat as a 22nd century scanner "optimized" for engineering.*
- Two Plasma Torches.
- One Hyperspanner.
- Gravitic Calipers.
- Magnetic Calipers.
- A variety of computer/circuitry "jumpers" and device power cells.





Magnetic Caliper

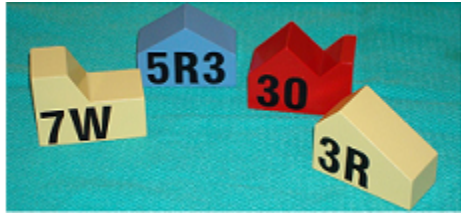

Computer/Circuit "Jumpers"

#### **EQUIPMENT HARNESS (2245-2263)**

Specifications: size varies.

**Description:** The equipment harness is used primarily on landing parties and worn underneath the excursion jacket.

*Other Equipment that was used during the 2250's.*

- *Earpiece Transceiver see Starfleet Operations Manual p.62.*
- *Universal Translator see Starfleet Operations Manual p.62.*
- *Medical Pouch (25 x 8 x 2.5 cm; 0.2 kg) Contains the following: Hypospray, Medical Scanner, Spray Applicator, and a small supply of commonly used drugs.*

EXPERIMENTAL/EMERGENT EQUIPMENT (2243-2255)



TR-440 MARK II Type 1

23<sup>rd</sup> Century Tricorder (Prototype Tricorder); (Model: TR-440 MARK II Type 1)  
(Introduced 2243)

Specifications: 18 x 12 x 5 cm, 0.61 kg  
see PG p.175-176; 23<sup>rd</sup> century Tricorder for rulings.



23<sup>rd</sup> Century Portable Scanner (Model SC-445 Mk. 3) (2245-2254)

**Description:** The portable scanner, precursor to the tricorder, provides enhanced

sensory capabilities to its user. The scanner can detect and analyze electrical, chemical, biological, meteorological, and geological conditions and substances. Scanners can also interface with a ship's computer or other scanners to share information and transfer data.

Specifications: 25.1 x 14.52 x 4.8 cm, 0.6 kg

Duration/Energy: With intermittent use a Scanner can be used roughly 800 hours or just under 29 hours continuous use.

Range: 5/15/150/1000/+0

**Rules:** The scanner allows a character to ascertain a number of useful pieces of information not normally available. Scanners provide a +4 bonus to all related tests when used, be it an Observe test or making a Science (Geology) test to carbon date a section of bedrock.



PADD (Prototype)