

Price quote for: **TRACTORS: SKID STEERS AND OEM ATTACHMENTS**

Vendor Name: **Bobcat Company**  
 Contact Person: **Mike Kotzbacher**  
 Street Address: **250 East Beaton Drive**  
 P.O. Box: **PO Box 6000**  
 City, State, Zip: **West Fargo, ND 58078**  
 Phone #: **701-241-8700**  
 Toll Free #: **800-965-4232**  
 Fax #: **701-280-7860**  
 Email Address: [mike.kotzbacher@doosan.com](mailto:mike.kotzbacher@doosan.com)

Version of Excel used: 2007

<b>PERCENTAGE DISCOUNT PRICING</b>	
1.0	<b>MANUFACTURER</b> Bobcat
2.0	<b>DATE AND ID. OF PRICE LIST</b> Bobcat 7/2/2012
3.0	<b>PERCENTAGE DISCOUNT FROM PRICE LIST</b> 30%
4.0	<b>PRICE FOR SERVICE MANUAL</b> \$100
4.1	<b>PRICE FOR PARTS MANUAL</b> \$100
4.2	<b>PRICE FOR OPERATIONS MANUAL</b> \$100
5.0	<b><u>PERFORMANCE/ WARRANTY OPTIONS</u></b> Use this section to offer performance/warranty options, number these items starting with 5.1, 5.2, etc. <b><u>(Specify years, miles or hours extended term covers.)</u></b>
5.1	
5.2	
6.0	<b><u>NEW EQUIPMENT RENTAL PROGRAM</u></b> If rental programs are available on the new equipment offered, with the option to purchase, list the hourly/weekly/monthly rental rate. Indicate the percent of rental fee paid by the purchaser that will be applied to the purchase price. See Solicitation Special Terms & Conditions.
	<b>Hourly Rental Rate:</b> N/A
	<b>Weekly Rental Rate:</b> N/A
	<b>Monthly Rental Rate:</b> N/A
	<b>Percent (%) of Rental Fee applied to purchase price:</b> N/A
7.0	<b><u>VENDOR OWNED RENTAL RETURN OR DEMO EQUIPMENT PROGRAM</u></b> See Solicitation Special Terms and Conditions. <b><u>DEDUCT</u></b> cost per Used Hour from the original Contract Price N/A
8.0	<b><u>DISCOUNT OFF LIST PRICE FOR RELATED PARTS &amp; ACCESSORIES</u></b> Attachments 24% (See Special Terms and Conditions)
9.0	<b><u>DELIVERY STARTING POINT - City, State, Zip</u></b> FOB Destination (See Special Terms and Conditions - no flat rate allowed.) <b>Price Per Loaded Mile:</b> No Charge
10.0	<b><u>INSTALLATION - PER HOUR (Hourly Shop Rate):</u></b> \$90.00 (Installation services may be requested on an "as needed" basis - see special terms and conditions.)

November 6, 2012  
SLP Pages



MN State Loader Contract #52041  
Expires August 31, 2013

Contract  
Price

Part Number	All Wheel Steer Loader Description	SLP in US\$	Discount Percent	Price
M0187	<b>A770 All Wheel Steer Loader (equipped with iT4 engine)</b>	\$60,301.00	30.0%	\$42,210.70



Part Number	Air Conditioned/Heated Cab Packages Description	SLP in US\$	Discount Percent	Price
M0187-P01-A91	<b>A91 Option Package</b>	\$7,976.00	30.0%	\$5,583.20
M0187-P01-A71	<b>A71 Option Package</b>	\$5,612.00	30.0%	\$3,928.40
M0187-P01-A51	<b>A51 Option Package</b>	\$4,376.00	30.0%	\$3,063.20

**A51**  
Enclosed Cab with AC/Heat  
Cab Accessories Package\*  
Power Bob-Tach  
Sound Reduction  
Deluxe Instrument Panel with Keyless Start  
Attachment Control Kit

**A71**  
Enclosed Cab with AC/Heat  
Cab Accessories Package\*  
Power Bob-Tach  
Sound Reduction  
Deluxe Instrument Panel with Keyless Start  
Attachment Control Kit

**A91**  
Enclosed Cab with AC/Heat  
Cab Accessories Package\*  
Power Bob-Tach  
Sound Reduction  
Deluxe Instrument Panel with Keyless Start  
Attachment Control Kit  
High Flow Hydraulics  
Hydraulic Bucket Positioning  
Engine Block Heater

Part Number	Heated Cab Packages Description	SLP in US\$	Discount Percent	Price
M0187-P01-H71	<b>H71 Option Package</b>	\$4,325.00	30.0%	\$3,027.50

**H71**  
Enclosed Cab with Heat

Cab Accessories Package\*  
 Power Bob-Tach  
 Sound Reduction  
 Deluxe Instrument Panel with Keyless Start  
 Attachment Control Kit

Part Number	Open Cab Packages Description	SLP in US\$	Discount Percent	Price
-------------	-------------------------------	-------------	------------------	-------

M0187-P01-O71	<b>O71 Option Package</b>	<b>\$1,966.00</b>	<b>30.0%</b>	<b>\$1,376.20</b>
---------------	---------------------------	-------------------	--------------	-------------------

**O71**

Cab Accessories Package\*  
 Deluxe Instrument Panel with Keyless Start  
 Power Bob-Tach  
 Attachment Control Kit

*Cab Accessories Package: Deluxe Headliner with Dome Light, Cab Accessory Harness, Power Port, Lower Interior Panels with Storage Compartments and Cup Holder.*

Part Number	Factory Installed Options Description	SLP in US\$	Discount Percent	Price
-------------	---------------------------------------	-------------	------------------	-------

**Tire Options** (Set of 4 Tires in Place of Base Equipment)

M0187-R09-C04	<b>12-16.5, 12 Pr, Bobcat Severe Duty Tires</b>	<b>\$800.00</b>	<b>30.0%</b>	<b>\$560.00</b>
---------------	---	-----------------	--------------	-----------------

Loader width 72.1"

M0187-R09-C05	<b>12-16.5, 12 Pr, Bobcat Severe Duty-Poly Fill Tires</b>	<b>\$1,575.00</b>	<b>30.0%</b>	<b>\$1,102.50</b>
---------------	---	-------------------	--------------	-------------------

Loader width 72.1"

M0187-R09-C06	<b>33 x 15.5-16.5, 12 PR, Bobcat Super Float Tires- Offset Rims</b>	<b>\$840.00</b>	<b>30.0%</b>	<b>\$588.00</b>
---------------	---	-----------------	--------------	-----------------

Loader width 80"

M0187-R09-C12	<b>33 x 15.5-16.5, 12 PR, Turf and Sand Tires</b>	<b>\$885.00</b>	<b>30.0%</b>	<b>\$619.50</b>
---------------	---	-----------------	--------------	-----------------

Loader width 80"

Part Number	Factory Installed Options Description	SLP in US\$	Discount Percent	Price
-------------	---------------------------------------	-------------	------------------	-------

M0187-R05-C12	<b>Air Ride Suspension Seat</b>	<b>\$299.00</b>	<b>30.0%</b>	<b>\$209.30</b>
---------------	---------------------------------	-----------------	--------------	-----------------

Must order a Cab Option Package

M0187-R26-C12	<b>Radio</b>	<b>\$397.00</b>	<b>30.0%</b>	<b>\$277.90</b>
---------------	--------------	-----------------	--------------	-----------------

Must order a Cab Option Package

Includes weatherproof AM/FM/NOAA Weather Band Radio, Speakers, and Antenna.

Works with MP3 or other portable music player.

M0187-R03-C03	<b>High Flow Hydraulics</b>	<b>\$1,828.00</b>	<b>30.0%</b>	<b>\$1,279.60</b>
---------------	-----------------------------	-------------------	--------------	-------------------

Provides 36.5 GPM and 3500 PSI for attachment operation.  
 The Bobcat Ordering systems will automatically add the 7 Pin Attachment Control Kit if the High Flow Hydraulics are ordered. Unless you are ordering an A71, H71 or O71 Cab Package that includes the Attachment Control Kit

<b>M0187-P03-F40</b>	<b>High Flow Hydraulics, Hydraulic Bucket Positioning</b>	<b>\$2,173.00</b>	<b>30.0%</b>	<b>\$1,521.10</b>
<b>M0187-P01-F20</b>	<b>Attachment 7 Pin Control Kit</b>	<b>\$195.00</b>	<b>30.0%</b>	<b>\$136.50</b>
<b>M0187-R11-C02</b>	<b>Hydraulic Bucket Positioning</b>	<b>\$454.00</b>	<b>30.0%</b>	<b>\$317.80</b>
	Bucket Positioning helps the operator to keep the same tilt of the load during lifting. Includes On/Off switch			
<b>M0187-A01-C02</b>	<b>Engine Block Heater</b>	<b>\$108.00</b>	<b>30.0%</b>	<b>\$75.60</b>
<b>M0187-P03-F10</b>	<b>Hydraulic Bucket Positioning, Engine Block Heater</b>	<b>\$536.00</b>	<b>30.0%</b>	<b>\$375.20</b>
<b>M0187-R16-C03</b>	<b>Strobe Light</b>	<b>\$425.00</b>	<b>30.0%</b>	<b>\$297.50</b>
<b>M0187-A03-C05</b>	<b>Port Relief Valve</b>	<b>\$295.00</b>	<b>30.0%</b>	<b>\$206.50</b>
	Recommended when Using a Combination Bucket or Industrial Grapple.			

November 6, 2012  
SLP Pages



MN State Loader Contract #52041  
Expires August 31, 2013

Contract  
Price

Part Number	Angle Brooms Description	SLP in US\$	Discount Percent	Labor	Price
-------------	-----------------------------	-------------	---------------------	-------	-------

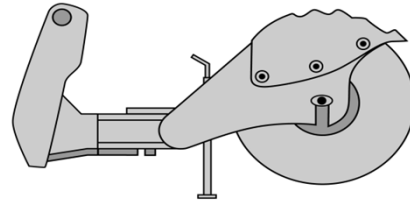

(S70) 6907000	<b>48" Angle Broom</b> (Manual Angle, 3-Positions: 30° Right, Left and Straight)	\$2,976.00	24.0%	\$0.00	\$2,261.76
------------------	---	------------	-------	--------	------------

(S100, S130, S510, S550, S530, S570, S590, S220, S250, S300, S330)  
(S630, S650, S750, S770)

(T110, T140, T550, T590) (A770) (T630, T650, T750, T770) 6905805	<b>68" Angle Broom</b> (Loader must be equipped with an Attachment Control Kit) (When used on loaders equipped with a 14-Pin Attachment Control Kit, a 14-Pin Attachment T-Harness Kit is required)	\$5,538.00	24.0%	\$0.00	\$4,208.88
---	---	------------	-------	--------	------------

(S510, S550, S550H, S530, S530H, S570, S570H, S590, S590H, S220, S250, S300, S330)  
(S630, S650, S750, S770, S850) (A300) (A770)

(T550, T550H, T590, T590H, T250, T300, T320) (T630, T650, T750, T770, T870) 6905806	<b>84" Angle Broom</b> (Loader must be equipped with an Attachment Control Kit) (When used on loaders equipped with a 14-Pin Attachment Control Kit, a 14-Pin Attachment T-Harness Kit is required)	\$6,341.00	24.0%	\$0.00	\$4,819.16
--	---	------------	-------	--------	------------

Part Number	Augers Description	SLP in US\$	Discount Percent	Labor	Price
-------------	-----------------------	-------------	---------------------	-------	-------



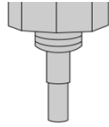

<p>(S70, S100, S130, S510, S550, S530, S570, S590) (T110, T140)  <b>6808799</b></p>	<p><b>Model 10 Auger Drive Unit</b>          (Must also order Mounting Frame and Bit) (Must order mounting frame, light duty bit and swing stop kit when installing on MT50 and MT52)</p>	<p><b>\$1,268.00</b></p>	<p><b>24.0%</b></p>	<p><b>\$0.00</b></p>	<p><b>\$963.68</b></p>
<p>(S100, S130, S510, S550, S530, S570, S590, S220, S250, S300, S330)          (S630*, S650*, S750*, S770*, S850*) (A300) (A770*)          (T110, T140, T550, T590, T250, T300, T320) (T630*, T650*, T750*, T770*, T870*)  <b>6809442</b></p>	<p><b>Model 15C Auger Drive Unit</b>          (Must also order Mounting Frame and Bit)          (Auger drive unit is shipped with a 7/8" round bit retention pin, if used in conjunction with a hex bit a 5/8" Pin Kit P/N 6809733 is required.)</p>	<p><b>\$1,533.00</b></p>	<p><b>24.0%</b></p>	<p><b>\$0.00</b></p>	<p><b>\$1,165.08</b></p>
<p><b>7145345</b></p>	<p><b>Model 15H Hex Shaft Auger Drive Unit</b>          (Must also order Mounting Frame and Bit)</p>	<p><b>\$1,533.00</b></p>	<p><b>24.0%</b></p>	<p><b>\$0.00</b></p>	<p><b>\$1,165.08</b></p>
<p>(S130, S510, S550, S550H, S530, S530H, S570, S570H, S590, S590H, S220, S220H, S250, S250H, S300, S300H, S330, S330H) (S630*, S630H*, S650*, S650H*, S750*, S750H*, S770*, S770H*, S850*, S850H*) (A300, A300H) (A770*, A770H*)          (T140, T550, T550H, T590, T590H, T250, T250H, T300, T300H, T320, T320H)          (T630*, T630H*, T650*, T650H*, T750*, T750H*, T770*, T770H*, T870*, T870H*)  <b>6809445</b></p>	<p><b>Model 30C Auger Drive Unit</b>          (Must also order Mounting Frame and Bit)          (Auger drive unit is shipped with a 7/8" round bit retention pin, if used in conjunction with a hex bit a 5/8" Pin Kit P/N 6809733 is required.)</p>	<p><b>\$2,091.00</b></p>	<p><b>24.0%</b></p>	<p><b>\$0.00</b></p>	<p><b>\$1,589.16</b></p>
<p><b>7138264</b></p>	<p><b>Model 30H Hex Shaft Auger Drive Unit</b>          (Must also order Mounting Frame and Bit)</p>	<p><b>\$2,091.00</b></p>	<p><b>24.0%</b></p>	<p><b>\$0.00</b></p>	<p><b>\$1,589.16</b></p>
<p><b>6812946</b></p>	<p><b>Mounting Frame, 463, S70</b>          (Includes Mounting Hardware)</p>	<p><b>\$403.00</b></p>	<p><b>24.0%</b></p>	<p><b>\$0.00</b></p>	<p><b>\$306.28</b></p>
<p><b>6812980</b></p>	<p><b>S100-S330, S630-S850, A300, A770, T140-T320, T630-T870</b>  <b>Mounting Frame,</b>          (Includes Mounting Hardware)</p>	<p><b>\$368.00</b></p>	<p><b>24.0%</b></p>	<p><b>\$0.00</b></p>	<p><b>\$279.68</b></p>

\*Must also order Bumper Kit p/n 7172609 for M-Series Loaders – S630, S650, S870, T630, T650, T870  
 \*Must also order Swing Stop Kit, PN 6811444 for Mini-Track Loaders.  
 \*Auger Bits are not Included with the Auger Drive Units.

**Auger Drive & Bit Recommendations**

**Model 10 Augers—Recommended bit size 6, 9”, 12”, 15”, 16”, 18”**

**Model 15C and 30C Augers—Recommended bit size 6”, 9”, 12”, 15”, 18”, 24”, 30”, 36”**

**Model 15H and 30H Augers—Recommended bit size 6”, 9”, 12”, 15”, 18”, 24”, 30”, 36”**

**Light Duty, Standard Duty, Heavy Duty and Rock Bits are Available.**

**Auger bit combinations should be used as a guideline. Recommendations are based upon average digging conditions.**

Part Number	Bob-Tach Mounted Backhoe Description	SLP in US\$	Discount Percent	Labor	Price
-------------	--------------------------------------	-------------	------------------	-------	-------

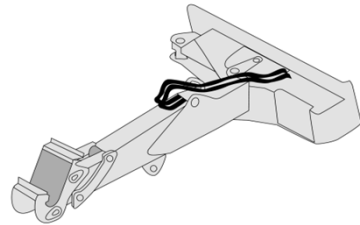

(S510, S550, S530, S570, S590) (T550, T590)

6906767	<b>Bob-Tach Mounted Backhoe</b> (Must also order bucket, see Backhoe Bucket pages) (Loader must be equipped with an Attachment Control Kit) (If installing on loader with 14-Pin Attachment Control, must also order 14-pin Attachment T-Harness P/N 6725383) (Bob-Tach Mounted Backhoe is NOT compatible with Rear Stabilizers)	\$4,641.00	24.0%	\$0.00	\$3,527.16
---------	---	------------	-------	--------	------------

Part Number	Accessories Description	SLP in US\$	Discount Percent	Labor	Price
-------------	-------------------------	-------------	------------------	-------	-------

7104321	<b>Hydraulic Clamp</b> (Includes cylinder, hoses & pins)(Must also order Auxiliary Hydraulic Kit)	\$1,419.00	24.0%	\$270.00	\$1,348.44
---------	--	------------	-------	----------	------------

(Price includes \$270 for installation)

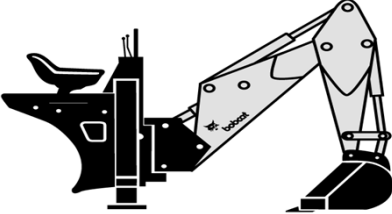
Part Number	Backhoes Description	SLP in US\$	Discount Percent	Labor	Price
					
(S70) <b>6906310</b>	<b>406 Backhoe</b> (Must also order a Bucket) (Mounting Kit included with 406 Backhoe)	<b>\$5,959.00</b>	<b>24.0%</b>	<b>\$0.00</b>	<b>\$4,528.84</b>
(S70, S100) (T110) <b>6906864</b>	<b>506 Backhoe</b> (Must order a Bucket and Mounting Kit)	<b>\$6,146.00</b>	<b>24.0%</b>	<b>\$0.00</b>	<b>\$4,670.96</b>
(S130, S510, S550, S530, S570, S590) (T140, T550, T590) <b>7131524</b>	<b>607 Backhoe</b> (Must also order Bucket and Mounting Kit) (607 Backhoes s/n 1439 & below) will NOT fit on 853 or 863 loaders)	<b>\$8,896.00</b>	<b>24.0%</b>	<b>\$0.00</b>	<b>\$6,760.96</b>
(S130, S510, S550, S530, S570, S590) (T140, T550, T590) <b>7130745</b>	<b>709 Backhoe, with vertical stabilizers</b> (Must also order Bucket and Mounting Kit) (709 Backhoes with vertical stabilizers s/n 299 & below will NOT fit 753L, 763, 773 or 7753; s/n 1199 & below will NOT fit 853 or 863)	<b>\$10,112.00</b>	<b>24.0%</b>	<b>\$0.00</b>	<b>\$7,685.12</b>
<b>7131854</b>	<b>709 Backhoe, with fold down stabilizers</b> (Must also order Bucket and Mounting Kit)	<b>\$11,261.00</b>	<b>30.0%</b>	<b>\$0.00</b>	<b>\$7,882.70</b>
(S220, S250, S300, S330) (S630, S650, S750, S770) (A300) (A770) (T250, T300, T320) (T630, T650, T750, T770) <b>7130772</b>	<b>8811 Backhoe</b> (Must also order Mounting Kit and Bucket)	<b>\$12,050.00</b>	<b>24.0%</b>	<b>\$0.00</b>	<b>\$9,158.00</b>
<b>Note:</b>	<b>Use of Rear Stabilizers is recommended with the 607, 709 and 8811 Backhoes</b> <b>Bolt-on street pads are available thru the local Bobcat Dealership.</b>				

Part Number	Accessories Description	SLP in US\$	Discount Percent	Labor	Price
-------------	-------------------------	-------------	------------------	-------	-------



**Ripper**

6817177	<b>Frost &amp; Rock Ripper</b> (Used on the 709/8811 Backhoes to penetrate and scarify frost or hard ground) (X-Change System required) (Ship Weight 195 lbs.)	\$857.00	24.0%	\$0.00	\$651.32
---------	--	----------	-------	--------	----------

**Packer Wheel**

6806644	<b>Packer Wheel</b> (Use with 607/709/8709/811/8811 Backhoes to compact fill after trenching.) (X-Change System required) (Ship Weight 415 lbs.)	\$1,894.00	24.0%	\$0.00	\$1,439.44
---------	--	------------	-------	--------	------------

**Backhoe Mounting Kits – Current**

6958101	<b>Mounting Kit</b> (506 to 463, S70) (Price includes \$180 for installation)	\$191.00	24.0%	\$180.00	\$325.16
---------	--	----------	-------	----------	----------

7141973	<b>Mounting Kit</b> (506 to S100, T110) (Price includes \$180 for installation)	\$216.00	24.0%	\$180.00	\$344.16
---------	--	----------	-------	----------	----------

7101325	<b>Mounting Kit</b> (607 or 709 to S510, S550 and T550) (Price includes \$180 for installation)	\$427.00	24.0%	\$180.00	\$504.52
---------	--	----------	-------	----------	----------

6718155	<b>Mounting Kit</b> (607 or 709 S/N 2700-00301 & above to 773 G-Series or newer, S530, S570, S590 and T590 and all 709s with Fold Down Stabilizers) (Price includes \$180 for installation)	\$427.00	24.0%	\$180.00	\$504.52
---------	--	----------	-------	----------	----------

7168488	<b>Mounting Kit</b> (8811 to S630, S650, S750, S770, A770, T630, T650, T750, T770) For backhoe s/n A55809999 & below, must also order p/n 7171578) (Must also order Spacer Kit p/n 7168932) (Price includes \$180 for installation)	\$358.00	24.0%	\$180.00	\$452.08
---------	--	----------	-------	----------	----------

7204239	<b>Mounting Kit</b> (8811 to S850 & T870) For backhoe s/n A55810370 & below, must also order p/n 7204238) (Must also order Spacer Kit p/n 7168932) (Price includes \$180 for installation)	\$348.00	24.0%	\$180.00	\$444.48
---------	---	----------	-------	----------	----------

7168932	<b>Bob-Tach Adapter Kit (Spacer)</b> (Required to mount 8811 to S630, S650, S750, S770, A770, T630, T650, T750, T770)	\$535.00	24.0%	\$0.00	\$406.60
---------	--	----------	-------	--------	----------

Part	Backhoe Buckets	SLP in US\$	Discount	Labor	Price
------	-----------------	-------------	----------	-------	-------

Number	Description	Percent			
--------	-------------	---------	--	--	--

**Backhoe Buckets – Current**

**(Bob-Tach Mounted Backhoe X-Change™ Style)**

6735375	13" Trenching Bucket, 3 Bolt-On Teeth	\$483.00	24.0%	\$0.00	\$367.08
6735380	16" Trenching Bucket, 4 Bolt-On Teeth	\$523.00	24.0%	\$0.00	\$397.48
6735395	20" Trenching Bucket, 4 Bolt-On Teeth	\$561.00	24.0%	\$0.00	\$426.36

Note: These buckets are the same buckets as used with the 607 Backhoe and 325 and 328 excavators.

**(406/506 Pin-On Style)**

6715495	9" Trenching Bucket, 2 Bolt-On Teeth	\$402.00	24.0%	\$0.00	\$305.52
6715496	12" Trenching Bucket, 3 Bolt-On Teeth	\$447.00	24.0%	\$0.00	\$339.72
6715497	16" Trenching Bucket, 3 Bolt-On Teeth	\$489.00	24.0%	\$0.00	\$371.64
7109522	18" Trenching Bucket, 4 Bolt-On Teeth	\$504.00	24.0%	\$0.00	\$383.04
6715498	20" Trenching Bucket, 4 bolt-on teeth	\$510.00	24.0%	\$0.00	\$387.60

Note: These buckets are the same buckets used with 322 excavator.

**(607 X-Change™ Style)**

6735375	13" Trenching Bucket, 3 Bolt-On Teeth	\$483.00	24.0%	\$0.00	\$367.08
6735380	16" Trenching Bucket, 4 Bolt-On Teeth	\$523.00	24.0%	\$0.00	\$397.48
6735395	20" Trenching Bucket, 4 Bolt-On Teeth	\$561.00	24.0%	\$0.00	\$426.36
6735399	24" Trenching Bucket, 5 Bolt-On Teeth	\$593.00	24.0%	\$0.00	\$450.68

Note: These buckets are the same buckets used with 325, 328 excavators.

**(709, 8811 X-Change™ Style)**

6735414	13" Trenching Bucket, 3 Bolt-On Teeth	\$582.00	24.0%	\$0.00	\$442.32
6735418	16" Trenching Bucket, 4 Bolt-On Teeth	\$619.00	24.0%	\$0.00	\$470.44
6735422	18" Trenching Bucket, 4 Bolt-On Teeth	\$653.00	24.0%	\$0.00	\$496.28
6735426	20" Trenching Bucket, 4 Bolt-On Teeth	\$652.00	24.0%	\$0.00	\$495.52
6735429	24" Trenching Bucket, 5 Bolt-On Teeth	\$698.00	24.0%	\$0.00	\$530.48
6735433	30" Trenching Bucket, 5 Bolt-On Teeth	\$797.00	24.0%	\$0.00	\$605.72
6735437	36" Trenching Bucket, 6 Bolt-On Teeth	\$877.00	24.0%	\$0.00	\$666.52

( 8811 only)

6735443	39" Grading Bucket, No Teeth	\$978.00	24.0%	\$0.00	\$743.28
---------	------------------------------	----------	-------	--------	----------

(8811 only)

Note: These buckets are the same buckets used with 331, 331E and 334 excavators.

Part Number	Boring Unit Description	SLP in US\$	Discount Percent	Labor	Price
-------------	-------------------------	-------------	------------------	-------	-------

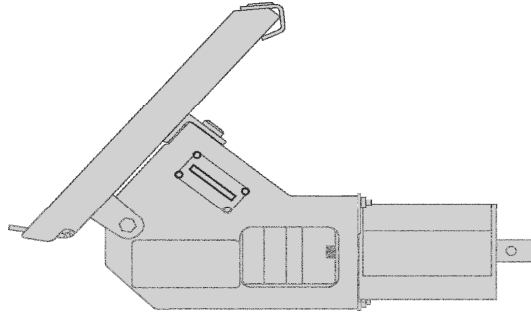

(463, S70) 7110098	<b>Boring Unit</b> (Includes drive unit and guide tool)	\$2,075.00	24.0%	\$0.00	\$1,577.00
-----------------------	--	------------	-------	--------	------------

Part Number	Box Blade Description	SLP in US\$	Discount Percent	Labor	Price
-------------	-----------------------	-------------	------------------	-------	-------

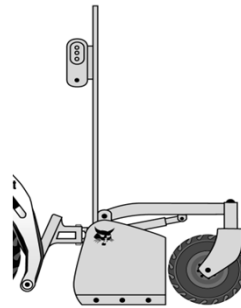
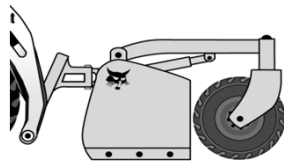

Box Blade with Laser Receiver

(S510, S550, S530, S570, S590, S220, S250, S300, S330) (S630, S650, S750, S770) (A300) (A770) (T140, T550, T590) (T630, T650) 6906574	<b>84" Box Blade</b> (Used for rough grading and landscaping)	\$4,061.00	24.0%	\$0.00	\$3,086.36
---	--	------------	-------	--------	------------

(S510, S550, S530, S570, S590, S220, S250, S300, S330) (S630, S650, S750, S770) (A300) (A770)(T140, T550, T590) (T630, T650) 6906676	<b>84" Box Blade With Laser Mounting</b> (Must also order receiver p/n 7160486) (Approved for use only on BICS loaders.) (Includes integrated laser control)	\$6,272.00	24.0%	\$0.00	\$4,766.72
--	--	------------	-------	--------	------------

(May also need laser transmitter and tripod—unless customer has this equipment.)  
 (The laser receiver will work with most rotating laser beacons)  
 (Loader must be equipped with an Attachment Control Kit)  
 (If installing on loader with 14-Pin Attachment Control, must also order 14-Pin Attachment T-Harness P/N 7164095)

Part Number	Accessories Description	SLP in US\$	Discount Percent	Labor	Price
6680073	<b>Laser Transmitter, Dual Slope</b> (Trimble GL722)	\$7,717.00	24.0%	\$0.00	\$5,864.92
6697973	<b>Laser Transmitter, Dual Slope</b> (Trimble GL422; includes CR600 receiver)	\$3,564.00	24.0%	\$0.00	\$2,708.64
6697972	<b>Laser Transmitter, Single Slope</b> (Trimble GL412)	\$2,590.00	24.0%	\$0.00	\$1,968.40
6688806	<b>Tripod</b>	\$238.00	24.0%	\$0.00	\$180.88
6958471	<b>Laser Kit</b> (Must also order laser receiver p/n 7160486) (Approved for use only on BICS loaders.) (Must also order laser transmitter and tripod) (Upgrades non-laser box blade serial number 657400101 & above to a laser box blade.) (Kit includes laser pole, hydraulic valve, mounting hardware & wiring.) (Loader must be equipped with an Attachment Control Kit) (If installing on loader with 14-Pin Attachment Control, must also order 14-Pin Attachment T-Harness P/N 7164095) (Ship Weight 90 lbs.) <i>(Price includes \$225 for installation)</i>	\$2,588.00	24.0%	\$225.00	\$2,191.88
7160486	<b>Laser Receiver, BLR2</b> (For use with Laser Box Blade S/N 657500370 and above). (May also need a laser transmitter and tripod—unless customer has this equipment.) (The laser receivers will work with most rotating laser transmitters.) (Must order 1 for use with laser kit)	\$1,941.00	24.0%	\$0.00	\$1,475.16

Part Number	Breaker, Hydraulic Description	SLP in US\$	Discount Percent	Labor	Price
-------------	--------------------------------	-------------	------------------	-------	-------





<b>(463, S70, 553)</b>					
<b>7113419</b>	<b>HB680 Breaker</b>	<b>\$4,714.00</b>	<b>24.0%</b>	<b>\$0.00</b>	<b>\$3,582.64</b>
	(Includes Nail Point, fixing cap bolts, cradle, isolation mount, gauge tool, retainer clip and hose protector) (Must also order Loader Mounting Frame and Hose Kit)				
	(Special Applications Kit must be used when operating a Hydraulic Breaker)				
	(When installing on MT50, must also order Shutdown Kit, p/n 6735945)				

**Mounting Frames –HB680**

<b>7113736</b>	<b>Loader Mounting Frame</b>	<b>\$672.00</b>	<b>24.0%</b>	<b>\$0.00</b>	<b>\$510.72</b>
	(Must also order a hose kit, P/N 6727411)				
<b>7150181</b>	<b>Loader X-Change Mounting Frame</b>	<b>\$904.00</b>	<b>24.0%</b>	<b>\$0.00</b>	<b>\$687.04</b>
	(Uses X-Change pin-through design) (Must also order Breaker X-Change Mounting Cap p/n 7113656. This allows breaker with X-Change Mounting Cap to be installed on loader)				
	(Must also order a hose kit, P/N 6727411)				
<b>7113656</b>	<b>X-Change Mounting Cap</b>	<b>\$411.00</b>	<b>24.0%</b>	<b>\$0.00</b>	<b>\$312.36</b>

**Accessories – HB680**

<b>6727411</b>	<b>Hose Kit</b>	<b>\$193.00</b>	<b>24.0%</b>	<b>\$0.00</b>	<b>\$146.68</b>
	(Includes hoses and quick couplers)				

<b>Part Number</b>	<b>HB880 Breaker Description</b>	<b>SLP in US\$</b>	<b>Discount Percent</b>	<b>Labor</b>	<b>Price</b>
--------------------	----------------------------------	--------------------	-------------------------	--------------	--------------

<b>(553, S100, S130, S510, S550, S530, S570, S590) (T110, T140, T550, T590)</b>					
<b>7113420</b>	<b>HB880 Breaker</b>	<b>\$6,675.00</b>	<b>24.0%</b>	<b>\$0.00</b>	<b>\$5,073.00</b>
	(Includes Nail Point, flow control valve, fixing cap bolts, cradle, isolation mount, gauge tool, retainer clip and hose protector) (Must also order Loader Mounting Frame and Hose Kit)				
	(Special Applications Kit must be used when operating a Hydraulic Breaker)				

**Mounting Frame – HB880**

<b>7113737</b>	<b>Loader Mounting Frame</b>	<b>\$711.00</b>	<b>24.0%</b>	<b>\$0.00</b>	<b>\$540.36</b>
	(Breaker mounting frame allows for breaking horizontal or vertical surfaces.)				
	(Must also order a hose kit, P/N 7114764)				
<b>7113738</b>	<b>Horizontal Loader Mounting Frame</b>	<b>\$711.00</b>	<b>24.0%</b>	<b>\$0.00</b>	<b>\$540.36</b>
	(Recommended mounting frame for horizontal surface breaking only)				
	(Must also order a hose kit, P/N 7114764)				

7141800	<b>Loader X-Change Mounting Frame</b> Allows breaker with X-Change Mounting Cap to be installed on loader, breaker can then be used on excavator and loader. Uses X-Change pin-through design. (Breaker mounting frame allows for breaking horizontal or vertical surfaces) (Must also order Breaker X-Change Mounting Cap P/N 7113657) (Must also order a hose kit, P/N 7114764)	\$975.00	24.0%	\$0.00	\$741.00
---------	---	----------	-------	--------	----------

7113657	<b>X-Change Mounting Cap</b>	\$411.00	24.0%	\$0.00	\$312.36
---------	------------------------------	----------	-------	--------	----------

**Accessories – HB880**

7114764	<b>Hose Kit</b> (Ship Weight 20 lbs.)	\$193.00	24.0%	\$0.00	\$146.68
---------	--	----------	-------	--------	----------

Part Number	HB980 Breaker Description	SLP in US\$	Discount Percent	Labor	Price
-------------	---------------------------	-------------	------------------	-------	-------

(S100, S130, S510, S550, S530, S570, S590, S220, S250, S300, S330)  
(S630\*, S650\*, S750\*, S770\*)(A300) (A770\*)  
(T110, T140, T550, T590, T250, T300, T320) (T630\*, T650\*, T750\*, T770\*)

7113421	<b>HB980 Breaker</b> (Includes Nail Point, flow control valve, fixing cap bolts, cradle, isolation mount, gauge tool, retainer clip and hose protector) (Must also order Loader Mounting Frame and Hose Kit) (Special Applications Kit must be used when operating a Hydraulic Breaker) <b>*Must also order Flow Control Valve Kit, for M-Series p/n 7177744</b>	\$8,358.00	24.0%	\$0.00	\$6,352.08
---------	--	------------	-------	--------	------------

**Mounting Frame –HB980**

7113737	<b>Loader Mounting Frame</b> (Breaker mounting frame allows for breaking horizontal or vertical surfaces.) (Must also order a hose kit, P/N 7114764)	\$711.00	24.0%	\$0.00	\$540.36
---------	--	----------	-------	--------	----------

7113738	<b>Horizontal Loader Mounting Frame</b> (Recommended mounting frame for horizontal surface breaking only) (Must also order a hose kit, P/N 7114764)	\$711.00	24.0%	\$0.00	\$540.36
---------	---	----------	-------	--------	----------

7141800	<b>Loader X-Change Mounting Frame</b> Allows breaker with X-Change Mounting Cap to be installed on loader, breaker can then be used on excavator and loader. Uses X-Change pin-through design. (Breaker mounting frame allows for breaking horizontal or vertical surfaces) (Must also order Breaker X-Change Mounting Cap P/N 7113657) (Must also order a hose kit, P/N 7114764)	\$975.00	24.0%	\$0.00	\$741.00
---------	---	----------	-------	--------	----------

7113657	<b>X-Change Mounting Cap</b>	\$411.00	24.0%	\$0.00	\$312.36
---------	------------------------------	----------	-------	--------	----------

Accessories –HB980

7114764	Hose Kit	\$193.00	24.0%	\$0.00	\$146.68
---------	----------	----------	-------	--------	----------

Part Number	HB1180 Breaker Description	SLP in US\$	Discount Percent	Labor	Price
-------------	----------------------------	-------------	------------------	-------	-------

(S220, S250, S300, S330) (S630, S650, S750, S770, S850) (A300) (A770) (T250, T300, T320) (T630, T650, T750, T770, T870)

7115923	<b>HB1180 Breaker</b> (Includes Nail Point, fixing cap bolts, cradle, isolation mount, gauge tool, retainer clip and hose protector) (Must also order Loader Mounting Frame and Hose Kit) (Special Applications Kit must be used when operating a Hydraulic Breaker)	\$10,994.00	24.0%	\$0.00	\$8,355.44
---------	--	-------------	-------	--------	------------

Mounting Frame –HB1180

7115937	<b>Loader Mounting Frame</b> (Breaker mounting frame allows for breaking horizontal or vertical surfaces.) (Must also order a hose kit, P/N 7114764)	\$813.00	24.0%	\$0.00	\$617.88
---------	--	----------	-------	--------	----------

7141800	<b>Loader X-Change Mounting Frame</b> Allows breaker with X-Change Mounting Cap to be installed on loader, breaker can then be used on excavator and loader. Uses X-Change pin-through design. (Breaker mounting frame allows for breaking horizontal or vertical surfaces) (Must also order Breaker X-Change Mounting Cap P/N 7117325) (Must also order a hose kit, P/N 7114764)	\$975.00	24.0%	\$0.00	\$741.00
---------	---	----------	-------	--------	----------

7117325	<b>X-Change Mounting Cap</b>	\$555.00	24.0%	\$0.00	\$421.80
---------	------------------------------	----------	-------	--------	----------

Accessories –HB1180

7114764	Hose Kit	\$193.00	24.0%	\$0.00	\$146.68
---------	----------	----------	-------	--------	----------

Part Number	HB1380 Breaker Description	SLP in US\$	Discount Percent	Labor	Price
-------------	----------------------------	-------------	------------------	-------	-------

(S220, S250, S300, S330) (S750, S770, S850) (A300) (A770) (T250, T300, T320) (T750, T770, T870)

7157576	<b>HB1380 Breaker</b> (Includes Nail Point, fixing cap bolts, cradle, isolation mount, gauge tool, retainer clip and hose protector) (Must also order Loader Mounting Frame and Hose Kit) (Special Applications Kit must be used when operating a Hydraulic Breaker)	\$13,640.00	24.0%	\$0.00	\$10,366.40
---------	--	-------------	-------	--------	-------------

**Mounting Frame –HB1380**

<b>7115937</b>	<b>Loader Mounting Frame</b> (Breaker mounting frame allows for breaking horizontal or vertical surfaces.) (Must also order a hose kit, P/N 7114764)	<b>\$813.00</b>	<b>24.0%</b>	<b>\$0.00</b>	<b>\$617.88</b>
----------------	--	-----------------	--------------	---------------	-----------------

**Accessories – HB1380**

<b>7114764</b>	<b>Hose Kit</b>	<b>\$193.00</b>	<b>24.0%</b>	<b>\$0.00</b>	<b>\$146.68</b>
----------------	-----------------	-----------------	--------------	---------------	-----------------

<b>Part Number</b>	<b>HB2380 Breaker Description</b>	<b>SLP in US\$</b>	<b>Discount Percent</b>	<b>Labor</b>	<b>Price</b>
--------------------	-----------------------------------	--------------------	-------------------------	--------------	--------------

<b>(S220, S250, S300, S330) (S750, S770, S850) (A300) (A770) (T250, T300, T320) (T750, T770, T870)</b>					
<b>7133203</b>	<b>HB2380 Breaker</b> (Includes Nail Point, fixing cap bolts, cradle, isolation mount, and hose protector) (Must also order Loader Mounting Frame and Hose Kit) (Special Applications Kit must be used when operating a Hydraulic Breaker)	<b>\$16,765.00</b>	<b>24.0%</b>	<b>\$0.00</b>	<b>\$12,741.40</b>

**Mounting Frames –HB2380**

<b>7115937</b>	<b>Loader Mounting Frame</b> (Breaker mounting frame allows for breaking horizontal or vertical surfaces.) (Must also order a hose kit, P/N 7114764)	<b>\$813.00</b>	<b>24.0%</b>	<b>\$0.00</b>	<b>\$617.88</b>
----------------	--	-----------------	--------------	---------------	-----------------

**Accessories – HB2380**

<b>7141851</b>	<b>Auto-Grease Kit</b>	<b>\$1,847.00</b>	<b>24.0%</b>	<b>\$0.00</b>	<b>\$1,403.72</b>
----------------	------------------------	-------------------	--------------	---------------	-------------------



7114764	Hose Kit	\$193.00	24.0%	\$0.00	\$146.68
---------	----------	----------	-------	--------	----------

Part Number	Brush Saw Description	SLP in US\$	Discount Percent	Labor	Price
-------------	-----------------------	-------------	------------------	-------	-------

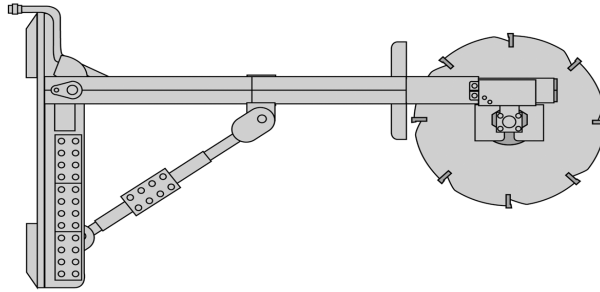

(S100, S130, S510, S550, S530, S570, S590, S220, S250, S300, S330)  
 (S630, S650, S750, S770, S850) (A300) (A770)  
 (T110, T140, T550, T590, T250, T300, T320) (T630, T650, T750, T770, T870)

7121030	<b>Brush Saw</b> (Special Applications kit must be installed on loader when operating Brush Saw)	\$6,216.00	24.0%	\$0.00	\$4,724.16
---------	---	------------	-------	--------	------------

Part Number	Bruschcat Rotary Cutter Description	SLP in US\$	Discount Percent	Labor	Price
-------------	-------------------------------------	-------------	------------------	-------	-------

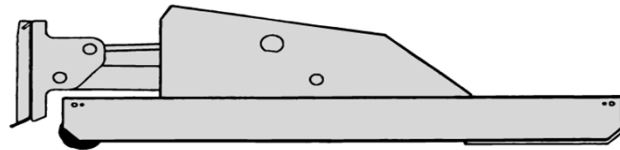

(S510, S550, S530, S570, S590, S220, S250, S300, S330) (S630, S650, S750, S770)  
 (A300) (A770) (T550, T590, T250, T300, T320) (T630, T650)

7114295	<b>60" Brushcat Rotary Cutter, Standard Flow</b> (Comes standard with 3" Offset Blades and Front Wheels) (Cutting height of 2")	\$5,656.00	24.0%	\$0.00	\$4,298.56
---------	--	------------	-------	--------	------------

(S550H, S530H, S570H, S590H, S220, S250, S300, S330) (S630H, S650H, S750, S770)  
 (A300) (A770) (T550H, T590H, T250, T300, T320) (T630H, T650H)

7114296	<b>60" Brushcat Rotary Cutter, High Flow</b> *Not approved for use with 37 GPM High Flow Loaders (Comes standard with 3" Offset Blades and Front Wheels) (Cutting height of 2")	\$5,757.00	24.0%	\$0.00	\$4,375.32
---------	---	------------	-------	--------	------------

(S530, S570, S590, S220, S250, S300, S330) (S630, S650, S750, S770) (A300) (A770)  
 (T550, T590, T250, T300, T320) (T630, T650, T750, T770)

7112209      **72" Brushcat Rotary Cutter, Standard Flow**      \$5,965.00      24.0%      \$0.00      \$4,533.40  
 (Comes standard with 3" Offset Blades and Front Wheels) (Cutting height of 2")

(S530H, S570H, S590H, S220, S220H\*, S250, S250H\*, S300, S300H\*) (A300, A300H\*) (A770)  
 (S630H, S650H, S750, S770) (T550H, T590H, T250, T250H\*, T300, T300H\*, T320, T320H)  
 (T630H, T650H, T750, T770)

7114303      **72" Brushcat Rotary Cutter, High Flow**      \$6,093.00      24.0%      \$0.00      \$4,630.68  
                  **\*Not approved for use with 37 GPM High Flow Loaders**  
 (Comes standard with 3" Offset Blades and Front Wheels) (Cutting height of 2")

(S220H, S250H, S300H, S330H) (S750H, S770H) (A300H) (A770H)  
 (T250H, T300H, T320H) (T750H, T770H)

7114304      **72" Brushcat Rotary Cutter, High Flow**      \$6,585.00      24.0%      \$0.00      \$5,004.60  
                  **For use with 37 GPM High Flow Loaders**  
 (Comes standard with 3" Offset Blades and Front Wheels) (Cutting height of 2")

Part Number	Buckets Description	SLP in US\$	Discount Percent	Labor	Price
-------------	---------------------	-------------	------------------	-------	-------

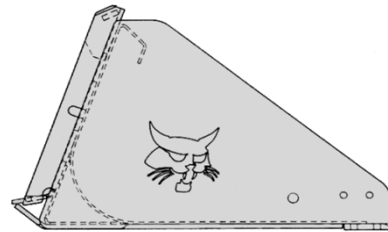

(S70)

7117432	36" Dirt Bucket ♦	\$508.00	24.0%	\$0.00	\$386.08
7117433	44" Dirt Bucket ♦	\$543.00	24.0%	\$0.00	\$412.68
7114488	36" General Purpose Bucket ♦	\$560.00	24.0%	\$0.00	\$425.60
7114581	44" General Purpose Bucket ♦	\$588.00	24.0%	\$0.00	\$446.88
7114583	50" General Purpose Bucket ♦	\$617.00	24.0%	\$0.00	\$468.92

(S100)

7160274	50" Constr./Ind. Bucket ♦	\$890.00	24.0%	\$0.00	\$676.40
7117434	50" Dirt Bucket ♦	\$572.00	24.0%	\$0.00	\$434.72
7114582	50" General Purpose Bucket ♦	\$618.00	24.0%	\$0.00	\$469.68
7161031	50" Low Profile Bucket ♦	\$901.00	24.0%	\$0.00	\$684.76
7114584	56" General Purpose Bucket ♦	\$678.00	24.0%	\$0.00	\$515.28

(T110)

7160274	50" Constr./Ind. Bucket ♦	\$890.00	24.0%	\$0.00	\$676.40
7161031	50" Low Profile Bucket ♦	\$901.00	24.0%	\$0.00	\$684.76

**D** Buckets have holes predrilled to accept bolt-on cutting edges.

♦ Buckets have holes predrilled to accept bolt-on cutting edges or bolt-on teeth.

(S130)

6737399	56" Constr./Ind. Bucket ♦	\$922.00	24.0%	\$0.00	\$700.72
6731403	62" Constr./Ind. Bucket ♦	\$839.00	24.0%	\$0.00	\$637.64
6557599	54" Fertilizer & Grain Bucket D	\$805.00	24.0%	\$0.00	\$611.80
6558681	60" Fertilizer & Grain Bucket D	\$826.00	24.0%	\$0.00	\$627.76
7114584	56" General Purpose Bucket ♦	\$678.00	24.0%	\$0.00	\$515.28
7114585	62" General Purpose Bucket ♦	\$716.00	24.0%	\$0.00	\$544.16
7114586	68" General Purpose Bucket ♦	\$733.00	24.0%	\$0.00	\$557.08
7114587	74" General Purpose Bucket ♦	\$780.00	24.0%	\$0.00	\$592.80
7101903	56" Low Profile Bucket ♦	\$933.00	24.0%	\$0.00	\$709.08
6731415	62" Low Profile Bucket ♦	\$853.00	24.0%	\$0.00	\$648.28
7184103	68" Snow & Light Material Bucket D	\$1,098.00	24.0%	\$0.00	\$834.48
7184105	74" Snow & Light Material Bucket D	\$1,162.00	24.0%	\$0.00	\$883.12

(S510, S550, S530, S570, S590)

6731403	62" Constr./Ind. Bucket ♦	\$839.00	24.0%	\$0.00	\$637.64
6731406	68" Constr./Ind. Bucket ♦	\$950.00	24.0%	\$0.00	\$722.00
7124426	68" Constr./Ind. Heavy Duty Bucket ♦	\$1,360.00	24.0%	\$0.00	\$1,033.60
	(S530, S570, S590 only) Recommended for severe-duty use (Not approved for use with the 55" Farm Grapple P/N 7176977)				
6731409	74" Constr./Ind. Bucket ♦	\$1,030.00	24.0%	\$0.00	\$782.80
6558681	60" Fertilizer & Grain Bucket D	\$826.00	24.0%	\$0.00	\$627.76
6706479	66" Fertilizer & Grain Bucket D	\$1,071.00	24.0%	\$0.00	\$813.96
7114585	62" General Purpose Bucket ♦	\$716.00	24.0%	\$0.00	\$544.16
	(S510, S550, S530, S570 only)				
7114586	68" General Purpose Bucket ♦	\$733.00	24.0%	\$0.00	\$557.08
	(S510, S550, S530, S570 only)				
7114587	74" General Purpose Bucket ♦	\$780.00	24.0%	\$0.00	\$592.80
	(S510, S550, S530, S570 only)				
6731415	62" Low Profile Bucket ♦	\$853.00	24.0%	\$0.00	\$648.28
6731418	68" Low Profile Bucket ♦	\$963.00	24.0%	\$0.00	\$731.88
6731421	74" Low Profile Bucket ♦	\$1,043.00	24.0%	\$0.00	\$792.68
7184103	68" Snow & Light Material Bucket D	\$1,098.00	24.0%	\$0.00	\$834.48
7184105	74" Snow & Light Material Bucket D	\$1,162.00	24.0%	\$0.00	\$883.12

7184110	<b>80" Snow &amp; Light Material Bucket D</b>	<b>\$1,274.00</b>	<b>24.0%</b>	<b>\$0.00</b>	<b>\$968.24</b>
7184098	<b>88" Snow &amp; Light Material Bucket D</b> (S530, S570, S590 only)	<b>\$1,359.00</b>	<b>24.0%</b>	<b>\$0.00</b>	<b>\$1,032.84</b>

**D Buckets have holes predrilled to accept bolt-on cutting edges.**

**◆ Buckets have holes predrilled to accept bolt-on cutting edges or bolt-on teeth.**

<b>(S630, S650)</b>					
6731406	<b>68" Constr./Ind. Bucket ◆</b> (For use with offset rims only)	<b>\$950.00</b>	<b>24.0%</b>	<b>\$0.00</b>	<b>\$722.00</b>
7124426	<b>68" Constr./Ind. Heavy Duty Bucket ◆</b> (S530, S570, S590 only) Recommended for severe-duty use (Not approved for use with the 55" Farm Grapple P/N 7176977)	<b>\$1,360.00</b>	<b>24.0%</b>	<b>\$0.00</b>	<b>\$1,033.60</b>
6731409	<b>74" Constr./Ind. Bucket ◆</b>	<b>\$1,030.00</b>	<b>24.0%</b>	<b>\$0.00</b>	<b>\$782.80</b>
6732305	<b>74" Constr./Ind. Heavy Duty Bucket ◆</b> (Recommended for severe-duty use) (Not approved for use with the 55" Farm Grapple, P/N 7176977)	<b>\$1,412.00</b>	<b>24.0%</b>	<b>\$0.00</b>	<b>\$1,073.12</b>
6731412	<b>80" Constr./Ind. Bucket ◆</b>	<b>\$1,121.00</b>	<b>24.0%</b>	<b>\$0.00</b>	<b>\$851.96</b>
6726344	<b>80" Constr./Ind. Heavy Duty Bucket ◆</b> (Recommended for severe-duty use) (Not approved for use with the 55" Farm Grapple, P/N 7176977)	<b>\$1,519.00</b>	<b>24.0%</b>	<b>\$0.00</b>	<b>\$1,154.44</b>
7125917	<b>84" Constr./Ind. Heavy Duty Bucket ◆</b> (For use with S650 only) (Recommended for severe-duty use) (Not approved for use with the 55" Farm Grapple, P/N 7176977)	<b>\$1,593.00</b>	<b>24.0%</b>	<b>\$0.00</b>	<b>\$1,210.68</b>
6706479	<b>66" Fertilizer &amp; Grain Bucket D</b> (For use with offset rims only)	<b>\$1,071.00</b>	<b>24.0%</b>	<b>\$0.00</b>	<b>\$813.96</b>
6706483	<b>72" Fertilizer &amp; Grain Bucket D</b>	<b>\$1,183.00</b>	<b>24.0%</b>	<b>\$0.00</b>	<b>\$899.08</b>
6731418	<b>68" Low Profile Bucket ◆</b> (For use with offset rims only)	<b>\$963.00</b>	<b>24.0%</b>	<b>\$0.00</b>	<b>\$731.88</b>
6731421	<b>74" Low Profile Bucket ◆</b>	<b>\$1,043.00</b>	<b>24.0%</b>	<b>\$0.00</b>	<b>\$792.68</b>
6731424	<b>80" Low Profile Bucket ◆</b>	<b>\$1,136.00</b>	<b>24.0%</b>	<b>\$0.00</b>	<b>\$863.36</b>
7184103	<b>68" Snow &amp; Light Material Bucket D</b> (For use with offset rims only)	<b>\$1,098.00</b>	<b>24.0%</b>	<b>\$0.00</b>	<b>\$834.48</b>
7184105	<b>74" Snow &amp; Light Material Bucket D</b>	<b>\$1,162.00</b>	<b>24.0%</b>	<b>\$0.00</b>	<b>\$883.12</b>
7184110	<b>80" Snow &amp; Light Material Bucket D</b>	<b>\$1,274.00</b>	<b>24.0%</b>	<b>\$0.00</b>	<b>\$968.24</b>
7184098	<b>88" Snow &amp; Light Material Bucket D</b>	<b>\$1,359.00</b>	<b>24.0%</b>	<b>\$0.00</b>	<b>\$1,032.84</b>

<b>(S750, S770)</b>					
6731406	<b>68" Constr./Ind. Bucket ◆</b> (For use with offset rims only)	<b>\$950.00</b>	<b>24.0%</b>	<b>\$0.00</b>	<b>\$722.00</b>

7124426	<b>68" Constr./Ind. Heavy Duty Bucket ♦</b> (S530, S570, S590 only) Recommended for severe-duty use (Not approved for use with the 55" Farm Grapple P/N 7176977)	\$1,360.00	24.0%	\$0.00	\$1,033.60
6731409	<b>74" Constr./Ind. Bucket ♦</b>	\$1,030.00	24.0%	\$0.00	\$782.80
6732305	<b>74" Constr./Ind. Heavy Duty Bucket ♦</b> (Not approved for use with the 55" Farm Grapple, P/N 7176977)	\$1,412.00	24.0%	\$0.00	\$1,073.12
6731412	<b>80" Constr./Ind. Bucket ♦</b>	\$1,121.00	24.0%	\$0.00	\$851.96
6726344	<b>80" Constr./Ind. Heavy Duty Bucket ♦</b> (Not approved for use with the 55" Farm Grapple, P/N 7176977)	\$1,519.00	24.0%	\$0.00	\$1,154.44
7125917	<b>84" Constr./Ind. Heavy Duty Bucket ♦</b> (Not approved for use with the 55" Farm Grapple, P/N 7176977)	\$1,593.00	24.0%	\$0.00	\$1,210.68
6726328	<b>88" Constr./Ind. Heavy Duty Bucket ♦</b> (Not approved for use with the 55" Farm Grapple, P/N 7176977)	\$1,668.00	24.0%	\$0.00	\$1,267.68
7173162	<b>82" Constr./Ind. Severe Duty Bucket ♦</b>	\$1,822.00	24.0%	\$0.00	\$1,384.72
7173161	<b>88" Constr./Ind. Severe Duty Bucket ♦</b>	\$1,954.00	24.0%	\$0.00	\$1,485.04
6706483	<b>72" Fertilizer &amp; Grain Bucket D</b>	\$1,183.00	24.0%	\$0.00	\$899.08
6731418	<b>68" Low Profile Bucket ♦</b> (For use with offset rims only)	\$963.00	24.0%	\$0.00	\$731.88
6731421	<b>74" Low Profile Bucket ♦</b>	\$1,043.00	24.0%	\$0.00	\$792.68
6731424	<b>80" Low Profile Bucket ♦</b>	\$1,136.00	24.0%	\$0.00	\$863.36
7184103	<b>68" Snow &amp; Light Material Bucket D</b> (For use with offset rims only)	\$1,098.00	24.0%	\$0.00	\$834.48
7184105	<b>74" Snow &amp; Light Material Bucket D</b>	\$1,162.00	24.0%	\$0.00	\$883.12
7184110	<b>80" Snow &amp; Light Material Bucket D</b>	\$1,274.00	24.0%	\$0.00	\$968.24
7184098	<b>88" Snow &amp; Light Material Bucket D</b>	\$1,359.00	24.0%	\$0.00	\$1,032.84
6727787	<b>100" Snow &amp; Light Material Bucket ♦</b>	\$1,771.00	24.0%	\$0.00	\$1,345.96
(S850)					
6726344	<b>80" Constr./Ind. Heavy Duty Bucket ♦</b> (Not approved for use with the 55" Farm Grapple, P/N 7176977)	\$1,519.00	24.0%	\$0.00	\$1,154.44
7125917	<b>84" Constr./Ind. Heavy Duty Bucket ♦</b> (Not approved for use with the 55" Farm Grapple, P/N 7176977)	\$1,593.00	24.0%	\$0.00	\$1,210.68
6726328	<b>88" Constr./Ind. Heavy Duty Bucket ♦</b> (Not approved for use with the 55" Farm Grapple, P/N 7176977)	\$1,668.00	24.0%	\$0.00	\$1,267.68
7173162	<b>82" Constr./Ind. Severe Duty Bucket ♦</b>	\$1,822.00	24.0%	\$0.00	\$1,384.72
7173161	<b>88" Constr./Ind. Severe Duty Bucket ♦</b>	\$1,954.00	24.0%	\$0.00	\$1,485.04
7184110	<b>80" Snow &amp; Light Material Bucket D</b>	\$1,274.00	24.0%	\$0.00	\$968.24
7184098	<b>88" Snow &amp; Light Material Bucket D</b>	\$1,359.00	24.0%	\$0.00	\$1,032.84
6727787	<b>100" Snow &amp; Light Material Bucket ♦</b>	\$1,771.00	24.0%	\$0.00	\$1,345.96

**D** Buckets have holes predrilled to accept bolt-on cutting edges.

**♦** Buckets have holes predrilled to accept bolt-on cutting edges or bolt-on teeth.

(A770)					
6731409	74" Constr./Ind. Bucket ♦	\$1,030.00	24.0%	\$0.00	\$782.80
6732305	74" Constr./Ind. Heavy Duty Bucket ♦ (Not approved for use with the 55" Farm Grapple, P/N 7176977)	\$1,412.00	24.0%	\$0.00	\$1,073.12
6731412	80" Constr./Ind. Bucket ♦	\$1,121.00	24.0%	\$0.00	\$851.96
6726344	80" Constr./Ind. Heavy Duty Bucket ♦ (Not approved for use with the 55" Farm Grapple, P/N 7176977)	\$1,519.00	24.0%	\$0.00	\$1,154.44
7125917	84" Constr./Ind. Heavy Duty Bucket ♦ (Not approved for use with the 55" Farm Grapple, P/N 7176977)	\$1,593.00	24.0%	\$0.00	\$1,210.68
6726328	88" Constr./Ind. Heavy Duty Bucket ♦ (Not approved for use with the 55" Farm Grapple, P/N 7176977)	\$1,668.00	24.0%	\$0.00	\$1,267.68
7173162	82" Constr./Ind. Severe Duty Bucket ♦	\$1,822.00	24.0%	\$0.00	\$1,384.72
7173161	88" Constr./Ind. Severe Duty Bucket ♦	\$1,954.00	24.0%	\$0.00	\$1,485.04
6706483	72" Fertilizer & Grain Bucket D	\$1,183.00	24.0%	\$0.00	\$899.08
6731421	74" Low Profile Bucket ♦	\$1,043.00	24.0%	\$0.00	\$792.68
6731424	80" Low Profile Bucket ♦	\$1,136.00	24.0%	\$0.00	\$863.36
7184105	74" Snow & Light Material Bucket D	\$1,162.00	24.0%	\$0.00	\$883.12
7184110	80" Snow & Light Material Bucket D	\$1,274.00	24.0%	\$0.00	\$968.24
7184098	88" Snow & Light Material Bucket D	\$1,359.00	24.0%	\$0.00	\$1,032.84
6727787	100" Snow & Light Material Bucket ♦	\$1,771.00	24.0%	\$0.00	\$1,345.96

**D** Buckets have holes predrilled to accept bolt-on cutting edges.

♦ Buckets have holes predrilled to accept bolt-on cutting edges or bolt-on teeth.

(T140)					
6737399	56" Constr./Ind. Bucket ♦	\$922.00	24.0%	\$0.00	\$700.72
6731403	62" Constr./Ind. Bucket ♦	\$839.00	24.0%	\$0.00	\$637.64
6557599	54" Fertilizer & Grain Bucket D	\$805.00	24.0%	\$0.00	\$611.80
6558681	60" Fertilizer & Grain Bucket D	\$826.00	24.0%	\$0.00	\$627.76
7101903	56" Low Profile Bucket ♦	\$933.00	24.0%	\$0.00	\$709.08
6731415	62" Low Profile Bucket ♦ (Must also order Side Edge Cutting kit p/n 6732094 when used with wide track option)	\$853.00	24.0%	\$0.00	\$648.28
7184103	68" Snow & Light Material Bucket D	\$1,098.00	24.0%	\$0.00	\$834.48
7184105	74" Snow & Light Material Bucket D	\$1,162.00	24.0%	\$0.00	\$883.12

(T550, T590)					
6731406	68" Constr./Ind. Bucket ♦	\$950.00	24.0%	\$0.00	\$722.00
7124426	68" Constr./Ind. Heavy Duty Bucket ♦ (S530, S570, S590 only) Recommended for severe-duty use (Not approved for use with the 55" Farm Grapple P/N 7176977)	\$1,360.00	24.0%	\$0.00	\$1,033.60
6731409	74" Constr./Ind. Bucket ♦ (Must also order Side Edge Cutting kit p/n 6732093 when used with wide track option)	\$1,030.00	24.0%	\$0.00	\$782.80

6732305	<b>74" Constr./Ind. Heavy Duty Bucket ♦</b> (Recommended for severe-duty use) (Not approved for use with the 55" Farm Grapple, P/N 7176977)	<b>\$1,412.00</b>	<b>24.0%</b>	<b>\$0.00</b>	<b>\$1,073.12</b>
6558681	<b>60" Fertilizer &amp; Grain Bucket D</b>	<b>\$826.00</b>	<b>24.0%</b>	<b>\$0.00</b>	<b>\$627.76</b>
6706479	<b>66" Fertilizer &amp; Grain Bucket D</b>	<b>\$1,071.00</b>	<b>24.0%</b>	<b>\$0.00</b>	<b>\$813.96</b>
6731415	<b>62" Low Profile Bucket ♦</b>	<b>\$853.00</b>	<b>24.0%</b>	<b>\$0.00</b>	<b>\$648.28</b>
6731418	<b>68" Low Profile Bucket ♦</b>	<b>\$963.00</b>	<b>24.0%</b>	<b>\$0.00</b>	<b>\$731.88</b>
6731421	<b>74" Low Profile Bucket ♦</b> (Must also order Side Edge Cutting kit p/n 6732094 when used with wide track option)	<b>\$1,043.00</b>	<b>24.0%</b>	<b>\$0.00</b>	<b>\$792.68</b>
7184103	<b>68" Snow &amp; Light Material Bucket D</b>	<b>\$1,098.00</b>	<b>24.0%</b>	<b>\$0.00</b>	<b>\$834.48</b>
7184105	<b>74" Snow &amp; Light Material Bucket D</b>	<b>\$1,162.00</b>	<b>24.0%</b>	<b>\$0.00</b>	<b>\$883.12</b>
7184110	<b>80" Snow &amp; Light Material Bucket D</b>	<b>\$1,274.00</b>	<b>24.0%</b>	<b>\$0.00</b>	<b>\$968.24</b>
7184098	<b>88" Snow &amp; Light Material Bucket D</b>	<b>\$1,359.00</b>	<b>24.0%</b>	<b>\$0.00</b>	<b>\$1,032.84</b>
<b>(T630, T650)</b>					
6731409	<b>74" Constr./Ind. Bucket ♦</b> (Must also order Side Edge Cutting kit p/n 6732093 when used with wide track option)	<b>\$1,030.00</b>	<b>24.0%</b>	<b>\$0.00</b>	<b>\$782.80</b>
6732305	<b>74" Constr./Ind. Heavy Duty Bucket ♦</b> (Not approved for use with the 55" Farm Grapple, P/N 7176977)	<b>\$1,412.00</b>	<b>24.0%</b>	<b>\$0.00</b>	<b>\$1,073.12</b>
6731412	<b>80" Constr./Ind. Bucket ♦</b>	<b>\$1,121.00</b>	<b>24.0%</b>	<b>\$0.00</b>	<b>\$851.96</b>
6726344	<b>80" Constr./Ind. Heavy Duty Bucket ♦</b> (Not approved for use with the 55" Farm Grapple, P/N 7176977)	<b>\$1,519.00</b>	<b>24.0%</b>	<b>\$0.00</b>	<b>\$1,154.44</b>
7125917	<b>84" Constr./Ind. Heavy Duty Bucket ♦</b> (Not approved for use with the 55" Farm Grapple, P/N 7176977)	<b>\$1,593.00</b>	<b>24.0%</b>	<b>\$0.00</b>	<b>\$1,210.68</b>
6706483	<b>72" Fertilizer &amp; Grain Bucket D</b> (For use with narrow track only)	<b>\$1,183.00</b>	<b>24.0%</b>	<b>\$0.00</b>	<b>\$899.08</b>
6731421	<b>74" Low Profile Bucket ♦</b> (Must also order Side Edge Cutting kit p/n 6732094 when used with wide track option)	<b>\$1,043.00</b>	<b>24.0%</b>	<b>\$0.00</b>	<b>\$792.68</b>
6731424	<b>80" Low Profile Bucket ♦</b>	<b>\$1,136.00</b>	<b>24.0%</b>	<b>\$0.00</b>	<b>\$863.36</b>
7184105	<b>74" Snow &amp; Light Material Bucket D</b>	<b>\$1,162.00</b>	<b>24.0%</b>	<b>\$0.00</b>	<b>\$883.12</b>
7184110	<b>80" Snow &amp; Light Material Bucket D</b>	<b>\$1,274.00</b>	<b>24.0%</b>	<b>\$0.00</b>	<b>\$968.24</b>
7184098	<b>88" Snow &amp; Light Material Bucket D</b>	<b>\$1,359.00</b>	<b>24.0%</b>	<b>\$0.00</b>	<b>\$1,032.84</b>
<b>(T750, T770)</b>					
6732305	<b>74" Constr./Ind. Heavy Duty Bucket ♦</b> (Not approved for use with the 55" Farm Grapple, P/N 7176977)	<b>\$1,412.00</b>	<b>24.0%</b>	<b>\$0.00</b>	<b>\$1,073.12</b>
6726344	<b>80" Constr./Ind. Heavy Duty Bucket ♦</b> (Not approved for use with the 55" Farm Grapple, P/N 7176977)	<b>\$1,519.00</b>	<b>24.0%</b>	<b>\$0.00</b>	<b>\$1,154.44</b>
7125917	<b>84" Constr./Ind. Heavy Duty Bucket ♦</b> (Not approved for use with the 55" Farm Grapple, P/N 7176977)	<b>\$1,593.00</b>	<b>24.0%</b>	<b>\$0.00</b>	<b>\$1,210.68</b>
6726328	<b>88" Constr./Ind. Heavy Duty Bucket ♦</b> (Not approved for use with the 55" Farm Grapple, P/N 7176977)	<b>\$1,668.00</b>	<b>24.0%</b>	<b>\$0.00</b>	<b>\$1,267.68</b>

7173162	<b>82" Constr./Ind. Severe Duty Bucket ♦</b>	<b>\$1,822.00</b>	<b>24.0%</b>	<b>\$0.00</b>	<b>\$1,384.72</b>
7173161	<b>88" Constr./Ind. Severe Duty Bucket ♦</b>	<b>\$1,954.00</b>	<b>24.0%</b>	<b>\$0.00</b>	<b>\$1,485.04</b>
6706483	<b>72" Fertilizer &amp; Grain Bucket D</b> (For use with narrow track only)	<b>\$1,183.00</b>	<b>24.0%</b>	<b>\$0.00</b>	<b>\$899.08</b>
7184110	<b>80" Snow &amp; Light Material Bucket D</b>	<b>\$1,274.00</b>	<b>24.0%</b>	<b>\$0.00</b>	<b>\$968.24</b>
7184098	<b>88" Snow &amp; Light Material Bucket D</b>	<b>\$1,359.00</b>	<b>24.0%</b>	<b>\$0.00</b>	<b>\$1,032.84</b>
6727787	<b>100" Snow &amp; Light Material Bucket ♦</b>	<b>\$1,771.00</b>	<b>24.0%</b>	<b>\$0.00</b>	<b>\$1,345.96</b>
(T870)					
7125917	<b>84" Constr./Ind. Heavy Duty Bucket ♦</b> (Recommended for severe-duty use) (Not approved for use with the 55" Farm Grapple, P/N 7176977)	<b>\$1,593.00</b>	<b>24.0%</b>	<b>\$0.00</b>	<b>\$1,210.68</b>
6726328	<b>88" Constr./Ind. Heavy Duty Bucket ♦</b> (Recommended for severe-duty use) (Not approved for use with the 55" Farm Grapple, P/N 7176977)	<b>\$1,668.00</b>	<b>24.0%</b>	<b>\$0.00</b>	<b>\$1,267.68</b>
7173161	<b>88" Constr./Ind. Severe Duty Bucket ♦</b> (Recommended for severe-duty use)	<b>\$1,954.00</b>	<b>24.0%</b>	<b>\$0.00</b>	<b>\$1,485.04</b>
7184098	<b>88" Snow &amp; Light Material Bucket D</b>	<b>\$1,359.00</b>	<b>24.0%</b>	<b>\$0.00</b>	<b>\$1,032.84</b>
6727787	<b>100" Snow &amp; Light Material Bucket ♦</b>	<b>\$1,771.00</b>	<b>24.0%</b>	<b>\$0.00</b>	<b>\$1,345.96</b>

**D** Buckets have holes predrilled to accept bolt-on cutting edges.

**♦** Buckets have holes predrilled to accept bolt-on cutting edges or bolt-on teeth.

Part Number	Chipper Description	SLP in US\$	Discount Percent	Labor	Price
-------------	---------------------	-------------	------------------	-------	-------

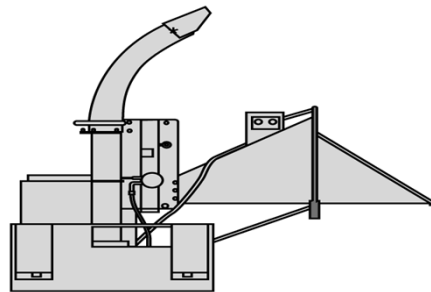

(S130, S510, S550, S530, S570, S590, S220, S250, S300, S330) (A300) (A770)

(S630, S650, S750, S770, S850) (T140, T550, T590, T250, T300, T320)

(T630, T650, T750, T770, T870)

6719129	<b>5A Chipper</b> (Loader must be equipped with an Attachment Control Kit) (Attachment includes a 7-pin harness only) (Approved G-Series and newer Loaders only)	<b>\$8,071.00</b>	<b>24.0%</b>	<b>\$0.00</b>	<b>\$6,133.96</b>
---------	--	-------------------	--------------	---------------	-------------------



(S550H, S570H, S590H, S220H, S250H, S300H, S330H) (A300H) (A770H)  
 (S630H, S650H, S750H, S770H, S850H) (T550H, T590H, T250H, T300H)  
 (T630H, T650H, T750H, T770H, T870H)

**7117662**      **8B Chipper**      **\$11,927.00**      **24.0%**      **\$0.00**      **\$9,064.52**  
 (Loader must be equipped with an 7-Pin Attachment Control Kit)  
 (Approved G-Series and new Loaders only)

5A Chipper must be installed on 700-800 Series BICS Loaders. Will not function on non-BICS loaders, 953s or 963s. 700-800 Series Loaders prior to G-Series need a Remote Attachment Control Kit, P/N 6716566

8B Chipper must be installed on G-Series and new loaders only

Part Number	Combination Bucket Description	SLP in US\$	Discount Percent	Labor	Price
-------------	--------------------------------	-------------	------------------	-------	-------

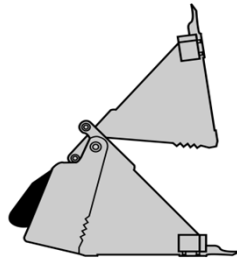

(463, S70)  
**6815543**      **44" Combination Bucket**      **\$2,296.00**      **24.0%**      **\$0.00**      **\$1,744.96**  
 (Bolt-on Teeth are available from Bobcat Dealer)

(S130, S510\*, S550\*, S530\*, S570\*) (T140)  
**7167310**      **62" Combination Bucket**      **\$3,040.00**      **24.0%**      **\$0.00**      **\$2,310.40**  
 (Bolt-on Teeth are available from Bobcat Dealer)

(S510, S550, S530, S570, S590, S220\*, S250\*, S300\*) (S630\*, S650\*, S750\*, S770\*)  
 (T550, T590)  
**7167311**      **68" Combination Bucket**      **\$3,294.00**      **24.0%**      **\$0.00**      **\$2,503.44**  
 (Bolt-on Teeth are available from Bobcat Dealer)

(S510, S550, S530, S570, S590, S220, S250, S300) (S630, S650, S750, S770) (A770)  
 (T550, T590) (T630, T650)  
**7167312**      **74" Combination Bucket**      **\$3,547.00**      **24.0%**      **\$0.00**      **\$2,695.72**  
 (Bolt-on Teeth are available from Bobcat Dealer)

(S220, S250, S300, S330) (S630, S650, S750, S770) (A300) (A770) (T250, T300, T320)  
 (T630, T650, T750, T770)

7167313      **80" Combination Bucket**      \$4,359.00      24.0%      \$0.00      \$3,312.84  
 (Bolt-on Teeth are available from Bobcat Dealer)

(S220, S250, S300, S330) (S750, S770) (A300) (A770) (T250, T300, T320) (T650, T750, T770)

7167314      **84" Combination Bucket**      \$4,562.00      24.0%      \$0.00      \$3,467.12  
 (Bolt-on Teeth are available from Bobcat Dealer)

**\*Requires Inset Rims**

Combination Buckets are not approved for use with the Tilt-Tatch.  
 Combination Buckets may interfere with tracks at extreme roll-back position on some loaders. Use of lift-arm stop is required if this occurs.  
 It is recommended that a port relief be installed for use with the Combination Buckets. Installation instructions are included in the Operation Manual.  
 Optional Open/Close Restrictor is available to slow down the open/close functions of the combination bucket.

Part Number	Concrete Mixer Description	SLP in US\$	Discount Percent	Labor	Price
-------------	----------------------------	-------------	------------------	-------	-------

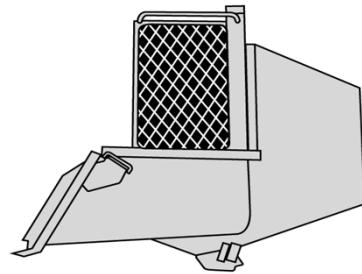

(S130, S510, S550, S530, S570, S590, S220, S250, S300, S330)  
 (A300) (T140, T550, T590, T250, T300, T320)

7113817      **Concrete Mixer**      \$4,000.00      24.0%      \$0.00      \$3,040.00  
 (Loader must be equipped with an Attachment Control Kit)  
 (F-Series and prior Loaders require Remote Attachment Control Kit)  
 (Attachment includes a 7-Pin Harness only)

Concrete Mixer needs to be installed on BICS Loaders. Concrete Mixer will not function on non-BICS loaders, 953s or 963.

Part Number	Concrete Pump Description	SLP in US\$	Discount Percent	Labor	Price
-------------	---------------------------	-------------	------------------	-------	-------

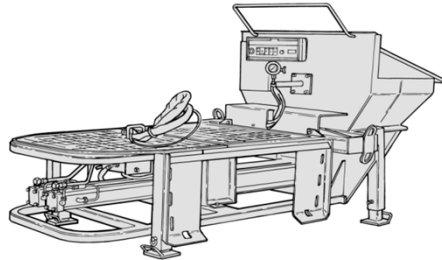

(S570, S570H, S590, S590H, S220, S220H, S250, S250H, S300, S300H, S330, S330H)  
 (S630, S630H, S650, S650H, S750, S750H, S770, S770H, S850, S850H) (A300, A300H)  
 (A770, A770H) (T550, T550H, T590, T590H, T250, T250H, T300, T300H, T320, T320H)  
 (T630, T630H, T650, T650H, T750, T750H, T770, T770H, T870, T870H)

7108693	<b>Concrete Pump</b> (Loader must be equipped with an Attachment Control Kit) (Attachment includes a 7-Pin Harness only) (May also need Delivery System Kit-unless customer has this equipment) Concrete Pump needs to be installed on 700-800, S570-S300, A220-A300, T550-T300 G-Series or newer BICS Loaders or 963 G-Series, will not function on F-Series or non-BICS loaders, 953s or 963 C-Series.	\$24,090.00	24.0%	\$0.00	\$18,308.40
---------	--	-------------	-------	--------	-------------

Part Number	Accessories Description	SLP in US\$	Discount Percent	Labor	Price
-------------	-------------------------	-------------	------------------	-------	-------

6906079	<b>Delivery System Kit</b> (Includes 5" elbow, 5" to 3" reducer, (3) 25 ft. sections of 3" flexible hose, 3" x 6' flexible hose, (3) 3" x 10' steel lines, (2) 5" couplings, (8) 3" couplings, 3" cleanout ball) (Ship Weight 640 lbs.)	\$4,705.00	24.0%	\$0.00	\$3,575.80
6906813	<b>Remote Control Kit</b> (The hand held transmitter runs all functions of the Concrete Pump within a range of 200-400 feet from the pump.) (Price includes \$90 for installation)	\$1,855.00	24.0%	\$90.00	\$1,499.80
6906861	<b>Shot Crete Delivery Kit</b> (Kit includes (3) 25 ft. sections of 2" hose, 3" to 2" reducer, shot crete nozzle, ball valve, 2" clean out ball and clamps.) (Delivery system P/N 6906079 is required for use unless customer has pump hoses and clamps.) (Ship Weight 225 lbs.)	\$1,662.00	24.0%	\$0.00	\$1,263.12

Part Number	Digger Description	SLP in US\$	Discount Percent	Labor	Price
-------------	--------------------	-------------	------------------	-------	-------

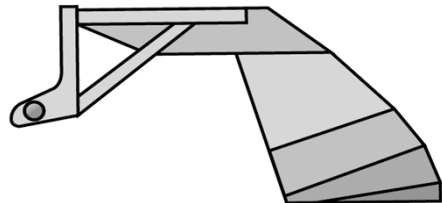

(553, S100, S130, S510, S550, S530, S570, S590, S220, S250, S300, S330)

(S630, S650, S750, S770) (A770) (T110, T140, T550, T590)

6719754	12" Digger	\$1,020.00	24.0%	\$0.00	\$775.20
6719755	16" Digger	\$1,020.00	24.0%	\$0.00	\$775.20

(S130, S510, S550, S530, S570, S590, S220, S250, S300, S330)

(S630, S650, S750, S770) (A770) (T140, T550, T590)

6719756	25" Digger	\$1,020.00	24.0%	\$0.00	\$775.20
6719757	30" Digger	\$1,075.00	24.0%	\$0.00	\$817.00
6719758	36" Digger	\$1,120.00	24.0%	\$0.00	\$851.20

Part Number	Dozer Blade Description	SLP in US\$	Discount Percent	Labor	Price
-------------	-------------------------	-------------	------------------	-------	-------

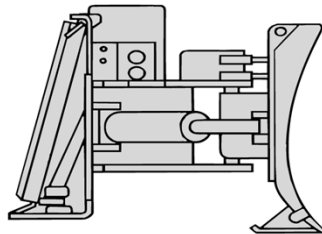

(463, S70)

7196165	<b>54" Utility Blade (with hydraulic angle)</b> (To be used as either a Snow Blade or a Dozer Blade)	\$1,378.00	24.0%	\$0.00	\$1,047.28
---------	---	------------	-------	--------	------------

(S130) (T140)

7106089	<b>68" Dozer Blade</b> (Loader must be equipped with an Attachment Control Kit) (When used on loaders equipped with a 14-Pin Attachment Control Kit, a 14-Pin	\$4,295.00	24.0%	\$0.00	\$3,264.20
---------	---	------------	-------	--------	------------

Attachment T-Harness Kit is required)

(S130, S510, S550, S530, S570, S590, S220, S250, S300, S330) (S630, S650, S750, S770)  
(T140, T550, T590) (T630, T650)

**6905884**      **80" Dozer Blade, 6-Way**      **\$4,595.00**      **24.0%**      **\$0.00**      **\$3,492.20**  
(Loader must be equipped with an Attachment Control Kit)  
(When used on loaders equipped with a 14-Pin Attachment Control Kit, a 14-Pin Attachment T-Harness Kit is required)

(S220, S250, S300, S330) (S630, S650, S750, S770) (A300) (A770) (T630, T650)

**6905811**      **90" Dozer Blade, 6-Way**      **\$4,960.00**      **24.0%**      **\$0.00**      **\$3,769.60**  
(Loader must be equipped with an Attachment Control Kit)  
(When used on loaders equipped with a 14-Pin Attachment Control Kit, a 14-Pin Attachment T-Harness Kit is required)

(S220, S250, S300, S330) (S630, S650, S750, S770, S850) (A300) (A770)

(T250, T300, T320) (T630, T650, T750, T770, T870)  
**7105781**      **96" Dozer Blade, 6-Way**      **\$5,930.00**      **24.0%**      **\$0.00**      **\$4,506.80**  
(Loader must be equipped with an Attachment Control Kit)  
(When used on loaders equipped with a 14-Pin Attachment Control Kit, a 14-Pin

Part Number	Drop Hammer Description	SLP in US\$	Discount Percent	Labor	Price
-------------	-------------------------	-------------	------------------	-------	-------

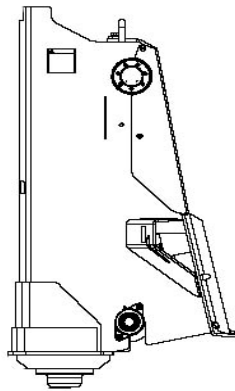

(S530, S570, S590, S220, S250, S300, S330) (S630, S650, S750, S770, S850) (A300) (A770)  
(T550, T590, T250, T300, T320) (T630, T650, T750, T770, T870)

**7137810**      **Drop Hammer**      **\$8,117.00**      **24.0%**      **\$0.00**      **\$6,168.92**

Part Number	Dumping Hopper Description	SLP in US\$	Discount Percent	Labor	Price
-------------	----------------------------	-------------	------------------	-------	-------

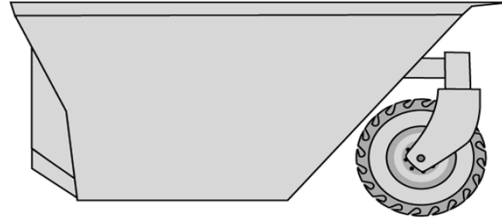

(463, S70, 553, S100) (T110)

6727275

**Model 10 Dumping Hopper**

(Includes 8.5 x 12 Bobcat Heavy Duty Tire. Tire is not installed on Dumping Hopper.)

(For 553, S100 and T110 must also order Mounting Frame P/N 6729483)

**\$2,981.00**

**24.0%**

**\$0.00**

**\$2,265.56**

(S130, S510, S550, S530, S570, S590, S220, S250, S300, S330) (S630, S650, S750, S770, S850)

(A300) (A770) (T140, T550, T590, T250, T300, T320) (T630, T650, T750, T770, T870)

6717597

**Model 25 Dumping Hopper**

(Includes 8.5 x 12 Bobcat Heavy Duty Tires. Tires are not installed on Dumping Hopper.)

**\$4,607.00**

**24.0%**

**\$0.00**

**\$3,501.32**

Part Number	Flail Cutter Description	SLP in US\$	Discount Percent	Labor	Price
-------------	--------------------------	-------------	------------------	-------	-------

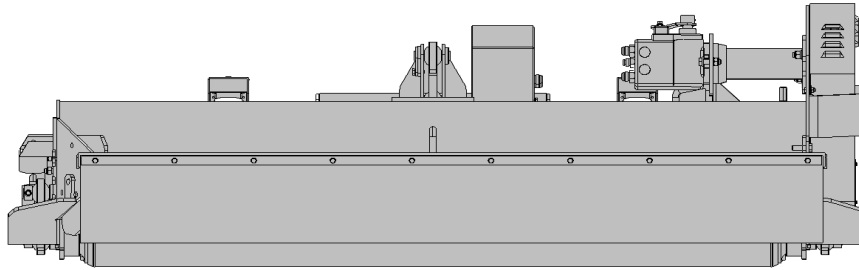

(S530, S530H, S570, S570H, S590, S590H, S220, S220H, S250, S250H, S300, S300H, S330, S330H)(S630, S630H, S650, S650H, S750, S750H, S770, S770H, S850, S850H)  
(A300, A300H)(A770, A770H) (T550, T550H, T590, T590H, T250, T250H, T300, T300H, T320, T320H)(T630, T630H, T650, T650H, T750, T750H, T770, T770H, T870, T870H)

7101894	FC200 Flail Cutter	\$11,119.00	24.0%	\$0.00	\$8,450.44
---------	--------------------	-------------	-------	--------	------------

Part Number	Forestry Cutter Description	SLP in US\$	Discount Percent	Labor	Price
-------------	-----------------------------	-------------	------------------	-------	-------

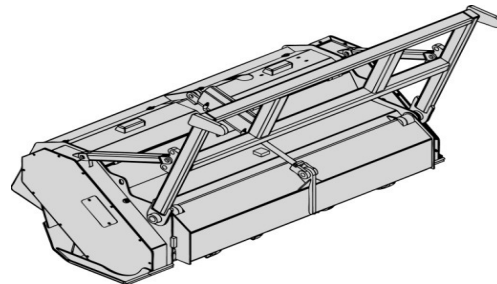

(S300H, S330H) (S750H, S770H, S850H) (A300H) (A770H) (T250H, T300H, T320H)  
(T750H, T770H, T870H)

7194306	Forestry Cutter, 50"	\$24,086.00	24.0%	\$0.00	\$18,305.36
---------	----------------------	-------------	-------	--------	-------------

- For K-Series Loaders (S300H, S330H, A300H, T250H, T300H, T320H)
- Must also order Forestry Applications Kit, K-Series p/n 7131810

- For M-Series Loaders (S750H, S770H, S850H, A770H, T750H, T770H, T870H) must also order Forestry Applications Kit, M-Series p/n 7174126
- Loader must be equipped with high flow and upgraded cooling system

(The following K-Series loader serial numbers must be equipped with the cooling system upgrade kit p/n 7126319 - order from Bobcat Dealer: A300 s/n 539911675 & below; T300 s/n 532015066 & below; T250 s/n 531812826 & below; S300 s/n 531115051 & below)

(All S330 loaders are equipped with the upgraded cooling system)  
 (For loaders A300 s/n A5GW19999 and below; S300 A5GP19999 and below; S330 A5HA19999 and below; T250 A5GS19999 and below; T300 A5GU19999 and below; and T320 A7MP60000 and below must also order door wiring harness kit, p/n 7155443)

**(S300H, S330H) (S750H, S770H, S850H) (A300H) (A770H) (T250H, T300H, T320H) (T750H, T770H, T870H)**

**7194305**

**Forestry Cutter, 60"**

**\$25,350.00      24.0%      \$0.00      \$19,266.00**

- For K-Series Loaders (S300H, S330H, A300H, T250H, T300H, T320H)
- Must also order Forestry Applications Kit, K-Series p/n 7131810
- For M-Series Loaders (S750H, S770H, S850H, A770H, T750H, T770H, T870H) must also order Forestry Applications Kit, M-Series p/n 7174126
- Loader must be equipped with high flow and upgraded cooling system

(The following K-Series loader serial numbers must be equipped with the cooling system upgrade kit p/n 7126319 - order from Bobcat Dealer: A300 s/n 539911675 & below; T300 s/n 532015066 & below; T250 s/n 531812826 & below; S300 s/n 531115051 & below)

(All S330 loaders are equipped with the upgraded cooling system)

(For loaders A300 s/n A5GW19999 and below; S300 A5GP19999 and below; S330 A5HA19999 and below; T250 A5GS19999 and below; T300 A5GU19999 and below; and T320 A7MP60000 and below must also order door wiring harness kit, p/n 7155443 from parts.)

**(S300H, S330H) (S750H, S770H, S850H) (A300H) (A770H) (T250H, T300H, T320H) (T750H, T770H, T870H)**

**7204123**

**Forestry Cutter, 50" 2 Speed**

**\$27,080.00      24.0%      \$0.00      \$20,580.80**

- For K-Series Loaders (S300H, S330H, A300H, T250H, T300H, T320H)
- Must also order Forestry Applications Kit, K-Series p/n 7131810
- For M-Series Loaders (S750H, S770H, S850H, A770H, T750H, T770H, T870H) must also order Forestry Applications Kit, M-Series p/n 7174126
- Loader must be equipped with high flow and upgraded cooling system

(The following K-Series loader serial numbers must be equipped with the cooling system upgrade kit p/n 7126319 - order from Bobcat Dealer: A300 s/n 539911675 & below; T300 s/n 532015066 & below; T250 s/n 531812826 & below; S300 s/n 531115051 & below)

(All S330 loaders are equipped with the upgraded cooling system)



(For loaders A300 s/n A5GW19999 and below; S300 A5GP19999 and below; S330 A5HA19999 and below; T250 A5GS19999 and below; T300 A5GU19999 and below; and T320 A7MP60000 and below must also order door wiring harness kit, p/n 7155443)

**(S300H, S330H) (S750H, S770H, S850H) (A300H) (A770H) (T250H, T300H, T320H) (T750H, T770H, T870H)**

**7204127      Forestry Cutter, 60" 2-Speed      \$28,495.00      24.0%      \$0.00      \$21,656.20**

- For K-Series Loaders (S300H, S330H, A300H, T250H, T300H, T320H)
  - Must also order Forestry Applications Kit, K-Series p/n 7131810
  - For M-Series Loaders (S750H, S770H, S850H, A770H, T750H, T770H, T870H)
- must also order Forestry Applications Kit, M-Series p/n 7174126**
- Loader must be equipped with high flow and upgraded cooling system

(The following K-Series loader serial numbers must be equipped with the cooling system upgrade kit p/n 7126319 - order from Bobcat Dealer: A300 s/n 539911675 & below; T300 s/n 532015066 & below; T250 s/n 531812826 & below; S300 s/n 531115051 & below)  
(All S330 loaders are equipped with the upgraded cooling system)

(For loaders A300 s/n A5GW 19999 and below; S300 A5GP19999 and below; S330 A5HA19999 and below; T250 A5GS19999 and below; T300 A5GU19999 and below; and T320 A7MP60000 and below must also order door wiring harness kit, p/n 7155443 from parts.)

Part Number	Factory Installed Options Description	SLP in US\$	Discount Percent	Labor	Price
7195450	<b>Front Gate, 50"</b> (Produces finer mulch)	\$1,662.00	24.0%	\$0.00	\$1,263.12
7195323	<b>Front Gate, 60"</b> (Produces finer mulch)	\$1,678.00	24.0%	\$0.00	\$1,275.28

Part Number	Accessories Description	SLP in US\$	Discount Percent	Labor	Price
-------------	-------------------------	-------------	------------------	-------	-------

7131810	<b>Forestry Applications Kit, K-Series</b> <b>Kit is required to operate Forestry Cutter and provides operator &amp; machine protection. Not compatible with rear auxiliary hydraulics.</b> Kit includes: Forestry Door (3/4 in. laminated polycarbonate), Front and Rear Light Guards, Hydraulic Quick Coupler Guard, Fire Extinguisher, Level II FOPS, Debris Screen for Radiator, Muffler Guard, Lift Cylinder Debris Shields, Top and Rear Windows (1/4 in. polycarbonate), Cab Bulb Seal and Door Threshold and Seal (Add \$900.00 for installation to discounted price)	\$4,939.00	24.0%	\$900.00	\$4,653.64
---------	---	------------	-------	----------	------------

7174126	<p><b>Forestry Applications Kit, M-Series**</b></p> <p><b>Kit is required to operate Forestry Cutter and provides operator &amp; machine protection.</b></p> <p><b>**Must also order Engine Seal Kit</b></p> <p><b>Not compatible with rear auxiliary hydraulics.</b></p> <p>Kit includes: Forestry Door (3/4 in. laminated polycarbonate), Front and Rear Light Guards, Hydraulic Quick Coupler Guard, Fire Extinguisher, Level II FOPS, Muffler Guard, Lift Cylinder Debris Shields, Top and Rear Windows, Polycarbonate Side Windows</p> <p>(Add \$900.00 for installation to discounted price)</p>	\$5,995.00	24.0%	\$900.00	\$5,456.20
---------	--	------------	-------	----------	------------

Part Number	Forks, Utility Description	SLP in US\$	Discount Percent	Labor	Price
-------------	----------------------------	-------------	------------------	-------	-------

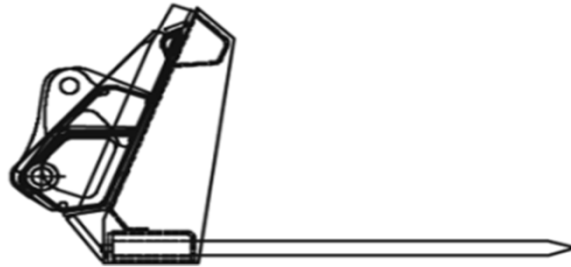

(463, S70) 6727904	<p><b>36" Utility fork, with 5 Teeth</b></p> <p>(Use with Farm/Utility grapple P/N 6728117) (Additional Forks (p/n 6717622) may be Ordered)</p>	\$750.00	24.0%	\$0.00	\$570.00
(463, S70, 553, S100) (T110) 6727899	<p><b>48" Utility fork, with 6 Teeth</b></p> <p>(Use with Farm/Utility grapple P/N 6728117) (Additional Forks (p/n 6717622) may be Ordered)</p>	\$817.00	24.0%	\$0.00	\$620.92
(463, S70, 553, S100, S130) (T110, T140) 6727888	<p><b>54" Utility fork, with 7 Teeth</b></p> <p>(Use with Farm/Utility grapple P/N 6728117) (Additional Forks (p/n 6717622) may be Ordered)</p>	\$897.00	24.0%	\$0.00	\$681.72
(S130, S510, S550, S530, S570, S590) (S630, S650) (T140) 6725178	<p><b>60" Utility fork, with 8 Teeth</b></p> <p>(Use with Farm/Utility grapple P/N 7176977) (Additional Forks (p/n 6717622) may be Ordered)</p>	\$990.00	24.0%	\$0.00	\$752.40

<b>(S130, S510, S550, S530, S570, S590) (S630, S650) (T140, T550, T590)</b>					
<b>6725179</b>	<b>66" Utility fork, with 9 Teeth</b>	<b>\$1,092.00</b>	<b>24.0%</b>	<b>\$0.00</b>	<b>\$829.92</b>
	(Use with Farm/Utility grapple P/N 7176977) (Additional Forks (p/n 6717622) may be Ordered)				
<b>(S510, S550, S530, S570, S590, S220, S250, S300, S330) (S630, S650, S750, S770)</b>					
<b>(A770) (T140, T550, T590) (T630, T650)</b>	<b>72" Utility fork, with 10 Teeth</b>	<b>\$1,237.00</b>	<b>24.0%</b>	<b>\$0.00</b>	<b>\$940.12</b>
<b>6725180</b>	(Use with Farm/Utility grapple P/N 7176977) (Additional Forks (p/n 6717622) may be Ordered)				
<b>(S530, S570, S590, S220, S250, S300, S330) (S630, S650, S750, S770)</b>					
<b>(A300) (A770) (T550, T590) (T630, T650)</b>	<b>80" Utility fork, with 11 Teeth</b>	<b>\$1,448.00</b>	<b>24.0%</b>	<b>\$0.00</b>	<b>\$1,100.48</b>
<b>7107243</b>	(Use with Farm/Utility grapple P/N 7176977) (Additional Forks (p/n 6717622) may be ordered)				

Part Number	Grader Description	SLP in US\$	Discount Percent	Labor	Price
-------------	--------------------	-------------	------------------	-------	-------

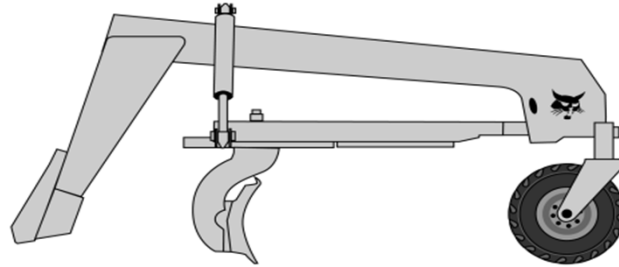

(S130, S510, S550, S530, S570, S590, S220, S250, S300, S330) (S630, S650, S750, S770)  
(A300) (A770) (T140, T550, T590)

6906480	<b>Grader, 84"</b> (Loader must be equipped with an Attachment Control Kit) (When used on loaders equipped with a 14-Pin Attachment Control Kit, a 14-Pin Attachment T-Harness Kit P/N 7164095 is required)	\$7,716.00	24.0%	\$0.00	\$5,864.16
---------	---	------------	-------	--------	------------

(S300, S330) (S750, S770, S850) (A300) (A770) (T250, T300, T320) (T650, T750, T770, T870)

7160005	<b>Grader,96"</b> (Loader must be equipped with an Attachment Control Kit) (When used on loaders equipped with a 14-Pin Attachment Control Kit, a 14-Pin Attachment T-Harness Kit P/N 7164095 is required)	\$12,302.00	24.0%	\$0.00	\$9,349.52
---------	--	-------------	-------	--------	------------

(S300, S330) (S750, S770, S850) (A300) (A770) (T300, T320) (T750, T770, T870)

7182060	<b>Grader, 108"</b> (Loader must be equipped with an Attachment Control Kit) (When used on loaders equipped with a 14-Pin Attachment Control Kit, a 14-Pin Attachment T-Harness Kit P/N 7164095 is required)	\$12,843.00	24.0%	\$0.00	\$9,760.68
---------	--	-------------	-------	--------	------------

Part Number	Accessories Description	SLP in US\$	Discount Percent	Labor	Price
-------------	-------------------------	-------------	------------------	-------	-------

7164094	<b>Laser Mounting Kit, BLR2 (must also order 2 receivers)</b> (For 84" Grader) (Must also order two laser receivers, p/n 7160486) (Approved for use on Graders S/N 64801631 & above, started production April 2009) (Includes two receiver poles and wiring harnesses) <i>(Price includes \$225 for installation)</i>	\$876.00	24.0%	\$225.00	\$890.76
---------	---	----------	-------	----------	----------

7177685	<b>Laser Mounting Kit</b> (For 96" and 108" Grader) (Must also order two laser receivers, p/n 7160486) (Includes two receiver poles and wiring harnesses) <i>(Price includes \$225 for installation)</i>	<b>\$914.00</b>	<b>24.0%</b>	<b>\$225.00</b>	<b>\$919.64</b>
7160486	<b>Laser Receiver, BLR2</b> (Must order 2 for use with laser kit) (May also need a laser transmitter and tripod—unless customer has this equipment.) (The laser receivers will work with most rotating laser transmitters, for full functionality a dual slope-rotating transmitter is recommended.)(Approved for use on Graders S/N 648001631 & above, started production April 2009, and 96" and 108" Graders)	<b>\$1,941.00</b>	<b>24.0%</b>	<b>\$0.00</b>	<b>\$1,475.16</b>
6680073	<b>Laser Transmitter, Dual Slope</b> (Trimble GL722)	<b>\$7,717.00</b>	<b>24.0%</b>	<b>\$0.00</b>	<b>\$5,864.92</b>
6697973	<b>Laser Transmitter, Dual Slope</b> (Trimble GL422; includes CR600 receiver)	<b>\$3,564.00</b>	<b>24.0%</b>	<b>\$0.00</b>	<b>\$2,708.64</b>
6697972	<b>Laser Transmitter, Single Slope</b> (Trimble GL412)	<b>\$2,590.00</b>	<b>24.0%</b>	<b>\$0.00</b>	<b>\$1,968.40</b>
6688806	<b>Tripod</b>	<b>\$238.00</b>	<b>24.0%</b>	<b>\$0.00</b>	<b>\$180.88</b>

Part Number	Grapple, Farm/Utility Description	SLP in US\$	Discount Percent	Labor	Price
-------------	-----------------------------------	-------------	------------------	-------	-------

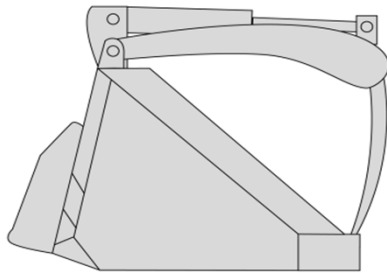

*Farm Grapple with Bucket*

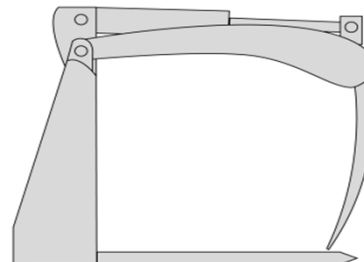

*Farm Grapple with Forks*

(463, S70, 553) 6728117	<b>Grapple, 32" Utility</b> (Fits Current 36", 48" & 54" Utility Forks and 36" & 44" Utility Buckets) <i>(Price includes \$360 for installation)</i>	<b>\$1,050.00</b>	<b>24.0%</b>	<b>\$360.00</b>	<b>\$1,158.00</b>
7125370	<b>Grapple, 32"</b> (Fits Current 36" – 50" <b>General Purpose</b> buckets) (If bucket is equipped with a 6 hole step, must order a replacement 4 hole step, P/N 7103163) <i>(Price includes \$360 for installation)</i>	<b>\$1,050.00</b>	<b>24.0%</b>	<b>\$360.00</b>	<b>\$1,158.00</b>

(S130, S510, S550, S530, S570, S590, S220, S250, S300, S330) (S630, S650, S750, S770)

(A300) (A770) (T140, T550, T590) (T630, T650)

**7176977**      **Grapple, 55" Utility – C/I**  
(Fits 62", 68", 74" and 80" **Roundback** Low Profile and Construction/Industrial Buckets  
and 60", 66", 72", and 80" Utility Forks)  
(Will not fit Heavy Duty Construction/Industrial Buckets)  
*(Price includes \$360 for installation)*

**\$1,475.00**      **24.0%**      **\$360.00**      **\$1,481.00**

(S130, S510, S550, S530, S570)

**7176783**      **Grapple, 55" Utility - GP**  
(Fits 62", 68" and 74" **General Purpose** buckets)  
*(Price includes \$360 for installation)*

**\$1,475.00**      **24.0%**      **\$360.00**      **\$1,481.00**

<b>Part Number</b>	<b>Grapple, Industrial Description</b>	<b>SLP in US\$</b>	<b>Discount Percent</b>	<b>Labor</b>	<b>Price</b>
--------------------	--	--------------------	-------------------------	--------------	--------------

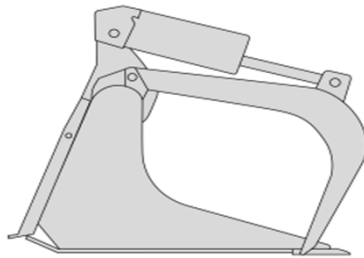

*Industrial Bucket Grapple*

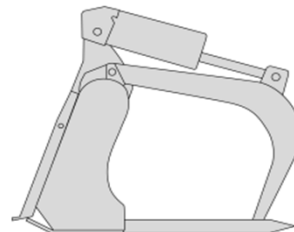

*Industrial Fork Grapple*

(463, S70)

**7135737**      **36" Industrial Bucket Grapple**  
(Bolt-On Cutting Edge included)

**\$1,795.00**      **24.0%**      **\$0.00**      **\$1,364.20**

(553, S100) (T110)

**7140888**      **48" Industrial Bucket Grapple**  
(Bolt-On Cutting Edge included)

**\$2,015.00**      **24.0%**      **\$0.00**      **\$1,531.40**

(S130, S510, S550, S530, S570, S590) (T140, T550, T590)

**7168342**      **62" Industrial Bucket Grapple**  
(Bolt-On Cutting Edge included)

**\$3,215.00**      **24.0%**      **\$0.00**      **\$2,443.40**

(S130, S510, S550, S530, S570, S590, S220, S250, S300, S330) (S630, S650, S750, S770)

(T140, T550, T590) (T630, T650)

7168340      **68" Industrial Bucket Grapple**      \$3,385.00      24.0%      \$0.00      \$2,572.60  
(Bolt-On Cutting Edge included)

(S130, S510, S550, S530, S570, S590, S220, S250, S300) (S630, S650, S750, S770)

(T140, T550, T590) (T630, T650)

7168344      **66" Industrial Fork Grapple, with 7 teeth**      \$3,958.00      24.0%      \$0.00      \$3,008.08

(S220, S250, S300, S330) (S630, S650, S750, S770) (A770) (T550, T590) (T630, T650)

7168290      **74" Industrial Bucket Grapple**      \$3,585.00      24.0%      \$0.00      \$2,724.60  
(Bolt-On Cutting Edge included)

(S220, S250, S300, S330) (S630, S650, S750, S770, S850) (A300) (A770)

(T250, T300, T320) (T630, T650, T750, T770, T870)

7166624      **78" Industrial Fork Grapple, with 8 teeth**      \$5,095.00      24.0%      \$0.00      \$3,872.20

(S220, S250, S300, S330) (S630, S650, S750, S770, S850) (A300) (A770)

(T250, T300, T320) (T630, T650, T750, T770, T870)

7168339      **80" Industrial Bucket Grapple**      \$4,895.00      24.0%      \$0.00      \$3,720.20  
(Bolt-On Cutting Edge included)

It is recommended that a port relief be installed for use with grapples. Installation instructions are included in the Operation Manual.

Optional Open/Close Restrictor is available to slow down the open/close functions of the combination bucket.

Part Number	Grapple, Root Description	SLP in US\$	Discount Percent	Labor	Price
-------------	---------------------------	-------------	------------------	-------	-------

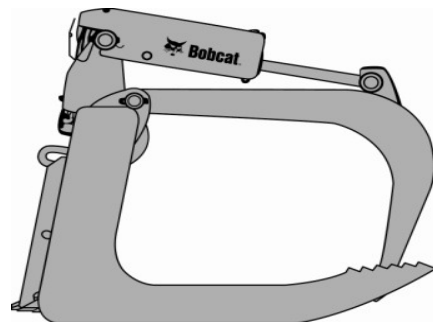

(463, S70)

7134179      **36" Root Grapple**      \$1,825.00      24.0%      \$0.00      \$1,387.00

(553, S100) (T110)					
7140902	48" Root Grapple	\$2,148.00	24.0%	\$0.00	\$1,632.48
(S510, S550, S530, S570, S590) (T140, T550, T590)					
7168343	66" Root Grapple	\$2,936.00	24.0%	\$0.00	\$2,231.36
(S530, S570, S590, S220, S250, S300, S330) (S630, S650, S750, S770) (A300) (A770)					
(T550, T590, T250, T300, T320) (T630, T650, T750, T770)					
7165486	72" Root Grapple	\$3,229.00	24.0%	\$0.00	\$2,454.04
(S530, S570, S590, S220, S250, S300, S330) (S630, S650, S750, S770, S850) (A300) (A770)					
(T550, T590, T250, T300, T320) (T630, T650, T750, T770, T870)					
7168338	82" Root Grapple	\$3,513.00	24.0%	\$0.00	\$2,669.88

It is recommended that a port relief be installed for use with grapples. Installation instructions are included in the Operation Manual.  
Optional Open/Close Restrictor is available to slow down the open/close functions of the combination bucket.

Part Number	Landplane Description	SLP in US\$	Discount Percent	Labor	Price
-------------	-----------------------	-------------	------------------	-------	-------

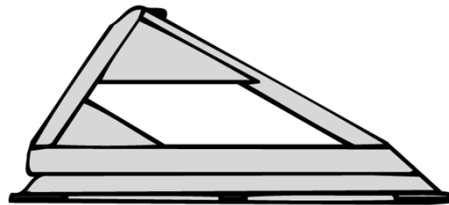

(463, S70, 553, S100) (T110)					
6907173	48" Deluxe Landplane Leveling Attachment (Includes expanded metal grate, scarifier assembly, teeth and respective hardware)	\$1,155.00	24.0%	\$0.00	\$877.80
6959099	48" Basic Landplane Leveling Attachment (Does not include expanded metal grate, scarifier assembly, teeth or respective hardware)	\$762.00	24.0%	\$0.00	\$579.12
(553, S100, S130, S510, S550, S530, S570, S590, S220, S250, S300, S330) (S630, S650, S750, S770) (A770) (T110, T140, T550, T590) (T630, T650)					
6906150	72" Deluxe Landplane Leveling Attachment (Includes expanded metal grate, scarifier assembly, teeth and respective hardware)	\$1,999.00	24.0%	\$0.00	\$1,519.24
6959098	72" Basic Landplane Leveling Attachment (Does not include expanded metal grate, scarifier assembly, teeth or respective hardware)	\$1,329.00	24.0%	\$0.00	\$1,010.04



(S130, S510, S550, S530, S570, S590, S220, S250, S300, S330) (S630, S650, S750, S770)

(A300) (A770) (T140, T550, T590, T250, T300, T320) (T630, T650, T750, T770)

<b>6906115</b>	<b>78" Deluxe Landplane Leveling Attachment</b> (Includes expanded metal grate, scarifier assembly, teeth and respective hardware)	<b>\$2,128.00</b>	<b>24.0%</b>	<b>\$0.00</b>	<b>\$1,617.28</b>
----------------	---	-------------------	--------------	---------------	-------------------

<b>6959097</b>	<b>78" Basic Landplane Leveling Attachment</b> (Does not include expanded metal grate, scarifier assembly, teeth or respective hardware)	<b>\$1,444.00</b>	<b>24.0%</b>	<b>\$0.00</b>	<b>\$1,097.44</b>
----------------	---	-------------------	--------------	---------------	-------------------

<b>Part Number</b>	<b>Landscape Rake Description</b>	<b>SLP in US\$</b>	<b>Discount Percent</b>	<b>Labor</b>	<b>Price</b>
--------------------	-----------------------------------	--------------------	-------------------------	--------------	--------------

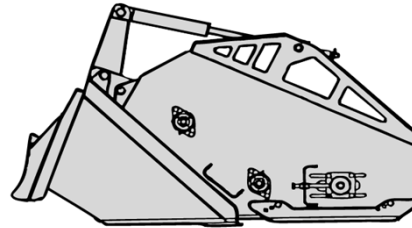

(S130, S510, S550, S530, S570, S590) (S630, S650) (T140, T550, T590) (T630, T650)

<b>6709107</b>	<b>5B Landscape Rake</b>	<b>\$7,425.00</b>	<b>24.0%</b>	<b>\$0.00</b>	<b>\$5,643.00</b>
----------------	--------------------------	-------------------	--------------	---------------	-------------------

(S510, S550, S530, S570, S590, S220, S250, S300, S330) (S630, S650, S750, S770)

(A300) (A770) (T550, T590, T250, T300, T320) (T630, T650, T750, T770)

<b>6710630</b>	<b>6B Landscape Rake</b>	<b>\$7,941.00</b>	<b>24.0%</b>	<b>\$0.00</b>	<b>\$6,035.16</b>
----------------	--------------------------	-------------------	--------------	---------------	-------------------

Also order Inline Restrictor P/N 6631698 and Adapter P/N 1312113 when installing a Landscape Rake on a 40 series loader.

Part Number	Mower, Finish Description	SLP in US\$	Discount Percent	Labor	Price
-------------	------------------------------	-------------	---------------------	-------	-------

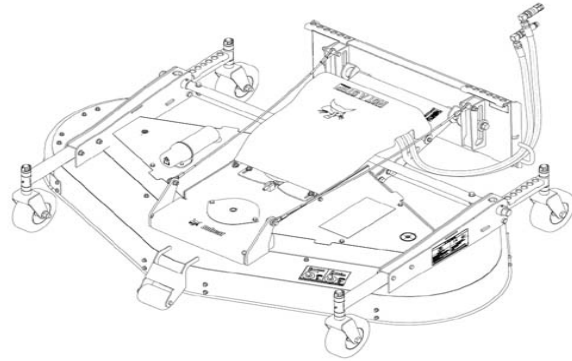

(S100, S130, S510, S550, S530, S570, S590, S220, S250, S300, S330)  
(S630, S650, S750, S770)

(A300) (A770) (T110, T140, T550, T590, T250, T300, T320) (T630, T650, T750, T770)  
7144850 72" Mower

\$4,893.00 24.0% \$0.00 \$3,718.68

(S510, S550, S530, S570, S590, S220, S250, S300, S330) (S630, S650, S750, S770, S850)  
(A300) (A770) (T550, T590, T250, T300, T320) (T630, T650, T750, T770, T870)

7143993 90" Mower

\$5,356.00 24.0% \$0.00 \$4,070.56

Part Number	Packer Wheel Description	SLP in US\$	Discount Percent	Labor	Price
-------------	-----------------------------	-------------	---------------------	-------	-------

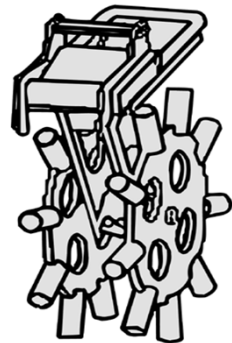

553, S130, S510, S550, S530, S570, S590, S220, S250, S300, S330)  
(S630, S650, S750, S770, S850) (A300) (A770) (T140, T550, T590, T250, T300, T320)  
(T630, T650, T750, T770, T870)

6806644

**Packer Wheel**

(Must also order loader x-change mounting frame p/n 7141800)

**\$1,894.00**

**24.0%**

**\$0.00**

**\$1,439.44**

<b>Part Number</b>	<b>Accessories Description</b>	<b>SLP in US\$</b>	<b>Discount Percent</b>	<b>Labor</b>	<b>Price</b>
------------------------	------------------------------------	--------------------	-----------------------------	--------------	--------------

7141800	Loader X-Change Mounting Frame	\$975.00	24.0%	\$0.00	\$741.00
---------	--------------------------------	----------	-------	--------	----------

Part Number	Pallet Forks Description	SLP in US\$	Discount Percent	Labor	Price
-------------	--------------------------	-------------	------------------	-------	-------

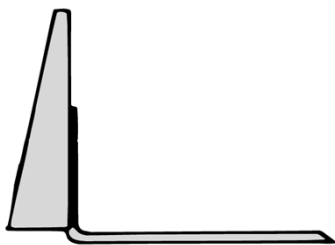

*Standard Pallet Fork Teeth and Frame*

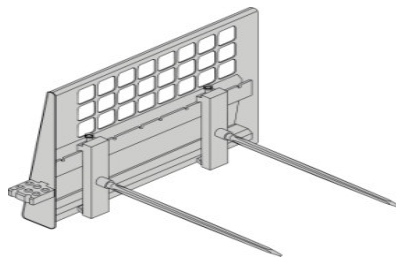

*Bale Forks and Frame*

(463, S70) 6809716	Pallet Fork Frame, less teeth	\$426.00	24.0%	\$0.00	\$323.76
6540185	30" Pallet Fork Teeth, Set of 2	\$357.00	24.0%	\$0.00	\$271.32
6540184	36" Pallet Fork Teeth, Set of 2	\$376.00	24.0%	\$0.00	\$285.76
(553, S100, S130, S510, S55 (T110, T140, T550, T590) (T630, T650)					
6712927	Pallet Fork Frame, less teeth	\$426.00	24.0%	\$0.00	\$323.76
<i><u>Bale Forks</u></i>					
6815781	Bale Forks, Set of 2	\$557.00	24.0%	\$0.00	\$423.32
<i><u>Pallet Forks</u></i>					
6540183	42" Pallet Fork Teeth, Set of 2	\$358.00	24.0%	\$0.00	\$272.08
6540182	48" Pallet Fork Teeth, Set of 2	\$379.00	24.0%	\$0.00	\$288.04
(S220, S250, S300, S330) (S630, S650, S750, S770, S850) (T250, T300, T320) (T630, T650, T750, T770, T870) (A300) (A770)					
7109332	Pallet Fork Frame, Heavy Duty, less teeth	\$1,151.00	24.0%	\$0.00	\$874.76
<i><u>Bale Forks</u></i>					
6815781	Bale Forks, Set of 2	\$557.00	24.0%	\$0.00	\$423.32
<i><u>Pallet Forks</u></i>					

6541521	42" Pallet Fork Teeth, Set of 2	\$521.00	24.0%	\$0.00	\$395.96
6541518	48" Pallet Fork Teeth, Set of 2	\$549.00	24.0%	\$0.00	\$417.24

Part Number	Pallet Forks, Hydraulic Description	SLP in US\$	Discount Percent	Labor	Price
-------------	-------------------------------------	-------------	------------------	-------	-------

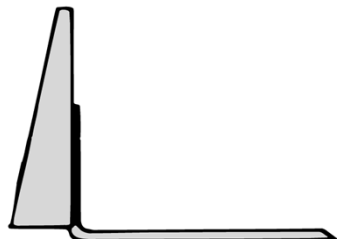

(S130, S510, S550, S530, S570, S590, S220, S250, S300, S330) (A300) (A770)  
(S630, S650, S750, S770, S850)

(T140, T550, T590, T250, T300, T320) (T630, T650, T750, T770, T870)

6905492	42" Hydraulic Pallet Fork (Includes back frame and 2 hydraulically adjustable 42" teeth)	\$2,799.00	24.0%	\$0.00	\$2,127.24
---------	---	------------	-------	--------	------------

6905425	48" Hydraulic Pallet Fork (Includes back frame and 2 hydraulically adjustable 48" teeth)	\$2,899.00	24.0%	\$0.00	\$2,203.24
---------	---	------------	-------	--------	------------

Part Number	Planer Description	SLP in US\$	Discount Percent	Labor	Price
-------------	--------------------	-------------	------------------	-------	-------

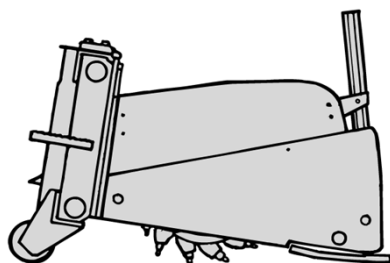

(S130, S510, S550, S530, S570, S590, S220, S250, S300, S330) (S630, S650, S750, S770)  
(A300) (A770) (T140, T550, T590, T250, T300, T320) (T630, T650, T750, T770)

M7019	<b>14" Planer, Standard Flow</b> (Includes manual depth adjust, hydraulic sideshift, and hoses) Must also order a drum. (No Attachment Control Kit is required)	\$8,303.00	24.0%	\$0.00	\$6,310.28
-------	---	------------	-------	--------	------------

**Drums for 14" Planers - MUST order one of the following drum options**

<b>M7019-R01-C02</b>	<b>2 ½" Slot Cut Drum</b> (With 21 bits) (Ship Weight 95 lbs.)	<b>\$1,195.00</b>	<b>24.0%</b>	<b>\$0.00</b>	<b>\$908.20</b>
<b>M7019-R01-C04</b>	<b>4" Slot Cut Drum</b> (With 24 bits) (Ship Weight 111 lbs.)	<b>\$1,328.00</b>	<b>24.0%</b>	<b>\$0.00</b>	<b>\$1,009.28</b>
<b>M7019-R01-C01</b>	<b>6" All Purpose Drum</b> (With 32 bits) (Ship Weight 165 lbs.)	<b>\$1,735.00</b>	<b>24.0%</b>	<b>\$0.00</b>	<b>\$1,318.60</b>
<b>M7019-R01-C05</b>	<b>8" All Purpose Drum</b> (With 34 bits) (Ship Weight 189 lbs.)	<b>\$1,735.00</b>	<b>24.0%</b>	<b>\$0.00</b>	<b>\$1,318.60</b>
<b>M7019-R01-C06</b>	<b>12" All Purpose Drum</b> (With 40 bits) (Ship Weight 245 lbs.)	<b>\$2,169.00</b>	<b>24.0%</b>	<b>\$0.00</b>	<b>\$1,648.44</b>
<b>M7019-R01-C03</b>	<b>14" All Purpose Drum</b> (With 46 bits) (Ship Weight 260 lbs.)	<b>\$2,292.00</b>	<b>24.0%</b>	<b>\$0.00</b>	<b>\$1,741.92</b>

(S550H, S530H, S570H, S590H, S220H, S250H, S300H, S330H)  
(S630H, S650H, S750H, S770H, S850H) (A300H) (A770H)  
(T550H, T590H, T250H, T300H, T320H) (T630H, T650H, T750H, T770H, T870H)

<b>M7018</b>	<b>18" Planer, High Flow</b> (Includes hydraulic depth adjust, hydraulic sideshift, and hoses) (Must also order drum) (Loader must be equipped with an Attachment Control Kit) (When used on loaders equipped with a 14-Pin Attachment Control Kit , a 14-Pin Attachment T-Harness Kit P/N 7164095 is required)	<b>\$12,277.00</b>	<b>24.0%</b>	<b>\$0.00</b>	<b>\$9,330.52</b>
--------------	---	--------------------	--------------	---------------	-------------------

**Drums for 18" Planers - MUST order one of the following drum options**

<b>M7018-R01-C02</b>	<b>2 ½" Slot Cut Drum</b> (With 21 bits) (Ship Weight 95 lbs.)	<b>\$1,195.00</b>	<b>24.0%</b>	<b>\$0.00</b>	<b>\$908.20</b>
<b>M7018-R01-C05</b>	<b>4" Slot Cut Drum</b> (With 24 bits) (Ship Weight 111 lbs.)	<b>\$1,328.00</b>	<b>24.0%</b>	<b>\$0.00</b>	<b>\$1,009.28</b>
<b>M7018-R01-C01</b>	<b>6" All Purpose Drum</b> (With 32 bits) (Ship Weight 165 lbs.)	<b>\$1,735.00</b>	<b>24.0%</b>	<b>\$0.00</b>	<b>\$1,318.60</b>
<b>M7018-R01-C06</b>	<b>8" All Purpose Drum</b> (With 34 bits) (Ship Weight 189 lbs.)	<b>\$1,735.00</b>	<b>24.0%</b>	<b>\$0.00</b>	<b>\$1,318.60</b>
<b>M7018-R01-C07</b>	<b>12" All Purpose Drum</b> (With 40 bits) (Ship Weight 245 lbs.)	<b>\$2,169.00</b>	<b>24.0%</b>	<b>\$0.00</b>	<b>\$1,648.44</b>
<b>M7018-R01-C03</b>	<b>14" All Purpose Drum</b> (With 46 bits) (Ship Weight 260 lbs.)	<b>\$2,292.00</b>	<b>24.0%</b>	<b>\$0.00</b>	<b>\$1,741.92</b>
<b>M7018-R01-C04</b>	<b>16" Surface Drum</b> (With 84 bits) (Ship Weight 330 lbs.)	<b>\$4,957.00</b>	<b>24.0%</b>	<b>\$0.00</b>	<b>\$3,767.32</b>
<b>M7018-R01-C09</b>	<b>16" Fast Cut All Purpose Drum</b> (With 47 bits) (Ship Weight 266 lbs.)	<b>\$2,851.00</b>	<b>24.0%</b>	<b>\$0.00</b>	<b>\$2,166.76</b>

M7018-R01-C08	<b>16" Smooth Cut All Purpose Drum</b> (With 84 bits) (Ship Weight 322 lbs.)	\$3,594.00	24.0%	\$0.00	\$2,731.44
M7018-R01-C10	<b>18" Fast Cut All Purpose Drum</b> (With 47 bits) (Ship Weight 285 lbs.)	\$2,911.00	24.0%	\$0.00	\$2,212.36
M7018-R01-C11	<b>18" Smooth Cut All Purpose Drum</b> (With 84 bits) (Ship Weight 340 lbs.)	\$3,718.00	24.0%	\$0.00	\$2,825.68

(S530H, S570H, S590H, S220H, S250H, S300H, S330H) (S630H, S650H, S750H, S770H, S850H) (A300H) (A770H) (T550H, T590H, T250H, T300H, T320H) (T630H, T650H, T750H, T770H, T870H)

M7017	<b>24" Planer, High Flow</b> (Includes hydraulic depth adjust, hydraulic sideshift, and hoses) (Must also order drum) (Loader must be equipped with an Attachment Control Kit) (When used on loaders equipped with a 14-Pin Attachment Control Kit , a 14-Pin Attachment T-Harness Kit P/N 7164095 is required)	\$14,867.00	24.0%	\$0.00	\$11,298.92
-------	---	-------------	-------	--------	-------------

**Drums for 24" Planers - MUST order one of the following drum options**

M7019-R01-C02	<b>2 ½" Slot Cut Drum</b> (With 21 bits) (Ship Weight 95 lbs.)	\$1,195.00	24.0%	\$0.00	\$908.20
M7019-R01-C05	<b>4" Slot Cut Drum</b> (With 24 bits) (Ship Weight 111 lbs.)	\$1,328.00	24.0%	\$0.00	\$1,009.28
M7019-R01-C01	<b>6" All Purpose Drum</b> (With 32 bits) (Ship Weight 165 lbs.)	\$1,735.00	24.0%	\$0.00	\$1,318.60
M7019-R01-C06	<b>8" All Purpose Drum</b> (With 34 bits) (Ship Weight 189 lbs.)	\$1,735.00	24.0%	\$0.00	\$1,318.60
M7019-R01-C07	<b>12" All Purpose Drum</b> (With 40 bits) (Ship Weight 245 lbs.)	\$2,169.00	24.0%	\$0.00	\$1,648.44
M7019-R01-C03	<b>14" All Purpose Drum</b> (With 46 bits) (Ship Weight 260 lbs.)	\$2,292.00	24.0%	\$0.00	\$1,741.92
M7019-R01-C14	<b>16" Surface Drum</b> (With 84 bits) (Ship Weight 330 lbs.)	\$4,957.00	24.0%	\$0.00	\$3,767.32
M7019-R01-C09	<b>16" Fast Cut All Purpose Drum</b> (With 47 bits) (Ship Weight 266 lbs.)	\$2,851.00	24.0%	\$0.00	\$2,166.76
M7019-R01-C08	<b>16" Smooth Cut All Purpose Drum</b> (With 84 bits) (Ship Weight 322 lbs.)	\$3,594.00	24.0%	\$0.00	\$2,731.44
M7019-R01-C10	<b>18" Fast Cut All Purpose Drum</b> (With 47 bits) (Ship Weight 285 lbs.)	\$2,911.00	24.0%	\$0.00	\$2,212.36
M7019-R01-C11	<b>18" Smooth Cut All Purpose Drum</b> (With 84 bits) (Ship Weight 340 lbs.)	\$3,718.00	24.0%	\$0.00	\$2,825.68
M7019-R01-C04	<b>24" Fast Cut All Purpose Drum</b>	\$3,947.00	24.0%	\$0.00	\$2,999.72

<b>M7019-R01-C12</b>	(With 57 bits) (Ship Weight 375 lbs.) <b>24" Smooth Cut All Purpose Drum</b> (With 124 bits) (Ship Weight 420 lbs.)	<b>\$4,957.00</b>	<b>24.0%</b>	<b>\$0.00</b>	<b>\$3,767.32</b>
<b>(S220H, S250H, S300H, S330H) (S630H, S650H, S750H, S770H, S850H) (A300H) (A770H) (T250H, T300H, T320H) (T630H, T650H, T750H, T770H, T870H)</b>					
<b>6726632</b>	<b>40" Planer, High Flow</b> (Includes hydraulic depth adjust, 40" drum, hydraulic sideshift, hydraulic oscillation & hoses) (Loader must be equipped with an Attachment Control Kit) (When used on loaders equipped	<b>\$24,763.00</b>	<b>24.0%</b>	<b>\$0.00</b>	<b>\$18,819.88</b>





Bobcat Rock Buckets work excellent for separating unwanted objects, such as rocks and other debris, from work areas while leaving finer material behind that can be cultivated or landscaped. Each tine tip is fully gusseted on each side, and connected to the tip next to it. This allows the Bobcat Rock Bucket to be used effectively as a tool to clear the soil surface of vegetation or other debris, as well as to be used to pull up objects from below the ground surface.

Part Number	Scarifier Description	SLP in US\$	Discount Percent	Labor	Price
-------------	-----------------------	-------------	------------------	-------	-------

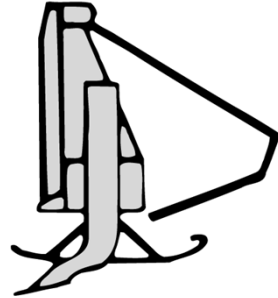

(553, S130, S510, S550, S530, S570, S590, S220, S250, S300, S330) (S630, S650, S750, S770)  
 (A770) (T110, T140, T550, T590) (T630, T650)

6563526	Front Scarifier (Includes 2 Depth Guides and 5 Teeth)	\$891.00	24.0%	\$0.00	\$677.16
---------	--	----------	-------	--------	----------

Part Number	Scraper Description	SLP in US\$	Discount Percent	Labor	Price
-------------	---------------------	-------------	------------------	-------	-------

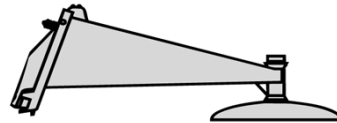

(S70)  
 6907177 Mini Scraper

(S100, S130, S510, S550, S530, S570, S590, S220, S250, S300, S330)  
 (S630, S650, S750, S770) (A300) (A770) (T110, T140, T550, T590, T250, T300, T320)  
 (T630, T650, T750, T770)

		\$706.00	24.0%	\$0.00	\$536.56
--	--	----------	-------	--------	----------

6675211	Scraper	\$1,132.00	24.0%	\$0.00	\$860.32
---------	---------	------------	-------	--------	----------

Part Number	Seeder Description	SLP in US\$	Discount Percent	Labor	Price
-------------	--------------------	-------------	------------------	-------	-------

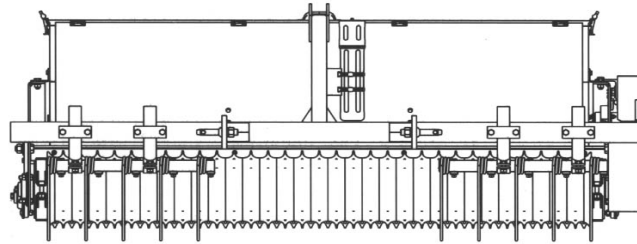

(S130, S510, S550, S530, S570, S590, S220, S250, S300, S330) (S630, S650, S750, S770)  
 (A300) (A770) (T140, T550, T590, T250, T300, T320) (T630, T650, T750, T770)

7167712	<b>Seeder, 72", 3PT Mounting</b> (Must also order Bob-Tach adapter)	\$6,587.00	24.0%	\$0.00	\$5,006.12
---------	--	------------	-------	--------	------------

Part Number	Factory Installed Options Description	SLP in US\$	Discount Percent	Labor	Price
-------------	---------------------------------------	-------------	------------------	-------	-------

7167758	<b>Bob-Tach Adapter</b> (Allows Seeder to mount on Bob-Tach equipped machines)	\$664.00	24.0%	\$0.00	\$504.64
---------	---	----------	-------	--------	----------

Part Number	Silt Fence Installer Description	SLP in US\$	Discount Percent	Labor	Price
-------------	----------------------------------	-------------	------------------	-------	-------

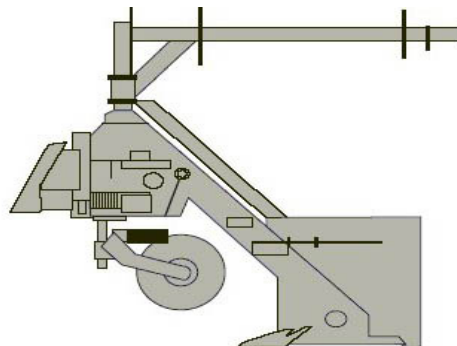

S220, S250, S300, S330) (S630, S650, S750, S770, S850) (A300) (A770)  
 (T550, T590, T250, T300, T320) (T630, T650, T750, T770, T870)

7137320	<b>Silt Fence Installer</b> (Must also order mounting frame)	\$4,738.00	24.0%	\$0.00	\$3,600.88
---------	---	------------	-------	--------	------------

Part Number	Factory Installed Options Description	SLP in US\$	Discount Percent	Labor	Price
7137333	<b>Loader Rigid Mounting Frame</b>	\$1,159.00	24.0%	\$0.00	\$880.84
7139171	<b>3-Point Rigid Mounting Frame</b> (Must also order Adapter p/n 7137334)	\$1,107.00	24.0%	\$0.00	\$841.32
7137332	<b>3-Point Mounting Frame, 72" Side-Shift</b> (Must also order Adapter p/n 7137334)	\$2,177.00	24.0%	\$0.00	\$1,654.52
7137331	<b>3-Point Mounting Frame, 84" Side-Shift</b> (Must also order Adapter p/n 7137334)	\$2,327.00	24.0%	\$0.00	\$1,768.52

Part Number	Snow Blade Description	SLP in US\$	Discount Percent	Labor	Price
-------------	------------------------	-------------	------------------	-------	-------

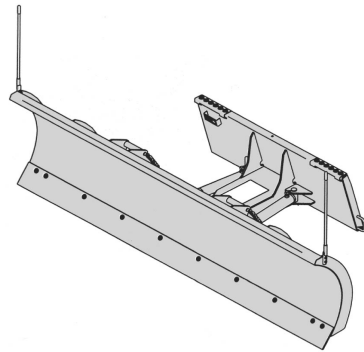

(463, S70)					
7196165	<b>54" Utility Blade (with hydraulic angle)</b> (To be used as either a Snow Blade or a Dozer Blade)	\$1,378.00	24.0%	\$0.00	\$1,047.28

(553, S100, S130, S510, S550) (T110)					
6906107	<b>60" Snow Blade (with hydraulic angle)</b>	\$2,002.00	24.0%	\$0.00	\$1,521.52

(553, S100, S130, S510, S550, S530, S570, S590) (S630, S650) (T110)					
6905156	<b>72" Snow Blade (with hydraulic angle)</b>	\$2,159.00	24.0%	\$0.00	\$1,640.84

(S130, S510, S550, S530, S570, S590, S220, S250, S300) (S630, S650, S750, S770)  
 (A300) (A770)

6716836 84" Snow Blade (with hydraulic angle) \$2,356.00 24.0% \$0.00 \$1,790.56

(S220, S250, S300, S330) (S630, S650, S750, S770) (A300) (A770)

6716838 96" Snow Blade (with hydraulic angle) \$2,452.00 24.0% \$0.00 \$1,863.52

(S130, S510, S550, S530, S570, S590, S220) (S630, S650) (T140, T550, T590) (T630, T650)

7131132 86" Snow Blade – Heavy Duty (with hydraulic angle) \$3,715.00 24.0% \$0.00 \$2,823.40

(S130, S510, S550, S530, S570, S590, S220, S250, S300, S330) (S630, S650, S750, S770)

(A300) (A770) (T140, T550, T590, T250, T300, T320) (T630, T650, T750, T770)

7161181 96" Snow Blade – Heavy Duty (with hydraulic angle) \$3,809.00 24.0% \$0.00 \$2,894.84

(S510, S550, S530, S570, S590, S220, S250, S300, S330) (S630, S650, S750, S770, S850)

(A300) (A770) (T550, T590, T250, T300, T320) (T630, T650, T750, T770, T870)

7161174 108" Snow Blade – Heavy Duty (with hydraulic angle) \$4,168.00 24.0% \$0.00 \$3,167.68

Part Number	Accessories Description	SLP in US\$	Discount Percent	Labor	Price
-------------	-------------------------	-------------	------------------	-------	-------

6716834 End Wing Kit \$384.00 24.0% \$0.00 \$291.84  
 (Converts 84" & 96" Snow Blades in to Snow Pushers)  
 (Not for use on 60" or 72" Snow Blades) (Not for use on Heavy Duty Snow Blades)  
 (Ship Weight 95 lbs.)

Part Number	Snow Pusher Description	SLP in US\$	Discount Percent	Labor	Price
-------------	-------------------------	-------------	------------------	-------	-------

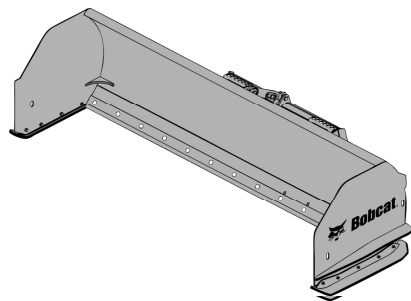

(S130, S510, S550, S530, S570, S590, S220, S250, S300, S330) (S630, S650, S750, S770, S850)

(A300) (A770) (T140, T550, T590, T250, T300, T320) (T630, T650, T750, T770, T870)

7113767 Snow Pusher, 8' \$3,094.00 24.0% \$0.00 \$2,351.44

(S590, S220, S250, S300, S330) (S630, S650, S750, S770, S850) (A300) (A770)

(T550, T590, T250, T300, T320) (T630, T650, T750, T770, T870)

7116164 Snow Pusher, 10' \$3,405.00 24.0% \$0.00 \$2,587.80

Part Number	Snow V-Blade Description	SLP in US\$	Discount Percent	Labor	Price
-------------	--------------------------	-------------	------------------	-------	-------



Blade in "V" Configuration

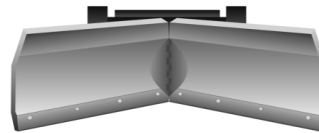

Blade in "Scoop" Configuration

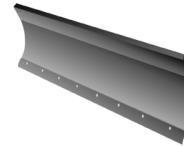

Blade in "Angled" Configuration

(463, S70, 553, S100) (T110)

6958575 60" Snow V-Blade \$3,444.00 24.0% \$0.00 \$2,617.44

(Loader must be equipped with a 14-Pin Attachment Control Kit (P/N 6729313))

(S130, S510, S550, S530, S570, S590) (T140)

7104861 60" Snow V-Blade, 7-Pin \$3,819.00 24.0% \$0.00 \$2,902.44

(Loader must be equipped with an Attachment Control Kit)

Blade is equipped with fingertip 7-Pin Control. Adjustable blade width from 53-60 inches.

(S130, S510, S550, S530, S570, S590) (T140, T550, T590)

6958576 72" Snow V-Blade \$4,079.00 24.0% \$0.00 \$3,100.04

(Loader must be equipped with an Attachment Control Kit) (When used on loaders equipped with a 14-Pin Attachment Control Kit a 14-Pin Attachment T-Harness Kit (P/N 6725383) is required)

(S130, S510, S550, S530, S570, S590, S220, S250, S300, S330) (S630, S650, S750, S770)

(A300) (A770) (T140, T550, T590, T250, T300, T320) (T630, T650, T750, T770)

6958577 84" Snow V-Blade \$4,171.00 24.0% \$0.00 \$3,169.96

(Loader must be equipped with an Attachment Control Kit) (When used on loaders equipped with a 14-Pin Attachment Control Kit a 14-Pin Attachment T-Harness Kit (P/N 6725383) is required)

(S530, S570, S590, S220, S250, S300, S330) (S630, S650, S750, S770) (A300) (A770)

(T550, T590, T250, T300, T320) (T630, T650, T750, T770)

6958578 96" Snow V-Blade \$4,266.00 24.0% \$0.00 \$3,242.16

(Loader must be equipped with an Attachment Control Kit) (When used on loaders equipped with a 14-Pin Attachment Control Kit a 14-Pin Attachment T-Harness Kit

(P/N 6725383) is required)

(S220, S250, S300, S330) (S630, S650, S750, S770) (A300) (A770)

(T250, T300, T320) (T630, T650, T750, T770)

<b>6958579</b>	<b>108" Snow V-Blade</b>	<b>\$4,358.00</b>	<b>24.0%</b>	<b>\$0.00</b>	<b>\$3,312.08</b>
	(Loader must be equipped with an Attachment Control Kit) (When used on loaders equipped with a 14-Pin Attachment Control Kit a 14-Pin Attachment T-Harness Kit (P/N 6725383) is required)				

Part Number	Accessories Description	SLP in US\$	Discount Percent	Labor	Price
<b>7102606</b>	<b>Blade Flotation Option</b> (Allows blade to oscillate +/- 10 degrees, includes pin to lock in place at 0 degrees) (Approved for use with 72", 84", 96" and 108" Snow V-Blades) (The frame flotation mounts between the existing frame and blade and will extend the overall blade length eight-inches from the Bob-Tach.)	<b>\$819.00</b>	<b>24.0%</b>	<b>\$0.00</b>	<b>\$622.44</b>

Part Number	Snowblower Description	SLP in US\$	Discount Percent	Labor	Price
-------------	------------------------	-------------	------------------	-------	-------

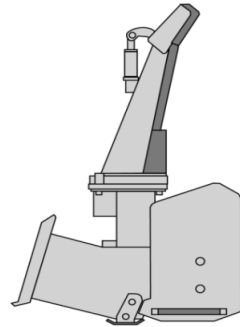

Part Number	SB150 Snowblower Description	SLP in US\$	Discount Percent	Labor	Price
(S70) <b>M7007</b>	<b>SB150 x 36"</b> (Loader must be equipped with a Bobcat 14-Pin Attachment Control Kit) (Snowblower includes hydraulic motor package)	<b>\$4,294.00</b>	<b>24.0%</b>	<b>\$0.00</b>	<b>\$3,263.44</b>

(S70, S100) (T110)					
M7008	<b>SB150 x 48"</b>		<b>\$4,435.00</b>	<b>24.0%</b>	<b>\$0.00</b>
	(Loader must be equipped with a Bobcat 14-Pin Attachment Control Kit)				
	(Snowblower includes hydraulic motor package)				<b>\$3,370.60</b>

Part Number	SB200 Snowblower Description	SLP in US\$	Discount Percent	Labor	Price
-------------	------------------------------	-------------	------------------	-------	-------

**Preferred Hydraulic Motor Package (BOLD)**  
*Must order a hydraulic motor package with the SB200 & SB240 Snowblowers*  
*Loader must be equipped with a 7-pin Attachment Control Kit*

(S130, S510*, S550*, S550H*, S530*, S570*, S570H*)					
M7001	<b>SB200 x 60" Snowblower</b>		<b>\$4,209.00</b>	<b>24.0%</b>	<b>\$0.00</b>
					<b>\$3,198.84</b>
M7001-R01-C01	5.5 Hydraulic Motor Package (S130, S510*, S550*, S530*, S570*)		<b>\$1,045.00</b>	<b>24.0%</b>	<b>\$0.00</b>
					<b>\$794.20</b>
M7001-R01-C02	6.2 Hydraulic Motor Package (S130, S510*, S550*, S530*, S570*)		<b>\$1,045.00</b>	<b>24.0%</b>	<b>\$0.00</b>
					<b>\$794.20</b>
M7001-R01-C03	8.0 Hydraulic Motor Package (S550H*, S570H*)		<b>\$1,103.00</b>	<b>24.0%</b>	<b>\$0.00</b>
					<b>\$838.28</b>
M7001-R01-C04	9.6 Hydraulic Motor Package (S550H*, S570H*)		<b>\$1,166.00</b>	<b>24.0%</b>	<b>\$0.00</b>
					<b>\$886.16</b>

(S130, S510, S550, S550H, S530, S570, S570H, S590, S590H, S250*, S300*)					
(S630*, S630H*, S650*, S650H*, S750*, S770*) (T550, T550H, T590, T590H)					
M7002	<b>SB200 x 66" Snowblower</b>		<b>\$4,342.00</b>	<b>24.0%</b>	<b>\$0.00</b>
					<b>\$3,299.92</b>
M7002-R01-C01	5.5 Hydraulic Motor Package (S130, S510, S550, S530, S570, S590) (T550, T590)		<b>\$1,045.00</b>	<b>24.0%</b>	<b>\$0.00</b>
					<b>\$794.20</b>
M7002-R01-C02	6.2 Hydraulic Motor Package (S130, S510, S550, S530, S570, S590, S250*, S300*) (T550, T590)		<b>\$1,045.00</b>	<b>24.0%</b>	<b>\$0.00</b>
					<b>\$794.20</b>
M7002-R01-C03	8.0 Hydraulic Motor Package (S630*, S650*, S750*, S770*) (S550H, S570H, S590H) (T550H, T590H)		<b>\$1,103.00</b>	<b>24.0%</b>	<b>\$0.00</b>
					<b>\$838.28</b>
M7002-R01-C04	9.6 Hydraulic Motor Package (S550H, S570H, S590H, S630H*, S650H*) (T550H, T590H)		<b>\$1,166.00</b>	<b>24.0%</b>	<b>\$0.00</b>
					<b>\$886.16</b>

**\*Offset rims required**



**Preferred Hydraulic Motor Package (BOLD)**  
*Must order a hydraulic motor package with the SB200 Snowblowers*  
*Loader must be equipped with a 7-pin Attachment Control Kit*

(S130, S510, S550, S550H, S530, S570, S570H, S590, S590H, S250, S300, S330)					
(S630, S630H, S650, S650H, S750, S770) (A770) (T550, T550H, T590, T590H)					
(T630, T630H, T650, T650H, T750*, T770*)					
M7003	SB200 x 72" Snowblower	\$4,483.00	24.0%	\$0.00	\$3,407.08
M7003-R01-C01	5.5 Hydraulic Motor Package (S130, S510, S550, S530, S570, S590) (T550, T590)	\$1,045.00	24.0%	\$0.00	\$794.20
M7003-R01-C02	6.2 Hydraulic Motor Package (S130, S510, S550, S530, S570, S590, S250, S300, S330) (T550, T590)	\$1,045.00	24.0%	\$0.00	\$794.20
M7003-R01-C03	8.0 Hydraulic Motor Package (S630, S650, S750, S770) (A770) (T630, T650, T750*, T770*) (S550H, S570H, S590H) (T550H, T590H)	\$1,103.00	24.0%	\$0.00	\$838.28
M7003-R01-C04	9.6 Hydraulic Motor Package (S550H, S570H, S590H, S630H, S650H) (T550H, T590H, T630H, T650H)	\$1,166.00	24.0%	\$0.00	\$886.16
(S510, S550, S550H, S530, S570, S570H, S590, S590H, S250, S300, S330)					
(S630, S630H, S650, S650H, S750, S770, S850) (A300) (A770)					
(T550, T550H, T590, T590H, T300, T320) (T630, T630H, T650, T650H, T750, T770)					
M7004	SB200 x 78" Snowblower	\$4,754.00	24.0%	\$0.00	\$3,613.04
M7004-R01-C02	6.2 Hydraulic Motor Package (S510, S550, S530, S570, S590, S250, S300, S330) (T550, T590, T300, T320) (A300)	\$1,045.00	24.0%	\$0.00	\$794.20
M7004-R01-C03	8.0 Hydraulic Motor Package (S630, S650, S750, S770, S850) (A770) (T630, T650, T750, T770) (S550H, S570H, S590H) (T550H, T590H)	\$1,103.00	24.0%	\$0.00	\$838.28
M7004-R01-C04	9.6 Hydraulic Motor Package (S550H, S570H, S590H, S630H, S650H) (T550H, T590H, T630H, T650H)	\$1,166.00	24.0%	\$0.00	\$886.16

Part Number	SB240 Snowblower Description	SLP in US\$	Discount Percent	Labor	Price
-------------	------------------------------	-------------	------------------	-------	-------

**Preferred Hydraulic Motor Package (BOLD)**  
*Must order a hydraulic motor package with the SB240 Snowblowers*  
*Loader must be equipped with a 7-pin Attachment Control Kit*

<b>(S550H, S570H, S590H) (S630H, S650H, S750, S770) (A770) (T550H, T590H)</b>					
<b>(T630H, T650H, T750*, T770*)</b>					
<b>M7005</b>	<b>SB240 x 72" Snowblower</b>	<b>\$5,998.00</b>	<b>24.0%</b>	<b>\$0.00</b>	<b>\$4,558.48</b>
M7005-R01-C03	8.0 Hydraulic Motor Package (S750, S770) (A770) (T750*, T770*) (S550H, S570H, S590H) (T550H, T590H)	\$1,071.00	24.0%	\$0.00	\$813.96
M7005-R01-C04	9.6 Hydraulic Motor Package (S550H, S570H, S590H, S630H, S650H) (T550H, T590H, T630H, T650H) * Narrow Track Option Required	\$1,132.00	24.0%	\$0.00	\$860.32
<b>Preferred Hydraulic Motor Package (BOLD)</b>					
<i>Must order a hydraulic motor package with the SB240 Snowblowers</i>					
<i>Loader must be equipped with a 7-pin Attachment Control Kit</i>					
<b>(S630H, S650H, S750, S770, S850) (A770) (T550H, T590H) (T630H, T650H, T750, T770, T870)</b>					
<b>M7006</b>	<b>SB240 x 84" Snowblower</b>	<b>\$6,127.00</b>	<b>24.0%</b>	<b>\$0.00</b>	<b>\$4,656.52</b>
M7006-R01-C03	8.0 Hydraulic Motor Package (S750, S770, S850) (A770) (T750, T770, T870) (T550H, T590H)	\$1,071.00	24.0%	\$0.00	\$813.96
M7006-R01-C04	9.6 Hydraulic Motor Package (S630H, S650H) (T550H, T590H, T630H, T650H)	\$1,132.00	24.0%	\$0.00	\$860.32

<b>Part Number</b>	<b>SBX240 Snowblower Description</b>	<b>SLP in US\$</b>	<b>Discount Percent</b>	<b>Labor</b>	<b>Price</b>
--------------------	--------------------------------------	--------------------	-------------------------	--------------	--------------

*Approved for use with loaders equipped with 37 GPM high flow only*

<b>(S250H, S300H, S330H) (S750H, S770H) (A300H) (A770H) (T300H, T320H)</b>					
<b>(T750H, T770H)</b>					
<b>M7009</b>	<b>SBX240 x 72"</b> (Approved for use with loaders equipped with high flow: S220 s/n 526214400 & above; S250 s/n 5260167000 & above; S300 s/n 525815600 & above; T250 s/n 525613400 & above T300 s/n 525414500 & above; A300 s/n 526412200 & above) (Snowblower includes hydraulic motor package)	<b>\$7,676.00</b>	<b>24.0%</b>	<b>\$0.00</b>	<b>\$5,833.76</b>
<b>(S250H, S300H, S330H) (S750H, S770H, S850H) (A300H) (A770H)</b>					
<b>(T300H, T320H) (T750H, T770H, T870H)</b>					
<b>M7010</b>	<b>SBX240 x 84" (blower includes hyd motor pkg)</b> (Approved for use with loaders equipped with high flow: S220 s/n 526214400 & above; S250 s/n 5260167000 & above; S300 s/n 525815600 & above; T250 s/n 525613400 & above;	<b>\$7,815.00</b>	<b>24.0%</b>	<b>\$0.00</b>	<b>\$5,939.40</b>

T300 s/n 525414500 & above; A300 s/n 526412200 & above)

Part Number	Accessories Description	SLP in US\$	Discount Percent	Labor	Price
6958978	<b>Truck Loading Chute</b> (For SB240 and SBX240 Snowblowers, will not fit SB200) (For use with high flow loaders only) (Includes deflector control, support mount and hoses) (Price includes \$270 for installation)	\$1,458.00	24.0%	\$270.00	\$1,378.08

Part Number	Sod Layer Description	SLP in US\$	Discount Percent	Labor	Price
-------------	-----------------------	-------------	------------------	-------	-------

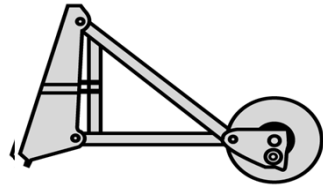

(S130, S510, S550, S530, S570, S590, S220, S250, S300, S330)  
 (S630, S650, S750, S770, S850)  
 (A300) (A770) (T140, T550, T590, T250, T300, T320) (T630, T650, T750, T770, T870)

6906783	Sod Layer	\$3,497.00	24.0%	\$0.00	\$2,657.72
---------	-----------	------------	-------	--------	------------

Part Number	Soil Conditioner Description	SLP in US\$	Discount Percent	Labor	Price
-------------	------------------------------	-------------	------------------	-------	-------

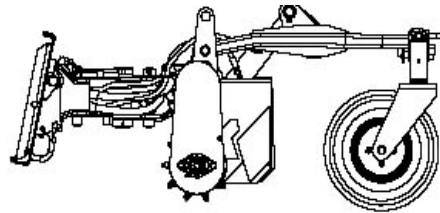

(463, S70, 553, S100) (T110)

6958310	48" Soil Conditioner, Manual Angle	\$5,833.00	24.0%	\$0.00	\$4,433.08
---------	------------------------------------	------------	-------	--------	------------

(553, S100, S130, S510, S550, S550H, S530, S570, S570H, S590, S590H)  
 (T110, T140, T550, T550H, T590, T590H)

7132966	60" Soil Conditioner, Manual Angle	\$6,404.00	24.0%	\$0.00	\$4,867.04
---------	------------------------------------	------------	-------	--------	------------

7140848	<b>60" Soil Conditioner, Hydraulic Angle and Depth</b> (Loader must be equipped with an Attachment Control Kit)	\$7,617.00	24.0%	\$0.00	\$5,788.92
(S130, S510, S550, S550H, S530, S570, S570H, S590, S590H, S220, S220H, S250, S250H, S300, S300H, S330, S330H) (S630, S630H, S650, S650H, S750, S750H, S770, S770H) (A300, A300H) (A770, A770H) (T140, T550, T550H, T590, T590H) (T630, T630H, T650, T650H)					
6906513	<b>72" Soil Conditioner, Manual Angle</b>	\$7,648.00	24.0%	\$0.00	\$5,812.48
7135945	<b>72" Soil Conditioner, Hydraulic Angle and Depth</b> (Loader must be equipped with an Attachment Control Kit)	\$8,685.00	24.0%	\$0.00	\$6,600.60
(S550H, S570H, S590H, S220H, S250H, S300H, S330H) (S630H, S650H, S750H, S770H) (A300H) (A770H) (T550H, T590H, T250H, T300H, T320H) (T630H, T650H, T750H, T770H)					
7135944	<b>72" Soil Conditioner, High Flow Hydraulic Angle and Depth</b> (Loader must be equipped with an Attachment Control Kit)	\$8,949.00	24.0%	\$0.00	\$6,801.24
(S530, S570, S570H, S590, S590H, S220, S220H, S250, S250H, S300, S300H, S330, S330H) (S630, S630H, S650, S650H, S750, S750H, S770, S770H, S850) (A300, A300H) (A770, A770H) (T550, T550H, T590, T590H, T250, T250H, T300, T300H, T320, T320H) (T630, T630H, T650, T650H, T750, T750H, T770, T770H, T870)					
7135946	<b>84" Soil Conditioner, Hydraulic Angle and depth</b> (Loader must be equipped with an Attachment Control Kit)	\$9,043.00	24.0%	\$0.00	\$6,872.68
(S220H, S250H, S300H, S330H) (S630H, S650H, S750H, S770H, S850H) (A300H) (A770H)(T250H, T300H, T320H) (T630H, T650H, T750H, T770H, T870H)					
7135947	<b>84" Soil Conditioner, High Flow Hydraulic Angle and Depth</b> (Loader must be equipped with an Attachment Control Kit)	\$9,385.00	24.0%	\$0.00	\$7,132.60

Part Number	Spreader Description	SLP in US\$	Discount Percent	Labor	Price
-------------	----------------------	-------------	------------------	-------	-------

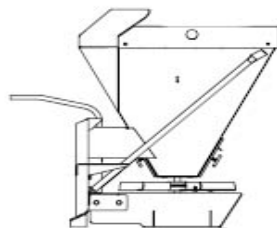

(S130, S510, S550, S530, S570, S590, S220, S250, S300, S330)  
 (S630, S650, S750, S770, S850) (A300) (A770)  
 (T140, T550, T590, T250, T300, T320) (T630, T650, T750, T770, T870)

6731612	<b>SP5 Spreader</b> (Must also order either loader mounting kit or truck mounting kit)	\$1,575.00	24.0%	\$0.00	\$1,197.00
---------	---	------------	-------	--------	------------

(S130, S510, S550, S530, S570, S590, S220, S250, S300, S330)  
 (S630, S650, S750, S770, S850) (A300) (A770)  
 (T140, T550, T590, T250, T300, T320) (T630, T650, T750, T770, T870)

7157284	<b>HS8 Spreader</b>	\$3,255.00	24.0%	\$0.00	\$2,473.80
---------	---------------------	------------	-------	--------	------------

Part Number	Accessories Description	SLP in US\$	Discount Percent	Labor	Price
-------------	-------------------------	-------------	------------------	-------	-------

*SP5 Spreader*

6731700	<b>Loader Mounting Kit</b> (Includes loader mount, control box and wiring harness) (Ship Weight 125 lbs.) <i>(Price includes \$225 for installation)</i>	\$613.00	24.0%	\$225.00	\$690.88
6731702	<b>Adjustable Deflector</b> (For additional control of the spread pattern) (Ship Weight 4 lbs.)	\$122.00	24.0%	\$0.00	\$92.72
6731703	<b>Gate Assembly Kit</b> (This kit is recommended when applying fine granular materials such as seed and fertilizer. The gate assembly controls and meters the material flow so a more precise rate is achieved) (Ship Weight 6 lbs.)	\$185.00	24.0%	\$0.00	\$140.60
6731705	<b>Vibrator Kit</b> (Helps prevent material from bridging in the spreader hopper) (Includes wiring harness for vibrator) (Ship Weight 8 lbs.)	\$428.00	24.0%	\$0.00	\$325.28

Part Number	Stabilizer Description	SLP in US\$	Discount Percent	Labor	Price
-------------	------------------------	-------------	------------------	-------	-------



(S130, S510, S550, S530, S570, S590, S220, S250, S300, S330) (S630, S650, S750, S770, S850)  
 (A300) (A770) (T140, T550, T590, T250, T300, T320) (T630, T650, T750, T770, T870)

6811449	<b>Quick-Tach Rear Stabilizer Kit</b> (Must also order mounting kit) (Intended for use with 607, 709, 8811 Backhoes, Augers and Tree Spades) (Rear Stabilizers NOT compatible with Bob-Tach Mounted Backhoe P/N 6906767) (Price includes \$270 for installation)	<b>\$1,329.00</b>	<b>24.0%</b>	<b>\$270.00</b>	<b>\$1,280.04</b>
---------	--	-------------------	--------------	-----------------	-------------------

Part Number	Accessories Description	SLP in US\$	Discount Percent	Labor	Price
-------------	-------------------------	-------------	------------------	-------	-------

(S510, S550, S530, S570, S590) (S630, S650) (T630, T650) 7152508	<b>Mounting Kit</b> (Approved for use with M-Series Loaders to mount Quick-Tach Stabilizer and Quick-Tach Water Kit) (Ship weight 120 lbs.)	<b>\$438.00</b>	<b>24.0%</b>	<b>\$0.00</b>	<b>\$332.88</b>
---	--	-----------------	--------------	---------------	-----------------

(S750, S770, S850) (A770) (T750, T770, T870) 7152512	<b>Mounting Kit</b> (Approved for use with M-Series Loaders to mount Quick-Tach Stabilizer and Quick-Tach Water Kit) (Ship weight 90 lbs.)	<b>\$438.00</b>	<b>24.0%</b>	<b>\$0.00</b>	<b>\$332.88</b>
---	---	-----------------	--------------	---------------	-----------------

(S130) 7100245	<b>Mounting Kit</b> (Mounting Kit for use with Quick-Tach Stabilizer Kit and Quick-Tach Water Kit) (Ship weight 68 lbs.)	<b>\$386.00</b>	<b>24.0%</b>	<b>\$0.00</b>	<b>\$293.36</b>
-------------------	---	-----------------	--------------	---------------	-----------------

Part Number	Steel Tracks Description	SLP in US\$	Discount Percent	Labor	Price
-------------	--------------------------	-------------	------------------	-------	-------





**Complete Track Package**

*Each part number includes a set of tracks, web binder, hardware, and if required, wheel spacers and lift arm stops.*

(S130)	7112841 10.00-16.5	\$2,530.00	24.0%	\$0.00	\$1,922.80
(S510, S550)	7111884 10.00-16.5 Note: Includes Lift Arm Stop p/n 7112304	\$2,545.00	24.0%	\$0.00	\$1,934.20
(S530, S570, S590)	7111882 10.00-16.5 Note: Tracks will not work with 773, S530, S570 with 60" offset rims.	\$2,476.00	24.0%	\$0.00	\$1,881.76
(S590)	7135552 31-12-16.5	\$2,974.00	24.0%	\$0.00	\$2,260.24
(S630, S650)	7178955 12.00-16.5	\$3,309.00	24.0%	\$0.00	\$2,514.84
(S750, S770)	7191754 12.00-16.5	\$4,099.00	24.0%	\$0.00	\$3,115.24
(S850)	7191757 14.00-17.5	\$4,743.00	24.0%	\$0.00	\$3,604.68

**Note on use of poly fill tires with steel tracks - Only pneumatic tires with Superflex formula poly fill manufactured by Arnco are permitted for use inside steel tracks. Bobcat factory poly-filled tires meet this requirement. All other tires are considered non-approved. The use of non-approved tires will void the loader and track warranties.**



Part Number	Stump Grinder Description	SLP in US\$	Discount Percent	Labor	Price
-------------	---------------------------	-------------	------------------	-------	-------

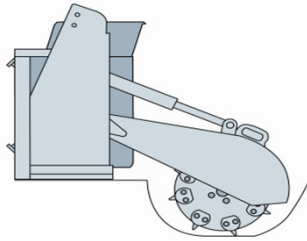

SG30 Stump Grinder

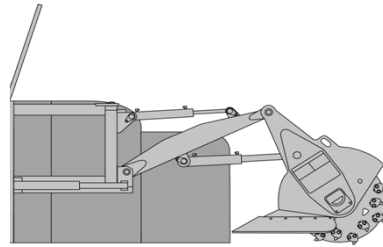

SG60 and SGX60 Stump Grinder

(463, S70, 553) 7100641	<b>SG30 Stump Grinder</b> (Loader must be equipped with a 14-Pin Attachment Control Kit)	\$4,769.00	24.0%	\$0.00	\$3,624.44
(S550H, S530, S530H, S570, S570H, S590, S590H, S220, S220H*, S250, S250H*, S300, S300H*, S330) (S630, S630H, S650, S650H, S750, S770, S850) (A300, A300H*) (A770) (T630, T630H, T650, T650H, T750, T770, T870) (T550, T550H, T590, T590H, T250, T250H*, T300, T300H*, T320) 6808034	<b>SG60 Stump Grinder</b> <b>*Not approved for use with 37 GPM High Flow Loaders</b> (Loader must be equipped with an Attachment Control Kit) (When used on loaders equipped with a 14-Pin Attachment Control Kit, a 14-Pin Attachment T-Harness Kit is required)	\$8,238.00	24.0%	\$0.00	\$6,260.88
(S530H, S570H, S220H, S250H, S300H, S330H) (S630H, S650H, S750H, S770H, S850H) (A300H) (A770H) (T550H, T590H, T250H, T300H, T320H) (T630H, T650H, T750H, T770H, T870H) 7112201	<b>SGX60 Stump Grinder</b> (Loader must be equipped with an Attachment Control Kit) (When used on loaders equipped with a 14-Pin Attachment Control Kit, a 14-Pin Attachment T-Harness is required)	\$8,482.00	24.0%	\$0.00	\$6,446.32

Part Number	Sweeper Description	SLP in US\$	Discount Percent	Labor	Price
-------------	---------------------	-------------	------------------	-------	-------

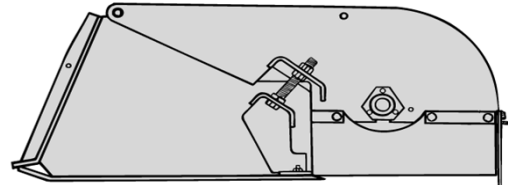

(463, S70) 7138898	44" Sweeper	\$2,951.00	24.0%	\$0.00	\$2,242.76
(553, S100) (T110) 7149358	48" Sweeper	\$3,124.00	24.0%	\$0.00	\$2,374.24
(S100, S130) (T110) 7138870	54" Sweeper	\$3,340.00	24.0%	\$0.00	\$2,538.40
(S130, S510, S550, S530, S570, S590) (T140, T550, T590) 6707144	60" Sweeper	\$3,709.00	24.0%	\$0.00	\$2,818.84
(S510, S550, S530, S570, S590, S220, S250, S300, S330) (S630, S650, S750, S770) (A300) (A770) (T550, T590) (T630, T650) 6707837	72" Sweeper	\$4,136.00	24.0%	\$0.00	\$3,143.36
(S220, S250, S300, S330) (S630, S650, S750, S770) (A300) (A770) (T250, T300, T320) (T630, T650, T750, T770) 7112646	84" Sweeper	\$4,601.00	24.0%	\$0.00	\$3,496.76

Part Number	Accessories Description	SLP in US\$	Discount Percent	Labor	Price
6714219	<b>Gutter Brush</b> (Add-on to the 60" and 72" Sweeper) (Includes hoses, couplers, steel bristles, mounting frame, hardware and control valve) (Price includes \$270 for installation)	\$1,321.00	24.0%	\$270.00	\$1,273.96
7122418	<b>Gutter Brush</b> (Add-on to the 84" Sweeper) (Includes hoses, couplers, steel bristles, mounting frame, hardware and control valve) (Price includes \$270 for installation)	\$1,259.00	24.0%	\$270.00	\$1,226.84

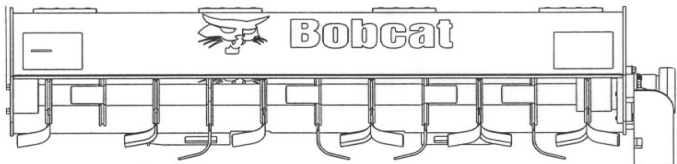
Part Number	Tiller Description	SLP in US\$	Discount Percent	Labor	Price
					
(463, S70, 553, S100) (T110) 7196028	40" MI Tiller	\$4,036.00	24.0%	\$0.00	\$3,067.36
(S130, S510, S550, S550H, S530, S530H, S570, S570H, S590, S590H, S220, S220H, S250, S250H, S300, S300H, S330, S330H) (S630, S630H, S650, S650H, S750, S750H, S770, S770H)(T140, T550, T550H, T590, T590H) (T630, T630H, T650, T650H) 7104371	62" Rotary Tiller	\$4,818.00	24.0%	\$0.00	\$3,661.68
(S550, S550H, S530, S530H, S570, S570H, S590, S590H, S220, S220H, S250, S250H, S300, S300H, S330, S330H) (S630, S630H, S650, S650H, S750, S750H, S770, S770H) (A300, A300H) (A770, A770H) (T630, T630H, T650, T650H, T750, T750H, T770, T770H) (T550, T550H, T590, T590H, T250, T250H, T300, T300H, T320, T320H)					

7102125	76" Rotary Tiller	\$5,800.00	24.0%	\$0.00	\$4,408.00
---------	-------------------	------------	-------	--------	------------

Part Number	Tilt Tach Description	SLP in US\$	Discount Percent	Labor	Price
-------------	-----------------------	-------------	------------------	-------	-------

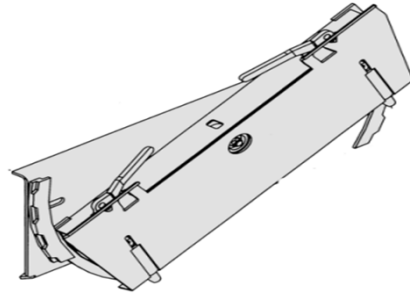

(S130, S510, S550, S530, S570, S590, S220, S250) (S630, S650) (T140, T550, T590)

7101600	Tilt-Tatch (Interface between the Loader's Bob-Tach and non hydraulic attachments)	\$2,329.00	24.0%	\$0.00	\$1,770.04
---------	---	------------	-------	--------	------------

Use of Tilt-Tatch will reduce Operating Capacity and Tip Load by approximately 20%. See the Tilt-Tatch Operators Manual for New Load Ratings.

Tilt-Tatch can be used with non-hydraulic attachments only.

Part Number	Tree Fork Description	SLP in US\$	Discount Percent	Labor	Price
-------------	-----------------------	-------------	------------------	-------	-------

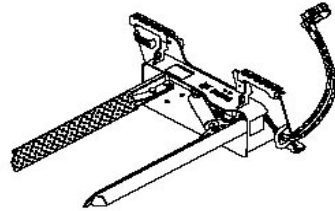

(463, S70, S100) (T110)

7124860	Tree Fork (left arm hydraulically controlled for opening or closing)	\$1,398.00	24.0%	\$0.00	\$1,062.48
---------	--	------------	-------	--------	------------

Part Number	Tree Spade Description	SLP in US\$	Discount Percent	Labor	Price
-------------	------------------------	-------------	------------------	-------	-------

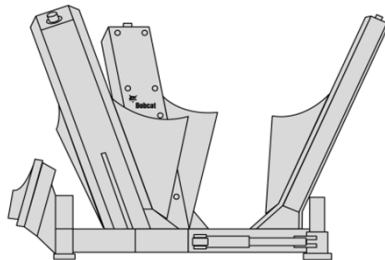

### ACD Tree Spades

Tree Spades are designed for fingertip spade control on G-Series and newer loaders only. The switches located on the loader's steering lever control Tree Spades. Loaders must be equipped with a 7-Pin control Kit

(S510, S550, S530, S570, S590, S220, S250, S300, S330) (S630, S650, S750, S770, S850)

(A300) (A770) (T140, T550, T590, T250, T300, T320) (T630, T650, T750, T770, T870)

7149499	24" ACD Tree Spade, Cone	\$9,236.00	24.0%	\$0.00	\$7,019.36
7149451	24" ACD Tree Spade, Modified	\$9,082.00	24.0%	\$0.00	\$6,902.32
7149448	24" ACD Tree Spade, Truncated	\$9,133.00	24.0%	\$0.00	\$6,941.08

(S510, S550, S530, S570, S590, S220, S250, S300, S330) (S630, S650, S750, S770, S850)

(A300) (A770) (T550, T590, T250, T300, T320) (T630, T650, T750, T770, T870)

7149501	28" ACD Tree Spade, Cone	\$9,350.00	24.0%	\$0.00	\$7,106.00
7149457	28" ACD Tree Spade, Modified	\$9,350.00	24.0%	\$0.00	\$7,106.00
7149454	28" ACD Tree Spade, Truncated	\$9,350.00	24.0%	\$0.00	\$7,106.00

(S550, S530, S570, S590, S220, S250, S300, S330) (S630, S650, S750, S770, S850)

(A300) (A770) (T550, T590, T250, T300, T320) (T630, T650, T750, T770, T870)

7149503	32" ACD Tree Spade, Cone	\$10,238.00	24.0%	\$0.00	\$7,780.88
7149463	32" ACD Tree Spade, Modified	\$10,238.00	24.0%	\$0.00	\$7,780.88
7149460	32" ACD Tree Spade, Truncated	\$10,238.00	24.0%	\$0.00	\$7,780.88

(S530, S570, S590, S220, S250, S300, S330) (S630, S650, S750, S770, S850) (A300) (A770)

(T550, T590, T250, T300, T320) (T630, T650, T750, T770, T870)

7149505	36" ACD Tree Spade, Cone	\$10,864.00	24.0%	\$0.00	\$8,256.64
7149469	36" ACD Tree Spade, Modified	\$10,864.00	24.0%	\$0.00	\$8,256.64
7149466	36" ACD Tree Spade, Truncated	\$10,864.00	24.0%	\$0.00	\$8,256.64

(S220, S250, S300, S330) (S750, S770, S850) (A300) (A770) (T250, T300, T320)  
(T750, T770, T870)

7149507	44" ACD Tree Spade, Cone	\$14,499.00	24.0%	\$0.00	\$11,019.24
7149472	44" ACD Tree Spade, Modified	\$14,499.00	24.0%	\$0.00	\$11,019.24

Note: Rear Stabilizers are required and counterweights are recommended when using the tree spade

### Convertible Tree Spades

Convertible Tree Spades can be equipped with either a pendant style (rocker switch) control panel or a 7-pin ACD control kit. Tree Spades with pendant control can be installed on all loader series; tree spades with 7-pin ACD control must be installed on G-Series and newer loaders. Must order a pendant control kit or 7-pin ACD conversion kit for tree spade with convertible control.

(S510, S550, S530, S570, S590, S220, S250, S300, S330) (S630, S650, S750, S770, S850)  
(A300) (A770) (T140, T550, T590, T250, T300, T320) (T630, T650, T750, T770, T870)

7149476	24" Convertible Tree Spade, Cone (Must also order Pendant Control Kit or 7-Pin ACD Conversion Kit)	\$10,012.00	24.0%	\$0.00	\$7,609.12
7149312	24" Convertible Tree Spade, Modified (Must also order Pendant Control Kit or 7-Pin ACD Conversion Kit)	\$9,873.00	24.0%	\$0.00	\$7,503.48
7149309	24" Convertible Tree Spade, Truncated (Must also order Pendant Control Kit or 7-Pin ACD Conversion Kit)	\$9,924.00	24.0%	\$0.00	\$7,542.24

(S510, S550, S530, S570, S590, S220, S250, S300, S330) (S630, S650, S750, S770, S850)  
(A300) (A770) (T550, T590, T250, T300, T320) (T630, T650, T750, T770, T870)

7149480	28" Convertible Tree Spade, Cone (Must also order Pendant Control Kit or 7-Pin ACD Conversion Kit)	\$9,577.00	24.0%	\$0.00	\$7,278.52
7149243	28" Convertible Tree Spade, Modified (Must also order Pendant Control Kit or 7-Pin ACD Conversion Kit)	\$9,577.00	24.0%	\$0.00	\$7,278.52
7144870	28" Convertible Tree Spade, Truncated (Must also order Pendant Control Kit or 7-Pin ACD Conversion Kit)	\$9,577.00	24.0%	\$0.00	\$7,278.52

(S550, S530, S570, S590, S220, S250, S300, S330) (S630, S650, S750, S770, S850)  
(A300) (A770)

7149485	32" Convertible Tree Spade, Cone (Must also order Pendant Control Kit or 7-Pin ACD Conversion Kit)	\$10,496.00	24.0%	\$0.00	\$7,976.96
7149442	32" Convertible Tree Spade, Modified (Must also order Pendant Control Kit or 7-Pin ACD Conversion Kit)	\$10,496.00	24.0%	\$0.00	\$7,976.96
7149439	32" Convertible Tree Spade, Truncated (Must also order Pendant Control Kit or 7-Pin ACD Conversion Kit)	\$10,496.00	24.0%	\$0.00	\$7,976.96

(S530, S570, S590, S220, S250, S300, S330) (S630, S650, S750, S770, S850)

<b>(A300) (A770)(T550, T590, T250, T300, T320) (T630, T650, T750, T770, T870)</b>					
<b>7149488</b>	<b>36" Convertible Tree Spade, Cone</b>	<b>\$11,094.00</b>	<b>24.0%</b>	<b>\$0.00</b>	<b>\$8,431.44</b>
	(Must also order Pendant Control Kit or 7-Pin ACD Conversion Kit)				
<b>7149445</b>	<b>36" Convertible Tree Spade, Modified</b>	<b>\$11,094.00</b>	<b>24.0%</b>	<b>\$0.00</b>	<b>\$8,431.44</b>
	(Must also order Pendant Control Kit or 7-Pin ACD Conversion Kit)				
<b>7149292</b>	<b>36" Convertible Tree Spade, Truncated</b>	<b>\$11,094.00</b>	<b>24.0%</b>	<b>\$0.00</b>	<b>\$8,431.44</b>
	(Must also order Pendant Control Kit or 7-Pin ACD Conversion Kit)				

<b>(S220, S250, S300, S330) (S750, S770, S850) (A300) (A770) (T250, T300, T320) (T750, T770, T870)</b>					
<b>7149491</b>	<b>44" Convertible Tree Spade, Cone</b>	<b>\$15,156.00</b>	<b>24.0%</b>	<b>\$0.00</b>	<b>\$11,518.56</b>
	(Must also order Pendant Control Kit p/n 7152664 or 7-Pin ACD Conversion Kit)				
<b>7149306</b>	<b>44" Convertible Tree Spade, Modified</b>	<b>\$15,070.00</b>	<b>24.0%</b>	<b>\$0.00</b>	<b>\$11,453.20</b>
	(Must also order Pendant Control Kit p/n 7152664 or 7-Pin ACD Conversion Kit)				

**Note: Rear Stabilizers are required and counterweights are recommended when using the tree spade**

<b>Part Number</b>	<b>Accessories Description</b>	<b>SLP in US\$</b>	<b>Discount Percent</b>	<b>Labor</b>	<b>Price</b>
	(All Loader Series)				
<b>7152662</b>	<b>ACD Conversion Kit, 7-Pin</b> (Price includes \$90 for installation)	<b>\$272.00</b>	<b>24.0%</b>	<b>\$90.00</b>	<b>\$296.72</b>
<b>7152663</b>	<b>Pendant Control Kit, 3-Blade</b> (For 24" through 36" Convertible Tree Spades) (No additional Control Kits needed.) (Price includes \$90 for installation)	<b>\$450.00</b>	<b>24.0%</b>	<b>\$90.00</b>	<b>\$432.00</b>
<b>7152664</b>	<b>Pendant Control Kit, 4-Blade</b> (For 44" Convertible Tree Spades) (No additional Control Kits needed.) (Will operate 4-Blade convertible Tree Spades) (Price includes \$90 for installation)	<b>\$517.00</b>	<b>24.0%</b>	<b>\$90.00</b>	<b>\$482.92</b>

Part Number	Trench Compactor Description	SLP in US\$	Discount Percent	Labor	Price
-------------	---------------------------------	-------------	---------------------	-------	-------

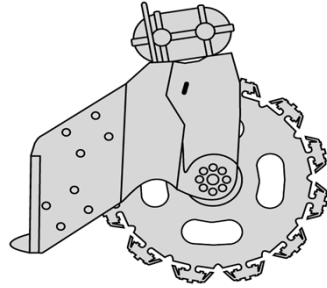

(S130, S510, S550, S530, S570, S590, S220, S250, S300, S330) (A300)

(T140, T550, T590, T250, T300, T320)

6905277	<b>Trench Compactor</b> (Comes standard with a 4 1/2" Pad and compacts trenches up to 8" wide) (Wheel-type vibratory compactor)	\$7,632.00	24.0%	\$0.00	\$5,800.32
---------	---	------------	-------	--------	------------

Part Number	Trencher Description	SLP in US\$	Discount Percent	Labor	Price
-------------	-------------------------	-------------	---------------------	-------	-------

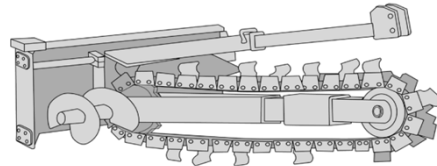

Part Number	LT112 Trencher Description	SLP in US\$	Discount Percent	Labor	Price
-------------	-------------------------------	-------------	---------------------	-------	-------

(463, S70)

M7011	<b>LT112 Trencher</b> (Includes mounting frame, hoses, couplers, 2' depth, manual sideshift, 4" trench cleaner) (Can only order one factory installed chain option per trencher model)	\$3,466.00	24.0%	\$0.00	\$2,634.16
-------	--	------------	-------	--------	------------

*2' Chain Options are 1.654" Double Standard (DS) Anti-Back Flex (ABF)*

M7011-R01-C02	2' x 4" cup teeth, Single Standard pattern	\$377.00	24.0%	\$0.00	\$286.52
M7011-R01-C01	2' x 4" Cup Teeth, Double Standard Pattern	\$476.00	24.0%	\$0.00	\$361.76
M7011-R01-C03	2' x 4" cup & carbide teeth, Double Standard pattern	\$924.00	24.0%	\$0.00	\$702.24



Part Number	LT113 Trencher Description	SLP in US\$	Discount Percent	Labor	Price
-------------	-------------------------------	-------------	---------------------	-------	-------

(463, S70)

M7014	<b>LT113 Trencher</b> (Includes mounting frame, hoses, couplers, 3' depth, manual sideshift, 4" trench cleaner) (Can only order one factory installed chain option per trencher model)	\$3,611.00	24.0%	\$0.00	\$2,744.36
-------	--	------------	-------	--------	------------

*3' Chain Options are 1.654" Double Standard (DS) Anti-Back Flex (ABF)*

M7014-R01-C02	3' x 4" Cup Teeth, Single Standard Pattern	\$433.00	24.0%	\$0.00	\$329.08
M7014-R01-C04	3' x 6" Cup Teeth, Single Standard Pattern	\$461.00	24.0%	\$0.00	\$350.36
M7014-R01-C01	3' x 4" Cup Teeth, Double Standard Pattern	\$490.00	24.0%	\$0.00	\$372.40
M7014-R01-C03	3' x 4" Cup & Carbide Teeth, Double Standard Pattern	\$1,005.00	24.0%	\$0.00	\$763.80

Part Number	LT213 Trencher Description	SLP in US\$	Discount Percent	Labor	Price
-------------	-------------------------------	-------------	---------------------	-------	-------

(553, S100, S130) (T110, T140)

M7013	<b>LT213 Trencher</b> (Includes 3' depth, manual sideshift, and 4" trench cleaner) (Can only order one factory installed chain option per trencher model)	\$3,636.00	24.0%	\$0.00	\$2,763.36
-------	---	------------	-------	--------	------------

*Chains are 1.654" Double Standard (DS) Anti-Back Flex (ABF)*

M7013-R01-C02	3' x 4" Cup Teeth, Single Standard Pattern	\$433.00	24.0%	\$0.00	\$329.08
M7013-R01-C04	3' x 6" Cup Teeth, Single Standard Pattern	\$461.00	24.0%	\$0.00	\$350.36
M7013-R01-C01	3' x 4" Cup Teeth, Double Standard Pattern	\$490.00	24.0%	\$0.00	\$372.40
M7013-R01-C03	3' x 4" Cup & Carbide Teeth, Double Standard Pattern	\$1,005.00	24.0%	\$0.00	\$763.80

M7013-A01-C01	Hydraulic Side Shift	\$657.00	24.0%	\$0.00	\$499.32
---------------	----------------------	----------	-------	--------	----------

Part Number	LT313 Trencher Description	SLP in US\$	Discount Percent	Labor	Price
-------------	-------------------------------	-------------	---------------------	-------	-------

(S130, S510, S550, S530, S570, S590, S220, S250, S300, S330) (S630, S650, S750, S770)

(A300) (A770) (T140, T550, T590) (T630, T650)

M7015	<b>LT313 Trencher</b> (Includes 3' depth, manual sideshift, 6" trench cleaner) (Can only order one factory installed chain option per trencher model)	\$4,472.00	24.0%	\$0.00	\$3,398.72
-------	---	------------	-------	--------	------------

*All chains are 2.0" Double Standard (DS) Anti-Back Flex (ABF)*

M7015-R01-C02	3' x 6" Cup Teeth in Single Standard Pattern	\$624.00	24.0%	\$0.00	\$474.24
M7015-R01-C05	3' x 8" Cup Teeth in Single Standard Pattern	\$656.00	24.0%	\$0.00	\$498.56
M7015-R01-C01	3' x 6" Cup Teeth in Double Standard Pattern	\$924.00	24.0%	\$0.00	\$702.24
M7015-R01-C04	3' x 6" Shark Tooth/Cup Teeth in Double Standard Pattern	\$1,041.00	24.0%	\$0.00	\$791.16
M7015-R01-C03	3' x 6" Cup & Carbide Teeth in Double Standard Pattern	\$1,685.00	24.0%	\$0.00	\$1,280.60
M7015-R01-C06	3' x 8" Cup & Carbide Teeth in Double Standard Pattern	\$1,725.00	24.0%	\$0.00	\$1,311.00
M7015-A01-C01	Hydraulic Side Shift	\$657.00	24.0%	\$0.00	\$499.32

*The LT313 is assembled as a 4' dig depth when ordering the 4' chain option  
(Boom Guide included with 4' factory installed chain)*

M7015-R01-C08	4' x 6" Cup Teeth in Single Standard Pattern	\$769.00	24.0%	\$0.00	\$584.44
M7015-R01-C11	4' x 8" Cup Teeth in Single Standard Pattern	\$864.00	24.0%	\$0.00	\$656.64
M7015-R01-C07	4' x 6" Cup Teeth in Double Standard Pattern	\$947.00	24.0%	\$0.00	\$719.72
M7015-R01-C10	4' x 6" Shark Tooth/Cup Teeth in Double Standard Pattern	\$1,223.00	24.0%	\$0.00	\$929.48
M7015-R01-C09	4' x 6" Cup & Carbide Teeth in Double Standard Pattern	\$1,893.00	24.0%	\$0.00	\$1,438.68
M7015-R01-C12	4' x 8" Cup & Carbide Teeth in Double Standard Pattern	\$2,021.00	24.0%	\$0.00	\$1,535.96
M7015-A01-C01	Hydraulic Side Shift	\$657.00	24.0%	\$0.00	\$499.32

Part Number	LT414 High Flow Trencher Description	SLP in US\$	Discount Percent	Labor	Price
-------------	--------------------------------------	-------------	------------------	-------	-------

(S550H, S530H, S570H, S590H, S220H, S250H, S300H, S330H)  
(S630H, S650H, S750H, S770H) (A300H) (A770H)  
(T550H, T590H, T250H, T300H, T320H) (T630H, T650H, T750H, T770H)  
4' Depth

(S220H, S250H, S300H, S330H) (S630H, S650H, S750H, S770H) (A300H) (A770H)  
(T250H, T300H, T320H) (T630H, T650H, T750H, T770H)  
5' Depth

M7016	<b>LT414 Trencher</b> (Includes 4' or 5' depth, hydraulic sideshift, and 6" trench cleaner) (Can only order one factory installed chain option per trencher model) (Loader must be equipped with High Flow auxiliary hydraulics)	\$6,672.00	24.0%	\$0.00	\$5,070.72
-------	---	------------	-------	--------	------------

*Chains are 2.0" Single Standard (SS) or Double Standard (DS) Anti-Back Flex (ABF)*

M7016-R01-C08	4' x 6" Cup Teeth, Single Standard Pattern	\$794.00	24.0%	\$0.00	\$603.44
---------------	--	----------	-------	--------	----------

M7016-R01-C07	4' x 6" Cup Teeth, Double Standard Pattern	\$914.00	24.0%	\$0.00	\$694.64
M7016-R01-C09	4' x 6" Cup & Carbide Teeth, Double Standard Pattern	\$1,894.00	24.0%	\$0.00	\$1,439.44
M7016-R01-C10	4' x 6" Shark Tooth/Cup Teeth in Double Standard Pattern	\$1,567.00	24.0%	\$0.00	\$1,190.92
M7016-R01-C11	4' x 8" Cup Teeth, Single Standard Pattern	\$844.00	24.0%	\$0.00	\$641.44
M7016-R01-C12	4' x 8" Cup & Carbide Teeth in Double Standard Pattern	\$1,965.00	24.0%	\$0.00	\$1,493.40
M7016-R01-C04	5' x 6" Cup Teeth, Single Standard Pattern	\$941.00	24.0%	\$0.00	\$715.16
M7016-R01-C01	5' x 6" Cup Teeth, Double Standard Pattern	\$1,076.00	24.0%	\$0.00	\$817.76
M7016-R01-C03	5' x 6" Cup & Carbide Teeth, Double Standard Pattern	\$2,241.00	24.0%	\$0.00	\$1,703.16
M7016-R01-C02	5' x 6" Shark Tooth/Cup Teeth in Double Standard Pattern	\$1,788.00	24.0%	\$0.00	\$1,358.88
M7016-R01-C06	5' x 8" Cup Teeth, Single Standard Pattern	\$999.00	24.0%	\$0.00	\$759.24
M7016-R01-C05	5' x 8" Cup & Carbide Teeth in Double Standard Pattern	\$2,450.00	24.0%	\$0.00	\$1,862.00

Part Number	LT405 High Flow Trencher Description	SLP in US\$	Discount Percent	Labor	Price
-------------	--------------------------------------	-------------	------------------	-------	-------

(S530H, S570H, S590H, S220H, S250H, S300H, S330H) (S630H, S650H, S750H, S770H)

(A300H) (A770H) (T550H, T590H, T250H, T300H, T320H)

(T630H, T650H, T750H, T770H)

6906100	LT405 Trencher (Includes 3' – 4' adjustable boom setup at 4', double standard ABF chain, Hydraulic Sideshift, 6" trench cleaner, hoses and couplers) (Must also order teeth)	\$10,481.00	24.0%	\$0.00	\$7,965.56
---------	---	-------------	-------	--------	------------

Part Number	Vibratory Roller Description	SLP in US\$	Discount Percent	Labor	Price
-------------	------------------------------	-------------	------------------	-------	-------

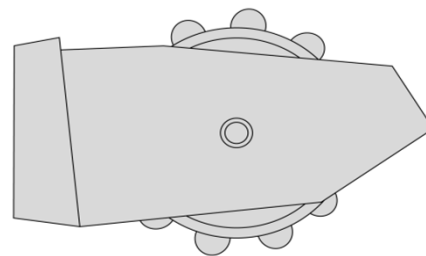

(S130\*, S510, S550, S530, S570, S590) (T140, T550, T590)

7165403	48" Vibratory Roller with Padded Drum	\$8,441.00	24.0%	\$0.00	\$6,415.16
7165404	48" Vibratory Roller with Smooth Drum	\$8,235.00	24.0%	\$0.00	\$6,258.60

(S590, S220, S250, S300, S330) (S630, S650, S750, S770, S850) (A300) (A770)

(T250, T300, T320) (T630, T650, T750, T770, T870)

7165401	73" Vibratory Roller with Padded Drum	\$9,728.00	24.0%	\$0.00	\$7,393.28
---------	---------------------------------------	------------	-------	--------	------------

7165402	<b>73" Vibratory Roller with Smooth Drum</b>	<b>\$9,471.00</b>	<b>24.0%</b>	<b>\$0.00</b>	<b>\$7,197.96</b>
---------	--	-------------------	--------------	---------------	-------------------

(S250, S300, S330) (S750, S770, S850) (A300) (A770) (T250, T300, T320)  
(T630, T750, T770, T870)

7165400	<b>80" Vibratory Roller with Smooth Drum</b>	<b>\$10,192.00</b>	<b>24.0%</b>	<b>\$0.00</b>	<b>\$7,745.92</b>
---------	--	--------------------	--------------	---------------	-------------------

Part Number	Accessories Description	SLP in US\$	Discount Percent	Labor	Price
-------------	-------------------------	-------------	------------------	-------	-------

7162567	<b>73" Smooth Shell</b> (Smooth shell for the 73" Vibratory Roller with Padded Drum) (Ship Weight 580 lbs.)	<b>\$1,437.00</b>	<b>24.0%</b>	<b>\$0.00</b>	<b>\$1,092.12</b>
---------	---	-------------------	--------------	---------------	-------------------

Part Number	Wheel Saw Description	SLP in US\$	Discount Percent	Labor	Price
-------------	-----------------------	-------------	------------------	-------	-------

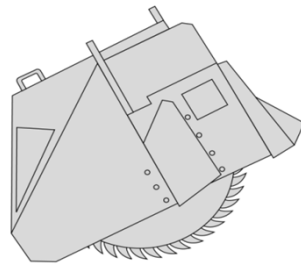

**18" Wheel Saw with 3" Wheel**

(Must order the two part numbers listed below—18" Wheel Saw and 3" Wheel)

(Must also order Attachment Control Kit)

(S530H, S570H, S590H, S220H, S250H, S300H, S330H) (S630H, S650H, S750H, S770H, S850, S850H) (A300H) (A770H) (T550H, T590H, T250H, T300H, T320H)  
(T630H, T650H, T750H, T770H, T870, T870H)

6729537	<b>WS18 Wheel Saw</b>	<b>\$15,017.00</b>	<b>24.0%</b>	<b>\$0.00</b>	<b>\$11,412.92</b>
---------	-----------------------	--------------------	--------------	---------------	--------------------

6729544	<b>3" Wheel</b>	<b>\$3,316.00</b>	<b>24.0%</b>	<b>\$0.00</b>	<b>\$2,520.16</b>
---------	-----------------	-------------------	--------------	---------------	-------------------

(Weight 650 lbs. Wheel Width 3.13")

**Note: There is no Trench Cleaner available with the 3" Wheel.**

**18" Wheel Saw with 6" Wheel and 6" Trench Cleaner**

(Must order the three part numbers listed below—18" Wheel Saw, 6" Wheel and 6" Trench Cleaner)

(Must also order Attachment Control Kit)

(S530H, S570H, S590H, S220H, S250H, S300H, S330H) (S630H, S650H, S750H, S770H, S850, S850H) (A300H) (A770H) (T550H, T590H, T250H, T300H, T320H)

(T630H, T650H, T750H, T770H, T870, T870H)

6729537	<b>WS18 Wheel Saw</b>	<b>\$15,017.00</b>	<b>24.0%</b>	<b>\$0.00</b>	<b>\$11,412.92</b>
6729546	<b>6" Wheel</b> (Weight 395 lbs., Wheel Width 6.25")	<b>\$3,316.00</b>	<b>24.0%</b>	<b>\$0.00</b>	<b>\$2,520.16</b>
6729550	<b>6" Trench Cleaner</b> (Weight 95 lbs.)	<b>\$1,235.00</b>	<b>24.0%</b>	<b>\$0.00</b>	<b>\$938.60</b>

**18" Wheel Saw with 8" Wheel and 8" Trench Cleaner**

(Must order the three part numbers listed below—18" Wheel Saw, 8" Wheel and 8" Trench Cleaner)

(Must also order Attachment Control Kit)

(S530H, S570H, S590H, S220H, S250H, S300H, S330H) (S630H, S650H, S750H, S770H, S850, S850H) (A300H) (A770H) (T550H, T590H, T250H, T300H, T320H)

(T630H, T650H, T750H, T770H, T870, T870H)

6729537	<b>WS18 Wheel Saw</b>	<b>\$15,017.00</b>	<b>24.0%</b>	<b>\$0.00</b>	<b>\$11,412.92</b>
6729548	<b>8" Wheel</b> (Weight 442 lbs., Wheel Width 7.88")	<b>\$3,999.00</b>	<b>24.0%</b>	<b>\$0.00</b>	<b>\$3,039.24</b>
6729552	<b>8" Trench Cleaner</b> (Weight 113 lbs.)	<b>\$1,354.00</b>	<b>24.0%</b>	<b>\$0.00</b>	<b>\$1,029.04</b>

**24" Wheel Saw with 6" Wheel and 6" Trench Cleaner**

(Must order the three part numbers listed below—24" Wheel Saw, 6" Wheel and 6" Trench Cleaner)

(Must also order Attachment Control Kit)

(S250H, S300H, S330H) (S750H, S770H, S850, S850H) (A300H) (A770H)

(T250H, T300H, T320H) (T750H, T770H, T870, T870H)

6729566	<b>WS24 Wheel Saw</b>	<b>\$17,363.00</b>	<b>24.0%</b>	<b>\$0.00</b>	<b>\$13,195.88</b>
6729573	<b>6" Wheel</b> (Weight 585 lbs., Wheel Width 6.25")	<b>\$4,207.00</b>	<b>24.0%</b>	<b>\$0.00</b>	<b>\$3,197.32</b>
6729577	<b>6" Trench Cleaner</b> (Weight 130 lbs.)	<b>\$1,417.00</b>	<b>24.0%</b>	<b>\$0.00</b>	<b>\$1,076.92</b>

**24" Wheel Saw with 8" Wheel and 8" Trench Cleaner**

(Must order the three part numbers listed below—24" Wheel Saw, 8" Wheel and 8" Trench Cleaner)

(Must also order Attachment Control Kit)

(S250H, S300H, S330H) (S750H, S770H, S850, S850H) (A300H) (A770H)

<b>(T250H, T300H, T320H) (T750H, T770H, T870, T870H)</b>					
<b>6729566</b>	<b>WS24 Wheel Saw</b>	<b>\$17,363.00</b>	<b>24.0%</b>	<b>\$0.00</b>	<b>\$13,195.88</b>
<b>6729575</b>	<b>8" Wheel</b> (Weight 618 lbs., Wheel Width 7.88")	<b>\$4,891.00</b>	<b>24.0%</b>	<b>\$0.00</b>	<b>\$3,717.16</b>
<b>6729579</b>	<b>8" Trench Cleaner</b> (Weight 148 lbs.)	<b>\$1,513.00</b>	<b>24.0%</b>	<b>\$0.00</b>	<b>\$1,149.88</b>

<b>Part Number</b>	<b>Whisker Broom Description</b>	<b>SLP in US\$</b>	<b>Discount Percent</b>	<b>Labor</b>	<b>Price</b>
--------------------	----------------------------------	--------------------	-------------------------	--------------	--------------

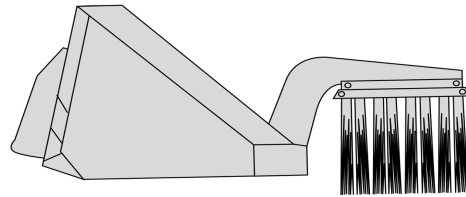

<b>(S130, S510, S550, S530, S570, S590, S220, S250, S300, S330) (S630, S650, S750, S770)</b>					
<b>(A300) (A770) (T140, T550, T590) (T630, T650)</b>					
<b>6728236</b>	<b>Whiskers Push Broom, 72"</b> (Quick attaches to 62", 68" and 74" C/I, General Purpose and Low Profile Buckets with 2 spring loaded pins) <i>(Price includes \$90 for installation)</i>	<b>\$1,224.00</b>	<b>24.0%</b>	<b>\$90.00</b>	<b>\$1,020.24</b>

<b>(S510, S550, S530, S570, S590, S220, S250, S300, S330) (S630, S650, S750, S770)</b>					
<b>(A300) (A770) (T550, T590) (T630, T650)</b>					
<b>6728241</b>	<b>Whiskers Push Broom, 90"</b> (Quick attaches to 68", 74" and 80" C/I, General Purpose and Low Profile Buckets with 2 spring loaded pins) <i>(Price includes \$90 for installation)</i>	<b>\$1,467.00</b>	<b>24.0%</b>	<b>\$90.00</b>	<b>\$1,204.92</b>