



XINGYING

COMMON NAILS COILED NAILS PLASTIC COLLATED NAILS
STEEL NAILS CATALOG
PAPER COLLATE NAILS CONCRETE NAILS HORSESHOE NAILS

FINISHING NAILS
SHANDONG XINGYING
CORRUGATED NAILS
CUT MASONRY NAILS
WOOD SCREW
SCREW NAILS
ROOFING NAILS
SQUARE BOAT NAILS
HORSESHOE NAILS
RING SHANK NAILS
DUPLEX NAILS
INSULATION NAILS
CLOUT NAILS
U NAILS

COMMON NAILS COILED NAILS PLASTIC COLLATED NAILS
PAPER COLLATE NAILS CONCRETE NAILS HORSESHOE NAILS

SCREW NAILS WOOD SCREW
U NAILS CLOUT NAILS
DUPLEX NAILS RING-SHANK NAILS
INSULATION NAILS
HORSESHOE NAILS
STEEL NAILS CATALOG
CORRUGATED NAILS
FINISHING NAILS
SQUARE BOAT NAILS
ROOFING NAILS

ABOUT XINGYING

Shandong Xingying International Trading Co., Ltd. is a leading manufacturer of common nails as well as other nail products in China. Since its foundation in 1985, the factory is engaged in the production and export of roofing nails, coil nails, square boat nails, corrugated nails, common nail, concrete nails, finishing nails, horseshoe nails, hog ring staple, screwed nails, etc.

Main export market presently centers on Asia, South America and Europe, etc. And the products have gained a good reputation among our distributors & customers. The company has been awarded as one of the best suppliers from the Fortune 500 clients over the past few years. We are so proud of our steel nails and considering to develop other overseas markets.

If you are interested in purchasing nails for your project, please do not hesitate to contact us. We are looking forward to forming business relationships with any customer from all over the world.

Content

GENERAL DESCRIPTION

Nail Sizes	04
Nail Head Types	04
Nail Shank Types	05
Nail Point Types	05

NAIL TYPES

1. Common Nails	06
2. Coiled Nails	07
3. Concrete Nails	10
4. Roofing Nails	11
5. Square Boat Nails	13
6. Horseshoe Nails	14
7. Ring Shank Nails	16
8. Finishing Nails	18
9. Corrugated Nails	19
10. Plastic Collated Nails	21
11. Paper Collate Nails	24
12. Duplex Nails	28
13. Clout Nails	29
14. U Nails	31
15. Hog Ring Staple	32
16. Cut Masonry Nails	34
17. Insulation Nails	35
18. Wood Screw	37
19. Screw Nails	39

HOW TO CHOOSE A RIGHT NAIL?

Factors to Consider	41
Purchase Information	41

General Description

Nail Sizes

Nail size is called a "penny", e.g. "a 6-penny nail". And now penny size is simply denoted by the letter "d". The following table is the length of each number.

Penny Size	Length	
	in.	mm
2d	1	25.4
3d	1-1/4	31.7
4d	1-1/2	38.1
5d	1-3/4	44.4
6d	2	50.8
7d	2-1/4	57.1
8d	2-1/2	63.5
9d	2-3/4	69.8
10d	3	76.2
12d	3-1/4	82.5
16d	3-1/2	88.9
20d	4	101.6
30d	4-1/2	114.3
40d	5	127.0
50d	5-1/2	139.7
60d	6	152.4
70d	7	177.8

Steel Wire Gauge	Diameter Gauge	
	in.	mm
3	0.259	6.57
4	0.238	6.05
6	0.203	5.16
8	0.162	4.12
9	0.148	3.76
10	0.131	3.33
11	0.120	3.05
12	0.113	2.85
13	0.092	2.34
14	0.083	2.11
15	0.072	1.83
16	0.065	1.65
18	0.049	1.25
23	0.026	0.66

Nail Head Types

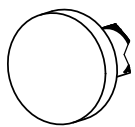

Circular flat

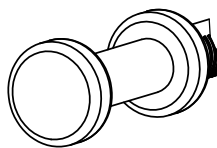

Double head

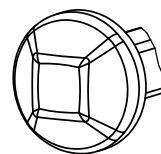

Diamond head

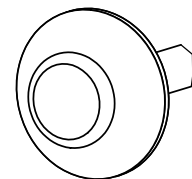

Spring head

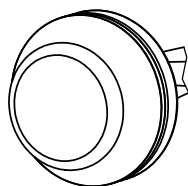

Washer head

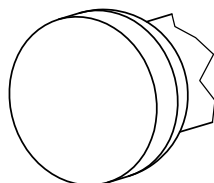

Brad head

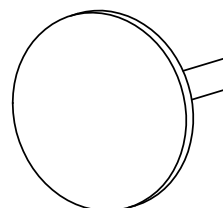

Clout head

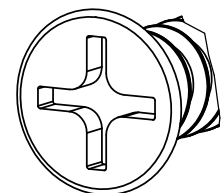

Phillips flat

Nail Shank Types



Smooth shank



Ring shank



Screw shank

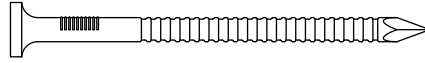
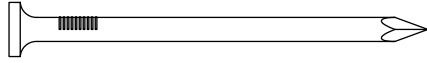

Square shank



Flute shank



Square twisted shank

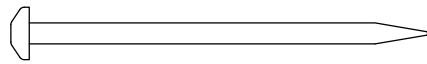

Nail Shank Types

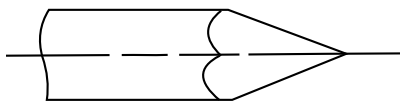

Diamond point

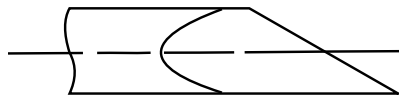

Diamond point offset

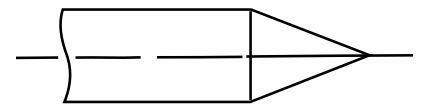

Round point

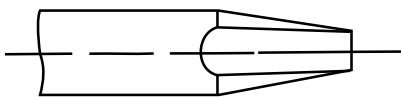

Chisel point

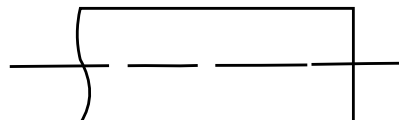

Cut point

1. Common nails

Common steel nails are shown as a wide head, a smooth shank and a diamond-shaped point.

- One of the most commonly used types of steel nails.
- Strong and stiff for medium & heavy projects.
- Great holding power and resistant to bending.
- Complete gauges, length and sizes are available.
- Surface treatment: bright, galvanized, polished, vinyl coated.
- Standard: ASTM F1667, ASTM A153.

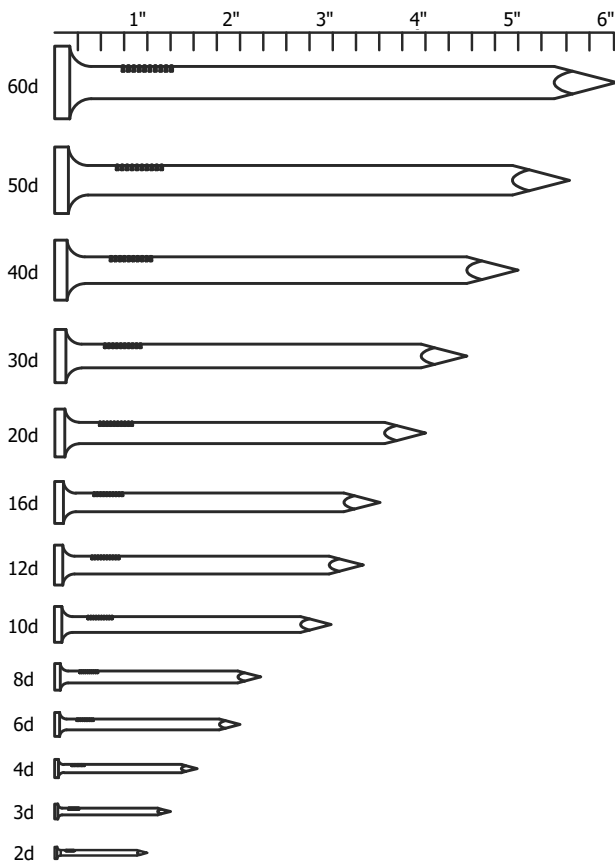

Application

- Wood construction.
- Cabinet work.
- Furniture finishing.
- Bamboo device.
- Ordinary plastic.
- Wall moulding.
- Packaging boxes.

Item No.	Size (d)	Length (inch)	Diameter (inch)	Head Dia. (inch)	No./lb
Aluminum					
XCAL-01	4	1-1/2	0.099	0.250	830
XCAL-02	6	2	0.120	0.266	430
XCAL-03	8	2-1/2	0.148	0.281	220
XCAL-04	10	2	0.162	0.312	170
XCAL-05	16	3-1/2	0.177	0.344	120
XCAL-06	20	4	0.199	0.406	78

Copper					
XCAC-01	—	5/6	0.065	0.156	1380
XCAC-02	—	3/4	0.065	0.156	1160
XCAC-03	—	3/4	0.072	0.172	960
XCAC-04	—	7/8	0.072	0.172	810
XCAC-05	2	1	0.072	0.172	700
XCAC-06	3	1-1/4	0.083	0.203	420
XCAC-07	4	1-1/2	0.109	0.250	210
XCAC-08	5	1-3/4	0.109	0.250	180
XCAC-09	5	1-3/4	0.120	0.266	140

Steel					
XCAS-01	2	1	0.072	0.172	850
XCAS-02	3	1-1/4	0.080	0.203	540
XCAS-03	4	1-1/2	0.099	0.250	290
XCAS-04	5	1-3/4	0.099	0.250	250
XCAS-05	6	2	0.113	0.266	170
XCAS-06	7	2-1/4	0.113	0.266	150
XCAS-07	8	2-1/2	0.131	0.281	100
XCAS-08	9	2-3/4	0.131	0.281	92
XCAS-09	10	3	0.148	0.312	66
XCAS-10	12	3-1/4	0.148	0.312	61
XCAS-11	16	3-1/2	0.162	0.344	47
XCAS-12	20	4	0.192	0.406	30
XCAS-13	30	4-1/2	0.207	0.438	23
XCAS-14	40	5	0.226	0.469	14
XCAS-15	50	5-1/2	0.244	0.500	14
XCAS-16	60	6	0.262	0.531	11

2. Coiled Nails

Main types include coiled smooth shank nails, coiled ring shank nails and coiled screw nails.

- Designed for high efficient operation.
- For use with 15° wire coil framing nailers.
- Proper fastener feeding for high volume operations.
- Resistant to rust for outdoor applications.
- Tighter hold power and increased durability.
- Surface treatment: bright, electro galvanized, hot dipped galvanized, phosphate coated.

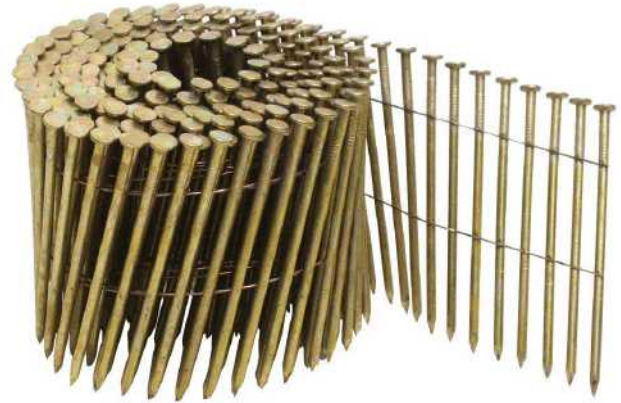

Application

- Sheathing.
- Ply bracing.
- Fencing fixation.
- Timber & softer pine framing material.
- Composition roofing.
- Underlayments.
- Fiber cement boards.
- Cabinet and furniture frames.

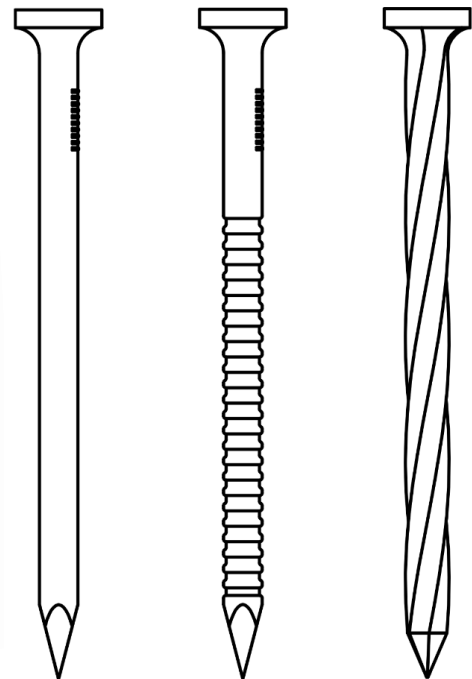
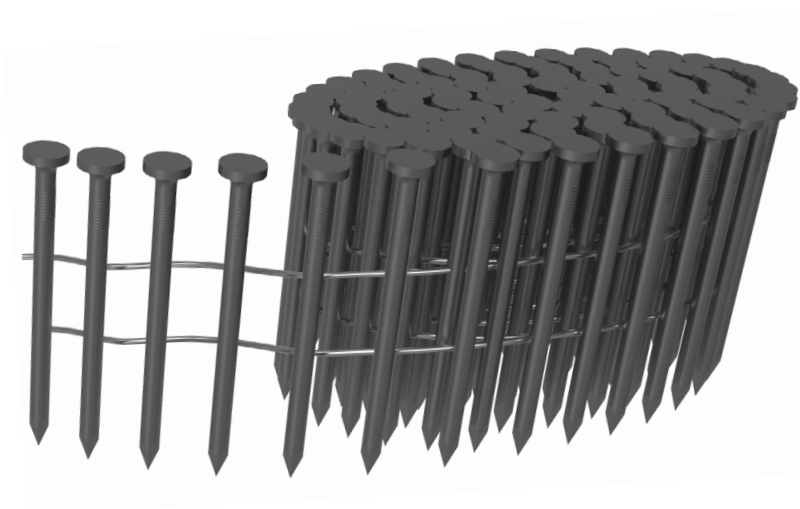

smooth

annular ring

screw

Table 1: Specification of Coiled Nails – Smooth Shank

Item No.	Length (inch)	Diameter (inch)	Collation Angle (°)	Finish	No./box
XCS-01	1-1/2	0.099	15	bright	6000
XCS-02	1-3/4	0.092	15	hot dipped galvanized	3600
XCS-03	2	0.092	15	galvanized	3600
XCS-04	2	0.092	15	galvanized	3600
XCS-05	2-1/4	0.092	15	galvanized	3600
XCS-06	2-1/4	0.092	15	galvanized	3600
XCS-07	2-1/4	0.092	15	hot dipped galvanized	3600
XCS-08	2	0.092	15	galvanized	6400
XCS-09	2	0.092	15	galvanized	7200
XCS-10	2	0.092	15	hot dipped galvanized	3600
XCS-11	2-1/4	0.092	15	galvanized	4800
XCS-12	2-1/4	0.092	15	galvanized	7200
XCS-13	2-1/4	0.092	15	hot dipped galvanized	3600
XCS-14	2	0.113	15	galvanized	6000
XCS-15	2	0.113	15	bright	6000
XCS-16	2-3/8	0.113	15	bright	6000
XCS-17	2-1/2	0.113	15	galvanized	6000
XCS-18	2-1/2	0.113	15	bright	6000
XCS-19	3	0.120	15	bright	4000
XCS-20	3-1/4	0.120	15	bright	4000
XCS-21	2-1/2	0.131	15	bright	3600
XCS-22	3	0.131	15	bright	3600
XCS-23	3	0.131	15	hot dipped galvanized	2400
XCS-24	3-1/4	0.131	15	galvanized	3600
XCS-25	3-1/4	0.131	15	bright	3600
XCS-26	3-1/4	0.131	15	hot dipped galvanized	2400
XCS-27	3-1/2	0.131	15	bright	3600
XCS-28	3	0.131	15	bright	2400
XCS-29	3-1/4	0.131	15	bright	2400
XCS-30	3-1/2	0.131	15	bright	2400
XCS-31	5	0.148	15	bright	1800

Table 2: Specification of Coiled Nails – Ring Shank

Item No.	Length (inch)	Diameter (inch)	Collation Angle (°)	Finish	Head/Point	No./box
XCR-01	2-1/4	0.099	15	Galvanized	Round/diamond	6600
XCR-02	2	0.099	15	bright	Round/diamond	6600
XCR-03	2-1/4	0.099	15	bright	Round/diamond	6600
XCR-04	2	0.099	15	bright	Round/diamond	6600
XCR-05	1-1/4	0.090	15	304 stainless steel	Round/diamond	3600
XCR-06	1-1/2	0.092	15	galvanized	Round/diamond	9000
XCR-07	1-1/2	0.090	15	304 stainless steel	Round/diamond	3600
XCR-08	1-3/4	0.092	15	304 stainless steel	Round/diamond	3600
XCR-09	1-3/4	0.092	15	hot dipped galvanized	Round/diamond	3600
XCR-10	1-3/4	0.092	15	hot dipped galvanized	Round/diamond	3600
XCR-11	1-7/8	0.092	15	galvanized	Round/diamond	3600
XCR-12	1-7/8	0.092	15	304 stainless steel	Round/diamond	3600
XCR-13	1-7/8	0.092	15	hot dipped galvanized	Round/diamond	3600
XCR-14	2	0.092	15	galvanized	Round/diamond	9000
XCR-15	2	0.092	15	304 stainless steel	Round/diamond	3600
XCR-16	2	0.092	15	hot dipped galvanized	Round/diamond	3600
XCR-17	2-1/4	0.092	15	galvanized	Round/diamond	3600
XCR-18	2-1/4	0.092	15	304 stainless steel	Round/diamond	3600
XCR-19	2-1/4	0.090	15	304 stainless steel	Round/diamond	3600
XCR-20	2-1/4	0.092	15	hot dipped galvanized	Round/diamond	3600
XCR-21	2-1/4	0.092	15	hot dipped galvanized	Round/diamond	3600
XCR-22	2-1/2	0.090	15	304 stainless steel	Round/diamond	3600
XCR-23	2-1/2	0.092	15	hot dipped galvanized	Round/diamond	3600
XCR-24	2-1/2	0.092	15	316 stainless steel	Round/diamond	3000
XCR-25	1-7/8	0.099	15	aluminum	Round/diamond	9000
XCR-26	2	0.113	15	bright	Round/diamond	6000
XCR-27	2-3/8	0.113	15	galvanized	Round/diamond	6000
XCR-28	2-3/8	0.113	15	304 stainless steel	Round/diamond	2700
XCR-29	2-3/8	0.113	15	bright	Round/diamond	6000
XCR-30	2-3/8	0.113	15	hot dipped galvanized	Round/diamond	2700
XCR-31	2-3/8	0.113	15	bright	Round/diamond	4000
XCR-32	1-3/4	0.120	15	304 stainless steel	Round/diamond	3600
XCR-33	3	0.120	15	galvanized	Round/diamond	3600
XCR-34	3	0.120	15	304 stainless steel	Round/diamond	2400
XCR-35	3	0.120	15	hot dipped galvanized	Round/diamond	2400
XCR-36	2-1/2	0.131	15	bright	Round/diamond	4000
XCR-37	1-1/4	0.082	15	bright	Round/diamond	15000
XCR-38	1-1/2	0.082	15	bright	Round/diamond	12000
XCR-39	1-3/4	0.082	15	bright	Round/diamond	12000

Table 3: Specification of Coiled Nails – Screw Shank

Item No.	Length (inch)	Diameter (inch)	Collation Angle (°)	Finish	Head/Point	No./box
XCR-01	2-1/4	0.099	15	Galvanized	Round/diamond	6600
XCR-02	2	0.099	15	bright	Round/diamond	6600
XCR-03	2-1/4	0.099	15	bright	Round/diamond	6600
XCR-04	2	0.099	15	bright	Round/diamond	6600
XCR-05	1-1/4	0.090	15	304 stainless steel	Round/diamond	3600
XCR-06	1-1/2	0.092	15	galvanized	Round/diamond	9000
XCR-07	1-1/2	0.090	15	304 stainless steel	Round/diamond	3600
XCR-08	1-3/4	0.092	15	304 stainless steel	Round/diamond	3600
XCR-09	1-3/4	0.092	15	hot dipped galvanized	Round/diamond	3600

Compatible Tools

Fits All Standard Coil Nail Guns

- Bostitch N12, RN45, RN46.
- Hitachi NV45 series.
- Makita AN451.
- Max CN450R, CN12R.
- Paslode 3175, 44RCU, 405000.
- Senco RoofPro, RoofPro 455XP, SCN40R.
- Spotnails VRN45.



3. Concrete Nails

Also called masonry nails. Available in smooth shank, straight fluted & twilled fluted shank for different substrate hardness.

- Hardness: > HRC 50° .
- Securing objects into masonry and other hard & brittle materials.
- Various special nail heads and shank types.
- Excellent anti-bending, anti-crack performance.
- Fluted shank provide greatest holding power.
- Surface treatment: hot dipped galvanized, blank zinc coated.



Application

Concrete nails are used for various securing materials to concrete wall and blocks

Projects

- Building construction.
- Home improvement projects.

Substrates

- Cinder blocks.
- Brick substrate.
- Bamboo pieces.

Substrates

- Furring strips fixation.
- Wood framing fixation.
- Metal base fixation.
- Ledger board fixation.
- Garage poured fixation.
- Hand rails fixation.

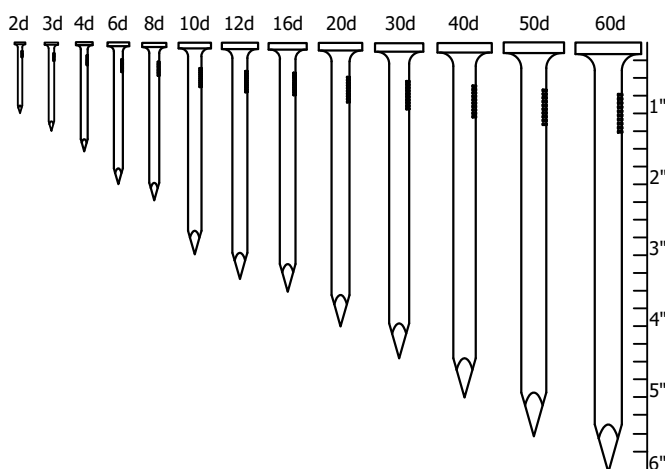

Item No.	Size (d)	Length (inch)	Rod Diameter (gauge)
XCMN-01	—	3/8	20
XCMN-02	—	1/2	20/19/18
XCMN-03	—	5/8	19/18
XCMN-04	—	3/4	18/17
XCMN-05	—	7/8	18/17
XCMN-06	2	1	16
XCMN-07	3	1-1/4	15/14
XCMN-08	4	1-1/2	14
XCMN-09	5	1-3/4	13
XCMN-10	6	2	12/11
XCMN-11	8	2-1/2	11/10
XCMN-12	10	3	10/8
XCMN-13	16	3-1/2	8/7
XCMN-14	20	4	8/7/6
XCMN-15	30	4-1/2	7/6/5
XCMN-16	40	5	6/5
XCMN-17	60	6	6/5/4
XCMN-18	70	7	5/4

4. Roofing Nails

Roofing nails, with smooth or twist shanks and umbrella head, are designed for roofing materials installation.

- Umbrella head prevent the roofing sheets from tearing off around the head of the nail.
- Rubber/plastic washer for additional stability & adhesion.
- Twist ring shanks offer excellent withdrawal resistance.
- Length is from the point to the underside of the head.
- Surface treatment: electro galvanized, hot dipped galvanized.



Application

- Building construction.
- Wooden furniture.
- Connect timber pieces.
- Asbestos shingle.
- Plastic tile fixed.
- Wooden construction.
- Indoor decorations.
- Roofing sheets.

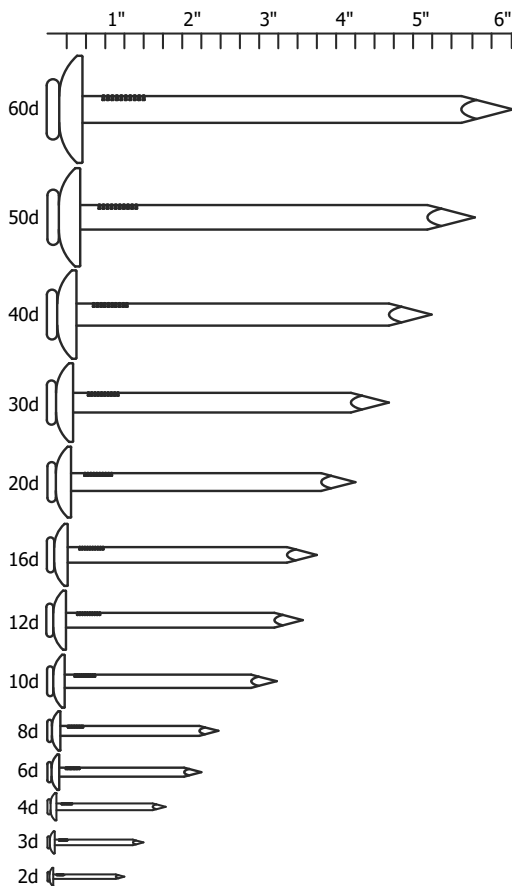

Item No.	Size (d)	Length (inch)	Diameter (gauge)	Head Diameter (inch)	Head
XGRN-01	6	2	8	0.79	umbrella
XGRN-02	8	2-1/2	8	0.79	umbrella
XGRN-03	10	3	8	0.79	umbrella
XGRN-04	4	1-1/2	9	0.79	umbrella
XGRN-05	6	2	9	0.79	umbrella
XGRN-06	8	2-1/2	9	0.79	umbrella
XGRN-07	10	3	9	0.79	umbrella
XGRN-08	5	1-3/4	10	0.79	umbrella
XGRN-09	6	2	10	0.79	umbrella
XGRN-10	8	2-1/2	10	0.79	umbrella
XGRN-11	4	1-1/2	11	0.71	umbrella
XGRN-12	5	1-3/4	11	0.71	umbrella
XGRN-13	6	2	11	0.71	umbrella
XGRN-14	8	2-1/2	11	0.71	umbrella
XGRN-15	4	1-1/2	12	0.71	umbrella
XGRN-16	5	1-3/4	12	0.71	umbrella
XGRN-17	6	2	12	0.71	umbrella
XGRN-18	4	1-1/2	13	0.59	umbrella
XGRN-19	5	1-3/4	13	0.59	umbrella
XGRN-20	6	2	13	0.59	umbrella
XGRN-21	5	1-3/4	14	0.55	umbrella

5. Square Boat Nails

Square boat nails are designed with tapered square nail shank & sharp point. The square nail shank has a tapered section for increasing connecting area.

- Made of heavy duty steel wire.
- Wooden boat building and other hardwood construction projects.
- Outstanding durability and holding power.
- Great for historic renovation & preservation.
- Surface treatment: galvanized, hot dipped galvanized, copper coated



Application

- Boat building.
- Historic renovation.
- Hardwood flooring.
- Vintage reproductions.

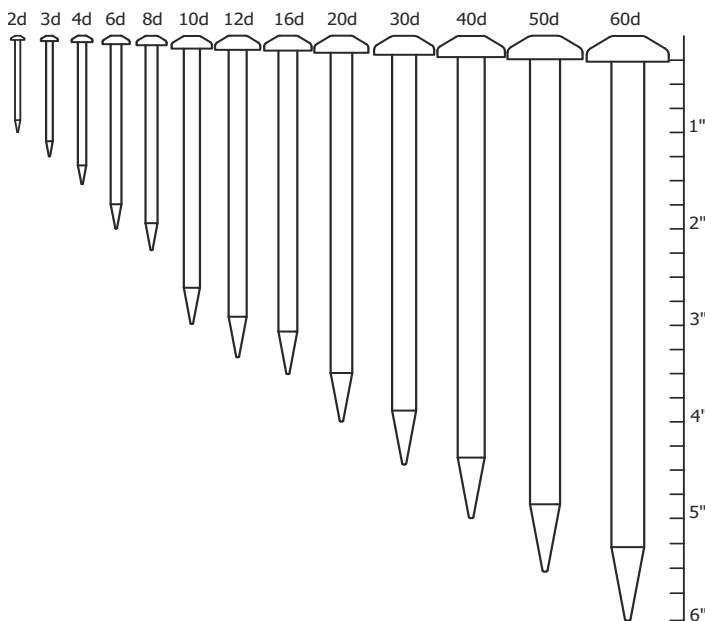

Item No.	Size (d)	Length (inch)	Diameter (gauge)
XBS-01	2	1	14
XBS-02	2	1	15
XBS-03	2	1	16
XBS-04	3	1-1/4	14
XBS-05	4	1-1/2	13
XBS-06	4	1-1/2	14
XBS-07	5	1-3/4	13
XBS-08	6	2	12
XBS-09	8	2-1/2	10
XBS-10	10	3	8
XBS-11	11	3-1/2	7
XBS-12	20	4	6
XBS-13	40	5	5
XBS-14	60	6	4

6. Horseshoe Nails

The copper coated or copper horseshoe nails not only hold the shoe in place but also cure the horses with white line disease and seedy toe.

- Designed for hoof health of all horse types.
- Copper coating has antimicrobial properties.
- Improving hoof health been released.
- Less microbial damage to the surrounding hoof tissue.
- Smooth shank for different hoof wall angles.
- Surface treatment: copper-coated.

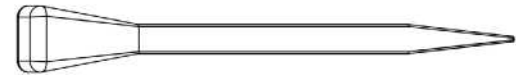

Application

- Saddle horses.
- Working horses.
- Racing horses.
- Draught horses.
- Ponies.
- Show horses.



E type
a classic & multiple-used nail



E slim
longer & thinner than the E-nail



EXL type
with extra long & slim shank



MX type
for horses with very sensitive, thin hoof walls



JC type
ideal for small ponies, work well with polyurethane shoes



RN type
a classic American nail for race horses



City head
for American made shoes



Regular head
for heavy, pack & working horses

E type		E Slim type		EXL type		MX type	
Size	Length (mm)	Size	Length (mm)	Size	Length (mm)	Size	Length (mm)
E2	41	E Slim2	45.5	EXL8	62	MX45	45
E3	45	E Slim3	47.5	EXL9	65	MX50	51
E4	47.5	E Slim4	51	EXL10	70	MX55	54
E5	51	E Slim5	54	—	—	MX60	60.5
E6	54	E Slim6	57.5	—	—	MX65	65
E7	57	E Slim7	61	—	—	MX70	70
E8	62	—	—	—	—	—	—
E9	64	—	—	—	—	—	—
E10	68	—	—	—	—	—	—
E11	72	—	—	—	—	—	—
E12	77	—	—	—	—	—	—
E14	80	—	—	—	—	—	—

JC type		RN type		City head		Regular head	
Size	Length (mm)	Size	Length (mm)	Size	Length (mm)	Size	Length (mm)
JC00	41	RN3.5	38.5	CH4	45	REG4	45
JC0	45	RN3.5 XL	41	CH4.5	47.5	REG5	50
JC1	49	RN4.5	44	CH5	50	REG6	54
JC2	53	RN5	47	CH6	54	REG7	59
JC3	57	—	—	—	—	REG8	64
JC4	61	—	—	—	—	REG9	68
JC5	65	—	—	—	—	REG10	73
JC6	69	—	—	—	—	REG12	81
JC7	73	—	—	—	—	REG16	97

7. Ring Shank Nails

Ring shank nails, with screw-like shank and diamond point, are designed for construction projects that need greater holding power.

- Offer a 40% more holding power than common nails.
- Annular ring shank threads for extra grip.
- Ring patterns can vary according to customers' demands.
- Great staying power and resistant to bending.
- Surface treatment: bright, electro galvanized, vinyl coated, polished.
- Standard: ASTM F1667, ASTM A153.



Application

- Plywood.
- Decking.
- Pallets.
- Truss rafters.
- Floors.
- Underlayment.
- Paneling.
- Clapboards.
- Shingles.
- Drywall.
- Siding.
- Roofing.

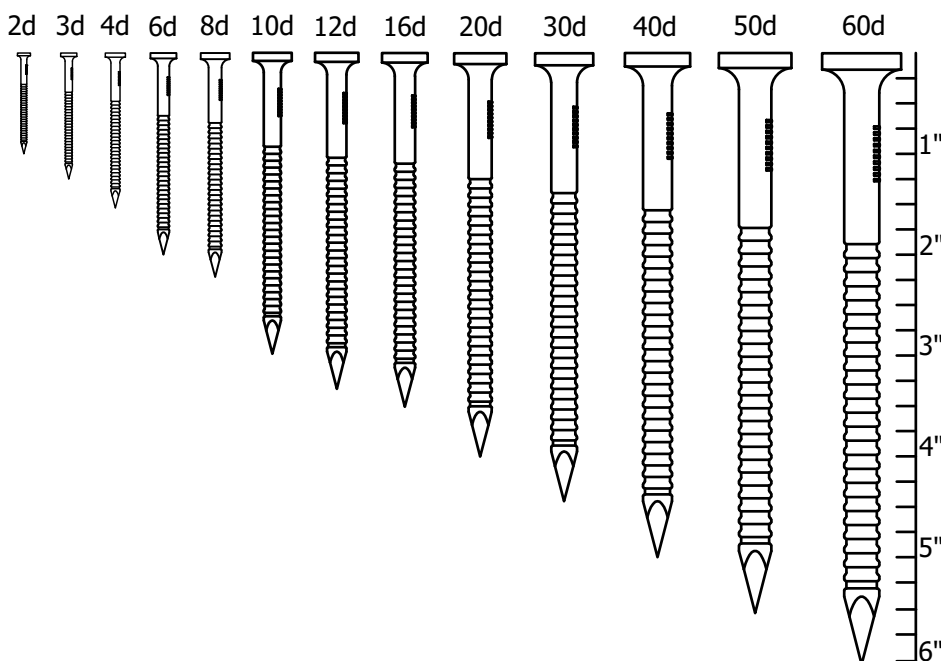

Item No.	Length (inch)	Dia. (inch)	Head Dia. (inch)	T1-Dia.		TL Min.	P		Root Dia.
				Max.	Min.		Max.	Min.	
For Post Frame									
XRS-01	3	0.135	5/16	0.010	0.005	2.25	0.077	0.050	0.128
XRS-02	3	0.148	5/16	0.010	0.005	2.25	0.077	0.050	0.140
XRS-03	3	0.177	3/8	0.010	0.005	2.25	0.077	0.050	0.169
XRS-04	3.5	0.135	5/16	0.010	0.005	2.25	0.077	0.050	0.128
XRS-05	3.5	0.148	5/16	0.010	0.005	2.25	0.077	0.050	0.140
XRS-06	3.5	0.177	3/8	0.010	0.005	2.25	0.077	0.050	0.169
XRS-07	3.5	0.200	15/32	0.010	0.005	2.25	0.077	0.050	0.193
XRS-08	4	0.148	5/16	0.010	0.005	2.25	0.077	0.050	0.140
XRS-09	4	0.177	3/8	0.010	0.005	2.25	0.077	0.050	0.169
XRS-10	4	0.200	15/32	0.010	0.005	2.25	0.077	0.050	0.193
XRS-11	4	0.207	15/32	0.010	0.005	2.25	0.077	0.050	0.199
XRS-12	4.5	0.148	5/16	0.010	0.005	3	0.077	0.050	0.140
XRS-13	4.5	0.177	3/8	0.010	0.005	3	0.077	0.050	0.169
XRS-14	4.5	0.200	15/32	0.010	0.005	3	0.077	0.050	0.193
XRS-15	4.5	0.207	15/32	0.010	0.005	3	0.077	0.050	0.199
XRS-16	5	0.177	3/8	0.010	0.005	3	0.077	0.050	0.169
XRS-17	5	0.200	15/32	0.010	0.005	3	0.077	0.050	0.193
XRS-18	5	0.207	15/32	0.010	0.005	3	0.077	0.050	0.199
XRS-19	6	0.177	3/8	0.010	0.005	3	0.077	0.050	0.169
XRS-20	6	0.200	15/32	0.010	0.005	3	0.077	0.050	0.193
XRS-21	6	0.207	15/32	0.010	0.005	3	0.077	0.050	0.199
XRS-22	8	0.177	3/8	0.010	0.005	3	0.077	0.050	0.169
XRS-23	8	0.200	15/32	0.010	0.005	3	0.077	0.050	0.193
XRS-24	8	0.207	15/32	0.010	0.005	3	0.077	0.050	0.199
For Roof Sheathing									
XRS-25	2-3/8	0.113	0.281	0.012	0.005	1-1/2	0.077	0.050	—
XRS-26	2-1/2	0.120	0.281	0.012	0.005	1-1/2	0.077	0.050	—
XRS-27	2-1/2	0.131	0.281	0.012	0.005	1-1/2	0.077	0.050	—
XRS-28	3	0.120	0.281	0.012	0.005	1-1/2	0.077	0.050	—
XRS-29	3	0.131	0.281	0.012	0.005	1-1/2	0.077	0.050	—

TL: length of threaded shank.

T1: crest diameter.

P: pitch, or spacing of threads.

Root diameter: a calculated value and is not specified as a dimension to be measured.

8. Finishing Nails

Finishing nails, featured with a small globular head, act as the fasteners while offering a decorative effect.



- For finish works where modification surface is needed.
- Brad head for a less-visible appearance.
- Smooth shank, diamond point for easier driving.
- Driven by a special tool called a nail set.
- Can be collated for pneumatic nail guns.
- Surface treatment: bright, electro galvanized, hot dipped galvanized, copper-plated.

Application

- Furniture making.
- Indoor decorations.
- Cabinetwork.
- Trim and baseboard.
- Molding making.
- Cladding floor boards.
- Floor strips.
- Decoration strips.

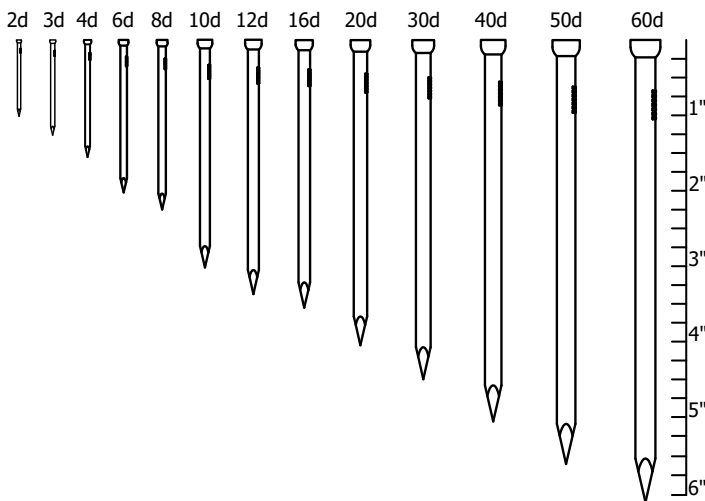

Item No.	Size (d)	Length (inch)	Diameter (gauge)	Head Dia. (inch)	No./lb
XFN-01	2	1	16-1/2	0.086	1473
XFN-02	3	1-1/4	15-1/2	0.099	880
XFN-03	4	1-1/2	15	0.1055	630
XFN-04	5	1-3/4	15	0.1055	535
XFN-05	6	2	13	0.135	288
XFN-06	7	2-1/4	13	0.135	254
XFN-07	8	2-1/2	12-1/2	0.142	196
XFN-08	9	2-3/4	12-1/2	0.142	178
XFN-09	10	3	11-1/2	0.155	124
XFN-10	12	3-1/4	11-1/2	0.155	113
XFN-11	16	3-1/2	11	0.162	93
XFN-12	20	4	10	0.177	65
XFN-13	30	4-1/2	9	0.186	60
XFN-14	40	5	8	0.194	56

9. Corrugated Fasteners

CF, W and X corrugated fasteners are designed for wood corner frame connection.

- A remedy for damaged adjacent timbers caused by nails or screws.
- Versatile for indoor & outdoor mitre joints.
- Alternating grooves for strong and hidden holding power.
- High rust resistance and retention force.
- Surface treatment: bright, galvanized, phosphate coated.



Application

- Cabinet and furniture frames.
- Decking board.
- Real wood door.
- Truss construction.
- Picture frames.
- Wood boxes.
- Upholstery bed frames..
- Repair splits in pallet stringers.
- Windows.

Styles



CF corrugated fasteners



W corrugated fasteners

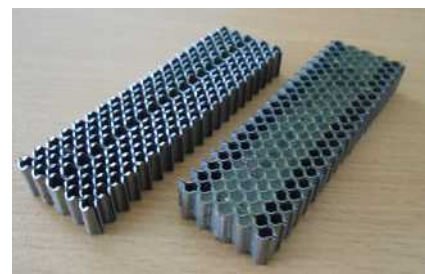

X corrugated fasteners

Tools & Connection



Just install it with a hammer



Pneumatic corrugated fastener tool

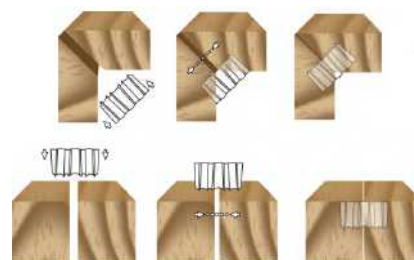

For mitre joint & butt joint

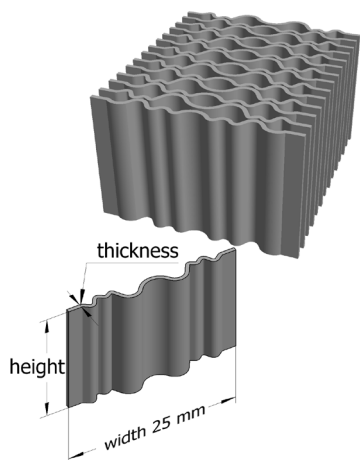

Item No.	Length (mm)	Height (inch)	Width (mm)	Thickness (mm)
CF Type				
XCF08	8	5/16	25	0.5
XCF10	10	3/8	25	0.5
XCF13	13	1/2	25	0.5
XCF15	15	5/8	25	0.5

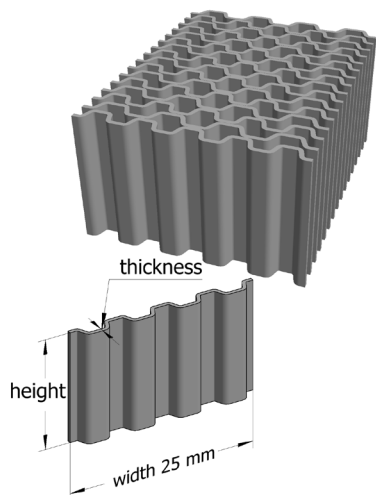

Item No.	Length (mm)	Height (inch)	Width (mm)	Thickness (mm)
W Type				
XCW08	8	1/4	25	0.5
XCW09	9	3/8	25	0.5
XCW12	12	1/2	25	0.5
XCW15	15	5/8	25	0.5

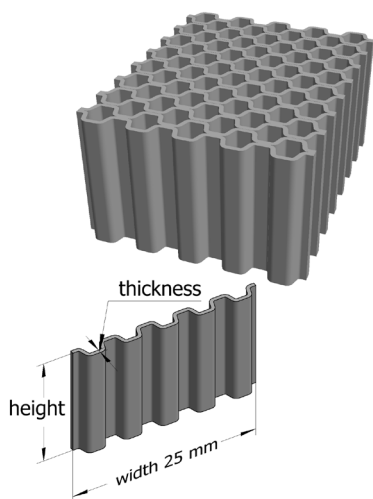

Item No.	Length (mm)	Height (inch)	Width (mm)	Thickness (mm)
X Type				
XCW04	4	1/4	25	0.5
XCW06	6	3/8	25	0.5
XCW08	8	1/2	25	0.5
XCW10	10	5/8	25	0.5

10. Plastic Collated Nails

Plastic collated nails are held together with plastic strip or band to prevent deterioration due to weather conditions or high humidity.

- No sting, no jams, no waste.
- Cost saving and fairly durable.
- Resistant to damage due to water, heat or cold.
- Work well with all standard corresponding framing nailers.
- Great holding power and resistant to bending.
- Surface treatment: bright, electro galvanized, hot dipped galvanized.



Application

- Carpentry.
- Framing.
- Sheathing material.
- Truss building.
- Subflooring.
- Side wall fixation.
- Pallets & crate assembly.
- Real wood door.

Styles



Plastic collated nails
— smooth shank



Plastic collated nails — ring shank



Plastic collated nails — screw shank

Tools & Connection

- Bostitch.
- Dewalt.
- Duo-Fast.
- Fasco.
- Hitachi.
- Makita.
- Max.
- Paslode.
- Porter Cable.
- Senco.
- Spotnails.
- Grip-Rite.



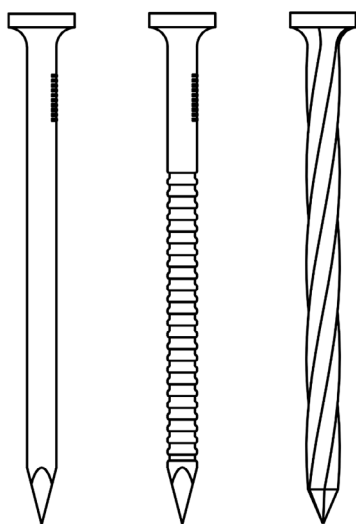

smooth annular ring screw

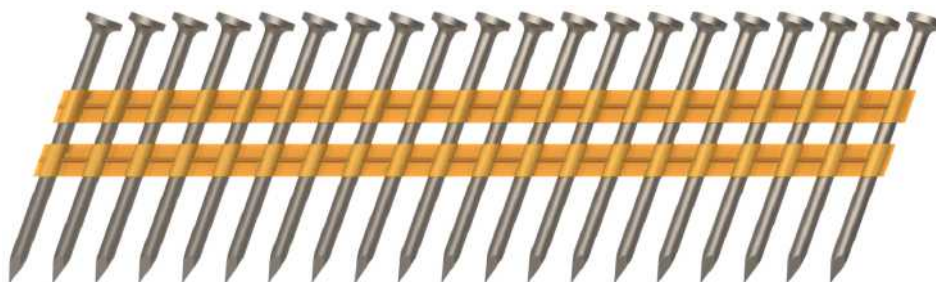

Item No.	Length (inch)	Diameter (inch)	Point	Finish	Collation Angle	No./box
Smooth Shank						
XMP-01	2	0.113	diamond	bright	20°	5000
XMP-02	2-1/4	0.113	diamond	bright hardened	20°	2800
XMP-03	2-1/4	0.148	diamond	bright	20°	4000
XMP-04	2-3/8	0.113	diamond	bright	20°	2500
XMP-05	2-3/8	0.113	diamond	bright	20°	5000
XMP-06	2-1/2	0.113	diamond	bright hardened	20°	5000
XMP-07	2-1/2	0.131	diamond	bright	20°	4000
XMP-08	2-1/2	0.131	diamond	bright	20°	2500
XMP-09	3	0.120	diamond	bright	20°	4000
XMP-10	3	0.131	diamond	bright	20°	4000
XMP-11	3	0.131	diamond	bright	20°	2500
XMP-12	3	0.148	diamond	bright	20°	4000
XMP-13	3	0.148	diamond	bright	20°	2000
XMP-14	3-1/4	0.120	diamond	bright	20°	4000
XMP-15	3-1/4	0.131	diamond	bright	20°	4000
XMP-16	3-1/4	0.131	diamond	bright	20°	2500
XMP-17	3-1/4	0.148	diamond	bright	20°	4000
XMP-18	3-1/2	0.131	diamond	bright	20°	4000
XMP-19	3-1/2	0.131	diamond	bright	20°	2500
XMP-20	3-1/2	0.162	diamond	bright	20°	1800
XMP-21	2	0.113	diamond	galvanized	20°	5000
XMP-22	2-1/2	0.113	diamond	galvanized	20°	5000
XMP-23	2-1/2	0.113	diamond	galvanized	20°	2500
XMP-24	2-1/2	0.120	diamond	hot dipped galvanized	20°	2300
XMP-25	2-1/2	0.120	diamond	galvanized	20°	2500
XMP-26	3	0.131	diamond	hot dipped galvanized	20°	2300
XMP-27	3	0.131	diamond	hot dipped galvanized	20°	2500

Item No.	Length (inch)	Diameter (inch)	Point	Finish	Collation Angle	No./box
XMP-28	3	0.131	diamond	galvanized	20°	4000
XMP-29	3	0.131	diamond	galvanized	20°	2500
XMP-30	3-1/4	0.131	diamond	hot dipped galvanized	20°	2500
XMP-31	3-1/4	0.131	diamond	galvanized	20°	4000
XMP-32	3-1/4	0.131	diamond	galvanized	20°	2500
XMP-33	3-1/2	0.131	diamond	hot dipped galvanized	20°	2500
XMP-34	3-1/2	0.131	chisel	hot dipped galvanized	20°	4000
XMP-35	3-1/2	0.131	diamond	hot dipped galvanized	20°	2500
XMP-36	3-1/4	0.131	diamond	stainless	20°	1000

Ring Shank

XRP-01	2	0.113	diamond	bright	20°	5000
XRP-02	2-3/8	0.113	diamond	bright	20°	5000
XRP-03	2-3/8	0.113	diamond	bright	20°	2500
XRP-04	2	0.113	diamond	hot dipped galvanized	20°	2500
XRP-05	2-3/8	0.113	diamond	galvanized	20°	5000
XRP-06	2-3/8	0.113	diamond	galvanized	20°	2500
XRP-07	2-3/8	0.113	diamond	hot dipped galvanized	20°	2500
XRP-08	3	0.120	diamond	galvanized	20°	4000
XRP-09	3	0.120	diamond	hot dipped galvanized	20°	2500
XRP-10	2-3/8	0.113	diamond	stainless	20°	1000
XRP-11	3	0.120	diamond	stainless	20°	1000

Screw Shank

XSP-01	2	0.113	diamond	stainless	20° /21° /22°	5000
XSP-02	2	0.113	diamond	stainless	20° /21° /22°	1000
XSP-03	2-1/2	0.113	diamond	stainless	20° /21° /22°	4000
XSP-04	2-1/2	0.113	diamond	stainless	20° /21° /22°	1000
XSP-05	3	0.120	diamond	stainless	20° /21° /22°	4000
XSP-06	3	0.120	diamond	stainless	20° /21° /22°	1000
XSP-07	4	0.131	diamond	stainless	20° /21° /22°	1000
XSP-08	3-1/4	0.120	diamond	stainless	20° /21° /22°	4000
XSP-09	3-1/4	0.120	diamond	stainless	20° /21° /22°	1000
XSP-10	3-1/2	0.131	diamond	stainless	20° /21° /22°	4000
XSP-11	3-1/2	0.131	diamond	stainless	20° /21° /22°	1000

11. Paper Collated Nails

Compared with plastic collated nails and wire collated nails, these paper strip nails are more expensive but safer and cleaner during the driving operation.

- No sting, no jams, no waste.
- Fit all 28° to 34° pneumatic nailer tools.
- Hot dipped galvanizing for uses in ACQ treated lumber.
- Great holding power and resistant to bending.
- Meet all applicable ASTM standards.
- Fit performance standards for building codes.

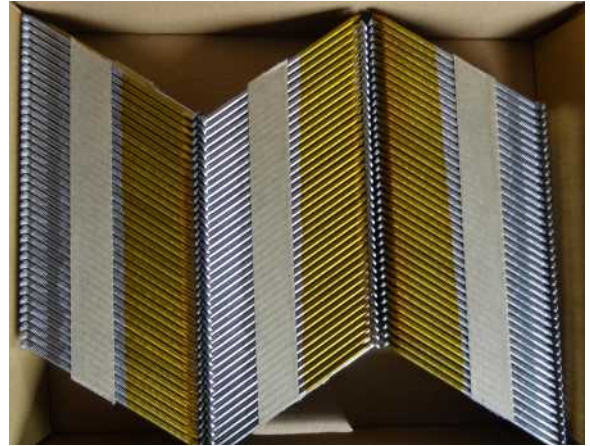

Application

- Carpentry.
- Framing.
- Truss building.
- Subflooring.
- Side wall fixation.
- Pallets & crate assembly.
- Real wood door.

Styles



Paper collated nails — smooth shank



Paper collated nails — ring shank

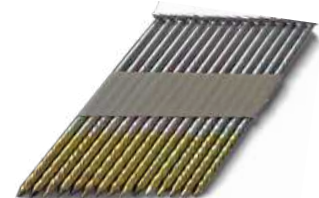

Paper collated nails — screw shank

Tools & Connection

Fits All Standard Pneumatic Framing Nailer.

- Senco: JoistPro150, JoistPro250.
- Hitachi: NR65AK, NR65AKS.
- Paslode: 5250/65SPP.
- Grip Rite: GR150.



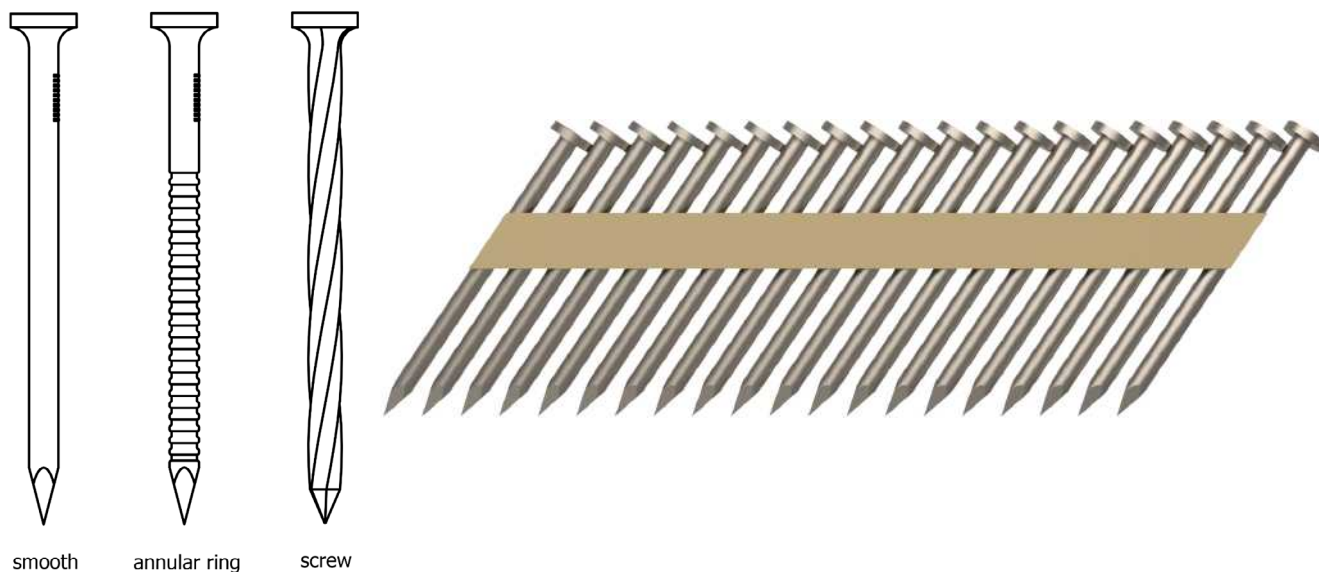

Table 1: Specification of Coiled Nails – Smooth Shank

Item No.	Length (inch)	Diameter (inch)	Point	Finish	Collation Angle	No./box
Smooth Shank						
XPM-01	1-1/2	0.131	diamond	bright	34°	1000
XPM-02	1-1/2	0.131	diamond	bright hardened	34°	1000
XPM-03	2	0.113	diamond	bright	34°	2000
XPM-04	2	0.113	diamond	bright	34°	2500
XPM-05	2-1/4	0.113	diamond	bright	34°	5000
XPM-06	2-1/4	0.113	diamond	bright hardened	34°	1000
XPM-07	2-3/8	0.113	diamond	bright	34°	2000
XPM-08	2-3/8	0.113	diamond	bright	34°	2500
XPM-09	2-3/8	0.113	diamond	bright	34°	2500
XPM-10	2-1/2	0.113	diamond	bright	34°	5000
XPM-11	2-3/4	0.120	diamond	bright	34°	3000
XPM-12	3	0.120	diamond	bright	34°	2500
XPM-13	3	0.120	diamond	bright	34°	2500
XPM-14	3	0.120	diamond	bright	34°	3000
XPM-15	3	0.120	diamond	bright	34°	3000
XPM-16	3	0.131	diamond	bright	34°	2500
XPM-17	3	0.131	diamond	bright	34°	2000
XPM-18	3	0.131	diamond	bright	34°	3000
XPM-19	3-1/4	0.120	diamond	bright	34°	2000
XPM-20	3-1/4	0.120	diamond	bright	34°	2500
XPM-21	3-1/4	0.120	diamond	bright	34°	3000
XPM-22	3-1/4	0.131	diamond	bright	34°	2000
XPM-23	3-1/2	0.131	diamond	bright	34°	2000
XPM-24	3-1/4	0.131	diamond	bright	34°	2500
XPM-25	3-1/4	0.131	diamond	bright	34°	3000

Item No.	Length (inch)	Diameter (inch)	Point	Finish	Collation Angle	No./box
Smooth Shank						
XPM-26	3-1/2	0.131	diamond	bright	34°	3000
XPM-27	4	0.131	diamond	bright	34°	2400
XPM-28	3-1/2	0.135	diamond	bright	34°	3000
XPM-29	2	0.113	diamond	galvanized	34°	2500
XPM-30	2-3/8	0.113	diamond	hot dipped galvanized	34°	2000
XPM-31	2-1/2	0.113	diamond	galvanized	34°	5000
XPM-32	2-1/2	0.131	diamond	galvanized	34°	5000
XPM-33	3	0.120	diamond	galvanized	34°	3000
XPM-34	3	0.131	chisel	hot dipped galvanized	34°	1000
XPM-35	3	0.131	diamond	Hot dipped galvanized	34°	2000
XPM-36	3-1/4	0.131	diamond	Hot dipped galvanized	34°	2000
XPM-37	3-1/4	0.131	diamond	galvanized	34°	3000
XPM-38	3-1/2	0.131	diamond	Hot dipped galvanized	34°	2000
XPM-39	3-1/2	0.131	diamond	galvanized	34°	3000
XPM-40	3	0.131	diamond	stainless	34°	1000
XPM-41	3-1/4	0.131	diamond	stainless	34°	1000
Ring Shank						
XPR-01	2	0.113	diamond	bright	34°	2000
XPR-02	2	0.113	diamond	bright	34°	2500
XPR-03	2-3/8	0.113	diamond	bright	34°	5000
XPR-04	2-3/8	0.113	diamond	bright	34°	2000
XPR-05	2-3/8	0.113	diamond	bright	34°	2500
XPR-06	2	0.113	diamond	Hot dipped galvanized	34°	2000
XPR-07	2	0.113	diamond	Hot dipped galvanized	34°	2000
XPR-08	2-3/8	0.113	diamond	galvanized	34°	1500
XPR-09	2-3/8	0.113	diamond	galvanized	34°	1500
XPR-10	2-3/8	0.113	diamond	galvanized	34°	2000
XPR-11	2-3/8	0.113	diamond	Hot dipped galvanized	34°	2000
XPR-12	2-3/8	0.113	diamond	Hot dipped galvanized	34°	2000
XPR-13	3	0.120	diamond	galvanized	34°	2000
XPR-14	3	0.120	diamond	Hot dipped galvanized	34°	2000
XPR-15	2-3/8	0.113	diamond	stainless	34°	1000
XPR-16	3	0.120	diamond	stainless	34°	1000
Screw Shank						
XPS-01	3	0.120	chisel	bright	34°	3100
XPS-02	3	0.120	diamond	Hot dipped galvanized	34°	2000
XPS-03	3	0.120	chisel	Hot dipped galvanized	34°	1000
XPS-04	3	0.120	diamond	stainless	34°	1000

**Table 2: Specification of
34° Paper Tape Collated Nail – Round Head**

Item No.	Length (inch)	Diameter (inch)	Point	Finish	Collation Angle	No./box
Smooth Shank						
XPRM-01	2-3/8	0.113	diamond	bright	34°	2000
XPRM-02	3	0.120	diamond	bright	34°	2000
XPRM-03	3	0.131	diamond	bright	34°	2000
XPRM-04	3-1/4	0.131	diamond	bright	34°	2000
XPRM-05	3-1/2	0.131	diamond	bright	34°	2000
XPRM-06	2	0.113	diamond	hot dipped galvanized	34°	2000
XPRM-07	2-3/8	0.113	diamond	hot dipped galvanized	34°	2000
XPRM-08	3	0.120	diamond	hot dipped galvanized	34°	2000
XPRM-09	3	0.131	diamond	hot dipped galvanized	34°	2000
XPRM-10	3-1/4	0.131	diamond	hot dipped galvanized	34°	2000
Ring Shank						
XPRR-01	2-3/8	0.113	diamond	bright	34°	2000
XPRR-02	3	0.120	diamond	bright	34°	2000
XPRR-03	2	0.113	diamond	hot dipped galvanized	34°	2000
XPRR-04	2-3/8	0.113	diamond	hot dipped galvanized	34°	2000
XPRR-05	3	0.120	diamond	hot dipped galvanized	34°	2000
XPRR-06	3	0.131	diamond	hot dipped galvanized	34°	2000

12. Duplex Nails

Duplex nail, once called a scaffold nail, is now known as a double-headed nail. It is designed to for easy removal when a temporary construction projects finished.

- Designed for temporary structures.
- Double head for easily dismantlement.
- The lower head remains exposed.
- As strong as common nails and reused.
- Great holding power and resistant to bending.
- Surface treatment: bright, polished.
- Standard: ASTM F1667, ASTM A153.



Application

- Concrete pouring.
- Scaffolding.
- Temporary braces.
- Wood construction.
- Theatrical scenery.

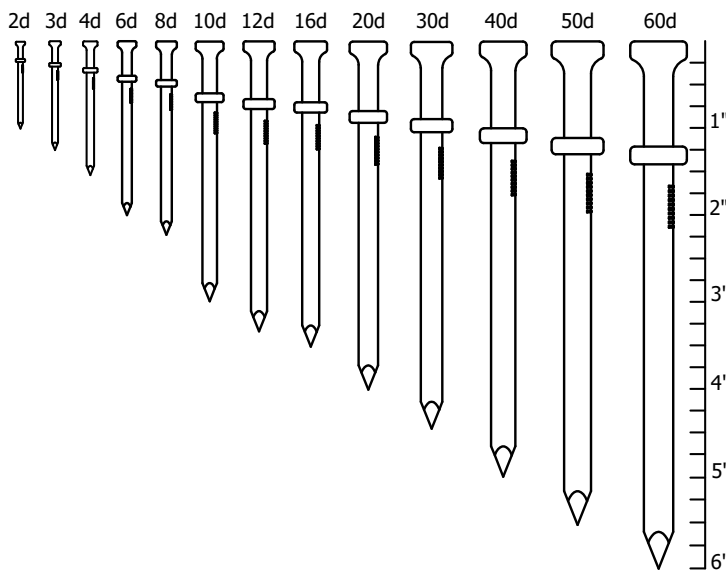

Item No.	Size (d)	Length (inch)	Diameter (inch)	Head Dia. (inch)	No./lb
XDN-01	5	1-3/4	0.113	1/4	160
XDN-02	7	2-1/4	0.131	1/4	90
XDN-03	9	2-3/4	0.148	5/16	59
XDN-04	10	3	0.162	3/8	45
XDN-05	11	3-1/2	0.192	3/8	28
XDN-06	20	4	0.207	7/16	22

13. Clout Nails

Clout nails, also known as shingle nails or felt nails, are commonly used to fix soft materials such as plasterboard and roofing felt.

- Suitable for use with both soft and hard wood.
- Large flat head is flush with the material.
- Twist ring shanks offer excellent withdrawal resistance.
- Various surface coatings for increased durability.
- Can be collated for pneumatic nail gun operation.
- Surface treatment: polish, electro galvanized, hot dipped galvanized or vinyl coated.



Application

- Roofing felt.
- Plastic foams.
- Lightweight boards.
- Wall insulation boards.
- Cedar roofing shingles.
- Pressboard.
- Plastic board.
- Plaster board.
- Timber fence palings.

Styles



Clout nails — smooth shank



Clout nails — smooth shank



Clout nails — smooth shank

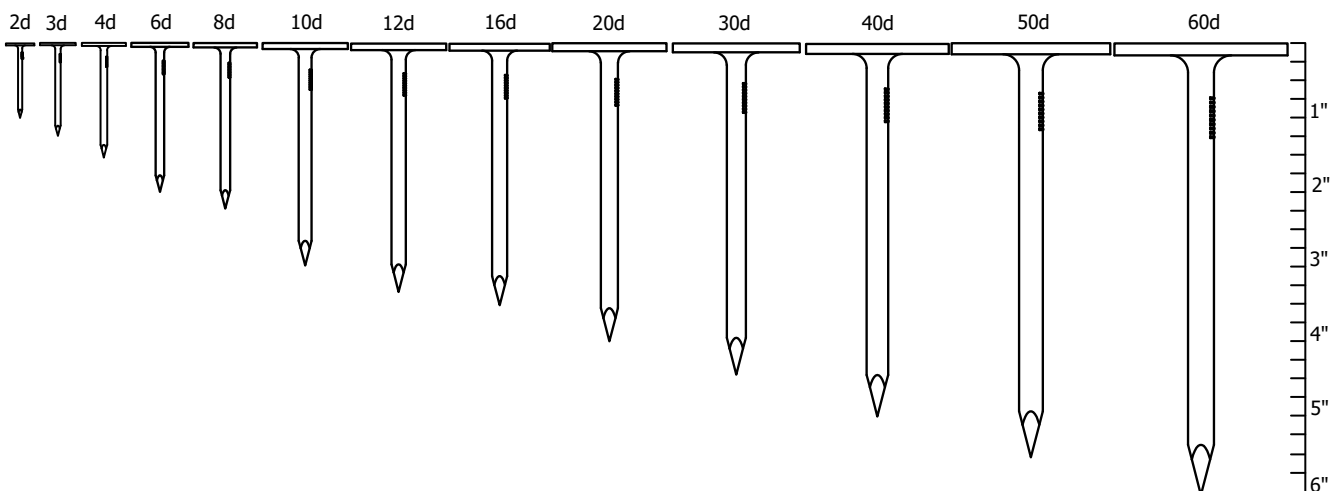

Item No.	Size (d)	Length (inch)	Rod Diameter (gauge)	Finish
XCR-01	2-1/4	0.099	15	Galvanized
XCR-02	2	0.099	15	bright
XCR-03	2-1/4	0.099	15	bright
XCR-04	2	0.099	15	bright
XCR-05	1-1/4	0.090	15	304 stainless steel
XCR-06	1-1/2	0.092	15	galvanized
XCR-07	1-1/2	0.090	15	304 stainless steel
XCR-08	1-3/4	0.092	15	304 stainless steel
XCR-09	1-3/4	0.092	15	hot dipped galvanized
XCR-10	1-3/4	0.092	15	hot dipped galvanized
XCR-11	1-7/8	0.092	15	galvanized
XCR-12	1-7/8	0.092	15	304 stainless steel
XCR-13	1-7/8	0.092	15	hot dipped galvanized
XCR-14	2	0.092	15	galvanized
XCR-15	2	0.092	15	304 stainless steel
XCR-16	2	0.092	15	hot dipped galvanized
XCR-17	2-1/4	0.092	15	galvanized
XCR-18	2-1/4	0.092	15	304 stainless steel
XCR-19	2-1/4	0.090	15	304 stainless steel
XCR-20	2-1/4	0.092	15	hot dipped galvanized
XCR-21	2-1/4	0.092	15	hot dipped galvanized

14. U Nails

U nails, with two-pronged shanks, are usually used for attaching the mesh fences to wooden posts and frame, hence the name fencing staples.

- Designed for gardening & agriculture.
- U shaped head for binding the wires in position.
- Slice cut sharp point for easy operation.
- Great staying power and resistant to bending.
- Polished, copper-plated & galvanized for rust resistance.
- Standard: ASTM F1667, ASTM A153.



Application

U shaped nails are versatile for fixing the rabbit wire, field fence, poultry netting, barbed wire, chicken wire and welded wire mesh on wooden construction. E.g.

- Bird aviaries.
- Animal hutches.
- Chicken coops.
- Pig areas.
- Plant trellis.
- Raised gardening bed.

Styles



U nails – smooth shank



U nails – single barbed shank



U nails – double barbed shank

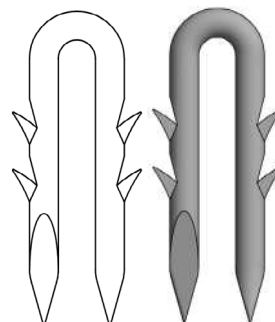
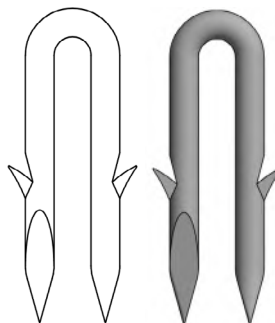
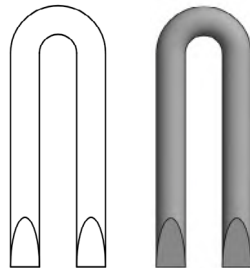

Item No.	Length (inch)	Diameter (inch)
Smooth Shank		
XUS-01	3/4	1.25-2
XUS-02	3/4	0.080
XUS-03	3/4	0.110
XUS-04	3/4	0.148
XUS-05	1	0.080
XUS-06	1	0.110
XUS-07	1	0.133
XUS-08	1	0.148
XUS-09	1-1/4	0.148
Single Barbed Shank		
XUB-01	1-1/4	0.148
XUB-02	1-1/2	0.148
XUB-03	1-3/4	0.148
XUB-04	2	0.148
Double Barbed Shank		
XUD-01	1-1/2	0.148
XUD-02	1-3/4	0.148
XUD-03	2	0.148

15. Hog Ring Staple

C/D/M hog ring staple can be collated for pneumatic hog ring guns operation or loose-packed in a plastic bag for working with hog ring pliers.

- Versatile for indoor & outdoor fastening projects.
- Offer a more secure connection than traditional nails.
- Adaptable to hog ring pliers or pneumatic hog ring guns.
- Heavy duty steel wire is resistant to tear free.
- Galvanized or copper plated for rust resistance.



Application

- Shower curtain.
- Carton binding.
- Fencing installation.
- Gabion box fixation.
- Costume design.
- Furniture making.
- Meat packaging.

Styles



C hog ring staple



D hog ring staple



M hog ring staple

Styles



Hog ring pliers for loose-packed type



Manual Hog ring pliers for collated type



Pneumatic hog ring guns for collated type



C type



D type



M type

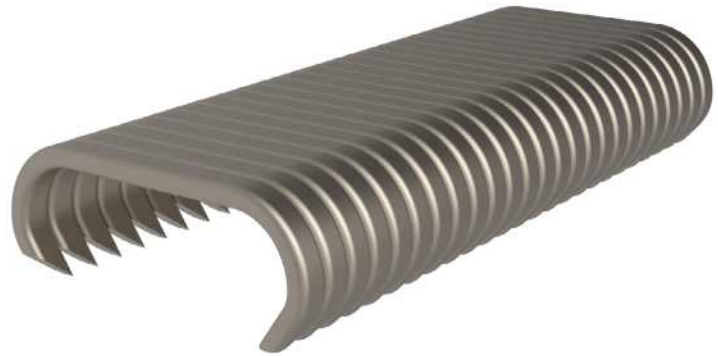

Table 1: Specification of Hog Ring Staples

Item No.	Wire Diameter (inch)	Crown (inch)	Closed Hog Diameter (inch)	Height (inch)
C Ring				
XRC-01	0.063	11/16	0.126-0.189	0.343
XRC-02	0.071	15/16	0.185-0.315	0.472
XRC-03	0.079	1-1/2	0.59-0.709	3/4
XRC-04	0.079	2-1/4	0.787-0.984	3/4
D Ring				
XRD-01	0.083/0.072/0.065	9/16	1/4	0.275
XRD-02	0.083/0.072/0.065	3/4	1/4	0.39
XRD-03	0.148	1-3/16	7/16	0.55

Table 2: Specification of M Hog Ring Staple

Item No.	Wire Diameter (inch)	Crown (inch)	Closed Hog Diameter (inch)	Height (inch)
XRM-01	0.079	0.63	0.16-0.18	0.16-0.30
XRM-02	0.079	0.71	0.16-0.18	0.16-0.30
XRM-03	0.079	0.79	0.23-0.31	0.26-0.35

16. Cut Masonry Nails

Cut masonry nails, with blunt point and tapered shank, are specially used for hard materials such as cinder block, concrete and masonry.



- Hardness: > HRC 50° .
- Designed for minimal spalling and splitting during operation.
- Outstanding durability and holding power.
- Minimal splitting during penetration.
- Surface treatment: bright, electro galvanized, hot dipped galvanized.

Application

Projects

- Masonry work.
- Restoration work.

Substrates

- Hinder block.
- Mortar joints.
- Brick walls.
- Stone.
- Reinforced concrete.

Purpose

- Wood members fixation.

Note

- Should not be used in treated lumber.
- Should not be used where surface rust is unacceptable.

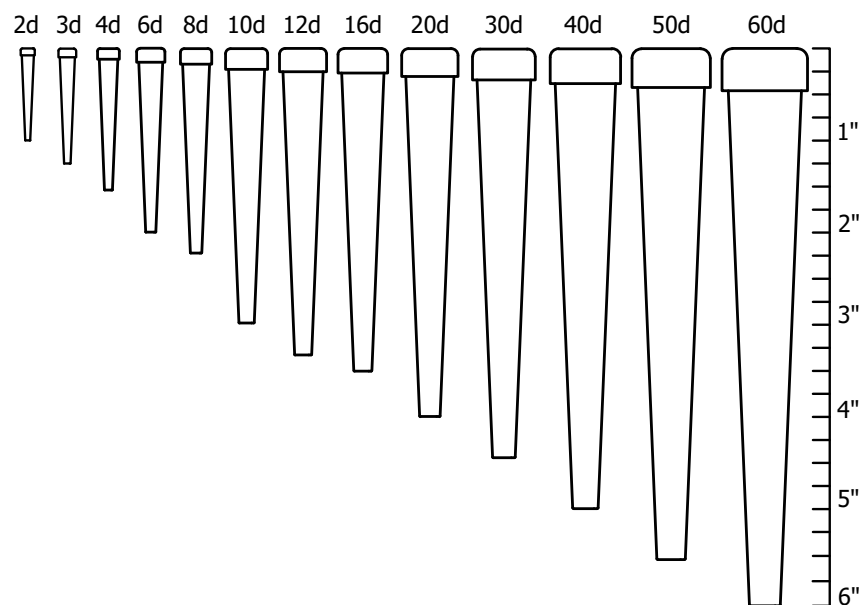

Item No.	Size (d)	Length (inch)	Rod Diameter (inch)	Head (inch)	No./box
XCM-01	4	1-1/2	0.120	0.156 × 0.250	125
XCM-02	6	2	0.120	0.188 × 0.313	85
XCM-03	8	2-1/2	0.120	0.219 × 0.313	64
XCM-04	10	3	0.130	0.250 × 0.375	48
XCM-05	11	3-1/2	0.145	0.250 × 0.375	34

17. Insulation Nails

Insulation nails consist of a steel nail, a plastic plug and a fixed round cap, are unique designed for external wall insulation.

- Reduce thermal conductivity, energy saving.
- High bearing capacity, good insulation.
- Good moisture and sound absorption performance.
- Good tensile resistance, anti-aging.
- Complete thicknesses of the insulation layers are available.
- Surface treatment: polish, electro galvanized, hot dipped galvanized or vinyl coated..



Application

- Building decoration.
- Floor heating.
- Slab heating.
- Sound insulation.
- Power plants.
- Petrochemical external wall insulation.
- Architectural wall reinforcement.

Item No.	Length		Drilling Bit Dia.		Deviation Range		
	(mm)	(inch)	(mm)	(inch)	Drilling Bit Dia. (mm)	Drilling Hole Depth (mm)	Drilling Hole Dia. (cm)
XIN-01	60	2.36	8	0.315	8.05-8.20	8.5±10%	2.5
XIN-02	80	3.15	8	0.315	8.05-8.20	8.5±10%	0.3-4.0
XIN-03	100	3.94	8	0.315	8.05-8.20	8.5±10%	5.5-6.0
XIN-04	120	4.72	8	0.315	8.05-8.20	8.5±10%	7.5-8.0
XIN-05	140	5.51	8	0.315	8.05-8.20	8.5±10%	9.0-9.5
XIN-06	160	6.30	8	0.315	8.05-8.20	8.5±10%	—
XIN-07	180	7.08	8	0.315	8.05-8.20	8.5±10%	—
XIN-08	200	7.87	8	0.315	8.05-8.20	8.5±10%	—
XIN-09	160	6.30	10	0.394	10.05-10.20	8.5±10%	—
XIN-10	180	7.08	10	0.394	10.05-10.20	8.5±10%	—
XIN-11	200	7.87	10	0.394	10.05-10.20	8.5±10%	—

Matching nails and boards

- 70 mm insulation nails: 20–40 mm insulation panels.
- 90 mm insulation nails: 40–60 mm insulation panels.
- 110 mm insulation nails: 60–80 mm insulation panels.
- 130 mm insulation nails: 80–100 mm insulation panels.
- 150 mm insulation nails: 100–120 mm insulation panels.
- 180 mm insulation nails: 120–150 mm insulation panels.

Layout

1.1–10 floor: 6 pcs/m², 11–20 floor: 7 pcs/m², 21–26 floor: 9 pcs/m². Anchoring parts must be used when the area of a single plate is greater than 0.1 m².

2.The density of anchoring parts should be increased at positive angle, hole edge and under eaves. The distance between the two anchorage pieces shall not be greater than 300 mm, and the anchorage piece shall not be less than 60mm from the substrate edge.

Construction Steps:

- 1.Affix the insulation board to the wall, determine the anchorage point position, and then drill holes in the anchorage point position according to the specified size.
- 2.The insulation nail tube is inserted into the protective cap. And its four ribs will be perfectly meshed with the cap. Then insert the nail tube directly into the nail hole to make the protective cap close to the insulation board. Finally, hammer the matching nails into the nail tube.

18. Wood Screw

Wood screws are meticulously designed for fastening wood to wood. Thanks to the threaded shank, wood screw can offer a greatest holding power during the connection.

- Lasts longer in ACQ treated wood.
- Minimal splitting during penetration.
- High resistant to withdrawal & bending.
- No need to switch drives, time saving.
- Surface treatment: bright, electro galvanized, hot dipped galvanized.
- Standard: ASME B18.6.1.



Application

- Solid wood.
- Plywood.
- Other resilient material.

Styles



Wood screw — Phillips flat head



Wood screw — frearson flat head



Wood screw — slotted flat head



Wood screw — slotted oval head



Wood screw — Phillips round head



Wood screw — slotted round head



Wood screw — square flat head

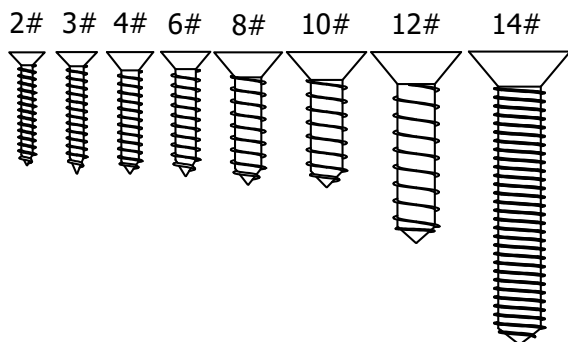

Item No.	Threads/inch	Shank Diameter		For Hard Woods		For Soft Woods		Countersink Size
		decimal	fractional	tapered bit	straight bit	tapered bit	straight bit	
		(inch)		(inch)		(inch)		
#2	26	0.086	3/32	3/32	1/16	5/64	1/16	1/4
#3	24	0.099	7/64	7/64	5/64	3/32	1/16	1/4
#4	22	0.112	7/64	7/64	5/64	3/32	1/16	1/4
#5	20	0.125	1/8	1/8	3/32	7/64	5/64	5/16
#6	18	0.1375	9/64	9/64	7/64	1/8	3/32	5/16
#7	16	0.151	5/32	5/32	7/64	9/64	3/32	5/16
#8	15	0.164	5/32	11/64	1/8	5/32	7/64	3/8
#9	14	0.177	11/64	3/16	9/64	11/64	1/8	3/8
#10	13	0.190	3/16	13/64	9/64	3/16	1/8	7/16
#12	11	0.216	7/32	7/32	5/32	13/64	9/64	7/16
#14	10	0.242	1/4	1/4	11/64	15/64	5/32	1/2
#16	9	0.268	17/64	9/32	3/16	17/64	11/64	9/16
#18	8	0.294	19/64	5/16	7/32	19/64	13/64	5/8
#20	8	0.320	5/16	21/64	15/64	5/16	7/32	3/4
#24	7	0.372	3/8	3/8	17/64	3/8	1/4	3/4

Nominal size	Basic Screw Diameter	Threads/inch	Length
4	0.112	22	1/4-1-1/2
6	0.138	18	3/8-2-1/2
8	0.164	15	3/8-3-1/2
10	0.177	13	1/2-4
12	0.216	11	3/4-5
14	0.242	10	1-1/4-6

19. Screw Nails

Screw nails, a special type of nails with helical shanks resembling screws, can be driven like a nail but also offer a strong holding power like a screw.

- Easy to drive without predrilling.
- Offer greater grip force, resistant to withdrawal.
- Easy to remove if necessary.
- Can be collated for the screw gun use.
- Various corrosion coatings for durability.
- Complete styles, gauges and sizes are available.

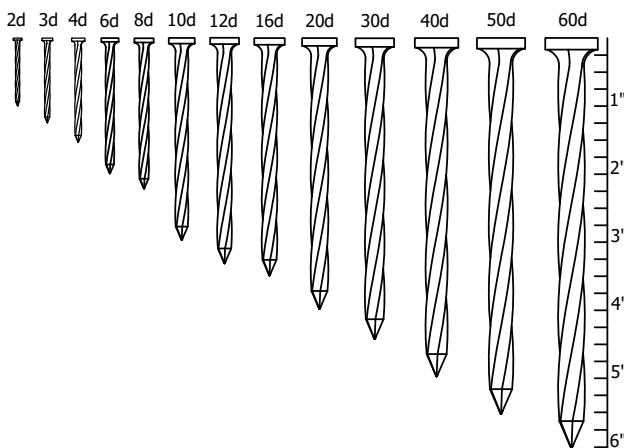

Item No.	Size (d)	Length (inch)	Diameter (gauge)	Head Diameter (inch)	No./lb
XSN-01	4	1-1/2	0.120	0.281	190
XSN-02	—	1-5/8	0.120	0.281	170
XSN-03	6	2	0.120	0.281	140
XSN-04	7	2-1/4	0.120	0.281	130
XSN-05	8	2-1/2	0.120	0.281	120
XSN-06	8	2-1/2	0.135	0.312	93
XSN-07	10	3	0.120	0.281	98
XSN-08	10	3	0.135	0.312	79
XSN-09	10	3	0.148	0.312	66
XSN-10	12	3-1/4	0.135	0.312	73
XSN-11	12	3-1/4	0.148	0.312	61
XSN-12	16	3-1/2	0.148	0.312	57
XSN-13	16	3-1/2	0.162	0.375	47
XSN-14	16	3-1/2	0.177	0.438	38
XSN-15	20	4	0.177	0.438	35
XSN-16	20	4	0.177	0.375	35
XSN-17	40	5	0.177	0.375	27
XSN-18	60	6	0.177	0.375	23
XSN-19	70	7	0.207	0.500	15
XSN-20	80	8	0.207	0.500	13
XSN-21	3	1-1/4	0.080	0.215	561
XSN-22	3	1-1/4	0.099	0.255	367
XSN-23	3	1-1/4	0.099	0.280	367
XSN-24	4	1-1/2	0.080	0.215	468
XSN-25	4	1-1/2	0.099	0.255	305
XSN-26	4	1-1/2	0.099	0.280	305
XSN-27	—	1-5/8	0.105	0.270	251
XSN-28	5	1-3/4	0.084	0.200	364
XSN-29	5	1-3/4	0.086	0.235	347

Application

- M-D flooring.
- Plumbing.
- Tiling.
- Vinyl siding.
- Truss building.
- Subflooring.
- Aluminum floor metals.
- Sheet metal cornices, gutters, flashing.
- Flat or corrugated metal roofing .
- Pallets & crate assembly.

Item No.	Size (d)	Length (inch)	Diameter (gauge)	Head Diameter (inch)	No./lb
XSN-30	5	1-3 / 4	0.090	0.245	317
XSN-31	5	1-3 / 4	0.099	0.255	262
XSN-32	5	1-3 / 4	0.099	0.280	262
XSN-33	6	2	0.084	0.200	318
XSN-34	5	2	0.086	0.235	304
XSN-35	5	2	0.090	0.245	277
XSN-36	5	2	0.099	0.255	229
XSN-37	5	2	0.099	0.280	229
XSN-38	5	2	0.105	0.270	204
XSN-39	5	2	0.113	0.280	176
XSN-40	7	2-1 / 4	0.084	0.200	283
XSN-41	7	2-1 / 4	0.086	0.235	270
XSN-42	7	2-1 / 4	0.099	0.255	204
XSN-43	7	2-1 / 4	0.099	0.280	204
XSN-44	7	2-1 / 4	0.105	0.270	181
XSN-45	7	2-1 / 4	0.113	0.280	156
XSN-46	8	2-1 / 2	0.095	0.260	199
XSN-47	8	2-1 / 2	0.099	0.255	183
XSN-48	8	2-1 / 2	0.099	0.280	183
XSN-49	8	2-1 / 2	0.113	0.280	141
XSN-50	8	2-1 / 2	0.113	0.290	141
XSN-51	8	2-1 / 2	0.120	0.290	125
XSN-52	8	2-1 / 2	0.131	0.280	105
XSN-53	9	2-3 / 4	0.113	0.290	128
XSN-54	9	2-3 / 4	0.120	0.285	113
XSN-55	10	3	0.113	0.280	117
XSN-56	12	3-1 / 4	0.120	0.290	96
XSN-57	12	3-1 / 4	0.131	0.280	81
XSN-58	16	3-1 / 2	0.131	0.280	75
XSN-59	20	4	0.120	0.280	78
XSN-60	20	4	0.131	0.280	65

How to Choose a Right Nail?

Factors to Consider

- Nail size and length

In actual operation, a proper nail length should be 3 times the thickness of the substrate you are nailing through. E.g., A 8-penny nail is suitable to fasten a 1-inch-thick material and a 16-penny nail is suitable to fasten a 2-inch-thick material.

- Material & coating

Sometimes, the elements of the project will be exposed to outdoor or wet conditions for a long time. If so, except for a proper nail length, an anti-corrosion surface coating is another factor to consider in making the project strong and reliable.

- Electro-galvanized. It is a zinc electrolytic process that adding a thin coating to the carbon steel nails. Electrogalvanizing coating can withstand dry and low-corrosion applications for a few more months or possibly an extra year. But it is not recommended for corrosive environments.
- Hot dipped galvanized. It is an effective way of metal corrosion, mainly used for metal structure on the facilities of the industry. Hot dipped galvanized nails are recommended for pressure treated wood and cedar which can cause standard nails to corrode quickly.
- Stainless Steel 304/316. These types of materials are the appropriate choices for high level corrosion protection requirement. Especially for most exterior applications. 316 grade stainless steel, chromium-nickel alloys, can stand up Marine and corrosive industrial atmospheres.

Factors to Consider

The following information are required for an accurate quotation:

- 1.Nail type.
- 2.Head type and surface.
- 3.Shank type.
- 4.Point type.
- 5.Length.
- 6.Head diameter, shank diameter.
- 7.Surface coating.
- 8.Standards to follow.
- 9.Other characteristic dimensions.



XINGYING

**SHANDONG XINGYING
INTERNATIONAL TRADING CO., LTD.**

📍 Add: #236 Beijing Road, Rizhao City,
Shandong Province, China.

📞 WhatsApp: +86-15963806918

☎ Tel: +86-633-3691680

📠 Fax: +86-633-8017391

📞 Telephone/WeChat: +86-15963806918

📧 Skype: Queelian Wong

✉ E-mail: sales@ironwirenails.com

🌐 Website: www.ironwirenails.com