

**DORMAN**<sup>®</sup>  
NEW SINCE 1918

VOLUME 1

# SERVICE DEALER GUIDE '15

Formerly "Dealer Only" Parts  
Now Available in the Aftermarket!

NEW PRODUCTS • NEW SOLUTIONS • NEW OPPORTUNITIES



Transmission Control Modules (TEHCM)



Electric Motor Transmission Stator (Prius)



Door Lock Actuator Motors



Hybrid Drive Batteries



[www.DormanProducts.com](http://www.DormanProducts.com)

# STAINLESS STEEL BRAKE LINE KITS

## STAINLESS STEEL BRAKE LINE KITS

19 SKUS AVAILABLE

Available April 2015

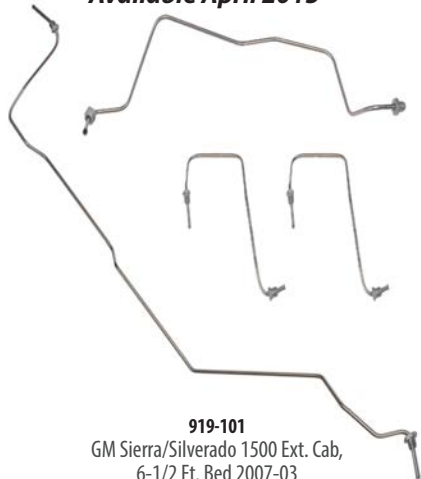

**919-101**  
GM Sierra/Silverado 1500 Ext. Cab,  
6-1/2 Ft. Bed 2007-03

### CODES:

|        |     |            |     |
|--------|-----|------------|-----|
| Epicor | DDM | Wrenchhead | DRE |
|--------|-----|------------|-----|

Direct fit pre-bent stainless steel brake lines carry pressurized fluid from the master cylinder to the brake caliper or cylinder at the wheel

- **Dorman Engineered** - Materials upgraded to stainless steel to resist corrosion
- **Complete Kit** - Includes all lines and fittings for a complete brake line repair for the applications listed
- **Direct Fit** - Dorman's stainless steel brake lines are preformed to specific application, saving time by eliminating bending, cutting and flaring



### Failure Mode:

- Rust, corrosion and deterioration from exposure to environmental debris
- Near 100% failure rate in the rust belt region

## BRAKE LINE SYSTEM

Dorman Kit provides a complete replacement solution for entire brake line system

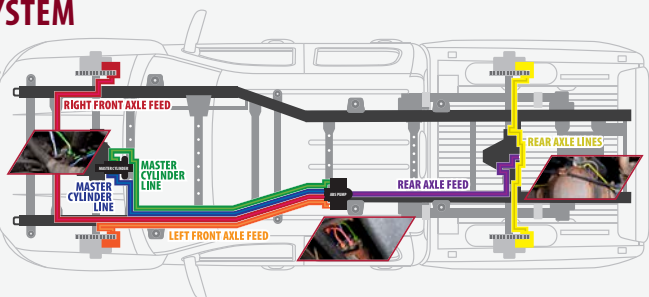

GM FULL SIZE TRUCKS 2006-99

### ALSO NEW:

| Part #  | Applications  | Part #  | Applications   |
|---------|---|---------|--|
| 919-102 | GM Sierra/Silverado 1500 Std. Cab, 6-1/2 Ft. Bed 2002-99      | 919-115 | GM Sierra/Silverado 1500 Std. Cab, 8 Ft. Bed, 4WD 2004-03  |
| 919-103 | GM Sierra/Silverado 1500 Ext. Cab, 6-1/2 Ft. Bed 2002-99      | 919-117 | GM Sierra/Silverado 1500 2007-03   |
| 919-105 | GM Sierra/Silverado 1500 Ext. Cab, 8 Ft. Bed, 2WD 2002-99     | 919-119 | GM Sierra/Silverado 1500 Std. Cab, 6-1/2 Ft. Bed, 2WD 2007-05  |
| 919-106 | GM Sierra/Silverado 1500 Std. Cab, 6-1/2 Ft. Bed, 4WD 2002-99 | 919-120 | GM Sierra/Silverado 1500 Ext. Cab, 6-1/2 Ft. Bed, 2WD, Front Coil Spring Susp., Rear Drum Brakes 2007-05 |
| 919-107 | GM Sierra/Silverado 1500 Ext. Cab, 6-1/2 Ft. Bed, 4WD 2002-99 | 919-121 | GM Sierra/Silverado 1500 Ext. Cab, 6-1/2 Ft. Bed 2007-05   |
| 919-109 | GM Sierra/Silverado 1500 Ext. Cab, 8 Ft. Bed, 4WD 2002-99     | 919-123 | GM Sierra/Silverado 1500 Ext. Cab, 8 Ft. Bed, 2WD 2007-05  |
| 919-110 | GM Sierra/Silverado 1500 Crew Cab, Long Bed 2002-01           | 919-126 | GM Sierra/Silverado 1500 Std. Cab, 6-1/2 Ft. Bed, 4WD 2007-05  |
| 919-111 | GM Sierra/Silverado 1500 Std. Cab, 6-1/2 Ft. Bed, 2WD 2004-03 | 919-128 | GM Sierra/Silverado 1500 Ext. Cab, 8 Ft. Bed, 4WD 2007-05  |
| 919-113 | GM Sierra/Silverado 1500 Ext. Cab, 8 Ft. Bed, 2WD 2004-03     |         |  |
| 919-114 | GM Sierra/Silverado 1500 Std. Cab, 6-1/2 Ft. Bed, 4WD 2004-03 |         |  |

ADDITIONAL COVERAGE COMING SOON!

## AMBIENT AIR TEMPERATURE SENSOR



**902-022**

Chrysler 2008-04, Dodge 2009-07,  
Mercedes-Benz 2013-98, Volkswagen 2009-08

**CODES:**

|        |     |            |     |
|--------|-----|------------|-----|
| Epicor | DDM | Wrenchhead | DRE |
|--------|-----|------------|-----|

**Tired of guessing how hot or cold it is outside your vehicle?**

- Restore accurate outside temperature readings with Dorman's outdoor temperature sensor
- **Complete Kit** - Includes wire connectors for a complete repair (where applicable)



**Failure Mode:**

- Sensor malfunction and/or electrical failure
- Failure results in incorrect temperature displayed

## AUDIO / VIDEO JACK - Honda Civic



**IMPORT**

**57010**  
Honda Civic  
2011-06



**CODES:**

|        |     |            |     |
|--------|-----|------------|-----|
| Epicor | MDH | Wrenchhead | RNB |
|--------|-----|------------|-----|

**Restores vehicle audio system auxiliary input function**

- Direct replacement for a proper fit
- Easy to install

**Failure Mode:**

- Loss of connection
- Failure results in the inability to connect an external audio device via auxiliary input

## AUXILIARY WATER PUMP (ENGINE) - Dodge Durango



**902-407**

Dodge Durango 2003-01

**CODES:**

|        |     |            |     |
|--------|-----|------------|-----|
| Epicor | DDM | Wrenchhead | DRE |
|--------|-----|------------|-----|

**Circulates coolant through rear heating system**

**Failure Mode:**

- Leaks
- Failure results in engine overheating



Air Bag Lamp



Center Console  
Hinge Repair Kit



Console Lid Kits

## BATTERY HOLD DOWN CLAMPS

5 SKUS AVAILABLE



**IMPORT**

**00591**

Toyota Corolla 2008-03, Toyota Matrix 2008-03

**CODES:**

|        |     |            |     |
|--------|-----|------------|-----|
| Epicor | MDH | Wrenchhead | RNB |
|--------|-----|------------|-----|

Secures battery in place

**Failure Mode:**

- Corrodes over time
- Often breaks during service repairs

## BUMPER GRILLE INSERTS - Volkswagen Jetta

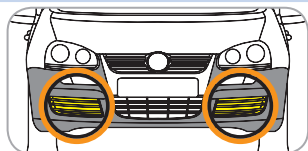

**IMPORT**

**45163 (Front Left)**

**45164 (Front Right)**

Volkswagen Jetta 2005-99

**CODES:**

|        |     |            |     |
|--------|-----|------------|-----|
| Epicor | MDH | Wrenchhead | RNB |
|--------|-----|------------|-----|

Restores factory appearance

**Failure Mode:**

- Grille cracks, loose grille falls out
- Original falls out of contact with road debris

### ALSO AVAILABLE

*Use to safely remove interior and exterior body components*



**49051**

Multi-use removal set

## CENTER CONSOLE LATCHES

4 SKUS AVAILABLE



**924-294**

Ford 2010-05, Mercury 2010-05, Explorer 2010-08, Taurus 2009-05

**CODES:**

|        |     |            |     |
|--------|-----|------------|-----|
| Epicor | DDM | Wrenchhead | DRE |
|--------|-----|------------|-----|

Secures console lid in closed position

- **Reduce Repair Cost** - Replace just the failed latch, not the entire center console assembly



**Failure Mode:**

- Wear and tear
- Failure results in console lid not functioning properly



Cup Holder Inserts



Dome Lamp Switches



Door Latch Cables



## CENTER HIGH MOUNT STOP LIGHTS

OVER 40 SKUS AVAILABLE



**923-216**

Jeep Grand Cherokee 2010-05

**CODES:**

|        |     |            |     |
|--------|-----|------------|-----|
| Epicor | DDM | Wrenchhead | DRE |
|--------|-----|------------|-----|

Features integrated LED bulbs to provide up to 10 times more brightness than standard bulbs

- Includes wire harness (where applicable)

**ALSO NEW:**

| Part #  | Applications   |
|---------|--|
| 923-262 | Cadillac Escalade 2013-07, Cadillac Escalade ESV 2013-07 |

**Failure Mode:**

- Original lamp burns out over time
- Collision

## CONSOLE LIDS

OVER 5 SKUS AVAILABLE



**924-835**

Cadillac 2013-07, Chevrolet 2013-07, GMC 2013-07

**CODES:**

|        |     |            |     |
|--------|-----|------------|-----|
| Epicor | DDM | Wrenchhead | DRE |
|--------|-----|------------|-----|

**Replacement lid for center consoles**

- **Complete Kit** - Includes all hardware for a complete repair (where applicable)
- **Reduce Repair Cost** - Replace just the broken lid instead of replacing the entire console
- Available in a variety of colors to match interior design of vehicle



**Failure Mode:**

- Original lid becomes cracked over time
- Failure results in lid not closing properly

## CUP HOLDERS

OVER 10 SKUS AVAILABLE



**IMPORT**

**41014**

BMW 2003-97, BMW 1995

**CODES:**

|        |     |            |     |
|--------|-----|------------|-----|
| Epicor | MDH | Wrenchhead | RNB |
|--------|-----|------------|-----|

**Replaces broken or missing cup holders**

- Spring-loaded cup holders available (where applicable)
- Durable construction
- Direct replacement for a proper fit

**Failure Mode:**

- Missing arms cause cups to fall out
- Original spring loaded arms break over time

**ALSO NEW:**

| Part # | Applications          |
|--------|-----------------------|
| 41025  | Mercedes-Benz 2011-03 |

SCAN HERE to view install video ▶



Hood Release Cables



Ignition Lock Cylinders



Oil Filter Housing

## DOOR LATCH ACTUATOR MOTORS

OVER 200 SKUS AVAILABLE



**931-004 (Front Left)**  
Chrysler 300 2010-05,  
Dodge Charger 2010-06,  
Dodge Magnum 2008-05

### CODES:

|        |     |            |     |
|--------|-----|------------|-----|
| Epicor | DDM | Wrenchhead | DRE |
|--------|-----|------------|-----|

Electrical motor used to lock or unlock a vehicle door

- Integrated with latch (where applicable)
- High quality electric motor

### ALSO NEW:

| Part #               | Applications                                 |
|----------------------|--|
| 931-626 (Front Left) | Dodge Dakota 2003-00, Dodge Durango 2003-98  |
| 931-692 (Rear Left)  | Jeep Liberty 2007-02                         |
| 937-670 (Liftgate)   | Ford Escape 2007-01, Mercury Mariner 2007-05 |

### Failure Mode:

- Electric motor wears out over time
- Failure results in the lock becoming inoperable

## HALO RING BULBS - BMW 3 Series



IMPORT

639-000

BMW 3 Series 2013-06

### CODES:

|        |     |            |     |
|--------|-----|------------|-----|
| Epicor | DDM | Wrenchhead | DRE |
|--------|-----|------------|-----|

Auxiliary component that restores illumination of headlight rings

- Direct replacement for a proper fit

### Failure Mode:

- Original bulb burns out
- Failure results in headlights not illuminating properly

## HEADLIGHT ADJUSTER KITS - BMW

OVER 10 SKUS AVAILABLE



IMPORT

924-394

BMW 2001-97

### CODES:

|        |     |            |     |
|--------|-----|------------|-----|
| Epicor | DDM | Wrenchhead | DRE |
|--------|-----|------------|-----|

Clips that enable headlights to adapt to various lighting options

- **Reduce Repair Cost** - Replace just the failed original clips instead of the entire headlight assembly



### Failure Mode:

- Plastic pieces become brittle and crack
- Failure results in lights not adjusting or focusing properly



License Plate Lens

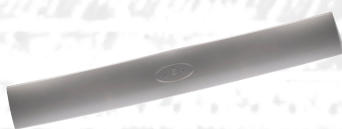

Rear Applique Panels



Sliding Door Rollers

## HOOD LATCH ASSEMBLIES

5 SKUS AVAILABLE



**RUST**

**42401**

Jeep Wrangler 2013-07

**CODES:**

|        |     |            |     |
|--------|-----|------------|-----|
| Epicor | MDH | Wrenchhead | RNB |
|--------|-----|------------|-----|

**Secures hood in closed position**

- Brackets included (where applicable)
- Direct replacement is essential for driving safety
- Zinc coated or painted steel for corrosion and added rust-resistance

**Failure Mode:**

- Original latch point breaks over time
- Latch cracks over time

## KEYLESS REMOTE CASES

OVER 45 SKUS AVAILABLE



**13607GNC**

Camouflage style  
Ford 2013-95,  
Lincoln 2012-95,  
Mercury 2011-95



**13618GNC**

Camouflage style  
GM 2009-02

**CODES:**

|        |     |            |     |
|--------|-----|------------|-----|
| Epicor | MDH | Wrenchhead | RNB |
|--------|-----|------------|-----|

**Does your Keyless Entry Remote still work but the case is damaged?**

- **Reduce Repair Cost** - Replace just the broken or cracked keyless remote case instead of the entire key fob
- Available in three new camouflage colors: green, gray and pink (for select models)
- No special tools required



**CUSTOMIZE TO FIT YOUR STYLE!**

▶ Available in a variety of styles



## LIFTGATE RELEASE MOTOR - Toyota Highlander



**IMPORT**

**747-201**

Toyota Highlander 2013-10

**CODES:**

|        |     |            |     |
|--------|-----|------------|-----|
| Epicor | DDM | Wrenchhead | DRE |
|--------|-----|------------|-----|

**Electrical motor used to operate trunk and/or liftgate**

- Replacement restores power function of liftgate

**Failure Mode:**

- Original electric motor wears over time
- Failure results in improper function of power liftgate



Subframe Bushing Kits



Window Switches



Third Brake Lights

## ODOMETER DRIVE GEAR KITS



**924-388**  
Ford 2003-86,  
Mercury 2001-86



### CODES:

|        |     |            |     |
|--------|-----|------------|-----|
| Epicor | DDM | Wrenchhead | DRE |
|--------|-----|------------|-----|

New money saving solution for odometer reading failure

- **Reduce Repair Cost** - Replace just the failed gear instead of the entire instrument cluster assembly



### Failure Mode:

- Original gear strips or breaks over time
- Failure results in odometer not reading accurate mileage

### ALSO AVAILABLE



**924-396**  
Chevrolet 2000-88,  
GMC 2000-88

## RADIO KNOBS



**76849**

A wide variety of  
Buick 2007-04, Cadillac 1999,  
Chevrolet 2009-95, GMC 2009-95,  
Hummer 2007-03, Oldsmobile 1999-97

### CODES:

|        |     |            |     |
|--------|-----|------------|-----|
| Epicor | MDH | Wrenchhead | RNB |
|--------|-----|------------|-----|

Complete radio knob repair kit comes with knobs for the tuner, treble, bass, balance, fade and volume controls

- Available in a variety of assortments containing different styles and sizes for a broad range of vehicle applications

### Failure Mode:

- Original knobs fade, crack or fall off over time, making it difficult to adjust radio settings

## RADIO KNOBS (BUTTONS)

10 TOTAL SKUS AVAILABLE



**IMPORT**

**76821**

A wide variety of GM 2005-95, Isuzu 1999-98

### ALSO NEW:

| Part #       | Applications  |
|--------------|---|
| <b>76823</b> | Ford F-Series 2005  |
| <b>76824</b> | Buick 2007-05, Cadillac 2007-05, Chevrolet 2007-05, GMC 2007-05, Hummer 2007-05 |

### CODES:

|        |     |            |     |
|--------|-----|------------|-----|
| Epicor | MDH | Wrenchhead | RNB |
|--------|-----|------------|-----|

Direct Replacement radio buttons kit, now available for a broad range of vehicle applications

- Replaces original broken or missing buttons on the radio
- **Reduce Repair Cost** - Replace just the broken or missing buttons, not the entire radio assembly



### Failure Mode:

- Original buttons fade, crack or fall off over time

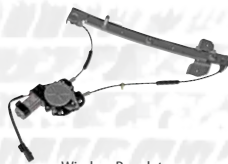

Window Regulators



Hub Bolts



Seat Bracket Repair

## ROOF MARKER LIGHTS

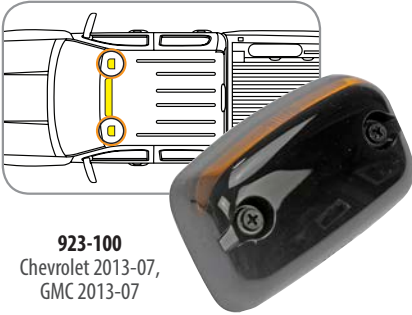

**923-100**  
Chevrolet 2013-07,  
GMC 2013-07

### CODES:

|        |     |            |     |
|--------|-----|------------|-----|
| Epicor | DDM | Wrenchhead | DRE |
|--------|-----|------------|-----|

Exterior lighting component that increases visibility to other vehicle operators

### Failure Mode:

- Original burns out over time

### ALSO NEW:

| Part #  | Applications                   |
|---------|--------------------------------|
| 923-101 | Chevrolet 2013-07, GMC 2013-07 |

## SEAT ADJUSTMENT GEARS - BMW

3 SKUS AVAILABLE

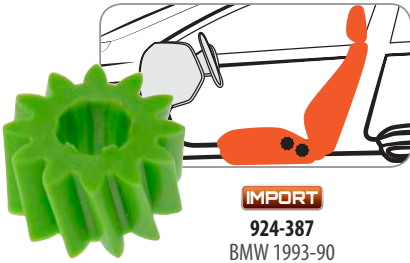

IMPORT

**924-387**  
BMW 1993-90

### ALSO NEW:

| Part #          | Applications |
|-----------------|--------------|
| 924-384 (White) | BMW 1996-94  |
| 924-386 (Pink)  | BMW 2000-90  |

### CODES:

|        |     |            |     |
|--------|-----|------------|-----|
| Epicor | DDM | Wrenchhead | DRE |
|--------|-----|------------|-----|

Restores driver and passenger seat reclining functions

- **Reduce Repair Cost** - Replace just the failed gear instead of the entire assembly
- All seat adjustment gears are color coded to easily determine correct application



### Failure Mode:

- Original gear strips
- Failure results in seat not moving up or down

## SLIDING DOOR ROLLER BRACKET



**924-143**  
Chevrolet 2013-96, GMC 2013-96

### CODES:

|        |     |            |     |
|--------|-----|------------|-----|
| Epicor | DDM | Wrenchhead | DRE |
|--------|-----|------------|-----|

Bracket that assists in the opening and closing of the vehicle's sliding door

- Restores smooth operation of sliding door

### Failure Mode:

- Wear from continued use
- Failure results in misaligned door, or door comes off the track



Shift Lever



Tailgate Glass Hinges

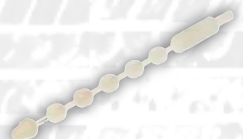

Shift Release Link



## SPARE TIRE HOISTS

OVER 10 SKUS AVAILABLE



**RUST**

924-511

Ford Explorer 2010-06, Mercury Mountaineer 2010-06

**CODES:**

|        |     |            |     |
|--------|-----|------------|-----|
| Epicor | DDM | Wrenchhead | DRE |
|--------|-----|------------|-----|

**Holds spare tire in place under vehicle**

- **Dorman Engineered** - Coated finish prevents rust and corrosion
- **Complete Kit** - Includes mounting hardware for a complete installation (where applicable)



**Failure Mode:**

- Rust and corrosion
- Failure results in hoist not releasing the spare tire

## STEERING COLUMN ADJUSTMENT GEAR - Telescoping & Tilt Motor



**IMPORT**

905-522

Infiniti 2013-10, Nissan 2012-09

**CODES:**

|        |     |            |     |
|--------|-----|------------|-----|
| Epicor | DDM | Wrenchhead | DRE |
|--------|-----|------------|-----|

**Save time and money with Dorman's new Column Motor Gear Kits**

- **Reduce Repair Cost** - Replace just the failed gear instead of the tilt motor assembly
- **Complete Kit** - Includes telescoping and tilt motor gears for a complete repair



**Failure Mode:**

- Original gear strips or breaks over time
- Failure results in loss of power tilt and telescoping function

## SUN VISOR BRACKET



924-279

Ford 2005-02,  
Lincoln 2005-03,  
Mercury 2005-02

**CODES:**

|        |     |            |     |
|--------|-----|------------|-----|
| Epicor | DDM | Wrenchhead | DRE |
|--------|-----|------------|-----|

**Repairs the mount that holds sun visor to the headliner of the vehicle**

- **Reduce Repair Cost** - Replace just the failed mount, instead of the entire sun visor assembly
- **Dorman Engineered** - Upgraded materials from plastic to aluminum for increased durability
- **Complete Kit** - Includes all hardware needed for a complete repair



SCAN HERE to view install video ▶



**Failure Mode:**

- Original plastic cracks through normal use
- Sun visor falls or hangs down



Water Hose Connector



Shift Indicator Bracket



Ignition Actuator

## TAILGATE LATCHES

10 SKUS AVAILABLE



**FLEET**

**38675 (Left)**  
**38676 (Right)**

Chevrolet Trucks 2000-88,  
GMC Trucks 2000-88



### CODES:

|        |     |            |     |
|--------|-----|------------|-----|
| Epicor | MDH | Wrenchhead | RNB |
|--------|-----|------------|-----|

### Secures tailgate in closed position

- Fits popular fleet vehicles
- Daily use leads to common replacement of original latch
- **Complete Kit** - Includes all hardware for a complete repair (where applicable)



### Failure Mode:

- Components in latch fail due to rust
- Failure results in difficulty opening or closing the tailgate

## TRANS SHIFT BOOT (AUTO)



**47106**

Cadillac 2006-02, Chevrolet 2007-98,  
GMC 2007-98, Oldsmobile 2004-99

### CODES:

|        |     |            |     |
|--------|-----|------------|-----|
| Epicor | MDH | Wrenchhead | RNB |
|--------|-----|------------|-----|

### Covers steering column where the selector is attached

- Replacement prevents dirt and debris from entering the shift linkage
- Restores factory appearance

### Failure Mode:

- Original boot tears or cracks over time
- Failure results in missing boot, and debris contamination in shift linkage

## TRUNK LOCK ACTUATOR MOTOR - Volkswagen



**IMPORT**

**747-020**

Volkswagen Bora 2010-06,  
Volkswagen Clasico 2014-11,  
Volkswagen Jetta 2005-99



### CODES:

|        |     |            |     |
|--------|-----|------------|-----|
| Epicor | DDM | Wrenchhead | DRE |
|--------|-----|------------|-----|

### Mounts trunk actuator to body of the vehicle

### Failure Mode:

- Original actuator arm breaks and requires plate replacement
- Failure results in inability to open trunk



Wiper Arms



Window Regulators



Shift Interlock Latch

## WINDSHIELD WASHER NOZZLE



**47140**  
Chevrolet Equinox 2009-05,  
Pontiac Torrent 2009-06,  
Saturn Vue 2009-02

### CODES:

|        |     |            |     |
|--------|-----|------------|-----|
| Epicor | MDH | Wrenchhead | RNB |
|--------|-----|------------|-----|

### Directs washer fluid to windshield

- Direct replacement for proper fit

**DIRECT FIT**

### Failure Mode:

- Original nozzle clogs
- Spray pattern diminishes over time

## WINDSHIELD WASHER NOZZLE TECH TRAY



**030-207**  
Direct Fit

### CODES:

|        |     |            |     |
|--------|-----|------------|-----|
| Epicor | DDM | Wrenchhead | DRE |
|--------|-----|------------|-----|

### Assortment of the most popular washer nozzles

- Direct replacement for proper fit

**DIRECT FIT**

### Failure Mode:

- Original nozzle clogs
- Spray pattern diminishes or is non-existent

### WINDSHIELD WASHER NOZZLE TECH TRAY CONTENT

| Part # | Make             | Model  | Year    | Description    |
|--------|------------------|--|---------|----------------|
| 47183  | Jeep, Mitsubishi | Grand Cherokee, Galant   | 2013-06 | Front, LH & RH |
| 47184  | Chrysler, GM     | Malibu, G6, Sebring, Stratus   | 2011-08 | Front, LH & RH |
| 47185  | Mitsubishi       | Eclipse  | 2012-06 | Front, LH & RH |
| 47186  | Chrysler, Jeep   | 300, PT Cruiser, Avenger, Charger, Ram 1500 Pickup, Durango, Compass | 2012-06 | Front, LH & RH |
| 47187  | Ford             | Focus, Edge, MKX   | 2010-07 | Front, LH & RH |
| 47188  | Chrysler, Jeep   | Nitro, Commander   | 2011-07 | Front, LH & RH |
| 47189  | Toyota           | Sienna, Solara   | 2010-03 | Front, LH & RH |
| 47190  | Chrysler, Toyota | Sebring, Solara  | 2006-03 | Coupe, LH      |
| 47191  | Chrysler         | Sprinter   | 2009-07 | Front, LH & RH |
| 47192  | Chrysler, GM     | Enclave, Traverse, Acadia, Concorde, Intrepid                        | 2010-08 | Front, LH & RH |



Windshield Washer Hose



Cup Holder Insert

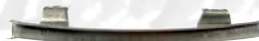

Window Channel

## BRAKE HYDRAULIC LINES (ABS)

2 SKUS AVAILABLE



905-932 (Primary Line)

Ford Expedition 1999-97, Ford F-150 1999-97,  
Ford F-250 1999-97, Lincoln Navigator 1999-98

### ALSO NEW:

| Part #                 | Applications   |
|------------------------|--|
| 905-931<br>(Secondary) | Ford Expedition 1999-97, Ford F-150 1999-97, Ford F-250 1999-97, Lincoln Navigator 1999-98 |

### CODES:

|        |     |            |     |
|--------|-----|------------|-----|
| Epicor | DDM | Wrenchhead | DRE |
|--------|-----|------------|-----|

Transmits hydraulic pressure between the master cylinder and the ABS unit

### Failure Mode:

- Corrosion
- Failure results in leaks, loss of braking

## PARKING BRAKE ACTUATOR GEAR KIT - BMW



IMPORT

924-395  
BMW 2008-02

### CODES:

|        |     |            |     |
|--------|-----|------------|-----|
| Epicor | DDM | Wrenchhead | DRE |
|--------|-----|------------|-----|

Repairs broken gear inside the parking brake assembly

- **Reduce Repair Cost** - Replace the failed gears, instead of the entire Parking Brake Assembly



### Failure Mode:

- Wear and tear over time, original plastic gear teeth strip
- Failure results in parking brake not functioning properly

## PARKING BRAKE BELL CRANKS

10 SKUS AVAILABLE



IMPORT RUST

924-744

Infiniti QX56 2013-04, Nissan Armada 2013-05,  
Nissan Titan 2013-04

### ALSO NEW:

| Part #  | Applications                                   |
|---------|--|
| 924-740 | Chrysler 2007-01, Dodge 2007-01                |
| 924-741 | Ford 2008-99, Lincoln 2011-04, Lincoln 2002-99 |
| 924-743 | Chevrolet 2013-99, GMC 2013-99                 |

### CODES:

|        |     |            |     |
|--------|-----|------------|-----|
| Epicor | DDM | Wrenchhead | DRE |
|--------|-----|------------|-----|

Engages parking brake shoes

- **Dorman Engineered** - Coated for high corrosion resistance and long lasting durability
- **Complete Kit** - Includes everything needed for a complete repair



### Failure Mode:

- Normal wear and tear
- Corrosion
- Failure results in brake not releasing properly
- Seized/locked bell crank and sagging cable



Brake Master Cylinder Caps



Brake Proportioning Valves



ABS Sensors

## BODY MOUNT SETS

OVER 30 SKUS AVAILABLE



**924-051**

Ford Explorer 2005-02, Lincoln Aviator 2005-03,  
Mercury Mountaineer 2005-02

### ALSO NEW:

| Part #  | Applications |
|---------|--------------|
| 924-056 | Ford 2014-95 |

### CODES:

|        |     |            |     |
|--------|-----|------------|-----|
| Epicor | DDM | Wrenchhead | DRE |
|--------|-----|------------|-----|

Secures frame or subframe to vehicle body while isolating road noise and vibration

- **Complete Kit** - Includes upper and lower bushings, retainer and bolt for a complete repair



### Failure Mode:

- Original mounts compress, crack and separate
- Failure results in clunking noises and reduced ride control

## DIFFERENTIAL MOUNTS

2 SKUS AVAILABLE



**905-404**

Jeep Commander  
2010-06,  
Jeep Grand Cherokee  
2010-05



**905-405**

Jeep Commander  
2010-06,  
Jeep Grand Cherokee  
2010-05

### CODES:

|        |     |            |     |
|--------|-----|------------|-----|
| Epicor | DDM | Wrenchhead | DRE |
|--------|-----|------------|-----|

Secures front differential to the suspension

- High replacement rate part as original unit is failure prone

### Failure Mode:

- Original bushing deteriorates over time
- Failure results in suspension clunking

## ENGINE MOUNT (CRADLE) - Volvo



**IMPORT**

**523-138**

Volvo 2014-93

### CODES:

|        |     |            |     |
|--------|-----|------------|-----|
| Epicor | DDM | Wrenchhead | DRE |
|--------|-----|------------|-----|

Bushings for the engine cradle

- Replacement prevents potential vehicle engine damage
- **Reduce Repair Cost** - Replace the failed bushing, instead of the entire assembly
- Easy to install



### Failure Mode:

- Original rubber deteriorates over time
- Failure results in rattling or clunking noise



Steering Shafts



Sway Bar Kits



Sway Bar Bracket



## ENGINE MOUNT BRACKET



**917-000**

Buick 2009-99, Chevrolet 2005-00, Pontiac 2008-99

### CODES:

|               |     |                   |     |
|---------------|-----|-------------------|-----|
| <b>Epicor</b> | DDM | <b>Wrenchhead</b> | DRE |
|---------------|-----|-------------------|-----|

### Secures engine to vehicle frame

- **Dorman Engineered** - Materials upgraded from aluminum to ductile iron for improved durability
- Galvanized-coated for long-lasting rust and corrosion resistance



### Failure Mode:

- Original aluminum design is prone to cracking
- Failure results in excessive engine rocking

## JOUNCE BUMPER - REAR



**31068**

Chevrolet Camaro 2002-82, Chevrolet Firebird 1994, Pontiac Firebird 2002-82

### CODES:

|               |     |                   |     |
|---------------|-----|-------------------|-----|
| <b>Epicor</b> | MDH | <b>Wrenchhead</b> | RNB |
|---------------|-----|-------------------|-----|

### Prevents damage to the vehicle's control arm, frame, shock mount and other suspension components

- Replacement of worn or damaged Jounce Bumper restores proper suspension functioning
- Constructed of steel and polystyrene foam for long-lasting durability

### Failure Mode:

- Suspension knock due to axle bottoming out

## LEAF SPRINGS

OVER 15 SKUS AVAILABLE



**929-115**

Chevrolet Silverado 1500 2007-00, GMC Sierra 1500 2007-00

### CODES:

|               |     |                   |     |
|---------------|-----|-------------------|-----|
| <b>Epicor</b> | DDM | <b>Wrenchhead</b> | DRE |
|---------------|-----|-------------------|-----|

### Spring comprised of multiple thin bands of steel used to restore vehicle suspension to proper function

- **Complete Kit** - Includes bushings for a complete repair (where applicable)
- Replacement restores a safe, stable, and smooth ride



### Failure Mode:

- Original spring ends corrode, crack and weaken ability to stabilize suspension



Trailing Arms



Strut Mount Bearing



Power Steering Lines

## LEAF SPRING HANGERS

OVER 10 SKUS AVAILABLE



**RUST**

**722-032**  
Chevrolet 2007-99,  
GMC 2007-99

**CODES:**

|        |     |            |     |
|--------|-----|------------|-----|
| Epicor | DDM | Wrenchhead | DRE |
|--------|-----|------------|-----|

Attaches the leaf spring to the frame of the vehicle

- **Complete Kit** - Includes hardware for a complete repair



**Failure Mode:**

- Rust and corrosion
- Failure results in sagging suspension and loose leaf spring

## LEAF SPRING HANGER - BRACKETS

OVER 15 SKUS AVAILABLE



**RUST**

**722-061**

Dodge B Vans 1997-82, Plymouth PB Vans 1983-82

**CODES:**

|        |     |            |     |
|--------|-----|------------|-----|
| Epicor | DDM | Wrenchhead | DRE |
|--------|-----|------------|-----|

Attaches leaf spring shackle to the frame of the vehicle

- **Complete Kit** - Includes necessary hardware for a complete installation



**Failure Mode:**

- Rust and Corrosion
- Failure results in collapsed leaf springs, affecting drivability of the vehicle

## LEAF SPRING SHACKLE KITS

OVER 15 SKUS AVAILABLE



**RUST**

**722-030**  
Chevrolet 2010-01,  
GMC 2010-01

**CODES:**

|        |     |            |     |
|--------|-----|------------|-----|
| Epicor | DDM | Wrenchhead | DRE |
|--------|-----|------------|-----|

Bracket that mounts to the frame and holds the leaf spring in place

- **Complete Kit** - Includes hardware for a complete repair
- Shackle and hardware are powder-coated for long-lasting corrosion protection



**Failure Mode:**

- Rust and corrosion
- Leaf spring becomes detached from suspension

**ALSO NEW:**

| Part #  | Applications           |
|---------|------------------------|
| 722-034 | Dodge Ram 1500 2008-02 |



Sway Bar Kits



Wheel Hubs



Steering Knuckles

## RACK AND PINION BUSHINGS - Toyota



**IMPORT**

**905-408**

Toyota Avalon 2004-97, Toyota Camry 1996-92,  
Toyota Sienna 2003-98

**ALSO NEW:**

| Part #  | Applications                                    |
|---------|---|
| 905-402 | Infiniti QX4 2003-97, Nissan Pathfinder 2004-05 |

**CODES:**

| Epicor | DDM | Wrenchhead | DRE |
|--------|-----|------------|-----|
|        |     |            |     |

**Holds steering rack in place**

- **Reduce Repair Cost** - Replace just the failed part not the entire steering rack assembly
- Replacement restores the original steering feel and alignment



**Failure Mode:**

- Wear and tear over time
- Failure results in loose steering or misaligned front end

## SUSPENSION KNUCKLE BUSHINGS

**6 SKUS AVAILABLE**



**IMPORT**

**905-521**

Lexus 2012-92, Toyota 2013-90

**CODES:**

| Epicor | DDM | Wrenchhead | DRE |
|--------|-----|------------|-----|
|        |     |            |     |

**Bushings are the mounting point between the steering knuckle and mating chassis parts**

- Includes tool for an easy repair
- **Reduce Repair Cost** - Replace just the failed bushing, instead of the entire steering knuckle assembly



**Failure Mode:**

- Wear and tear over time
- Failure results in clunking noise



**IMPORT**

**905-533**

BMW 2010-95

**ALSO NEW:**

| Part #  | Applications                     |
|---------|----------------------------------|
| 905-537 | Audi 2013-02, Volkswagen 2013-05 |



Steering Rack Bushing



Wheel Center Caps



Leaf Spring Bracket

## SUSPENSION RIDE HEIGHT SENSOR



**RUST**  
**924-261**

Ford Expedition 2006-03,  
Lincoln Navigator 2006-03

### CODES:

|        |     |            |     |
|--------|-----|------------|-----|
| Epicor | DDM | Wrenchhead | DRE |
|--------|-----|------------|-----|

**Direct replacement sensor restores vehicle suspension height**

- **Complete Kit** - Includes all hardware for a complete repair



### Failure Mode:

- Corrosion
- Failure results in sensor's inability to correctly monitor vehicle ride height

## SUSPENSION TRAILING ARM BUSHINGS

10 SKUS AVAILABLE



**IMPORT**  
**523-033**

Toyota Sienna 2003-98

### CODES:

|        |     |            |     |
|--------|-----|------------|-----|
| Epicor | DDM | Wrenchhead | DRE |
|--------|-----|------------|-----|

**Mounting point for the front and/or rear axle to vehicle frame**

- **Reduce Repair Cost** - Includes all necessary hardware for a complete repair
- Direct fit for a proper fit and easy installation



### Failure Mode:

- Original rubber deteriorates over time
- Failure results in knocking noise from the front or rear of the vehicle

## WATTS LINK - Chrysler PT Cruiser



**RUST**  
**523-026**

Chrysler PT Cruiser 2010-07

### CODES:

|        |     |            |     |
|--------|-----|------------|-----|
| Epicor | DDM | Wrenchhead | DRE |
|--------|-----|------------|-----|

**Allows vehicle axle to move vertically and prevents side-to-side motion**

- Replacement eliminates clunking sound in the suspension system

### Failure Mode:

- Rust and corrosion
- Failure results in clunking noise from rear of vehicle



Watt Linkage Bell Crank



Power Steering Pulley



Lateral Links

## EGR COOLER KITS

OVER 8 SKUS AVAILABLE



**CODES:**

|        |     |            |     |
|--------|-----|------------|-----|
| Epicor | DDM | Wrenchhead | DRE |
|--------|-----|------------|-----|

**Cools recirculating exhaust gas**

- **Complete Kit** - Includes all gaskets and O-rings for a complete kit
- **Dorman Engineered** - Engineered with a spiral tube core to eliminate clogging



**100% NEW**  
 NOT REMAN

**Failure Mode:**

- Original design becomes clogged from carbon buildup
- Failure results in coolant leaks



**ORIGINAL OE DESIGN**

*Design is more prone to clogging*



**STRAIGHT TUBE DESIGN**

*Design allows for less clogging and better overall performance*

## ENGINE OIL HOSES (HIGH PRESSURE PUMP)

3 SKUS AVAILABLE



**DIESEL**  
**904-196 (Passenger Side)**

Ford 2003-99 7.3L, Both 90 degree and straight ends

**ALSO NEW:**

| Part #                | Applications                            |
|-----------------------|---|
| 904-197 (Driver Side) | Ford 2003-99 7.3L                       |
| 904-198               | Ford 2003-00 7.3L, Both ends 90 degrees |

**CODES:**

|        |     |            |     |
|--------|-----|------------|-----|
| Epicor | DDM | Wrenchhead | DRE |
|--------|-----|------------|-----|

**Transfers high pressure oil from the high pressure pump to the high pressure oil rail**

- Replacement is required to ensure a properly functioning fuel system

**Failure Mode:**

- Original hose degrades over time
- Failure results in rough idle or no engine start, oil leaks

## TURBOCHARGER VANE POSITION SOLENOID



**CODES:**

|        |     |            |     |
|--------|-----|------------|-----|
| Epicor | DDM | Wrenchhead | DRE |
|--------|-----|------------|-----|

**Validates the position of the turbocharger vane**

- Prevents wear and tear to the turbo system
- **Plug and Play** - for easy installation

**Failure Mode:**

- Carbon buildup causes the original sensor to stop functioning
- Loss of engine power
- Vehicle will run rough and check engine light illuminates





## LOCKING HUBS

### 600-203 (Auto)

Ford 2005-01,  
Lincoln 2002-01



### 600-204 (Manual)

Ford 2005-01,  
Lincoln 2002-01

#### CODES:

|        |     |            |     |
|--------|-----|------------|-----|
| Epicor | DDM | Wrenchhead | DRE |
|--------|-----|------------|-----|

Restores Four-Wheel Drive (4WD) to proper performance

#### Failure Mode:

- Corrosion
- Inability to engage front axles into 4WD mode

## TRANSFER CASE GASKET



### 917-562

Cadillac 2014-99, Chevrolet 2014-91,  
GMC 2014-91, Hummer 2009-03

#### CODES:

|        |     |            |     |
|--------|-----|------------|-----|
| Epicor | DDM | Wrenchhead | DRE |
|--------|-----|------------|-----|

Provides a tight seal to the transfer case to prevent fluid leaks

- **Direct replacement** for a proper fit every time
- Easy to install

**DIRECT FIT**

#### Failure Mode:

- Replace when servicing transfer case
- Failure results in transmission fluid leak

## TRANSFER CASE MOTORS

30 SKUS AVAILABLE



**IMPORT**

### 600-935

Chrysler 2009-07, Dodge 2010-05,  
Mitsubishi 2009-06, Ram 2012-11

#### CODES:

|        |     |            |     |
|--------|-----|------------|-----|
| Epicor | DDM | Wrenchhead | DRE |
|--------|-----|------------|-----|

Connects to the transmission and axle shafts

- **Complete Kit** - Includes all necessary electrical pins and plugs for a complete repair
- **Dorman Engineered** - Sealed to protect against water intrusion or corrosion

**DORMAN**  
COMPLETE KIT

**DORMAN**  
ENGINEERED

#### Failure Mode:

- 4WD will not engage



Shift Fork Kit



Slip Yoke



4WD Differential Engagement Gear

## TRANSFER CASE MOTOR GEAR



**IMPORT**

**924-392**

BMW 2013-01, Mercedes-Benz 2013-06

**CODES:**

|        |     |            |     |
|--------|-----|------------|-----|
| Epicor | DDM | Wrenchhead | DRE |
|--------|-----|------------|-----|

**Gear located inside transfer case actuator**

- **Reduce Repair Cost** - Replace just the failed gear instead of the entire assembly
- **Dorman Engineered** - Constructed from a high temp nylon carbon fiber material for greater durability



**Failure Mode:**

- Original gear strips
- Failure results in loss of 4WD function

## TRANSMISSION OIL COOLER LINE CONNECTORS

**40 SKUS AVAILABLE**



**RUST**

**800-726**

Chevrolet 2007-01,  
GMC 2007-01



**RUST**

**800-719**

Chevrolet 2003-01,  
GMC 2003-01

**CODES:**

|        |     |            |     |
|--------|-----|------------|-----|
| Epicor | DDM | Wrenchhead | DRE |
|--------|-----|------------|-----|

**Provides connection point to the transmission oil cooler**

**Failure Mode:**

- Corrosion or O-ring deterioration
- Failure results in leaking transmission fluid

**FITS DORMAN OIL COOLER LINE**



**625-199**

Chevrolet 2008-06  
GMC 2008-06

## LIVE TECH SUPPORT AVAILABLE!



Online

[www.DormanProducts.com](http://www.DormanProducts.com)



Email

[techlinemarketing@  
dormanproducts.com](mailto:techlinemarketing@dormanproducts.com)



Phone

**1-866-933-2911**



Center Support Bearings



Differential Covers



Transmission Harness Connector Plug

## ABS CONTROL MODULES

18 SKUS AVAILABLE



**599-705**

Chevrolet Silverado 1500 2002-99,  
GMC Sierra 1500 2002-99

### CODES:

|        |     |            |     |
|--------|-----|------------|-----|
| Epicor | DDM | Wrenchhead | DRE |
|--------|-----|------------|-----|

**Restores your broken or malfunctioning anti-lock braking system**

- Completely remanufactured and vehicle simulator tested
- **Plug and play** - no programming required
- Updated with more durable main pump transistors to help prevent pump relay burnout

### Failure Mode:

- Moisture intrusion
- Failure results in loss of anti-lock brakes and illumination of the ABS light

## BODY CONTROL MODULES

6 SKUS AVAILABLE

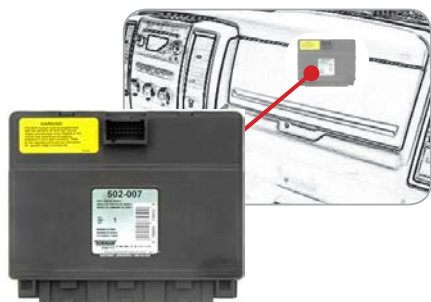

**502-007**

Chevrolet 2007-03, GMC 2007-03, Hummer 2007-06

### CODES:

|        |     |            |     |
|--------|-----|------------|-----|
| Epicor | DDM | Wrenchhead | DRE |
|--------|-----|------------|-----|

**Monitors and controls various electronic accessories in a vehicle**

- Completely remanufactured and tested for durability and quality assurance
- 100% replacement of relays, resistors and capacitors and soldering joints (where applicable)

### Failure Mode:

- Excessive heat, shock, movement, or mechanical wear cause original unit to fail
- Failure results in loss of various interior accessory functions

## DVD PLAYER REMOTE CONTROL



**57001**

Buick 2013-10, Cadillac 2013-10,  
Chevrolet 2013-10, GMC 2013-10, Saturn 2010-05

### CODES:

|        |     |            |     |
|--------|-----|------------|-----|
| Epicor | MDH | Wrenchhead | RNB |
|--------|-----|------------|-----|

**Have you lost or broken your vehicle's DVD remote?**

- This replacement restores the convenience of watching a movie in your vehicle

### Failure Mode:

- Lost or broken



OE Replacement Radios



Steering Wheel Position Sensor

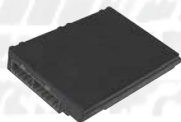

Power Seat Module

## HEADLIGHT LEVEL SENSOR



**IMPORT**

**924-755**

Lexus 2008-01, Mazda 2008-04, Toyota 2009-04

**CODES:**

|        |     |            |     |
|--------|-----|------------|-----|
| Epicor | DDM | Wrenchhead | DRE |
|--------|-----|------------|-----|

**Adjusts the headlight and suspension positions**

- **Dorman Engineered** - Re-designed to eliminate water intrusion
- **Reduce Repair Cost** - Replace just the failed sensor instead of the entire Headlight Leveling Sensor Assembly



**Failure Mode:**

- Wear and tear, water intrusion
- Failure results in headlight not adjusting properly to suspension height

## HVAC CONTROL MODULES

**OVER 50 SKUS AVAILABLE**



**599-147**

Jeep Commander 2007-06, Jeep Grand Cherokee 2007-05



**599-196**

Chrysler 300 2010-06, Dodge Charger 2010-06, Dodge Magnum 2008-06

**CODES:**

|        |     |            |     |
|--------|-----|------------|-----|
| Epicor | DDM | Wrenchhead | DRE |
|--------|-----|------------|-----|

**Controls a variety of cabin temperature settings**

- **Ready to Install** – Plug and play design requires no programming
- **Fully Remanufactured and Tested** – includes backlight replacement bulbs and O-rings (where applicable)

**Failure Mode:**

- Burnt out bulbs, fan and temperature control failure
- Dark display, inability to change modes, temperatures and fan speeds

## OCCUPANT DETECTION SENSOR



**IMPORT**

**601-004**

Lexus 2013-05, Scion 2013-06, Toyota 2013-03

**CODES:**

|        |     |            |     |
|--------|-----|------------|-----|
| Epicor | DDM | Wrenchhead | DRE |
|--------|-----|------------|-----|

**Sensor determines the presence of a passenger and engages the airbag**

- Popular replacement part due to highly failure prone original sensor
- **Dorman Engineered** - Upgraded design with new technology to eliminate water intrusions



**Failure Mode:**

- Water intrusion and electrical faults
- Failure results in passenger air bag light staying on



High Intensity Discharge Module



Electronic Shifter Module



Transfer Case Control Module

## RADIO CONTROL UNITS

OVER 5 SKUS AVAILABLE



**586-003**

Chrysler 2004-02, Dodge 2004-02, Jeep 2005-02

**CODES:**

|        |     |            |     |
|--------|-----|------------|-----|
| Epicor | DDM | Wrenchhead | DRE |
|--------|-----|------------|-----|

**Easy to install - No programming required**

- Upgraded with an auxiliary jack for easy connection to smart phones and MP3 players
- Fully remanufactured and tested

**Failure Mode:**

- Original bulbs burn out or electrical failure
- Failure results in a dark display and improper radio functioning

## TRANSMISSION CONTROL MODULES (TEHCM)

4 SKUS AVAILABLE



**609-000**

Buick 2009-08, Chevrolet 2009-08, Pontiac 2009-07, Saturn 2010



**609-001**

Buick 2012-10, Chevrolet 2012-10, GMC 2011-10



**609-002**

Cadillac 2011-10, Chevrolet 2013-10, GMC 2011-10



**609-003**

Chevrolet 2013-07, Cadillac 2010-08, GMC 2013-07

**CODES:**

|        |     |            |     |
|--------|-----|------------|-----|
| Epicor | DDM | Wrenchhead | DRE |
|--------|-----|------------|-----|

**Combines the transfer case motor, valve body solenoids, pressure and temperature switches into one unit**

- Fully remanufactured and vehicle simulator tested for durability and quality assurance
- 100% replacement of gaskets, grommets and seals
- **Plug and play** - Dorman's TEHCMS are programmed to match vehicle's VIN; saving time and money by eliminating a trip to the dealer

**FREE PRIORITY OVERNIGHT SHIPPING\***  
*Included with each order*

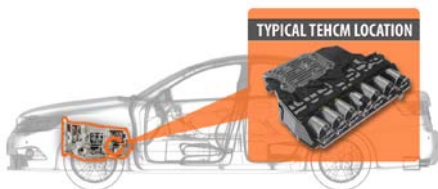

**Failure Mode:**

- Debris contaminates unit, deteriorating switches and solenoids
- Failure results in delayed shifting and/or the inability to shift gears

*\*For orders received before 5:00 PM EST*



Keyless Entry Remotes



Front Impact Sensors



Daytime Running Lamp Resistor



## DIP STICK TUBES (TRANSMISSION)

40 SKUS AVAILABLE



**RUST**

917-365

Cadillac 2013-07, Chevrolet 2013-07, GMC 2013-07

*Also Available from Dorman:  
Over 40 Application Specific  
Oil Dip Sticks*

### CODES:

|        |     |            |     |
|--------|-----|------------|-----|
| Epicor | DDM | Wrenchhead | DRE |
|--------|-----|------------|-----|

Connects to the transmission and guides the oil dipstick

- Direct replacement
- Prevents dirt and debris from entering the transmission oil

### Failure Mode:

- Over time engine vibration causes metal to fatigue and become damaged
- Failure results in oil leaks

## ENGINE CRANKCASE BREATHER HOSE CHECK VALVE - BMW



**IMPORT**

46063

BMW 2010-97

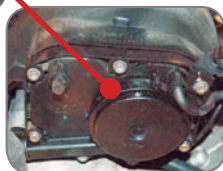

### CODES:

|        |     |            |     |
|--------|-----|------------|-----|
| Epicor | MDH | Wrenchhead | RNB |
|--------|-----|------------|-----|

Prevents engine oil leaks and restores drivability

### Failure Mode:

- Original internal diaphragm tears
- Failure results in vacuum leak

## ENGINE HARMONIC BALANCER BOLT



**IMPORT**

917-139

GM 2013-98, Saab 2009-05

### CODES:

|        |     |            |     |
|--------|-----|------------|-----|
| Epicor | DDM | Wrenchhead | DRE |
|--------|-----|------------|-----|

Bolt used to retain harmonic balancer

- Required when servicing any part that requires the harmonic balancer to be removed (such as timing covers)
- Original bolts cannot be reused

### Failure Mode:

- One time torque-to-yield bolt, replacement required when removed



Exhaust Manifold Kits



Oil Dip Stick Tubes



Turbocharger Kits

## ENGINE VARIABLE TIMING SOLENOIDS

67 SKUS AVAILABLE



**917-219**  
GM 2010-04

### CODES:

|        |     |            |     |
|--------|-----|------------|-----|
| Epicor | DDM | Wrenchhead | DRE |
|--------|-----|------------|-----|

Actuates variable valve timing by controlling oil flow and pressure

- **100% Tested** - All Dorman variable valve timing solenoids have undergone vehicle testing and laboratory testing for quality assurance
- **Plug and play** - easily plugs into the electrical harness
- **Complete Kit** - Includes all gaskets needed for a complete repair (where applicable)



### Failure Mode:

- Oil sludge builds up on screens and/or electrical failure
- Rough idle, loss of power, illumination of the check engine light



**IMPORT**  
**917-279**  
Subaru Forester 2004,  
Subaru Impreza 2006-04,  
Subaru Legacy 2006-05,  
Subaru Outback 2005

## ENGINE VARIABLE TIMING SPROCKETS

14 SKUS AVAILABLE



### CODES:

|        |     |            |     |
|--------|-----|------------|-----|
| Epicor | DDM | Wrenchhead | DRE |
|--------|-----|------------|-----|

Adjusts camshaft timing for optimal engine performance and efficiency

- **Complete Kit** - Includes hardware for a complete repair (where applicable)



### Failure Mode:

- Original oil passages clog with sludge, often due to long oil change intervals
- Loss of engine power accompanied by a knocking sound and diagnostic trouble code displayed



**917-254**  
Buick 2013-10, Chevrolet 2013-06, GMC 2010,  
Pontiac 2010-06, Saturn 2010-06



Oil Filter Adaptor Block



Manifold Converter Kit



Knock Sensor Adaptor

## IGNITION KNOCK (DETONATION) SENSOR CONNECTORS

4 SKUS AVAILABLE



**IMPORT**

**917-031**

Subaru Forester 2002-99,  
Subaru Impreza 2002-98, Subaru Legacy 2001-98

**CODES:**

|        |     |            |     |
|--------|-----|------------|-----|
| Epicor | DDM | Wrenchhead | DRE |
|--------|-----|------------|-----|

Sensor that sends signal from the knock sensor to the PCM/ECM

**Failure Mode:**

- Original cracks or corrodes
- Failure results in reduced performance and check engine light

## PCV VALVE HOSES - BMW



**IMPORT**

**46064**

BMW 2006-00



**IMPORT**

**46044**

BMW 2010-97

**CODES:**

|        |     |            |     |
|--------|-----|------------|-----|
| Epicor | MDH | Wrenchhead | RNB |
|--------|-----|------------|-----|

Allows crankcase pressure to escape the engine

**Failure Mode:**

- Original hose deteriorates over time, or becomes clogged
- Failure results in poor engine idle, leaks or illumination of the check engine light

## PCV VALVE TUBING - BMW



**IMPORT**

**917-125**

BMW 2008-06

**CODES:**

|        |     |            |     |
|--------|-----|------------|-----|
| Epicor | DDM | Wrenchhead | DRE |
|--------|-----|------------|-----|

Provides a tight seal between the PCV hoses to prevent vacuum leaks

- Replacement helps to ensure proper engine performance and longevity

**Failure Mode:**

- Failure results in oil and vacuum leaks



EGR Tubes



Crankcase Vent Valve



Exhaust Flange Hardware

## POWER STEERING PUMP FAN ASSEMBLY - Mini Cooper



**IMPORT**

**979-750**

Mini Cooper 2008-02

**CODES:**

|        |     |            |     |
|--------|-----|------------|-----|
| Epicor | DDM | Wrenchhead | DRE |
|--------|-----|------------|-----|

**Cools the power steering pump and cooler mechanism**

- Includes a fan grille to prevent debris from entering the fan assembly

**Failure Mode:**

- Fuse to the fan shorts out or overheats
- Failure results in lack of power steering

## TURBOCHARGER OIL LINES

**10 SKUS AVAILABLE**

**CODES:**

|        |     |            |     |
|--------|-----|------------|-----|
| Epicor | DDM | Wrenchhead | DRE |
|--------|-----|------------|-----|

**Supplies oil to turbocharger**

- A properly functioning turbocharger oil line is needed to avoid engine failure
- Direct replacement
- Recommended replacement when replacing turbo due to contamination

**DIRECT FIT**

**Failure Mode:**

- Oil leaks
- Failure results in engine or turbo failure

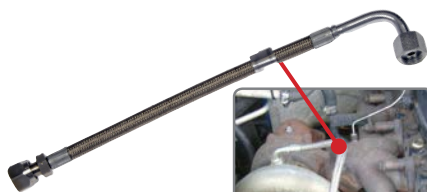

**625-211**

Dodge Ram 2500 2010-03,  
Dodge Ram 3500 2010-03,  
Dodge Ram 2500 2011,  
Dodge Ram 3500 2011



**IMPORT**

**625-812**

Mazda CX-7 2012-07



**625-813**

Chrysler PT Cruiser 2009-03



Camshaft Phasers



Transfer Case Housing



Variable Valve Timing Solenoids

## EXHAUST MANIFOLDS WITH INTEGRATED CATALYTIC CONVERTER\*

OVER 100 SKUS AVAILABLE



**IMPORT**

674-863

Lexus RX400h 2008-06, Toyota Highlander 2010-04

### CODES:

|        |     |            |     |
|--------|-----|------------|-----|
| Epicor | DDM | Wrenchhead | DRE |
|--------|-----|------------|-----|

Regulates exhaust emissions

- **Complete Kit** - Includes all hardware and gaskets for a complete repair (where applicable)



### Failure Mode:

- Original cracks or corrodes
- Failure results in illumination of the check engine light

*\*Not Carb Compliant; Not for sale in NY-CA.*

## INTAKE MANIFOLD FLAP MOTOR



**IMPORT**

911-903

Audi 2012-06, Volkswagen 2011-06

### CODES:

|        |     |            |     |
|--------|-----|------------|-----|
| Epicor | DDM | Wrenchhead | DRE |
|--------|-----|------------|-----|

Regulates air flow into the motor of the vehicle

### Failure Mode:

- Stuck open or closed
- Failure results in reduced engine performance, uneven engine operation, poor fuel economy and elevated emissions

## INTAKE MANIFOLD RUNNER CONTROL VALVES

OVER 10 SKUS AVAILABLE



911-912

Ford 2013-04, Lincoln 2013-05

### CODES:

|        |     |            |     |
|--------|-----|------------|-----|
| Epicor | DDM | Wrenchhead | DRE |
|--------|-----|------------|-----|

Optimizes power and torque to help improve overall engine performance and fuel efficiency

- **Reduce Repair Cost** - Replace only the failed part instead of the entire intake manifold (where applicable)



### Failure Mode:

- Original cracks, warps and/or corrodes
- Failure results in illumination of the check engine light and reduced engine performance



Intake Manifold Runner Controls



Air Filter Boxes



Air Pump Mounts

## HYBRID DRIVE BATTERIES

10 SKUS AVAILABLE

### TOYOTA



**IMPORT**

**587-000**  
Toyota Prius 2003-01

### HONDA



**IMPORT**

**587-006**  
Honda Accord  
2007-05

### NISSAN



**IMPORT**

**587-010**  
Nissan Altima  
2011-07

### FORD / MERCURY



**587-013**  
Ford Escape 2009-05,  
Mercury Mariner  
2009-06

#### CODES:

|        |     |            |     |
|--------|-----|------------|-----|
| Epicor | DDM | Wrenchhead | DRE |
|--------|-----|------------|-----|

**Ready to install Direct Replacements – no programming required**

- Includes modules (such as ECU) – no need to reuse from old battery
- Completely remanufactured and tested
- Each unit and individual cell is thoroughly tested and balanced to confirm optimal battery pack performance
- **Dorman Engineered** - Toyota batteries bus bars are upgraded to nickel plating to reduce corrosion (where applicable)



#### Failure Mode:

- Over time battery cells lose their ability to hold a charge
- Hybrid malfunction indication illuminates on dash
- Decreased fuel economy

#### ALSO NEW:

| Part # | Applications |
|--------|--------------|
|--------|--------------|

#### TOYOTA

**587-001** Toyota Prius 2009-04

**587-002** Toyota Camry 2011-07

#### HONDA

**587-003** Honda Civic 2005-03

**587-004** Honda Civic 2011-06

**587-005** Honda Insight 2006-00

## HYBRID SAFETY PLUG



**IMPORT**

**587-020**  
Lexus RX400h 2008-06, Toyota Highlander 2008-06,  
Toyota Prius 2003-01

#### CODES:

|        |     |            |     |
|--------|-----|------------|-----|
| Epicor | DDM | Wrenchhead | DRE |
|--------|-----|------------|-----|

**Safety plug for hybrid drive batteries to ensure voltage is not transmitted when plug is removed**

- Compatible with Dorman's hybrid drive batteries
- Easily plugs into the hybrid battery

#### Failure Mode:

- Lost or blown fuse
- Failure results in battery not functioning properly





**DID YOU KNOW?**  
DORMAN OFFERS OVER 1000 REPLACEMENT PARTS FOR POPULAR HYBRID APPLICATIONS

FOR MORE HYBRID INFORMATION, VISIT [DORMANHYBRID.COM](http://DORMANHYBRID.COM)

## INVERTER ASSEMBLIES - Toyota Prius

2 SKUS AVAILABLE



**IMPORT**

**587-900**  
Toyota Prius  
2003-01

**ALSO NEW:**

| Part #  | Applications         |
|---------|----------------------|
| 587-901 | Toyota Prius 2009-04 |

**CODES:**

|        |     |            |     |
|--------|-----|------------|-----|
| Epicor | DDM | Wrenchhead | DRE |
|--------|-----|------------|-----|

**Restores hybrid operation and drivability of vehicle**

- Replacement protects against potential damage to other hybrid system components
- Fully remanufactured and vehicle tested for performance and quality assurance

**Failure Mode:**

- Check engine light
- Reduced hybrid system performance

## ELECTRIC MOTOR TRANSMISSION STATOR - Toyota Prius



**IMPORT**

**587-990**  
Toyota Prius 2003-01

**CODES:**

|        |     |            |     |
|--------|-----|------------|-----|
| Epicor | DDM | Wrenchhead | DRE |
|--------|-----|------------|-----|

**Provides energy to help power the drive motor**

- Restores functionality of the electric drive motor system
- Includes removable alignment studs for installation assistance
- **Reduce Repair Cost** - Replace just the failed stator instead of the entire transmission assembly



**Failure Mode:**

- Vibration, friction, contamination and heat cause the original windings insulation to breakdown, short, and burn out
- Failure can cause a shudder during acceleration, temp warning light, and/or a loud whine during regen braking

## INVERTER COOLERS - Toyota Prius



**IMPORT**

**918-902**  
Toyota Prius 2003-01

**ALSO NEW:**

| Part #  | Applications         |
|---------|----------------------|
| 918-901 | Toyota Camry 2011-07 |

**CODES:**

|        |     |            |     |
|--------|-----|------------|-----|
| Epicor | DDM | Wrenchhead | DRE |
|--------|-----|------------|-----|

**Cools inverter fluid to keep batteries and inverter system at normal operating temperatures**

- Coated for high corrosion resistance and increased protection against the elements

**Failure Mode:**

- Corrosion due to exposure to the elements, road debris and collision
- Electric power becomes less efficient when original unit fails

# FREE PRODUCT TRAINING... EVEN ON THE GO!



## DORMAN<sup>®</sup> UNIVERSITY



- Training modules
- Installation videos
- Certificate of course completion

VISIT: [www.DormanUniversity.com](http://www.DormanUniversity.com)

## WIN a \$250 Visa Gift Card!



Qualifying Service Technicians and Counterpeople successfully completing Dorman U. courses earn entries to win!



## Dorman's TECHtube Installation Video Program

We want your installation videos!

- Simply upload your video (featuring a Dorman hard part) for a chance to win \$100\*

\*See website for terms and conditions



SCAN HERE ▶

[www.DormanProducts.com/techtube](http://www.DormanProducts.com/techtube)



Dorman Products, Inc.  
3400 East Walnut St., Colmar, PA 18915  
1-800-523-2492 (Customer Service)  
[www.DormanProducts.com](http://www.DormanProducts.com)  
© 2015 Dorman Products, Inc.

2015000

## DORMAN<sup>®</sup> NEW SINCE 1918