

# ***Speco***

## ***WHEEL NUTS***

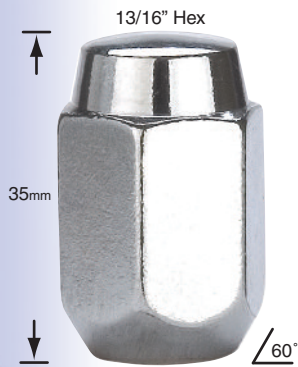



## STEEL WHEEL NUTS

SET OF 4	LOOSE IN BAGS	THREAD SIZE
WN101	WN701-10/50	7/16"
WN102	WN702-10/50	1/2"
WN103	WN703-10/50	12mm x 1.25
WN104	WN704-10/50	12mm x 1.50

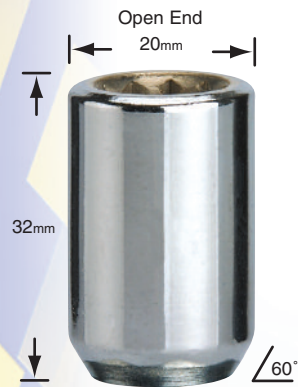

## STEEL WHEEL NUTS - TUNER NUTS

SET OF 16 + KEY	LOOSE IN BAGS	THREAD SIZE
WN151	WN751-10/50	7/16"
WN152	WN752-10/50	1/2"
WN153	WN753-10/50	12mm x 1.25
WN154	WN754-10/50	12mm x 1.50

## TUNER NUT KEY

WNK-TN

3/4" & 13/16" Hex



## STEEL WHEEL NUTS - BULGE NUTS

LOOSE IN BAGS	THREAD SIZE
WN604-10	12mm x 1.50
WN604-50	12mm x 1.50

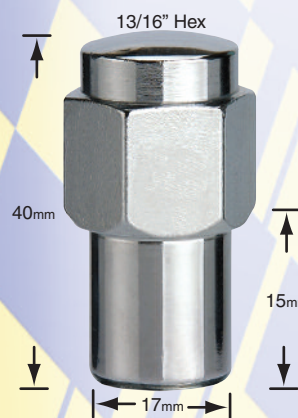

## MAG WHEEL NUTS

SET OF 4	LOOSE IN BAGS	THREAD SIZE
WN201	WN801-10/50	7/16"
WN202	WN802-10/50	1/2"
WN203	WN803-10/50	12mm x 1.25
WN204	WN804-10/50	12mm x 1.50

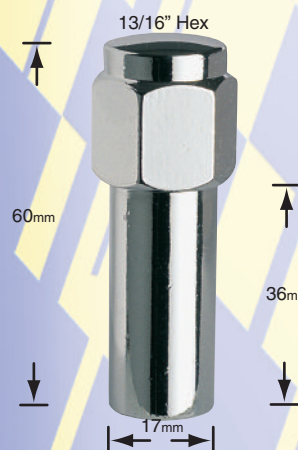

## CRAGAR MAG WHEEL NUTS

LOOSE IN BAGS	THREAD SIZE
WN901-5	7/16"
WN902-5	1/2"
WN903-5	12mm x 1.25
WN904-5	12mm x 1.50



## MAG WHEEL LOCKS

SET OF 4	SET OF 5	THREAD SIZE
WN301		7/16"
WN302		1/2"
WN303	WN3035	12mm x 1.25
WN304	WN3045	12mm x 1.50

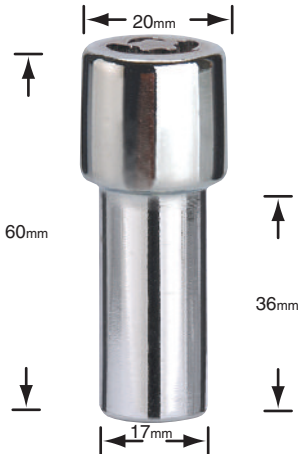

## CRAGAR MAG WHEEL LOCKS

SET OF 4	SET OF 5	THREAD SIZE
WN309		12mm x 1.50



## STEEL WHEEL LOCKS

SET OF 4	SET OF 5	THREAD SIZE
WN401		7/16"
WN402		1/2"
WN403	WN4035	12mm x 1.25
WN404	WN4035	12mm x 1.50



## STEEL WHEEL - OPEN END WHEEL LOCKS

SET OF 4	THREAD SIZE
WN305	7/16"
WN306	1/2"
WN307	12mm x 1.25
WN308	12mm x 1.50

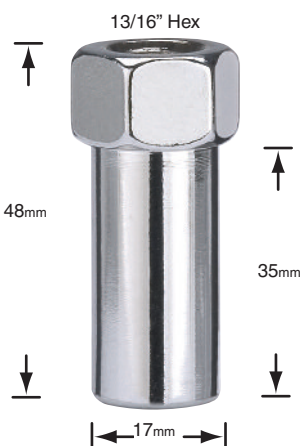

## MAG WHEEL - OPEN END - THREAD ALL THE WAY THROUGH

LOOSE IN BAGS	THREAD SIZE
WN805-5	1/2"
WN806-5	7/16"

## OEM - STEEL WHEEL NUTS - ZINC PLATED



SET OF 4	LOOSE IN BAGS	THREAD SIZE
WN501	WN501-50	7/16"
WN502	WN502-50	1/2"
WN503	WN503-50	12mm x 1.25
WN504	WN504-50	12mm x 1.50

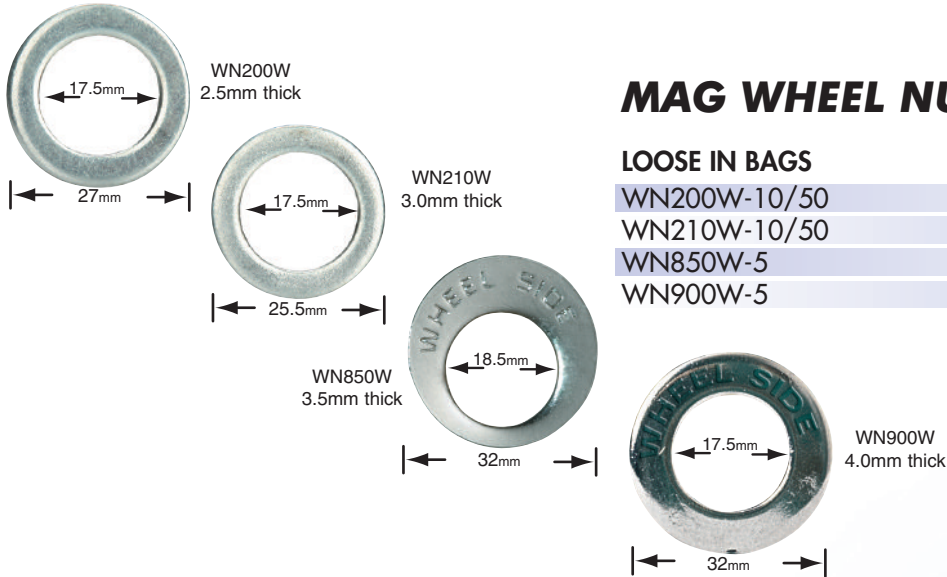

## MAG WHEEL NUT WASHERS

### LOOSE IN BAGS

WN200W-10/50	STANDARD MAG WASHER
WN210W-10/50	SMALL MAG WASHER
WN850W-5	CRAGAR OFFSET
WN900W-5	CRAGAR MAG WASHER

## WHEEL SPACERS - DISC BRAKE SPACERS

### PACKED IN PAIRS

WS3000	3mm THICK	SUIT 4 & 5 STUD CAR WHEELS
WS4000	1/4" THICK-6mm	SUIT 4 STUD CAR WHEELS
WS5000	5/16" THICK-8mm	SUIT 5 STUD CAR WHEELS
WS6000	1/4" THICK-6mm	SUIT 5 & 6 STUD 4WD WHEELS

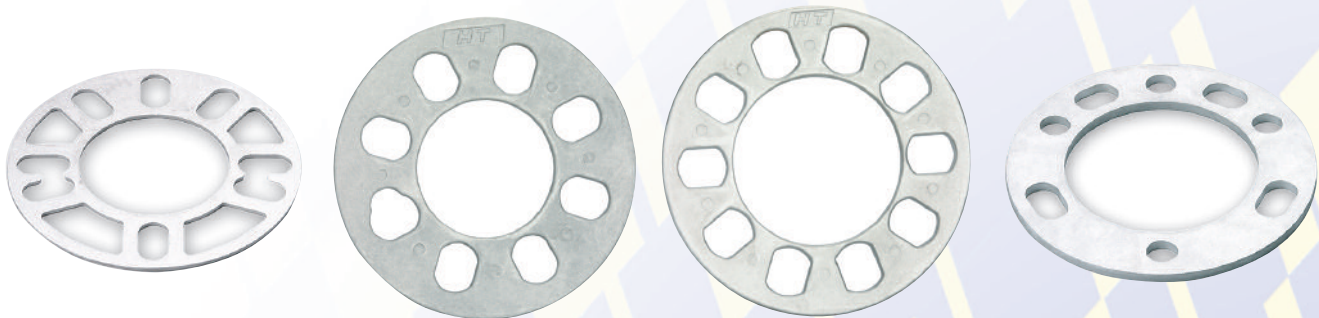

**NOTE - WHEEL LOCK KEYS ARE AVAILABLE SEPARATELY FOR THE STEEL WHEEL LOCKS, MAG WHEEL LOCKS AND OPEN END WHEEL LOCKS.  
PLEASE ENSURE THAT YOU RECORD THE KEY NUMBER WHEN PURCHASED IN CASE YOU LOSE THE KEY.**

# Speco Thomas

PTY LTD ABN 51 357 001 657

1 B LEVANSWELL ROAD MOORABBIN

VICTORIA 3189 AUSTRALIA

Phone: (03) 9555 7244 (5 lines) Fax: (03) 9553 2841  
Email: info@speco.com.au Web: www.speco.com.au

# VEHICLE APPLICATION LISTING

MAKE	MODEL	YEAR	STUD SIZE	MAKE	MODEL	YEAR	STUD SIZE	
<b>ALFA ROMEO</b>	GTV6	1981	ALL	<b>HOLDEN</b>	APOLLO	PRE 1992	12 x 1.5mm	
	ALFA 75	1986	12 x 1.5mm		APOLLO	1992 +	12 x 1.5mm	
	ALFA 90 2.5L				ASTRA	PRE 1988-99	12 x 1.25mm	
	ALFA 90	1985			ASTRA CD, SRI	1999 +	12 x 1.5mm	
	ALFA 95	1986			BARINA	1989 +	12 x 1.25mm	
	ALFA 164	1991-93			CAMARO	1978-93	12 x 1.5mm	
	147	2001 +			COMMODORE VB-VY11	1976-2002 +	12 x 1.5mm	
	156	1999 +			MONARO CV6, CV8	2001 +	12 x 1.5mm	
	166	1999 +			CORVETTE	1976-93	12 x 1.5mm	
	SPIDER CONVERT	1998 +			CRUZE	2002 +	12 x 1.25mm	
	GTV COUPE	1998 +			GEMINI	1975-86	12 x 1.5mm	
	<b>CHRYSLER</b>	CHEROKEE – JEEP	1974-83		1/2"	HOLDEN FX-HZ	1952-79	7/16"
		J10 JEEP	1974-92		1/2"	JACKAROO	PRE 1995	12 x 1.5mm
		CHEROKEE GRAND	1974-92		1/2"	NOVA	ALL	12 x 1.5mm
CHEROKEE JEEP		1990 +	1/2"	RODEO	ALL	12 x 1.5mm		
CROSS FIRE		2004	1/2"	STATESMAN WB		7/16"		
JEEP CJ, DJ		PRE 1985	1/2"	STATESMAN VS-VT	1994 +	12 x 1.5mm		
PT CRUISER		2000 +	12 x 1.5mm	TORANA	1969-80	7/16"		
VALIANT		UP TO 1979	7/16"	<b>HONDA</b>	ACCORD, CRX, CIVIC	1982-2003+	12 x 1.5mm	
VOYAGER		1997 +	12 x 1.5mm		CITY, CIVIC	PRE 1980	12 x 1.25mm	
WRANGLER, RENEGADE		ALL	1/2"		CONCERTO	1986 +	12 x 1.5mm	
<b>DAEWOO</b>		LEGANZA	1997 +		12 x 1.5mm	CRV, HRV	1998 +	12 x 1.5mm
	MATIZ	1999 +	12 x 1.25mm		INTEGRA	1986 +	12 x 1.5mm	
	SSANG YONG MUSSO	1999 +	12 x 1.5mm		JAZZ	2002 +	12 x 1.5mm	
	TACUMA	2000 +	12 x 1.5mm		LEGEND	PRE 1991	12 x 1.5mm	
	<b>DAIHATSU</b>	APPLAUSE	1987+		ALL	LEGEND	1991 +	12 x 1.5mm
		CHARADE	PRE 1985		12 x 1.5mm	NSX		12 x 1.5mm
CHARADE		1986 +			ODESSY	1995 +	12 x 1.5mm	
CHARADE		2003			PRELUDE	PRE 1991-92+	12 x 1.5mm	
FEROZA		1994 +		S2000	1999 +	12 x 1.5mm		
ROCKY		1984 +		<b>HYUNDAI</b>	ACCENT	2000 +	ALL	
SIRION, PYZAR		1998 +			COUPES	1996 +	12 x 1.5mm	
TERIOS	1996 +		EXCEL		1986 +			
<b>DATSUN</b>	180, 180B, 200B	1977-80	ALL		ELANTRA	2001 +		
	STANZA	PRE 1984	12 x 1.25mm		GRANDEUR XG	1999 +		
	STANZA	1987-90			GETZ	2002 +		
	280C	1978 +			LANTRA	1991 +		
	240Z, 260Z, 280Z	1970-78			S COUPE	1990 +		
280ZX	1979-83		SONATA		1991 +			
<b>FORD</b>	CAPRI SA-SC	1989-93	12 x 1.5mm		SANTE FE	2000 +		
	CORSAIR	1989 +	12 x 1.5mm		TRAJET	2000 +		
	CORTINA MK1	1962-66	7/16"	TIBURON	2001 +			
	CORTINA TC to TF	1971-80	12 x 1.5mm	<b>KIA</b>	CARNIVAL	1999 +	ALL	
	COURIER		12 x 1.5mm		MENTOR	1994 +	12 x 1.5mm	
	ESCORT MK1, MK11	1972-75	7/16"		OPTIMA	2001 +		
	ESCORT MK11	1975-80	12 x 1.5mm		RIO	2000 +		
	EXPLORER	1996 +	1/2"		SPECTRA	2001 +		
	FAIRLANE	1969-99	1/2"		SPORTAGE	1994 +		
	FAIRLANE AU	1999 +	1/2"		SORENTO	2003 +		
	FALCON XK – BA	1960-2002+	1/2"	<b>LADA</b>	NIVA, SAMARA	1985 +	12 x 1.25mm	
	FOCUS	2002	12 x 1.5mm		<b>LAND ROVER/ RANGE ROVER</b>	FREELANDER	1998 +	12 x 1.5mm
	KA	1999 +	12 x 1.5mm			<b>LEXUS</b>	IS200	1999 +
	LASER, METEOR	1981-90	12 x 1.5mm	IS300			2001 +	12 x 1.5mm
	LASER, SR2	1990 +	12 x 1.5mm	CS250	1990-91			
	MAVERICK		12 x 1.25mm	CS300, SC400	1992 +			
	MONDEO	1995 +	12 x 1.5mm	GS300	1998 +			
	MUSTANG	1979-84	1/2"	SC430	2001 +			
	MUSTANG COBRA	2000 +	1/2"	RX330	2003			
	PROBE	1994 +	12 x 1.5mm					
	TAURUS	1996 +	12 x 1.5mm					
	TELSTAR	PRE 1987	12 x 1.5mm					
	TELSTAR	1987 +	12 x 1.5mm					
F100, F150, BRONCO	1975-84	1/2"						
F250, F350	2001	1/2"						



# VEHICLE APPLICATION LISTING

MAKE	MODEL	YEAR	STUD SIZE	MAKE	MODEL	YEAR	STUD SIZE	
<b>MAZDA</b>	121	1986-90	ALL	<b>ROVER</b>	2000, 2200TC, 3500	1972-77	7/16"	
	323	1982-89	12 x 1.5mm		SDI 3500	1978 +	12 x 1.5mm	
	626, MX6	1983-88 +			QUINTET, 416, VITESSE	1983 +	12 x 1.5mm	
	929	1982 +			825-SI + STERLING	1987 +	12 x 1.5mm	
	ASTINA	1995 +			<b>SUBARU</b>	BRUMBY	1985 +	ALL
	MAZDA 2	2002 +				FIGO	1982 +	12 x 1.25mm
	MAZDA 6	2002 +				FORESTER	1997 +	
	METRO	1997 +				IMPREZA (ALL)	1996 +	
	MPV	1988 +				LEGACY OUTBACK	1996 +	
	MX5	1990 +				LEONE	1985 +	
	MX6	1992 +			LIBERTY (ALL)	1988 +		
	PREMACY	2000 +			OUTBACK	2001 +		
	RX7	1984-93 +		SHERPA	1982 +			
	RX8	2003 +		SPORTWAGON	2001			
	B SERIES	ALL		SVX	1992 +			
	E2000	ALL		<b>SUZUKI</b>	BALENO	1995 +	ALL	
	B2600, BRAVO	ALL			CINO	1986 +	12 x 1.25mm	
	<b>MITSUBISHI</b>	CHALLENGER	1998 +		ALL	JIMMY	ALL	
COLT		1980 +	12 x 1.5mm		LIANA	2001		
GALANT		1970-89 +			SIERRA	ALL		
LANCER		1977-93 +			SWIFT	1992 +		
MAGNA		ALL		VITARA	ALL			
MIRAGE		1998 +		<b>TOYOTA</b>	AVALON	2000 +	ALL	
OUTLANDER		2003 +			AVENSIS VERSO	2001	12 x 1.5mm	
PAJERO		ALL			CAMRY	ALL		
SCORPION		1979			CELICA	ALL		
SIGMA		1977-79			COROLLA	ALL		
STARION		1982 +			CORONA	ALL		
STARWAGON		1982-85			CRESSIDA	1978-87 +		
3000 GT	1992 +		ECHO		1999 +			
<b>NISSAN</b>	180 SX, 200SX	1994 +	ALL		KLUGER	2003 +		
	300ZX	1984 +	12 x 1.25mm		LEXEN	1991 +		
	BLUEBIRD	1981-93			LITE ACE	1982 +		
	EXA	1987 +			MR2	ALL		
	GAZELLE, 240K	1984-88		PRIUS	2001 +			
	GTR COUPE	1993 +		RAV 4	1995 +			
	INFINITY	1993 +		SPRINTER	1983 +			
	MAXIMA	1985 +		SPACIA	1996 +			
	MICRA	1985-93		SUPRA	PRE 1985			
	NAVARA	ALL		STARLET	1997-98			
	NOMAD	1987 +		TERCEL	ALL			
	NXR COUPE	1993 +		TARAGO	1983 +			
	PATHFINDER	ALL		FORERUNNER				
	PATROL	ALL		HILUX	ALL			
	PINTARA	1986 +		HI-ACE	ALL			
	PRARIE	1987 +		LANDCRUISER 70,75,80				
	PULSAR	ALL		PRADO 90, 120	1996 +			
	SERENA	1996 +		<b>VOLKSWAGEN</b>	PASSAT	1973 +	12 x 1.5mm	
	SKYLINE	1978-85			PASSAT	2003	12 x 1.5mm	
	SKYLINE GTR	1996 +			VIENTO	1991 +	12 x 1.5mm	
	360Z	2003 +		<b>VOLVO</b>	164	1973-75	1/2"	
X-TRAIL	2001 +		242, 244, 245		1974 +	1/2"		
TERRANO	ALL		262, 264, 265		1976 +	1/2"		
URVAN	ALL		240		1986-90	1/2"		
<b>PROTON</b>	JUMBUCK	2003	ALL		340, 360	1984-87	12 x 1.25mm	
	PERSONA, SATRIA	1996 +	12 x 1.5mm		440	1993-96	12 x 1.25mm	
	WIRA	1994 +			740	1988+	1/2"	
	WAJA	2001+			740T, 760	1987-92	12 x 1.5mm	
	M21	1997 +			940	1991	12 x 1.5mm	
					960	1996 +	12 x 1.5mm	
			S40, V40		1997 +	12 x 1.5mm		

