

Stock Timing Pulleys



STOCK TIMING PULLEYS 1/5" - 7/8" PITCH QD, TAPER BUSHED AND STOCK BORE



Stock Bore



Taper Bushed



QD

Pitch (Inches)	Pulley Designation
1/5"	XL (Extra Light)
3/8"	L (Light)
1/2"	H (Heavy)
7/8"	XH (Extra Heavy)

Martin timing pulleys are manufactured to extremely close specifications and are stocked in minimum plain bore, taper bushed and QD bushed styles depending on size and pitch.

See tables for stock pulley types. Bushings are priced separately and must be added to pulley price.

Illustrations below indicate stock pulley construction type listed in tables.

Type DF

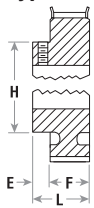

Type D

Type CF

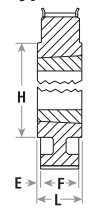

Type C

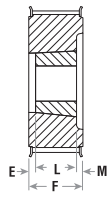

Type KF

Type AF

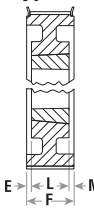

Type A

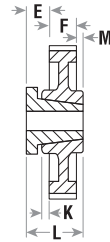

Type G

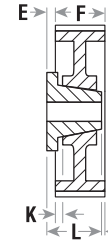

Type H

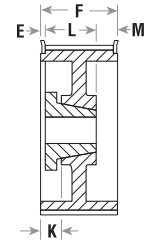

Type J

"F" designation in pulley type means pulley is flanged. When drive center distance is eight times the diameter of the smaller pulley or when drive is operating on vertical shafts, both pulleys should be flanged.

DEFINITION OF CATALOG NUMBERS

EX: TB 20L100

- TB — Requires taper bushing
- 20 — Number of teeth
- L — 3/8" pitch (light)
- 100 — Belt width 1"

EX: 72L100SD

- 72 — Number of Teeth
- L — 3/8" pitch (light)
- 100 — Belt width 1"
- SD — requires QD bushing

EX: 16L100

Min. plain bore

Pulley sizes shown stocked as stock bore only: max. bore listed is without keyway. If keyway is used reduce max. bore by twice keyway depth.

Pulley Style Designation As Shown in Tables

- Dash 1 = Block body style
- Dash 2 = web style
- Dash 3 = arm/spoke style

Size XXH (1-1/4" Pitch).
Available as made-to-order.
Call your nearest Martin facility.

Let us quote your made-to-order and large quantity requirements.

Timing belts and pulleys — in order to handle a wide range of loads, speeds and applications at highest possible efficiencies — are made in five stock pitches. Circular pitch (usually referred to as pitch) is a basic consideration in the selection of timing pulleys as with gear and chain drives. Pitch is the distance between groove centers and is measured on the pulley pitch circle. On the belt, pitch is the distance between tooth centers and is measured on the pitch line of the belt.

The pitch line of the belt is located within the tension member and coincides with the pitch circle of the pulley mating with it. Any timing belt must be run with pulleys of the same pitch. A belt of one pitch cannot be used successfully with pulleys of a different pitch.

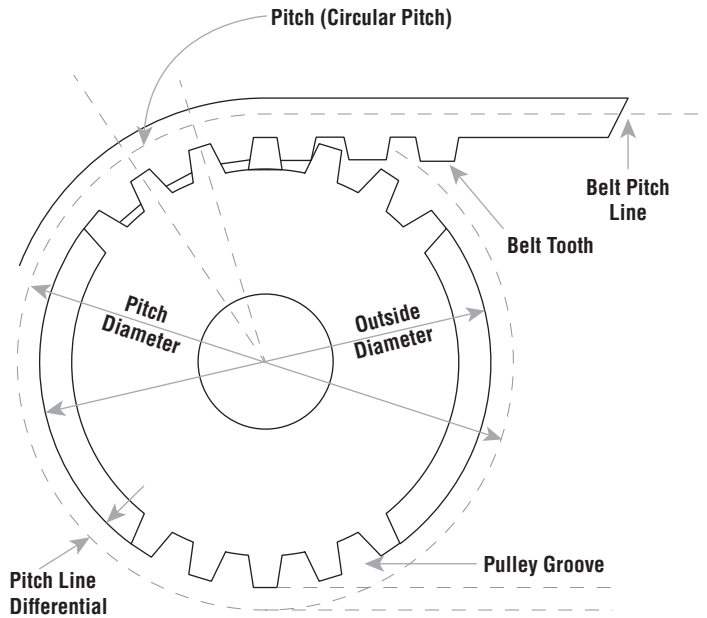

TIMING BELT TERMINOLOGY

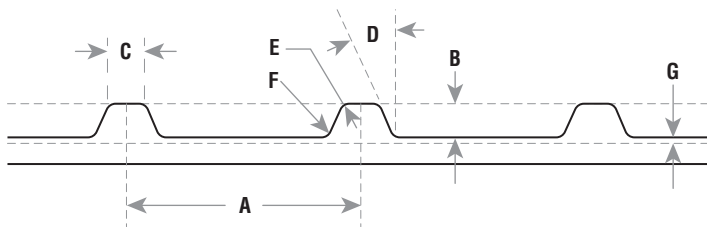

- A** Pitch of teeth
- B** Depth of teeth
- C** Width at bottom of teeth
- D** Pressure angle
- E** Radius at bottom of teeth
- F** Radius at top of teeth
- G** Pitch line differential

Belt P.L. = "A" X total no. of teeth in belt

TIMING PULLEY TERMINOLOGY

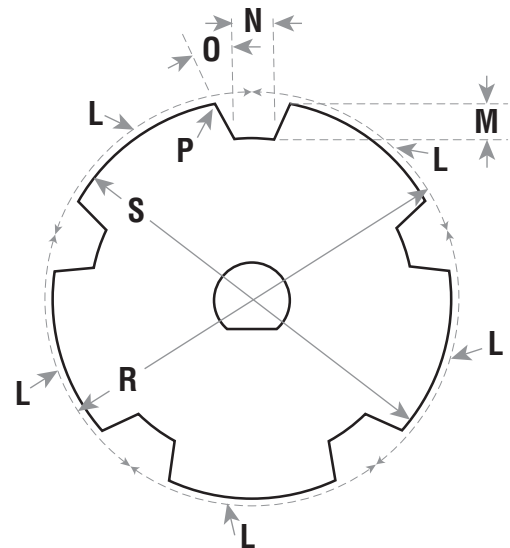

- L** Circular pitch of groove
- M** Minimum depth of groove, including clearance
- N** Width of groove at minimum depth, including clearance
- O** Pressure angle
- P** Top radius of groove
- R** Pitch diameter (always > S)
- S** Outside diameter

Timing Pulley Terminology



Timing Pulleys

Timing pulleys have evenly spaced axial grooves cut in their periphery to make correct, positive engagement with the mating teeth of the belt. These pulleys are designed so that the teeth of the belt enter and leave the grooves with negligible friction. All pulleys, stock and made-to-order, have minimum tooth-to-groove clearance (backlash). The pulley's pitch diameter will always be greater than its outside diameter. Pulleys are available in a wide range of stock widths and diameters.

Minimum Pulley Diameters

Pitch	Speed RPM	Recommended minimum*	No. of grooves
		Pitch (diam. in)	
1/5 in (XL)	3500	.764	12 XL
	1750	.637	10 XL
	1160	.637	10 XL
3/8 in (L)	3500	1.910	16 L
	1750	1.671	14 L
	1160	1.432	12 L
1/2 in (H)	3500	3.183	20 H
	1750	2.865	18 H
	1160	2.546	16 H
7/8 in (XH)	1750	7.242	26 XH
	1160	6.685	24 XH
	870	6.127	22 XH
1-1/4 in (XXH)	1750	10.345	26 XXH
	1160	9.549	24 XXH
	870	8.754	22 XXH

*Smaller diameter pulleys can be used if a corresponding reduction in belt service life is satisfactory.

Flanged Pulleys

Because timing belts have an inherent, gentle side thrust, it is necessary to use at least one flanged pulley to prevent the belt from riding off. Generally, for economy, the smaller pulley in each drive is flanged. However, when the center distance is greater than eight times the diameter of the smaller pulley on drive ratios less than 3 to 1, or when the drive is operated on other than horizontal shafts — both pulleys should be flanged. When a drive has three pulleys, at least two should be flanged. If the drive has more than three pulleys, every other pulley should be flanged.

Pulley Diameters

Stock timing belts should not be used over pulley diameters less than those recommended above without expecting some reduction in belt life. This reduced belt life is the result of flex fatigue of the steel tension members in the belt. If pulleys smaller than recommended must be used, the use of special timing belts should be considered.

Type AF

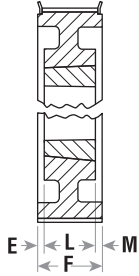

Type A

Dash 1 = Solid Style

Type DF

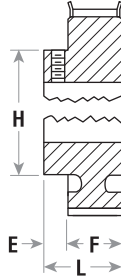

Type D

Dash 2 = Web Style

"F" type description indicates flanged.

Type EF

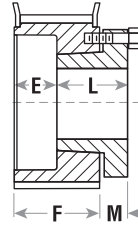

Type E

Type GF

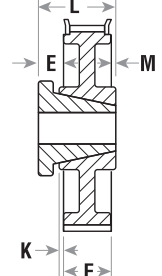

Type G

Dash 3 = Arm/Spoke Style

XL - 1/5" Pitch

XL 037 For Belts 1/4" and 3/8" Wide

Minimum Plain Bore

F = 9/16

No. Teeth	Part Number	Pitch Diameter	Max FL O.D.	Type	Bore		E	H	L	Wt.
					Stock	Max.				
10	10XL037	0.637	0.929	DF-1	0.1875	0.25	0.2188	0.4375	0.7813	0.03
11	11XL037	0.700	0.929	DF-1	0.1875	0.25	0.2188	0.4375	0.7813	0.04
12	12XL037	0.764	0.993	DF-1	0.1875	0.3125	0.2188	0.5	0.7813	0.06
14	14XL037	0.891	1.120	DF-1	0.25	0.375	0.2188	0.5625	0.7813	0.08
15	15XL037	0.955	1.184	DF-1	0.25	0.4375	0.2188	0.6250	0.7813	0.09
16	16XL037	1.019	1.248	DF-1	0.25	0.5	0.2188	0.6875	0.7813	0.10
18	18XL037	1.146	1.375	DF-1	0.25	0.5625	0.2188	0.8125	0.7813	0.13
20	20XL037	1.273	1.502	DF-1	0.25	0.6875	0.3125	0.9375	0.875	0.18
21	21XL037	1.337	1.566	DF-1	0.25	0.6875	0.3125	0.9375	0.875	0.19
22	22XL037	1.401	1.630	DF-1	0.25	0.75	0.3125	1	0.875	0.22
24	24XL037	1.528	1.756	DF-1	0.25	0.8125	0.3125	1.0625	0.875	0.25
28	28XL037	1.783	2.011	DF-1	0.25	0.9375	0.3125	1.1875	0.875	0.34
30	30XL037	1.910	2.138	DF-1	0.3125	1.0625	0.3125	1.375	0.875	0.41
32	32XL037	2.037	—	D-1	0.3125	1.1875	0.4375	1.5	1	0.25
36	36XL037	2.292	—	D-1	0.3125	1.1875	0.4375	1.5	1	0.29
40	40XL037	2.546	—	D-1	0.3125	1.1875	0.4375	1.5	1	0.35
42	42XL037	2.674	—	D-1	0.3125	1.1875	0.4375	1.5	1	0.31
44	44XL037	2.801	—	D-1	0.3125	1.1875	0.4375	1.5	1	0.34
48	48XL037	3.056	—	D-1	0.3125	1.1875	0.4375	1.5	1	0.63
60	60XL037	3.820	—	D-1	0.375	1.1875	0.4375	1.5	1	0.90
72	72XL037	4.584	—	D-1	0.375	1.1875	0.4375	1.5	1	0.50

Note: XL Pulleys stocked min. plain bore with 2 setscrews @ 90°. If keyway is used, reduce max. bore by twice keyway depth.
Pulley O.D. = P.D. - .02".

L 3/8" Pitch

Stock Timing Pulleys

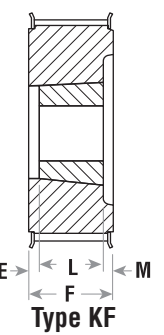
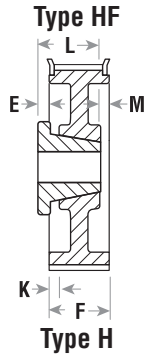
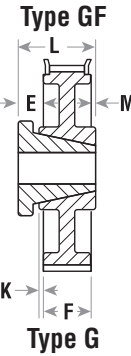
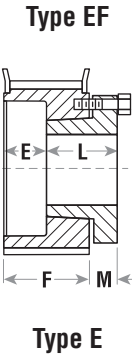
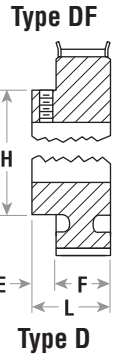
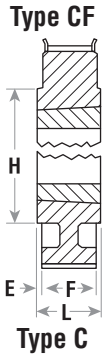

Dash 1 = Solid Style

Dash 2 = Web Style

Dash 3 = Arm/Spoke Style

L - 3/8" Pitch

L050 For Belts 1/2" Wide

Minimum Plain Bore

F = 3/4

No. Teeth	Part Number	Pitch Diameter	Max FL O.D.	Type	Bore		Dimensions			Wt.
					Stock	Max.	E	H	L	
10	10L050	1.194	1.4375	DF-1	0.375	0.5625	0.375	0.8125	1.125	0.28
12	12L050	1.432	1.6719	DF-1	0.375	0.8125	0.5	1.0625	1.25	0.30
13	13L050	1.552	1.75	DF-1	0.375	0.8125	0.5	1.125	1.25	0.35
14	14L050	1.671	1.9219	DF-1	0.375	0.875	0.5	1.125	1.25	0.40
15	15L050	1.790	2	DF-1	0.5	0.9375	0.5	1.125	1.25	0.50
16	16L050	1.910	2.1563	DF-1	0.5	1.125	0.625	1.4375	1.375	0.60
17	17L050	2.029	2.2813	DF-1	0.5	1.125	0.625	1.5	1.375	0.65
18	18L050	2.149	2.3906	DF-1	0.5	1.1875	0.625	1.625	1.375	0.75
19	19L050	2.268	2.375	DF-1	0.5	1.1875	0.625	1.625	1.375	0.80
20	20L050	2.387	2.625	DF-1	0.5	1.25	0.625	1.6875	1.375	0.94
21	21L050	2.507	2.75	DF-1	0.5	1.3125	0.6875	1.875	1.4375	1.00
22	22L050	2.626	2.875	DF-1	0.5	1.5	0.75	2	1.5	1.10
24	24L050	2.865	3.1094	DF-1	0.5	1.625	0.75	2.25	1.5	1.60
26	26L050	3.104	3.3438	DF-1	0.5	1.625	0.75	2.50	1.5	2.30
28	28L050	3.342	3.5781	DF-1	0.5	1.625	0.75	2.75	1.5	2.50
30	30L050	3.581	3.8281	DF-1	0.5	1.625	0.75	2.375	1.5	2.70
32	32L050	3.820	4.0625	DF-1	0.5	1.875	0.875	3.0625	1.625	3.00

L Pulleys 10 - 16 teeth min. plain bore stocked with 1 set screw. If keyway is used, reduced max. bore by twice keyway depth.

Dimensions in inches. Weight in pounds
Pulley O.D. = P.D. - .03"

L - 3/8" Pitch

L050 For Belts 1/2" Wide (3/8" Pitch)

QD Type

F = 3/4

No. Teeth	Part Number	Pitch Diameter	Max FL O.D.	Type	Bush	Bore Range		Dimensions				Wt. Less Bush
						Min.	Max.	E	K	L	M	
18	18L050JA	2.149	2.3906	EF-1*	JA	0.5	1.25	0.1875	—	1.0625	0.5	0.40
20	20L050JA	2.387	2.625	EF-1*	JA	0.5	1.25	0.1875	—	1.0625	0.5	0.50
22	22L050JA	2.626	2.875	EF-1*	JA	0.5	1.25	0.1875	—	1.0625	0.5	0.70
24	24L050SH	2.865	3.1094	GF-1+	SH	0.5	1.6875	0.5625	—	1.3125	—	0.70
26	26L050SH	3.104	3.3438	GF-1+	SH	0.5	1.6875	0.5625	—	1.3125	—	1.00
28	28L050SH	3.342	3.5781	GF-1+	SH	0.5	1.6875	0.5625	—	1.3125	—	1.10
30	30L050SDS	3.581	3.8281	GF-1	SDS	0.5	2	0.625	—	1.375	—	1.10
32	32L050SDS	3.820	4.0625	GF-1	SDS	0.5	2	0.625	—	1.375	—	1.40
36	36L050SDS	4.297	4.5313	GF-1	SDS	0.5	2	0.625	—	1.375	—	2.00
40	40L050SDS	4.775	5.0156	GF-1	SDS	0.5	2	0.625	—	1.375	—	2.80
44	44L050SDS	5.252	5.4844	GF-1	SDS	0.5	2	0.625	—	1.375	—	3.60
48	48L050SDS	5.730	6.0156	GF-1	SDS	0.5	2	0.625	—	1.375	—	4.40
60	60L050SD	7.162	—	G-3	SD	0.5	2	0.875	0.25	1.8125	0.25	4.20
72	72L050SD	8.594	—	G-3	SD	0.5	2	0.875	0.25	1.8125	0.25	6.60
84	84L050SD	10.027	—	G-3	SD	0.5	2	0.875	0.25	1.8125	0.25	5.80

Dimensions in inches. Weight in pounds
Pulley O.D. = P.D. - .03"
*Reverse mount drilled only
+Bushing Projects 1/16 on Small End.

L050 Taper Bushed
on Page K7

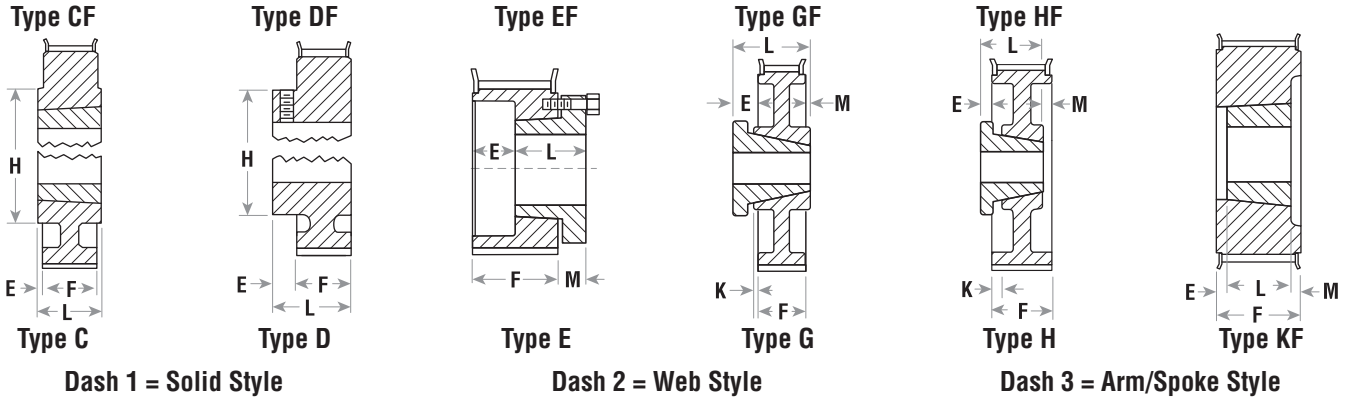

L - 3/8" Pitch

L050 For Belts 1/2" Wide (3/8" Pitch)

Taper Bushed Type

F = 3/4

No. Teeth	Part Number	Pitch Diameter	Max FL O.D.	Type	Bush	Bore Range		Dimensions				Wt. Less Bush
						Min.	Max.	E	K	L	M	
18	TB18L050	2.149	2.3906	CF-1	1008	0.5	1	0.125	1.875	0.875	—	0.45
20	TB20L050	2.387	2.625	CF-1	1008	0.5	1	0.125	1.6875	0.875	—	0.68
22	TB22L050	2.626	2.875	CF-1	1008	0.5	1	0.125	2	0.875	—	0.90
24	TB24L050	2.865	3.1094	CF-1	1210	0.5	1.25	0.25	2.25	1	—	1.00
26	TB26L050	3.104	3.3438	CF-1	1210	0.5	1.25	0.25	2.5	1	—	1.20
28	TB28L050	3.342	3.5781	CF-1	1610	0.5	1.25	0.25	2.75	1	—	1.40
30	TB30L050	3.581	3.8281	CF-1	1610	0.5	1.625	0.25	2.875	1	—	1.50
32	TB32L050	3.820	4.0625	CF-1	1610	0.5	1.625	0.25	3.0625	1	—	1.90
40	TB40L050	4.775	5.0156	CF-1	2012	0.5	2	0.50	3.6875	1.25	—	2.40
48	TB48L050	5.730	6.0156	CF-1	2012	0.5	2	0.50	3.6875	1.25	—	3.20
60	TB60L050	7.162	—	C-2	2012	0.5	2	0.25	4.375	1.25	0.25	4.90

Dimensions in inches. Weight in pounds.
Pulley O.D. = P.D. - .03"

L - 3/8" Pitch

L075 For Belts 3/4" Wide (3/8" Pitch)

Minimum Plain Bore

F = 1

No. Teeth	Part Number	Pitch Diameter	Max FL O.D.	Type	Bore		Dimensions			Wt.
					Stock	Max.	E	H	L	
12	12L075	1.432	1.6719	DF-1	0.375	0.8125	0.5	1.0625	1.5	0.40
14	14L075	1.671	1.9219	DF-1	0.375	0.875	0.5	1.125	1.5	0.50
16	16L075	1.910	2.1563	DF-1	0.5	1.125	0.625	1.4375	1.625	0.70
18	18L075	2.149	2.3906	DF-1	0.5	1.1875	0.625	1.625	1.625	0.90
20	20L075	2.387	2.625	DF-1	0.5	1.25	0.625	1.6875	1.625	1.50
22	22L075	2.626	2.875	DF-1	0.625	1.5	0.75	2	1.75	1.80
24	24L075	2.865	3.1094	DF-1	0.625	1.625	0.75	2.25	1.75	2.10
26	26L075	3.104	3.3438	DF-1	0.625	1.625	0.875	2.5	1.875	2.80
28	28L075	3.342	3.5781	DF-1	0.625	1.875	1	2.75	2	3.10
30	30L075	3.581	3.8281	DF-1	0.625	1.875	1	2.875	2	3.40
32	32L075	3.820	4.0625	DF-1	0.625	1.875	1	3.0625	2	3.70

Dimensions in inches. Weight in pounds.
Pulley O.D. = P.D. - .03"

L Pulleys 12 - 16 teeth min. plain bore stocked with 1-SS. If keyway is used, reduce max. bore by twice keyway depth.

L 3/8" Pitch

Stock Timing Pulleys

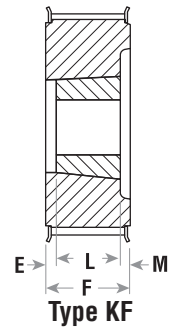
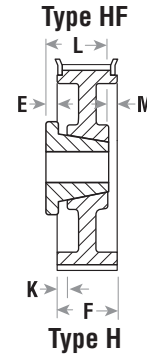
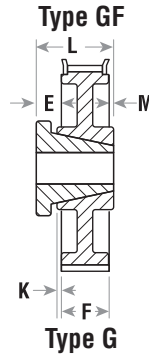
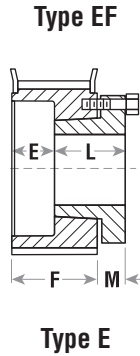
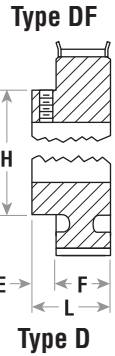
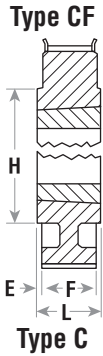

Type C

Type D

Type E

Type G

Type H

Type K

Dash 1 = Solid Style

Dash 2 = Web Style

Dash 3 = Arm/Spoke Style

L - 3/8" Pitch

L075 For Belts 3/4" Wide (3/8" Pitch)

QD Type

F = 1

No. Teeth	Part Number	Pitch Diameter	Max FL O.D.	Type	Bush	Bore Range		Dimensions				Wt. Less Bush
						Min.	Max.	E	K	L	M	
18	18L075JA	2.149	2.3906	EF-1*	JA	0.5	1.25	0.4375	—	1.0625	0.5	0.50
20	20L075JA	2.387	2.625	EF-1*	JA	0.5	1.25	0.4375	—	1.0625	0.5	0.70
22	22L075JA	2.626	2.875	EF-1*	JA	0.5	1.25	0.4375	—	1.0625	0.5	0.80
24	24L075SH	2.865	3.1094	EF-1*	SH	0.5	1.6875	0.1875	—	1.3125	0.5625	0.80
26	26L075SH	3.104	3.3438	EF-1*	SH	0.5	1.6875	0.1875	—	1.3125	0.5625	1.10
28	28L075SH	3.342	3.5781	EF-1*	SH	0.5	1.6875	0.1875	—	1.3125	0.5625	1.30
30	30L075SDS	3.581	3.8281	EF-1*	SDS	0.5	2	0.25	—	1.375	0.625	1.50
32	32L075SDS	3.82	4.0625	EF-1*	SDS	0.5	2	0.25	—	1.375	0.625	1.70
36	36L075SDS	4.297	4.5313	HF-1	SDS	0.5	2	0.375	0.25	1.375	0	2.30
40	40L075SDS	4.775	5.0156	HF-1	SDS	0.5	2	0.375	0.25	1.375	0	3.10
44	44L075SDS	5.252	5.4844	HF-1	SDS	0.5	2	0.375	0.25	1.375	0	4.00
48	48L075SDS	5.730	6.0156	HF-1	SDS	0.5	2	0.375	0.25	1.375	0	4.60
60	60L075SD	7.162	—	G-3	SD	0.5	2	0.6875	0.125	1.8125	0.125	4.70
72	72L075SD	8.594	—	G-3	SD	0.5	2	0.6875	0.125	1.8125	0.125	6.50
84	84L075SD	10.027	—	G-3	SD	0.5	2	0.6875	0.125	1.8125	0.125	6.30

Dimensions in inches. Weight in pounds
Pulley O.D. = P.D. - .03"
*Reverse mount only

L - 3/8" Pitch

L075 For Belts 3/4" Wide (3/8" Pitch)

Taper Bushed Type

F = 1

No. Teeth	Part Number	Pitch Diameter	Max FL O.D.	Type	Bush	Bore Range		Dimensions				Wt. Less Bush
						Min.	Max.	E	K	L	M	
18	TB18L075	2.149	2.3906	KF-1	1008	0.5	1	0.125	—	0.875	—	0.50
20	TB20L075	2.387	2.625	KF-1	1008	0.5	1	0.125	—	0.875	—	0.70
22	TB22L075	2.626	2.875	KF-1	1008	0.5	1	0.125	—	0.875	—	1.10
24	TB24L075	2.865	3.1094	KF-1	1210	0.5	1.25	—	—	1	—	0.90
26	TB26L075	3.104	3.3438	KF-1	1210	0.5	1.25	—	—	1	—	1.30
28	TB28L075	3.342	3.5781	KF-1	1610	0.5	1.625	—	—	1	—	1.30
30	TB30L075	3.581	3.8281	KF-1	1610	0.5	1.625	—	—	1	—	1.60
32	TB32L075	3.820	4.0625	KF-1	1610	0.5	1.625	—	—	1	—	1.80
40	TB40L075	4.775	5.0156	CF-1	2012	0.5	2	0.25	3.9375	1.25	—	3.60
48	TB48L075	5.730	6.0156	CF-1	2012	0.5	2	0.25	3.9375	1.25	—	5.40
60	TB60L075	7.162	—	C-1	2012	0.5	2	0.125	4.375	1.25	0.125	7.90

Dimensions in inches. Weight in pounds
Pulley O.D. = P.D. - .03"

Type CF

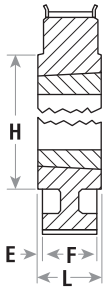

Type C

Type DF

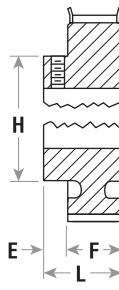

Type D

Type EF

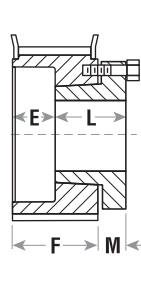

Type E

Type GF

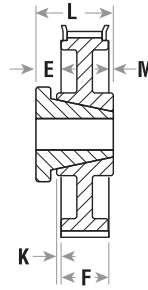

Type G

Type HF

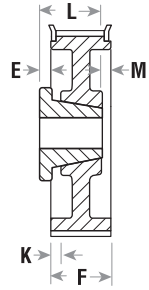

Type H

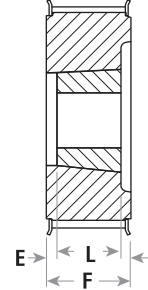

Type KF

Dash 1 = Solid Style

Dash 2 = Web Style

Dash 3 = Arm/Spoke Style

L - 3/8" Pitch

L100 For Belts 1" Wide (3/8" Pitch)

Minimum Plain Bore

F = 1-1/4

No. Teeth	Part Number	Pitch Diameter	Max FL O.D.	Type	Bore Range		Dimensions			Wt. Less Bush
					Min.	Max.	E	H	L	
14	14L100	1.671	1.9219	DF-1	0.375	0.875	0.500	1.1250	1.75	0.60
16	16L100	1.910	2.1563	DF-1	0.5	1.125	0.625	1.4375	1.875	0.80
17	17L100	2.029	2.2813	DF-1	0.5	1.125	0.625	1.5	1.875	1.00
18	18L100	2.149	2.3906	DF-1	0.5	1.1875	0.625	1.625	1.875	1.10
19	19L100	2.268	2.375	DF-1	0.5	1.1875	0.625	1.625	1.875	1.40
20	20L100	2.387	2.625	DF-1	0.5	1.1875	0.625	1.6875	1.875	1.75
21	21L100	2.507	2.75	DF-1	0.625	1.3125	0.6875	1.875	1.875	1.80
22	22L100	2.626	2.875	DF-1	0.625	1.5	0.75	2	2	2.00
24	24L100	2.865	3.1094	DF-1	0.625	1.625	0.75	2.25	2	2.50
26	26L100	3.104	3.3438	DF-1	0.625	1.625	0.875	2.5	2.125	3.30
28	28L100	3.342	3.5781	DF-1	0.625	1.875	1	2.75	2.25	3.60
30	30L100	3.581	3.8281	DF-1	0.625	1.875	1	2.875	2.25	4.00
32	32L100	3.820	4.0625	DF-1	0.625	1.875	1	3.0625	2.25	4.40

Dimensions in inches. Weight in pounds

Pulley O.D. = P.D. - .03"

L Pulleys 14 - 16 teeth min. plain bore stocked with 1-S.S. If keyway is used, reduce max. bore by twice keyway depth.

L - 3/8" Pitch

L100 For Belts 1" Wide (3/8" Pitch)

QD Type

F = 1-1/4

No. Teeth	Part Number	Pitch Diameter	Max FL O.D.	Type	Bush	Bore Range		Dimensions				Wt. Less Bush
						Min.	Max.	E	K	L	M	
18	18L100JA	2.149	2.3906	EF-1*	JA	0.5	1.25	0.6875	—	1.0625	0.5	0.70
20	20L100JA	2.387	2.625	EF-1*	JA	0.5	1.25	0.6875	—	1.0625	0.5	0.90
22	22L100JA	2.626	2.875	EF-1*	JA	0.5	1.25	0.6875	—	1.0625	0.5	1.00
24	24L100SH	2.865	3.1094	EF-1*	SH	0.5	1.6875	0.4375	—	1.3125	0.5625	1.00
26	26L100SH	3.104	3.3438	EF-1*	SH	0.5	1.6875	0.4375	—	1.3125	0.5625	1.30
28	28L100SH	3.342	3.5781	EF-1*	SH	0.5	1.6875	0.4375	—	1.3125	0.5625	1.70
30	30L100SDS	3.581	3.8281	EF-1*	SDS	0.5	2	0.5	—	1.375	0.625	2.00
32	32L100SDS	3.820	4.0625	EF-1*	SDS	0.5	2	0.5	—	1.375	0.625	2.10
36	36L100SDS	4.297	4.5313	HF-1	SDS	0.5	2	0.125	0.5	1.375	0	2.60
40	40L100SDS	4.775	5.0156	HF-1	SDS	0.5	2	0.125	0.5	1.375	0	3.40
44	44L100SDS	5.252	5.4844	HF-1	SDS	0.5	2	0.125	0.5	1.375	0	4.20
48	48L100SDS	5.730	6.0156	HF-1	SDS	0.5	2	0.125	0.5	1.375	0	5.10
60	60L100SD	7.162	—	G-3	SD	0.5	2	0.625	0	1.8125	0	6.00
72	72L100SD	8.594	—	G-3	SD	0.5	2	0.625	0	1.8125	0	8.00
84	84L100SD	10.027	—	G-3	SD	0.5	2	0.625	0	1.8125	0	9.20

Dimensions in inches. Weight in pounds

Pulley O.D. = P.D. - .03"

*Reverse mount only

L 3/8" Pitch

Stock Timing Pulleys



Type CF

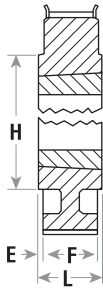

Type C

Type DF

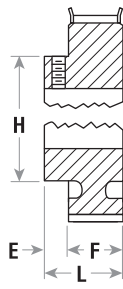

Type D

Type EF

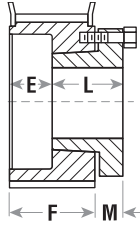

Type E

Type GF



Type G

Type HF

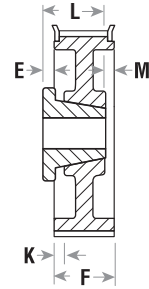

Type H

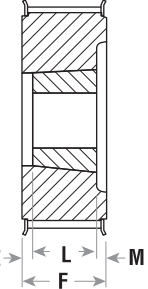

Type KF

Dash 1 = Solid Style

Dash 2 = Web Style
"F" type description indicates flanged.

Dash 3 = Arm/Spoke Style

L - 3/8" Pitch

L100 For Belts 1" Wide (3/8" Pitch)

Taper Bushed Type

F = 1-1/4

No. Teeth	Part Number	Pitch Diameter	Max FL O.D.	Type	Bush	Bore Range		Dimensions				Wt. Less Bush
						Min.	Max.	E	K	L	M	
18	TB18L100	2.149	2.3906	KF-1	1008	0.5	1	3/8	—	0.875	—	0.70
20	TB20L100	2.387	2.625	KF-1	1008	0.5	1	3/8	—	0.875	—	1.00
22	TB22L100	2.626	2.875	KF-1	1008	0.5	1	3/8	—	0.875	—	1.30
24	TB24L100	2.865	3.1094	KF-1	1210	0.5	1.25	1/4	—	1	—	1.30
26	TB26L100	3.104	3.3438	KF-1	1210	0.5	1.25	1/4	—	1	—	1.70
28	TB28L100	3.342	3.5781	KF-1	1610	0.5	1.625	1/4	—	1	—	1.70
30	TB30L100	3.581	3.8281	KF-1	1610	0.5	1.625	1/4	—	1	—	2.20
32	TB32L100	3.820	4.0625	KF-1	1610	0.5	1.625	1/4	—	1	—	2.70
40	TB40L100	4.775	5.0156	KF-1	2012	0.5	2	1/16	—	1.25	—	3.60
48	TB48L100	5.730	6.0156	KF-1	2012	0.5	2	1/16	—	1.25	—	5.10
60	TB60L100	7.162	—	C-2	2012	0.5	2	—	—	1.25	—	6.00

Dimensions in inches. Weight in pounds
Pulley O.D. = P.D. - .03"

Type DF

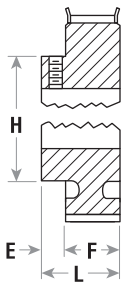

Type D

Type EF

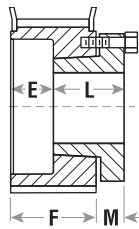

Type E

Type GF

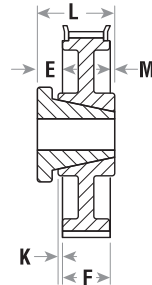

Type G

Type HF

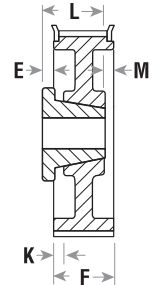

Type H

H - 1/2" Pitch

H100 For Belts 3/4" and 1" Wide (1/2" Pitch)

Minimum Plain Bore

F = 1-5/16

No. Teeth	Part Number	Pitch Diameter	Max FL O.D.	Type	Bore Range		Dimensions			Wt. Less Bush
					Min.	Max.	E	H	L	
14	14H100	2.228	2.4844	DF-1	0.625	1	0.625	1.5	1.9375	1.4
16	16H100	2.546	2.7969	DF-1	0.625	1.25	0.6875	2	2	2.0
18	18H100	2.865	3.1094	DF-1	0.625	1.5	0.6875	2.25	2	2.8
20	20H100	3.183	3.4375	DF-1	0.625	1.625	0.875	2.5	2.1875	3.4
21	21H100	3.342	3.5625	DF-1	0.75	1.6875	1	2.625	2.25	3.8
22	22H100	3.501	3.75	DF-1	0.75	1.875	1	2.875	2.3125	4.3
24	24H100	3.820	4.0156	DF-1	0.75	2.125	1	3.125	2.3125	5.3
26	26H100	4.138	4.3906	DF-1	0.75	2.5	1.125	3.5	2.4375	6.7
28	28H100	4.456	4.7031	DF-1	0.75	2.625	1.125	3.625	2.4375	8.0

Dimensions in inches. Weight in pounds
Pulley O.D. = P.D. - .054"

H - 1/2" Pitch

H100 For Belts 3/4" and 1" Wide (1/2" Pitch)

QD Type

F = 1-5/16

No. Teeth	Part Number	Pitch Diameter	Max FL O.D.	Type	Bush	Bore Range	Dimensions					Wt. Less Bush
							E	H	K	L	M	
14	14H100JA	2.228	2.4844	EF-1*	JA	1/2 - 1.25	0.75	—	—	1.0625	0.5	1.0
16	16H100JA	2.546	2.7969	EF-1*	JA	1/2 - 1.25	0.75	—	—	1.0625	0.5	1.5
18	18H100SH	2.865	3.1094	EF-1*	SH	1/2 - 1.6875	0.5625	—	—	1.3125	0.5625	1.2
20	20H100SH	3.183	3.4375	EF-1*	SH	1/2 - 1.6875	0.5625	—	—	1.3125	0.5625	1.2
22	22H100SDS	3.501	3.75	EF-1*	SDS	1/2 - 2	0.5625	—	—	1.375	0.625	1.4
24	24H100SDS	3.820	4.0156	EF-1*	SDS	1/2 - 2	0.5625	—	—	1.375	0.625	1.7
26	26H100SDS	4.138	4.3906	HF-1	SDS	1/2 - 2	0.0625	—	0.5625	1.375	—	2.0
28	28H100SDS	4.456	4.7031	HF-1	SDS	1/2 - 2	0.0625	—	0.5625	1.375	—	2.6
30	30H100SD	4.775	5.0156	GF-1	SD	1/2 - 2	0.6250	—	—	1.8125	—	3.0
32	32H100SK	5.093	5.3281	GF-1	SK	1/2 - 2.625	0.6875	—	—	1.9375	—	4.9
36	36H100SK	5.730	5.9531	GF-1	SK	1/2 - 2.625	0.6875	—	—	1.9375	—	5.6
40	40H100SK	6.366	6.5781	GF-1	SK	1/2 - 2.625	0.6875	—	—	1.9375	—	8.2
44	44H100SK	7.003	7.25	GF-1	SK	1/2 - 2.625	0.6875	—	—	1.9375	—	10.0
48	48H100SK	7.639	8.0156	GF-2	SK	1/2 - 2.625	0.6875	—	—	1.9375	—	12.5
60	60H100SF	9.549	—	H-2	SF	1/2 - 2.9375	0.6875	—	—	2.0625	—	10.9
72	72H100SF	11.459	—	H-3	SF	1/2 - 2.9375	0.6875	—	—	2.0625	—	14.0
84	84H100SF	13.369	—	H-2	SF	1/2 - 2.9375	0.6875	5.125	—	2.0625	—	20.0
96	96H100SF	15.279	—	H-3	SF	1/2 - 2.9375	0.6875	5.125	—	2.0625	—	27.0
120	120H100SF	19.099	—	H-3	SF	1/2 - 2.9375	0.6875	5.125	—	2.0625	—	38.0

Dimensions in inches. Weight in pounds
Pulley O.D. = P.D. - .054"

*Reverse mount only

H 1/2" Pitch

Stock Timing Pulleys



Type CF

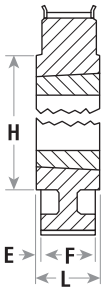

Type C

Type DF

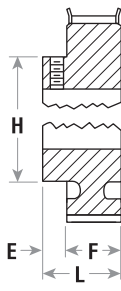

Type D

Type EF

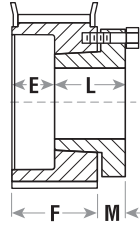

Type E

Type GF



Type G

Type HF

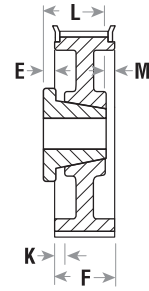

Type H

Dash 1 = Solid Style

Dash 2 = Web Style

Dash 3 = Arm/Spoke Style

"F" type description indicates flanged.

H - 1/2" Pitch

H100 For Belts 3/4" and 1" Wide (1/2" Pitch)

Taper Bushed Type

F = 1-5/16

No. Teeth	Part Number	Pitch Diameter	Max FL O.D.	Type	Bush	Bore Range	Dimensions				Wt. Less Bush
							E	H	L	M	
14	TB14H100	2.228	2.4844	KF-1	1008	0.5 - 1	0.4375	—	0.875	—	0.80
16	TB16H100	2.546	2.7969	KF-1	1008	0.5 - 1	0.4375	—	0.875	—	1.30
18	TB18H100	2.865	3.1094	KF-1	1210	0.5 - 1.25	0.3125	—	1	—	1.20
20	TB20H100	3.183	3.4375	KF-1	1210	0.5 - 1.25	0.3125	—	1	—	1.70
22	TB22H100	3.501	3.7500	KF-1	1610	0.5 - 1.625	0.3125	—	1	—	1.80
24	TB24H100	3.820	4.0156	KF-1	1610	0.5 - 1.625	0.3125	—	1	—	2.30
26	TB26H100	4.138	4.3906	KF-1	2012	0.5 - 2	0.0625	—	1.25	—	2.60
28	TB28H100	4.456	4.7031	KF-1	2012	0.5 - 2	0.0625	—	1.25	—	2.80
30	TB30H100	4.775	5.0156	KF-1	2012	0.5 - 2	0.0625	—	1.25	—	4.20
32	TB32H100	5.093	5.3281	CF-1	2517	0.5 - 2.5	0.4375	4.4375	3.25	—	4.30
40	TB40H100	6.366	6.5781	CF-1	2517	0.5 - 2.5	0.4375	4.4375	3.25	—	7.80
48	TB48H100	7.639	8.0156	CF-1	2517	0.5 - 2.5	0.4375	4.4375	3.25	—	12.10
60	TB60H100	9.549	—	C-2	3020	0.875 - 3	0.3438	6.25	2	0.3438	10.30

Dimensions in inches. Weight in pounds
Pulley O.D. = P.D. - .054"

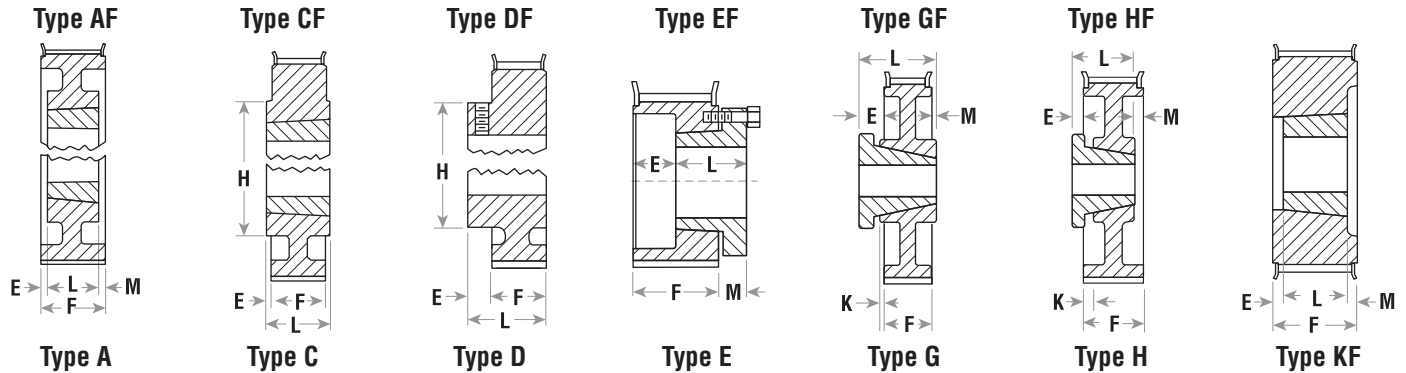

Dash 1 = Solid Style

Dash 2 = Web Style

Dash 3 = Arm/Spoke Style

"F" type description indicates flanged.

H - 1/2" Pitch

H150 For Belts 1-1/2" Wide (1/2" Pitch)

Minimum Plain Bore

F = 1-13/16

No. Teeth	Part Number	Pitch Diameter	Max FL O.D.	Type	Bore		Dimensions			Wt. Less Bush
					Min.	Max.	E	H	L	
14	14H150	2.228	2.4844	DF-1	0.75	1	0.625	1.5	2.4375	1.8
16	16H150	2.546	2.7969	DF-1	0.75	1.25	0.75	2	2.5625	2.5
18	18H150	2.865	3.1094	DF-1	0.75	1.5	0.75	2.25	2.5625	3.3
19	19H150	3.024	3.25	DF-1	0.75	1.5625	0.875	2.25	2.625	3.9
20	20H150	3.183	3.4375	DF-1	0.75	1.625	0.875	2.5	2.6875	4.3
21	21H150	3.342	3.5625	DF-1	0.75	1.6875	0.9375	2.5	2.75	5.3
22	22H150	3.501	3.75	DF-1	0.75	1.875	1	2.875	2.8125	5.4
24	24H150	3.820	4.0625	DF-1	0.75	2.125	1	3.125	2.8125	6.5
26	26H150	4.138	4.7813	DF-1	0.75	2.5	1	3.5	2.8125	8.4

Dimensions in inches. Weight in pounds
Pulley O.D. = P.D. - .054"

H 1/2" Pitch

Stock Timing Pulleys



Type AF

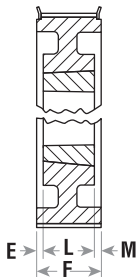

Type A

Dash 1 = Solid Style

Type CF

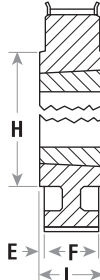

Type C

Dash 2 = Web Style

Type EF

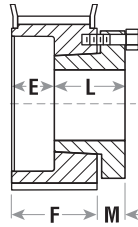

Type E

Dash 3 = Arm/Spoke Style

Type HF

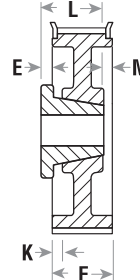

Type H

"F" type description indicates flanged.

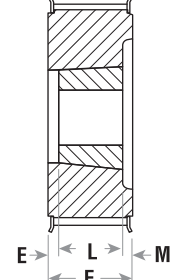

Type KF

H - 1/2" Pitch

H150 For Belts 1-1/2" Wide (1/2" Pitch)

QD Type

F = 1-13/16

No. Teeth	Part Number	Pitch Diameter	Max FL O.D.	Type	Bush	Bore Range	Dimensions				Wt. Less Bush
							E	K	L	M	
14	14H150JA	2.228	2.4844	EF-1*	JA	0.5 - 1.25	1.25	—	1.0625	0.5	1.5
16	16H150JA	2.546	2.7969	EF-1*	JA	0.5 - 1.25	1.25	—	1.0625	0.5	2.0
18	18H150SH	2.865	3.1094	EF-1*	SH	0.5 - 1.6875	1	—	1.3125	0.5625	1.3
20	20H150SH	3.183	3.4375	EF-1*	SH	0.5 - 1.6875	1	—	1.3125	0.5625	1.8
22	22H150SD	3.501	3.75	EF-1*	SD	0.5 - 2	0.5625	—	1.8125	0.625	2.0
24	24H150SD	3.820	4.0625	EF-1*	SD	0.5 - 2	0.5625	—	1.8125	0.625	2.6
26	26H150SD	4.138	4.7813	HF-1	SD	0.5 - 2	0.0625	0.5625	1.8125	0.0625	3.0
28	28H150SD	4.456	4.7031	HF-1	SD	0.5 - 2	0.0625	0.5625	1.8125	0.0625	4.0
30	30H150SD	4.775	5.0156	HF-1	SD	0.5 - 2	0.0625	0.5625	1.8125	0.0625	4.9
32	32H150SK	5.093	5.3281	HF-1	SK	0.5 - 2.625	0.125	0.5625	1.9375	—	5.8
36	36H150SK	5.730	5.9531	HF-1	SK	0.5 - 2.625	0.125	0.5625	1.9375	—	7.0
40	40H150SK	6.366	6.5781	HF-1	SK	0.5 - 2.625	0.125	0.5625	1.9375	—	9.2
44	44H150SK	7.003	7.25	HF-1	SK	0.5 - 2.625	0.125	0.5625	1.9375	—	11.0
48	48H150SK	7.639	8.0156	HF-2	SK	0.5 - 2.625	0.125	0.5625	1.9375	—	13.7
60	60H150SF	9.549	—	H-2	SF	0.5 - 2.9375	0.4063	0.2813	2.0625	0.2813	12.5
72	72H150SF	11.459	—	H-3	SF	0.5 - 2.9375	0.4063	0.2813	2.0625	0.2813	17.0
84	84H150SF	13.369	—	H-3	SF	0.5 - 2.9375	0.4063	0.2813	2.0625	0.2813	21.5
96	96H150SF	15.279	—	H-3	SF	0.5 - 2.9375	0.4063	0.2813	2.0625	0.2813	31.0
120	120H150SF	19.099	—	H-3	SF	0.5 - 2.9375	0.4063	0.2813	2.0625	0.2813	40.0

Dimensions in inches. Weight in pounds. Pulley O.D. = P.D. - .054"

*Reverse mount only

H - 1/2" Pitch

H150 For Belts 1-1/2" Wide (1/2" Pitch)

Taper Bushed Type

F = 1-13/16

No. Teeth	Part Number	Pitch Diameter	Max FL O.D.	Type	Bush	Bore Range	Dimensions					Wt. Less Bush
							E	H	K	L	M	
14	TB14H150	2.228	2.4844	KF-1	1008	0.5 - 1	0.4688	—	—	0.875	0.4688	1.0
16	TB16H150	2.546	2.7969	KF-1	1008	0.5 - 1	0.4688	—	—	0.875	0.4688	1.5
18	TB18H150	2.865	3.1094	KF-1	1215	0.5 - 1.25	0.3125	—	—	1.5	—	1.6
20	TB20H150	3.183	3.4375	KF-1	1215	0.5 - 1.25	0.3125	—	—	1.5	—	2.2
22	TB22H150	3.501	3.75	KF-1	1615	0.5 - 1.625	0.3125	—	—	1.5	—	2.5
24	TB24H150	3.820	4.0625	KF-1	2012	0.5 - 2	0.5625	—	—	1.25	—	2.7
26	TB26H150	4.138	4.7813	KF-1	2012	0.5 - 2	0.5625	—	—	1.25	—	3.2
28	TB28H150	4.456	4.7031	KF-1	2012	0.5 - 2	0.5625	—	—	1.25	—	4.1
30	TB30H150	4.775	5.0156	KF-1	2012	0.5 - 2	0.5625	—	—	1.25	—	5.1
32	TB32H150	5.093	5.3281	KF-1	2517	0.5 - 2.5	0.0625	—	—	1.75	—	5.6
40	TB40H150	6.366	6.5781	KF-1	2517	0.5 - 2.5	0.0625	—	—	1.75	—	8.6
48	TB48H150	7.639	8.0156	AF-1	2517	0.5 - 2.5	—	—	0.0625	1.75	0.0625	13.6
60	TB60H150	9.549	—	C-2	3020	0.88 - 3	0.0938	6.25	—	2	0.0938	12.3

Dimensions in inches. Weight in pounds. Pulley O.D. = P.D. - .054"

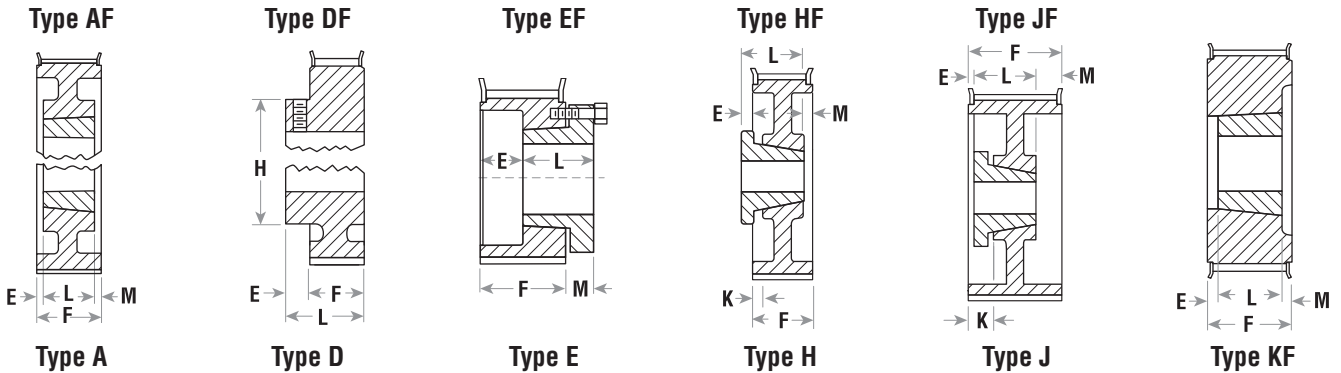

Dash 1 = Solid Style

Dash 2 = Web Style

Dash 3 = Arm/Spoke Style

"F" type description indicates flanged.

H - 1/2" Pitch

H200 For Belts 2" Wide (1/2" Pitch)

Minimum Plain Bore

F = 2-11/32

No. Teeth	Part Number	Pitch Diameter	Max FL O.D.	Type	Bush		Dimensions			Wt. Less Bush
					Stk.	Max.	E	H	L	
14	14H200	2.228	2.375	DF-1	0.75	1	0.625	1.5	2.9688	2.2
16	16H200	2.546	2.7969	DF-1	0.75	1.25	0.75	2	3.0938	3.1
18	18H200	2.865	3.1094	DF-1	0.75	1.5	0.75	2	3.0938	3.7
19	19H200	3.024	3.2500	DF-1	0.75	1.5625	0.875	2.25	3.2188	3.9
20	20H200	3.183	3.4375	DF-1	0.75	1.625	0.875	2.5	3.2188	4.9
22	22H200	3.501	3.75	DF-1	1	1.875	1	2.875	3.3438	6.3
24	24H200	3.820	4.0625	DF-1	1	2.125	1	3.125	3.3438	7.5
26	26H200	4.138	4.7813	DF-1	1	2.5	1.125	3.5	3.4688	9.5

Dimensions in inches. Weight in pounds. Pulley O.D. = P.D. - .054"

H 1/2" Pitch

Stock Timing Pulleys

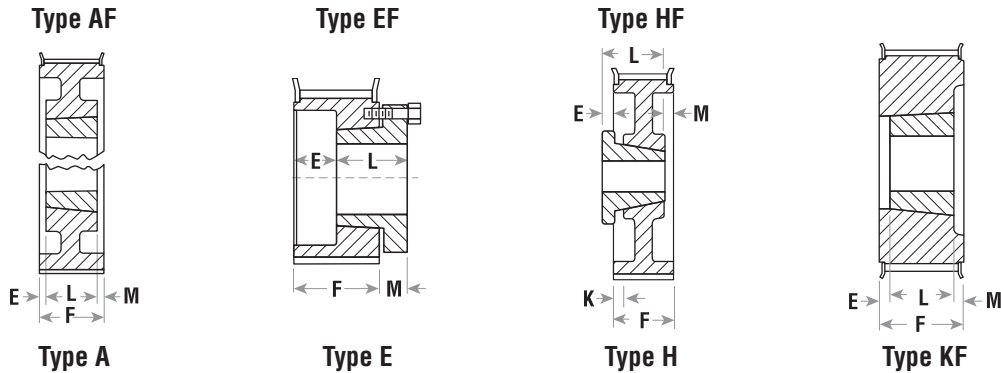

Dash 1 = Solid Style Dash 2 = Web Style Dash 3 = Arm/Spoke Style "F" type description indicates flanged.

H - 1/2" Pitch

H200 For Belts 2" Wide (1/2" Pitch)

QD Type

F = 2-11/16

No. Teeth	Part Number	Pitch Diameter	Max FL O.D.	Type	Bush	Bore Range	Dimensions				Wt. Less Bush
							E	K	L	M	
16	16H200JA	2.546	2.7969	EF-1*	JA	0.5 - 1.25	1.7813	—	1.0625	0.5	2.6
18	18H200SH	2.865	3.1094	EF-1*	SH	0.5 - 1.6875	1.5313	—	1.3125	0.5625	1.6
20	20H200SH	3.183	3.4375	EF-1*	SH	0.5 - 1.6875	1.5313	—	1.3125	0.5625	2.2
22	22H200SD	3.501	3.75	EF-1*	SD	0.5 - 2	1.0938	—	1.8125	0.6250	2.5
24	24H200SD	3.820	4.0625	EF-1*	SD	0.5 - 2	1.0938	—	1.8125	0.6250	3.0
26	26H200SD	4.138	4.7813	HF-1	SD	0.5 - 2	0.0781	0.5469	1.8125	0.5469	3.9
28	28H200SD	4.456	4.7031	HF-1	SD	0.5 - 2	0.0781	0.5469	1.8125	0.5469	4.7
30	30H200SD	4.775	5.0156	HF-1	SD	0.5 - 2	0.0781	0.5469	1.8125	0.5469	5.7
32	32H200SK	5.093	5.3281	HF-1	SK	0.5 - 2.625	0.1406	0.5469	1.9375	0.5469	6.7
36	36H200SK	5.730	5.9531	HF-1	SK	0.5 - 2.625	0.1406	0.5469	1.9375	0.5469	8.0
40	40H200SK	6.366	6.5781	HF-1	SK	0.5 - 2.625	0.1406	0.5469	1.9375	0.5469	10.2
44	44H200SK	7.003	7.25	HF-1	SK	0.5 - 2.625	0.1406	0.5469	1.9375	0.5469	12.5
48	48H200SF	7.639	8.0156	HF-2	SF	0.5 - 2.9375	0.1406	0.5469	2.0625	0.5469	14.1
60	60H200SF	9.549	—	H-2	SF	0.5 - 2.9375	0.1406	0.5469	2.0625	0.5469	14.6
72	72H200SF	11.459	—	H-2	SF	0.5 - 2.9375	0.1406	0.5469	2.0625	0.5469	21.0
84	84H200SF	13.369	—	H-3	SF	0.5 - 2.9375	0.1406	0.5469	2.3125	0.5469	23.0
96	96H200E	15.279	—	H-3	E	0.875 - 3.5	0.5156	0.3594	2.625	0.3594	34.0
120	120H200E	19.099	—	H-3	E	0.875 - 3.5	0.5156	0.3594	2.625	0.3594	42.0

Dimensions in inches. Weight in pounds. Pulley O.D. = P.D. - .054"

*Reverse mount only

H - 1/2" Pitch

H200 For Belts 1-1/2" Wide (1/2" Pitch)

Taper Bushed Type

F = 2-11/16

No. Teeth	Part Number	Pitch Diameter	Max FL O.D.	Type	Bush	Bore Range	Dimensions			Wt. Less Bush
							E	L	M	
16	TB16H200	2.546	2.7969	KF-1	1008	1/2 - 1	0.75	0.875	0.7188	1.9
18	TB18H200	2.865	3.1094	KF-1	1215	1/2 - 1.25	0.4375	1.5	0.4063	1.8
20	TB20H200	3.183	3.4375	KF-1	1215	1/2 - 1.25	0.4219	1.5	0.4219	2.6
22	TB22H200	3.501	3.75	KF-1	1615	1/2 - 1.625	0.4219	1.5	0.4219	2.8
24	TB24H200	3.820	4.0625	KF-1	2012	1/2 - 2	0.5469	1.25	0.5469	2.8
26	TB26H200	4.138	4.7813	KF-1	2012	1/2 - 2	0.5469	1.25	0.5469	3.6
28	TB28H200	4.456	4.7031	KF-1	2012	1/2 - 2	0.5469	1.25	0.5469	5.1
30	TB30H200	4.775	5.0156	KF-1	2012	1/2 - 2	0.4063	1.25	—	7.0
32	TB32H200	5.093	5.3281	KF-1	2517	1/2 - 2.5	0.5938	1.75	—	8.5
40	TB40H200	6.366	6.5781	KF-1	2517	1/2 - 2.5	0.5938	1.75	—	9.9
48	TB48H200	7.639	8.0156	KF-1	3020	7/8 - 3	0.3438	2	—	14.3
60	TB60H200	9.549	—	A-2	3020	7/8 - 3	0.1719	2	0.1719	15.3

Dimensions in inches. Weight in pounds. Pulley O.D. = P.D. - .054"

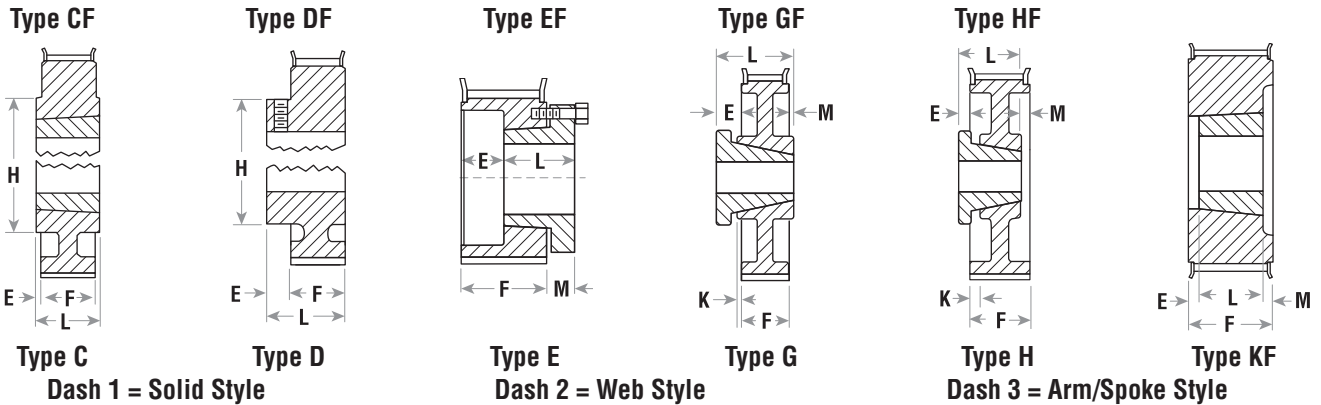

H - 1/2" Pitch

H300 For Belts 3" Wide (1/2" Pitch)

Minimum Plain bore

F = 3-3/8

No. Teeth	Part Number	Pitch Diameter	Max FL O.D.	Type	Bore		Dimensions			Wt. Less Bush
					Stk.	Max.	E	H	L	
16	16H300	2.546	2.80	DF-1	0.75	1.25	0.75	2	4.125	4.2

Dimensions in inches. Weight in pounds. Pulley O.D. = P.D. - .054"

H - 1/2" Pitch

H300 For Belts 3" Wide (1/2" Pitch)

QD Type

F = 3-3/8

No. Teeth	Part Number	Pitch Diameter	Max FL O.D.	Type	Bush	Bore Range	Dimensions				Wt. Less Bush
							E	K	L	M	
22	22H300SD	3.501	3.75	EF-1*	SD	0.5 - 2	2.125	—	1.8125	0.625	4.1
24	24H300SD	3.820	4.0625	EF-1*	SD	0.5 - 2	2.125	—	1.8125	0.625	4.1
26	26H300SD	4.138	4.3906	JF-1	SD	0.5 - 2	0.4375	1.0625	1.8125	1.0625	5.0
28	28H300SD	4.456	4.7031	JF-1	SD	0.5 - 2	0.4375	1.0625	1.8125	1.0625	6.0
30	30H300SD	4.775	5.0156	JF-1	SD	0.5 - 2	0.4375	1.0625	1.8125	1.0625	7.2
32	32H300SK	5.093	5.3281	JF-1	SK	0.5 - 2.625	0.375	1.0625	1.9375	1.0625	8.4
36	36H300SK	5.730	5.9531	JF-1	SK	0.5 - 2.625	0.375	1.0625	1.9375	1.0625	10.0
40	40H300SK	6.366	6.5781	JF-1	SK	0.5 - 2.625	0.375	1.0625	1.9375	1.0625	12.2
44	44H300SK	7.003	7.25	JF-1	SK	0.5 - 2.625	0.375	1.0625	1.9375	1.0625	15.5
48	48H300SF	7.639	8.0156	JF-2	SF	0.5 - 2.9375	0.375	1.0625	2.0625	1.0625	16.6
60	60H300SF	9.549	—	J-2	SF	0.5 - 2.9375	0.375	1.0625	2.0625	1.0625	17.9
72	72H300SF	11.459	—	J-2	SF	0.5 - 2.9375	0.1875	1.0625	2.0625	1.0625	23.0
84	84H300SF	13.369	—	J-2	SF	0.5 - 2.9375	0.1875	1.0625	2.0625	1.0625	30.0
96	96H300E	15.2790	—	H-3	E	0.875 - 3.5	-	0.875	2.625	0.875	38.0
120	120H300E	19.099	—	H-3	E	0.875 - 3.5	-	0.875	2.625	0.875	51.0

Dimensions in inches. Weight in pounds. Pulley O.D. = P.D. - .054"

*Reverse mount only

H - 1/2" Pitch

H300 For Belts 3" Wide (1/2" Pitch)

Taper Bushed Type

F = 3-3/8

No. Teeth	Part Number	Pitch Diameter	Max FL O.D.	Type	Bush	Bore Range	Dimensions			Wt. Less Bush
							E	L	M	
18	TB18H300	2.865	3.1094	KF-1	1215	0.5 - 1.25	0.9375	1.5	0.9375	2.6
20	TB20H300	3.183	3.4375	KF-1	1215	0.5 - 1.25	0.9375	1.5	0.9375	3.9
22	TB22H300	3.501	3.75	KF-1	1615	0.5 - 1.625	0.9375	1.5	0.9375	4.0
24	TB24H300	3.820	4.0625	KF-1	2012	0.5 - 2	1.0625	1.25	1.0625	4.3
26	TB26H300	4.138	4.3906	KF-1	2012	0.5 - 2	1.0625	1.25	1.0625	5.4
28	TB28H300	4.456	4.7031	KF-1	2012	0.5 - 2	1.0625	1.25	1.0625	6.8
30	TB30H300	4.775	5.0156	KF-1	2012	0.5 - 2	1.0625	1.25	1.0625	7.5
32	TB32H300	5.093	5.3281	KF-1	2517	0.5 - 2.5	0.8125	1.75	0.8125	7.4
40	TB40H300	6.366	6.5781	KF-1	2517	0.5 - 2.5	0.8125	1.75	0.8125	12.1
48	TB48H300	7.639	8.0156	KF-1	3020	0.875 - 3	0.6875	2	0.6875	16.3
60	TB60H300	9.549	—	A-2	3020	0.875 - 3	0.5625	2	0.5625	17.3

Dimensions in inches. Weight in pounds. Pulley O.D. = P.D. - .054"

*Reverse mount only

XH

7/8" Pitch

Stock Timing Pulleys

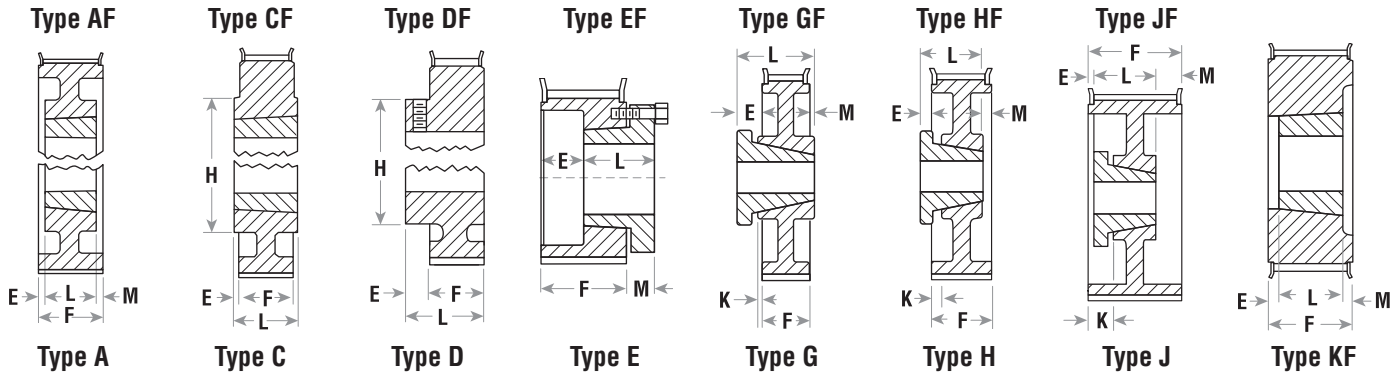

Dash 1 = Solid Style Dash 2 = Web Style Dash 3 = Arm/Spoke Style "F" type description indicates flanged.

XH - 7/8" Pitch

XH200 For Belts 2" Wide (7/8" Pitch)

Minimum Plain Bore

F = 2-9/16

No. Teeth	Part Number	Pitch Diameter	Max FL O.D.	Type	Bore		Dimensions			Wt. Less Bush
					Stk.	Max.	E	H	L	
18	18XH200	5.013	5.5781	DF-1	1	2.625	0.875	3.6875	3.4375	12.0
20	20XH200	5.570	6.1094	DF-1	1	3.25	1	4.125	3.5625	16.0

Dimensions in inches. Weight in pounds. Pulley O.D. = P.D. - .11"

XH - 7/8" Pitch

XH200 For Belts 2" Wide (7/8" Pitch)

Taper Bushed Type

F = 2-9/16

No. Teeth	Part Number	Pitch Diameter	Max FL O.D.	Type	Bush	Bore Range	Dimensions				Wt. Less Bush
							E	H	L	M	
22	TB22XH200	6.127	6.5938	KF-1	2517	0.5 - 2.5	0.8125	—	1.75	—	10.6
24	TB24XH200	6.685	7.2813	KF-1	3020	0.875 - 3	0.5625	—	2	—	11.3
26	TB26XH200	7.241	7.7813	KF-1	3020	0.875 - 3	0.5625	—	2	—	13.3
28	TB28XH200	7.799	8.2656	CF-1	3535	1.1875 - 3.5	0.9375	6.5	3.5	—	13.5
30	TB30XH200	8.356	9.0313	CF-1	3535	1.1875 - 3.5	0.9375	6.5	3.5	—	18.5
32	TB32XH200	8.913	9.5156	CF-1	3535	1.1875 - 3.5	0.9375	6.5	3.5	—	21.5
40	TB40XH200	11.141	11.7969	CF-1	4040	1.4375 - 4	1.4375	8.5	4	—	37.5
48	TB48XH200	13.369	—	C-2	4040	1.4375 - 4	0.4063	8.5	4	0.7188	44.5
60	TB60XH200	16.711	—	C-3	4040	1.4375 - 4	0.7188	8.5	4	0.7188	47.0

Dimensions in inches. Weight in pounds. Pulley O.D. = P.D. - .11"

Type CF

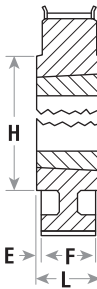

Type C

Type DF

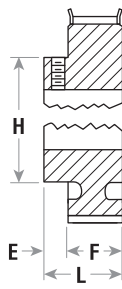

Type D

Type EF

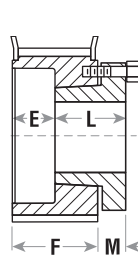

Type E

Type JF

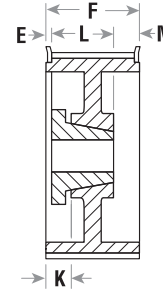

Type J

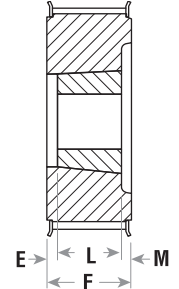

Type KF

XH - 7/8" Pitch

XH300 For Belts 3" Wide (7/8" Pitch)

Minimum Plain Bore

F = 3-5/8

No. Teeth	Part Number	Pitch Diameter	Max FL O.D.	Type	Bore		Dimensions				Wt. Less Bush
					Stk.	Max.	E	H	L	M	
18	18XH300	5.013	5.5781	DF-1	1	2.625	0.875	3.6875	4.5	1*	15.0
20	20XH300	5.570	6.1094	DF-1	1	3.25	1	4.125	4.625	0.75*	19.0

*Counterbore "M" depth on flush side.

XH - 7/8" Pitch

XH300 For Belts 3" Wide (7/8" Pitch)

Taper Bushed Type

F = 3-5/8

No. Teeth	Part Number	Pitch Diameter	Max FL O.D.	Type	Bush	Bore Range	Dimensions				Wt. Less Bush
							E	H	L	M	
22	TB22XH300	6.127	6.6563	KF-1	2517	0.5 - 2.5	0.9375	—	1.75	0.9375	13.6
24	TB24XH300	6.685	7.2813	KF-1	3020	0.875 - 3	0.8125	—	2	0.8125	15.3
26	TB26XH300	7.241	7.7813	KF-1	3020	0.875 - 3	0.8125	—	2	0.8125	17.3
28	TB28XH300	7.799	8.2656	KF-1	3535	1.1875 - 3.5	0.125	—	3.5	—	17.5
30	TB30XH300	8.356	9.0313	KF-1	3535	1.1875 - 3.5	0.125	—	3.5	—	22.5
32	TB32XH300	8.913	9.5156	KF-1	3535	1.1875 - 3.5	0.125	—	3.5	—	26.5
40	TB40XH300	11.141	11.7969	CF-1	4040	1.4375 - 4	0.375	7.75	4	—	43.5
48	TB48XH300	13.369	—	C-2	4040	1.4375 - 4	0.1875	8.5	4	0.1875	51.5
60	TB60XH300	16.711	—	C-3	4040	1.4375 - 4	0.1875	8.5	4	0.1875	55.5

XH - 1/2" Pitch

XH400 For Belts 4" Wide (7/8" Pitch)

QD Type

F = 4-11/16

No. Teeth	Part Number	Pitch Diameter	Max FL O.D.	Type	Bush	Bore Range	Dimensions				Wt. Less Bush
							E	K	L	M	
20	20XH400SK	5.570	6.0938	JF-1	SK	0.5 - 2.5	0.5	1.1875	1.9375	2.25	12.4
22	22XH400SK	6.127	6.6563	JF-1	SK	0.5 - 2.5	0.5	1.1875	1.9375	2.25	16.7
24	24XH400SF	6.685	7.2188	JF-1	SF	0.5 - 2.875	0.5	1.1875	2.0625	2.1875	19.2
26	26XH400SF	7.242	7.7813	JF-1	SF	0.5 - 2.875	0.5	1.1875	2.0625	2.1875	23.0
28	28XH400E	7.799	8.3438	JF-1	E	0.875 - 3.5	0.6563	1.5313	2.625	1.4063	24.0
30	30XH400E	8.356	8.9063	JF-1	E	0.875 - 3.5	0.6563	1.5313	2.625	1.4063	30.7
32	32XH400E	8.913	9.4375	JF-1	E	0.875 - 3.5	0.6563	1.5313	2.625	1.4063	34.0
40	40XH400F	11.141	11.6875	HF-2	F	1 - 3.9375	0.0938	1.0938	3.625	1.0313	49.0
48	48XH400J	13.369	—	H-3	J	1.4375 - 4.5	0.1875	1	4.5	0.875	67.3
60	60XH400J	16.711	—	H-3	J	1.4375 - 4.5	0.4375	0.75	4.5	0.625	85.0
72	72XH400J	20.054	—	H-3	J	1.4375 - 4.5	0.4375	0.75	4.5	0.625	108.0
84	84XH400J	23.396	—	H-3	J	1.4375 - 4.5	0.4375	0.75	4.5	0.625	119.0
96	96XH400J	26.738	—	H-3	J	1.4375 - 4.5	0.4375	0.75	4.5	0.625	187.5
120	120XH400J	33.423	—	H-3	J	1.4375 - 4.5	0.4375	0.75	4.5	0.625	187.5

Dimensions in inches. Weight in pounds. Pulley O.D. = P.D. - .11"

Timing Pulley Diameters



XL - 1/5" Pitch

No. Teeth	Diameter		No. Teeth	Diameter		No. Teeth	Diameter		No. Teeth	Diameter		No. Teeth	Diameter	
	P.D.	O.D.		P.D.	O.D.		P.D.	O.D.		P.D.	O.D.		P.D.	O.D.
10XL	0.637	0.617	33XL	2.101	2.081	55XL	3.501	3.481	77XL	4.902	4.882	99XL	6.303	6.283
11XL	0.700	0.680	34XL	2.165	2.145	56XL	3.565	3.545	78XL	4.966	4.946	100XL	6.346	6.326
12XL	0.764	0.744	35XL	2.228	2.208	57XL	3.629	3.609	79XL	5.029	5.009	101XL	6.430	6.410
13XL	0.828	0.808	36XL	2.292	2.272	58XL	3.692	3.672	80XL	5.093	5.073	102XL	6.494	6.474
14XL	0.891	0.871	37XL	2.355	2.335	59XL	3.756	3.736	81XL	5.157	5.137	103XL	6.557	6.537
15XL	0.955	0.935	38XL	2.419	2.399	60XL	3.820	3.800	82XL	5.220	5.200	104XL	6.621	6.601
16XL	1.019	0.999	39XL	2.483	2.463	61XL	3.883	3.863	83XL	5.284	5.264	105XL	6.685	6.665
17XL	1.082	1.062	40XL	2.546	2.526	62XL	3.947	3.927	84XL	5.348	5.328	106XL	6.748	6.728
18XL	1.146	1.126	41XL	2.610	2.590	63XL	4.011	3.991	85XL	5.411	5.391	107XL	6.812	6.792
19XL	1.210	1.190	42XL	2.674	2.654	64XL	4.074	4.054	86XL	5.475	5.455	108XL	6.875	6.855
20XL	1.273	1.253	43XL	2.737	2.717	65XL	4.138	4.118	87XL	5.539	5.519	109XL	6.939	6.919
21XL	1.337	1.317	44XL	2.801	2.781	66XL	4.202	4.182	88XL	5.602	5.582	110XL	7.003	6.983
22XL	1.401	1.381	45XL	2.865	2.845	67XL	4.265	4.245	89XL	5.666	5.646	111XL	7.066	7.046
23XL	1.464	1.444	46XL	2.928	2.908	68XL	4.329	4.309	90XL	5.730	5.710	112XL	7.130	7.110
24XL	1.528	1.508	47XL	2.992	2.972	69XL	4.393	4.373	91XL	5.793	5.773	113XL	7.194	7.174
25XL	1.592	1.572	48XL	3.056	3.036	70XL	4.456	4.436	92XL	5.857	5.837	114XL	7.257	7.237
26XL	1.655	1.635	49XL	3.119	3.099	71XL	4.520	4.500	93XL	5.921	5.901	115XL	7.321	7.301
27XL	1.719	1.699	50XL	3.183	3.163	72XL	4.584	4.564	94XL	5.984	5.964	116XL	7.385	7.365
28XL	1.783	1.763	51XL	3.247	3.227	73XL	4.647	4.627	95XL	6.048	6.028	117XL	7.448	7.428
29XL	1.846	1.826	52XL	3.310	3.290	74XL	4.711	4.691	96XL	6.112	6.092	118XL	7.512	7.492
30XL	1.910	1.890	53XL	3.374	3.354	75XL	4.775	4.755	97XL	6.175	6.155	119XL	7.576	7.556
31XL	1.974	1.954	54XL	3.438	3.418	76XL	4.838	4.818	98XL	6.239	6.219	120XL	7.639	7.619
32XL	2.037	2.017												

L - 3/8" Pitch

No. Teeth	Diameter		No. Teeth	Diameter		No. Teeth	Diameter		No. Teeth	Diameter		No. Teeth	Diameter	
	P.D.	O.D.		P.D.	O.D.		P.D.	O.D.		P.D.	O.D.		P.D.	O.D.
10L	1.194	1.164	33L	3.939	3.909	56L	6.685	6.655	79L	9.430	9.400	102L	12.175	12.145
11L	1.313	1.283	34L	4.058	4.028	57L	6.804	6.774	80L	9.549	9.519	103L	12.295	12.265
12L	1.432	1.402	35L	4.178	4.148	58L	6.923	6.893	81L	9.669	9.639	104L	12.414	12.384
13L	1.552	1.522	36L	4.297	4.267	59L	7.043	7.013	82L	9.788	9.758	105L	12.533	12.503
14L	1.671	1.641	37L	4.417	4.387	60L	7.162	7.132	83L	9.907	9.877	106L	12.653	12.623
15L	1.790	1.760	38L	4.536	4.506	61L	7.281	7.251	84L	10.027	9.997	107L	12.772	12.742
16L	1.910	1.880	39L	4.655	4.625	62L	7.401	7.371	85L	10.147	10.117	108L	12.892	12.862
17L	2.029	1.999	40L	4.775	4.745	63L	7.520	7.490	86L	10.266	10.236	109L	13.011	12.981
18L	2.149	2.119	41L	4.894	4.864	64L	7.639	7.609	87L	10.385	10.355	110L	13.130	13.100
19L	2.268	2.238	42L	5.013	4.983	65L	7.759	7.729	88L	10.504	10.474	111L	13.250	13.220
20L	2.387	2.357	43L	5.133	5.103	66L	7.878	7.848	89L	10.624	10.594	112L	13.369	13.339
21L	2.507	2.477	44L	5.252	5.222	67L	7.998	7.968	90L	10.743	10.713	113L	13.488	13.458
22L	2.626	2.596	45L	5.371	5.341	68L	8.117	8.087	91L	10.862	10.832	114L	13.608	13.578
23L	2.745	2.715	46L	5.491	5.461	69L	8.236	8.206	92L	10.982	10.952	115L	13.727	13.697
24L	2.865	2.835	47L	5.610	5.580	70L	8.356	8.326	93L	11.101	11.071	116L	13.846	13.816
25L	2.984	2.954	48L	5.730	5.700	71L	8.475	8.445	94L	11.220	11.190	117L	13.966	13.936
26L	3.104	3.074	49L	5.849	5.819	72L	8.594	8.564	95L	11.340	11.310	118L	14.085	14.055
27L	3.223	3.193	50L	5.968	5.938	73L	8.714	8.684	96L	11.459	11.429	119L	14.205	14.175
28L	3.342	3.312	51L	6.088	6.058	74L	8.833	8.803	97L	11.579	11.549	120L	14.324	14.294
29L	3.462	3.432	52L	6.207	6.177	75L	8.952	8.922	98L	11.698	11.668	130L	15.518	15.488
30L	3.581	3.551	53L	6.326	6.296	76L	9.072	9.042	99L	11.817	11.787	140L	16.711	16.681
31L	3.700	3.670	54L	6.446	6.416	77L	9.191	9.161	100L	11.937	11.907	150L	17.905	17.875
32L	3.820	3.790	55L	6.565	6.535	78L	9.311	9.281	101L	12.056	12.026			



Timing Pulley Diameters

H - 1/2" Pitch

No. Teeth	Diameter		No. Teeth	Diameter		No. Teeth	Diameter		No. Teeth	Diameter		No. Teeth	Diameter	
	P.D.	O.D.		P.D.	O.D.		P.D.	O.D.		P.D.	O.D.		P.D.	O.D.
15H	2.387	2.333	35H	5.570	5.516	55H	8.754	8.700	75H	11.937	11.883	95H	15.120	15.066
16H	2.546	2.492	36H	5.730	5.676	56H	8.913	8.859	76H	12.096	12.042	96H	15.225	15.171
17H	2.706	2.652	37H	5.889	5.835	57H	9.072	9.018	77H	12.255	12.201	97H	15.438	15.384
18H	2.865	2.811	38H	6.048	5.994	58H	9.231	9.177	78H	12.414	12.360	98H	15.597	15.543
19H	3.024	2.970	39H	6.207	6.153	59H	9.390	9.336	79H	12.573	12.519	99H	15.756	15.702
20H	3.183	3.129	40H	6.366	6.312	60H	9.549	9.495	80H	12.732	12.678	100H	15.915	15.861
21H	3.342	3.288	41H	6.525	6.471	61H	9.708	9.654	81H	12.892	12.848	102H	16.234	16.180
22H	3.501	3.447	42H	6.685	6.631	62H	9.868	9.814	82H	13.051	12.997	104H	16.552	16.498
23H	3.661	3.607	43H	6.844	6.790	63H	10.027	9.973	83H	13.210	13.156	106H	16.870	16.816
24H	3.820	3.766	44H	7.003	6.949	64H	10.186	10.132	84H	13.369	13.315	108H	17.189	17.135
25H	3.979	3.925	45H	7.162	7.108	65H	10.345	10.291	85H	13.528	13.474	110H	17.507	17.453
26H	4.138	4.084	46H	7.321	7.267	66H	10.504	10.450	86H	13.687	13.633	115H	18.303	18.249
27H	4.297	4.243	47H	7.480	7.426	67H	10.663	10.609	87H	13.846	13.792	120H	19.099	19.045
28H	4.456	4.402	48H	7.639	7.585	68H	10.823	10.769	88H	14.005	13.952	125H	19.894	19.840
29H	4.615	4.561	49H	7.799	7.745	69H	10.982	10.928	89H	14.165	14.111	130H	20.690	20.636
30H	4.775	4.721	50H	7.958	7.904	70H	11.141	11.087	90H	14.324	14.270	135H	21.486	21.432
31H	4.934	4.880	51H	8.117	8.063	71H	11.300	11.246	91H	14.483	14.429	140H	22.282	22.228
32H	5.093	5.039	52H	8.276	8.222	72H	11.459	11.405	92H	14.642	14.588	145H	23.077	23.023
33H	5.252	5.198	53H	8.435	8.381	73H	11.618	11.564	93H	14.801	14.747	150H	23.873	23.819
34H	5.411	5.357	54H	8.594	8.540	74H	11.777	11.723	94H	14.961	14.907	156H	24.828	24.774

XH - 7/8" Pitch

No. Teeth	Diameter		No. Teeth	Diameter		No. Teeth	Diameter		No. Teeth	Diameter		No. Teeth	Diameter	
	P.D.	O.D.		P.D.	O.D.		P.D.	O.D.		P.D.	O.D.		P.D.	O.D.
18XH	5.013	4.903	45XH	12.533	12.423	70XH	19.496	19.386	95XH	26.460	26.350	120XH	33.423	33.313
20XH	5.570	5.460	46XH	12.812	12.702	71XH	19.776	19.666	96XH	26.738	26.628	122XH	33.980	33.870
22XH	6.127	6.017	47XH	13.091	12.981	72XH	20.054	19.944	97XH	27.017	26.907	124XH	34.537	34.427
23XH	6.406	6.296	48XH	13.369	13.259	73XH	20.332	20.222	98XH	27.295	27.185	126XH	35.094	34.984
24XH	6.685	6.575	49XH	13.648	13.538	74XH	20.611	20.501	99XH	27.574	27.464	128XH	35.651	35.541
25XH	6.963	6.853	50XH	13.926	13.816	75XH	20.889	20.779	100XH	27.852	27.742	130XH	36.208	36.098
26XH	7.242	7.132	51XH	14.205	14.095	76XH	21.168	21.058	101XH	28.131	28.021	132XH	36.765	36.655
27XH	7.520	7.410	52XH	14.483	14.373	77XH	21.446	21.336	102XH	28.409	28.299	134XH	37.322	37.212
28XH	7.799	7.689	53XH	14.762	14.652	78XH	21.725	21.615	103XH	28.688	28.578	136XH	37.879	37.769
29XH	8.077	7.967	54XH	15.140	14.930	79XH	21.003	21.893	104XH	28.966	28.856	138XH	38.436	38.326
30XH	8.356	8.246	55XH	15.319	15.209	80XH	22.282	22.172	105XH	29.245	29.135	140XH	38.993	38.883
31XH	8.634	8.524	56XH	15.597	15.487	81XH	22.560	22.450	106XH	29.523	29.413	142XH	39.550	39.440
32XH	8.913	8.803	57XH	15.876	15.766	82XH	22.839	22.729	107XH	29.802	29.682	144XH	40.107	39.997
33XH	9.191	9.081	58XH	16.154	16.044	83XH	23.118	23.008	108XH	30.080	29.970	146XH	40.664	40.554
34XH	9.470	9.360	59XH	16.433	16.323	84XH	23.396	23.286	109XH	30.359	30.249	150XH	41.778	41.668
35XH	9.748	9.638	60XH	16.711	16.601	85XH	23.674	23.564	110XH	30.637	30.527			
36XH	10.027	9.917	61XH	16.990	16.880	86XH	23.953	23.843	111XH	30.916	30.806			
37XH	10.305	10.195	62XH	17.268	17.158	87XH	24.231	24.121	112XH	31.194	31.084			
38XH	10.584	10.474	63XH	17.547	17.437	88XH	24.510	24.400	113XH	31.473	31.363			
39XH	10.862	10.752	64XH	17.825	17.715	89XH	24.788	24.678	114XH	31.751	31.641			
40XH	11.141	11.031	65XH	18.104	17.994	90XH	25.067	24.957	115XH	32.030	31.920			
41XH	11.419	11.309	66XH	18.382	18.272	91XH	25.345	25.235	116XH	32.308	32.198			
42XH	11.698	11.588	67XH	18.661	18.551	92XH	25.624	25.514	117XH	32.587	32.477			
43XH	11.976	11.866	68XH	18.939	18.829	93XH	25.902	25.792	118XH	32.865	32.755			
44XH	12.255	12.145	69XH	19.218	19.108	94XH	26.181	26.071	119XH	33.145	33.035			

Outside Diameter Tolerances

Pulley Dia.	O.D. Tolerance	Pulley Dia.	O.D. Tolerance	Pulley Dia.	O.D. Tolerance	Pulley Dia.	O.D. Tolerance
0 - 1"	+0.02 -	2.001" - 4"	+0.04 -	7.001" - 12"	+0.06 -	20.001 UP	+0.08 -
1" - 2"	+0.03 -	4.001" - 7"	+0.05 -	12.001" - 20"	+0.07 -		