



# Straumann® Dental Implant System Basic Information



# Contents

<b>1. The Straumann® Dental Implant System</b>	<b>3</b>
1.1 Overview	3
1.2 Implant lines	4
1.3 Implant-abutment connections	6
1.4 Material	8
1.5 Surface	8
1.6 Transfer piece	8
<b>2. Indications and Contraindications</b>	<b>9</b>
2.1 List of abbreviations	9
2.2 Implant types and bone dimensions	10
<b>3. Preoperative Planning</b>	<b>12</b>
3.1 Implant position	12
3.2 Planning aids	19
<b>4. Surgical Procedures</b>	<b>24</b>
4.1 Implant bed preparation	24
4.2 Opening the implant package	36
4.3 Placing the implant	38
4.4 Soft tissue management	42
<b>5. Healing Phase</b>	<b>45</b>
5.1 Healing phase duration	45
<b>6. Additional Information on Instruments</b>	<b>46</b>
6.1 Surgical instruments	46
6.2 Osteotomes	52
6.3 Cleaning and care of instruments	54
<b>7. Appendix</b>	<b>55</b>
7.1 Related documentation	55
7.2 Important guidelines	56

# About this guide

This Basic Information for the Straumann® Dental Implant System provides dental practitioners and related specialists with the essential steps regarding surgical treatment, planning, and procedure.

The manual is divided into the following main parts:

- The Straumann® Dental Implant System
- Indications and Contraindications
- Preoperative Planning
- Surgical Procedures
- Healing Phase
- Additional Information on Instruments
- Appendix

For information on the Straumann® Bone Level Tapered Implant, please refer to the brochure *Straumann® Bone Level Tapered Implant, Basic Information (702167/en)*.

Information on the Straumann® Guided Implants and the Straumann® Guided Surgery System can be found in the brochure *Straumann® Guided Surgery, Basic Information (702083/en)*.

For further information regarding surgical treatment procedures, please refer to the following treatment guides or similar scientific publications:

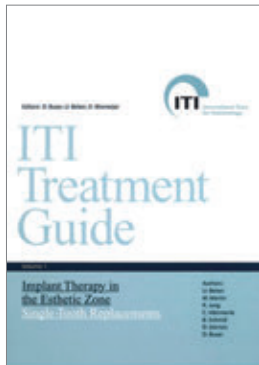

## ITI Treatment Guides

- Volume 1: Implant Therapy in the Esthetic Zone – Single-Tooth Replacements
- Volume 2: Loading Protocols in Implant Dentistry – Partially Dentate Patients
- Volume 3: Implant Placement in Post-Extraction Sites – Treatment Options
- Volume 4: Loading Protocols in Implant Dentistry – Edentulous Patients
- Volume 5: Sinus Floor Elevation Procedures
- Volume 6: Extended Edentulous Spaces in the Esthetic Zone
- Volume 7: Ridge Augmentation Procedures in Implant Patients – A Staged Approach
- Volume 8: Biological and Hardware Complications in Implant Dentistry
- Volume 9: Implant Therapy in the Geriatric Patient
- Volume 10: Implant Therapy in the Esthetic Zone – Current Treatment Modalities and Materials for Single-tooth Replacements
- Volume 11: Digital Workflows in Implant Dentistry

## ITI Consensus Paper

Buser D./ Martin W./ Belser U.: Optimizing esthetics for implant restorations in the anterior maxilla :anatomical and surgical considerations. Int J Oral Maxillofac Implants, 2004; 19 Suppl: 43–61.

Additional information on the Straumann® Dental Implant System can be found at [www.straumann.com](http://www.straumann.com).



# 1. The Straumann® Dental Implant System

## 1.1 Overview

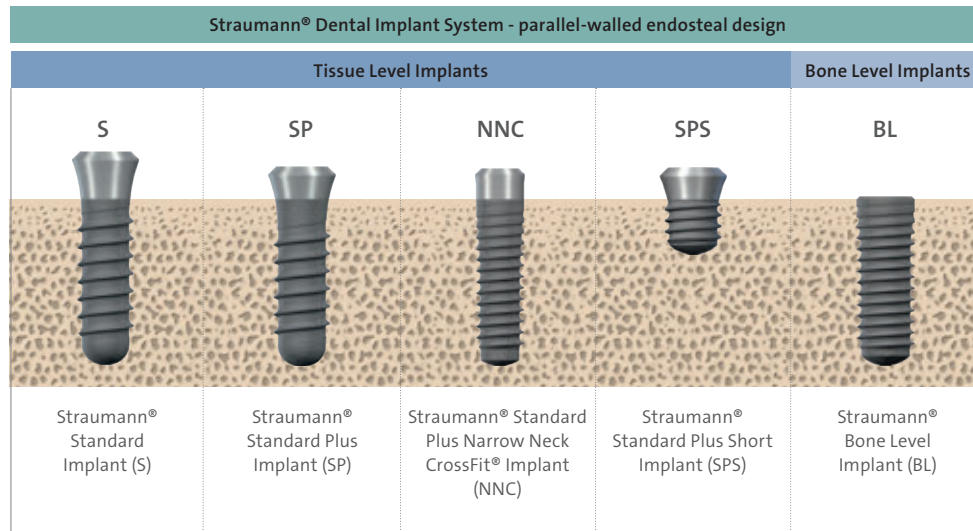
The Straumann® Dental Implant System offers a wide range of implant lines with diverse body and neck designs and different materials. This Basic Information focuses on the Titanium and Roxolid® Tissue Level and Bone Level implants with a parallel-walled endosteal design. These implants can be placed with the instruments from the Straumann® Surgical Cassette while using very similar surgical procedures.



Straumann® Tissue Level and Bone Level Implants are available in three endosteal diameters: Ø3.3 mm, Ø4.1mm, and Ø4.8 mm. A unified color code simplifies identification of instruments and implants.

Color coding	
	yellow Endosteal implant diameter 3.3 mm
	red Endosteal implant diameter 4.1 mm
	green Endosteal implant diameter 4.8 mm

## 1.2 Implant lines

### 1.2.1 Straumann® Standard Implant – The classic Tissue Level Implant

Straumann® Standard Implants have a smooth neck section of 2.8 mm and are especially suitable for classic single-stage procedures, where the implant is placed at soft tissue level and not covered with soft tissue during the healing phase. The Standard Implant uses the Straumann® synOcta® connection together with its corresponding prosthetic components, the Straumann® synOcta® portfolio and the Straumann® Solid Abutment. The thread pitch on the Standard Implants measures 1 mm for the Ø 3.3 mm implants, and 1.25 mm for all other diameters.

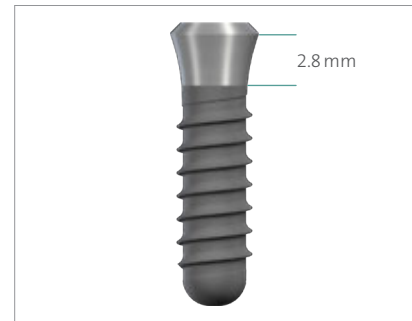

### 1.2.2 Straumann® Standard Plus Implant – The implant for flexible placement

Straumann® Standard Plus Implants have a shorter smooth neck section of 1.8 mm that allows flexible coronapical implant placement in combination with trans- or subgingival healing. This offers the dental surgeon additional options that are particularly useful in the anterior tooth region of the maxilla, where esthetic demands are high. Similar to Straumann® Standard Implants, this implant type uses the Straumann® synOcta® connection together with its corresponding prosthetic components, the Straumann® synOcta® portfolio and the Straumann® Solid Abutment. The thread pitch on the Standard Plus Implants measures 1 mm for the Ø 3.3 mm implants, and 1.25 mm for all other diameters.

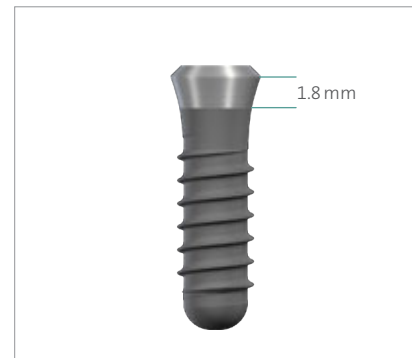

#### 1.2.2.1 Straumann® Standard Plus Narrow Neck CrossFit® Implant

The Narrow Neck CrossFit® (NNC) Implant is a 3.3 mm diameter implant with a narrow prosthetic platform. Its internal connection provides expanded prosthetic options and solutions for treatment in the upper and lower jaw, wherever space is limited. The NNC Implant is a Standard Plus (SP) Tissue Level Implant with a machined neck of 1.8 mm in height. With the introduction of Roxolid® material, it was possible to incorporate an internal CrossFit® connection and, at the same time, offer a strong small-diameter implant – resulting in added confidence for the operator. The implant body and thread design is the same as the Straumann® 3.3 mm Bone Level NC Implant. Narrow Neck CrossFit® Implants use the Narrow Neck CrossFit® (NNC) prosthetic components.



#### 1.2.2.2 Straumann® Standard Plus 4 mm Implant

The Straumann® Standard Plus 4 mm Implant is Straumann's shortest implant. The implant features a Standard Plus design for easy oral hygiene in the posterior regions, synOcta® internal connection compatibility with the existing Tissue Level prosthetic portfolio, and a Bone Level thread to increase the implant-to-bone contact. The most advanced Straumann technology combined within a very short implant.

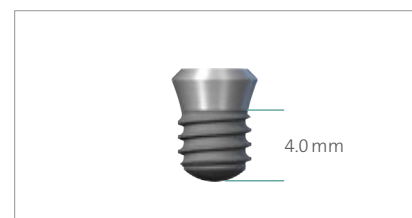

### 1.2.3 Straumann® Bone Level Implant – Straumann expertise applied at bone level

Straumann® Bone Level Implants are suitable for bone level treatments in combination with trans- or subgingival healing. The implant's rough surface extends to the top of the implant and the connection is shifted inwards. The Bone Level Implant uses a conical-cylindrical connection, the CrossFit® connection, together with its corresponding prosthetic CrossFit® components from the Bone Level product portfolio. A cylindrical outer contour and a thread pitch of 0.8 mm that tapers off in the coronal part of the implant provide excellent primary stability.



### 1.3 Implant-abutment connections

#### 1.3.1 Straumann® synOcta® Morse taper connection

The Straumann® synOcta® concept was introduced worldwide in 1999, using the well-known Morse taper design principle developed in 1986. The mechanically locking friction fit of the Straumann® synOcta® internal connection, with an 8° cone and an octagon for the repositioning of prosthetic parts, shows improved performance over traditional external connections. Abutment loosening, even in screw-retained situations, has virtually been eliminated.

The Straumann® synOcta® connection is available for all Straumann® Standard and Standard Plus, Implants with the Regular Neck (RN) and Wide Neck (WN) platform.



#### 1.3.2 Straumann® Narrow Neck CrossFit® connection

The Narrow Neck CrossFit® (NNC) Implant is a 3.3 mm diameter implant with a narrow prosthetic platform. The NNC Implant is a Standard Plus (SP) Tissue Level Implant with a machined neck of 1.8 mm in height. The implant body and thread design is the same as the Straumann® 3.3 mm Bone Level NC Implant.

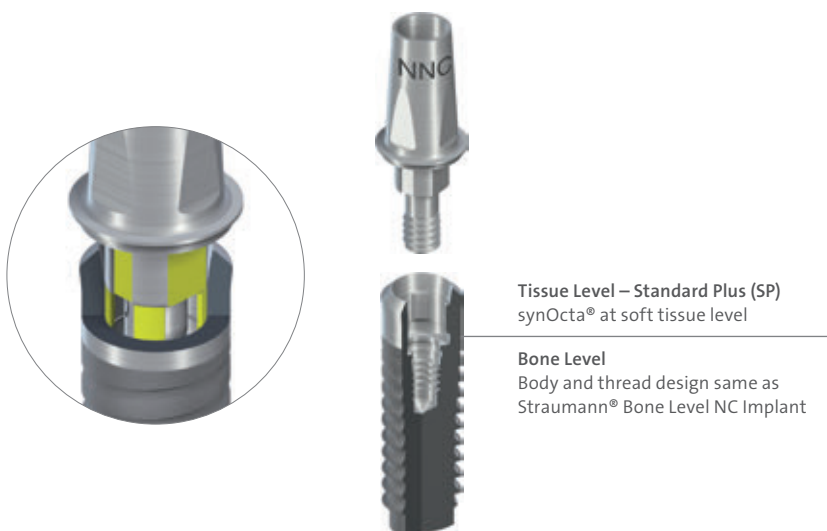



### 1.3.3 Straumann® Bone Level CrossFit® connection

The CrossFit® connection of Straumann® Bone Level Implants applies the know-how and benefits from the Straumann® synOcta® Morse taper connection to the connection requirements at bone level. Similar to the Straumann® synOcta® connection, the mechanically locking friction fit of the 15° conical-cylindrical CrossFit® connection with four internal grooves has excellent long-term stability under all loading conditions and virtually eliminates screw loosening. The CrossFit® connection is available for Straumann® Bone Level Implants only.

Straumann® Bone Level  $\varnothing$  4.1 mm and  $\varnothing$  4.8 mm Implants have the same connection, the Regular CrossFit® connection (RC), and share the same secondary components. Straumann® Bone Level  $\varnothing$  3.3 mm Implants feature the narrow CrossFit® connection (NC). The corresponding secondary components are color-coded:

- yellow = NC connection
- magenta = RC connection



Connection types	
NNC: Narrow Neck CrossFit® $\varnothing$ 3.5 mm	$\varnothing$ 3.5 mm 
RN: Regular Neck $\varnothing$ 4.8 mm	$\varnothing$ 4.8 mm 
WN: Wide Neck $\varnothing$ 6.5 mm	$\varnothing$ 6.5 mm 
NC: Narrow CrossFit® $\varnothing$ 3.3 mm	$\varnothing$ 3.3 mm 
RC: Regular CrossFit® $\varnothing$ 4.1 and $\varnothing$ 4.8 mm	$\varnothing$ 4.1 mm $\varnothing$ 4.8 mm 

## 1.4 Material

Roxid<sup>®</sup> is a groundbreaking material specifically designed for use in dental implantology. The titanium-zirconium alloy is stronger than pure titanium<sup>1,2</sup> and has excellent osseointegration properties<sup>3-5</sup>. This combination of properties is unique in the market, since no other metallic alloy unifies high mechanical strength and osteoconductivity.

Thanks to their outstanding biological and mechanical properties, Roxolid<sup>®</sup> Implants offer more treatment options than conventional titanium implants.

## 1.5 Surface

SLActive<sup>®</sup> significantly accelerates the osseointegration process and delivers everything you expect from a successful and patient-friendly implant treatment.

- High success and survival rates in compromised patients: diabetic, smokers, irradiated patients<sup>6-9</sup>
- SLActive<sup>®</sup> reduces initial healing time to 3–4 weeks<sup>\*10-14</sup>
- Increased treatment predictability in critical protocols<sup>6-17</sup>

Most implant failures occur in the critical early period between weeks 2 and 4. Although similar healing patterns were observed for both SLA<sup>®</sup> and SLActive<sup>®</sup> Implants, bone-to-implant contact (BIC) was greater after 2 weeks and significantly greater after 4 weeks for SLActive<sup>®</sup> (p-value < 0.05).<sup>10</sup>

## 1.6 Transfer piece

The Bone Level Tapered Implants are delivered with the Loxim<sup>®</sup> Transfer Piece, which is connected to the implant with a snap-in mounting.

\*Healing time defined by BIC and stability.

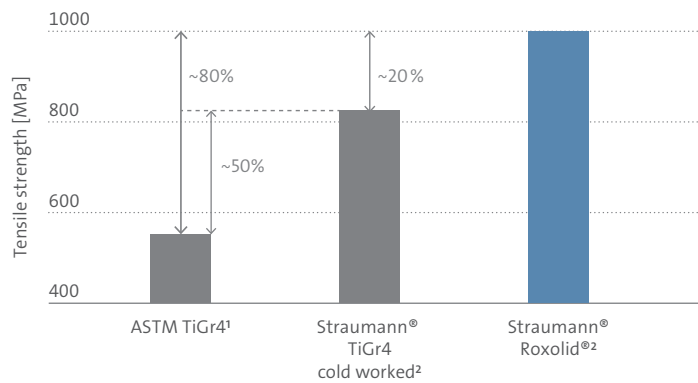

Roxid<sup>®</sup> shows a 20% higher tensile strength than Straumann cold-worked titanium and a 80% higher strength than standard titanium Grade 4.

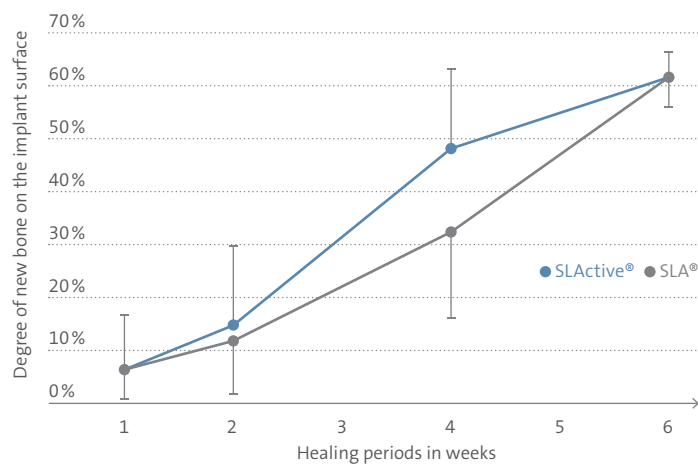

The SLActive<sup>®</sup> surface shows a faster integration into new bone after 4 weeks (50%) compared to the SLA<sup>®</sup> surface (30%).<sup>10</sup>

Features	Benefits
Snap-in mounting ...	... for easy handling without counter-maneuvering
Blue color ...	... for high visibility
Compact dimensions ...	... for easy access
Height markings ...	... for correct implant placement
Pre-determined breaking point ...	... avoids bone overcompression

## 2. Indications and Contraindications

To obtain more information about indications and contraindications related to each implant, please refer to the corresponding instructions for use. Instructions for use can also be found on [www.ifu.straumann.com](http://www.ifu.straumann.com)









### 2.1 List of abbreviations

List of abbreviations		
SCS	=	Screw Carrying System
HDD	=	Horizontal Defect Dimension
NNC	=	Narrow Neck CrossFit® connection (3.5 mm)
RN	=	Regular Neck (4.8 mm)
WN	=	Wide Neck (6.5 mm)
NC	=	Narrow CrossFit® connection (for Bone Level Implants)
RC	=	Regular CrossFit® connection (for Bone Level Implants)
S	=	Standard
SP	=	Standard Plus
BL	=	Bone Level
SPS	=	Standard Plus Short

## 2.2 Implant types and bone dimensions

Straumann® implants are available in the materials Roxolid® with the SLActive® or SLA® surface or titanium with an SLA® surface. Refer to the specific IFU for intended use and indication information.

Some of the Straumann products listed here may not be available in all countries.

Specific indications for Straumann® Roxolid® Implants					
Implant type		Distinctive features	Minimal ridge width*	Minimal gap width**	Available lengths
SP Ø 3.3 mm NNC***		• Small-diameter implant for narrow interdental spaces and bone ridges	5.5 mm	5.5 mm	8–14 mm
S Ø 3.3 mm RN		• Ideal in cases with restricted ridge width****	5.5 mm	7 mm	8–16 mm
SP Ø 3.3 mm RN					8–14 mm
BL Ø 3.3 mm NC SLActive®/SLA®		• Small-diameter implant for narrow interdental spaces and ridges	5.5 mm	5.5 mm	8–14 mm
S Ø 4.1 mm RN		• For oral endosteal implant indications in the maxilla and mandible, for functional and esthetic rehabilitation of edentulous and partially edentulous patients	6 mm	7 mm	6–16 mm
SP Ø 4.1 mm RN					6–14 mm
SP Ø 4.1 mm RN***		• Open-end situations in the mandible with severely atrophic bone resorption (always splinted, one implant per unit)	6 mm	7 mm	4 mm
BL Ø 4.1 mm RC		• For oral endosteal implant indications in the maxilla and mandible, for functional and esthetic rehabilitation of edentulous and partially edentulous patients	6 mm	6 mm	8–14 mm







\*Minimal ridge width: Minimal orofacial ridge width, rounded to 0.5 mm

\*\*Minimal gap width: Minimal mesial-distal gap width for a single-tooth restoration, between adjacent teeth, rounded to 0.5 mm

\*\*\* Only available in Roxolid®

\*\*\*\* Titanium Ø3.3 mm S and SP RN implants are to be used only in cases with partially dentate jaws, with implant-borne fixed constructions, combined with Ø 4.1 mm implants and splinting of the superstructure

Specific indications for Straumann® Roxolid® Implants

Implant type		Distinctive features	Minimal ridge width*	Minimal gap width**	Available lengths
S Ø 4.8 mm RN		<ul style="list-style-type: none"> <li>For oral endosteal implant indications in the maxilla and mandible, for functional and esthetic rehabilitation of edentulous and partially edentulous patients</li> <li>The S/SP Ø 4.8 mm Implants are especially suited for wider interdental spaces and ridges</li> </ul>	7 mm	7 mm	6–14 mm
SP Ø 4.8 mm RN					
SP Ø 4.8 mm RN***		<ul style="list-style-type: none"> <li>Open-end situations in the mandible with severely atrophic bone resorption (always splinted, one implant per unit)</li> </ul>	7 mm	7 mm	4 mm
S Ø 4.8 mm WN		<ul style="list-style-type: none"> <li>For oral endosteal implant indications in the maxilla and mandible, for functional and esthetic rehabilitation of edentulous and partially edentulous patients</li> <li>The S/SP Ø 4.8 mm Implants are especially suited for wider interdental spaces and ridges</li> <li>S/SP Implants with a WN platform are designed for the reconstruction of teeth with a greater neck diameter</li> </ul>	7 mm	8.5 mm	6–12 mm
SP Ø 4.8 mm WN					
SP Ø 4.8 mm WN***		<ul style="list-style-type: none"> <li>Open-end situations in the mandible with severely atrophic bone resorption (always splinted, one implant per unit)</li> </ul>	7 mm	8.5 mm	4 mm
BL Ø 4.8 mm RC		<ul style="list-style-type: none"> <li>For oral endosteal implant indications in the maxilla and mandible, for functional and esthetic rehabilitation of edentulous and partially edentulous patients</li> <li>BL Ø 4.8 mm Implants are especially suited for wider interdental spaces and ridges</li> </ul>	7 mm	7 mm	8–14 mm

\* Minimal ridge width: Minimal orofacial ridge width, rounded to 0.5 mm

\*\* Minimal gap width: Minimal mesial-distal gap width for a single-tooth restoration, between adjacent teeth, rounded to 0.5 mm

\*\*\* Only available in Roxolid®

# 3. Preoperative Planning

## 3.1 Implant position

The implant is the focal point of the dental restoration. It provides the basis for planning the surgical procedure. Close communication between the patient, dentist, surgeon and dental technician is imperative for achieving the desired prosthetic result.

To establish the topographical situation, the axial orientation, and the choice of implants, we recommend the following:

- Make a wax-up/set-up on the previously prepared study cast.
- Define the type of superstructure.

The wax-up/set-up can later be used as the basis for a custom-made X-ray or drill template and for a temporary restoration.

**Note:** The implant abutments should always be loaded axially. Ideally, the long axis of the implant is aligned with the cusps of the opposing tooth. Extreme cusp formation should be avoided. It can lead to unphysiological loading.

The implant diameter, implant type, position and number of implants should be selected individually, taking the anatomy and spatial circumstances (e.g. malpositioned or inclined teeth) into account. The measurements given here should be regarded as minimum guidelines. Only when the minimum distances are observed is it possible to design the restoration so that the necessary oral hygiene measures can be carried out.

The final hard and soft tissue response is influenced by the position between the implant and the proposed restoration. Therefore, it should be based on the position of the implant-abutment connection. The implant position can be viewed in three dimensions:

- Mesiodistal
- Orofacial
- Coronoapical

### 3.1.1 Mesiodistal implant position

The mesiodistal bone availability is an important factor for choosing the implant type and diameter as well as the inter-implant distances in the case of multiple implants. The point of reference on the implant for measuring mesiodistal distances is always the shoulder, being the most voluminous part of the implant. Note that all distances given in this chapter are rounded to 0.5 mm. The following basic rules are recommended:

#### Rule 1

Distance to adjacent tooth at bone level:

A minimal distance of 1.5 mm from the implant shoulder to the adjacent tooth at bone level (mesial and distal) is recommended.

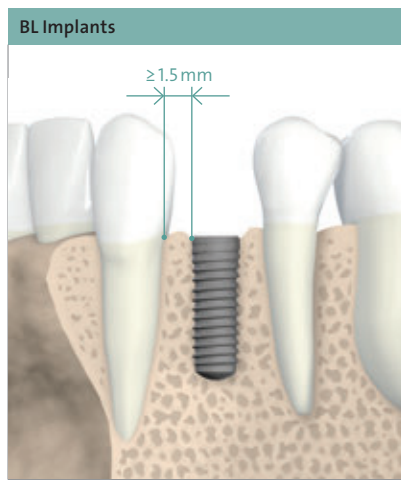
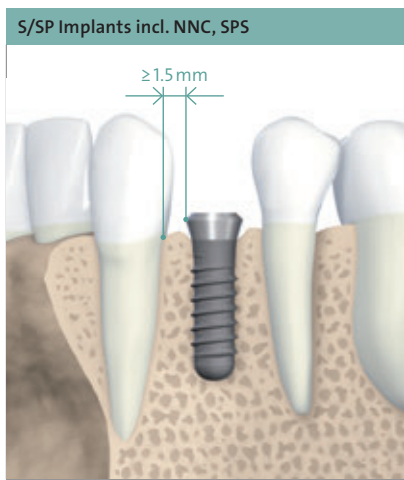

#### Rule 2

Distance to adjacent implants at bone level:

A minimal distance of 3 mm between two adjacent implant shoulders (mesiodistal) is recommended.

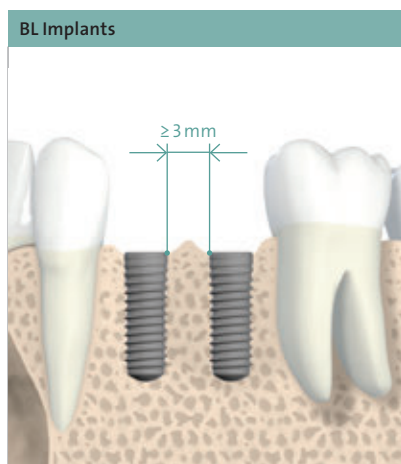
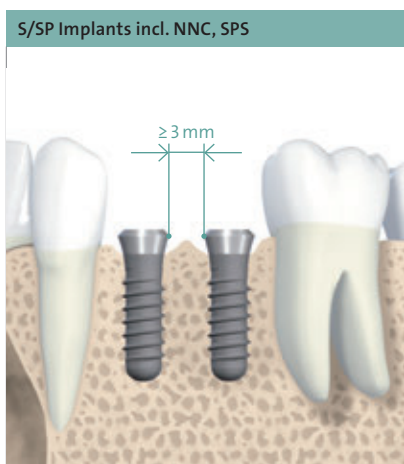

### 3.1.1.1 Examples for single-tooth gaps

For single-tooth restoration, the implant is placed centered within the single-tooth gap. The following examples show how Rule 1 is implemented.

#### **Straumann® Standard and Standard Plus Implants**

For Straumann® Tissue Level Implants, the gap size has to be considered for the selection of the shoulder diameter (NNC, RN, WN). In order to make use of the gap width in conjunction with Rule 1, the following approximation can be used.

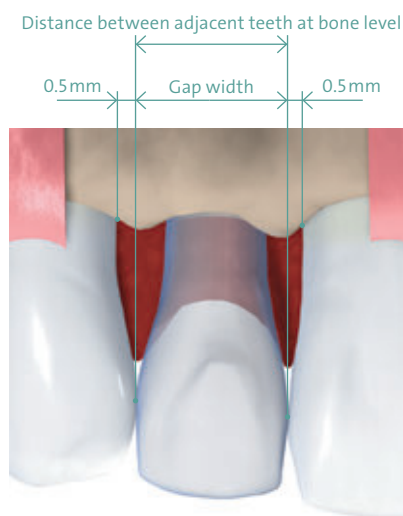

The distance between adjacent teeth at bone level is approximately 1 mm ( $2 \times 0.5\text{mm}$ ) more than the gap width. Hence, applying Rule 1, the gap width must be 2 mm wider than the implant shoulder.



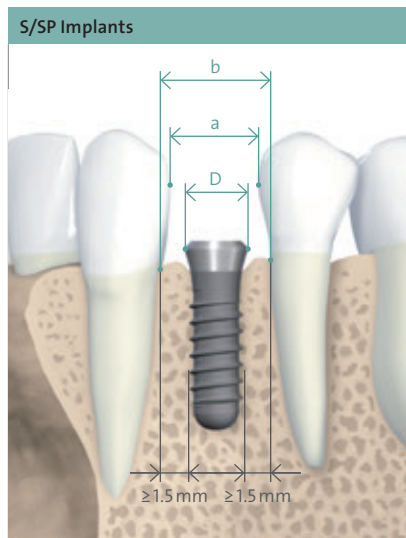

Shoulder diameter D (mm)	Gap width $a_{min}$ (mm)	Distance between adjacent teeth at bone level $b_{min}$ (mm)
∅ 3.5 (NNC)	5.5	6.5
∅ 4.8 (RN)	7	8
∅ 6.5 (WN)	8.5	9.5
<b>Rule</b>	<b>D + 2 mm</b>	<b>D + 3 mm*</b>

\* Rule 1 applied on both implant sides  
The Diagnostic T, applied in the patient's mouth or on the cast, can be used to obtain an initial measurement of the gap width for the choice of the implant shoulder diameter and prosthetic reconstruction.

### Straumann® Bone Level Implants

For Straumann® Bone Level Implants, the distance between adjacent teeth at bone level determines the implant diameter.

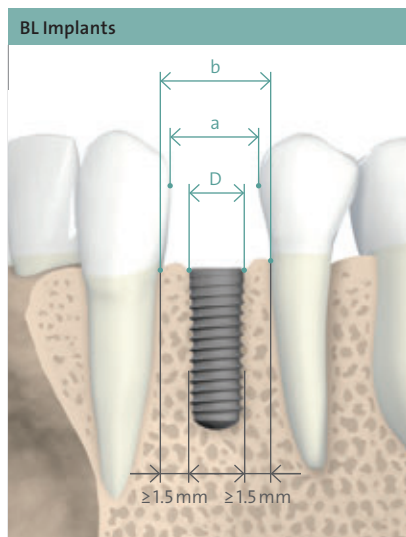

Shoulder diameter D (mm)	Gap width $a_{min}$ (mm)	Distance between adjacent teeth at bone level $b_{min}$ (mm)
BL ∅ 3.3	5.5	6.5
BL ∅ 4.1	6	7
BL ∅ 4.8	7	8
<b>Rule</b>	<b>D + 2 mm</b>	<b>D + 3 mm*</b>

\* Rule 1 applied on both implant sides



### 3.1.2 Orofacial implant position

The facial and palatal bone must be at least 1 mm thick in order to ensure stable hard and soft tissue conditions. The minimal orofacial ridge widths for individual implant types are given in the indication tables in chapter 2.2. Within this limitation, a restoration-driven orofacial implant position and axis should be chosen such that screw-retained restorations are possible.

**Caution:** An augmentation procedure is indicated where the orofacial bone wall is less than 1 mm or a layer of bone is missing on one or more sides. This technique should be employed only by dentists who have adequate experience in the use of augmentation procedures.

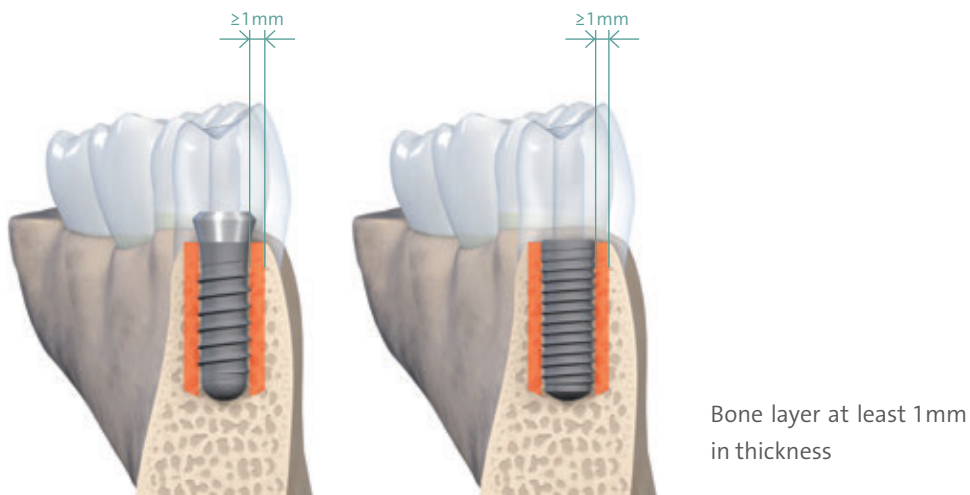

Choose the orofacial implant position and axis so that the screw channel of the screw-retained restoration is located behind the incisal edge.

### 3.1.3 Coronoapical implant position

Straumann® dental implants allow for flexible coronoapical implant positioning, depending on individual anatomy, implant site, the type of restoration planned, and preference. In the anterior area, a deeper coronoapical implant position is better for esthetic reasons. In this situation, the use of Straumann® Standard Plus or Bone Level Implants is recommended. The following illustration shows the coronoapical implant position for these implants.

#### Straumann® Standard Implants

Straumann® Standard Implants with a smooth neck section of 2.8 mm are submerged in the bone as far as the margin of the SLA®/SLActive® surface.

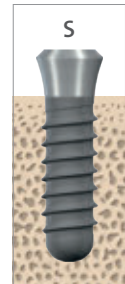

#### Straumann® Standard Plus Implants

Straumann® Standard Plus Implants with a smooth neck section of 1.8 mm are submerged in the bone as far as the margin of the Straumann® SLA®/SLActive® surface. Optionally they can be placed slightly deeper if necessary.

Ideally, in the esthetic region, the implant shoulder should be positioned about 1 mm apical to the cemento-enamel junction (CEJ) of the contralateral tooth or 2 mm subgingival of the prospective gingival margin.



**Caution:** If a Straumann® Tissue Level Implant is inserted deeper than the margin of the Straumann® SLA®/SLActive® surface, the preparation depth must be increased accordingly (see Chapter 4.1.2).

#### Straumann® Bone Level Implants

Straumann® Bone Level Implants are best set with the outer rim of the narrow 45° sloping edge (chamfer) at bone level.

Ideally, in the esthetic region, the implant shoulder should be positioned about 3–4 mm subgingival of the prospective gingival margin and with the correct implant orientation (See Chapter 4.3).

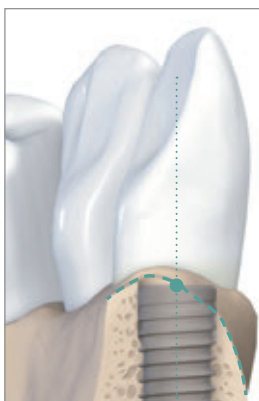

In a scalloped situation, place the mesial/distal point of the outer rim of the implant to bone level. The lingual/palatal wall will then extend slightly over the top line of the implant. The buccal wall is located somewhat below the implant edge.

## 3.2 Planning aids

### 3.2.1 Mesiodistal and orofacial space requirements

#### 3.2.1.1 Diagnostic T for Straumann® Standard and Standard Plus Implants

By using the Diagnostic T in the patient's mouth or on the cast, an initial impression of the spatial relations for the choice of the implant shoulder diameter and prosthetic reconstruction can be obtained. The pictograms on the instruments show which arm is used for which measurement.

**Note:** Currently, a Diagnostic T for Straumann® Bone Level Implants is not available.

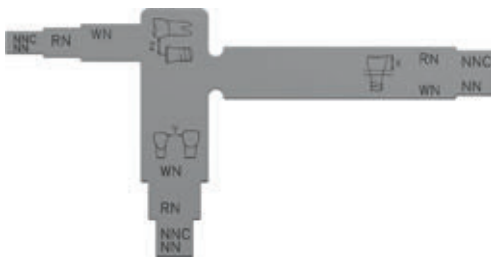

X = Minimum occlusal space requirement  
(for the lowest prosthetic restoration option)  
Y = Interproximal distance (gap width)  
Z = Implant center to adjacent tooth (half the gap width)

Implant shoulders:

NNC = Narrow Neck CrossFit® (∅ 3.5 mm)  
RN = Regular Neck (∅ 4.8 mm)  
WN = Wide Neck (∅ 6.5 mm)

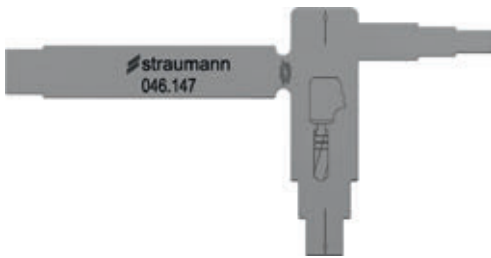

Minimum vertical space requirement for access  
with surgical instruments



Determining the implant shoulder diameter in a  
single-tooth gap

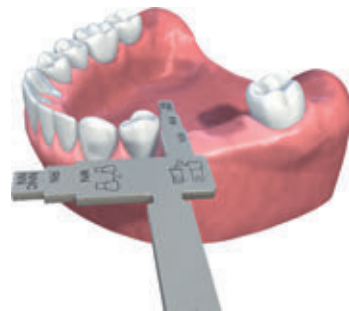

Determining the minimal distance between im-  
plant axis and adjacent teeth

### 3.2.1.2 Straumann® Implant Distance Indicator

Two types of Implant Distance Indicators are available:

- For Straumann® Standard and Standard Plus Implants (art. no. 046.148)
- For Straumann® Bone Level Implants (art. no. 026.0901)

The disks of the Implant Distance Indicators display the shoulder diameters of Straumann® implants. The Implant Distance Indicators can be used to check the available space before the start of treatment or intraoperatively to mark the desired implant site.



Intraoperative use of the Implant Distance Indicator before flap opening



Round Bur, Needle Drill,  
Ø 1.4 mm Ø 1.6 mm

After flap opening and precise positioning of the disk(s) at the planned implantation site, it is possible to drill through the perforation in the disk(s) with the Round Bur Ø 1.4 mm (art. no. 044.022) or the Ø 1.6 mm Needle Drill (art. no. 026.0054) in order to mark the center of the implant bed.

**Implant Distance Indicator for Straumann® Standard and Standard Plus Implants**

Straumann® Implant Distance Indicator for Straumann® Standard and Standard Plus Implants (art. no. 046.148)

	Leg label	Disk diameter	Corresponding implants
Leg 1	RN Ø 4.8	Ø 4.8 mm	all Regular Neck (RN) Implants
Leg 2	RN Ø 4.8	Ø 4.8 mm	all Regular Neck (RN) Implants
Leg 3	NNC Ø 3.5	Ø 3.5 mm	all Narrow Neck CrossFit® (NNC) Implants
Leg 4	WN Ø 6.5	Ø 6.5 mm	all Wide Neck (WN) Implants

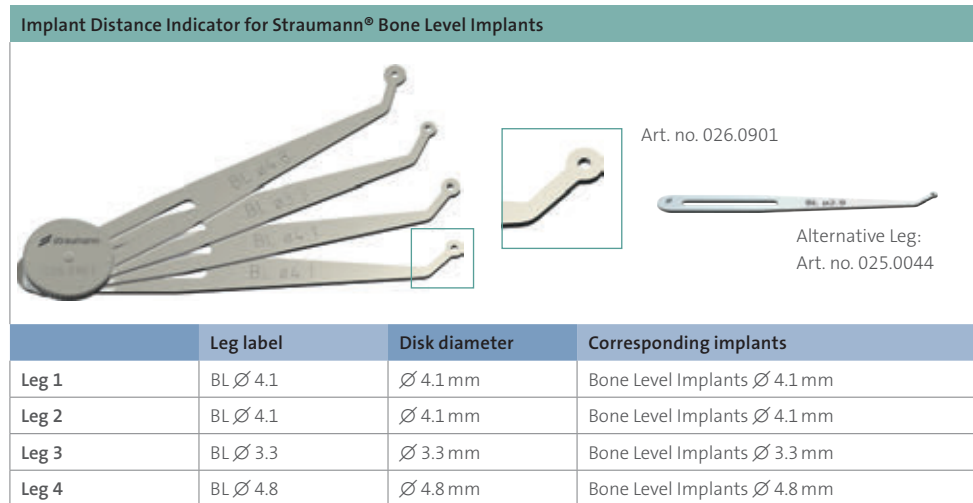

### 3.2.2 Determining the vertical bone availability

The vertical bone availability determines the maximal allowable length of the implant that can be placed. To make it easier in determining the vertical bone availability, the use of an X-ray Template with X-ray Reference Spheres is recommended.

#### 3.2.2.1 X-ray Reference Sphere

The X-ray Reference Sphere (art. no. 049.076V4) has a diameter of 5 mm. The image of the sphere on the X-ray provides the reference value for the magnification scale. To prepare a reference sphere-carrying template, the selected implant positions are marked on the study cast. The X-ray Reference Spheres are fixed at the marked points. The vacuum-formed template is then made with the spheres. The subsequent X-ray shows the vertical bone availability and mucosal thickness, from which the corresponding implant length and type can be derived, in consideration of the enlargement factor.



**Warning:** Adhere to production requirements of the holding template and ensure that the X-ray Reference Sphere is securely fixed within the holding template.

### 3.2.2.2 X-ray Templates

The X-ray Templates are used for measurement and comparison. They also assist the user in selecting the suitable implant type, diameter and length. The following X-ray Templates are available:

- For Straumann® Standard and Standard Plus Implants (art. no. 150.215)
- For Straumann® Bone Level Implants (art. no. 150.216)

Similar to the distortions that occur in X-rays, the implant dimensions are shown on the individual templates with the corresponding distortion factors (1:1 to 1.7:1).

Determining each magnification factor or scale is facilitated by showing the X-ray Reference Sphere on the template (next to the scale reference).

The first stage consists of comparing the size of the X-ray Reference Sphere on the patient's X-ray with the size of the reference sphere on the template. By superimposing the two pictures, the correct scale can be found. Next, the spatial relations around the implant position are determined and the implant length and insertion depth are established.

**Warning:** Use only the X-ray Template specific to the implant type.

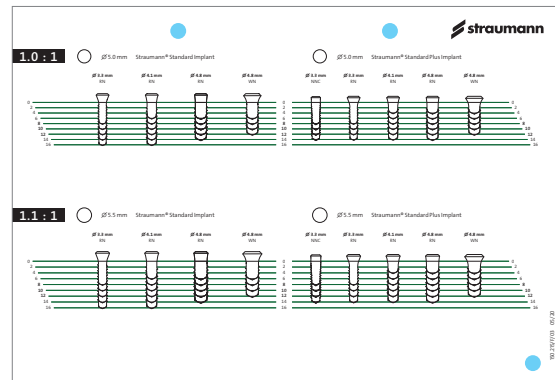

X-ray Template for Straumann® Standard and Standard Plus Implants (art. no. 150.215)

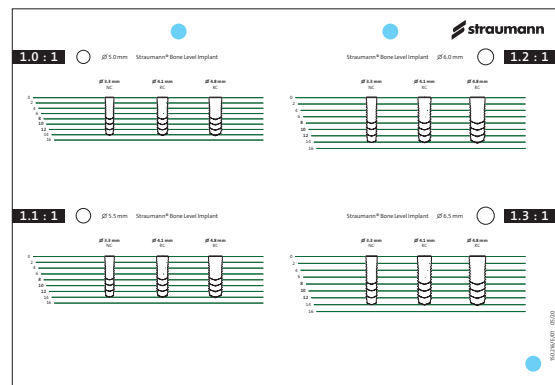

X-ray Template for Straumann® Bone Level Implants (art. no. 150.216)



Example: scale 1.1:1 = reference sphere Ø 5.5 mm



To calculate the effective bone availability the following formula should be used:

$$\frac{\text{X-ray Reference Sphere 5 mm} \times \text{bone availability (X-ray*)}}{\text{Reference sphere diameter on the X-ray}} = \text{effective bone availability}$$

\* Taking into consideration all implant-related anatomical structures (e.g. mandibular canal, maxillary sinus, etc.)

Example for a measured bone availability and reference sphere diameter on the X-ray of 13 mm and 6 mm (+ 20 % distortion), respectively.

$$\frac{5 \text{ mm} \times 13 \text{ mm}}{6 \text{ mm}} = 10.8 \text{ mm}$$

Additional length of the drill tip:

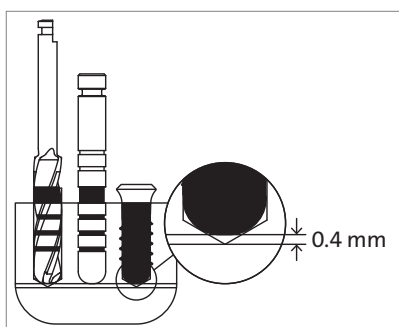

**Warning:** Due to the construction and function of the drills, the drill tip is a maximum of 0.4 mm longer than the implant insertion depth. This additional length must be taken into consideration during the planning phase.

# 4. Surgical Procedures

## 4.1 Implant bed preparation

The implant diameter, implant type, position and number of implants should be selected individually taking the anatomy and spatial circumstances into account. The specific measurements should be regarded as minimum guidelines.

Steps	Instrumentation
<b>1. Basic implant bed preparation</b>	
Ridge preparation	Needle Drill Round Bur
Twist drilling	Pilot Drill 1 (2.2 mm) Alignment Pin Pilot Drill 2 (2.8 mm) Depth Gauge Twist Drill PRO (Ø 3.5 mm) Depth Gauge Twist Drill PRO (Ø 4.2 mm) Depth Gauge
<b>2. Fine implant bed preparation</b>	
Profile drilling	SP Profile Drill      BL/NNC Profile Drill
Tapping	S/SP Tap      BL/NNC Tap

**Basic implant bed preparation** involves ridge preparation and twist drilling. For Twist Drilling, the endosteal diameter of the implant (3.3/4.1/4.8 mm) – not the implant type or the bone class – determines which instruments have to be used.

**Fine implant bed preparation** involves profile drilling and tapping, if required. For tapping, the implant type (S/SP/BL) and the bone class determine which instruments have to be used.

**Please note:** Narrow Neck CrossFit® and Standard plus 4 mm Implants have a Standard Plus neck design, but both implant types require Bone Level tapping.

#### 4.1.1 Basic implant bed preparation

After the gingiva is opened, the basic implant bed preparation begins with preparation of the alveolar ridge (Step 1) and marking of the implantation site with a Round Bur or a Needle Drill (Step 2). The implant bed is then prepared with Pilot Drills and Twist Drills (Steps 3–7), according to the endosteal implant diameter chosen in the preoperative planning (see Chapter 3).



##### Step 1 – Prepare the alveolar ridge

Carefully reduce and smooth a narrow tapering ridge with a large Round Bur. This will provide a flat bone surface and a sufficiently wide area of bone.

**Note:** When choosing the implant length, the vertical reduction of the bone has to be considered.



##### Step 2 – Mark the implantation site

Mark the implantation site determined during the implant position planning with the  $\varnothing$  1.4 mm Round Bur or the  $\varnothing$  1.6 mm Needle Drill. The Implant Distance Indicator can be used for this purpose. If the Distance Indicator is used together with the Needle Drill to mark the implant position, make sure not to drill more than 3 mm in order to avoid any collision between the Needle Drill and the Distance Indicator.

Widen and correct the position of the mark with the  $\varnothing$  2.3 mm or the  $\varnothing$  3.1 mm Round Bur, if necessary.

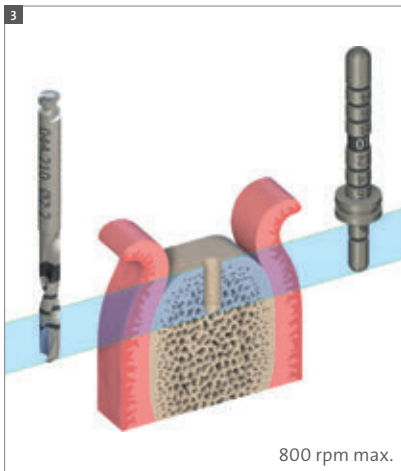

### Step 3 – Mark the implant axis

With the  $\varnothing$  2.2 mm Pilot Drill, mark the implant axis by drilling to a depth of about 6 mm – except for 4 mm SPS Implants, where the drilling depth must not exceed 4 mm.

Insert the short side of the Depth Gauge with the Implant Distance Indicator to check for correct implant axis orientation.

If necessary, correct unsatisfactory implant axis orientation in the following step.

**Note:** The Implant Distance Indicator visualizes the shoulder diameter of 4.8 mm (RN) and enables checking of the probable position of the implant shoulder.

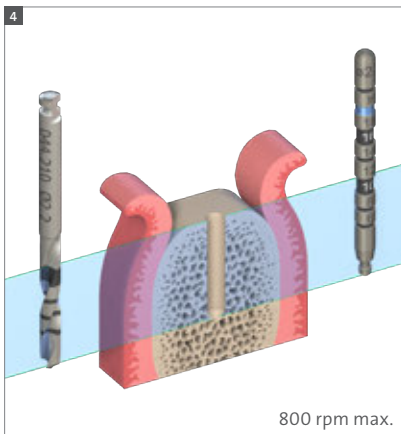

### Step 4 – Prepare the implant bed to $\varnothing$ 2.2 mm

Pre-drill the implant bed to the final preparation depth with the  $\varnothing$  2.2 mm Pilot Drill.

Use the  $\varnothing$  2.2 mm Alignment Pin to check the implant axis and preparation depth.

**Caution:** At this point take an X-ray, particularly with vertically reduced bone availability. The Alignment Pin is inserted into the drilled area, which allows a comparative visualization of the drill hole in relation to the anatomical structures.

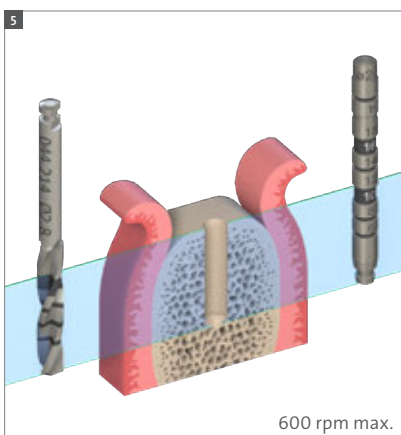

### Step 5 – Widen the implant bed to $\varnothing$ 2.8 mm

Continue with the implant bed preparation.

If necessary, correct the implant position with the  $\varnothing$  2.8 mm Pilot Drill. Use the  $\varnothing$  2.8 mm Depth Gauge to check the preparation depth.

For an implant with an endosteal diameter of 3.3 mm, basic preparation ends here. Continue with the fine implant bed preparation.

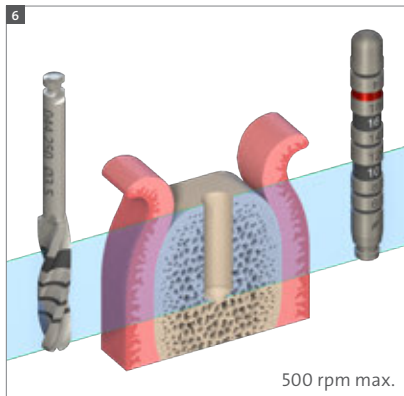

For  $\varnothing$  4.1 mm and  $\varnothing$  4.8 mm implants

**Step 6 – Widen the implant bed to  $\varnothing$  3.5 mm**

Continue with the  $\varnothing$  3.5 mm Straumann® Twist Drill PRO and check the final preparation depth with the  $\varnothing$  3.5 mm Depth Gauge.

For an implant with an endosteal diameter of 4.1 mm, basic preparation ends here. Continue with the fine implant bed preparation.

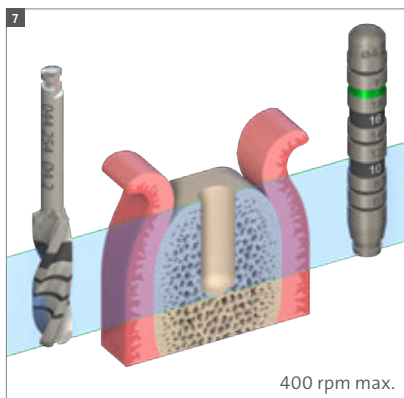

For  $\varnothing$  4.8 mm implants

**Step 7 – Widen the implant bed to  $\varnothing$  4.2 mm**

Continue with the  $\varnothing$  4.2 mm Straumann® Twist Drill PRO and check the final preparation depth with the  $\varnothing$  4.2 mm Depth Gauge.

Continue with the fine implant bed preparation.

The following table summarizes the use of instruments for the basic implant bed preparation according to the endosteal implant diameter. All drills are available in a short and a long version (see also Chapter 6). The table lists the short drills only.

Instrumentation for basic implant bed preparation					Endosteal Ø (mm)		
Step	Art. no.	Product	max. rpm		Ø 3.3	Ø 4.1	Ø 4.8
1 Ridge preparation	044.004	Round Bur, Ø 3.1 mm	800				
2 Mark implant position	026.0054	Needle Drill, Ø 1.6 mm	800				
	044.022	Round Bur, Ø 1.4 mm					
	044.003	Round Bur, Ø 2.3 mm					
	044.004	Round Bur, Ø 3.1 mm					
3 Mark implant axis	044.210	Pilot Drill 1, short, Ø 2.2 mm	800				
	046.455	Depth Gauge, with Implant Distance Indicator, Ø 2.2/2.8 mm					
4 Prepare implant bed to Ø 2.2 mm	044.210	Pilot Drill 1, short, Ø 2.2 mm	800				
	046.799	Alignment Pin, Ø 2.2 mm, straight					
5 Prepare implant bed to Ø 2.8 mm	044.214	Pilot Drill 2, short, Ø 2.8 mm	600				
	046.800	Depth Gauge, Ø 2.8 mm			↓		
6 Prepare implant bed to Ø 3.5 mm	044.250	Twist Drill PRO, short, Ø 3.5 mm	500				
	046.802	Depth Gauge Ø 3.5 mm				↓	
7 Prepare implant bed to Ø 4.2 mm	044.254	Twist Drill PRO, short, Ø 4.2 mm	400				
	046.804	Depth Gauge Ø 4.2 mm					↓

#### 4.1.2 Fine implant bed preparation





The fine implant bed preparation encompasses profile drilling and subsequent tapping. Instrumentation depends on the implant type, the endosteal implant diameter, and the bone class.

##### Profile drilling

The Profile Drill prepares the implant bed for a specific Straumann® implant.

- Straumann® Standard Plus and Bone Level Implants require profile drilling with specific instruments. This is independent of the bone class. Due to the unflared neck portion, Standard Plus Ø 4.8 mm RN Implants are inserted without profile drilling.
- Straumann® Standard Implants are inserted without profile drilling.

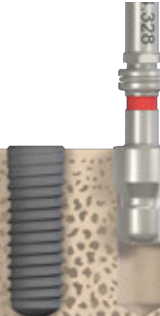
When inserting a Straumann® Standard Plus Implant up to the implant shoulder level (see Chapter 3), the preparation depth must be 2 mm deeper than the indicated implant length. (Example: The preparation depth for a 10 mm SP Implant inserted up to shoulder level must be 12 mm.) The Profile Drill should also be used deeper for fine implant bed preparation. Examples are illustrated below

Straumann® Standard Plus Profile Drill	Straumann® Bone Level Profile Drill	Straumann® Narrow Neck CrossFit® Profile Drill
<div style="display: flex; justify-content: space-around;"> <div style="text-align: center;"> <p>Insertion depth on SLActive®/SLA® surface margin level</p>  </div> <div style="text-align: center;"> <p>Insertion depth on implant shoulder</p>  </div> </div>		<div style="display: flex; justify-content: space-around;"> <div style="text-align: center;"> <p>Insertion depth on SLActive® surface margin level</p>  </div> <div style="text-align: center;"> <p>Insertion depth on implant shoulder</p>  </div> </div>
<p>Insert the Straumann® Standard Plus Profile Drill according to the planned insertion depth of the implant.</p>	<p>Insert the Straumann® Bone Level Profile Drill according to the planned insertion depth of the implant.</p>	<p>Insert the Straumann® Bone Level Profile Drill according to the planned insertion depth of the implant</p>
<p>400 rpm max.</p>	<p>300 rpm max.</p>	<p>300 rpm max</p>

The Drill Extender (art. no. 040.563) can be used with Profile Drills to increase the overall instrument length by 15 mm. This helps to gain access between long crowns of adjacent teeth.

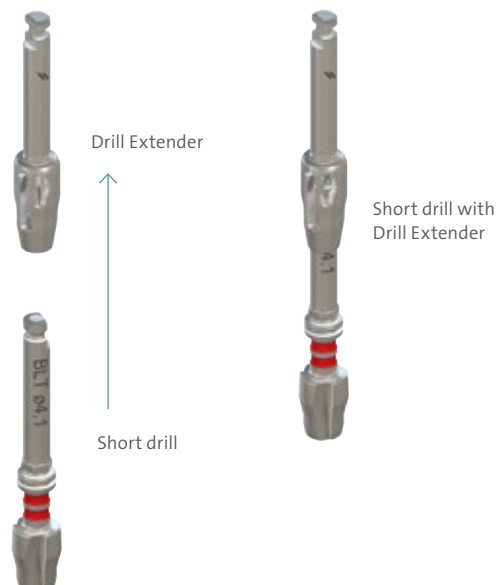

## Tapping

Tapping prepares the implant bed for a specific thread type. It is an optional step that gives the surgeon the flexibility to adjust the surgical protocol to the bone class to help achieve optimal primary stability. It is recommended in dense bone in order to keep the insertion torque in a desirable range.

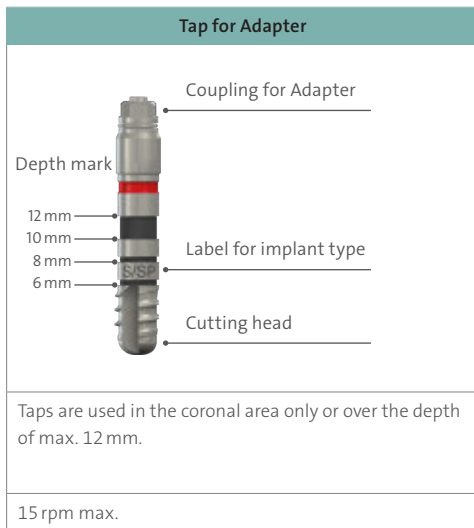

**Caution:** Straumann® Taps are to be used only for the corresponding implant type!

**Please note:** For NNC and SP 4 mm Implants, the corresponding diameter BL Taps must be used.

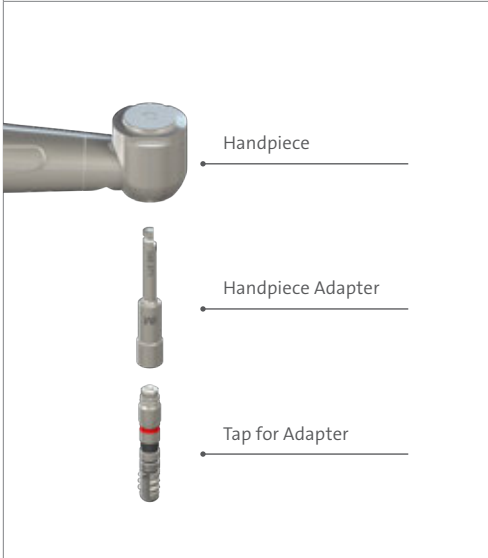
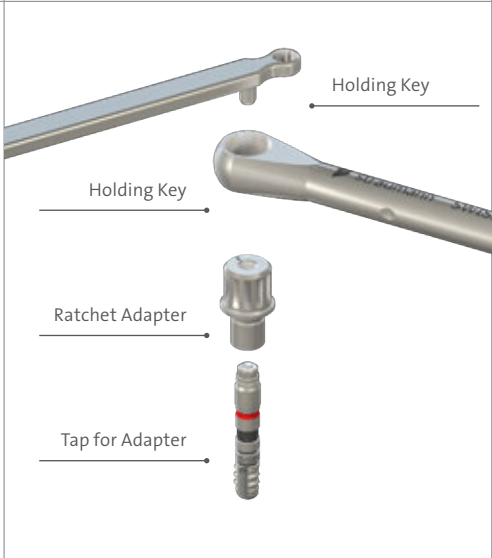

The Straumann® Taps can be used with a dental handpiece or with a Straumann® Ratchet as shown below.

Tapping with Handpiece	Tapping with Ratchet
<p>Connect the Tap for Adapter to the Handpiece via the Handpiece Adapter. Do not exceed 15 rpm.</p>	<p>For tapping with the Ratchet connect a Ratchet Adapter to the Tap for Adapter. After inserting the Tap into the cavity, the Ratchet is placed on its coupling and the thread is tapped with a slow rotating movement. The Holding Key is used as a stabilizer to maintain the direction of tapping during the procedure.</p>
 <p>Handpiece</p> <p>Handpiece Adapter</p> <p>Tap for Adapter</p>	 <p>Holding Key</p> <p>Holding Key</p> <p>Ratchet Adapter</p> <p>Tap for Adapter</p>

#### 4.1.3 Examples for fine implant bed preparation: Straumann® Standard and Standard Plus Implants

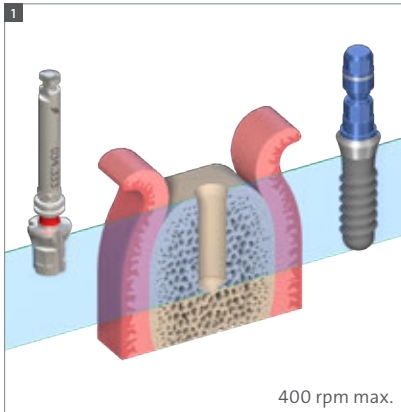

##### Step 1 – Standard Plus Profile Drill

Shape the coronal part of the implant bed with the Standard Plus Profile Drill.

Insert the Standard Plus Profile Drill up to the planned implant shoulder level.

**Note:** For Standard Implants, profile drilling is not required.

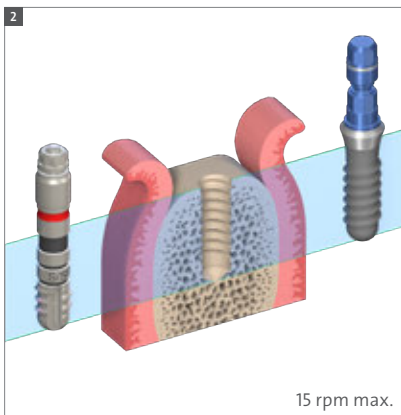

##### Step 2 – Tapping the thread in dense bone

Tap the implant bed with the S/SP Tap according to the endosteal diameter, in case of too high insertion torques.

Please note that Standard plus 4 mm Implants and NNC Implants require the corresponding diameter BL Taps.

## Straumann® Bone Level Implants

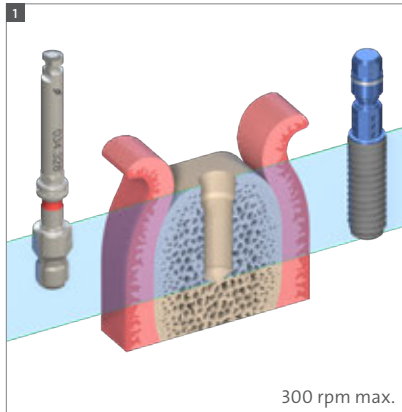

### Step 1 – Bone Level Profile Drill



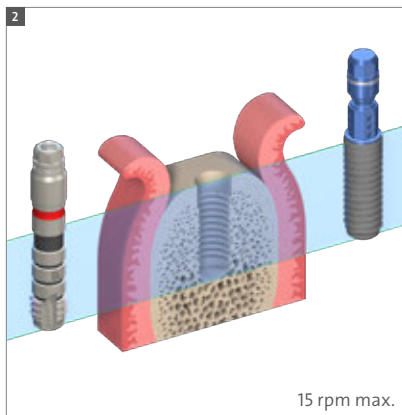









Prepare the implant bed with the Straumann® Bone Level Profile Drill. Insert the Profile Drill up to the planned implant shoulder level.



### Step 2 – Tapping the thread in dense bone

Tap the implant bed with the BL Tap according to the endosteal diameter, in case of too high insertion torques in dense bone.

The following table summarizes the use of Profile Drills and Taps for the fine implant bed preparation for all Straumann® implants.

Instrumentation for fine implant bed preparation					Straumann® Standard Implant			
								
Art. no.	Product	Max. rpm		Thread pitch	S Ø 3.3 RN	S Ø 4.1 RN	S Ø 4.8 RN	S Ø 4.8 WN
034.332	SP Profile Drill, short, Ø 3.3 mm, RN	400						
034.333	SP Profile Drill, short, Ø 4.1 mm, RN							
044.084	SP Profile Drill, short, Ø 4.8 mm, WN							
034.351	S/SP Tap, Ø 3.3 mm, for Adapter	15		1	●			
034.352	S/SP Tap, Ø 4.1 mm, for Adapter			1.25		●		
034.353	S/SP Tap, Ø 4.8 mm, for Adapter			1.25			●	●
034.327	BL/NNC Profile Drill, Ø 3.3 mm, short	300						
034.328	BL Profile Drill, Ø 4.1 mm, short							
034.329	BL Profile Drill, Ø 4.8 mm, short							
034.348	BL/NNC Tap, Ø 3.3 mm, for Adapter	15		0.8				
034.349	BL Tap, Ø 4.1 mm, for Adapter			0.8				
034.350	BL Tap, Ø 4.8 mm, for Adapter			0.8				

- Required step
- ◐ Recommended in case of high insertion torque

Straumann® Standard Plus Implant								Straumann® Bone Level Implant		
SP Ø 3.3 NNC	SP Ø 3.3 RN	SP Ø 4.1 RN		SP Ø 4.8 RN		SP Ø 4.8 WN		BL Ø 3.3 NC	BL Ø 4.1 RC	BL Ø 4.8 RC
	●									
		●	●							
				*	*	●	●			
	◐									
		◐								
				◐		◐				
●								●		
									●	
										●
◐								◐		
			◐						◐	
						◐				◐
							◐			◐

\* Due to the unflared neck portion, the Straumann® Standard Plus Ø 4.8 mm RN Implants are inserted without profile drilling.

## 4.2 Opening the implant package

Sterile barrier system: Blister



### Step 1 – Open the blister and remove the vial

**Note:** The blister ensures the sterility of the implant. Do not open the blister until immediately prior to implant placement.

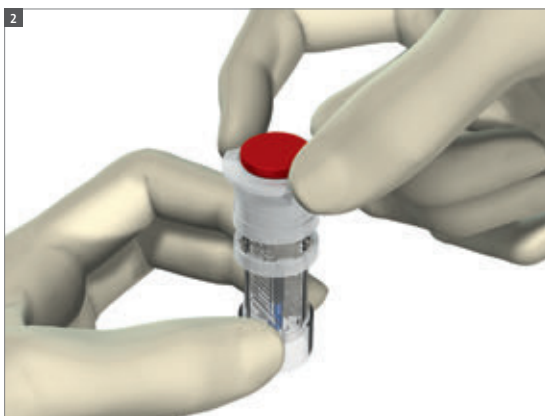

### Step 2 – Open the vial

Turn the lid in a counterclockwise direction.

**SLActive® only:** Keep the vial upright to prevent the liquid from flowing out.

**Note:** If the implant carrier is not firmly attached to the lid, screw in the lid once again.

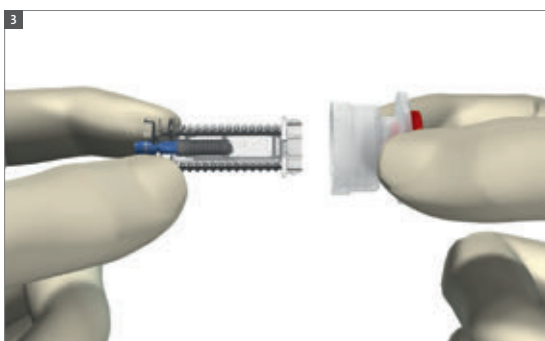

### Step 3 – Detach the implant carrier

Detach the implant carrier from the lid by pulling it off manually.

**Note (for SLActive® only):** After the implant is removed from the solution, the chemical activity of SLActive® is ensured for 15 minutes.

Sterile barrier system: Vial



**Step 1 – Open the safety cap**

Open the safety cap of the sterile vial.

**Note:** The vial ensures the sterility of the implant.



**Step 2 – Remove the implant from the carrier**

Simultaneously pull down the implant carrier and lift the implant out of the implant carrier (while keeping your arms steady).

### 4.3 Placing the implant

A Straumann® implant can be placed either manually with the Ratchet or with the aid of the Handpiece. A maximum speed of 15 rpm is recommended. The following step-by-step instructions show how a Straumann® Bone Level Implant is placed with the Handpiece (left column on the following pages) and how a Straumann® Standard Plus Implant is placed with the Ratchet (right column).

#### Implant placement with Handpiece

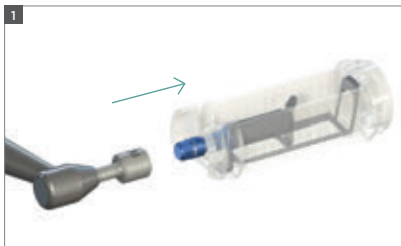

**Step 1 – Attach the Handpiece Adapter**  
Hold the enclosed part of the implant carrier. Attach the Handpiece Adapter. A click will be heard when the Adapter is attached correctly.

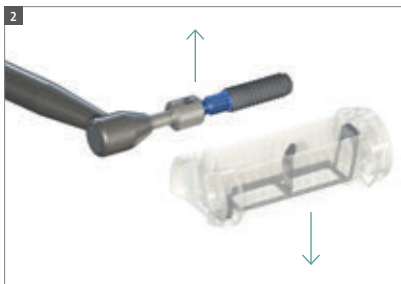

**Step 2 – Remove the implant from the carrier**  
Simultaneously pull down the implant carrier and lift the implant out of the implant carrier (keep your arms steady).

#### Implant placement with Ratchet

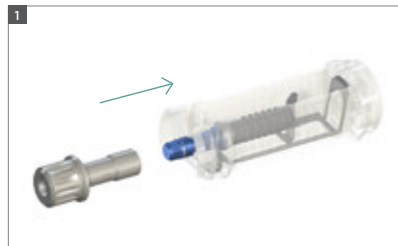

**Step 1 – Attach the Ratchet Adapter**  
Hold the enclosed part of the implant carrier. Attach the Ratchet Adapter. A click will be heard when the Adapter is attached correctly.



**Step 2 – Remove the implant from the carrier**  
Simultaneously pull down the implant carrier and lift the implant out of the implant carrier (keep your arms steady).



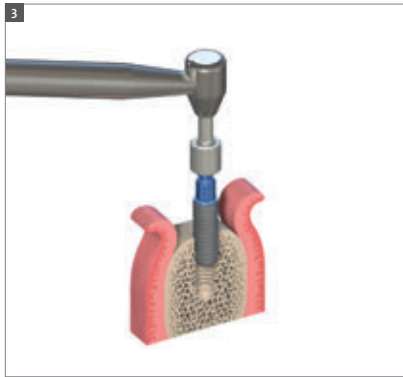

### Step 3 – Place the implant

Place the implant with the Handpiece into the implant bed. Move the implant into its final position with a maximum of 15rpm turning it clockwise.

**Caution:** Vertical position corrections using reverse rotations (counterclockwise) may lead to a decrease in primary stability.

**Caution:** An insertion torque of 35 Ncm is recommended. If 35 Ncm is achieved before the implant has assumed its final position, check that the implant bed preparation is correct to avoid bone overcompression.

The Loxim® is provided with a pre-determined breaking point to prevent damage to the inner configuration of the implant, thus ensuring the integrity of the interface for mounting the prosthesis.

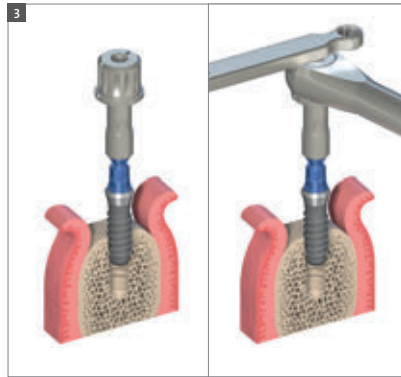

### Step 3 – Place the implant

Place the implant with the Ratchet into the implant bed. Move the implant into its final position with a maximum of 15rpm turning it clockwise.

**Caution:** Vertical position corrections using reverse rotations (counterclockwise) may lead to a decrease in primary stability.

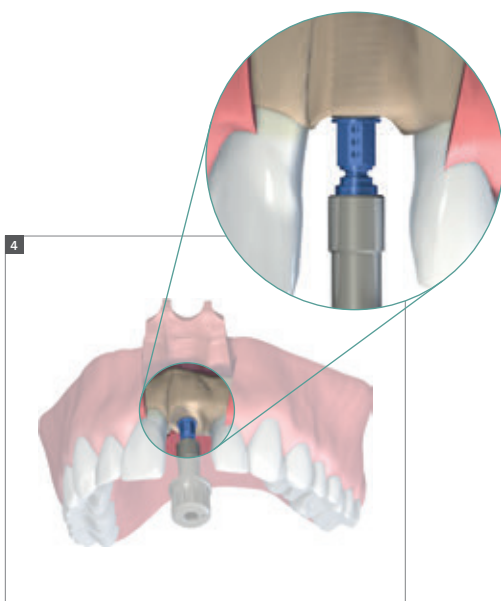

### Step 4 – Correct implant orientation for Straumann® implants with CrossFit® connection

While approaching the final implant position, make sure that the drilled holes on the blue transfer part are oriented exactly orofacially. This positions the four protrusions of the internal connection for ideal prosthetic abutment orientation. A quarter turn to the next drilled hole corresponds to a vertical displacement of 0.2mm. The drilled holes also show the depth of the implant shoulder in the bone.

**Caution:** Avoid vertical position corrections using reverse rotations (counterclockwise). This can cause loosening of the transfer part and may lead to a decrease in primary stability.

## Additional information for implants with the Loxim® Transfer Piece

### Release aid for the Loxim® Transfer Piece

For situations in which any removal force is to be avoided, a release aid for the Loxim® can be used. Place the release aid onto the implant shoulder and hold it in place while detaching the Adapter with the Loxim®.



Release aid S for Loxim® (for SC), 026.0073



Release aid N for Loxim® (for NNC and NC), 026.2558



Release aid R/W for Loxim® (for RC, RN and WN), 026.4558

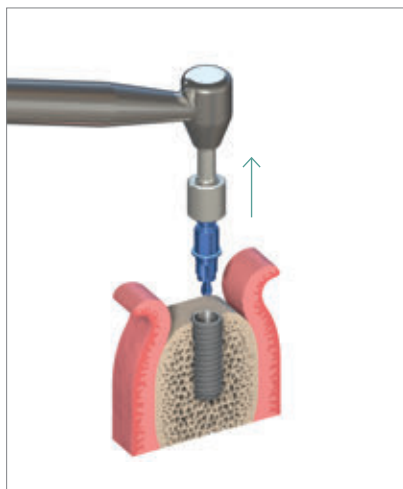
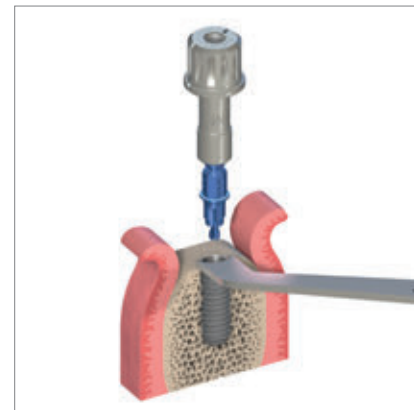

### Step 5 – Remove the instruments with Loxim®

Loxim® can easily be re-inserted to finish an uncompleted implant placement until the implant is fully inserted. If the implant needs to be removed during implantation surgery, Loxim® allows for counterclockwise turns.

After insertion, the Loxim® is detached with the Adapter.

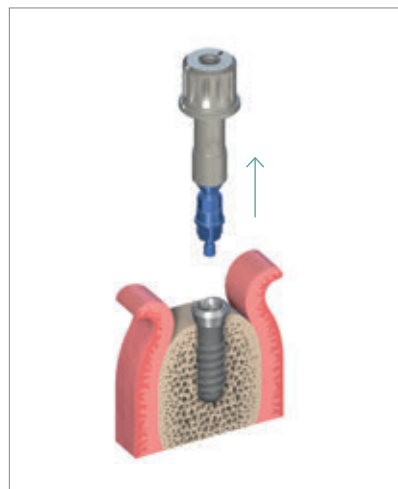

### Step 5 – Remove the instruments with Loxim®

Loxim® can easily be re-inserted to finish an uncompleted implant placement until the implant is fully inserted. If the implant needs to be removed during implantation surgery, Loxim® allows for counterclockwise turns.

Remove the Ratchet while holding the Adapter at the bottom, and then detach the Adapter-Loxim® assembly.

**Important additional information**

An insertion torque of 35Ncm is recommended. If 35Ncm is achieved before the implant has reached its final position, make sure the implant bed preparation is correct to avoid bone overcompression.

**Warning:** If the implant has to be removed after implant placement, the retention of the Loxim® in the implant may be reduced. Always secure the implant against aspiration when removing the implant.

The Loxim® is provided with a pre-determined breaking point to prevent damage to the implant's inner configuration, thus ensuring the integrity of the interface to mount the prosthesis. If the Loxim® breaks during implant insertion, one part remains in the Adapter and the other part in the implant. Both parts can be removed with tweezers.

To extract the implant after breakage at the pre-determined breaking point, simply take out the broken part of the Loxim® from the Adapter and re-insert the Adapter on the Loxim® part remaining in the implant. Counterclockwise turns will remove the implant.

The part of the Loxim® below the pre-determined breaking point is not secured in the Adapter and, additionally, needs to be secured against aspiration when taking out the implant.

**Caution:** The broken part of the Loxim® no longer protects against high torque. Therefore, it is not to be used to advance the placement of the implant.



## 4.4 Soft tissue management

After implantation, the implant is closed – hand-tightened – with an SCS Closure Screw, Healing Cap or Healing Abutment to protect the implant (for SCS Screwdrivers see Chapter 6.1.8). The surgeon can choose between submucosal and transmucosal healing and has many options available for soft tissue management through a set of secondary healing components.

### 4.4.1 Submucosal healing

For submucosal healing (healing under closed mucoperiosteal flap) the use of a Closure Screw, shorter Healing Cap or Healing Abutment is recommended. Submucosal healing is suggested in esthetic indications and for implantations with simultaneous guided bone restoration (GBR) or membrane technique. A second surgical procedure is required for uncovering the implant and inserting the desired secondary component.

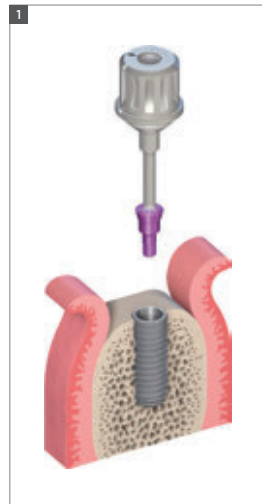
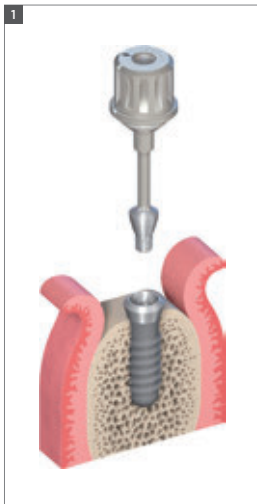

#### Step 1 – Inserting the Closure Screw after first surgery

Ensure that the internal configuration of the implant is clean and bloodless.

Pick up the Closure Screw with the SCS Screwdriver. The friction fit will secure the Closure Screw to the instrument during insertion and will allow safe handling.

Hand-tighten the Closure Screw. The design will provide a tight connection between the two components.

**Note:** All Closure Screws are delivered sterile and ready to use.

Subsequent loosening is made easier by applying chlorhexidine gel or sterile Vaseline® to the Closure Screw before it is screwed into the implant.



#### Step 2 – Wound closure

Adapt the mucoperiosteal flaps carefully and suture together with interrupted sutures.

Make sure a tight seal is formed over the implant.



**Step 3 – Reopening and removal: second surgery**

Locate the implant.

Make a small crestal incision down to the Closure Screw.

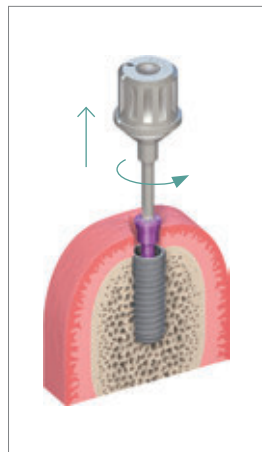
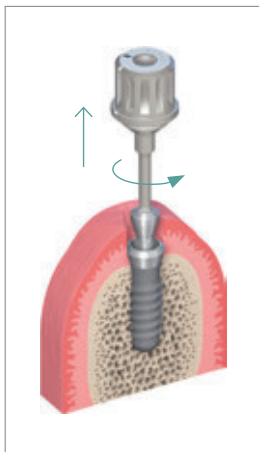

Spread the flap slightly and remove the Closure Screw with the SCS Screwdriver.

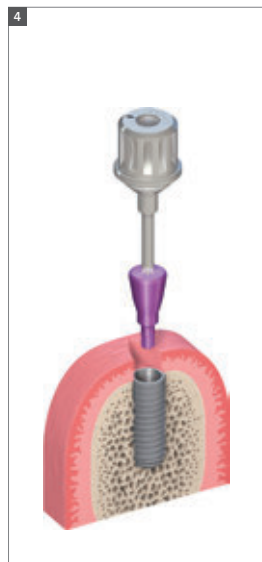
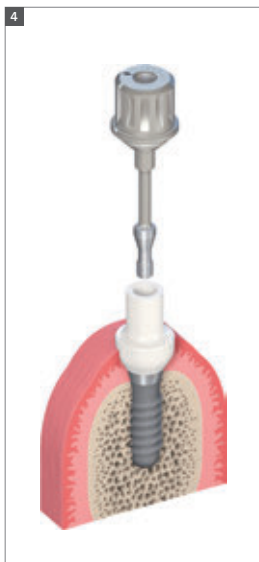

**Step 4 – Insertion and wound closure**

Rinse the exposed internal connection of the implant thoroughly with sterile saline solution.

Insert a suitable secondary component.

Adapt the soft tissue and suture it back tightly without tension around the secondary component.

#### 4.4.2 Transmucosal healing

A versatile portfolio of Healing Caps and Healing Abutments is available for all Straumann® implants, enabling soft-tissue sculpturing during transmucosal healing. They are recommended for intermediate use. After the soft-tissue healing phase they are replaced with the appropriate temporary or final restoration.

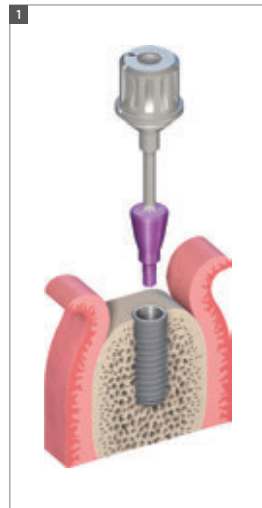
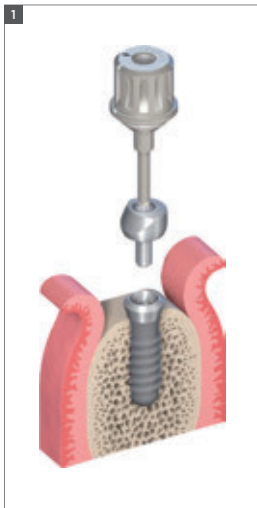

##### Step 1 – Insertion

Ensure that the internal configuration of the implant is clean and bloodless.

Insert the Healing Cap or Healing Abutment with the SCS Screwdriver. The friction fit secures the components to the instrument during insertion and ensures safe handling.

Hand-tighten the Healing Cap or Healing Abutment. The design will provide a tight connection between the two components.

Subsequent loosening is made easier by applying chlorhexidine gel or sterile Vaseline® to the Healing Cap or Healing Abutment before they are screwed into the implant.



##### Step 2 – Wound closure

Adapt the soft tissue and suture it back tightly around the abutment.

# 5. Healing Phase

## 5.1 Healing phase duration

For the delayed loading surgical protocol, it is recommended to follow the healing time durations as indicated below:

Situation	Healing phase	
	SActive®	SLA®
<ul style="list-style-type: none"> <li>• Good bone quality and adequate bone quantity</li> <li>• Implants with a diameter of 4.1 mm or 4.8 mm and a Straumann® SActive®/SLA® surface length of ≥ 8 mm</li> </ul>	At least 3–4 weeks	At least 6 weeks
<ul style="list-style-type: none"> <li>• Cancellous bone quality</li> <li>• Implants with a diameter of 2.9 mm</li> <li>• Implants with a diameter of 3.3 mm</li> <li>• Implants with a Straumann® SActive®/SLA® surface length of 6 mm</li> </ul>	At least 8 weeks	At least 12 weeks
<ul style="list-style-type: none"> <li>• Straumann® Standard Plus Short Implant</li> </ul>	10–12 weeks	n. a.
<ul style="list-style-type: none"> <li>• Straumann® SActive®/SLA® surface is not completely in contact with the bone</li> <li>• Bone augmentation measures* are necessary</li> </ul>	Healing phase corresponding to the situation	

*\*This technique should be employed only by dentists who have adequate experience in the use of augmentation procedures.*

# 6. Additional Information on Instruments

## 6.1 Surgical instruments

Instruments must be checked for completeness and function. An adequate stock of implants and spare sterile instruments should always be available. The instruments must be disassembled for sterilization. Well-maintained instruments prevent infections from developing that could endanger both the patients and the practice team.

To avoid contamination of the operation field, all the instruments and materials employed must be sterile. To prevent contamination of the sterile instruments, they should be removed from the Surgical Cassette with the sterile Instrument Tweezers and put into the handle or Ratchet. The Instrument Tweezers (art. no. 046.110) were developed and shaped specially to allow round instruments to be gripped securely.

All steps related to the maintenance of Straumann® surgical instruments are part of a dental practice hygiene plan (see also *Straumann® Surgical and Prosthetic Instruments, Care and Maintenance* (702000/en)).

### 6.1.1 Depth marks on Straumann® instruments

Straumann® instruments have depth marks in 2 mm intervals that correspond to the available implant lengths. The marks on drills are continuous between 10 mm and 12 mm. The lower edge of the mark corresponds to 10 mm and the upper edge to 12 mm.

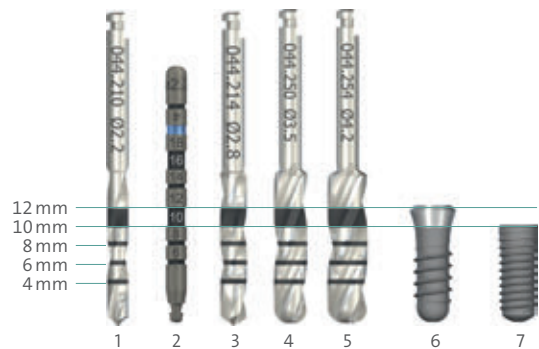
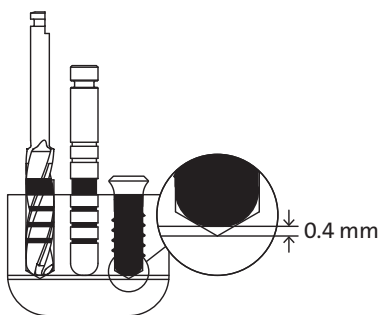

1. Pilot Drill 1,  $\varnothing$  2.2 mm
2. Alignment Pin,  $\varnothing$  2.2 mm
3. Pilot Drill 2,  $\varnothing$  2.8 mm
4. Twist Drill PRO,  $\varnothing$  3.5 mm
5. Twist Drill PRO,  $\varnothing$  4.2 mm
6. Straumann® Standard Plus Implant,  $\varnothing$  4.1 RN, length 10 mm
7. Straumann® Bone Level Implant,  $\varnothing$  4.1 RC, length 10 mm

**Warning:** Due to the function and design of the drills, the drill tip is 0.4 mm longer than the insertion depth of the implant.



### 6.1.2 Single-patient Drills

Single-patient drills are indicated for the preparation of the implant bed for Straumann® dental implants. They are supplied sterile and are to be used for one operation only and for one patient only. Single-patient drills can minimize the risk of infection for the patient.

For more information, please refer to *Straumann® Single-patient Instruments, Surgical User Guide* (702173/en).

### 6.1.3 Straumann® Drill Stop – Precise depth control

The Straumann® Drill Stop provides precise control over drilling depth during implant bed preparation for the placement of Straumann® dental implants. Delivered in sterile sets, the Drill Stops are ready to use. The Straumann® Drill Stop is designed for single-patient use only and must be used in conjunction with the single-patient drills specifically designed for them.

**Note:** Straumann® Drill Stops are not indicated for:

- Extraction sites, where the bone cavity is often wider than the diameter necessary to hold the Drill Stop.
- Use with drill templates, due to the interference with the template.

For more information, please refer to *Straumann® Drill Stop, Basic Information* (702874/en).

#### 6.1.4 Straumann® Modular Cassette

The Straumann® Modular Cassette is used for the secure storage and reprocessing of surgical and auxiliary instruments of the Straumann® Dental Implant System. The Straumann® Modular Cassette works with any Straumann® implant line, including with the Straumann® Guided Surgery workflow.



For information on how to equip the Cassette, please see the brochure *Straumann® Modular Cassette Selection Guide* (702824/en).

For more technical information, please see the brochure *Straumann® Modular Cassette - Basic Information* (702527/en).

### 6.1.5 Ratchet

#### Ratchet

The Ratchet (art. no. 046.119) of the Straumann® Dental Implant System is a two-part lever arm instrument with a rotary knob for changing the direction of force.

The Ratchet is required for the following operations:

- Manual thread tapping
- Manual placement of implants into their final position in the implant bed
- Manual screwing of healing caps and closure screws\*.
- Screwing of abutments and occlusal screws\*.

\*Combined with the torque control device for defined torque



#### Service Instrument

The Ratchet is supplied with a Service Instrument, which is used to loosen or tighten the retaining screw.



#### Ratchet disassembled

After loosening, the Ratchet bolt can be removed from the body of the Ratchet. It must be disassembled for cleaning and sterilization.

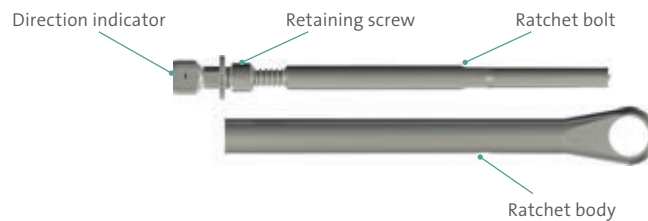

### 6.1.6 Torque Control Device

The Torque Control Device (art. no. 046.049) is an instrument for determining the torque applied to various screw connections. A specific force/torque (Ncm) is transferred to the screw connection by means of a torque bar mounted on the ratchet. A calibration mark shows the measured tightening torque.

If the torque bar is aligned with the zero mark at rest, the precision of the displayed tightening torque is within  $\pm 2$  Ncm. The torque bar must not be bent beyond the calibration mark on the scale, otherwise the precision can no longer be guaranteed or the bar may break.

Recommended torque values are defined by optimal conditions for the specific screw connections of the Straumann® System. The individual clinical situation (bone quality, implant length, implant type, implant surface, time of application of force, etc.) also has to be considered apart from the recommended torque values.

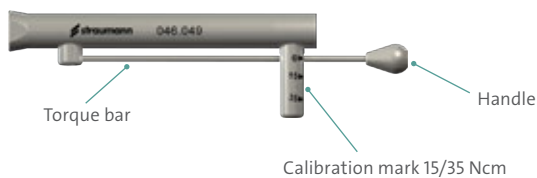

Assembled Torque Control Device and Ratchet

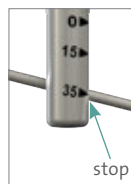

Maximum torque - reference mark on the scale

#### Recommendations for correct torque with the Straumann® Dental Implant System

Connection	Recommended torque
Abutment (incl. angled abutments)	35 Ncm
Closure screws	15 Ncm
Healing caps	15 Ncm
Occlusal screws	15 Ncm

#### Bone graft System

Connection	Recommended torque
Basal screw	35 Ncm
Mucosa cylinder	35 Ncm
Bone graft abutment	15 Ncm



### 6.1.7 Holding Key

The Holding Key can be used to stabilize the Ratchet.



### Stabilizing the Ratchet

Use the pivot of the Holding Key to stabilize the Ratchet during implant insertion or during tapping.

### 6.1.8 SCS Screwdriver and AS Screwdriver



SCS Screwdriver for ratchet  
extra-short (15 mm),  
short (21 mm), long (27 mm)



SCS Screwdriver for handpiece  
extra-short (20 mm),  
short (26 mm), long (32 mm)



AS Screwdriver for ratchet  
extra-short (15 mm),  
short (21 mm), long (27 mm)



AS Screwdriver for handpiece  
extra-short (20 mm),  
short (26 mm), long (32 mm)

**Note:** All the AS (Angled Solution) components are identified via a green color coding. Please note that the SCS and AS components are not intercompatible.

## 6.2 Osteotomes

### 6.2.1 Instrument set for bone condensation

- Indicated in cases with cancellous bone (bone classes 3 and 4).
- Reinforces bone radially to give improved primary stability to the implant.
- Before the instruments are used, it is advisable to mount the depth stops in order not to exceed the pre-determined working depth. These are mounted onto the instrument using an SCS screwdriver.
- Instruments of increasing diameter are introduced manually using gentle rotary movements or, if necessary, lightly tapping with a hammer in accordance with the desired implant length and implant diameter.
- Insert the implant carefully without applying extra force.

**Note:** The instruments with diameters of 2.2 mm, 2.8 mm, 3.5 mm and 4.2 mm match the implant diameters of the Straumann® Dental Implant System. They are available as straight or angled models, which facilitates access in the posterior region.



Osteotomes for bone condensation

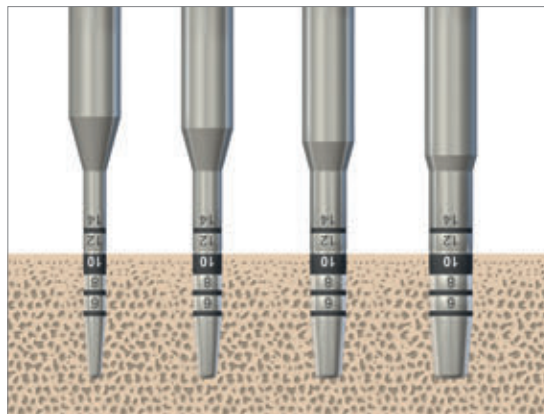

Insert Osteotomes to the desired implant length using gentle rotary movements.

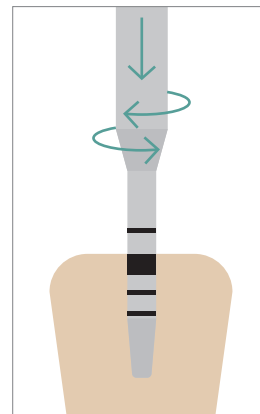

### 6.2.2 Instrument set for transalveolar sinus floor elevation

Indicated in cases with inadequate vertical bone. By tapping on the osteotomes with a mallet, the sinus floor can be fractured and elevated.

- The bone is prepared using the twist drills ( $\varnothing$  2.2 mm/2.8 mm/3.5 mm/4.2 mm) in accordance with the desired implant diameter. The surgeon feels his or her way very carefully down to the cortical bone of the sinus floor (minimum distance 1 mm). This process requires precise radiological planning.
- Before the instruments are used, it is advisable to mount the depth stops in order not to exceed the pre-determined working depth. These are mounted onto the instrument using an SCS screwdriver.
- First, the sinus floor is fractured, which requires precise radiological planning. The use of depth stops is also recommended in order not to exceed the pre-determined working depth. The instrument is introduced by lightly tapping with a hammer in accordance with the desired implant length.
- During elevation, autologous and/or alloplastic filling or bone material should also be applied to the implant bed. The material introduced acts like a cushion, lifting the mucous membrane in accordance with the principles of hydraulics.
- Insert the implant carefully without applying extra force.

**Note:** The instruments with diameters of 2.2 mm, 2.8 mm, 3.5 mm and 4.2 mm match the implant diameters of the Straumann® Dental Implant System. They are available as straight or angled models, which facilitates access in the posterior region.



Osteotomes for sinus floor elevation

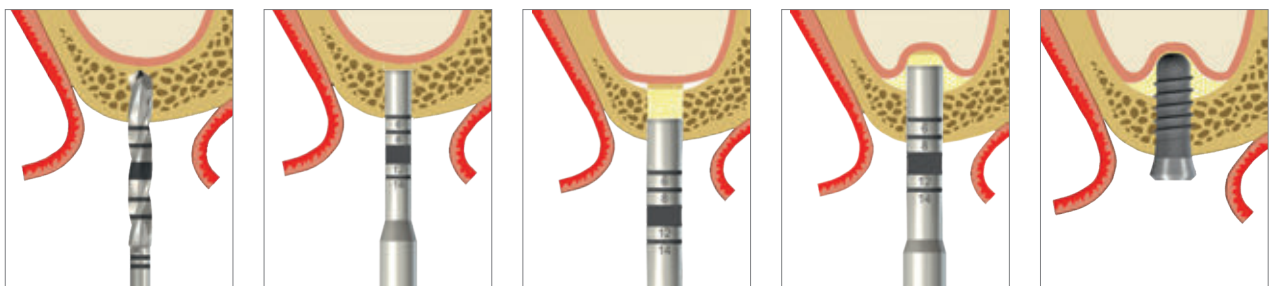

### 6.2.3 Depth stops for osteotomes

All osteotomes have clear laser marks for depths of 6 mm, 8 mm, 10 mm, 12 mm and 14 mm. In addition, adjustable depth stops facilitate depth checking.



Depth stops for osteotomes

### 6.3 Cleaning and care of instruments

Careful treatment of all instruments is of the utmost importance. Even slight damage, for instance to the drill tips (e.g., when the drills are “thrown” into a metal bowl) impairs cutting performance and thus the clinical result. With correct and careful care, the high quality of the material and excellent workmanship ensure that the cutting instruments (drills, taps etc.) can be used repeatedly (up to a maximum of ten times is recommended). The *Surgery Tracking Sheet for Straumann Cutting Instruments* (152.755/en). helps to give an overview of how often the individual instruments have already been used.

Instruments with high cutting performance are a basic requirement for successful implantation. The following should therefore be remembered:

- Never allow instruments to land on their tips.
- Use each instrument only for its intended purpose.
- Never let surgical residues (blood, secretion, tissue residues) dry on an instrument; clean immediately after surgery.
- Thoroughly clean off incrustations with soft brushes only. Disassemble instruments, clean cavities especially well.
- Never disinfect, clean (also ultrasound) or sterilize instruments made of different materials together.
- Use only cleaning agents and disinfectants intended for the material and follow the instructions for use of the manufacturer.
- Rinse disinfectants and cleaning agents very thoroughly with water.
- Never leave or store instruments moist or wet.

You will find detailed information in the brochure *Straumann® Surgical and Prosthetic Instruments, Care and Maintenance* (702000/en).



# 7. Appendix

## 7.1 Related documentation

**Note:** Our detailed documentation will help you in carefully planning and performing your implant-based restorations:

- *Prosthetic Procedures for the Narrow Neck CrossFit® Implant – Straumann® Narrow Neck CrossFit® Implant Line* (702058/en)
- *Straumann® synOcta® Prosthetic System, Basic Information* (702163/en)
- *Cement-retained Crowns and Bridges with the Solid Abutment System: Straumann® Solid Abutment Prosthetic System* (152.254/en)
- *Straumann® Bone Level Prosthetic Procedures, Basic Information* (702061/en)

### Instrument care and maintenance

- Well maintained instruments are a basic requirement for successful treatment. You will find detailed information in the brochure *Straumann® Surgical and Prosthetic Instruments, Care and Maintenance* (702000/en).

### The Straumann® Guarantee

- As a Swiss company, we attach the greatest importance to manufacturing products of the highest quality. The Straumann® Guarantee regulates replacement of all components of the Straumann® Dental Implant System. You will find detailed information in the brochure *Straumann® Guarantee* (152.360/en).

### Explanation

- For explanation guidelines please refer to *Guidance for Implant Removal, Basic Information* (702085/en). The components required for explanation can be found in our current product catalog.

### References

The Straumann® Dental Implant System has been comprehensively clinically documented. You can find references to the current research literature on our website [www.straumann.com](http://www.straumann.com) or by contacting your local Straumann representative.

### Courses and training

Continuing education ensures long-term success! Please ask your Straumann representative directly for information on the Straumann® Dental Implant System courses and training. Further information at [www.straumann.com](http://www.straumann.com).

## 7.2 Important guidelines

### **Please note**

Practitioners must have appropriate knowledge and instruction in the handling of the Straumann CAD/CAM products or other Straumann products ("Straumann Products") for using the Straumann Products safely and properly in accordance with the instructions for use.

The Straumann Product must be used in accordance with the instructions for use provided by the manufacturer. It is the practitioner's responsibility to use the device in accordance with these instructions for use and to determine whether the device fits the patient's individual situation.

The Straumann Products are part of an overall concept and must be used only in conjunction with the corresponding original components and instruments distributed by Institut Straumann AG, its ultimate parent company and all affiliates or subsidiaries of such parent company ("Straumann"), except if stated otherwise in this document or in the instructions for use for the respective Straumann Product. If use of products made by third parties is not recommended by Straumann in this document or in the respective instructions for use, any such use will void any warranty or other obligation, express or implied, of Straumann.

### **Availability**

Some of the Straumann Products listed in this document may not be available in all countries.

### **Caution**

In addition to the caution notes in this document, our products must be secured against aspiration when used intraorally.

### **Validity**

Upon publication of this document, all previous versions are superseded.

### **Documentation**

For detailed instructions on the Straumann Products contact your Straumann representative.

### **Copyright and trademarks**

Straumann® documents may not be reprinted or published, in whole or in part, without the written authorization of Straumann.

Straumann® and/or other trademarks and logos from Straumann® mentioned herein are the trademarks or registered trademarks of Straumann Holding AG and/or its affiliates.



1 Bernhard N et al. (2009): The Binary TiZr Alloy – A newly developed Ti Alloy for use in dental implants; *Forum Implantologicum* 5(30) 2 Medvedev et al. (2016): Microstructure and mechanical properties of Ti-15Zr alloy used as dental implant material; *J. Mech. Behav. Biomed. Mater.* 2016 Sep; 62:384-98. doi: 10.1016/j.jmbbm.2016.05.008. epub 2016 May 11 3 Gottlow J et al. (2012): Evaluation of a new Titanium-Zirconium dental implant: a biomechanical and histological comparative study in the mini pig; *Clin. Implant Dent. Relat. Res.* 14 Suppl. 1:e204-e212 4 Thoma et al. (2011): Tissue integration of a new Titanium-Zirconium dental implant: a comparative histologic and radiographic study in the canine; *J. Periodontol.* 2011 Oct; 82(10):1453-61. doi 10.1902/jop.2010.100737 5 Wen et al. (2014): The osseointegration behavior of Titanium-Zirconium implants in ovariectomized rabbits; *Clin. Oral Implants Res.* 2014 Jul; 25(7):819-25. doi: 10.1111/clr.12141. epub 2013 Feb 21 6 Nelson K (2016): Rehabilitation of irradiated patients with chemically modified and conventional SLA implants: a clinical clarification; *J Oral Rehabil*; 43: 871–872. doi:10.1111/joor.12434 7 Heberer S et al. (2011): Rehabilitation of irradiated patients with modified and conventional sandblasted, acid-etched implants: preliminary results of a split-mouth study; *Clin. Oral Impl. Res.* 22, 2011; 546-551 8 Cabrera-Domínguez JJ et al. Clinical performance of titanium-zirconium implants with a hydrophilic surface in patients with controlled type 2 diabetes mellitus: 2-year results from a prospective case-control clinical study *Clin Oral Investig* 2020 Jul;24(7):2477-2486 9 Alsahhap A et al. Survival of Titanium-Zirconium and Titanium Dental Implants in Cigarette-smokers and Never-smokers: A 5-Year Follow-up *Chin J Dent Res.* 2019;22(4):265-272 10 Lang, N. P., G. E. Salvi, G. Huynh-Ba, S. Ivanovski, N. Donos and D. D. Bosshardt (2011). "Early osseointegration to hydrophilic and hydrophobic implant surfaces in humans." *Clin Oral Implants Res* 22(4): 349-356. 11 Oates, T. W., P. Valderrama, M. Bischof, R. Nedir, A. Jones, J. Simpson, H. Toutenburg and D. L. Cochran (2007). "Enhanced implant stability with a chemically modified SLA surface: a randomized pilot study." *Int J Oral Maxillofac Implants* 22(5): 755-760. 12 Nicolau, P., F. Guerra, R. Reis, T. Krafft, K. Benz and J. Jackowski (2019). "10-year outcomes with immediate and early loaded implants with a chemically modified SLA surface." *Quintessence Int* 50(2): 114-124. 13 Reis, R., P. Nicolau, N. Calha, A. Messias and F. Guerra (2019). "Immediate versus early loading protocols of titanium-zirconium narrow-diameter implants for mandibular overdentures in edentulous patients: 1-year results from a randomized controlled trial." *Clin Oral Implants Res* 30(10): 953-961. 14 Eckert, S. E., G. Hueler, N. Sandler, R. Elkattah and D. C. McNeil (2019). "Immediately Loaded Fixed Full-Arch Implant-Retained Prosthesis: Clinical Analysis When Using a Moderate Insertion Torque." *Int J Oral Maxillofac Implants* 34(3): 737-744. 15 Kuchler U, Chappuis V, Bornstein MM, Siewczyk M, Gruber R, Maestre L, Buser D. Development of Implant Stability Quotient values of implants placed with simultaneous sinus floor elevation – results of a prospective study with 109 implants. *Clin. Oral Impl. Res.* 28, 2017, 109–115. 16 El Chaar E, Zhang L, Zhou Y, et al. Osseointegration of Superhydrophilic Implants Placed in Defect Grafted Bones. *International Journal of Oral & Maxillofacial Implants*. Mar/Apr2019, Vol. 34 Issue 2, p443-450 17 Schwarz, F., et al., Bone regeneration in dehiscence-type defects at chemically modified (SLActive®) and conventional SLA® titanium implants: a pilot study in dogs. *J Clin.Periodontol.* 34.1 (2007): 78–86

## International Headquarters

Institut Straumann AG  
Peter Merian-Weg 12  
CH-4002 Basel, Switzerland  
Phone +41 (0)61 965 11 11  
Fax +41 (0)61 965 11 01  
[www.straumann.com](http://www.straumann.com)

Vaseline® is a registered trademark of Unilever N.V., NL.

© Institut Straumann AG, 2022. All rights reserved.

Straumann® and/or other trademarks and logos from Straumann® mentioned herein are the trademarks or registered trademarks of Straumann Holding AG and/or its affiliates.