

Structural use of concrete —

Part 1: Code of practice for design and construction

ICS 91.080.40

Committees responsible for this British Standard

The preparation of this British Standard was entrusted by Technical Committee B/525, Building and civil engineering structures, to Subcommittee B/525/2, Structural use of concrete, upon which the following bodies were represented:

Association of Consulting Engineers
 British Cement Association
 British Precast Concrete Federation Ltd.
 Concrete Society
 Department of the Environment (Building Research Establishment)
 Department of the Environment (Property and Buildings Directorate)
 Department of Transport (Highways Agency)
 Federation of Civil Engineering Contractors
 Institution of Civil Engineers
 Institution of Structural Engineers
 Steel Reinforcement Commission

This British Standard, having been prepared under the direction of the Sector Board for Building and Civil Engineering, was published under the authority of the Standards Board and comes into effect on 15 March 1997

© BSI 06-1999

First published August 1985
 Second edition March 1997

The following BSI references relate to the work on this standard:
 Committee reference B/525/2
 Draft for comment 95/105430 DC

ISBN 0 580 26208 1

Amendments issued since publication

Amd. No.	Date	Comments
9882	September 1998	Indicated by a sideline in the margin

Contents

	Page
Committees responsible	Inside front cover
Foreword	v
<hr/>	
Section 1. General	
1.1 Scope	1
1.2 References	1
1.3 Definitions	1
1.4 Symbols	3
<hr/>	
Section 2. Design objectives and general recommendations	
2.1 Basis of design	4
2.2 Structural design	4
2.3 Inspection of construction	6
2.4 Loads and material properties	7
2.5 Analysis	10
2.6 Designs based on tests	11
<hr/>	
Section 3. Design and detailing: reinforced concrete	
3.1 Design basis and strength of materials	13
3.2 Structures and structural frames	15
3.3 Concrete cover to reinforcement	18
3.4 Beams	23
3.5 Solid slabs supported by beams or walls	33
3.6 Ribbed slabs (with solid or hollow blocks or voids)	42
3.7 Flat slabs	45
3.8 Columns	59
3.9 Walls	66
3.10 Staircases	71
3.11 Bases	72
3.12 Considerations affecting design details	74
<hr/>	
Section 4. Design and detailing: prestressed concrete	
4.1 Design basis	90
4.2 Structures and structural frames	91
4.3 Beams	91
4.4 Slabs	99
4.5 Columns	99
4.6 Tension members	99
4.7 Prestressing	99
4.8 Loss of prestress, other than friction losses	99
4.9 Loss of prestress due to friction	101
4.10 Transmission lengths in pre-tensioned members	103
4.11 End blocks in post-tensioned members	103
4.12 Considerations affecting design details	104
<hr/>	
Section 5. Design and detailing: precast and composite construction	
5.1 Design basis and stability provisions	110
5.2 Precast concrete construction	111
5.3 Structural connections between precast units	116
5.4 Composite concrete construction	119
<hr/>	
Section 6. Concrete, materials, specification and construction	
6.1 Materials and specification	123
6.2 Concrete construction	123

	Page
Section 7. Specification and workmanship: reinforcement	
7.1 General	135
7.2 Cutting and bending	135
7.3 Fixing	135
7.4 Surface condition	136
7.5 Laps and joints	136
7.6 Welding	136
<hr/>	
Section 8. Specification and workmanship: prestressing tendons	
8.1 General	138
8.2 Handling and storage	138
8.3 Surface condition	138
8.4 Straightness	138
8.5 Cutting	138
8.6 Positioning of tendons and sheaths	139
8.7 Tensioning the tendons	139
8.8 Protection and bond of prestressing tendons	141
8.9 Grouting of prestressing tendons	142
<hr/>	
Annex A (informative) Grouting of prestressing tendons	143
<hr/>	
Index	146
<hr/>	
Figure 2.1 — Short term design stress-strain curve for normal-weight concrete	11
Figure 2.2 — Short term design stress-strain curve for reinforcement	12
Figure 2.3 — Short term design stress-strain curve for prestressing tendons	12
Figure 3.1 — Flow chart of design procedure	17
Figure 3.2 — Minimum dimensions of reinforced concrete members for fire resistance	22
Figure 3.3 — Simplified stress block for concrete at ultimate limit state	25
Figure 3.4 — System of bent-up bars	29
Figure 3.5 — Shear failure near supports	29
Figure 3.6 — Effective width of solid slab carrying a concentrated load near an unsupported edge	34
Figure 3.7 — Definition of panels and bays	34
Figure 3.8 — Explanation of the derivation of the coefficient of Table 3.14	39
Figure 3.9 — Division of slab into middle and edge strips	39
Figure 3.10 — Distribution of load on a beam supporting a two-way spanning slab	41
Figure 3.11 — Types of column head	47
Figure 3.12 — Division of panels in flat slabs	49
Figure 3.13 — Definition of breadth of effective moment transfer strip b_e for various typical cases	53
Figure 3.14 — Shear at slab-column connection	54
Figure 3.15 — Application of 3.7.6.2 and 3.7.6.3	55
Figure 3.16 — Definition of a shear perimeter for typical cases	56
Figure 3.17 — Zones for punching shear reinforcement	57
Figure 3.18 — Shear perimeter of slabs with openings	58
Figure 3.19 — Shear perimeters with loads close to free edge	58
Figure 3.20 — Braced slender columns	63

	Page
Figure 3.21 — Unbraced slender columns	64
Figure 3.22 — Biaxially bent column	66
Figure 3.23 — Critical section for shear check in a pile cap	75
Figure 3.24 — Simplified detailing rules for beams	86
Figure 3.25 — Simplified detailing rules for slabs	87
Figure 5.1 — Continuity of ties: bars in precast member lapped with bar in in situ concrete	111
Figure 5.2 — Continuity of ties: anchorage by enclosing links	112
Figure 5.3 — Continuity of ties: bars lapped within in situ concrete	112
Figure 5.4 — Schematic arrangement of allowance for bearing	114
Table 2.1 — Load combinations and values of γ_f for the ultimate limit state	8
Table 2.2 — Values of γ_m for the ultimate limit state	9
Table 3.1 — Strength of reinforcement	15
Table 3.2 — Classification of exposure conditions	20
Table 3.3 — Nominal cover to all reinforcement (including links) to meet durability requirements	21
Table 3.4 — Nominal cover to all reinforcement (including links) to meet specified periods fire resistance	21
Table 3.5 — Design ultimate bending moments and shear forces	24
Table 3.6 — Values of the factor β_f	25
Table 3.7 — Form and area of shear reinforcement in beams	28
Table 3.8 — Values of v_c design concrete shear stress	28
Table 3.9 — Basic span/effective depth ratio for rectangular or flanged beams	31
Table 3.10 — Modification factor for tension reinforcement	32
Table 3.11 — Modification factor for compression reinforcement	32
Table 3.12 — Ultimate bending moment and shear forces in one-way spanning slabs	35
Table 3.13 — Bending moment coefficients for slabs spanning in two directions at right-angles, simply-supported on four sides	37
Table 3.14 — Bending moment coefficients for rectangular panels supported on four sides with provision for torsion at corners	38
Table 3.15 — Shear force coefficient for uniformly loaded rectangular panels supported on four sides with provision for torsion at corners	40
Table 3.16 — Form and area of shear reinforcement in solid slabs	41
Table 3.17 — Minimum thickness of structural toppings	43
Table 3.18 — Distribution of design moments in panels of flat slabs	50
Table 3.19 — Values of β for braced columns	60
Table 3.20 — Values of β for unbraced columns	60
Table 3.21 — Values of β_a	64
Table 3.22 — Values of the coefficient β	66
Table 3.23 — Maximum slenderness ratios for reinforced walls	69
Table 3.24 — Bar schedule dimensions: deduction for permissible deviations	75
Table 3.25 — Minimum percentages of reinforcement	78
Table 3.26 — Values of bond coefficient β	80
Table 3.27 — Ultimate anchorage bond lengths and lap lengths as multiples of bar size	82
Table 3.28 — Clear distance between bars according to percentage redistribution	88

	Page
Table 4.1 — Design flexural tensile stresses for class 2 members: serviceability limit state: cracking	93
Table 4.2 — Design hypothetical flexural tensile stresses for class 3 members	93
Table 4.3 — Depth factors for design tensile stresses for class 3 members	94
Table 4.4 — Conditions at the ultimate limit state for rectangular beams with pre-tensioned tendons or post-tensioned tendons having effective bond	96
Table 4.5 — Values of $V_{co}/b_v h$	97
Table 4.6 — Relaxation factors	100
Table 4.7 — Design bursting tensile forces in end blocks	104
Table 4.8 — Nominal cover to all steel (including links) to meet durability requirements	105
Table 4.9 — Nominal cover to all steel to meet specified periods of fire resistance	106
Table 4.10 — Minimum cover to curved ducts	108
Table 4.11 — Minimum distance between centre-lines of ducts in plane of curvature	109
Table 5.1 — Allowances for effects of spalling at supports	114
Table 5.2 — Allowances for effects of spalling at supported members	115
Table 5.3 — Values of $\tan a_f$ for concrete connections	119
Table 5.4 — Design flexural tensile stresses in in situ concrete	120
Table 5.5 — Design ultimate horizontal shear stresses at interface	122
Table 6.1 — Minimum periods of curing and protection	125
Table 6.2 — Minimum period before striking formwork	134
List of references	150

Foreword

This Part of BS 8110 has been prepared by Subcommittee B/525/2. It is a revision of BS 8110-1:1985 which is withdrawn.

BS 8110-1:1997 incorporates all published amendments made to BS 8110-1:1985. |

- Amendment No. 1 (AMD 5917) published on 31 May 1989;
- Amendment No. 2 (AMD 6276) published on 22 December 1989;
- Amendment No. 3 (AMD 7583) published on 15 March 1993;
- Amendment No. 4 (AMD 7973) published on 15 September 1993.

It also includes changes made by incorporating Draft Amendments Nos 5 and 6 issued for public comment during 1994 and 1995.

Amendment No. 5 detailed the insertion of various references to different cements used in concrete construction, covered by BS 5328 and the recommendations of BS 5328 for concrete as a material, up to the point of placing, curing and finishing in the works.

Amendment No. 6 dealt with the change of the partial safety factor for reinforcement γ_m , from 1.15 to 1.05.

It has been assumed in the drafting of this British Standard that the execution of its provisions will be entrusted to appropriately qualified and experienced people.

BSI Subcommittee B/525/2 whose constitution is listed on the inside front cover of this British Standard, takes collective responsibility for its preparation under the authority of the Standards Board. The Subcommittee wishes to acknowledge the personal contribution of:

- Dr. F. Walley, CB (Chairman)
- Professor A. W. Beeby
- P. Cobb
- Dr. S. B. Desai
- H. Gulvanessian
- T. W. Kirkbride
- R. I. Lancaster
- M. E. R. Little
- R. S. Narayanan
- Dr. G. Somerville
- Dr. H. P. J. Taylor
- S. Trew
- R. T. Whittle

A British Standard does not purport to include all the necessary provisions of a contract. Users of British Standards are responsible for their correct application. |

Compliance with a British Standard does not of itself confer immunity from legal obligations.

Summary of pages

This document comprises a front cover, an inside front cover, pages i to vi, pages 1 to 150, an inside back cover and a back cover.

This standard has been updated (see copyright date) and may have had amendments incorporated. This will be indicated in the amendment table on the inside front cover.

Section 1. General

1.1 Scope

This Part of BS 8110 gives recommendations for the structural use of concrete in buildings and structures, excluding bridges and structural concrete made with high alumina cement.

The recommendations for robustness have been prepared on the assumption that all load-bearing elements, e.g. slabs, columns and walls are of concrete. In a structure where concrete elements such as floor slabs are used in conjunction with load-bearing elements of other materials, similar principles are appropriate but, when adequate robustness is provided by other means, the ties recommended by this code may not be required.

NOTE 1 Where appropriate British Standards are available for precast concrete products, e.g. kerbs and pipes, it is not intended that this code should replace their more specific requirements.

1.2 References

1.2.1 Normative references

This Part of BS 8110 incorporates, by reference, provisions from specific editions of other publications. These normative references are cited at the appropriate points in the text and the publications are listed on page 150. Subsequent amendments to, or revisions of, any of these publications apply to this Part of BS 8110 only when incorporated in it by updating or revision.

1.2.2 Informative references

This Part of BS 8110 refers to other publications that provide information or guidance. Editions of these publications current at the time of issue of this standard are listed on the inside back cover, but reference should be made to the latest editions.

3 Definitions

For the purposes of this Part of BS 8110, the following definitions apply.

1.3.1 General

1.3.1.1

design ultimate load¹⁾

the design load for the ultimate limit state

1.3.1.2

design service load¹⁾

the design load for the serviceability limit state

1.3.2 Terms specific to flat slabs (see 3.7)

1.3.2.1

flat slab

a slab with or without drops and supported, generally without beams, by columns with or without column heads. It may be solid or may have recesses formed on the soffit so that the soffit comprises a series of ribs in two directions (waffle or coffered slab)

1.3.2.2

column head

local enlargement of the top of a column providing support to the slab over a larger area than the column section alone

1.3.2.3

drop

thickening of a slab in the region of a column

¹⁾ Design loads are obtained by multiplying the characteristic loads by the appropriate partial safety factors for loading (γ_f).

1.3.3 Terms specific to perimeters (see 3.7.7)

1.3.3.1

perimeter

a boundary of the smallest rectangle that can be drawn round a loaded area which nowhere comes closer to the edges of the loaded area than some specified distance l_p (a multiple of $0.75d$)

NOTE See 3.7.7.8 for loading close to a free edge, and Figure 3.16 for typical cases.

1.3.3.2

failure zone

an area of slab bounded by two perimeters $1.5d$ apart

NOTE See 3.7.7.8 for loading close to a free edge.

1.3.3.3

effective length of a perimeter

the length of the perimeter reduced, where appropriate, for the effects of holes or external edges

1.3.3.4

effective depth (d)

the average effective depth for all effective reinforcement passing through a perimeter

1.3.3.5

effective steel area

the total area of all tension reinforcement that passes through a zone and that extends at least one effective depth (see 1.3.3.4) or 12 times the bar size beyond the zone on either side

NOTE The reinforcement percentage used to calculate the design ultimate shear stress v_c is given by:

$$v_c = \frac{100 \times \text{effective reinforcement area}}{ud}$$

where

u is the outer perimeter of the zone considered;

d is as defined in 1.3.3.4.

1.3.4 Terms specific to walls (see 3.9)

1.3.4.1

wall

a vertical load-bearing member whose length exceeds four times its thickness

1.3.4.2

unbraced wall

a wall providing its own lateral stability

1.3.4.3

braced wall

a wall where the reactions to lateral forces are provided by lateral supports

1.3.4.4

lateral supports

an element (which may be a prop, a buttress, a floor, crosswall or other horizontal or vertical element) able to transmit lateral forces from a braced wall to the principal structural bracing or to the foundations

1.3.4.5

principal structural bracing

strong points, shear walls or other suitable bracing providing lateral stability to the structure as a whole

1.3.4.6

reinforced wall

a concrete wall containing at least the minimum quantities of reinforcement given in 3.12.5

1.3.4.7**plain wall**

a wall containing either no reinforcement or insufficient to satisfy the criteria in **3.12.5**

NOTE For a "plain wall", any reinforcement is ignored when considering the strength of the wall.

1.3.4.8**stocky wall**

a wall where the effective height divided by the thickness (l_e/h) does not exceed 15 (braced) or 10 (unbraced)

1.3.4.9**slender wall**

a wall other than a stocky wall

1.3.5 Terms relating to bearings for precast members (see 5.2.3)**1.3.5.1****simple bearing**

a supported member bearing directly on a support, the effect of projecting steel or added concrete being discounted

1.3.5.2**dry bearing**

a bearing with no immediate padding material

1.3.5.3**bedded bearing**

a bearing with contact surfaces having an immediate padding of cementitious material

1.3.5.4**non-isolated member**

a supported member which, in the event of loss of an assumed support, would be capable of carrying its load by transverse distribution to adjacent members

1.3.5.5**bearing length**

the length of support, supported member or intermediate padding material (whichever is the least) measured along the line of support

1.3.5.6**net bearing width (of a simple bearing)**

the bearing width (of a simple bearing) after allowance for ineffective bearing and for constructional inaccuracies (see Figure 5.4)

1.4 Symbols

For the purposes of this Part of BS 8110, the following symbols apply.

γ_f partial safety factor for load.

γ_m partial safety factor for strength of materials.

E_n nominal earth load.

G_k characteristic dead load.

Q_k characteristic imposed load.

W_k characteristic wind load.

f_{cu} characteristic strength of concrete

f_y characteristic strength of reinforcement

f_{pu} characteristic strength of a prestressing tendon

Other symbols are defined in the text where they occur.

Section 2. Design objectives and general recommendations

2.1 Basis of design

2.1.1 Aim of design

The aim of design is the achievement of an acceptable probability that structures being designed will perform satisfactorily during their intended life. With an appropriate degree of safety, they should sustain all the loads and deformations of normal construction and use and have adequate durability and resistance to the effects of misuse and fire.

2.1.2 Design method

The method recommended in this code is that of limit state design. Account should be taken of accepted theory, experiment and experience and the need to design for durability. Calculations alone do not produce safe, serviceable and durable structures. Suitable materials, quality control and good supervision are equally important.

2.1.3 Durability, workmanship and materials

It is assumed that the quality of the concrete, steel and other materials and of the workmanship, as verified by inspections, is adequate for safety, serviceability and durability (see sections 6, 7 and 8).

2.1.4 Design process

Design, including design for durability, construction and use in service should be considered as a whole. The realization of design objectives requires conformity to clearly defined criteria for materials, production, workmanship and also maintenance and use of the structure in service.

2.2 Structural design

NOTE See 1.3.1 for definitions of design ultimate load and design service load.

2.2.1 General

Well-detailed and properly-erected structures designed by the limit state method will have acceptable probabilities that they will not reach a limit state, i.e. will not become unfit for their purpose by collapse, overturning, buckling (ultimate limit states), deformation, cracking, vibration, etc. (serviceability limit states) and that the structure will not deteriorate unduly under the action of the environment over the design life, i.e. will be durable. The usual approach is to design on the most critical limit state and then to check that the remaining limit states will not be reached.

2.2.2 Ultimate limit state (ULS)

2.2.2.1 Structural stability

The structure should be so designed that adequate means exist to transmit the design ultimate dead, wind and imposed loads safely from the highest supported level to the foundations. The layout of the structure and the interaction between the structural members should be such as to ensure a robust and stable design. The engineer responsible for the overall stability of the structure should ensure the compatibility of the design and details of parts and components, even where some or all of the design and details of those parts and components are not made by this engineer.

The design strengths of materials and the design loads should be those given in 2.4, as appropriate for the ULS. The design should satisfy the requirement that no ULS is reached by rupture of any section, by overturning or by buckling under the worst combination of ultimate loads. Account should be taken of elastic or plastic instability, or sway when appropriate.

2.2.2.2 Robustness

Structures should be planned and designed so that they are not unreasonably susceptible to the effects of accidents. In particular, situations should be avoided where damage to small areas of a structure or failure of single elements may lead to collapse of major parts of the structure.

Unreasonable susceptibility to the effects of accidents may generally be prevented if the following precautions are taken.

- a) All buildings are capable of safely resisting the notional horizontal design ultimate load as given in 3.1.4.2 applied at each floor or roof level simultaneously.
- b) All buildings are provided with effective horizontal ties (see 3.12.3):
 - 1) around the periphery;

- 2) internally;
- 3) to columns and walls.
- c) The layout of building is checked to identify any key elements the failure of which would cause the collapse of more than a limited portion close to the element in question. Where such elements are identified and the layout cannot be revised to avoid them, the design should take their importance into account. Recommendations for the design of key elements are given in **2.6** of BS 8110-2:1985.
- d) Buildings are detailed so that any vertical load-bearing element other than a key element can be removed without causing the collapse of more than a limited portion close to the element in question. This is generally achieved by the provision of vertical ties in accordance with **3.12.3** in addition to satisfying a), b) and c) above. There may, however, be cases where it is inappropriate or impossible to provide effective vertical ties in all or some of the vertical load-bearing elements. Where this occurs, each such element should be considered to be removed in turn and elements normally supported by the element in question designed to “bridge” the gap in accordance with the provisions of **2.6** of BS 8110-2:1985.

2.2.2.3 Special hazards

The design for a particular occupancy, location or use, e.g. flour mills or chemical plant, may need to allow for the effects of particular hazards or for any unusually high probability of the structure’s surviving an accident even though damaged. In such cases, partial safety factors greater than those given in **2.4** may be required.

2.2.3 Serviceability limit states (SLS)

2.2.3.1 General

The design properties of materials and the design loads should be those given in section **3** of BS 8110-2:1985 as appropriate for SLS. Account should be taken of such effects as temperature, creep, shrinkage, sway, settlement and cyclic loading as appropriate.

2.2.3.2 Deflection due to vertical loading

The deformation of the structure or any part of it should not adversely affect its efficiency or appearance. Deflections should be compatible with the degree of movement acceptable by other elements including finishes, services, partitions, glazing and cladding; in some cases a degree of minor repair work or fixing adjustment to such elements may be acceptable. Where specific attention is required to limit deflections to particular values, reference should be made to **3.2** of BS 8110-2:1985; otherwise it will generally be satisfactory to use the span/effective depth ratios given in section **3** for reinforced concrete.

2.2.3.3 Response to wind loads

The effect of lateral deflection should be considered, particularly for a tall, slender structure. However the accelerations associated with the deflection may be more critical than the deflection itself (see **3.2.2** of BS 8110-2:1985).

2.2.3.4 Cracking

2.2.3.4.1 Reinforced concrete

Cracking should be kept within reasonable bounds by attention to detail. It will normally be controlled by adherence to the detailing rules given in **3.12.11**. Where specific attention is required to limit the design crack width to particular values, reference should be made to **3.2.4** of BS 8110-2:1985.

2.2.3.4.2 Prestressed concrete

In the assessment of the likely behaviour of a prestressed concrete structure or element the amount of flexural tensile stress determines its class, as follows:

- class 1: no flexural tensile stresses;
- class 2: flexural tensile stresses but no visible cracking;
- class 3: flexural tensile stresses but surface width of cracks not exceeding 0.1 mm for members in very aggressive environments (e.g. exposure to sea or moorland water) and not exceeding 0.2 mm for all other members.

2.2.3.5 Vibration

Discomfort or alarm to occupants, structural damage, and interference with proper function should be avoided. Isolation of the source of vibration or of part or all of the structure may be needed. Flexible structural elements may require special consideration.

NOTE Acceptable vibration limits are described in specialist literature.

2.2.4 Durability

To produce a durable structure requires the integration of all aspects of design, materials and construction. The environmental conditions to which the concrete will be exposed should be defined at the design stage. The design should take account of the shape and bulk of the structure, and the need to ensure that surfaces exposed to water are freely draining (see 3.1.5). Adequate cover to steel has to be provided for protection (see 3.3 and 4.1.5). Consideration may also be given to the use of protective coatings to either the steel or the concrete, or both, to enhance the durability of vulnerable parts of construction.

Concrete should be of the relevant quality; this depends on both its constituent materials and mix proportions. There is a need to avoid some constituent materials which may cause durability problems and, in other instances, to specify particular types of concrete to meet special durability requirements (see 3.1.5 and BS 5328-1).

Good workmanship, particularly curing, is essential and dimensional tolerances and the levels of control and inspection of construction should be specified. Use should be made of suitable quality assurance schemes where they exist (see 2.3, 6.1, 7.1 and 8.1 of this standard and introduction and 8.2.5 of BS 5328-1:1997).

NOTE For exceptionally severe environments additional precautions may be necessary and specialist literature should be consulted.

2.2.5 Fatigue

When the imposed load on a structure is predominantly cyclical it may be necessary to consider the effects of fatigue.

2.2.6 Fire resistance

A structure or structural element required to have fire resistance should be designed to possess an appropriate degree of resistance to flame penetration, heat transmission and collapse. Recommendations are given in section 4 of BS 8110-2:1985.

2.2.7 Lightning

Reinforcement may be used as part of a lightning protection system in accordance with BS 6651.

2.3 Inspection of construction

To ensure that the construction is in accordance with the design, an inspection procedure should be set up covering materials, records, workmanship and construction.

Tests should be made on reinforcement and the constituent materials of concrete in accordance with the relevant standards; the production and testing of concrete should conform to BS 5328. Where applicable, use should be made of suitable quality assurance schemes.

Care should be taken to ensure that:

- a) design and detail are capable of being executed to a suitable standard, with due allowance for dimensional tolerances;
- b) there are clear instructions on inspection standards;
- c) there are clear instructions on permissible deviations;
- d) elements critical to workmanship, structural performance, durability and appearance are identified; and
- e) there is a system to verify that the quality is satisfactory in individual parts of the structure, especially the critical ones.

2.4 Loads and material properties

2.4.1 Loads

2.4.1.1 *Characteristic values of loads*

The following loads should be used in design:

- a) characteristic dead load G_k i.e. the weight of the structure complete with finishes, fixtures and partitions;
- b) characteristic imposed load, Q_k ; and
- c) characteristic wind load, W_k .

The characteristic load in each case should be the appropriate load as defined in and calculated in accordance with BS 6399-1, BS 6399-2 and BS 6399-3.

2.4.1.2 *Nominal earth loads E_n*

Nominal earth loads should be obtained in accordance with normal practice (see, for example, BS 8004).

2.4.1.3 *Partial safety factors for load γ_f*

The design load for a given type of loading and limit state is obtained from:

$$G_k\gamma_f \text{ or } Q_k\gamma_f \text{ or } W_k\gamma_f \text{ or } E_n\gamma_f$$

where

γ_f is the appropriate partial safety factor. It is introduced to take account of unconsidered possible increases in load, inaccurate assessment of load effects, unforeseen stress redistribution, variation in dimensional accuracy and the importance of the limit state being considered. The value of γ_f chosen also ensures that the serviceability requirements can generally be met by simple rules.

2.4.1.4 *Loads during construction*

The loading conditions during erection and construction should be considered in design and should be such that the structure's subsequent conformity to the limit state requirements is not impaired.

2.4.2 Material properties

2.4.2.1 *Characteristic strengths of materials*

Unless otherwise stated in this code the term characteristic strength means that value of the cube strength of concrete f_{cu} , the yield or proof strength of reinforcement f_y , or the ultimate strength of a prestressing tendon f_{pu} below which 5 % of all possible test results would be expected to fall.

2.4.2.2 *Partial safety factors for strength of materials γ_m*

For the analysis of sections, the design strength for a given material and limit state is derived from the characteristic strength divided by γ_m , where γ_m is the appropriate partial safety factor given in 2.4.4.1 and 2.4.6.2. γ_m takes account of differences between actual and laboratory values, local weaknesses and inaccuracies in assessment of the resistance of sections. It also takes account of the importance of the limit state being considered.

2.4.2.3 *Stress-strain relationships*

The short-term stress-strain relationships may be taken as follows:

- a) for normal-weight concrete, from Figure 2.1 with γ_m having the relevant value given in 2.4.4 or 2.4.6;
- b) for reinforcement, from Figure 2.2 with γ_m having the relevant value;
- c) for prestressing tendons, from Figure 2.3 with γ_m having the relevant value.

When sustained loading is being considered, for reinforcement the short-term stress-strain curves should be taken to apply; for prestressing tendons, appropriate allowance for relaxation should be made. For concrete, information on creep and shrinkage is given in section 7 of BS 8110-2:1985.

2.4.2.4 *Poisson's ratio for concrete*

Where linear elastic analysis is appropriate, Poisson's ratio may be taken as 0.2.

2.4.3 Values of loads for ultimate limit state (ULS)

2.4.3.1 Design loads

2.4.3.1.1 General

In ULS design of the whole or any part of a structure each of the combinations of loading given in Table 2.1 should be considered and the design of cross-sections based on the most severe stresses produced.

Table 2.1 — Load combinations and values of γ_f for the ultimate limit state

Load combination	Load type					
	Dead		Imposed		Earth and water pressure	Wind
	Adverse	Beneficial	Adverse	Beneficial		
1. Dead and imposed (and earth and water pressure)	1.4	1.0	1.6	0	1.4	—
2. Dead and wind (and earth and water pressure)	1.4	1.0	—	—	1.4	1.4
3. Dead and wind and imposed (and earth and water pressure)	1.2	1.2	1.2	1.2	1.2	1.2

For load combinations 1 and 2 in Table 2.1, the “adverse” partial factor is applied to any loads that tend to produce a more critical design condition while the “beneficial” factor is applied to any loads that tend to produce a less critical design condition at the section considered. For load combinations 2 and 3, see 3.1.4.2 for minimum horizontal load.

2.4.3.1.2 Partial factors for earth pressures

The overall dimensions and stability of earth retaining and foundation structures, e.g. the area of pad footings, should be determined by appropriate geotechnical procedures which are not considered in this code. However, in order to establish section sizes and reinforcement areas which will give adequate safety and serviceability without undue calculation, it is appropriate in normal design situations to apply values of γ_f comparable to those applied to other forms of loading.

The factor γ_f should be applied to all earth and water pressures unless they derive directly from loads that have already been factored, in which case the pressures should be derived from equilibrium with other design ultimate loads. When applying the factor, no distinction is made between adverse and beneficial loads.

Where a detailed investigation of the soil conditions has been undertaken and account has been taken of possible structure-soil interaction in the assessment of the earth pressure, it may be appropriate to derive design ultimate values for earth and water pressure by different procedures. In this case, additional consideration should be given to conditions in the structure under serviceability loads. This approach is also recommended for all design situations which involve uncommon features. Further guidance is given in section 2 of BS 8110-2:1985.

2.4.3.2 Effects of exceptional loads or localized damage

If in the design it is necessary to consider the probable effects of excessive loads caused by misuse or accident, γ_f should be taken as 1.05 on the defined loads, and only those loads likely to be acting simultaneously need be considered. Again, when considering the continued stability of a structure after it has sustained localized damage, γ_f should be taken as 1.05. The loads considered should be those likely to occur before temporary or permanent measures are taken to repair or offset the effect of the damage.

For these exceptional cases all the following should be taken into account:

- dead-load;
- one-third of the wind load;
- for buildings used predominantly for storage or industrial purposes or where the imposed loads are permanent, 100 % of the imposed load or, for other buildings, one-third of the imposed load.

2.4.3.3 Creep, shrinkage and temperature effects

For the ULS, these effects will usually be minor and no specific calculations will be necessary.

2.4.4 Strengths of materials for the ultimate limit state

2.4.4.1 Design strengths

In the assessment of the strength of a structure or any of its parts or cross-sections, appropriate γ_m values should be taken from Table 2.2.

Table 2.2 — Values of γ_m for the ultimate limit state

Reinforcement	1.05
Concrete in flexure or axial load	1.50
Shear strength without shear reinforcement	1.25
Bond strength	1.4
Others (e.g. bearing stress)	≥ 1.5

A more detailed method for the assessment of γ_m is given in section 2 of BS 8110-2:1985. In sections 3, 4 and 5 of this standard these values have been used in the preparation of the various tables associated with the ULS.

2.4.4.2 Effects of exceptional loads or localized damage

In the consideration of these effects γ_m may be taken as 1.3 for concrete in flexure and 1.0 for steel.

2.4.5 Design loads for serviceability limit states

For SLS calculations the design loads should be those appropriate to the SLS under consideration as discussed in 3.3 of BS 8110-2:1985.

2.4.6 Material properties for serviceability limit states

2.4.6.1 General

For SLS calculations, the material properties assumed (modules of elasticity, creep, shrinkage, etc.) should be taken as those appropriate to the SLS under consideration as discussed in 3.2 of BS 8110-2:1985.

2.4.6.2 Tensile stress criteria for prestressed concrete

In assessing the cracking strength for a class 2 member, γ_m should be taken as 1.3 for concrete in tension due to flexure. Allowable design stresses are given in 4.3.4.3.

2.4.7 Material properties for durability

Some durability problems are associated with the characteristics of the constituent materials whilst others require particular characteristics of the concrete to overcome them. Guidance on these is given in the following sections and subclauses of this standard and BS 5328:

a) durability and constituent materials:

- 1) chlorides and corrosion of steel (see 4.4.1 and 5.2.2 of BS 5328-1:1997);
- 2) disruption due to excess sulfates (see 5.2.3 of BS 5328-1:1997);
- 3) disruption due to alkali-silica reaction (see 5.2.4 of BS 5328-1:1997);
- 4) aggregates with high drying shrinkage (see 4.3.4 of BS 5328-1:1997);
- 5) aggregates and fire resistance (see section 4 of BS 8110-2:1985 and 4.3.8 of BS 5328-1:1997);

b) durability and concrete characteristics:

- 1) concrete quality and cover to reinforcement (see 3.1.5, 3.3 and 4.12.3 of this standard and clause 5 of BS 5328-1:1997);
- 2) air-entrained concrete for freeze/thaw resistance (see 4.3.3 of BS 5328-1:1997);
- 3) concrete subject to exposure to aggressive chemicals (see 5.3.4 of BS 5328-1:1997);
- 4) concrete properties and durability (see clause 5 of BS 5328-1:1997);
- 5) fire resistance (see section 4 of BS 8110-2:1985 and 4.3.8 and 6.2 of BS 5328-1:1997);
- 6) lightweight aggregate concrete (see section 5 of BS 8110-2:1985).

2.5 Analysis

2.5.1 General

The analysis that is carried out to justify a design can be broken into two stages as follows:

- a) analysis of the structure;
- b) analysis of sections.

In the analysis of the structure, or part of the structure, to determine force distributions within the structure, the properties of materials may be assumed to be those associated with their characteristic strengths, irrespective of which limit state is being considered. In the analysis of any cross-section within the structure, the properties of materials should be assumed to be those associated with their design strengths appropriate to the limit state being considered.

The methods of analysis used should be based on as accurate a representation of the behaviour of the structure as is reasonably practicable. The methods and assumptions given in this clause are generally adequate but, in certain cases, more fundamental approaches in assessing the behaviour of the structure under load may be more appropriate.

2.5.2 Analysis of structure

The primary objective of structural analysis is to obtain a set of internal forces and moments throughout the structure that are in equilibrium with the design loads for the required loading combinations.

Under design ultimate loads, any implied redistribution of forces and moments should be compatible with the ductility of the members concerned. Generally it will be satisfactory to determine envelopes of forces and moments by linear elastic analysis of all or parts of the structure and allow for redistribution and possible buckling effects using the methods described in sections 3 and 4. Alternatively plastic methods, e.g. yield line analysis, may be used.

For design service loads, the analysis by linear elastic methods will normally give a satisfactory set of moments and forces.

When linear elastic analysis is used, the relative stiffnesses of members may be based on any of the following.

- a) *The concrete section*: the entire concrete cross-section, ignoring the reinforcement.
- b) *The gross section*: the entire concrete cross-section, including the reinforcement on the basis of modular ratio.
- c) *The transformed section*: the compression area of the concrete cross-section combined with the reinforcement on the basis of modular ratio.

In b) and c) a modular ratio of 15 may be assumed in the absence of better information.

A consistent approach should be used for all elements of the structure.

2.5.3 Analysis of sections for the ultimate limit state

The strength of a cross-section at the ULS under both short and long term loading may be assessed assuming the short term stress/strain curves derived from the design strengths of the materials as given in 2.4.4.1 and Figure 2.1 to Figure 2.3 as appropriate. In the case of prestressing tendons the moduli of elasticity in Figure 2.3 are those given for information in BS 4486 and BS 5896.

2.5.4 Analysis of sections for serviceability limit states

The behaviour of a section at a SLS may be assessed assuming plane sections remain plain and linear stress/strain relationships for both steel and concrete.

Allowance should be made where appropriate for the effects of creep, shrinkage, cracking and prestress losses.

The elastic modulus for steel should be taken as 200 kN/mm². Information on the selection of elastic moduli for concrete may be found in section 7 of BS 8110-2:1985.

2.6 Design based on tests

2.6.1 Model tests

A design may be deemed satisfactory on the basis of results from an appropriate model test coupled with the use of model analysis to predict the behaviour of the actual structure, provided the work is carried out by engineers with relevant experience using suitable equipment.

2.6.2 Prototype tests

A design may be deemed satisfactory if the analytical or empirical basis of the design has been justified by development testing of prototype units and structures relevant to the particular design under consideration.

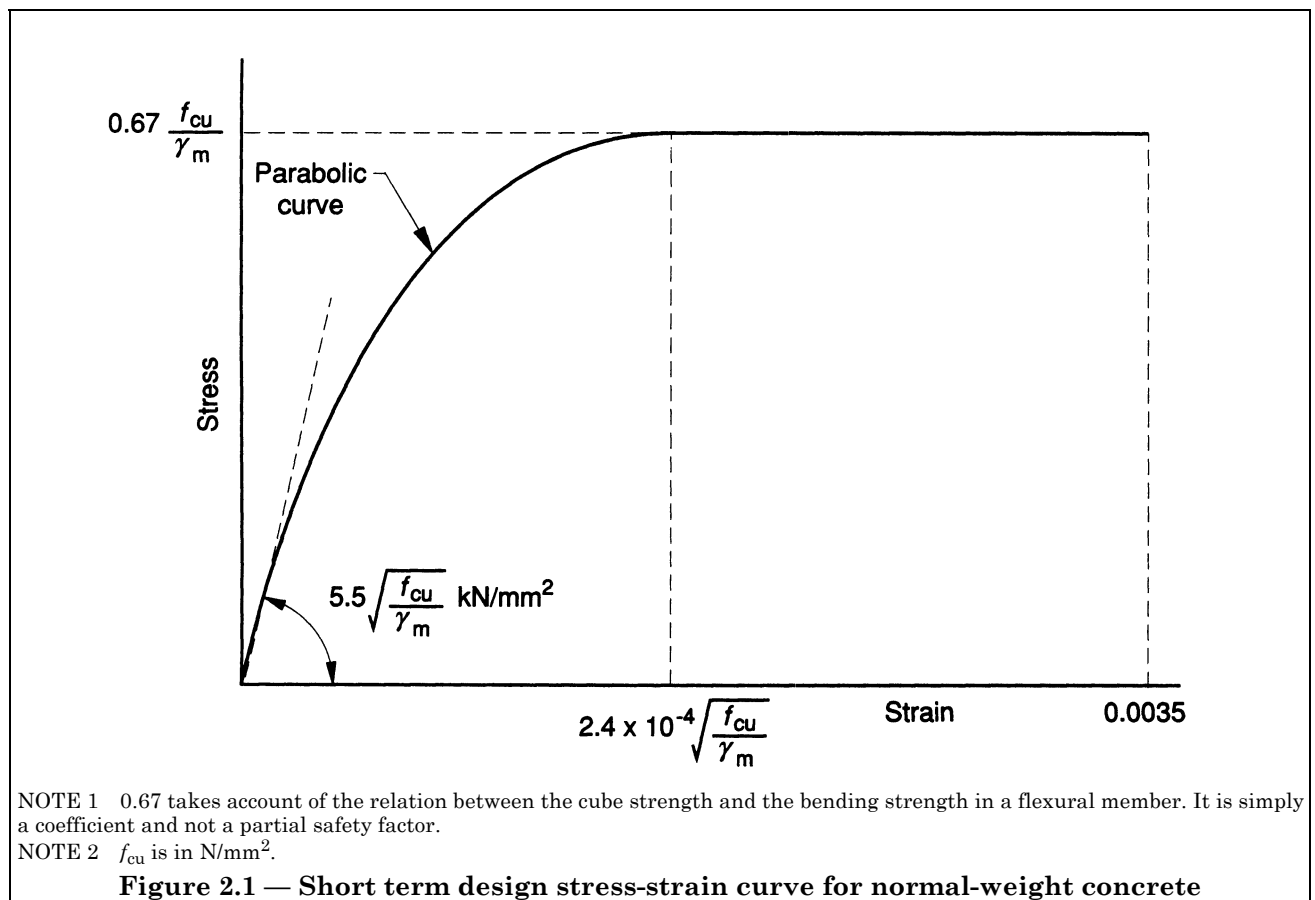

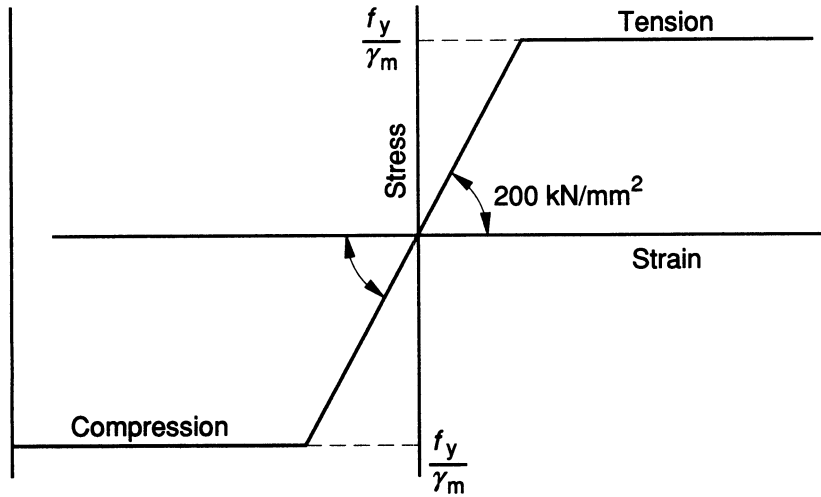

NOTE f_y is in N/mm^2 .

Figure 2.2 — Short term design stress-strain curve for reinforcement

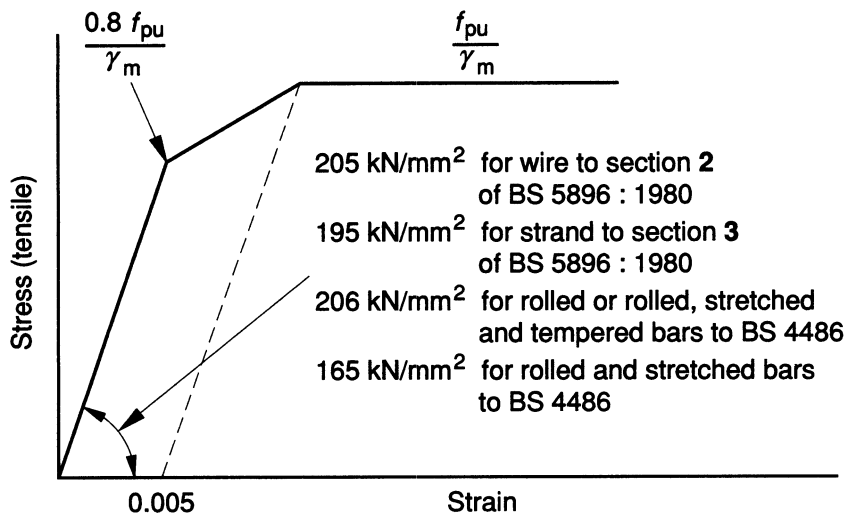

NOTE f_{pu} is in N/mm^2 .

Figure 2.3 — Short term design stress-strain curve for prestressing tendons

Section 3. Design and detailing: reinforced concrete

NOTE Bridges, water-retaining structures, chimneys and some other structures are more appropriately covered by other codes. For deep beams and other uncommon elements, other relevant specialist literature may be used providing the resulting designs satisfy section 2.

3.1 Design basis and strength of materials

3.1.1 General

This section gives methods of analysis and design that will in general ensure that for reinforced concrete structures, the objectives set out in section 2 are met. Other methods may be used provided they can be shown to be satisfactory for the type of structure or member considered. The design recommendations assume the use of normal-weight aggregate. Where lightweight aggregate is to be used, see section 5 of BS 8110-2:1985. In certain cases, the assumptions made in this section may be inappropriate and the engineer should adopt a more suitable method having regard to the nature of the structure in question.

3.1.2 Basis of design for reinforced concrete

Here the ULS is assumed to be the critical limit state; the SLS of deflection and cracking will not then normally be reached if the recommendations given for span/effective depth ratios and reinforcement spacings are followed.

3.1.3 Alternative methods (serviceability limit state)

As an alternative to 3.1.2 (deflection and crack width may be calculated; suitable methods are given in section 3 of BS 8110-2:1985).

3.1.4 Robustness

3.1.4.1 *General check of structural integrity*

A careful check should be made and appropriate action taken to ensure that there is no inherent weakness of structural layout and that adequate means exist to transmit the dead, imposed and wind loads safely from the highest supported level to the foundations.

3.1.4.2 *Notional horizontal load*

All buildings should be capable of resisting a notional design ultimate horizontal load applied at each floor or roof level simultaneously equal to 1.5 % of the characteristic dead weight of the structure between mid-height of the storey below and either mid-height of the storey above or the roof surface [i.e. the design ultimate wind load should not be taken as less than this value when considering load combinations 2 or 3 (see 2.4.3.1)].

3.1.4.3 *Provision of ties*

In structures where all load-bearing elements are concrete, horizontal and vertical ties should be provided in accordance with 3.12.3.

3.1.4.4 *Key elements and bridging structures*

Where key elements and bridging structures are necessary, they should be designed in accordance with 2.6 of BS 8110-2:1985.

3.1.4.5 *Safeguarding against vehicular impact*

Where vertical elements are particularly at risk from vehicle impact, consideration should be given to the provision of additional protection, such as bollards, earth banks or other devices.

3.1.4.6 *Flow chart of design procedure*

Figure 3.1 summarizes the design procedure envisaged by the code for ensuring robustness.

3.1.5 Durability of structural concrete

3.1.5.1 *General*

A durable concrete element is one that is designed and constructed to protect embedded metal from corrosion and to perform satisfactorily in the working environment for the life-time of the structure.

To achieve this it is necessary to consider many interrelated factors at various stages in the design and construction process. Thus the structural form and cover to steel are considered at the design stage and this involves consideration of the environmental conditions (see 3.3.4.1). If these are particularly aggressive, it may be necessary to consider the type of cement at the design stage.

The main characteristics influencing the durability of concrete are the rates at which oxygen, carbon dioxide, chloride ions and other potentially deleterious substances can penetrate the concrete, and the concrete's ability to bind these substances. These characteristics are governed by the constituents and procedures used in making the concrete (see clause 5 of BS 5328-1:1997 and 2.4.7 of this standard).

The factors influencing durability include:

- a) the design and detailing of the structure (see 3.1.5.2.1);
- b) the cover to embedded steel (see 3.3, and 4.12.3);
- c) the exposure conditions (see 3.3.4);
- d) the type of cement (see 4.2 and 5.3.4 of BS 5328-1:1997);
- e) the type of aggregate (see 4.3 and 5.2 of BS 5328-1:1997);
- f) the cement content and water/cement ratio of the concrete (see 3.3.5 of this standard and 5.4 of BS 5328-1:1997);
- g) the type and dosage of admixture (see 4.4 and 5.3.3 of BS 5328-1:1997);
- h) workmanship, to obtain a specified cover, full compaction and efficient curing (see 6.2);
- i) joints and connections (see 6.2.9 and 6.2.10).

The degree of exposure anticipated for the concrete during its service life together with other relevant factors relating to mix composition, workmanship and design should be considered. To provide adequate durability under these conditions, the concrete should be chosen and specified in accordance with BS 5328-1 and BS 5328-2.

3.1.5.2 Design for durability

3.1.5.2.1 Design and detailing of the structure

Since many processes of deterioration of concrete only occur in the presence of free water, the structure should be designed, wherever possible, to minimize uptake of water or exposure to moisture. The shape and design details of exposed structures should be such as to promote good drainage of water and to avoid standing pools and rundown of water.

Care should also be taken to minimize any cracks that may collect or transmit water.

Concrete is more vulnerable to deterioration due to chemical or climatic attack when it is in thin sections, in sections under hydrostatic pressure from one side only, in partly immersed sections and at corners and edges of elements. The life of the structure can be lengthened by providing extra cover to steel at the corners, by chamfering the corners or by using circular cross-sections or by using surface treatments which prevent or reduce the ingress of water, carbon dioxide or aggressive chemicals.

Good curing (see 6.2.3) is essential to avoid the harmful effects of early loss of moisture.

Where the minimum dimension of the concrete to be placed at a single time is greater than 600 mm, and especially where the cement content is 400 kg/m³ or more, measures to reduce the temperature rise and/or peak temperature such as using material with a slower release of heat of hydration should be considered.

The amount and the rate of heat evolution is related to the cement content and the chemistry of the Portland cement, and the chemistry and amount of the ground granulated blastfurnace slag (g.g.b.f.s.) or pulverized fuel ash (p.f.a.) in blended cements, or combined in the concrete mixes. These factors may also affect the rate of strength development, ultimate strength and other properties.

3.1.5.2.2 Depth of concrete cover and concrete quality

The protection of the steel in concrete against corrosion depends upon the alkaline environment provided by an adequate thickness of good quality concrete.

Table 3.4 and Table 4.8 give the limiting values of the nominal cover of normal-weight aggregate concrete which should be provided to all reinforcement, including links, and to prestressing tendons depending on the condition of exposure described in 3.3.4 and on the characteristics of the concrete mix.

3.1.5.2.3 Other properties

Where it is anticipated that any aggregate is likely to have an unusual effect on the physical and mechanical properties of concrete, or its interaction with steel reinforcement, these factors should be taken into account in structural design and in the workmanship. For example, the elastic modulus depends mainly on the aggregate used (see section 3 of BS 8110-2:1985).

3.1.5.2.4 Unreinforced concrete

Tables 6 and 7 of BS 5328-1:1997 gives recommended values for the maximum free water cement/ratio, minimum cement content and lowest grade of concrete to ensure long service life under appropriate conditions of exposure.

For concrete made with normal-weight aggregate and used in foundations and slabs for low rise structures in non-aggressive soil conditions (see sulfate class 1 of Table 7a of BS 5328-1:1997), a minimum grade of C10 may be used provided the minimum cement content is not less than 175 kg/m^3 for designated mixes or 210 kg/m^3 for other types of concrete.

Where a member is designed as unreinforced but contains reinforcing bars, the member may be treated as unreinforced for the purposes of this sub-clause provided that any damage to the cover concrete or unsightliness that may result from corrosion of the bars is acceptable.

3.1.6 Loads

The values of the design ultimate loads to be used in design are those given in 2.4.3 and the values of the design service loads in 2.4.5.

3.1.7 Strength of materials

3.1.7.1 General

The design strengths of materials for ULS are expressed in the tables and the equations in terms of the characteristic strengths of the materials and partial safety factors.

3.1.7.2 Selection of compressive strength grade of concrete

The grade of concrete appropriate for use should be selected from the preferred grades in 6 and 8.5 of BS 5328-1:1997 taking account of the following factors:

- adequate strength for the limit state requirements of section 2;
- durability (see 3.1.5 and 3.3 of this standard, 4 and 8.5 of BS 5328-1:1997 and Tables 3 and 6 of BS 5328-2:1997);
- any other special overriding characteristic.

For reinforced concrete, the lowest grade that should be used is C15 for concrete made with lightweight aggregates, and C25 for concrete made with normal-weight aggregates.

3.1.7.3 Age allowance for concrete

Design should be based on the 28 day characteristic strength unless there is evidence to justify a higher strength for a particular structure.

3.1.7.4 Characteristic strengths of reinforcement

Characteristic strengths of reinforcement are given in BS 4449, BS 4482 and BS 4483 and are as shown in Table 3.1. Design may be based on the appropriate characteristic strength or a lower value if necessary to reduce deflection or control cracking.

Table 3.1 — Strength of reinforcement

Designation	Specified characteristic strength, f_y N/mm ²
Hot rolled mild steel	250
High yield steel (hot rolled or cold worked)	460

3.2 Structures and structural frames

3.2.1 Analysis of structures

3.2.1.1 Complete structures and complete structural frames

Analysis may follow the recommendations of 2.5 but the methods of 3.2.1.2 or 3.2.1.3 may be adopted if appropriate.

3.2.1.2 Monolithic frames not providing lateral stability

3.2.1.2.1 Simplification into sub-frames

The moments, loads and shear forces to be used in the design of individual columns and beams of a frame supporting vertical loads only may be derived from an elastic analysis of a series of sub-frames (but see 3.2.2 concerning redistribution of moments). Each sub-frame may be taken to consist of the beams at one level together with the columns above and below. The ends of the columns remote from the beams may generally be assumed to be fixed unless the assumption of a pinned end is clearly more reasonable (for example, where a foundation detail is considered unable to develop moment restraint).

3.2.1.2.2 Choice of critical loading arrangements

It will normally be sufficient to consider the following arrangements of vertical load:

- a) all spans loaded with the maximum design ultimate load ($1.4G_k + 1.6Q_k$);
- b) alternate spans loaded with the maximum design ultimate load ($1.4G_k + 1.6Q_k$) and all other spans loaded with the minimum design ultimate load ($1.0G_k$).

3.2.1.2.3 Alternative simplification for individual beams (and associated columns)

As an alternative to 3.2.1.2.1 the moments and forces in each individual beam may be found by considering a simplified sub-frame consisting only of that beam, the columns attached to the ends of the beam and the beams on either side, if any. The column and beam ends remote from the beam under consideration may generally be assumed to be fixed unless the assumption of pinned ends is clearly more reasonable. The stiffness of the beams on either side of the beam considered should be taken as half their actual values if they are taken to be fixed at their outer ends. The critical loading arrangements should be in accordance with 3.2.1.2.2.

The moments in an individual column may also be found from this simplified sub-frame provided that the sub-frame has as its central beam the longer of the two spans framing into the column under consideration.

3.2.1.2.4 "Continuous beam" simplification

As a more conservative alternative to the preceding sub-frame arrangements the moments and shear forces in the beams at one level may also be obtained by considering the beams as a continuous beam over supports providing no restraint to rotation. The critical loading arrangements should be in accordance with 3.2.1.2.2.

3.2.1.2.5 Asymmetrically-loaded columns where a beam has been analysed in accordance with 3.2.1.2.4

In these columns the ultimate moments may be calculated by simple moment distribution procedures, on the assumption that the column and beam ends remote from the junction under consideration are fixed and that the beams possess half their actual stiffness. The arrangement of the design ultimate imposed load should be such as to cause the maximum moment in the column.

3.2.1.3 Frames providing lateral stability

3.2.1.3.1 General

Where the frame provides lateral stability to the structure as a whole, sway should be considered. In addition, if the columns are slender, additional moments (e.g. from eccentricity) may be imposed on beams at beam-column junctions (see 3.8.3). The load combinations 2 and 3 (see 2.4.3.1) should be considered in addition to load combination 1.

3.2.1.3.2 Sway-frame of three or more approximately equal bays

The design of individual beams and columns may be based on either the moments, loads and shear obtained by considering vertical loads only, as in 3.2.1.2.2 or, if more severe, on the sum of those obtained from a) and b) as follows.

- a) An elastic analysis of a series of sub-frames each consisting of the beams at one level together with the columns above and below assumed to be fixed at their ends remote from those beams (or pinned if this is more realistic). Lateral loads should be ignored and all beams should be considered to be loaded with their full design load ($1.2G_k + 1.2Q_k$).
- b) An elastic analysis of the complete frame, assuming points of contraflexure at the centres of all beams and columns, ignoring dead and imposed loads and considering only the design wind load ($1.2W_k$) on the structure. If more realistic, instead of assuming points of contraflexure at the centres of ground floor columns the feet should be considered pinned.

It will also be necessary to consider the effects of load combination 2 (see 2.4.3.1) i.e. $1.0G_k + 1.4W_k$.

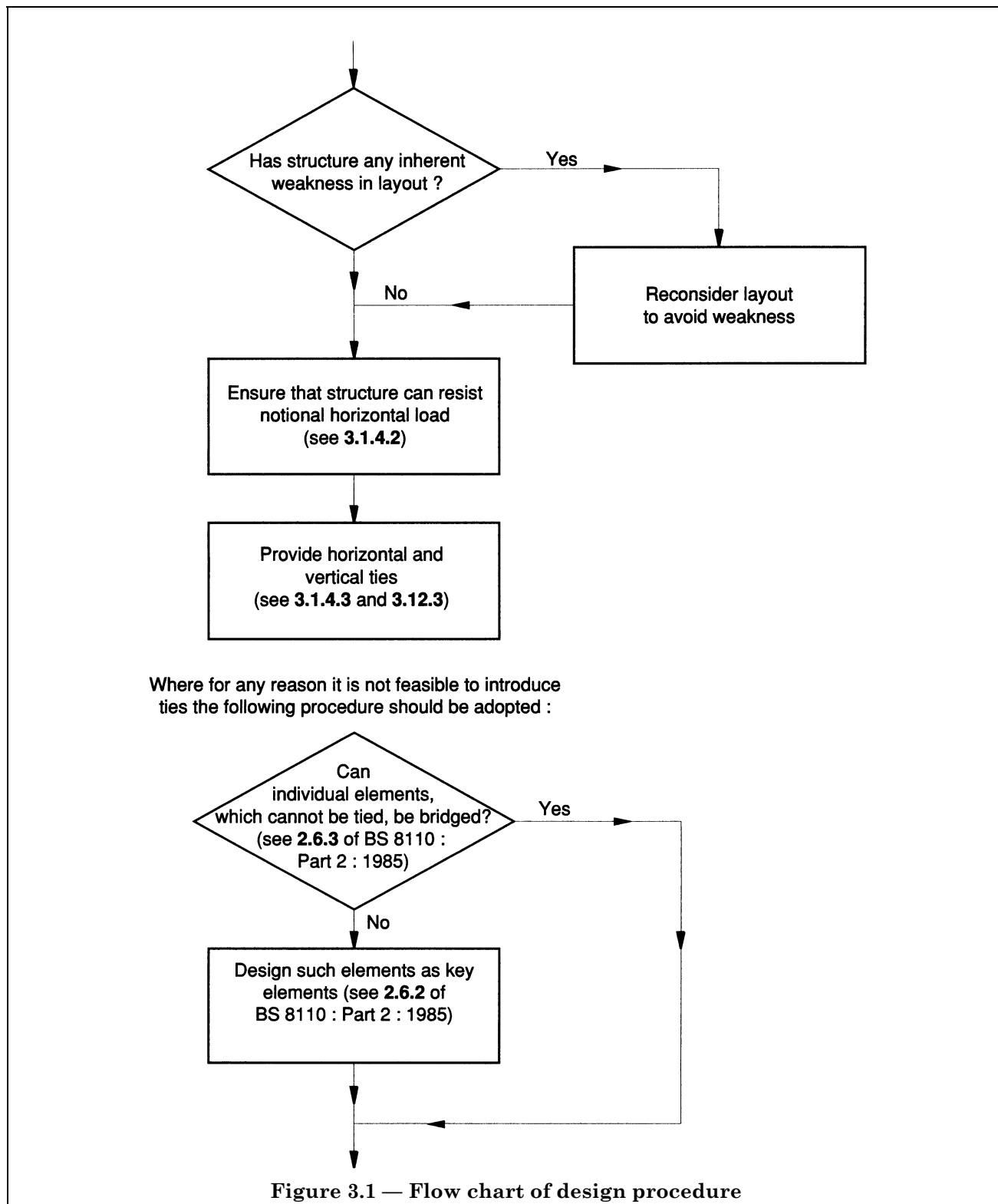

Figure 3.1 — Flow chart of design procedure

3.2.2 Redistribution of moments

3.2.2.1 General

Redistribution of the moments obtained by means of a rigorous elastic analysis or by the simplified methods of 3.2.1.2 and 3.2.1.3 may be carried out provided the following conditions are satisfied.

- a) *Condition 1.* Equilibrium between internal and external forces is maintained under all appropriate combinations of design ultimate load.
- b) *Condition 2.* Where the design ultimate resistance moment of the cross-section subjected to the largest moment within each region of hogging or sagging is reduced, the neutral axis depth x should be checked to see that it is not greater than $(\beta_b - 0.4)d$ where d is the effective depth and β_b is the ratio:

$$\frac{\text{(moment at the section after redistribution)}}{\text{(moment at the section before redistribution)}} \leq 1$$

from the respective maximum moments diagram.

- c) *Condition 3.* Resistance moment at any section should be at least 70 % of moment at that section obtained from an elastic maximum moments diagram covering all appropriate combinations of design ultimate load (but see 3.2.2.2 for tall structures).

NOTE Unless the column axial load is small, condition 2 will generally rule out reduction in column moment.

3.2.2.2 Restriction to redistribution of moments in structures over four storeys where the structural frame provides lateral stability

The provisions of 3.2.2.1 apply except that redistribution is limited to 10 % and the value given in condition 3 should read 90 %.

3.3 Concrete cover to reinforcement

3.3.1 Nominal cover

3.3.1.1 General

Nominal cover is the design depth of concrete cover to all steel reinforcement, including links. It is the dimension used in design and indicated on the drawings. The actual cover to all reinforcement should never be less than the nominal cover minus 5 mm. The nominal cover should:

- a) be in accordance with the recommendations for bar size and aggregate size for concrete cast against uneven surfaces (see 3.3.1.2 to 3.3.1.4);
- b) protect the steel against corrosion (see 3.3.3);
- c) protect the steel against fire (see 3.3.6); and
- d) allow for surface treatments such as bush hammering.

3.3.1.2 Bar size

The nominal cover to all steel should be such that the resulting cover to a main bar should not be less than the size of the main bar or, where bars are in pairs or bundles, the size of a single bar of cross-sectional area equal to the sum of their cross-sectional areas. At the same time the nominal cover to any links should be preserved.

3.3.1.3 Nominal maximum size of aggregate

Nominal covers should be not less than the nominal maximum size of the aggregate. The nominal maximum size of coarse aggregate should not normally be greater than one-quarter of the minimum thickness of the concrete section or element.

For most work, 20 mm aggregate is suitable. Larger sizes should be permitted where there are no restrictions to the flow of concrete into sections. In thin sections or elements with closely spaced reinforcement, consideration should be given to the use of 14 mm or 10 mm nominal maximum size.

3.3.1.4 Concrete cast against uneven surfaces

In such cases the specified nominal cover should generally be increased beyond the values given in Table 3.3 to ensure that an adequate minimum cover will be obtained. For this reason, the nominal cover specified where concrete is cast directly against the earth should generally be not less than 75 mm. Where concrete is cast against an adequate blinding, a nominal cover of less than 40 mm (excluding blinding) should not generally be specified.

3.3.2 Ends of straight bars

Cover is not required to the end of a straight bar in a floor or roof unit where its end is not exposed to the weather or to condensation.

3.3.3 Cover against corrosion

The cover required to protect the reinforcement against corrosion depends on the exposure conditions and the quality of the concrete as placed and cured immediately surrounding the reinforcement. Table 3.4 gives limiting values for the nominal cover of concrete made with normal-weight aggregates as a function of these factors. There may be cases where extra precautions are needed beyond those given in 3.3.4 in order to ensure protection of the reinforcement. Further information is given in 3.1.5.

3.3.4 Exposure conditions

The exposure conditions in service listed in Table 3.3 are described in Table 3.2.

3.3.5 Method of specifying concrete for durability

3.3.5.1 Mix proportions

Concrete to meet the requirements of Table 3.3 should be specified as designated mixes, designed mixes or prescribed mixes in accordance with BS 5328-2.

For simplicity, the specification of lowest grade from Table 3.3 may be by designated mixes in accordance with BS 5328-2, i.e. RC30 for C30, RC35 for C35, RC40 for C40, RC45 for C45 and RC50 for C50 (see Table 6 of BS 5328-2:1997). The use of these designations ensures that the respective water/cement ratios and minimum cement contents are included as part of the specification and do not have to be separately detailed. Adjustments to cement content for aggregates other than 20 mm nominal maximum size are also covered.

Additional requirements to cater for aggressive chemical and physical conditions should be specified in accordance with clause 5 of BS 5328-1:1997.

NOTE Designated mixes are not normally applicable to precast concrete or for case in situ concrete in piling and diaphragm walls.

3.3.5.2 Permitted reduction in cement content

Where concrete with free water/cement ratios significantly lower than the maximum values in Table 3.3, which are appropriate for normal workability, is both manufactured and used under particularly well controlled conditions, the cement content may be reduced provided the following requirements are met:

- a) the reduction in cement content does not exceed 10 % of the appropriate value in Table 3.3;
- b) the corresponding free water/cement ratio is reduced by not less than the percentage reduction in the cement content;
- c) the resulting mix can be placed and compacted properly;
- d) the establishment of systematic control to ensure that the reduced limits are met in the concrete as placed.

3.3.5.3 Permitted reduction in concrete grades

Where due to the nature of constituent materials there is difficulty in conforming to the concrete strengths in Table 3.3 and a systematic checking regime is established to ensure adherence with the free water/cement ratio and cement content, the concrete strengths C30, C35, C40 and C45 may be relaxed by not more than 5, that is to C25, C30, C35 and C40 respectively.

Table 3.2 — Classification of exposure conditions

Environment	Exposure conditions
Mild	Concrete surfaces protected against weather or aggressive conditions
Moderate	Exposed concrete surfaces but sheltered from severe rain or freezing whilst wet Concrete surfaces continuously under non-aggressive water Concrete in contact with non-aggressive soil (see sulfate class 1 of Table 7a in BS 5328-1:1997) Concrete subject to condensation
Severe	Concrete surfaces exposed to severe rain, alternate wetting and drying or occasional freezing or severe condensation
Very severe	Concrete surfaces occasionally exposed to sea water spray or de-icing salts (directly or indirectly) Concrete surfaces exposed to corrosive fumes or severe freezing conditions whilst wet
Most severe	Concrete surfaces frequently exposed to sea water spray or de-icing salts (directly or indirectly) Concrete in sea water tidal zone down to 1 m below lowest low water
Abrasive ^a	Concrete surfaces exposed to abrasive action, e.g. machinery, metal tyred vehicles or water carrying solids
NOTE 1 For aggressive soil and water conditions see 5.3.4 of BS 5328-1:1997.	
NOTE 2 For marine conditions see also BS 6349.	
^a For flooring see BS 8204.	

3.3.6 Cover as fire protection

Cover for protection against corrosion may not suffice as fire protection. The values given in Table 3.4 and Figure 3.2 will ensure that fire resistance requirements are satisfied. The tables are based on recommendations given in section 4 of BS 8110-2:1985; however, in columns and beams the covers included in the tables have been adjusted to permit nominal covers to be specified to all steel (including links). Minimum dimensions of members for fire resistance are also included in Figure 3.2. In some circumstances a more detailed treatment of the design for fire may give significant economies. Section 4 of BS 8110-2:1985 gives further information on design for fire, including information on surface treatments for improving fire resistance.

3.3.7 Control of cover

Good workmanship is required to ensure that the reinforcement is properly placed and that the specified cover is obtained. Recommendations for this are given in 7.3.

NOTE Further information on cover is given in the following:

- a) durability in general (see 3.1.5 of this standard and clause 5 of BS 5328-1:1997);
- b) prestressed concrete (see 4.12.3);
- c) control of cover (see 7.3);
- d) fire resistance (see section 4 of BS 8110-2:1985);
- e) lightweight aggregate concrete (see section 5 of BS 8110-2:1985).

Table 3.3 — Nominal cover to all reinforcement (including links) to meet durability requirements (see NOTE 1)

Conditions of exposure (see 3.3.4)	Nominal cover Dimensions in millimetres				
	Mild	25	20	20 ^a	20 ^a
Moderate	—	35	30	25	20
Severe	—	—	40	30	25
Very severe	—	—	50 ^b	40 ^b	30
Most severe	—	—	—	—	50
Abrasive	—	—	—	See NOTE 3	See NOTE 3
Maximum free water/cement ratio	0.65	0.60	0.55	0.50	0.45
Minimum cement content (kg/m ³)	275	300	325	350	400
Lowest grade of concrete	C30	C35	C40	C45	C50

NOTE 1 This table relates to normal-weight aggregate of 20 mm nominal size. Adjustments to minimum cement contents for aggregates other than 20 mm nominal maximum size are detailed in Table 8 of BS 5328-1:1997.

NOTE 2 Use of sulfate resisting cement conforming to BS 4027. These cements have lower resistance to chloride ion migration. If they are used in reinforced concrete in very severe or most severe exposure conditions, the covers in Table 3.3 should be increased by 10 mm.

NOTE 3 Cover should be not less than the nominal value corresponding to the relevant environmental category plus any allowance for loss of cover due to abrasion.

^a These covers may be reduced to 15 mm provided that the nominal maximum size of aggregate does not exceed 15 mm.

^b Where concrete is subject to freezing whilst wet, air-entrainment should be used (see 5.3.3 of BS 5328-1:1997) and the strength grade may be reduced by 5.

Table 3.4 — Nominal cover to all reinforcement (including links) to meet specified periods of fire resistance (see NOTES 1 and 2)

Fire resistance <i>h</i>	Nominal cover						Columns ^a mm
	Beams ^a		Floors		Ribs		
	Simply supported mm	Continuous mm	Simply supported mm	Continuous mm	Simply supported mm	Continuous mm	
0.5	20 ^b	20 ^b	20 ^b	20 ^b	20 ^b	20 ^b	20 ^b
1	20 ^b	20 ^b	20	20	20	20 ^b	20 ^b
1.5	20	20 ^b	25	20	35	20	20
2	40	30	35	25	45	35	25
3	60	40	45	35	55	45	25
4	70	50	55	45	65	55	25

NOTE 1 The nominal covers given relate specifically to the minimum member dimensions given in Figure 3.2. Guidance on increased covers necessary if smaller members are used is given in section 4 of BS 8110-2:1985.

NOTE 2 Cases that lie below the bold line require attention to the additional measures necessary to reduce the risks of spalling (see section 4 of BS 8110-2:1985).

^a For the purposes of assessing a nominal cover for beams and columns, the cover to main bars which would have been obtained from Tables 4.2 and 4.3 of BS 8110-2:1985 has been reduced by a notional allowance for stirrups of 10 mm to cover the range 8 mm to 12 mm (see also 3.3.6).

^b These covers may be reduced to 15 mm provided that the nominal maximum size of aggregate does not exceed 15 mm (see 3.3.1.3).

Beams

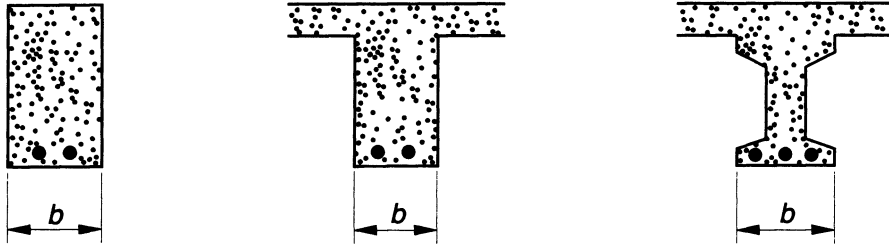

Floors

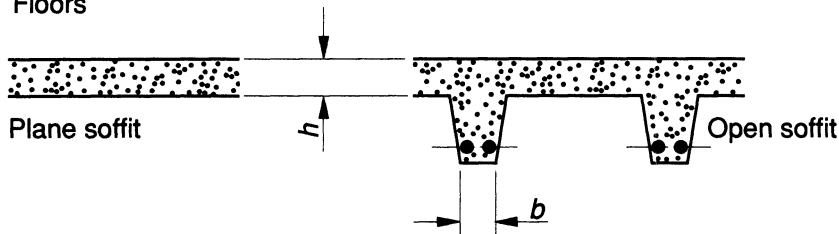

Columns

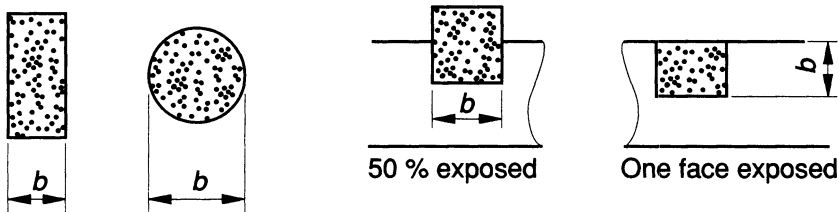

Fully exposed

Fire resistance h	Minimum beam width (b) mm	Rib width (b) mm	Minimum thickness of floors (h) mm	Column width (b)			Minimum wall thickness		
				Fully exposed mm	50 % exposed mm	One face exposed mm	$p < 0.4\%$ mm	$0.4\% < p < 1\%$ mm	$p > 1\%$ mm
0.5	200	125	75	150	125	100	150	100	75
1	200	125	95	200	160	120	150	120	75
1.5	200	125	110	250	200	140	175	140	100
2	200	125	125	300	200	160	—	160	100
3	240	150	150	400	300	200	—	200	150
4	280	175	170	450	350	240	—	240	180

NOTE 1 These minimum dimensions relate specifically to the covers given in Table 3.4 and Table 4.9.

NOTE 2 p is the area of steel relative to that of concrete.

Figure 3.2 — Minimum dimensions of reinforced concrete members for fire resistance

3.4 Beams

3.4.1 General

3.4.1.1 *Design limitations*

This sub-clause deals with the design of beams of normal proportions. Deep beams of clear span less than twice the effective depth are not considered.

NOTE For the design of deep beams, reference should be made to specialist literature.

3.4.1.2 *Effective span of simply-supported beams*

The effective span of a simply-supported beam may be taken as the smaller of the distance between the centres of bearings, or the clear distance between supports plus the effective depth.

3.4.1.3 *Effective span of a continuous member*

The effective span of a continuous member should be taken as the distance between centres of supports. The centre of action of support at an encastred end should be taken to be at half the effective depth from the face of the support.

3.4.1.4 *Effective length of a cantilever*

The effective length of a cantilever should be taken as its length to the face of the support plus half its effective depth except where it forms the end of a continuous beam where the length to the centre of the support should be used.

3.4.1.5 *Effective width of flanged beam*

In the absence of any more accurate determination this should be taken as:

- a) for *T-beams*: web width $+l_z/5$ or actual flange width if less;
- b) for *L-beams*: web width $+l_z/10$ or actual flange width if less;

where

l_z is the distance between points of zero moment (which, for a continuous beam, may be taken as 0.7 times the effective span).

3.4.1.6 *Slenderness limits for beams for lateral stability*

The clear distance between restraints should not exceed:

- a) for *simply-supported or continuous beams*: $60b_c$ or $250b_c^2/d$ if less;
- b) for *cantilevers with lateral restraint only at support*: $25b_c$ or $100b_c^2/d$ if less;

where

b_c is the breadth of the compression face of the beam, measured mid-way between restraints (or the breadth of the compression face of a cantilever);

d is the effective depth (which need not be greater than whatever effective depth would be necessary to withstand the design ultimate load with no compression reinforcement).

3.4.2 Continuous beams

Continuous beams may be analysed in accordance with section 2 or designed and detailed to resist the moments and shear forces given by 3.2.1.2 or 3.4.3, as appropriate.

3.4.3 *Uniformly-loaded continuous beams with approximately equal spans: moments and shears*

Table 3.5 may be used to calculate the design ultimate bending moments and shear forces, subject to the following provisions:

- a) characteristic imposed load Q_k may not exceed characteristic dead load G_k ;
- b) loads should be substantially uniformly distributed over three or more spans;
- c) variations in span length should not exceed 15 % of longest.

Table 3.5 — Design ultimate bending moments and shear forces

	At outer support	Near middle of end span	At first interior support	At middle of interior spans	At interior supports
Moment	0	$0.09Fl$	$-0.11Fl$	$0.07Fl$	$-0.08Fl$
Shear	$0.45F$	—	$0.6F$	—	$0.55F$

NOTE l is the effective span;
 F is the total design ultimate load ($1.4G_k + 1.6Q_k$).

No redistribution of the moments calculated from this table should be made.

3.4.4 Design resistance moment of beams

3.4.4.1 Analysis of sections

In the analysis of a cross-section to determine its ultimate moment of resistance the following assumptions should be made.

- The strain distribution in the concrete in compression and the strains in the reinforcement, whether in tension or compression, are derived from the assumption that plane sections remain plane.
- The stresses in the concrete in compression may be derived from the stress-strain curve in Figure 2.1 with $\gamma_m = 1.5$. Alternatively, the simplified stress block illustrated in Figure 3.3 may be used.
- The tensile strength of the concrete is ignored.
- The stresses in the reinforcement are derived from the stress-strain curve in Figure 2.2 with $\gamma_m = 1.05$.
- Where a section is designed to resist only flexure, the lever arm should not be assumed to be greater than 0.95 times the effective depth.

In the analysis of a cross-section of a beam that has to resist a small axial thrust, the effect of the design ultimate axial force may be ignored if it does not exceed $0.1f_{cu}$ times the cross-sectional area.

3.4.4.2 Design charts

The design charts which form BS 8110-3 includes charts, based on Figure 2.1, Figure 2.2 and the assumptions of 3.4.4.1, which may be used for the design of beams reinforced in tension only or in tension and compression.

3.4.4.3 Symbols

For the purposes of 3.4.4 the following symbols apply.

- A_s area of tension reinforcement.
- A_s' area of compression reinforcement.
- b width or effective width of the section or flange in the compression zone.
- b_w average web width of a flanged beam.
- d effective depth of the tension reinforcement.
- d' depth to the compression reinforcement.
- h_f thickness of the flange.
- M design ultimate moment.
- x depth to the neutral axis.
- z lever arm.
- β_b the ratio:

$$\frac{\text{(moment at the section after redistribution)}}{\text{(moment at the section before redistribution)}}$$
 from the respective maximum moments diagram.

3.4.4.4 Design formulae for rectangular beams

The following equations, which are based on the simplified stress block of Figure 3.3, are also applicable to flanged beams where the neutral axis lies within the flange:

$K' = 0.156$ where redistribution does not exceed 10 % (this implies a limitation of the neutral axis depth to $d/2$); or

$K' = 0.402(\beta_b - 0.4) - 0.18(\beta_b - 0.4)^2$ where redistribution exceeds 10 %

and $K = M/bd^2f_{cu}$.

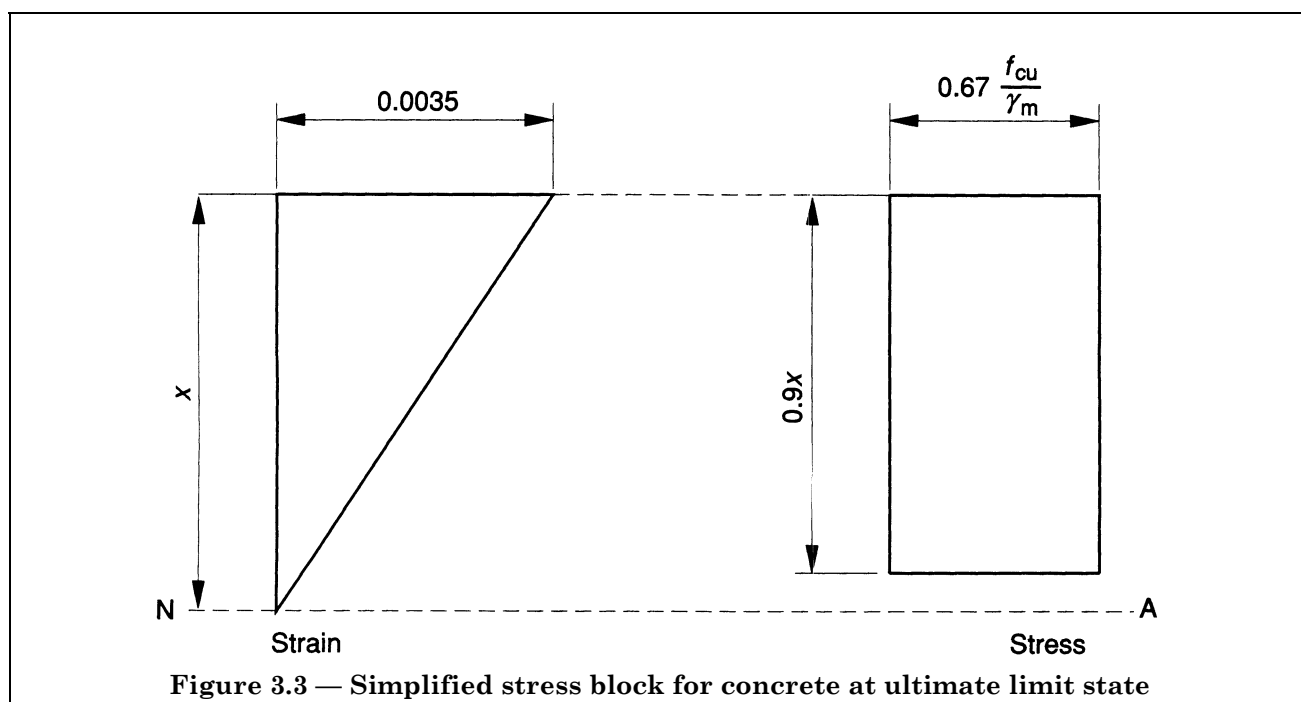

Table 3.6 — Values of the factor β_f

b/b_w	d/h_f					
	≤ 2	3	4	5	6	∞
1	0.15	0.15	0.15	0.15	0.15	0.15
2	0.15	0.14	0.12	0.12	0.11	0.08
4	0.15	0.13	0.11	0.10	0.09	0.04
6	0.15	0.13	0.11	0.09	0.08	0.03
8	0.15	0.13	0.10	0.09	0.08	0.02
∞	0.15	0.13	0.10	0.08	0.07	0

If $K \leq K'$, compression reinforcement is not required and:

$$z = d \left\{ 0.5 + \sqrt{\left(0.25 - \frac{K}{0.9} \right)} \right\}$$

but not greater than $0.95d$.

$$x = (d - z)/0.45$$

$$A_s = M/0.95f_y z$$

If $K > K'$, compression reinforcement is required and:

$$z = d \left\{ 0.5 + \sqrt{0.25 - \frac{K'}{0.9}} \right\}$$

$$x = (d - z)/0.45$$

$$A_s' = (K - K')f_{cu}bd^2/0.95f_y(d - d')$$

$$A_s = (K'f_{cu}bd^2/0.95f_yz + A_s')$$

If d'/x exceeds 0.37 (for $f_y = 460 \text{ N/mm}^2$), the compression stress will be less than $0.95f_y$ and should be obtained from Figure 2.2.

3.4.4.5 Design formulae for flanged beams where the neutral axis falls below the flange

Provided that the design ultimate moment is less than $\beta_f f_{cu} b d^2$ and that not more than 10 % of redistribution has been carried out, the required area of tension steel may be calculated using the following equation:

$$A_s = \frac{M + 0.1f_{cu}b_wd(0.45d - h_f)}{0.95f_y(d - 0.5h_f)} \quad \text{equation 1}$$

If the design ultimate moment exceeds $\beta_f f_{cu} b d^2$ or more than 10 % redistribution has been carried out, the section may be designed by direct application of the assumptions given in 3.4.4.1. β_f in this expression is a factor given in Table 3.6.

Equation 1 is only applicable when $h_f < 0.45d$.

The values in Table 3.6 are calculated from the following equation:

$$\beta_f = 0.45 \frac{h_f}{d} \left(1 - \frac{b_w}{b} \right) \left(1 - \frac{h_f}{2d} \right) + 0.15 \frac{b_w}{b} \quad \text{equation 2}$$

3.4.5 Design shear resistance of beams

3.4.5.1 Symbols

For the purposes of 3.4.5 the following symbols apply.

a_v length of that part of a member traversed by a shear failure plane.

A_c area of concrete section.

A_{sv} total cross-section of links at the neutral axis, at a section.

A_{sb} cross-sectional area of bent-up bars.

b_v breadth of section (for a flanged beam this should be taken as the average width of the rib below the flange.)

d effective depth.

f_{yv} characteristic strength of links (not to be taken as more than 460 N/mm^2).

M design ultimate moment at the section considered.

N design axial force.

s_v spacing of links along the member.

s_b spacing of bent-up bars.

V design shear force due to ultimate loads.

V_b design shear resistance of bent-up bars.

v design shear stress at a cross-section.

v_c design concrete shear stress (see Table 3.8).

v_c' design concrete shear stress corrected to allow for axial forces.

α angle between a bent-up bar and the axis of a beam.

β angle between the "compression strut" of a system of bent-up bars and the axis of the beam.

3.4.5.2 Shear stress in beams

The design shear stress v at any cross-section should be calculated from:

$$v = \frac{V}{b_v d} \quad \text{equation 3}$$

In no case should v exceed:

$0.8\sqrt{f_{cu}}$ or 5 N/mm^2 , whichever is the lesser, whatever shear reinforcement is provided. (This limit includes an allowance for γ_m of 1.25).

3.4.5.3 Shear reinforcement: form, area and stress

Shear reinforcement should be as given in Table 3.7. Stress in any bar should not exceed $0.95f_{yv}$.

3.4.5.4 Concrete shear stresses

Values for the design concrete shear stress v_c (in N/mm^2) are given in Table 3.8.

The term A_s is that area of longitudinal tension reinforcement which continues for a distance at least equal to d beyond the section being considered. At supports, the full area of tension reinforcement at the section may be applied in the table provided the requirements for curtailment and anchorage of reinforcement are met (see 3.12.9 where general recommendations and simplified rules are given).

At a monolithic beam-column junction where the beam has been designed on the assumption that the column provides a simple support but where some nominal top steel has been provided to control cracking, v_c may be calculated on the basis of the area of the bottom steel at the support provided that this has been anchored in accordance with the rules for detailing simply-supported ends given in 3.12.9.4 and 3.12.10.3.2. If this anchorage has not been provided then v_c should be calculated on the basis of the top steel. This steel should extend into the span for a distance of at least three times the effective depth from the face of the support.

3.4.5.5 Spacing of links (see Table 3.7)

The spacing of links in the direction of the span should not exceed $0.75d$. At right-angles to the span, the horizontal spacing should be such that no longitudinal tension bar is more than 150 mm from a vertical leg; this spacing should in any case not exceed d .

3.4.5.6 Shear resistance of bent-up bars

The design shear resistance of a system of bent-up bars may be calculated by assuming that the bent-up bars form the tension members of one or more single systems of trusses in which the concrete forms the compression members (see Figure 3.4). The resistance of a system of bent-up bars is given by the following equation:

$$V_b = A_{sb}(0.95f_{yv})(\cos \alpha + \sin \alpha \cot \beta) \frac{d-d'}{s_b} \quad \text{equation 4}$$

Table 3.7 — Form and area of shear reinforcement in beams

Value of v N/mm ²	Form of shear reinforcement to be provided	Area of shear reinforcement to be provided
Less than $0.5v_c$ throughout the beam	See NOTE 1	—
$0.5v_c < v < (v_c + 0.4)$	Minimum links for whole length of beam	$A_{sv} \geq 0.4b_v s_v / 0.95f_{yv}$ (see NOTE 2)
$(v_c + 0.4) < v < 0.8\sqrt{f_{cu}}$ or 5 N/mm^2	Links or links combined with bent-up bars. Not more than 50 % of the shear resistance provided by the steel may be in the form of bent-up bars (see NOTE 3)	Where links only provided: $A_{sv} \geq b_v s_v (v - v_c) / 0.95f_{yv}$ Where links and bent-up bars provided: see 3.4.5.6

NOTE 1 While minimum links should be provided in all beams of structural importance, it will be satisfactory to omit them in members of minor structural importance such as lintels or where the maximum design shear stress is less than half v_c .

NOTE 2 Minimum links provide a design shear resistance of 0.4 N/mm^2 .

NOTE 3 See **3.4.5.5** for guidance on spacing of links and bent-up bars.

Table 3.8 — Values of v_c design concrete shear stress

$\frac{100A_s}{b_v d}$	Effective depth mm							
	125	150	175	200	225	250	300	≥ 400
	N/mm ²	N/mm ²	N/mm ²	N/mm ²	N/mm ²	N/mm ²	N/mm ²	N/mm ²
≤ 0.15	0.45	0.43	0.41	0.40	0.39	0.38	0.36	0.34
0.25	0.53	0.51	0.49	0.47	0.46	0.45	0.43	0.40
0.50	0.67	0.64	0.62	0.60	0.58	0.56	0.54	0.50
0.75	0.77	0.73	0.71	0.68	0.66	0.65	0.62	0.57
1.00	0.84	0.81	0.78	0.75	0.73	0.71	0.68	0.63
1.50	0.97	0.92	0.89	0.86	0.83	0.81	0.78	0.72
2.00	1.06	1.02	0.98	0.95	0.92	0.89	0.86	0.80
≥ 3.00	1.22	1.16	1.12	1.08	1.05	1.02	0.98	0.91

NOTE 1 Allowance has been made in these figures for a γ_m of 1.25.

NOTE 2 The values in the table are derived from the expression:

$$0.79\{100A_s/(b_v d)\}^{1/2} (400/d)^{1/4} \gamma_m$$

where

$$\frac{100A_s}{b_v d} \text{ should not be taken as greater than } 3;$$

$$\frac{400}{d} \text{ should not be taken as less than } 1.$$

For characteristic concrete strengths greater than 25 N/mm^2 , the values in this table may be multiplied by $(f_{cu}/25)^{1/2}$. The value of f_{cu} should not be taken as greater than 40.

The truss should be arranged so that α and β are both greater than or equal to 45° giving a maximum value of s_t of $1.5d$. At least 50 % of the shear resistance provided by the steel should be in the form of links.

3.4.5.7 Anchorage and bearing of bent-up bars

Bars should be checked for anchorage (see **3.12.8.2** and **3.12.8.3**) and bearing (see **3.12.8.25**).

3.4.5.8 Enhanced shear strength of sections close to supports

Shear failure at sections of beams and cantilevers without shear reinforcement will normally occur on a plane inclined at an angle of about 30° to the horizontal. If the angle of failure plane is forced to be inclined more steeply than this (because the section considered (X – X) in Figure 3.5 is close to a support or for other reasons) the shear force required to produce failure is increased.

The enhancement of shear strength may be taken into account in the design of sections near a support by increasing the design concrete shear stress v_c to $2dv_c/a_v$ provided that v at the face of the support remains less than the lesser of $0.8\sqrt{f_{cu}}$ or 5 N/mm^2 (this limit includes a γ_m of 1.25).

Account may be taken of the enhancement in any situation where the section considered is closer to the face of a support or concentrated load than twice the effective depth, d . This enhancement is particularly useful for corbels (see 5.2.7) or pile-caps (see 3.11.4.4) or where concentrated loads are applied close to the support of a beam.

To be effective, tension reinforcement should extend on each side of the point where it is intersected by a possible failure plane for a distance at least equal to the effective depth, or be provided with an equivalent anchorage.

3.4.5.9 Shear reinforcement for sections close to supports

If shear reinforcement is required, the total area of this is given by:

$$\Sigma A_{sv} = a_v b_v (v - 2dv_c/a_v) / 0.95f_{yv} \geq 0.4b_v a_v / 0.95f_{yv} \quad \text{equation 5}$$

This reinforcement should be provided within the middle three-quarters of a_v . Where a_v is less than d horizontal shear reinforcement will be more effective than vertical.

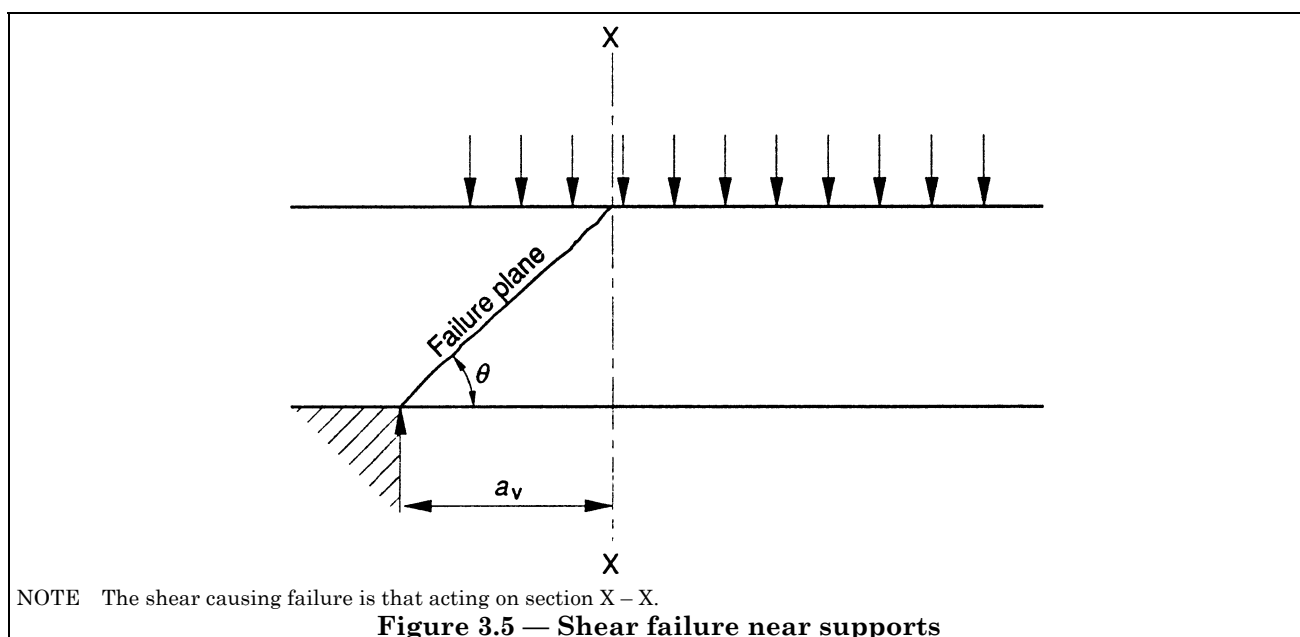
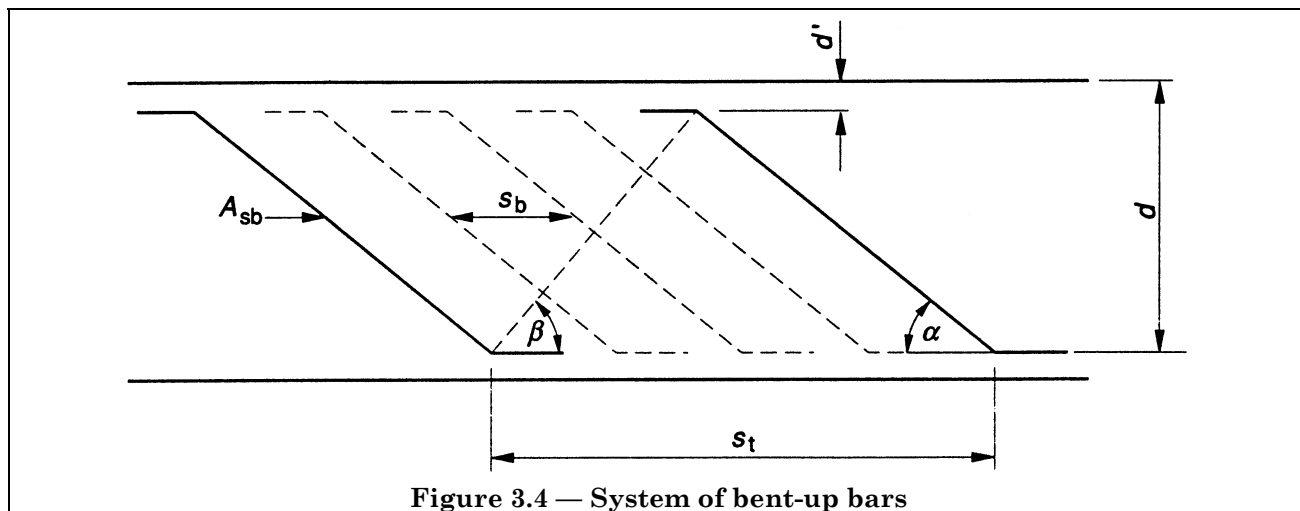

3.4.5.10 Enhanced shear strength near supports (simplified approach)

The procedures given in 3.4.5.8 and 3.4.5.9 may be used for all beams. However, for beams carrying generally uniform load or where the principal load is located further than $2d$ from the face of the support, the shear stress may be calculated at a section a distance d from the face of the support. The value of v_c is calculated in accordance with 3.4.5.4 and appropriate shear reinforcement assessed in accordance with Table 3.7. If this amount of shear reinforcement is provided at sections closer to the support, no further check for shear at such sections is required.

3.4.5.11 Bottom loaded beams

Where load is applied near the bottom of a section, sufficient vertical reinforcement to carry the load should be provided in addition to any reinforcement required to resist shear.

3.4.5.12 Shear and axial load

The design shear stress v_c' that can be supported by a section subjected to shear and axial compression without shear reinforcement can be calculated from equation 6a). Both adverse and beneficial load combinations should be considered (see Table 2.1).

$$v_c' = v_c + 0.6 \frac{NVh}{A_c M} \quad \text{equation 6a)}$$

where

v_c is the shear stress obtained from Table 3.8. This should not be adjusted in accordance with 3.4.5.8;

N is the applied axial load;

V is the shear,

M is the moment;

A_c is the gross area of the concrete section.

NOTE 1 N/A_c is intended to be the average stress in the concrete acting at the centroid of the section.

NOTE 2 The value of Vh/M should be taken as not greater than 1.

Where it is considered necessary to avoid shear cracking prior to the ultimate limit state, the shear stress should be limited to the value given by equation 6b).

$$v_c' = v_c \sqrt{1 + N/(A_c v_c)} \quad \text{equation 6b)}$$

If v exceeds v_c' shear reinforcement should be provided in accordance with Table 3.7 where v_c is replaced by v_c' .

v should not exceed $0.8\sqrt{f_{cu}}$ or 5 N/mm^2 .

For situations where the axial load is tensile, equations 6a) and 6b) may be used with N taken as negative.

3.4.5.13 Torsion

In normal slab-and-beam or framed construction specific calculations are not usually necessary, torsional cracking being adequately controlled by shear reinforcement but when the design relies on the torsional resistance of a member, explicit design for torsion will be necessary. Recommendations are given in 2.4 of BS 8110-2:1985.

3.4.6 Deflection of beams

3.4.6.1 General

Deflections may be calculated and then compared with the serviceability requirements given in section 3 of BS 8110-2:1985 but in all normal cases the deflections of a beam will not be excessive if the ratio of its span to its effective depth is not greater than the appropriate ratio obtained from 3.4.6.3 or 3.4.6.4. Where appropriate, Table 3.9 should be modified by Table 3.10 and Table 3.11.

3.4.6.2 Symbols

For the purposes of 3.4.6 the following symbols apply.

$A_{s \text{ prov}}$	area of tension reinforcement provided at mid-span (at support for cantilever).
$A_{s' \text{ prov}}$	area of compression reinforcement.
$A_{s \text{ req}}$	area of tension reinforcement required at mid-span to resist the moment due to design ultimate loads (at support for cantilever).
b	effective width of a rectangular beam, the effective flange width of a flanged beam or the total average width of the flanges.
b_w	average web width of a beam.
d	effective depth.
f_s	estimated design service stress in the tension reinforcement.
M	design ultimate moment at the centre of the span or, for a cantilever, at the support.
β_b	the ratio:

$$\frac{\text{(moment at the section after redistribution)}}{\text{(moment at the section before redistribution)}}$$

from the respective maximum moments diagram.

3.4.6.3 Span/effective depth ratio for a rectangular or flanged beam

The basic span/effective depth ratios for beams are given in Table 3.9. These are based on limiting the total deflection to span/250 and this should normally ensure that the part of the deflection occurring after construction of finishes and partitions will be limited to span/500 or 20 mm, whichever is the lesser, for spans up to 10 m. For values of b_w/b greater than 0.3, linear interpolation between the values given in Table 3.9 for rectangular sections and for flanged beams with b_w/b of 0.3 may be used.

Table 3.9 — Basic span/effective depth ratio for rectangular or flanged beams

Support conditions	Rectangular section	Flanged beams with $\frac{b_w}{b} \leq 0.3$
Cantilever	7	5.6
Simply supported	20	16.0
Continuous	26	20.8

3.4.6.4 Long spans

For spans exceeding 10 m, Table 3.9 should be used only if it is not necessary to limit the increase in deflection after the construction of partitions and finishes. Where limitation is necessary, the values in Table 3.9 should be multiplied by 10/span except for cantilevers where the design should be justified by calculation.

3.4.6.5 Modification of span/depth ratios for tension reinforcement

Deflection is influenced by the amount of tension reinforcement and its stress. The span/effective depth ratio should therefore be modified according to the ultimate design moment and the service stress at the centre of the span (or at the support in the case of a cantilever). Values of span/effective depth ratio obtained from Table 3.9 should be multiplied by the appropriate factor obtained from Table 3.10.

3.4.6.6 Modification of span/depth ratios for compression reinforcement

Compression reinforcement also influences deflection and the value of the span/effective depth ratio obtained from Table 3.9 modified by the factor obtained from Table 3.10 may be multiplied by a further factor obtained from Table 3.11.

3.4.6.7 Deflection due to creep and shrinkage

Permissible span/effective depth ratios obtained from Table 3.9 to Table 3.11 take account of normal creep and shrinkage deflection. If it is expected that creep or shrinkage of the concrete may be particularly high (e.g. if the free shrinkage strain is expected to be greater than 0.00075 or the creep coefficient greater than 3) or if other abnormally adverse conditions are expected, the permissible span/effective depth ratio should be suitably reduced. A reduction of more than 15 % is unlikely to be required (see also section 7 of BS 8110-2:1985 for creep coefficient).

3.4.7 Crack control in beams

Flexural cracking may be controlled by use of the rules of 3.12.11.2 (maximum distance between bars in tension). If greater spacings are required (e.g. between groups of bars), the expected crack widths should be checked by calculation (see section 3 of BS 8110-2:1985).

Table 3.10 — Modification factor for tension reinforcement

Service stress	M/bd^2									
	0.50	0.75	1.00	1.50	2.00	3.00	4.00	5.00	6.00	
$(f_y = 250)$	100	2.00	2.00	2.00	1.86	1.63	1.36	1.19	1.08	1.01
	150	2.00	2.00	1.98	1.69	1.49	1.25	1.11	1.01	0.94
	167	2.00	2.00	1.91	1.63	1.44	1.21	1.08	0.99	0.92
	200	2.00	1.95	1.76	1.51	1.35	1.14	1.02	0.94	0.88
	250	1.90	1.70	1.55	1.34	1.20	1.04	0.94	0.87	0.82
$(f_y = 460)$	300	1.60	1.44	1.33	1.16	1.06	0.93	0.85	0.80	0.76
	307	1.56	1.41	1.30	1.14	1.04	0.91	0.84	0.79	0.76

NOTE 1 The values in the table derive from the equation:

$$\text{Modification factor} = 0.55 + \frac{(477 - f_s)}{120 \left(0.9 + \frac{M}{bd^2}\right)} \leq 2.0 \quad \text{equation 7}$$

where

M is the design ultimate moment at the centre of the span or, for a cantilever, at the support.

NOTE 2 The design service stress in the tension reinforcement in a member may be estimated from the equation:

$$f_s = \frac{2f_y A_{s \text{ req}}}{3A_{s \text{ prov}}} \times \frac{1}{\beta_b} \quad \text{equation 8}$$

NOTE 3 For a continuous beam, if the percentage of redistribution is not known but the design ultimate moment at mid-span is obviously the same as or greater than the elastic ultimate moment, the stress f_s in this table may be taken as $2/3f_y$.

Table 3.11 — Modification factor for compression reinforcement

$100 \frac{A'_{s \text{ prov}}}{bd}$	Factor
0.00	1.00
0.15	1.05
0.25	1.08
0.35	1.10
0.50	1.14
0.75	1.20
1.0	1.25
1.5	1.33
2.0	1.40
2.5	1.45
≥ 3.0	1.50

NOTE 1 The values in this table are derived from the following equation:

Modification factor for compression reinforcement =

$$1 + \frac{100A'_{s \text{ prov}}}{bd} \left(3 + \frac{100A'_{s \text{ prov}}}{bd} \right) \leq 1.5 \quad \text{equation 9}$$

NOTE 2 The area of compression reinforcement A used in this table may include all bars in the compression zone, even those not effectively tied with links.

3.5 Solid slabs supported by beams or walls

3.5.1 Design

In general, the recommendations given in 3.4 for beams will apply also to solid slabs but 3.5.2 to 3.5.8 should be taken into account.

3.5.2 Moments and forces

3.5.2.1 General

In addition to the methods used for beams, the moments and shear forces resulting from both distributed and concentrated loads may be determined by appropriate elastic analyses. Alternatively, Johansen's yieldline method or Hillerborg's strip method may be used provided the ratio between support and span moments are similar to those obtained by the use of the elastic theory.

3.5.2.2 Distribution of concentrated loads on slabs

If a slab is simply supported on two opposite edges and carries one or more concentrated loads in a line in the direction of the span, it should be designed to resist the maximum bending moment caused by the loading system. Such bending moment may be assumed to be resisted by an effective width of slab (measured parallel to the supports) as follows.

- a) For solid slabs, the effective width may be taken as the sum of the load width and $2.4x(1 - x/l)$ where x is the distance from the nearer support to the section under consideration and l is the span.
- b) For other slabs, except where specially provided for, the effective width will depend on the ratio of the transverse and longitudinal flexural rigidities of the slab. When these are approximately equal, the value for the effective width as given for solid slabs may be used, but as the ratio decreases a smaller value should be taken. The minimum value which need be taken, however, is the load width plus $4x/l(1 - x/l)$ metres where x and l are as defined in a) so that, for a section at mid-span, the effective width is equal to 1 m plus the load width.
- c) Where the concentrated load is near an unsupported edge of a slab the effective width should not exceed the value in a) or b) above as appropriate, nor half that value plus the distance of the centre of the load from the unsupported edge (see Figure 3.6).

3.5.2.3 Simplification of load arrangements

In principle a slab should be designed to withstand the most unfavourable arrangements of design loads; however, slabs will normally be able to satisfy this requirement if they are designed to resist the moments and forces arising from the single-load case of maximum design load on all spans or panels provided the following conditions are met.

- a) In a one-way spanning slab the area of each bay exceeds 30 m^2 .
In this context, a bay means a strip across the full width of a structure bounded on the other two sides by lines of support (see Figure 3.7).
- b) The ratio of the characteristic imposed load the characteristic dead load does not exceed 1.25.
- c) The characteristic imposed load does not exceed 5 kN/m^2 excluding partitions.

Where analysis is carried out for the single load case of all spans loaded, the resulting support moments except those at the supports of cantilevers should be reduced by 20 %, with a consequential increase in the span moments.

The resulting bending moment envelope should satisfy the provisions of 3.2.2.1. No further redistribution should be carried out.

Where a span or panel is adjacent to a cantilever of significant length, the possibility should be considered of the case of slab unloaded/cantilever loaded.

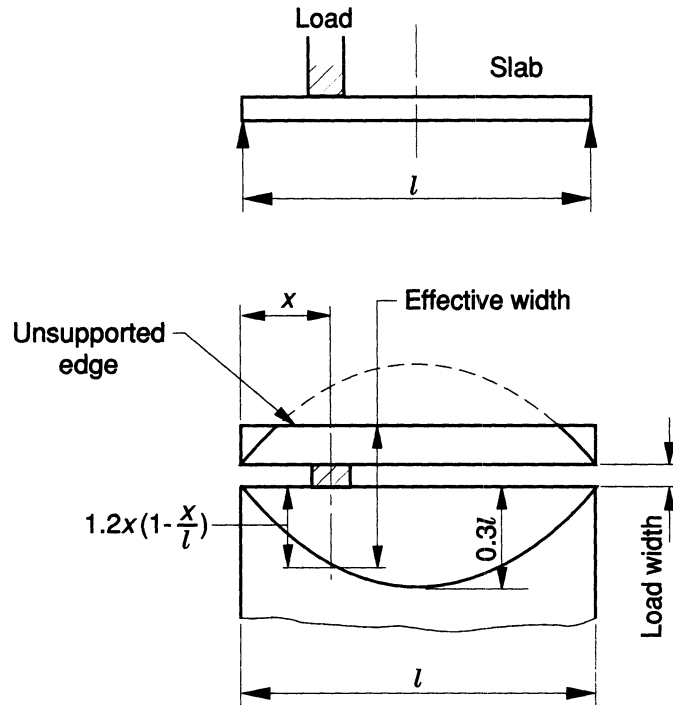

Figure 3.6 — Effective width of solid slab carrying a concentrated load near an unsupported edge

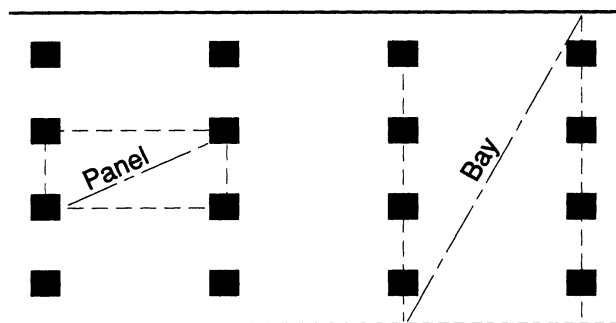

Figure 3.7 — Definition of panels and bays

3.5.2.4 One-way spanning slabs of approximately equal span: uniformly distributed loads

Where the conditions of 3.5.2.3 are met, the moments and shears in continuous one-way spanning slabs may be calculated using the coefficients given in Table 3.12. Allowance has been made in these coefficients for the 20 % redistribution mentioned above.

The curtailment of reinforcement designed in accordance with Table 3.12 may be carried out in accordance with the provisions of 3.12.10.

Table 3.12 — Ultimate bending moment and shear forces in one-way spanning slabs

	End support/slab connection				At first interior support	Middle interior spans	Interior supports
	Simple		Continuous				
	At outer support	Near middle of end span	At outer support	Near middle of end span			
Moment	0	$0.086Fl$	$-0.04Fl$	$0.075Fl$	$-0.086Fl$	$0.063Fl$	$-0.063Fl$
Shear	$0.4F$	—	$0.46F$	—	$0.6F$	—	$0.5F$
NOTE	F is the total design ultimate load ($1.4G_k + 1.6Q_k$); l is the effective span.						

3.5.3 Solid slabs spanning in two directions at right angles: uniformly distributed loads

3.5.3.1 General

Subclauses 3.5.3.3 to 3.5.3.7 may be used for the design of slabs spanning in two directions at right angles and supporting uniformly distributed loads.

3.5.3.2 Symbols

For the purposes of 3.5.3, the following symbols apply.

- l_x length of shorter side.
- l_y length of longer side.
- m_{sx} maximum design ultimate moments either over supports or at mid-span on strips of unit width and span l_x .
- m_{sy} maximum design ultimate moments either over supports or at mid-span on strips of unit width and span l_y .
- n total design ultimate load per unit area ($1.4G_k + 1.6Q_k$).
- N_d number of discontinuous edges ($0 \leq N \leq 4$).
- v_{sx} design end shear on strips of unit width and span l_x and considered to act over the middle three-quarters of the edge.
- v_{sy} design end shear on strips of unit width and span l_y and considered to act over the middle three-quarters of the edge.
- β_x sagging moment in the span, per unit width, in the direction of the shorter span, l_x , divided by nl_x^2 .
- β_y sagging moment in the span, per unit width, in the direction of the longer span, l_y divided by nl_x^2 .
- β_1 and β_2 hogging moments, per unit width, over the shorter edges divided by nl_x^2 .
- β_3 and β_4 hogging moments, per unit width, over the longer edges divided by nl_x^2 .
- α_{sx} α_{sy} moment coefficients shown in Table 3.13.
- β_{sx} and β_{sy} moment coefficients shown in Table 3.14.
- β_{vx} and β_{vy} shear force coefficients shown in Table 3.15.

3.5.3.3 Simply-supported slabs

When simply-supported slabs do not have adequate provision to resist torsion at the corners, and to prevent the corners from lifting, the maximum moments per unit width are given by the following equations:

$$m_{sx} = \alpha_{sx}nl_x^2 \quad \text{equation 10}$$

$$m_{sy} = \alpha_{sy}nl_x^2 \quad \text{equation 11}$$

NOTE Values for a_{sx} and a_{sy} are given in Table 3.13.

The values in Table 3.13 are derived from the following equations:

$$\alpha_{sx} = \frac{(l_y/l_x)^4}{8\{1 + (l_y/l_x)^4\}} \quad \text{equation 12}$$

$$\alpha_{sy} = \frac{(l_y/l_x)^2}{8\{1 + (l_y/l_x)^4\}} \quad \text{equation 13}$$

3.5.3.4 Restrained slabs

In slabs where the corners are prevented from lifting, and provision for torsion is made, the maximum design moments per unit width are given by equations 14 and 15:

$$m_{sx} = \beta_{sx} n l_x^2 \quad \text{equation 14}$$

$$m_{sy} = \beta_{sy} n l_x^2 \quad \text{equation 15}$$

Where these equations are used, the conditions and rules of 3.5.3.5 should be applied.

NOTE Values of β_{sx} and β_{sy} are given in Table 3.14.

Equations 14 and 15 and the coefficients in Table 3.14 may be derived from the following equations:

$$\beta_y = (24 + 2N_d + 1.5N_d^2)/1000 \quad \text{equation 16}$$

$$\gamma = \frac{2}{9} [3 - \sqrt{(18) \frac{l_x}{l_y} \{ \sqrt{(\beta_y + \beta_1)} + \sqrt{(\beta_y + \beta_2)} \}}] \quad \text{equation 17}$$

$$\sqrt{\gamma} = \sqrt{(\beta_x + \beta_3)} + \sqrt{(\beta_x + \beta_4)} \quad \text{equation 18}$$

NOTE β_1 and β_2 take values of $4/3\beta_y$ for continuous edges or zero for discontinuous edges.

β_3 and β_4 take values of $4/3\beta_x$ for continuous edges or zero for discontinuous edges.

3.5.3.5 Restrained slabs where the corners are prevented from lifting and adequate provision is made for torsion: conditions and rules for the use of equations 14 and 15

The conditions in which the equations may be used for continuous slabs only are as follows.

- a) The characteristic dead and imposed loads on adjacent panels are approximately the same as on the panel being considered.
- b) The span of adjacent panels in the direction perpendicular to the line of the common support is approximately the same as the span of the panel considered in that direction.

The rules to be observed when the equations are applied to restrained slabs (continuous or discontinuous) are as follows.

- 1) Slabs are considered as divided in each direction into middle strips and edge strips as shown in Figure 3.9, the middle strip being three-quarters of the width and each edge strip one-eighth of the width.
- 2) The maximum design moments calculated as above apply only to the middle strips and no redistribution should be made.
- 3) Reinforcement in the middle strips should be detailed in accordance with 3.12.10 (simplified rules for curtailment of bars).
- 4) Reinforcement in an edge strip, parallel to the edge, need not exceed the minimum given in 3.12.5 (minimum areas of tension reinforcement), together with the recommendations for torsion given in 5), 6) and 7).

5) Torsion reinforcement should be provided at any corner where the slab is simply supported on both edges meeting at that corner. It should consist of top and bottom reinforcement, each with layers of bars placed parallel to the sides of the slab and extending from the edges a minimum distance of one-fifth of the shorter span. The area of reinforcement in each of these four layers should be three-quarters of the area required for the maximum mid-span design moment in the slab.

6) Torsion reinforcement equal to half that described in the preceding paragraph should be provided at a corner contained by edges over only one of which the slab is continuous.

7) Torsion reinforcement need not be provided at any corner contained by edges over both of which the slab is continuous.

3.5.3.6 Restrained slab with unequal conditions at adjacent panels

In some cases the support moments calculated from Table 3.14, for adjacent panels, may differ significantly. To adjust them the following procedures may be used.

a) Calculate the sum of the midspan moment and the average of the support moments (neglecting signs) for each panel.

b) Treat the values from Table 3.14 as fixed end moments (FEMs).

c) Distribute the FEMs across the supports according to the relative stiffness of adjacent spans, giving new support moments.

d) Adjust midspan moment for each panel: this should be such that when it is added to the average of the support moments from c) (neglecting signs) the total equals that from a).

If, for a given panel, the resulting support moments are now significantly greater than the value from Table 3.14, the tension steel over the supports will need to be extended beyond the provisions of 3.12.10.3. The procedure should be as follows.

e) The span moment is taken as parabolic between supports; its maximum value is as found from d).

f) The points of contraflexure of the new support moments [from c)] with the span moment [from e)] are determined.

g) At each end half the support tension steel is extended to at least an effective depth or 12 bar diameters beyond the nearest point of contraflexure.

h) At each end the full area of the support tension steel is extended to half the distance from g).

3.5.3.7 Loads on supporting beams

The design loads on beams supporting solid slabs spanning in two directions at right angles and supporting uniformly distributed loads may be assessed from the following equations:

$$v_{sy} = \beta_{vy} n l_x \quad \text{equation 19}$$

$$v_{sx} = \beta_{vx} n l_x \quad \text{equation 20}$$

Where design ultimate support moments are used which differ substantially from those that would be assessed from Table 3.14, adjustment of the values given in Table 3.15 may be necessary. The assumed distribution of the load on a supporting beam is shown in Figure 3.10.

Table 3.13 — Bending moment coefficients for slabs spanning in two directions at right angles, simply-supported on four sides

l_y/l_x	1.0	1.1	1.2	1.3	1.4	1.5	1.75	2.0
α_{sx}	0.062	0.074	0.084	0.093	0.099	0.104	0.113	0.118
α_{sy}	0.062	0.061	0.059	0.055	0.051	0.046	0.037	0.029

Table 3.14 — Bending moment coefficients for rectangular panels supported on four sides with provision for torsion at corners

Type of panel and moments considered	Short span coefficients, β_{sx}								Long span coefficients, β_{sy} for all values of l_y/l_x
	Values of l_y/l_x								
	1.0	1.1	1.2	1.3	1.4	1.5	1.75	2.0	
Interior panels									
Negative moment at continuous edge	0.031	0.037	0.042	0.046	0.050	0.053	0.059	0.063	0.032
Positive moment at mid-span	0.024	0.028	0.032	0.035	0.037	0.040	0.044	0.048	0.024
One short edge discontinuous									
Negative moment at continuous edge	0.039	0.044	0.048	0.052	0.055	0.058	0.063	0.067	0.037
Positive moment at mid-span	0.029	0.033	0.036	0.039	0.041	0.043	0.047	0.050	0.028
One long edge discontinuous									
Negative moment at continuous edge	0.039	0.049	0.056	0.062	0.068	0.073	0.082	0.089	0.037
Positive moment at mid-span	0.030	0.036	0.042	0.047	0.051	0.055	0.062	0.067	0.028
Two adjacent edges discontinuous									
Negative moment at continuous edge	0.047	0.056	0.063	0.069	0.074	0.078	0.087	0.093	0.045
Positive moment at mid-span	0.036	0.042	0.047	0.051	0.055	0.059	0.065	0.070	0.034
Two short edges discontinuous									
Negative moment at continuous edge	0.046	0.050	0.054	0.057	0.060	0.062	0.067	0.070	—
Positive moment at mid-span	0.034	0.038	0.040	0.043	0.045	0.047	0.050	0.053	0.034
Two long edges discontinuous									
Negative moment at continuous edge	—	—	—	—	—	—	—	—	0.045
Positive moment at mid-span	0.034	0.046	0.056	0.065	0.072	0.078	0.091	0.100	0.034
Three edges discontinuous (one long edge continuous)									
Negative moment at continuous edge	0.057	0.065	0.071	0.076	0.081	0.084	0.092	0.098	—
Positive moment at mid-span	0.043	0.048	0.053	0.057	0.060	0.063	0.069	0.074	0.044
Three edges discontinuous (one short edge continuous)									
Negative moment at continuous edge	—	—	—	—	—	—	—	—	0.058
Positive moment at mid-span	0.042	0.054	0.063	0.071	0.078	0.084	0.096	0.105	0.044
Four edges discontinuous									
Positive moment at mid-span	0.055	0.065	0.074	0.081	0.087	0.092	0.103	0.111	0.056

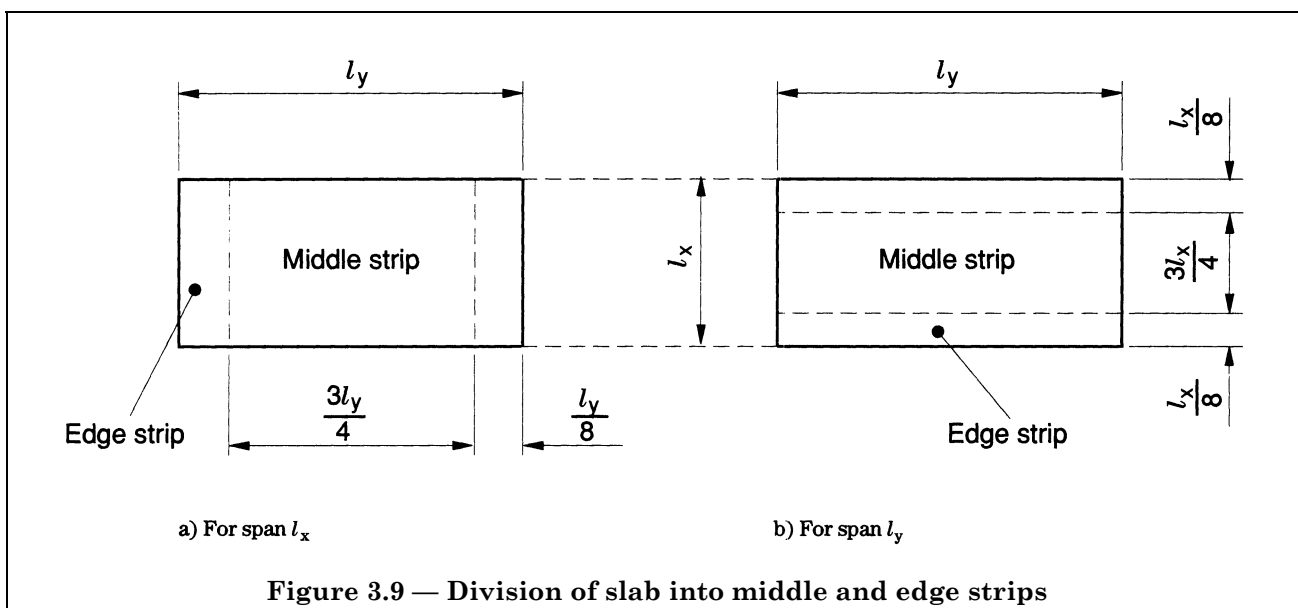
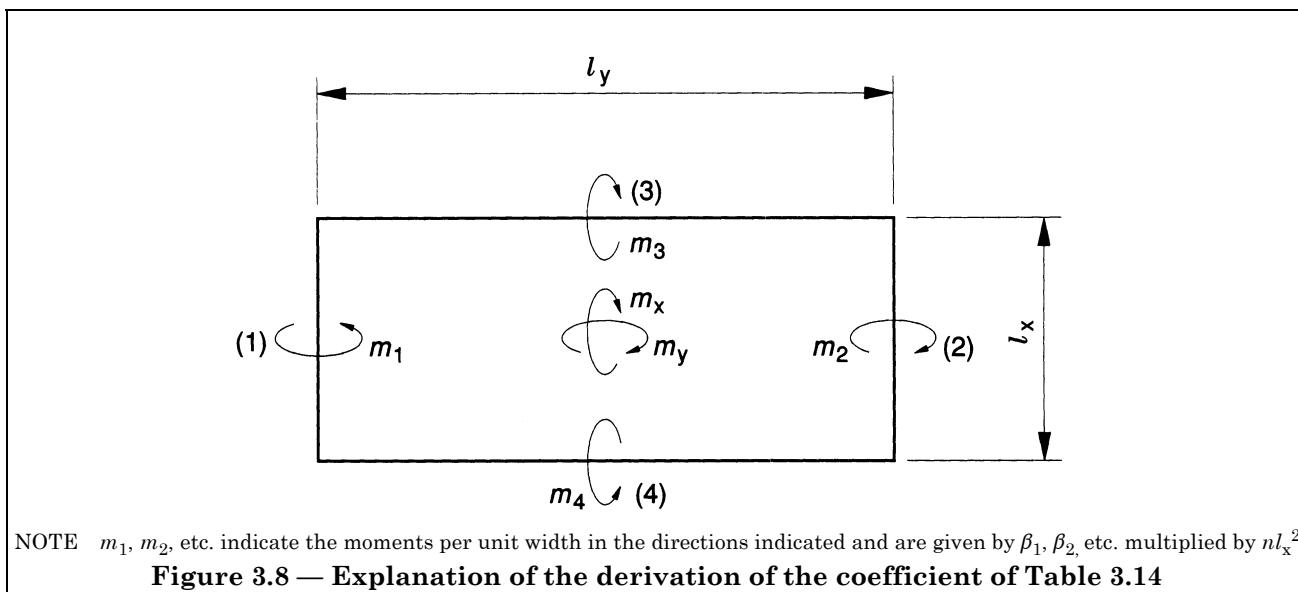

Table 3.15 — Shear force coefficient for uniformly loaded rectangular panels supported on four sides with provision for torsion at corners

Type of panel and location	β_{vx} for values of l_y/l_x								β_{vy}
	1.0	1.1	1.2	1.3	1.4	1.5	1.75	2.0	
Four edges continuous									
Continuous edge	0.33	0.36	0.39	0.41	0.43	0.45	0.48	0.50	0.33
One short edge discontinuous									
Continuous edge	0.36	0.39	0.42	0.44	0.45	0.47	0.50	0.52	0.36
Discontinuous edge	—	—	—	—	—	—	—	—	0.24
One long edge discontinuous									
Continuous edge	0.36	0.40	0.44	0.47	0.49	0.51	0.55	0.59	0.36
Discontinuous edge	0.24	0.27	0.29	0.31	0.32	0.34	0.36	0.38	—
Two adjacent edges discontinuous									
Continuous edge	0.40	0.44	0.47	0.50	0.52	0.54	0.57	0.60	0.40
Discontinuous edge	0.26	0.29	0.31	0.33	0.34	0.35	0.38	0.40	0.26
Two short edges discontinuous									
Continuous edge	0.40	0.43	0.45	0.47	0.48	0.49	0.52	0.54	—
Discontinuous edge	—	—	—	—	—	—	—	—	0.26
Two long edges discontinuous									
Continuous edge	—	—	—	—	—	—	—	—	0.40
Discontinuous edge	0.26	0.30	0.33	0.36	0.38	0.40	0.44	0.47	—
Three edges discontinuous (one long edge discontinuous)									
Continuous edge	0.45	0.48	0.51	0.53	0.55	0.57	0.60	0.63	—
Discontinuous edge	0.30	0.32	0.34	0.35	0.36	0.37	0.39	0.41	0.29
Three edges discontinuous (one short edge discontinuous)									
Continuous edge	—	—	—	—	—	—	—	—	0.45
Discontinuous edge	0.29	0.33	0.36	0.38	0.40	0.42	0.45	0.48	0.30
Four edges discontinuous									
Discontinuous edge	0.33	0.36	0.39	0.41	0.43	0.45	0.48	0.50	0.33

3.5.4 Resistance moment of solid slabs

The design ultimate resistance moment of a cross-section of a solid slab may be determined by the methods given in 3.4.4 for beams.

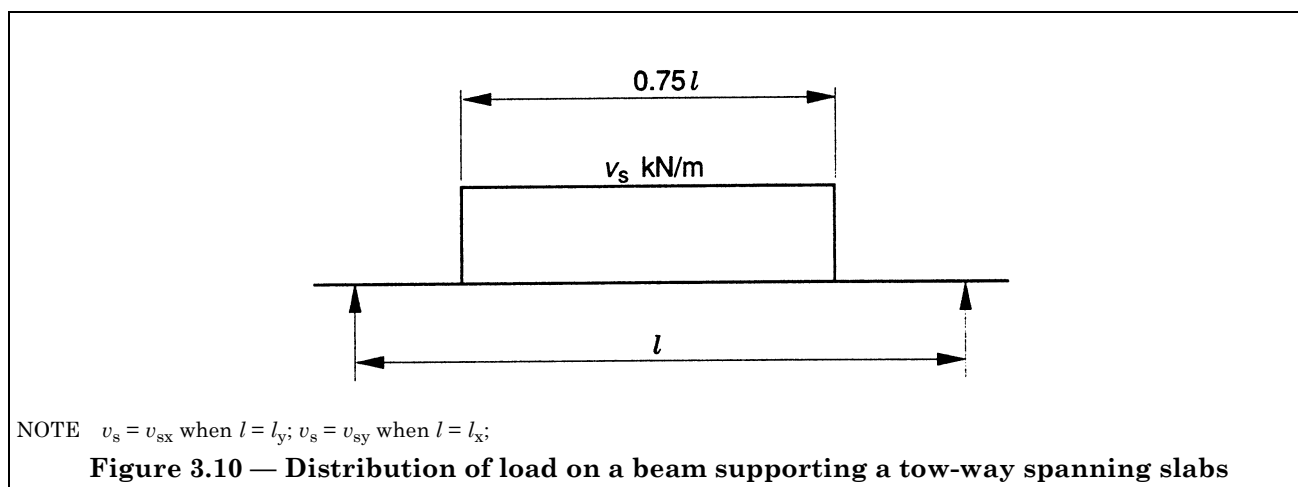

Table 3.16 — Form and area of shear reinforcement in solid slabs

Value of v N/mm^2	Form of shear reinforcement to be provided	Area of shear reinforcement to be provided
$v < v_c$	None required	None
$v_c < v < (v_c + 0.4)$	Minimum links in areas where $v > v_c$	$A_{sv} \geq 0.4bs_v/0.95f_{yv}$
$(v_c + 0.4) < v < 0.8\sqrt{f_{cu}}$ or 5 N/mm^2	Links and/or bent-up bars in any combination (but the spacing between links or bent-up bars need not be less than d)	Where links only provided: $A_{sv} \geq bs_v(v - v_c)/0.95f_{yv}$ Where bent-up bars only provided: $A_{sb} \geq bs_b(v - v_c)/\{0.95f_{yv}$ $(\cos \alpha + \sin \alpha \times \cot \beta)\}$ (see 3.4.5.7)
NOTE 1 It is difficult to bend and fix shear reinforcement so that its effectiveness can be assured in slabs less than 200 mm deep. It is therefore not advisable to use shear reinforcement in such slabs.		
NOTE 2 The enhancement in design shear strength close to supports described in 3.4.5.8, 3.4.5.9 and 3.4.5.10 may also be applied to solid slabs.		

3.5.5 Shear resistance of solid slabs

3.5.5.1 Symbols

For the purposes of 3.5.5 the following symbols apply.

- A_{sv} area of shear links in a zone.
- A_{sb} area of bent-up bars in a zone.
- b breadth of slab under consideration.
- d effective depth or average effective depth of a slab.
- f_{yv} characteristic strength of the shear reinforcement which should not be taken as greater than 460 N/mm^2 .
- v nominal design shear stress.
- v_c design ultimate shear stress obtained from Table 3.8.
- V shear force due to design ultimate loads or the design ultimate value of a concentrated load.
- α angle between the shear reinforcement and the plane of the slab
- s_b spacing of bent-up bars (see Figure 3.4).
- s_v spacing of links.

3.5.5.2 Shear stresses

The design shear stress v at any cross-section should be calculated from equation 21:

$$v = \frac{V}{bd} \quad \text{equation 21}$$

In no case should v exceed $0.8\sqrt{f_{cu}}$ or 5 N/mm^2 , whichever is the lesser, whatever shear reinforcement is provided.

3.5.5.3 Shear reinforcement

Recommendations for shear reinforcement in solid slabs are given in Table 3.16.

3.5.6 Shear in solid slabs under concentrated loads

The provisions of 3.7.7 may be applied.

3.5.7 Deflection

Deflections may be calculated and compared with the serviceability requirements given in section 3 of BS 8110-2:1985 but, in all normal cases, it will be sufficient to restrict the span/effective depth ratio. The appropriate ratio may be obtained from Table 3.9 and modified by Table 3.10. Only the conditions at the centre of the span in the width of slab under consideration should be considered to influence deflection.

The ratio for a two-way spanning slab should be based on the shorter span.

3.5.8 Crack control

In general the reinforcement spacing rules given in 3.12.11 will be the best means of controlling flexural cracking in slabs, but, in certain cases, advantage may be gained by calculating crack widths (see section 3 of BS 8110-2:1985).

3.6 Ribbed slabs (with solid or hollow blocks or voids)

3.6.1 General

3.6.1.1 Introduction

The term "ribbed slab" in this sub-clause refers to in situ slabs constructed in one of the following ways.

a) *Where topping is considered to contribute to structural strength* (see Table 3.17 for minimum thickness):

- 1) as a series of concrete ribs cast in situ between blocks which remain part of the completed structure; the tops of the ribs are connected by a topping of concrete of the same strength as that used in the ribs;
- 2) as a series of concrete ribs with topping cast on forms which may be removed after the concrete has set;
- 3) with a continuous top and bottom face but containing voids of rectangular, oval or other shape.

b) *Where topping is not considered to contribute to structural strength*: as a series of concrete ribs cast in situ between blocks which remain part of the completed structure; the tops of the ribs may be connected by a topping of concrete (not necessarily of the same strength as that used in the ribs).

3.6.1.2 Hollow or solid blocks and formers

Hollow or solid blocks and formers may be of any suitable material but, when required to contribute to the structural strength of a slab, they should:

- a) be made of concrete or burnt clay;
- b) have a characteristic strength of at least 14 N/mm^2 , measured on the net section, when axially loaded in the direction of compressive stress in the slab;
- c) when made of fired brickearth, clay or shale, conform to BS 3921.

3.6.1.3 Spacing and size of ribs

In situ ribs should be spaced at centres not exceeding 1.5 m and their depth, excluding any topping, should not exceed four times their width. The minimum width of rib will be determined by considerations of cover, bar spacing and fire.

3.6.1.4 Non-structural side support

Where the side of a slab is built into a wall or rests on a beam parallel to the ribs, that side should be strengthened by the formation of a rib of width equal to that of the bearing.

3.6.1.5 Thickness of topping used to contribute to structural strength

The thickness after any necessary allowance has been made for wear, should be not less than those of Table 3.17.

3.6.1.6 Hollow block slabs where topping is not used to contribute to structural strength

When a slab is constructed to b) of Table 3.17 the blocks should conform to 3.6.1.2. In addition the thickness of the block material above its void should be not less than 20 mm nor less than one-tenth of the dimension of the void measured transversely to the ribs. The overall thickness of the block and topping (if any) should be not less than one-fifth of the distance between ribs.

Table 3.17 — Minimum thickness of structural toppings

Type of slab	Minimum thickness of topping mm
<i>Slabs with permanent blocks as described in 3.6.1.1 a) 1) and 3.6.1.2</i> a) Clear distance between ribs not more than 500 mm jointed in cement: sand mortar not weaker than 1 : 3 or 11 N/mm ² b) Clear distance between ribs not more than 500 mm, not jointed in cement: sand mortar c) All other slabs with permanent blocks	25 30 40 or one-tenth of clear distance between ribs, whichever is greater
<i>All slabs without permanent blocks</i> As described in 3.6.1.1 a) 2) and 3	50 or one-tenth of clear distance between ribs, whichever is greater

3.6.2 Analysis of structure

The moments and forces due to design ultimate loads on continuous slabs may be obtained by any of the methods given in 3.5.2 for solid slabs. Where the slabs are ribbed in two directions, they may be designed as two-way spanning in accordance with 3.5.3 or as flat slabs in accordance with 3.7, whichever is the more appropriate.

Alternatively, if it is impracticable to provide sufficient reinforcement to develop the full design support moment, the slabs may be designed as a series of simply-supported spans. If this is done, sufficient reinforcement should be provided over the support to control cracking. It is recommended that such reinforcement should have an area of not less than 25 % of that in the middle of the adjoining spans and should extend at least 15 % of the spans into the adjoining spans.

3.6.3 Design resistance moments

The provisions given in 3.4.4 for determining the design ultimate resistance moment of beams may be used. In the analysis of sections the stresses in burnt clay blocks or solid blocks in the compression zone may be taken as 0.25 times the strength determined in 3.6.1.2 b); however, when evidence is available to show that not more than 5 % of the blocks have strength below a specified crushing strength, the stress may be taken as 0.3 times that strength.

3.6.4 Shear

3.6.4.1 Flat slab construction

If the design assumes this method 3.7.6 should be used. Where a critical perimeter (see 1.2.3.1) cuts any ribs, they should each be designed to resist an equal proportion of the applied effective design shear force. Shear links in the ribs should continue for a distance of at least d into the solid area.

3.6.4.2 One- or two-way spanning slabs

The design shear stress v should be calculated from equation 22:

$$v = \frac{V}{b_v d} \quad \text{equation 22}$$

where

- V is the design shear force due to design ultimate loads on a width of slab equal to the centre distance between ribs;
- b_v is the average width of the rib;
- d is the effective depth.

3.6.4.3 Shear contribution by hollow blocks

In equation 22, b_v may be increased by the wall thickness of the block on one side of the rib.

3.6.4.4 Shear contribution from solid blocks

Where blocks satisfy 3.6.1.2, b_v in equation 22 may be increased by one-half of the rib depth on each side of the rib.

3.6.4.5 Shear contribution by joints between narrow precast units

In equation 22, b_v may be increased by the width of mortar or concrete joint.

3.6.4.6 Maximum design shear stress

In no case should v exceed $0.8\sqrt{f_{cu}}$ or 5 N/mm^2 , whichever is the lesser (this includes an allowance for γ_m of 1.25).

3.6.4.7 Area of shear reinforcement in ribbed hollow block or voided slabs

No shear reinforcement is required when v is less than v_c (where v_c is obtained from Table 3.8). When v equals or exceeds v_c reinforcement conforming to Table 3.16 should be provided.

3.6.5 Deflection in ribbed, hollow block or voided construction generally

3.6.5.1 General

For one-way spanning floors, the span/effective depth ratios should be checked in accordance with 3.4.6 except that the rib width may include the walls of the blocks on both sides of the rib. For slabs spanning in two directions on to walls or beams, the check should be carried out for the shorter span. Where the slab is designed as a flat slab, the provisions of 3.7.8 apply.

3.6.5.2 Rib width of voided slabs or slabs of box or I-section units

In deriving the basic ratio from Table 3.9, b_v may be calculated assuming all material below the upper flange of the unit to be concentrated in a rectangular rib having the same cross-sectional area and depth.

3.6.6 Arrangement of reinforcement

3.6.6.1 Curtailment of bars

The reinforcement should be curtailed in accordance with 3.12.9. However, where appropriate, the simplified rules given in 3.12.10 may be used.

3.6.6.2 Reinforcement in topping for ribbed or hollow block slabs

Consideration should be given to providing a single layer of welded steel fabric, having a cross-sectional area of not less than 0.12 % of the topping, in each direction; the spacing between wires should not be greater than half the centre-to-centre distance between ribs.

3.6.6.3 Links in ribs

Provided the geometry satisfies 3.6.1.3 ribs reinforced with a single bar or ribs in waffle slabs do not require links unless shear or fire resistance requirements so dictate. However consideration should be given to the use of purpose made spacers occupying the full width of the rib to ensure correct cover to the bar.

Where two or more bars are used in a rib, the use of link reinforcement in addition to normal spacers is recommended except in waffle slabs, to ensure correct cover to reinforcement. The spacing of the links can generally be of the order of 1 m to 1.5 m depending on the size of the main bars

The cover of the link reinforcement should satisfy the durability requirement of Table 3.4 but need not satisfy the requirements for fire resistance in Table 3.5 provided the cover to the main bars does so.

3.7 Flat slabs

NOTE See 1.2.2 for definitions specific to flat slabs.

3.7.1 General

3.7.1.1 Symbols

For the purposes of 3.7 the following symbols apply.

a_v	distance from the edge of the loaded area to the perimeter considered.
A_{sv}	area of shear reinforcement
b_e	breadth of effective moment transfer strip (see Figure 3.13).
$C_x C_y$	plan dimensions of column (see Figure 3.13).
d_h	depth of the head.
F	total design ultimate load on the full width of panel between adjacent bay centre lines ($= 1.4G_k + 1.6Q_k$).
f_{yv}	characteristic strength of shear reinforcement.
h_c	effective diameter of a column or column head.
l	given in Table 3.12 should be taken as the full panel length in the direction of span.
l_1	panel length parallel to span, measured from centres of columns.
l_2	panel width, measured from centres of columns l_h .
l_c	dimensions of the column measured in the same direction as l_h .
l_h	effective dimension of a head.
l_x	shorter span of flat slab panel.
l_y	longer span of flat slab panel.
M_t	design moment transferred between slab and column.
n	design ultimate load per unit area ($= 1.4g_k + 1.6q_k$).
u	effective length of the outer perimeter of the zone.
u_o	effective length of the perimeter which touches a loaded area.
v	design shear stress.
v_c	design concrete shear stress.
V	design ultimate value of the concentrated load.
V_t	design shear transferred to column.
V_{eff}	design effective shear including allowance for moment transfer.
x	dimension of a shear perimeter parallel to axis of bending.
α	angle between the shear reinforcement and the plane of the slab.

3.7.1.2 Design

Provisions are given for the design of flat slabs supported by a generally rectangular arrangement of columns using the equivalent frame method and where the ratio of the longer to the shorter spans does not exceed 2. Other approaches to the design of flat slabs are acceptable; for example, design based on the methods referred to in 3.5.2.1 or on a finite element analysis. In such cases, the applicability of the provisions given in this section are a matter of judgement. Further provisions for waffle or coffered slabs are given in 3.6.

3.7.1.3 Column head

For the purposes of 3.7, the dimensions of a column head which may be considered to be effective are limited according to the depth of the head.

In any direction, the effective dimension of a head l_h should be taken as the lesser of the actual dimension l_{ho} or $l_{h \max}$ where $l_{h \max}$ (in millimetres) is given by:

$$l_{h \max} = l_c + 2(d_h - 40) \quad \text{equation 23}$$

For a flared head, the actual dimension l_{ho} is that measured 40 mm below the soffit of the slab or drop (see Figure 3.11).

3.7.1.4 Effective diameter of a column or column head

The effective diameter of a column or column head is the diameter of a circle whose area equals the cross-sectional area of the column or, if column heads are used, the area of the column head based on the effective dimensions as defined in 3.7.1.3. In no case should h_c be taken as greater than one-quarter of the shortest span framing into the column.

3.7.1.5 Drops

For the purposes of 3.7, a drop may only be considered to influence the distribution of moments within the slab where the smaller dimension of the drop is at least one-third of the smaller dimension of the surrounding panels. Smaller drops may, however, still be taken into account when assessing the resistance to punching shear.

3.7.1.6 Thickness of panels

The thickness of the slab will generally be controlled by consideration of deflection (see 3.7.8). In no case, however, should the thickness of the slab be less than 125 mm. 3.6.1 gives further limitations applicable to waffle or coffered slabs.

3.7.2 Analysis of flat slab structures

3.7.2.1 General

While, in principle, a flat slab should be analysed to obtain at each section the moments and shears resulting from the most unfavourable arrangement of the design loads, it will normally be satisfactory to obtain the moments and forces within a system of flat slab panels from analysis of the structure under the single load case of maximum design load on all spans or panels simultaneously, provided the conditions set out in 3.5.2.3 are satisfied.

Where it is not appropriate to analyse for the single load case of maximum design load on all spans, it will be sufficient to consider the arrangements of load given in 3.2.1.2.2.

3.7.2.2 Analysis

In the absence of a more rigorous treatment, flat slabs consisting of a series of rectangular panels may be divided into a series of frames and analysed in accordance with 3.7.2.3 to 3.7.2.10.

3.7.2.3 Division of flat slab structures into frames

The structures may be divided longitudinally and transversely into frames consisting of columns and strips of slab. The width of slab used to define the effective stiffness of the slab will depend upon the aspect ratio of the panels and type of loading. In the case of vertical loading, the stiffness of rectangular panels may be calculated taking into account the full width of the panel. For horizontal loading, it will be more appropriate to take half this value.

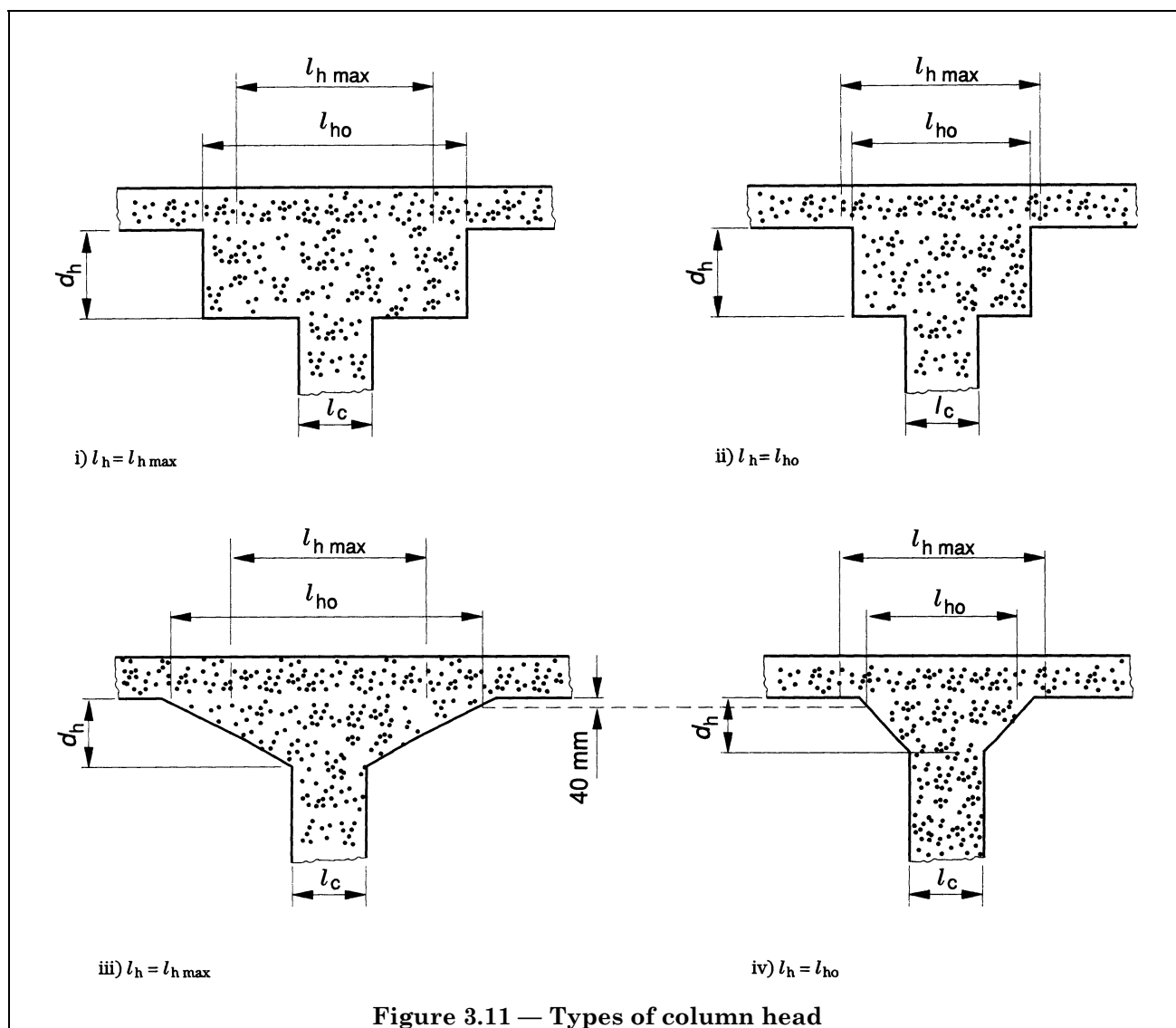

3.7.2.4 Frame analysis methods

Each frame may be analysed in its entirety by the Hardy Cross method or other suitable elastic methods. Alternatively, for vertical loads only, each strip of floor and roof may be analysed as a separate frame with the columns above and below fixed in position and direction at their extremities or the simplified sub-frame described in 3.2.1.2.3 may be used. In either case, the analysis should be carried out for the appropriate design ultimate loads on each span calculated for a strip of slab of width equal to the distance between centre lines of the panels on each side of the columns.

3.7.2.5 Frame stiffness

The second moment of area of any section of slab or column used in calculating the relative stiffness of members may be assumed to be that of the cross-section of the concrete alone.

3.7.2.6 Limitation of negative design moments

Negative moments greater than those at a distance $h_c/2$ from the centre-line of the column may be ignored providing the sum of the maximum positive design moment and the average of the negative design moments in any one span of the slab for the whole panel width is not less than:

$$\frac{nl_2}{8} \left(l_1 - \frac{2h_c}{3} \right)^2$$

When the above condition is not satisfied, the negative design moments should be increased.

3.7.2.7 Simplified method for determining moments

For flat-slab structures whose lateral stability is not dependent on slab-column connections, Table 3.12 may be used subject to the following provisions:

- a) design is based on the single load case of all spans loaded with the maximum design ultimate load, (i.e. the conditions of 3.5.2.3 are satisfied);
- b) there are at least three rows of panels of approximately equal span in the direction being considered;
- c) for definitions of l and F see 3.7.1.1;
- d) moments at supports taken from Table 3.12 may be reduced by $0.15Fh_c$; and
- e) the limitation of 3.7.2.6 need not be checked. Allowance has been made to the coefficients of Table 3.12 for 20 % redistribution in accordance with 3.5.2.3.

3.7.2.8 Division of panels (except in the region of edge and corner columns)

Flat slab panels should be assumed to be divided into column strips and middle strips (see Figure 3.12). In the assessment of the widths of the column and middle strips, drops should be ignored if their smaller dimension is less than one-third of the smaller dimension of the panel.

3.7.2.9 Column strips between unlike panels

Where there is a support common to two panels of such dimensions that the strips in one panel do not match those in the other, the division of the panels over the region of the common support should be taken as that calculated for the panel giving the wider column strip.

3.7.2.10 Division of moments between column and middle strips

The design moments obtained from analysis of the continuous frames or from Table 3.12 should be divided between the column and middle strips in the proportions given in Table 3.18.

3.7.3 Design of internal panels

3.7.3.1 Column and middle strips

The column and middle strips should be designed to withstand the design moments obtained from 3.7.2. In general, two-thirds of the amount of reinforcement required to resist the negative design moment in the column strip should be placed in a width equal to half that of the column strip and central with the column.

3.7.3.2 Curtailment of bars

Curtailment of bars should be in accordance with 3.12.9 but, where appropriate, the simplified rules given in 3.12.10 may be used.

3.7.4 Design of edge panels

3.7.4.1 Positive design moments in span and negative design moments over interior edges

These design moments should be apportioned and designed exactly as for an internal panel, using the same column and middle strips as for an internal panel.

3.7.4.2 Design moments transferable between slab and edge or corner columns

In general, moments will only be able to be transferred between a slab and an edge or corner column by a column strip considerably narrower than that appropriate for an internal panel. The breadth of this strip, b_e , for various typical cases is shown in Figure 3.13. The value of b_e should never be taken as greater than the column strip width appropriate for an interior panel.

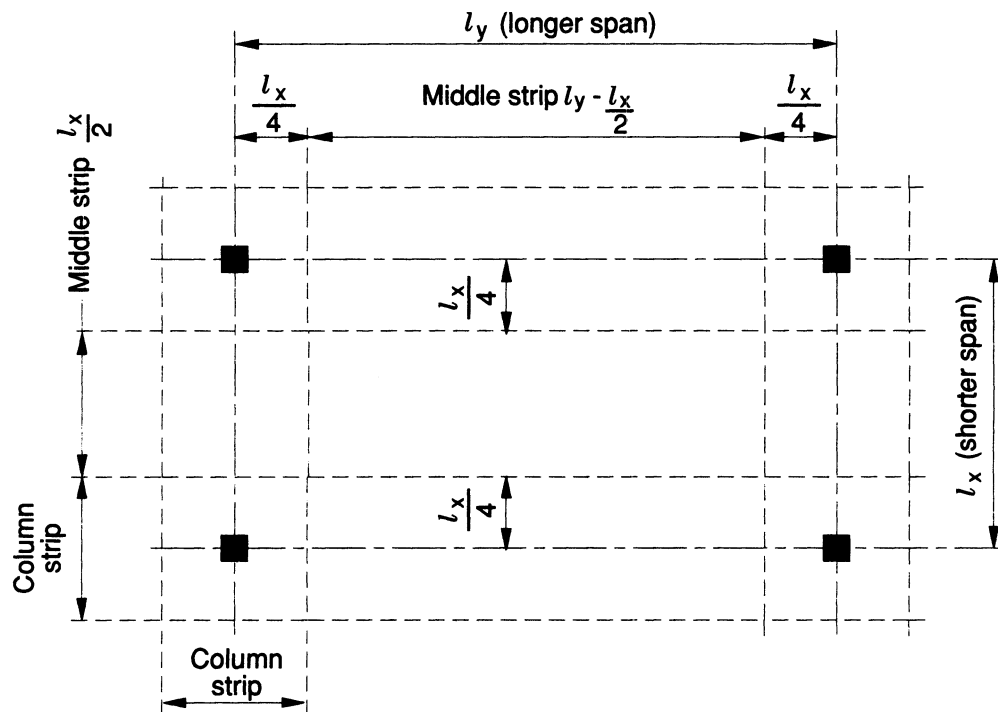

a) Slab without drops

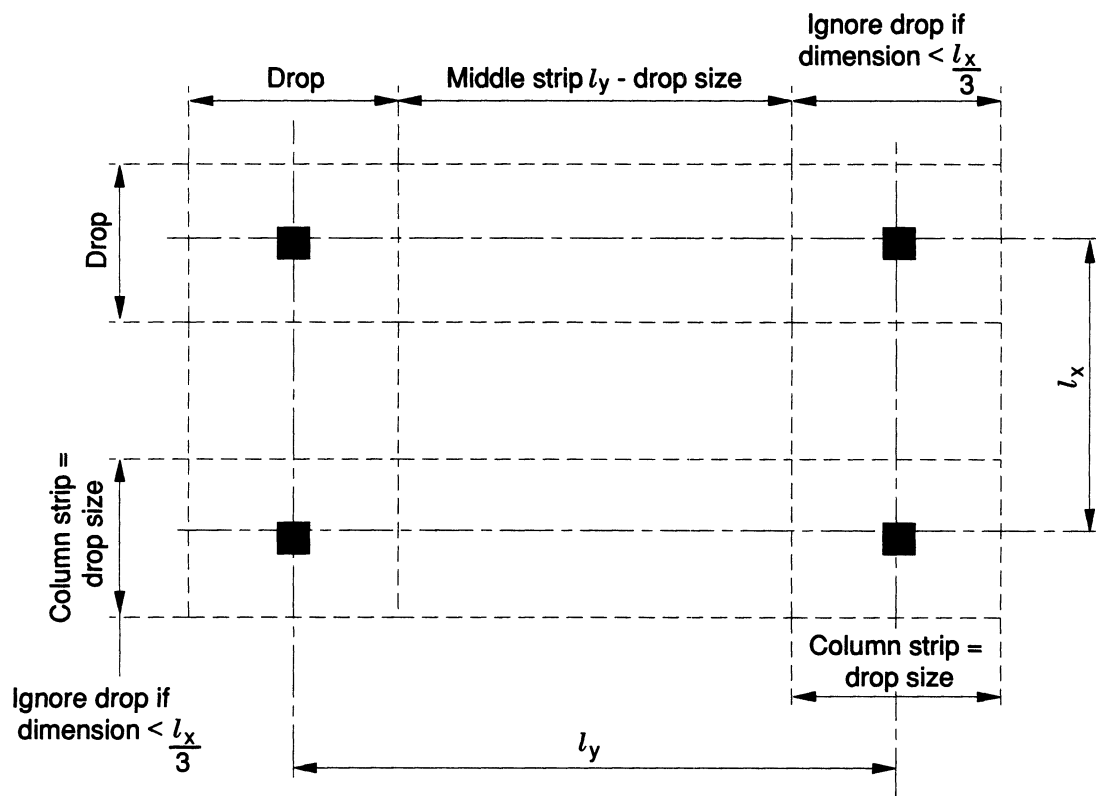

b) Slab with drops

Figure 3.12 — Division of panels in flat slabs

Table 3.18 — Distribution of design moments in panels of flat slabs

Design moment	Apportionment between column and middle strip expressed as percentages of the total negative or positive design moment	
	Column strip %	Middle strip %
Negative	75	25
Positive	55	45

NOTE For the case where the width of the column strip is taken as equal to that of the drop, and the middle strip is thereby increased in width, the design moments to be resisted by the middle strip should be increased in proportion to its increased width. The design moments to be resisted by the column strip may be decreased by an amount such that the total positive and the total negative design moments resisted by the column strip and middle strip together are unchanged.

The maximum design moment $M_{t \max}$ which can be transferred to a column by this strip is given by:

$$M_{t \max} = 0.15b_e d^2 f_{cu} \quad \text{equation 24}$$

where

- d is the effective depth for the top reinforcement in the column strip;
- $M_{t \max}$ should be not less than half the design moment obtained from an equivalent frame analysis or 70 % of the design moment if a grillage or finite element analysis has been used. If $M_{t \max}$ is calculated to be less than this, the structural arrangements should be changed.

3.7.4.3 Limitation of moment transfer

Where analysis of the structure indicates a design column moment larger than $M_{t \max}$, the design edge moment in the slab should be reduced to a value not greater than $M_{t \max}$ and the positive design moments in the span adjusted accordingly. The normal limitations on redistributions and neutral axis depth may be disregarded in this case. Moments in excess of $M_{t \max}$ may only be transferred to a column if an edge beam or strip of slab along the free edge is reinforced in accordance with 2.4 of BS 8110-2:1985 to carry the extra moment into the column by torsion. In the absence of an edge beam, an appropriate breadth of slab may be assessed by using the principles illustrated in Figure 3.13.

3.7.4.4 Negative moments at free edge

Reinforcement for negative design moments (other than in the column strip) is only needed where moments arise from loading on any extension of the slab beyond the column centre-lines. However, top reinforcement at least equal to the minimum reinforcement defined in 3.12.5 should be provided, extending at least 0.15 l or an anchorage length, whichever is the greater, into the span.

3.7.4.5 Panels with marginal beams or walls

Where the slab is supported by a marginal beam with a depth greater than 1.5 times the thickness of the slab, or by a wall then:

- the total design load to be carried by the beam or wall should comprise those loads directly on the wall or beams plus a uniformly distributed load equal to one-quarter of the total design load on the panel; and
- the design moments of the half-column strip adjacent to the beams or wall should be one-quarter of the design moments obtained from 3.7.2.

3.7.5 Openings in panels

3.7.5.1 General

Except for openings conforming to 3.7.5.2, 3.7.5.3 and 3.7.5.4, openings should be completely framed on all sides with beams to carry the loads to the columns. No opening should encroach upon a column head.

3.7.5.2 Holes in areas bounded by column strips

Holes in areas bounded by column strips may be formed providing:

- a) that their greatest dimension in a direction parallel to a centre-line of the panel does not exceed 0.4 l ; and
- b) that the total positive and negative design moments given in 3.7.2 are redistributed between the remaining structure to meet the changed conditions.

3.7.5.3 Holes in areas common to two column strips

Holes in areas common to two-column strips may be formed providing:

- a) that in aggregate their length or width does not exceed one-tenth of the width of the column strip;
- b) that the reduced sections are capable of resisting the appropriate moments given in 3.7.2; and
- c) that the perimeter for calculating the design shear stress is reduced if appropriate.

3.7.5.4 Holes in areas common to a column strip and middle strip

Holes in areas common to a column strip and a middle strip may be formed providing:

- a) that in aggregate their length or width does not exceed one-quarter of the width of the column strip; and
- b) that the reduced sections are capable of resisting the appropriate design moments given in 3.7.2.

3.7.6 Effective shear forces in flat slabs**3.7.6.1 General**

The critical consideration for shear in flat slab structures is that of punching shear around the columns. This is checked in accordance with the provisions of 3.7.7 except that the shear stresses are increased as stated in 3.7.6.2 and 3.7.6.3 to allow for the effects of moment transfer.

Figure 3.14 and Figure 3.15 are intended to clarify the application of these subclauses.

3.7.6.2 Shear stress at slab/internal column connections in flat slabs

After calculation of the design moment transmitted by the connection (in accordance with 3.7.2) the design effective shear force at the perimeter V_{eff} should be taken as:

$$V_{\text{eff}} = V_t \left(1 + \frac{1.5M_t}{V_t x} \right) \quad \text{equation 25}$$

where

- x is the length of the side of the perimeter considered parallel to the axis of bending;
- M_t is the design moment transmitted from the slab to the column at the connection.

In the absence of calculation, it will be satisfactory to take a value of $V_{\text{eff}} = 1.15V_t$ for internal columns in braced structures with approximately equal spans; where V_t is calculated on the assumption that the maximum design load is applied to all panels adjacent to the column considered.

NOTE 1 Equation 25 should be applied independently for the moments and shears about both axes of the column and the design checked for the worst case.

NOTE 2 M_t may be reduced by 30 % where the equivalent frame method has been used and analysis has been based on pattern loads.

3.7.6.3 Shear stress at other slab-column connections

At corner columns and at edge columns where bending about an axis parallel to the free edge is being considered, the design effective shear is calculated from $V_{\text{eff}} = 1.25V_t$. For edge columns where bending about an axis, perpendicular to the edge is being considered, the design effective shear should be calculated using equation 26:

$$V_{\text{eff}} = V_t \left(1.25 + \frac{1.5M_t}{V_t x} \right) \quad \text{equation 26}$$

Alternatively, V_{eff} may be taken as $1.4V_t$ for approximately equal spans.

NOTE M_t may be reduced by 30 % where the equivalent frame method has been used and analysis has been based on patterned loads.

3.7.6.4 Maximum design shear stress at the column face

The maximum design shear stress at the column face should not exceed $0.8\sqrt{f_{\text{cu}}}$ or 5 N/mm^2 , whichever is the lesser, when assessed using equation 25 or 26, as appropriate, on a perimeter equal to the perimeter of the column or column head (this includes an allowance for γ_m of 1.25).

3.7.7 Shear under concentrated loads

NOTE See 1.3.3 for definitions specific to perimeters.

3.7.7.1 Mode of punching failure

Punching failures occur on the inclined faces of truncated cones or pyramids, depending on the shape of the loaded areas. However, for practical purposes, it is satisfactory to consider rectangular failure perimeters. Empirical methods of designing against punching shear failure are given in 3.7.7.2 to 3.7.7.8.

3.7.7.2 Maximum design shear capacity

The maximum design shear stress v_{max} should not exceed $0.8\sqrt{f_{\text{cu}}}$ or 5 N/mm^2 if less. The value of v_{max} is given by the equation:

$$v_{\text{max}} = \frac{V}{u_0 d} \quad \text{equation 27}$$

The maximum shear capacity may also be limited by the provisions of 3.7.7.5.

3.7.7.3 Calculation of design shear stress

The nominal design shear stress v appropriate to a particular perimeter is calculated from the following equation:

$$v = \frac{V}{ud} \quad \text{equation 28}$$

3.7.7.4 Shear capacity without shear reinforcement

Provided the shear stress v is less than v_c obtained from Table 3.8 no shear reinforcement is required. The enhancement of v_c permitted in 3.4.5.8 may not be applied to the shear strength of perimeters at a distance of $1.5d$ or more from the face of the loaded area. Where it is desired to check perimeters closer to the loaded area than $1.5d$, v_c may be increased by a factor $1.5d/a_v$ where a_v is the distance from the edge of the loaded area to the perimeter considered.

3.7.7.5 Provision for shear reinforcement

The use of shear reinforcement other than links is not covered specifically by this code and should be justified separately.

If $v_c < v < 2v_c$, shear reinforcement in the form of links may be provided in accordance with equations 29a) and 29b) in slabs over 200 mm deep to increase the shear resistance.

For cases where $v \leq 1.6v_c$ shear reinforcement should be provided in accordance with the following equation:

$$\Sigma A_{\text{sv}} \sin \alpha \geq \frac{(v - v_c)ud}{0.95f_{\text{yv}}} \quad \text{equation 29a)}$$

where

- f_{yv} is the characteristic strength of shear reinforcement (in N/mm^2);
- ΣA_{sv} is the area of shear reinforcement (in mm^2);
- α is the angle between the shear reinforcement and the plane of the slab.

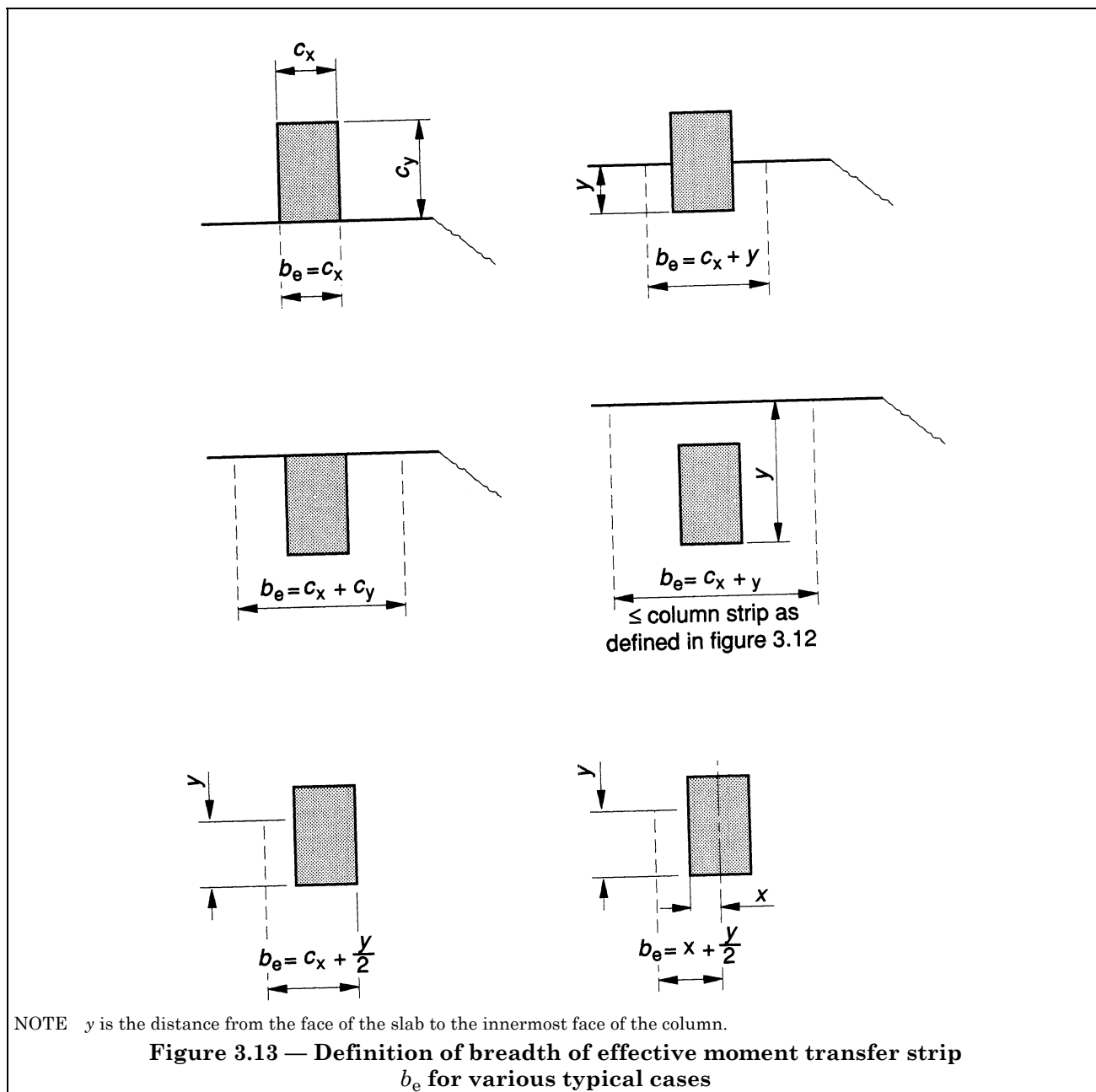

For cases where $1.6v_c < v \leq 2v_c$, shear reinforcement should be provided in accordance with:

$$\Sigma A_{sv} \sin \alpha \geq \frac{5(0.7v - v_c)ud}{0.95f_{yv}} \quad \text{equation 29b)}$$

Equations 29a) and 29b) should not be applied where the shear stress v exceeds $2v_c$.

Where $v > 2v_c$ and a reinforcing system is provided to increase the shear resistance, justification should be provided to demonstrate the validity of the design.

When using equations 29a) and 29b), $\Sigma A_{sv} \sin \alpha$ should not be taken as less than $0.4ud/0.95f_{yv}$.

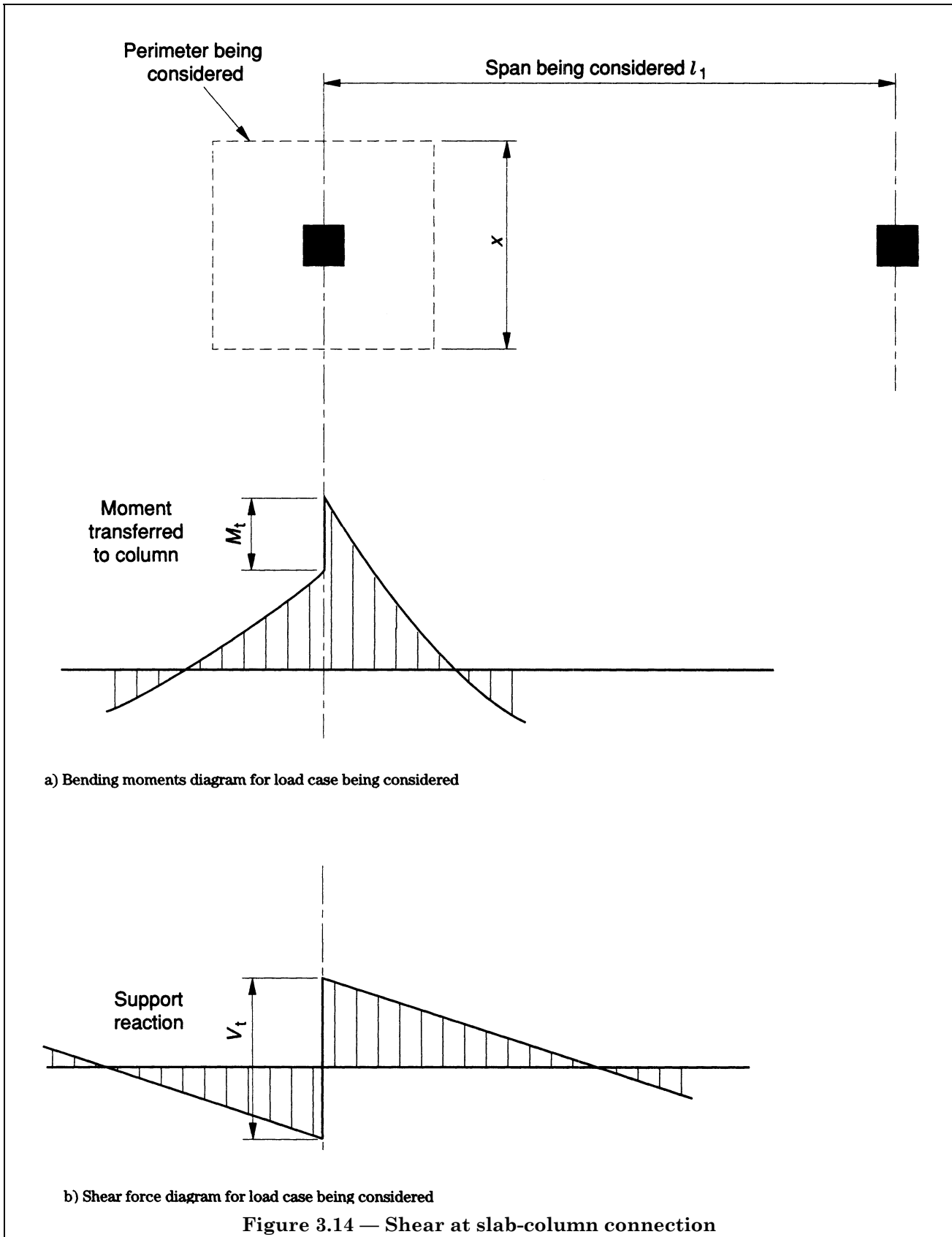

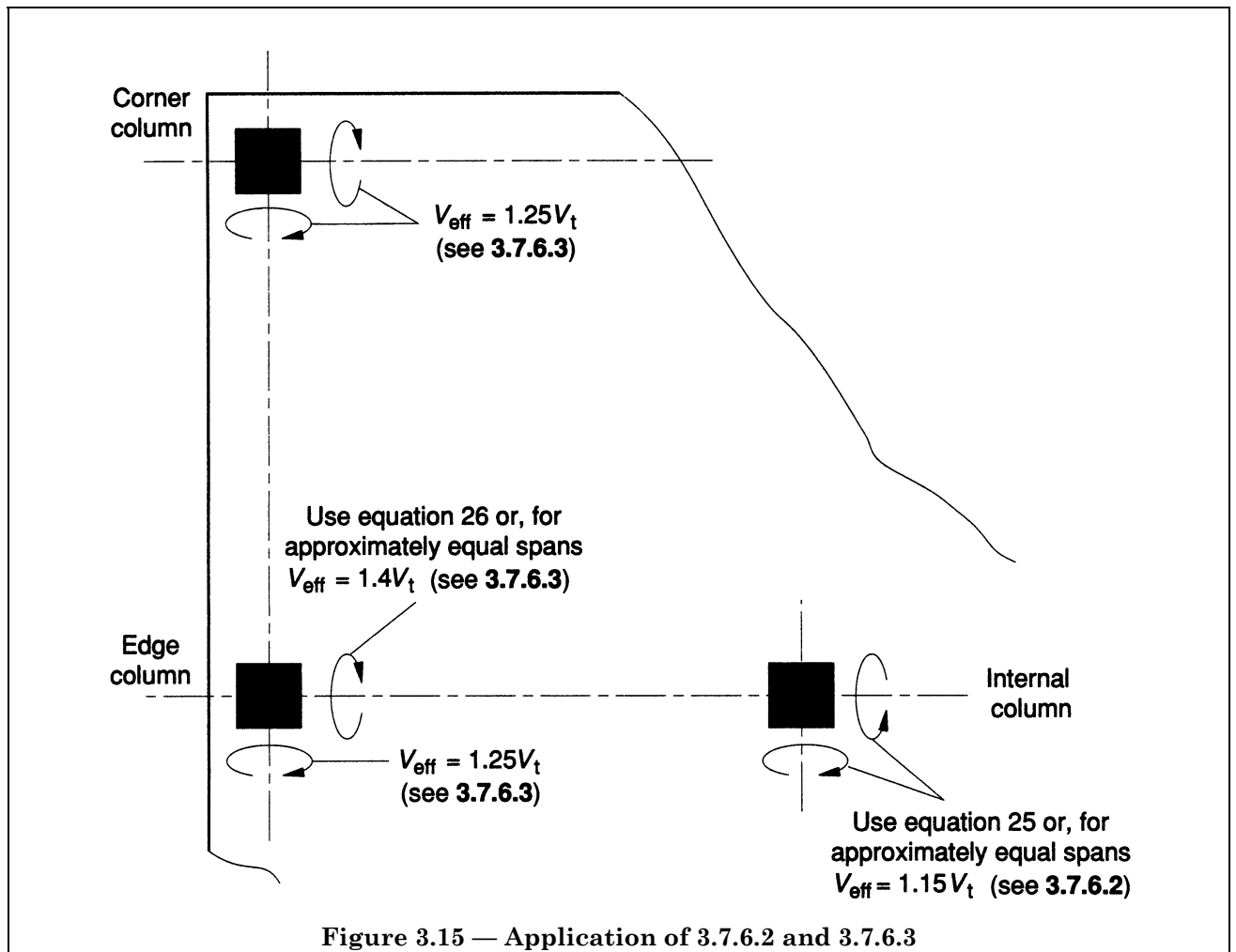

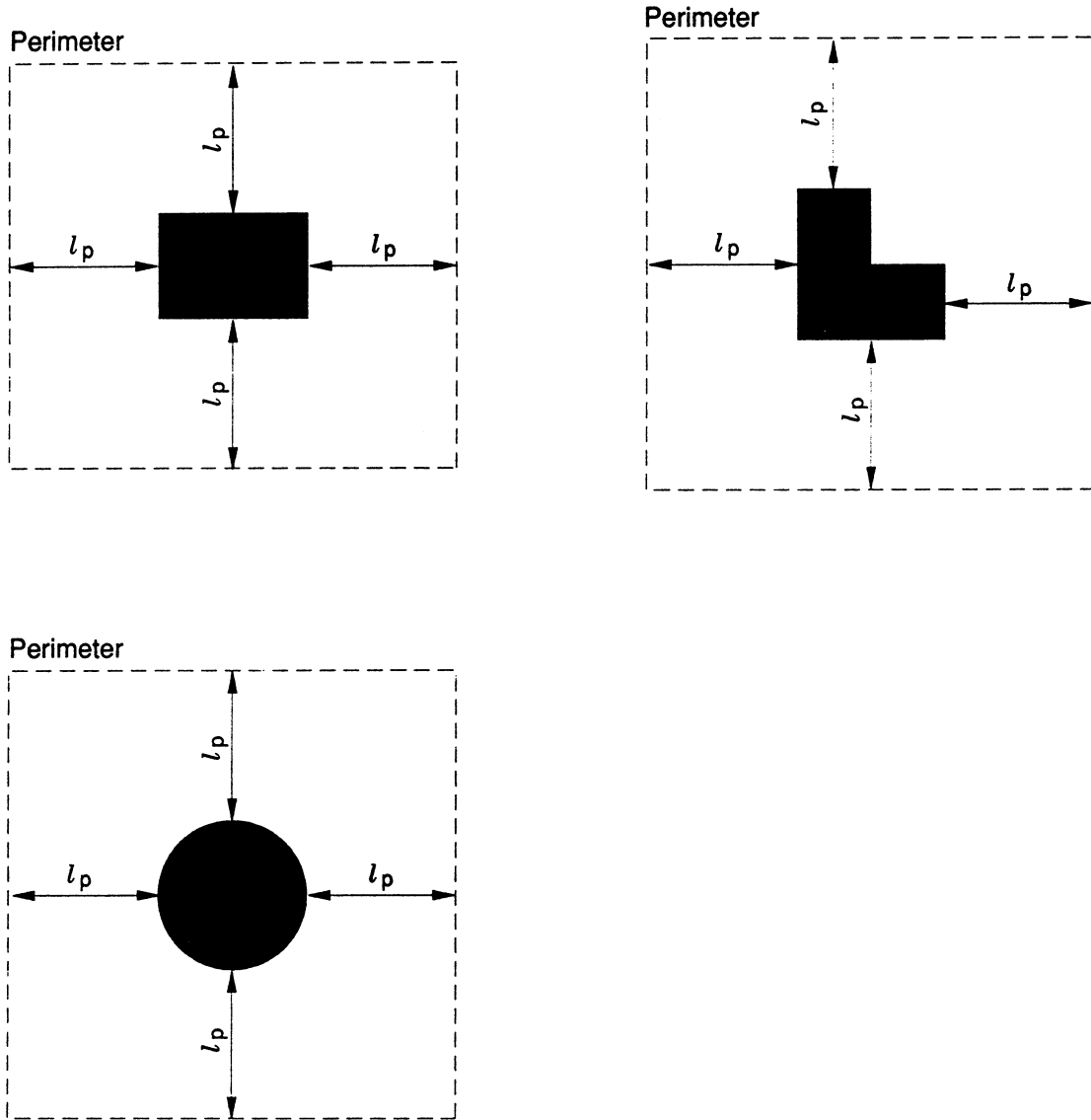

NOTE l_p is defined in 1.3.3.1.

Figure 3.16 — Definition of a shear perimeter for typical cases

3.7.7.6 Design procedure

The shear capacity is checked first on a perimeter $1.5d$ from the face of the loaded area. If the calculated shear stress does not exceed v_c then no further checks are needed.

If shear reinforcement is required, then it should be provided on at least two perimeters within the zone indicated in Figure 3.17. The first perimeter of reinforcement should be located at approximately $0.5d$ from the face of the loaded area and should contain not less than 40 % of the calculated area of reinforcement.

The spacing of perimeters of reinforcement should not exceed $0.75d$ and the spacing of the shear reinforcement around any perimeter should not exceed $1.5d$. The shear reinforcement should be anchored round at least one layer of tension reinforcement. The shear stress should then be checked on successive perimeters at $0.75d$ intervals until a perimeter is reached which does not require shear reinforcement.

In providing reinforcement for the shear calculated on the second and subsequent perimeters, that provided for the shear on previous perimeters and which lies within the zone shown in Figure 3.17 should be taken into account.

3.7.7.7 Modification of effective perimeter to allow for holes

When openings in slabs and footings (see Figure 3.18) are located at a distance less than six times the effective depth of the slab from the edge of a concentrated load, then that part of the perimeter which is enclosed by radial projections from the centroid of the loaded area to the openings is considered ineffective.

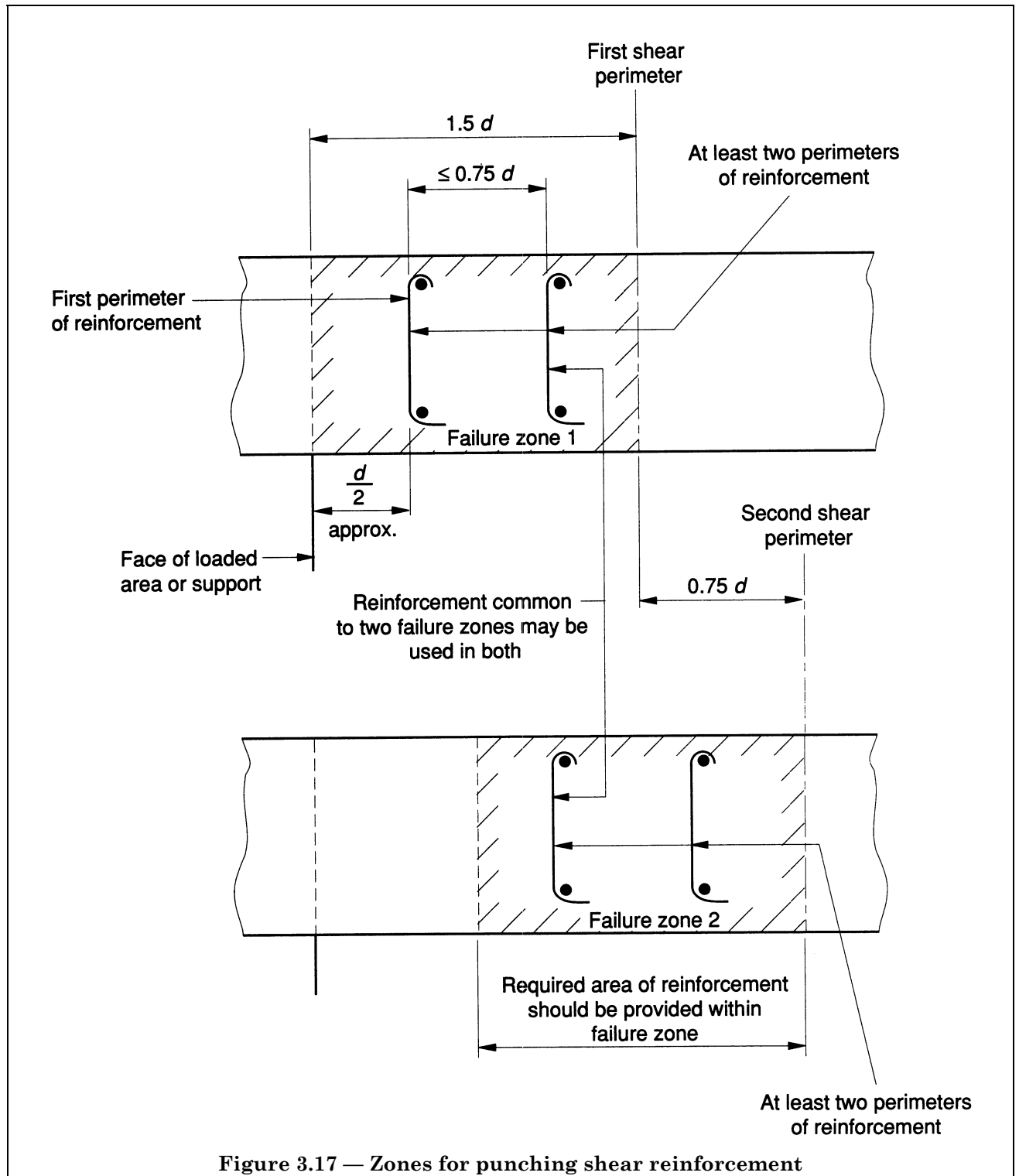

Where a single hole is adjacent to the column and its greatest width is less than one-quarter of the column side or one-half of the slab depth, whichever is the lesser, its presence may be ignored.

3.7.7.8 Effective perimeter close to a free edge

Where a concentrated load is located close to a free edge, the effective length of a perimeter should be taken as the lesser of the two illustrated in Figure 3.19. The same principle may be adopted for corner columns.

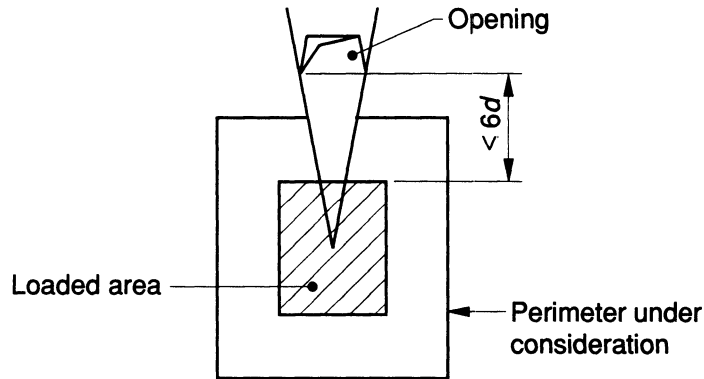

Figure 3.18 — Shear perimeter of slabs with openings

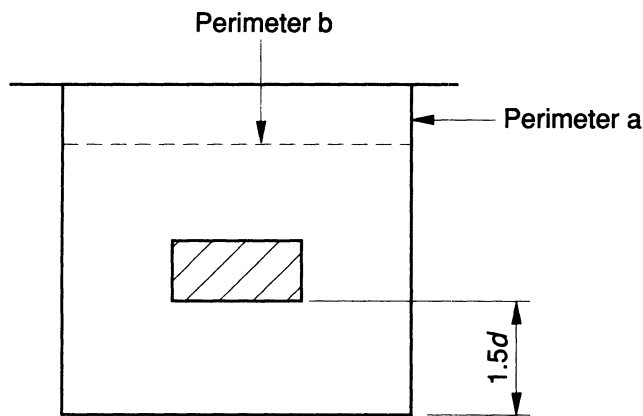

Figure 3.19 — Shear perimeters with loads close to free edge

3.7.8 Deflection of panels

For slabs with drops of gross width in both directions at least equal to one-third of the respective spans, the provisions of 3.4.6 can be applied directly. Otherwise the span/effective depth ratios obtained from 3.4.6 should be multiplied by 0.9. The check should be carried out for the more critical direction.

3.7.9 Crack control in panels

In general the reinforcement spacing rules given in 3.12.11 will be the best means of controlling flexural cracking in panels but, in certain cases, advantage may be gained by calculating crack widths (see section 3 of BS 8110-2:1985) and comparing them with the required values.

3.7.10 Design of columns in flat slab construction

Columns should be designed in accordance with the provisions of 3.8.

3.8 Columns

3.8.1 General

NOTE The provisions of this clause relate to columns whose greater overall cross-sectional dimension does not exceed four times its smaller dimension. While the provisions relate primarily to rectangular cross-sections, the principles involved may be applied to other shapes where appropriate.

3.8.1.1 Symbols

A_c	net cross-sectional area of concrete in a column.
A_{sc}	area of vertical reinforcement. ^a
a_u	deflection at ULS for each column calculated from equation 32.
a_{uav}	average deflection at ULS applied to all columns at a given level.
b	width of a column (dimension of cross-section perpendicular to h).
h	depth of cross-section measured in the plane under consideration.
l_e	effective height of a column in the plane of bending considered.
l_{ex}	effective height in respect of the major axis.
l_{ey}	effective height in respect of the minor axis.
l_o	clear height between end restraints.
l_c	height of column measured between centres of restraints.
M_1	smaller initial end moment due to design ultimate loads.
M_2	larger initial end moment due to design ultimate loads.
M_i	initial design ultimate moment in a column before allowance for additional design moments arising out of slenderness.
M_x	design ultimate moment about the x-axis.
M_x'	effective uniaxial design ultimate moment about the x-axis.
M_y	design ultimate moment about the y-axis
M_y'	effective uniaxial design ultimate moment about the y-axis.
M_{add}	additional design ultimate moment induced by deflection of column.
N	design ultimate axial load on a column.
N_{bal}	design axial load capacity of a balanced section; for symmetrically-reinforced rectangular sections, it may be taken as $0.25f_{cu}bd$.
N_{uz}	design ultimate capacity of a section when subjected to axial load only.
n	number of columns resisting sideways at a given level or storey.

^a“c” in the suffix here denotes main reinforcement in columns. It does not necessarily imply that the reinforcement will be in compression. It is used in a similar manner in 3.9 for walls.

3.8.1.2 Size of columns

The size of a column and the position of the reinforcement in it may be affected by the requirements for durability and fire resistance, and these should be considered before the design is commenced.

3.8.1.3 Short and slender columns

A column may be considered as short when both the ratios l_{ex}/h and l_{ey}/b are less than 15 (braced) and 10 (unbraced). It should otherwise be considered as slender.

3.8.1.4 Plain concrete columns

If a column has a large enough section to resist the ultimate loads without the addition of reinforcement, then it may be designed similarly to a plain concrete wall (see 1.3.4).

3.8.1.5 Braced and unbraced columns

A column may be considered braced in a given plane if lateral stability to the structure as a whole is provided by walls or bracing or buttressing designed to resist all lateral forces in that plane. It should otherwise be considered as unbraced.

3.8.1.6 Effective height of a column

3.8.1.6.1 General

The effective height, l_e , of a column in a given plane may be obtained from the following equation:

$$l_e = \beta l_0 \quad \text{equation 30}$$

Values of β are given in Table 3.19 and Table 3.20 for braced and unbraced columns respectively as a function of the end conditions of the column. Formulae that may be used to obtain a more rigorous assessment of the effective length, if desired, are given in 2.5 of BS 8110-2:1985. It should be noted that the effective height of a column in the two plan directions may be different.

In Table 3.19 and Table 3.20 the end conditions are defined in terms of a scale from 1 to 4. Increase in this scale corresponds to a decrease in end fixity. An appropriate value can be assessed from 3.8.1.6.2.

Table 3.19 — Values of β for braced columns

End condition at top	End condition at bottom		
	1	2	3
1	0.75	0.80	0.90
2	0.80	0.85	0.95
3	0.90	0.95	1.00

Table 3.20 — Values of β for unbraced columns

End condition at top	End condition at bottom		
	1	2	3
1	1.2	1.3	1.6
2	1.3	1.5	1.8
3	1.6	1.8	—
4	2.2	—	—

3.8.1.6.2 End conditions

The four end conditions are as follows.

- Condition 1.* The end of the column is connected monolithically to beams on either side which are at least as deep as the overall dimension of the column in the plane considered. Where the column is connected to a foundation structure, this should be of a form specifically designed to carry moment.
- Condition 2.* The end of the column is connected monolithically to beams or slabs on either side which are shallower than the overall dimension of the column in the plane considered.
- Condition 3.* The end of the column is connected to members which, while not specifically designed to provide restraint to rotation of the column will, nevertheless, provide some nominal restraint.
- Condition 4.* The end of the column is unrestrained against both lateral movement and rotation (e.g. the free end of a cantilever column in an unbraced structure).

3.8.1.7 Slenderness limits for columns

Generally, the clear distance, l_0 , between end restraints should not exceed 60 times the minimum thickness of a column.

3.8.1.8 Slenderness of unbraced columns

If, in any given plane, one end of an unbraced column is unrestrained (e.g. a cantilever column), its clear height, l_o , should not exceed:

$$l_o = \frac{100b^2}{h} \leq 60b \quad \text{equation 31}$$

NOTE In equation 31 h and b are respectively the larger and smaller dimensions of the column. The considerations of deflection (see 3.8.5) may introduce further limitations.

3.8.2 Moments and forces in columns

3.8.2.1 Columns in monolithic frames designed to resist lateral forces

In such cases the moments, shear forces and axial forces should be determined in accordance with 3.2.1.3 (see also 3.8.2.2).

3.8.2.2 Additional moments induced by deflection at ULS

In slender columns additional moments induced by deflection at ULS should also be considered. An allowance for them is made in the design requirements for slender columns (see 3.8.3). The bases or other members connected to the ends of such columns should also be designed to resist these additional moments at ULS if the average value of l_o/h for all columns at a particular level is greater than 20. Sub-clause 3.8.3.9 gives guidance in the design for these moments.

3.8.2.3 Columns in column-and-beam construction, or in monolithic braced structural frames

The axial force in a column may be calculated on the assumption that beams and slabs transmitting force into it are simply supported.

When a column is subject only to an axial load with no significant applied moment, as in the case of columns supporting a symmetrical arrangement of approximately equally loaded beams, only the design ultimate axial force need be considered in design together with a design moment representing a nominal allowance for eccentricity, equal to that recommended in 3.8.2.4.

3.8.2.4 Minimum eccentricity

At no section in a column should the design moment be taken as less than that produced by considering the design ultimate axial load as acting at a minimum eccentricity, e_{\min} , equal to 0.05 times the overall dimension of the column in the plane of bending considered but not more than 20 mm. Where biaxial bending is considered, it is only necessary to ensure that the eccentricity exceeds the minimum about one axis at a time.

3.8.3 Deflection induced moments in solid slender columns

3.8.3.1 Design

In general, a cross-section may be designed by the methods given for a short column (see 3.8.4) but in the design, account has to be taken of the additional moment induced in the column by its deflection.

The deflection of a rectangular or circular column under ultimate conditions may be taken to be:

$$a_u = \beta_a Kh \quad \text{equation 32}$$

In this expression β_a has the value obtained from Table 3.23 or, alternatively, from equation 34 from which the table is derived, where K is a reduction factor that corrects the deflection to allow for the influence of axial load. K is derived from the following equation:

$$K = \frac{N_{uz} - N}{N_{uz} - N_{bal}} \leq 1 \quad \text{equation 33}$$

where $N_{uz} = 0.45f_{cu}A_c + 0.95f_yA_{sc}$ (including allowances, as appropriate for γ_m).

The appropriate values of K may be found iteratively, taking an initial value of 1. Alternatively, it will always be conservative to assume that $K = 1$.

Table 3.21 is derived from the following equation:

$$\beta_a = \frac{1}{2000} \left(\frac{l_e}{b'} \right)^2 \quad \text{equation 34}$$

NOTE b' is generally the smaller dimension of the column (but see 3.8.3.6 for biaxial bending).

The deflection induces an additional moment given by:

$$M_{\text{add}} = N\alpha_u \quad \text{equation 35}$$

3.8.3.2 Design moments in braced columns bent about a single axis

Figure 3.20 shows the distribution of moments assumed over the height of a typical braced column. It may be assumed that the initial moment at the point of maximum additional moment (i.e. near mid-height of the column) is given by:

$$M_1 = 0.4M_1 + 0.6M_2 \geq 0.4M_2 \quad \text{equation 36}$$

where

M_1 is the smaller initial end moment due to design ultimate loads;

M_2 is the larger initial end moment due to design ultimate loads.

Assuming the column is bent in double curvature, M_1 should be taken as negative and M_2 positive.

It will be seen from Figure 3.20 that the maximum design moment for the column will be the greatest of a) to d):

- a) M_2
- b) $M_1 + M_{\text{add}}$;
- c) $M_1 + M_{\text{add}}/2$;
- d) $e_{\text{min}}N$.

3.8.3.3 Slender columns bent about a single axis (major or minor)

Provided the ratio of the length of the longer side to that of the shorter side is less than three and that, for columns bent about their major axis, l_e/h does not exceed 20, the additional moment may be calculated using equations 32 to 35 and added to the appropriate initial moments to obtain the total design moment. The initial moment M_1 is the maximum moment at the critical section calculated for the ultimate limit state.

3.8.3.4 Columns where l_e/h exceeds 20, bent about their major axis

In these cases the section should be designed as biaxially bent, with zero initial moment about the minor axis.

3.8.3.5 Columns bent about their major axis

Where the ratio of the longer to the shorter side equals three or more, the section should be designed as biaxially bent with zero initial moment about the minor axis.

3.8.3.6 Slender columns bent about both axes

Where the bending is significant about both axes, additional moments are calculated from equations 32 to 35 for both directions of bending. For each direction, b' in Table 3.23 should be taken as h , the dimension of the column in the plane of bending considered. These additional moments are then combined with the appropriate initial moments to obtain total design moments in the two directions. The critical section is then designed to withstand the design ultimate axial load, N , plus the total design moments in the two directions.

3.8.3.7 Unbraced structures

The distribution of moments assumed over the height of an unbraced column is indicated in Figure 3.21. The additional moment referred to in 3.8.3.1 may be assumed to occur at whichever end of the column has the stiffer joint; the additional moment at the other end may be reduced in proportion to the ratio of the joint stiffnesses at either end. The moment will act in a direction such that it increases the absolute magnitude at the critical section.

3.8.3.8 Deflection of unbraced columns

At any given level or storey all unbraced columns subject to lateral load are usually constrained to deflect sideways by the same amount. In such cases, an average ultimate deflection may be applied to all the columns. This deflection can be assessed from the following equation:

$$a_{uav} = \frac{\sum a_u}{n} \quad \text{equation 37}$$

After the calculation of a_{uav} any values of a_u more than twice a_{uav} should be ignored and the average recalculated; in this case n in equation 37 should be reduced appropriately.

3.8.3.9 Additional moments on members attached to a slender column

Where l_e/h exceeds 20 and either one or both ends of the column are connected monolithically to other members (e.g. a base, slabs or beams) then these members should be designed to withstand the additional moments applied by the ends of the column in addition to those calculated using normal analytical methods. Where there are columns both above and below a joint, the beams or slabs should be designed to withstand the sum of the additional design moments at the ends of the two columns.

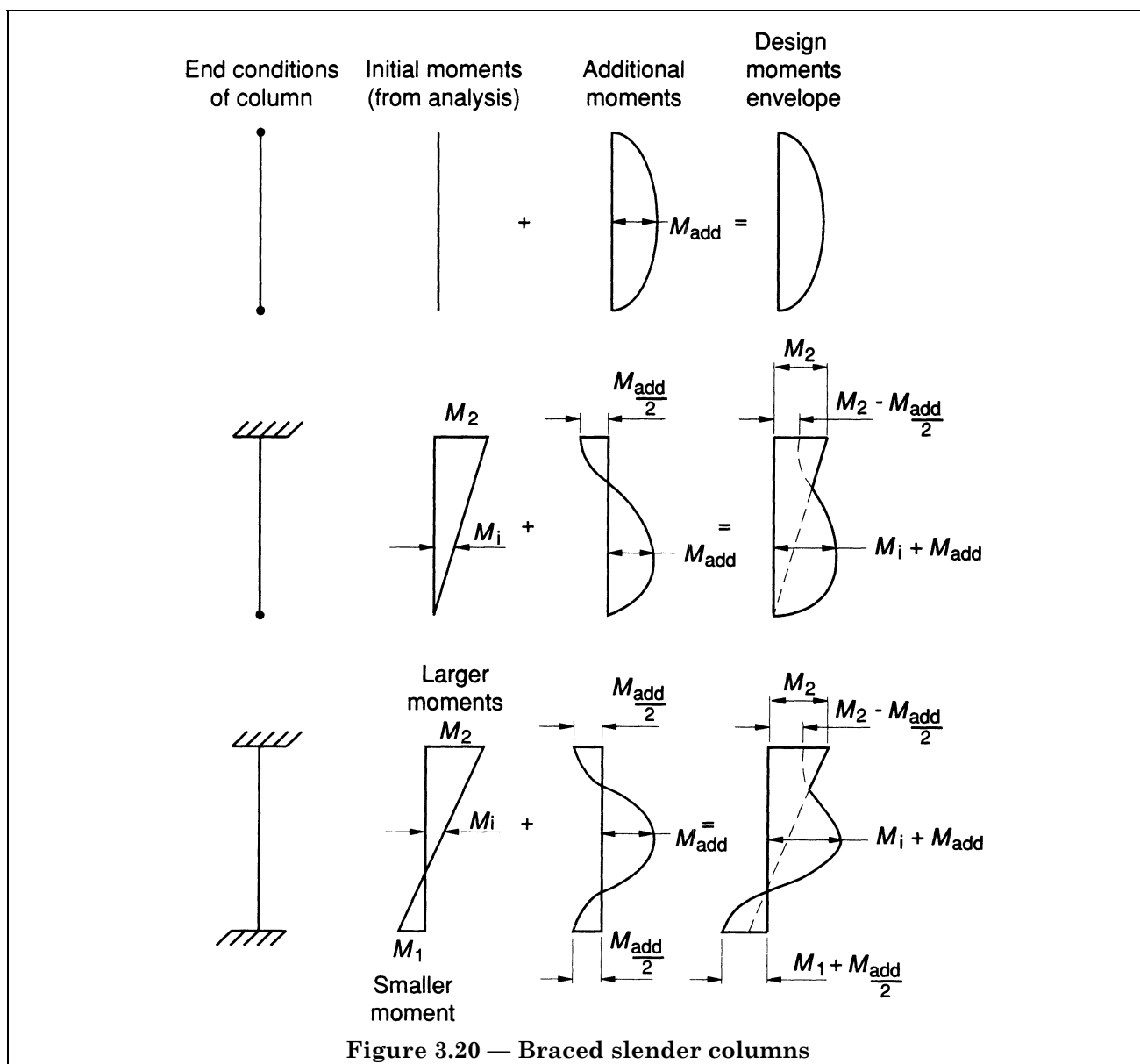
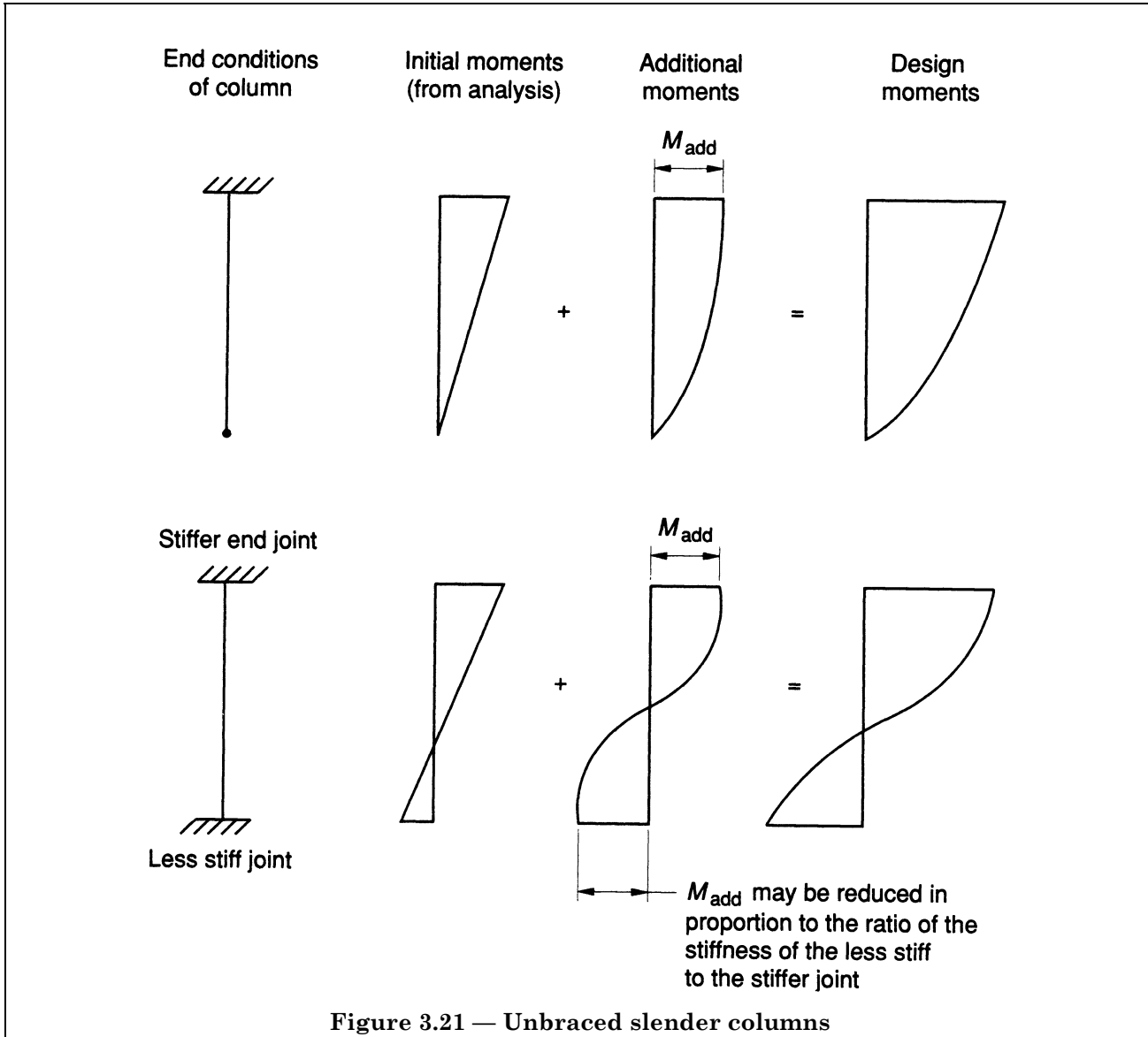

Table 3.21 — Values of β_a

l_e/b'	12	15	20	25	30	35	40	45	50	55	60
β_a	0.07	0.11	0.20	0.31	0.45	0.61	0.80	1.01	1.25	1.51	1.80



3.8.4 Design of column section for ULS

3.8.4.1 Analysis of sections

In the analysis of a column cross-section to determine its design ultimate resistance to moment and axial force, the same assumptions should be made as when analysing a beam (see 3.4.4.1).

3.8.4.2 Design charts for symmetrically-reinforced columns

Design charts for symmetrically-reinforced columns are given in BS 8110-3. They are based on Figure 2.1 and Figure 2.2 of this code and the assumptions of 3.4.4.1.

3.8.4.3 Nominal eccentricity of short columns resisting moments and axial forces

Short columns usually need only to be designed for the maximum design moment about the one critical axis.

Where, due to the nature of the structure, a column cannot be subjected to significant moments, it may be designed so that the design ultimate axial load does not exceed the value of N given by:

$$N = 0.4f_{cu}A_c + 0.8A_{sc}f_y \quad \text{equation 38}$$

NOTE This includes an allowance for γ_m .

3.8.4.4 Short braced columns supporting an approximately symmetrical arrangement of beams

The design ultimate axial load for a short column of this type may be calculated using the following equation:

$$N = 0.35f_{cu}A_c + 0.7A_{sc}f_y \quad \text{equation 39}$$

where

- a) the beams are designed for uniformly distributed imposed loads; and
- b) the beam spans do not differ by more than 15 % of the longer.

NOTE This includes an allowance for γ_m .

3.8.4.5 Biaxial bending

When it is necessary to consider biaxial bending and in the absence of more rigorous calculations in accordance with 3.4.4.1, symmetrically-reinforced rectangular sections may be designed to withstand an increased moment about one axis given by the following equations:

$$\text{a) for } M_x/h' \geq M_y/b', M_x' = M_x + \beta \frac{h'}{b'} M_y \quad \text{equation 40}$$

$$\text{b) for } M_x/h' < M_y/b', M_y' = M_y + \beta \frac{b'}{h'} M_x \quad \text{equation 41}$$

where

h' and b' are shown in Figure 3.22;

β is the coefficient obtained from Table 3.22.

3.8.4.6 Shear in columns

The design shear strength of columns may be checked in accordance with 3.4.5.12. For rectangular sections in compression no check is required provided that M/N does not exceed $0.6h$ and v does not exceed the maximum value given in 3.4.5.12.

3.8.5 Deflection of columns

No check is necessary under the following conditions.

- a) *Braced columns*. Within the recommended limits of slenderness no specific check is necessary.
- b) *Unbraced columns*. No check is normally necessary if in the direction and at the level considered the average value of l_e/h for all columns is not more than 30.
- c) *Single-storey construction*. Where no finishes susceptible to damage as a result of deflection are present, an unbraced column within the recommended limits of slenderness (see 3.8.1.8) may be considered to be acceptable.

If checks are needed, guidance on appropriate limits is given in section 3 of BS 8110-2:1985.

3.8.6 Crack control in columns

Cracks due to bending in a column designed for design ultimate axial load greater than $0.2f_{cu}A_c$ are unlikely to occur and therefore no check is required. A more lightly-loaded column subject to bending should be considered as a beam for the purpose of crack control.

Table 3.22 — Values of the coefficient β

$\frac{N}{bhf_{cu}}$	0	0.1	0.2	0.3	0.4	0.5	≥ 0.6
β	1.00	0.88	0.77	0.65	0.53	0.42	0.30

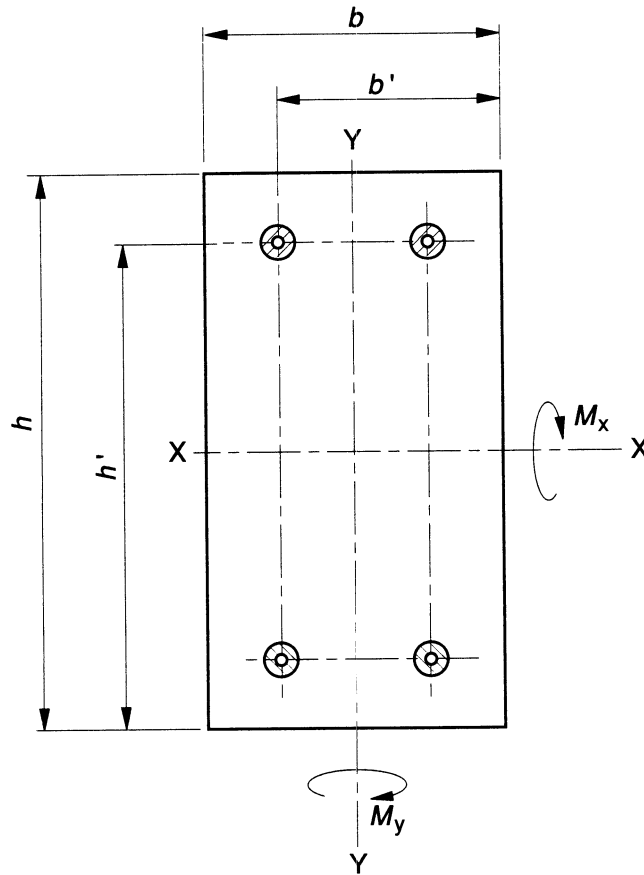

Figure 3.22 — Biaxially bent column

3.9 Walls

NOTE See 1.3.4 for definitions specific to walls.

3.9.1 Symbols

For the purposes of 3.9 the following symbols apply.

- A_c gross area of concrete at a cross-section.
- A_{sc} area of compression reinforcement, per unit length of wall.^a
- e_a additional eccentricity due to deflections.
- e_x resultant eccentricity of load at right angles to the plane of the wall.
- $e_{x,1}$ resultant eccentricity calculated at the top of the wall (see 3.9.3.7).
- $e_{x,2}$ resultant eccentricity calculated at the bottom of the wall (see 3.9.3.7)
- f_{cu} characteristic strength of concrete.

f_y	characteristic strength of compression reinforcement.
h	thickness of wall
l_e	effective height of wall.
l_o	clear height of wall between lateral supports.

^aThe “c” in the suffix denotes total vertical reinforcement and is justified as an extension of its use in 3.8.

3.9.2 Structural stability

3.9.2.1 Overall stability

The elements of construction providing lateral stability to the structure as a whole need not be designed to support the forces referred to in 3.9.2.3 in addition to the other design loads and forces.

3.9.2.2 Overall stability of multi-storey buildings

The overall stability of multi-storey buildings should not, in any direction, depend on unbraced walls alone.

3.9.2.3 Forces in lateral supports

NOTE See 1.3.4.4 for definition of “lateral support”.

The supports should be able to transmit forces assumed equal in magnitude to the sum of the following:

- the simple static reactions to the sum of the applied design ultimate horizontal forces at the point of lateral support; and
- 2.5 % of the total design ultimate vertical load that the wall or column is designed to carry at the point of lateral support.

3.9.2.4 Resistance to rotation of lateral supports

This resistance should only be considered to exist:

- where both the lateral support and the braced wall are concrete walls adequately detailed to provide bending restraint; or
- where precast or in situ concrete floors (irrespective of the direction of span) have a bearing on at least two-thirds of the thickness of the wall, or where there is a connection providing adequate bending restraint.

3.9.3 Design for reinforced walls

3.9.3.1 Axial forces

The design axial force in a reinforced wall may be calculated on the assumption that the beams and slabs transmitting force into it are simply supported.

3.9.3.2 Effective height

3.9.3.2.1 General

For a reinforced wall that is constructed monolithically with the adjacent construction, l_e should be assessed as though the wall were a column subject to bending at right angles to the plane of the wall, following the procedure given in 3.8 for columns.

3.9.3.2.2 Simply-supported construction

Where the construction transmitting load to a reinforced wall is, or is assumed to be, simply supported, the effective height should be assessed as for a plain wall.

3.9.3.3 Design transverse moments

Design transverse moments, when derived from beams or other construction designed to frame monolithically at right angles into the walls, should be calculated using elastic analysis. When construction is designed to be simply supported by the wall, the eccentricity may be assessed as for plain walls (see 3.9.4) and the resultant moment calculated. Except for short braced walls loaded almost symmetrically, the eccentricity in the direction at right angles to a wall should be taken as not less than $h/20$, or 20 mm if less, where h is the thickness of the wall.

3.9.3.4 In-plane moments

Design moments in the plane of a single wall due to horizontal forces may be calculated from statics alone.

When a horizontal force is resisted by several walls, the proportion allocated to each wall should be in proportion to its relative stiffness. When a shear connection is assumed between vertical edges of adjacent walls, an appropriate elastic analysis may be used provided the shear connection is designed to withstand the design forces.

3.9.3.5 Arrangement of reinforcement for reinforced walls in tension

In any part of a reinforced wall where tension develops under the design ultimate loads, the reinforcement should be arranged in two layers and each layer should be in accordance with the bar spacing rules given in 3.12.11.

3.9.3.6 Stocky reinforced walls

3.9.3.6.1 Stocky braced reinforced walls supporting approximately symmetrical arrangements of slabs

A wall of this type may be designed in such a way that:

$$n_w \leq 0.35f_{cu}A_c + 0.7A_{sc}f_y \quad \text{equation 42}$$

where

n_w is the total design axial load on the wall due to design ultimate loads; provided the slabs are designed for a uniformly distributed imposed load and the spans on either side of the wall do not differ by more than 15 %.

NOTE Allowance for γ_m is included in this equation.

3.9.3.6.2 Walls resisting transverse moments and uniformly distributed axial forces

When the only eccentricity of force derives from the transverse moments, the design axial load may be assumed to be distributed uniformly along the length of the wall. The cross-section of the wall should be designed to resist the appropriate design ultimate axial load and transverse moment. The assumptions made in the analysis of beam sections apply (see 3.4.4.1).

3.9.3.6.3 Walls resisting in-plane moments and axial forces

The cross-section of the wall should be designed to resist the appropriate design ultimate axial load and in-plane moments.

3.9.3.6.4 Walls with axial forces and significant transverse and in-plane moments

The effects should be assessed in three stages as follows.

- a) *In-plane*. Considering only axial forces and in-plane moments, the distribution of force along the wall is calculated by elastic analysis, assuming no tension in the concrete (see 3.9.3.4).
- b) *Transverse*. The transverse moments are calculated (see 3.9.3.3).
- c) *Combined*. At various points along the wall, effects a) and b) are combined and checked using the assumptions of 3.4.4.1.

3.9.3.7 Slender reinforced walls

3.9.3.7.1 *Design procedure*. The effects should be assessed in stages as follows.

- a) *In-plane*. Considering only axial forces and in-plane moments the distribution of force along the wall is calculated by elastic analysis, assuming no tension in the concrete (see 3.9.3.4).
- b) *Transverse*. The transverse moments are calculated (see 3.9.3.3 and 3.9.3.7.3).
- c) *Combined*. Effects a) and b) are combined and each unit length is considered as a slender column and designed as such in accordance with 3.8.4.

3.9.3.7.2 Limits of slenderness

The slenderness ratio l_e/h should not exceed that given in Table 3.23 for the reinforcement provided.

Table 3.23 — Maximum slenderness ratios for reinforced walls

Wall condition	Reinforcement	Maximum value of l_e/h
Braced	As given in 3.12.5 but $< 1\%$	40
Braced	As given in 3.12.5 but $\geq 1\%$	45
Unbraced	As given in 3.12.5	30

3.9.3.7.3 Transverse moments

In such walls significant moments additional to those mentioned in 3.9.3.3 may be induced by lateral deflection under load. Appropriate allowance for this is made by considering such walls as slender columns bent about the minor axis (see 3.9.3.8.1), except that where a wall is reinforced with only one central layer of reinforcement the additional moments should be doubled.

3.9.3.8 Deflection**3.9.3.8.1 General**

The deflection should be within acceptable limits if the preceding recommendations are followed.

3.9.3.8.2 Reinforced shear walls

The deflection of reinforced shear walls should be within acceptable limits if the total height does not exceed 12 times the length.

3.9.4 Design of plain walls**3.9.4.1 Axial forces**

The design ultimate axial force in a plain wall may be calculated on the assumption that the beams and slabs transmitting forces into it are simply supported.

3.9.4.2 Effective height of unbraced plain concrete walls

The effective height of unbraced plain concrete walls is given as follows:

- wall supporting at its top a roof or floor slab spanning at right angles: $l_e = 1.5l_o$;
- other walls $l_e = 2l_o$.

NOTE For gable walls to pitched roofs, l_o may be measured mid-ways between eaves and ridge.

3.9.4.3 Effective height of braced plain walls

The effective height of braced plain walls is given as follows:

- where any lateral support resists both rotation and lateral movement, l_e equals three-quarters of the clear distance²⁾ between lateral supports or twice the distance between a support and a free edge as appropriate;
- where any lateral support resists only lateral movement, l_e equals the distance between centres of support, or two and a half times the distance between a support and a free edge, as appropriate.

3.9.4.4 Limits of slenderness

The slenderness ratio l_e/h should not exceed 30 whether the wall is braced or unbraced.

3.9.4.5 Minimum transverse eccentricity of forces

Whatever the arrangements of vertical or horizontal forces, the resultant force in every plain wall should be assumed to have a transverse eccentricity of not less than $h/20$ or 20 mm. In the case of a slender wall further eccentricity can arise as a result of deflection under load. Procedures allowing for this are given in 3.9.4.16 and 3.9.4.17.

3.9.4.6 In-plane eccentricity due to forces on a single wall

In-plane eccentricity due to forces on a single wall may be calculated by statics alone.

²⁾ This distance is measured vertically if the lateral supports are horizontal (e.g. floors) or horizontally if the lateral supports are vertical (e.g. other walls).

3.9.4.7 In-plane eccentricity due to horizontal forces on two or more parallel walls

Where a horizontal force is resisted by several walls, it should be assumed to be shared between the walls in proportion to their relative stiffnesses provided the resultant eccentricity in any individual wall is not greater than one-third of the length of the wall. Where the eccentricity in any wall is found to be greater than this, the wall's stiffness should be considered as zero and an adjustment made to the forces assumed carried by the remainder.

3.9.4.8 Panels with shear connections

Where, in a wall, a shear connection is assumed between vertical edges of adjacent panels, an appropriate elastic analysis may be made provided the shear connection is designed to resist the design ultimate forces.

3.9.4.9 Eccentricity of loads from concrete floor or roof

The design loads may be assumed to act at one-third the depth of the bearing area from the loaded face. Where there is an in situ concrete floor on either side of the wall, the common bearing area may be assumed to be shared equally on each floor.

3.9.4.10 Other eccentricity-applied loads

It should be noted that loads may be applied to walls at eccentricities greater than half the thickness of the wall through special fittings (e.g. joist hangers).

3.9.4.11 In-plane and transverse eccentricity of resultant force on an unbraced wall

At any level full allowance should be made for the eccentricity of all vertical loads and the overturning moments produced by any lateral forces above that level.

3.9.4.12 Transverse eccentricity of resultant force on a braced wall

At any level the transverse eccentricity with respect to the wall's axial plane may be calculated on the assumption that immediately above a lateral support the resultant eccentricity of all the vertical loads above that level is zero.

3.9.4.13 Concentrated loads

When these are purely local (as at beam bearings or column bases) these may be assumed to be immediately dispersed provided the local design stress under the load does not exceed $0.6f_{cu}$ for concrete grade 25 or above, or $0.5f_{cu}$ for lower-strength concrete.

3.9.4.14 Calculation of design load per unit length

Design load per unit length should be assessed on the basis of a linear distribution of load along the length of the wall, with no allowance for any tensile strength.

3.9.4.15 Maximum unit axial loads for stocky braced plain walls

The maximum design ultimate axial load per unit length of wall due to ultimate loads, n_w , should satisfy the following:

$$n_w \leq 0.3(h - 2e_x)f_{cu} \quad \text{equation 43}$$

where

e_x is the resultant eccentricity of load at right angles to the plane of the wall (with minimum value $h/20$).

3.9.4.16 Maximum design ultimate axial load for slender braced plain walls

The maximum design ultimate axial load n_w should satisfy equation 43 and the following:

$$n_w \leq 0.3(h - 1.2e_x - 2e_a)f_{cu} \quad \text{equation 44}$$

where

e_x is as defined in **3.9.4.15**;

e_a is the additional eccentricity due to deflections which may be taken as $l_e^2/2 \cdot 500h$ where l_e is the effective height of the wall.

3.9.4.17 Maximum unit axial load for unbraced plain walls

The maximum unit axial load for unbraced plain walls should satisfy the following:

$$\text{a) } n_w \leq 0.3(h - 2e_{x,1})f_{cu} \quad \text{equation 45}$$

$$\text{b) } n_w \leq 0.3\{h - 2(e_{x,2} + e_a)\}f_{cu} \quad \text{equation 46}$$

where

e_a is defined in **3.9.4.16**.

3.9.4.18 Shear strength

The design shear resistance of plain walls need not be checked if one of the following conditions is satisfied:

- a) horizontal design shear force is less than one-quarter of design vertical load; or
- b) horizontal design shear force is less than that required to produce an average design shear stress of 0.45 N/mm^2 over the whole wall cross-section.

NOTE For concrete of grades lower than 25 and lightweight aggregate concrete, the figure of 0.30 N/mm^2 should be used instead of 0.45 N/mm^2 .

3.9.4.19 Cracking of concrete

Reinforcement may be needed in walls to control cracking due to flexure or thermal and hydration shrinkage. Guidance is given in **3.9.4.20** to **3.9.4.23**. Wherever provided, the quantity of reinforcement should be in each direction at least:

- a) for grade 460: 0.25 % of the concrete cross-sectional area;
- b) for grade 250: 0.30 % of the concrete cross-sectional area.

3.9.4.20 "Anticrack" reinforcement in external plain walls

If necessary in walls (of other than no-fines concrete) exceeding 2 m in length and exposed to the weather, reinforcement should be provided in both horizontal and vertical directions. It should consist of small diameter bars, relatively closely spaced, with adequate cover near the exposed surface.

3.9.4.21 "Anticrack" reinforcement in internal plain walls

It may be sufficient to provide reinforcement only at that part of the wall where junctions with floors and beams occur. When provided it should be dispersed half near each face.

3.9.4.22 Reinforcement around openings in plain walls

Nominal reinforcement should be considered.

3.9.4.23 Reinforcement of plain walls for flexure

If, at any level, a length of wall greater than one-tenth of the total length is subjected to tensile stress, resulting from in-plane eccentricity of the resultant force, vertical reinforcement to distribute potential cracking may be necessary. It needs to be provided only in the area of wall found to be in tension under design service loads. It should be arranged in two layers and conform to the spacing rules given in **3.12.11**.

3.9.4.24 Deflection of plain concrete walls**3.9.4.24.1 General**

The deflection of plain concrete walls should be within acceptable limits if the preceding recommendations of this clause are followed.

3.9.4.24.2 Shear walls

The deflection of plain concrete shear walls should be within acceptable limits if the total height does not exceed ten times the length of the wall.

3.10 Staircases**3.10.1 General**

NOTE For the purposes of this sub-clause, a staircase may be taken to include a section of landing spanning in the same direction and continuous with the stair flight.

3.10.1.1 Loading

Staircases should be designed to support the design ultimate loads according to the load combinations in 3.2.1.2.2.

3.10.1.2 Distribution of loading

In general, the design ultimate load should be assumed to be uniformly distributed over the plan area of a staircase. When, however, staircases surrounding open wells include two spans that intersect at right angles, the load on the areas common to both spans may be assumed to be divided equally between the two spans.

When staircases or landings that span in the direction of the flight are built at least 110 mm into walls along part or all of their length, a 150 mm strip adjacent to the wall may be deducted from the loaded area.

3.10.1.3 Effective span of monolithic staircases without stringer beams

When the staircase is built monolithically at its ends into structural members spanning at right angles to its span, the effective span should be as given in equation 47:

$$\text{effective span} = l_a + 0.5(l_{b,1} + l_{b,2}) \quad \text{equation 47}$$

where

- l_a is the clear horizontal distance between the supporting members;
- $l_{b,1}$ is the breadth of the supporting member at one end or 1.8 m, whichever is the lesser,
- $l_{b,2}$ is the breadth of the supporting member at the other or end 1.8 m, whichever is the lesser.

3.10.1.4 Effective span of simply-supported staircases without stringer beams

The effective span of simply-supported staircases without stringer beams should be taken as the horizontal distance between the centre-lines of the supports or the clear distance between the faces of supports plus the effective depth, whichever is the lesser.

3.10.1.5 Depth of section

The depth of the section should be taken as the minimum thickness perpendicular to the soffit of the staircase.

3.10.2 Design of staircases**3.10.2.1 Strength, deflection and crack control**

The recommendations for beams and slabs given in 3.4 and 3.5 apply except for the span/depth ratio of a staircase without stringer beams where 3.10.2.2 applies.

3.10.2.2 Permissible span/effective depth ratio for staircases without stringer beams

Provided the stair flight occupies at least 60 % of the span, the ratio calculated in accordance with 3.4.6.3 may be increased by 15 %.

3.11 Bases**3.11.1 Symbols**

For the purposes of 3.11 the following symbols apply.

- A_B total cross-sectional area of reinforcement parallel to the shorter side of a slab.
- a_v distance from the face of a column to the critical shear section.
- c column width.
- c_x horizontal dimension of a column, parallel to l_x .
- c_y horizontal dimension of a column, parallel to l_y .
- d effective depth of a pad footing or pile cap.
- h thickness of pad footing or pile cap.

l_c	half the spacing between column centres (if more than one) or the distance to the edge of the pad (whichever is the greater).
l_x	length of the longer side of a base.
l_y	length of the shorter side of a base.
v	design shear stress at a section.
v_c	design concrete shear stress (see Table 3.8).
φ	diameter of a circular pile or of a circle inscribed in the plan form of a pile of other shape.

3.11.2 Assumptions in the design of pad footings and pile caps

3.11.2.1 General

Except where the reactions to the applied loads and moments are derived by more accurate methods, e.g. an elastic analysis of a pile group or the application of established principles of soil mechanics, the following assumptions should be made.

- When a base or a pile cap is axially loaded, the reactions to design ultimate loads may be assumed to be uniformly distributed (i.e. load per unit area or per pile).
- When a base or a pile cap is eccentrically loaded, the reactions may be assumed to vary linearly across the base or across the pile system.

3.11.2.2 Critical section in design of an isolated pad footing

The critical section in design of an isolated pad footing may be taken as that at the face of the column or wall supported.

3.11.2.3 Pockets for precast members

Account should be taken of pockets for precast members in calculating section resistances, unless grouted up with a cement mortar not weaker than the concrete in the base.

3.11.3 Design of pad footings

3.11.3.1 Design moment on a vertical section taken completely across a pad footing

The design moment on a vertical section taken completely across a pad footing should be taken as that due to all external design ultimate loads and reactions on one side of that section. No redistribution of moments should be made.

3.11.3.2 Distribution of reinforcement

For the purposes of this sub-clause the reinforcement considered is that at right angles to the section. Where l_c exceeds $(3c/4 + 9d/4)$, two-thirds of the required reinforcement should be concentrated within a zone from the centre-line of the column to a distance $1.5d$ from the face of the column; otherwise the reinforcement should be uniformly distributed over l_c .

3.11.3.3 Design shear

The design shear is the algebraic sum of all design ultimate vertical loads acting on one side of or outside the periphery of the critical section (see 3.5.5 and 3.5.6).

3.11.3.4 Design shear strength near concentrated loads

Design shear strength near concentrated loads is governed by the more severe of the following two conditions.

- Shear along a vertical section extending across the full width of a base. See 3.5.5.2 and 3.5.5.3 (which deal with the design shear resistance of slabs).
- Punching shear around the loaded area. Use 3.7.6 except that no shear reinforcement is needed when $v < v_c$.

3.11.4 Design of pile caps

3.11.4.1 General

Pile caps are designed either by bending theory or by truss analogy; if the latter is used the truss should be of triangulated form, with a node at the centre of loaded area. The lower nodes of the truss lie at the intersections of the centre-lines of the piles with the tensile reinforcement.

3.11.4.2 *Truss method*

Where the truss method is used with widely spaced piles (spacing exceeding three times the pile diameter), only the reinforcement within 1.5 times the pile diameter from the centre of a pile should be considered to constitute a tension member of the truss.

3.11.4.3 *Shear forces*

The design shear strength of a pile cap is normally governed by the shear along a vertical section extending across the full width of the cap. Critical sections for the shear should be assumed to be located 20 % of the diameter of the pile inside the face of the pile, as indicated in Figure 3.23. The whole of the force from the piles with centres lying outside this line should be considered to be applied outside this line.

3.11.4.4 *Design shear resistance*

The design shear resistance of pile caps may be determined in accordance with 3.5.5 and 3.5.6, subject to the following limitations.

- a) In applying these provisions, α_v is the distance from the face of the column to the critical section as defined in 3.11.4.3.
- b) Where the spacing of the piles is less than or equal to 3ϕ , the enhancement may be applied over the whole of the critical section. Where the spacing is greater, the enhancement may only be applied to strips of width equal to 3ϕ , centred on each pile. Minimum stirrups are not required in pile caps where $v < v_c$ (enhanced if appropriate).
- c) The tension reinforcement should be provided with a full anchorage in accordance with 3.12.8.

3.11.4.5 *Punching shear*

A check should be made to ensure that the design shear stress calculated at the perimeter of the column does not exceed $0.8\sqrt{f_{cu}}$ N/mm² or 5 N/mm², whichever is the lesser. The maximum shear capacity may also be limited by the provisions of 3.7.7.5. In addition, if the spacing of the piles is greater than 3ϕ , punching shear should be checked in accordance with 3.7.7 on a perimeter as indicated in Figure 3.23.

3.12 Considerations affecting design details

NOTE Section 6 gives guidance on workmanship.

3.12.1 Permissible deviations

3.12.1.1 *General*

The effect of permissible deviations on design and detailing is given in 3.12.1.2 to 3.12.1.5 (see also 6.2.8 for dimensional deviations).

3.12.1.2 *Permissible deviations on member sizes*

In the selection of member sizes allowance should be made for inaccuracy of construction. BS 5606 gives guidance on accuracy and permissible deviations. The degree of permissible deviation specified should be consistent with the structure's fitness for its purpose.

The partial safety factors will, on a design based on nominal dimensions, provide for all normal permissible deviations. When large permissible deviations are allowed for small highly-stressed members, it may be necessary to base the design on net dimensions after allowance for the maximum specified permissible deviation; this would occur rarely.

3.12.1.3 *Position of reinforcement*

Normally the design may assume that the reinforcement is in its nominal position. However, when reinforcement is located in relation to more than one face of a member, e.g. a link in a beam in which the nominal cover for all sides is given, the actual concrete cover on one side may be greater and can be derived from consideration of certain other permissible deviations. These are:

- a) dimensions and spacing of cover blocks, spacers and/or chairs (including the compressibility of these items and the surfaces they bear on);
- b) stiffness, straightness, and accuracy of cutting, bending and fixing of bars or reinforcement cage;
- c) accuracy of formwork both in dimension and plane (this includes permanent forms, such as blinding or brickwork);
- d) the size of the structural part and the relative size of bars or reinforcement cage.

3.12.1.4 Permissible deviations on reinforcement fitting between two concrete faces

The overall dimension on the bending schedule should be determined for this reinforcement as the nominal dimension of the concrete less the nominal cover on each face and less the deduction for permissible deviation on member size and on bending given in Table 3.24.

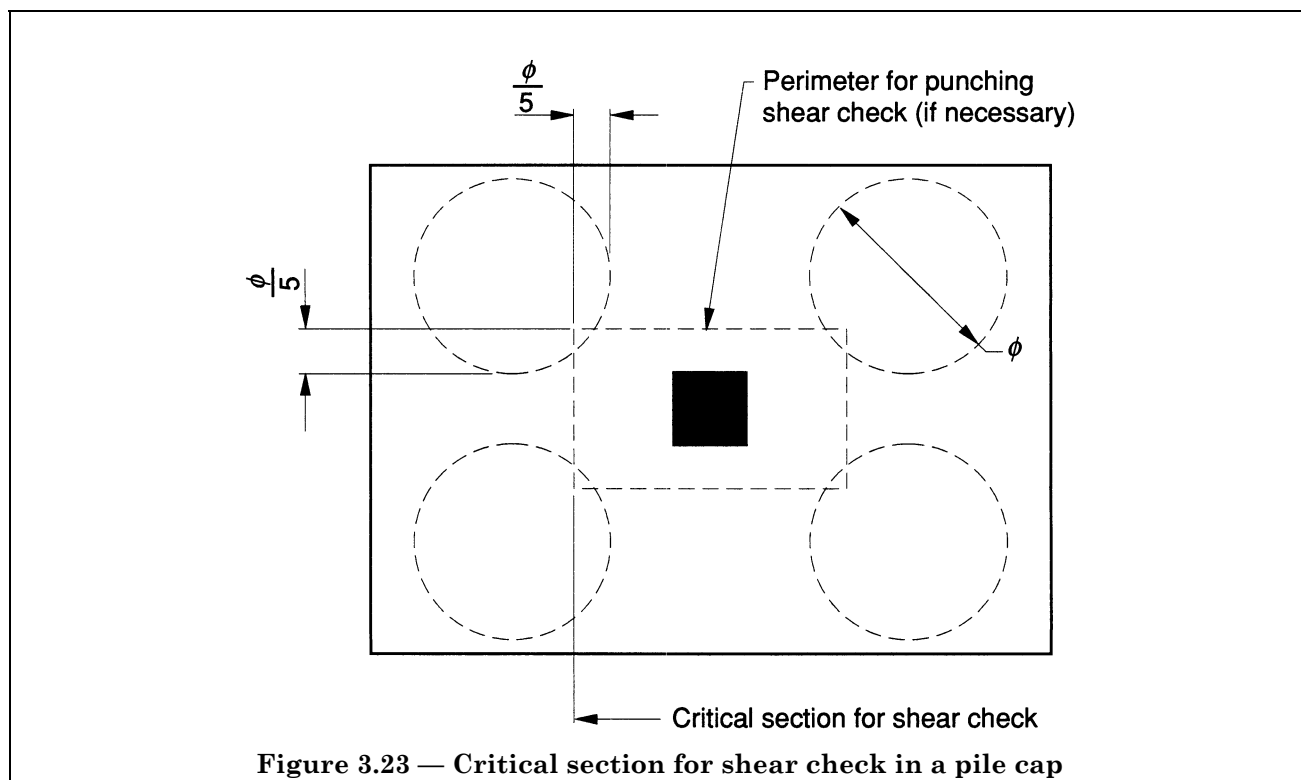

Table 3.24 — Bar schedule dimensions: deduction for permissible deviations

Distance between concrete faces m	Type of bar	Total deduction mm
0 up to and including 1	Links and other bent bars	10
Above 1 up to and including 2	Links and other bent bars	15
Over 2	Links and other bent bars	20
Any length	Straight bars	40

These deductions will apply to most reinforced concrete construction. However, where the permissible deviation on member size is greater than 5 mm, 5 mm, 10 mm and 10 mm for the four categories respectively, larger deductions should be made or the cover increased.

3.12.1.5 Accumulation of errors

In practice, the positioning of bars within their allotted individual permissible deviations may result in the accumulation of permissible deviations all in one direction. This may lead to reductions in resistance moments exceeding the percentage allowed for in the normal value of the partial safety factors. In the design of a particularly critical member, therefore, appropriate adjustment to the effective depth assumed may be necessary.

3.12.2 Joints

3.12.2.1 Construction joints

Careful consideration should be given to the location of construction joints and their position agreed before concreting. They should generally be at right angles to the direction of the member. If special preparation of the joint faces is required, it should be specified.

3.12.2.2 Movement joints

The location of movement joints should be clearly indicated on the drawings both for the individual members and for the structures as a whole. In general, movement joints in the structure should pass through the whole structure in one plane. Information on various types of movement joints is given in section 8 of BS 8110-2:1985.

3.12.3 Design of ties

3.12.3.1 General

The necessary interaction between elements is obtained by tying the structure together using the following types of tie (see 2.2.2.2):

- a) peripheral ties;
- b) internal ties;
- c) horizontal ties to columns and walls;
- d) vertical ties.

Where a building is divided by expansion joints into structurally independent sections, each section should have an appropriate tying system.

3.12.3.2 Proportioning of ties

In the design of the ties, the reinforcement may be assumed to be acting at its characteristic strength and forces other than those given in 3.12.3.4 to 3.12.3.7 may be neglected. Reinforcement provided for other purposes may be regarded as forming part of, or the whole of, these ties.

3.12.3.3 Continuity and anchorage of ties

Bars should be lapped, welded or mechanically joined in accordance with 3.12.8.9.

A tie may be considered anchored to another tie at right angles if the bars of the former tie extend:

- a) 12ϕ or an equivalent anchorage beyond all the bars of the other tie; or
- b) an effective anchorage length (based on the force in the bars) beyond the centre-line of the bars of the other tie.

At re-entrant corners or at substantial changes in construction, care should be taken to ensure that the ties are adequately anchored or otherwise made effective.

3.12.3.4 Internal ties

3.12.3.4.1 Distribution and location

These ties should be at each floor and roof level in two directions approximately at right angles. They should be effectively continuous throughout their length and should be anchored to the peripheral ties at each end (unless continuing as horizontal ties to columns or walls). They may, in whole or in part, be spread evenly in the slabs or may be grouped at or in beams, walls or other appropriate positions, but at spacings generally not greater than $1.5l_r$, where l_r is the greater of the distances (in metres) between the centres of the columns, frames or walls supporting any two adjacent floor spans in the direction of the tie under consideration. In walls they should be within 0.5 m of the top or bottom of floor slabs.

3.12.3.4.2 Strength

In each direction, the ties should be capable of resisting a tensile force (in kN/m width) equal to the greater of:

- a) $\frac{(g_k + q_k)l_r}{7.5} F_t$
- or
- b) $1.0F_t$

where

- $(g_k + q_k)$ is the sum of the average characteristic dead and imposed floor loads (in kN/m²);
 F_t is the lesser of $(20 + 4n_o)$ or 60, where n_o is the number of storeys in the structure;
 l_r is as defined in 3.12.3.4.1.

Whenever walls occur in plan in one direction only (e.g. “cross wall” or “spine wall” construction) the value of l_r used when assessing the tie force in the direction parallel to the wall should be taken as either the actual length of the wall or the length which may be considered lost in the event of an accident, whichever is the lesser. The length which may be considered lost should be taken as the length between adjacent lateral supports or between a lateral support and a free edge. Further information is given in 2.6.3.2 of BS 8110-2:1985.

3.12.3.5 *Peripheral ties*

At each floor and roof level an effectively continuous peripheral tie should be provided, capable of resisting a tensile force (in kilonewtons) of $1.0F_t$, located within 1.2 m of the edge of the building or within the perimeter wall.

3.12.3.6 *Horizontal ties to columns and walls*

3.12.3.6.1 *General*

Each external column and, if the peripheral tie is not located within the wall, every metre length of external wall carrying vertical load should be anchored or tied horizontally into the structure at each floor and roof level with a tie capable of developing a force (in kilonewtons) equal to the greater of:

- a) $2.0F_t$ [or $(l_s/2.5)F_t$ if less, where l_s is the floor to ceiling height (in metres)]; or
- b) 3 % of the total design ultimate vertical load carried by the column or wall at that level.

Where the peripheral tie is located within the wall, only such horizontal tying as is required to anchor the internal ties to the peripheral ties needs to be provided (see 3.12.3.4.1 and 3.12.3.4.2).

3.12.3.6.2 *Corner columns ties*

Corner columns should be tied into the structure at each floor and roof level in each of two directions, approximately at right angles, with ties each capable of developing a force equal to the greater of a) or b) of 3.12.3.6.1.

3.12.3.7 *Vertical ties*

Each column and each wall carrying vertical load should be tied continuously from the lowest to the highest level. The tie should be capable of resisting a tensile force equal to the maximum design ultimate dead and imposed load received by the column or wall from any one storey. The design load is that assessed in accordance with 2.4.3.2. Where a column or a wall at its lowest level is supported by an element other than a foundation, a general check for structural integrity should be made in accordance with 3.1.4.

3.12.4 **Reinforcement**

3.12.4.1 *Groups of bars*

Bars may be in groups of two, three or four, in contact. Where this is done, the bundle or pair should be treated as a single bar of equivalent area for all purposes in section 3. In no situation, even at laps, should more than four bars be arranged in contact.

3.12.4.2 *Bar schedule dimensions*

Bars should be scheduled in accordance with BS 4466. Where reinforcement is to fit between two concrete faces, the permissible deviations recommended in 3.12.1.4 should be adopted.

3.12.5 **Minimum areas of reinforcement in members**

3.12.5.1 *General*

Enough reinforcement should be provided to control, within reason, cracks however caused. The minimum quantities recommended in 3.12.5.3 and 3.12.5.4 should suffice.

3.12.5.2 *Symbols*

For the purposes of 3.12.5 the following symbols apply.

A_c total area of concrete.

A_{cc}	area of concrete in compression.
A_s	minimum recommended area of reinforcement.
A_{sc}	area of steel in compression.
A_{st}	area of transverse steel in a flange.
b	breadth of section.
b_w	breadth or effective breadth of the rib; for a box, T or l section, b_w is taken as the average breadth of the concrete below the flange.
f_y	characteristic strength of reinforcement.
h	overall depth of the cross-section of a reinforced member.
h_f	depth of flange.
l	span of the beam.

3.12.5.3 Minimum percentages of reinforcement

The minimum percentages of reinforcement appropriate for various conditions of loading and types of member are given in Table 3.25.

The minimum number of longitudinal bars in a column should be four in rectangular columns and six in circular columns, and the size of bar should be not less than 12 mm.

3.12.5.4 Minimum size of bars in side faces of beams to control cracking (see 3.12.11.2.6)

The minimum size of bars in side faces of beams to control cracking should be not less than $\sqrt{s_b b/f_y}$ where s_b is the bar spacing and b the breadth of the section at the point considered, or 500 mm if b exceeds 500 mm.

Table 3.25 — Minimum percentages of reinforcement

Situation	Definition of percentage	Minimum percentage	
		$f_y = 250 \text{ N/mm}^2$ %	$f_y = 460 \text{ N/mm}^2$ %
<i>Tension reinforcement</i>			
Sections subjected mainly to pure tension	$100A_s/A_c$	0.8	0.45
Sections subjected to flexure:			
a) flanged beams, web in tension:			
1) $b_w/b < 0.4$	$100A_s/b_w h$	0.32	0.18
2) $b_w/b \geq 0.4$	$100A_s/b_w h$	0.24	0.13
b) flanged beams, flange in tension:			
1) T-beam	$100A_s/b_w h$	0.48	0.26
2) L-beam	$100A_s/b_w h$	0.36	0.20
c) rectangular section (in solid slabs this minimum should be provided in both directions)	$100A_s/A_c$	0.24	0.13
<i>Compression reinforcement (where such reinforcement is required for the ultimate limit state)</i>			
General rule	$100A_{sc}/A_{cc}$	0.4	0.4
Simplified rules for particular cases:			
a) rectangular column or wall	$100A_{sc}/A_c$	0.4	0.4
b) flanged beam:			
1) flange in compression	$100A_{sc}/bh_f$	0.4	0.4
2) web in compression	$100A_{sc}/b_w h$	0.2	0.2
c) rectangular beam	$100A_{sc}/A_c$	0.2	0.2
<i>Transverse reinforcement in flanges or flanged beams (provided over full effective flange width near top surface to resist horizontal shear)</i>	$100A_{st}/h_f l$	0.15	0.15

3.12.6 Maximum areas of reinforcement in members

3.12.6.1 Beams

Neither the area of tension reinforcement nor the area of compression reinforcement should exceed 4 % of the cross-sectional area of the concrete.

3.12.6.2 Columns

The longitudinal reinforcement should not exceed the following amounts, calculated as percentages of the gross cross-sectional area of the concrete:

- a) vertically-cast columns: 6 %;
- b) horizontally-cast columns: 8 %;
- c) laps in vertically- or horizontally-cast columns: 10 %.

3.12.6.3 Walls

The area of vertical reinforcement should not exceed 4 % of the gross cross-sectional area of the concrete.

3.12.7 Containment of compression reinforcement

3.12.7.1 Links for containment of beam or column compression reinforcement

When part or all of the main reinforcement is required to resist compression, links or ties, at least one-quarter the size of the largest compression bar or 6 mm, whichever is the greater, should be provided at a maximum spacing of 12 times the size of the smallest compression bar.

3.12.7.2 Arrangement of links for containment of beam or column compression reinforcement

Every corner, bar, and each alternate bar (or pair or bundle) in an outer layer of reinforcement should be supported by a link passing round the bar and having an included angle of not more than 135°. No bar within a compression zone should be further than 150 mm from a restrained bar.

3.12.7.3 Containment of compression reinforcement around periphery of circular column

Adequate lateral support is provided by a circular tie passing round the bars or groups. The size and spacing of the ties should be in accordance with 3.12.7.1.

3.12.7.4 Horizontal bars for support of small amounts of compression reinforcement in walls

Where the main vertical reinforcement is used to resist compression and does not exceed 2 % of the concrete area, at least the following percentages of horizontal reinforcement should be provided, depending upon the characteristic strength of that reinforcement:

- a) $f_y = 250 \text{ N/mm}^2$: 0.30 % of concrete area;
- b) $f_y = 460 \text{ N/mm}^2$: 0.25 % of concrete area.

These horizontal bars should be evenly spaced and be not less than one-quarter of the size of the vertical bars and not less than 6 mm.

3.12.7.5 Links for containment of large amounts of compression reinforcement in walls

When the vertical compression reinforcement exceeds 2 %, links at least 6 mm or one-quarter the size of the largest compression bar should be provided through the thickness of the wall. The spacing of links should not exceed twice the wall thickness in either the horizontal or vertical direction. In the vertical direction it should be not greater than 16 times the bar size. All vertical compression bars should be enclosed by a link. No bar should be further than 200 mm from a restrained bar, at which a link passes round the bar with an included angle of not more than 90°.

3.12.8 Bond, anchorage, bearing, laps, joints and bends in bars

3.12.8.1 Avoidance of bond failure due to ultimate loads

At both sides of any cross-section the force in each bar should be developed by an appropriate embedment length or other end anchorage. Provided this is done, local bond stress may be ignored.

3.12.8.2 Anchorage bond stress

Anchorage bond stress is assumed to be constant over the effective anchorage length. It may be taken as the force in the bar divided by its effective surface anchorage area (see 3.12.8.3). It should not exceed the appropriate value obtained from 3.12.8.4.

3.12.8.3 Design anchorage bond stress

The design anchorage bond stress f_b is assumed to be constant over the anchorage length and is given by the following equation:

$$f_b = F_s / \pi \varphi_e l \quad \text{equation 48}$$

where

- f_b is the bond stress;
- F_s is the force in the bar or group of bars;
- l is the anchorage length;
- φ_e is the effective bar size which, for a single bar is equal to the bar size and, for a group of bars in contact is equal to the diameter of a bar of equal total area

3.12.8.4 Values for design ultimate anchorage bond stress

Values for design ultimate anchorage bond stress f_{bu} may be obtained from the equation:

$$f_{bu} = \beta \sqrt{f_{cu}} \quad \text{equation 49}$$

where

- f_{bu} is the design ultimate anchorage bond stress;
- β is a coefficient dependent on the bar type.

For bars in tension in slabs or in beams where minimum links have been provided in accordance with Table 3.7, the values of β may be taken from Table 3.26. These values include a partial safety factor (γ_m) of 1.4.

Table 3.26 — Values of bond coefficient β

Bar type	β	
	Bars in tension	Bars in compression
Plain bars	0.28	0.35
Type 1: deformed bars	0.40	0.50
Type 2: deformed bars	0.50	0.63
Fabric (see 3.12.8.5)	0.65	0.81

In beams where minimum links in accordance with Table 3.7 have not been provided, the design anchorage bond stresses used should be those appropriate to plain bars irrespective of the type of bar used. This does not apply to slabs.

Values for anchorage lengths are given in Table 3.27 as multiples of bar size.

3.12.8.5 Design ultimate anchorage bond stresses for fabric

The value for design ultimate anchorage bond stress given in 3.12.8.4 for fabric is applicable to fabric manufactured from bars conforming to BS 4449 or wires conforming to BS 4482. This is provided:

- a) the fabric is welded in a shear resistance manner conforming to BS 4483; and
- b) the number of welded intersections within the anchorage length is at least equal to $4A_s$ required/ A_s provided.

When condition b) is not satisfied, the anchorage bond stress should be taken as that appropriate to the individual bars or wires in the sheet.

3.12.8.6 Anchorage of links

A link may be considered to be fully anchored if it satisfies the following:

- a) it passes round another bar of at least its own size, through an angle of 90° , and continues beyond for a minimum length of eight times its own size; or
- b) it passes round another bar of at least its own size, through an angle of 180° , and continues beyond for a minimum length of four times its own size.

In no case should the radius of any bend in the link be less than twice the radius of a test bend guaranteed by the manufacturer of the bar.

3.12.8.7 Anchorage of welded fabric used as links

A link may be considered to be fully anchored when it has within the length of the anchorage either two welded transverse wires or a single welded wire of a size not less than 1.4 times the size of the wire being anchored.

3.12.8.8 Anchorage of column starter bars in bases or pile caps

The compression bond stresses that develop on starter bars within bases or pile caps do not need to be checked provided:

- a) the starters extend down to the level of the bottom reinforcement;
- b) the base or pile cap has been designed for moments and shears in accordance with 3.11.

3.12.8.9 Laps and joints

Connections transferring stress may be lapped, welded or joined with mechanical devices³⁾. They should be placed, if possible, away from points of high stress and should preferably be staggered. Laps in fabric may be layered or nested to maintain the lapped bars in one plane.

3.12.8.10 Joints where imposed loading is predominantly cyclical

In such cases bars should not be joined by welding.

3.12.8.11 Minimum laps

The minimum lap length for bar reinforcement should be not less than 15 times the bar size or 300 mm, whichever is the greater, and for fabric reinforcement should be not less than 250 mm.

3.12.8.12 Laps in beams and columns with limited cover

Where both bars at a lap exceed size 20 and the cover is less than 1.5 times the size of the smaller bar, transverse links should be provided throughout the lap length. At the lap the links should be at least one-quarter the size of the smaller bar and the spacing should not exceed 200 mm.

3.12.8.13 Design of tension laps

The length should be at least equal to the design tension anchorage length (see 3.12.8.3 and 3.12.8.4) necessary to develop the required stress in the reinforcement. Lap lengths for unequal size bars (or wires in fabric) may be based upon the smaller bar. The following provisions also apply:

- a) where a lap occurs at the top of a section as cast and the minimum cover is less than twice the size of the lapped reinforcement, the lap length should be increased by a factor of 1.4;
- b) where a lap occurs at the corner of a section and the minimum cover to either face is less than twice the size of the lapped reinforcement or, where the clear distance between adjacent laps is less than 75 mm or six times the size of the lapped reinforcement, whichever is the greater, the lap length should be increased by a factor of 1.4;
- c) in cases where both conditions a) and b) apply, the lap length should be increased by a factor of 2.0.

Values for lap lengths are given in Table 3.27 as multiples of bar size.

3.12.8.14 Maximum amount of reinforcement in a layer including tension laps

At laps, the sum of the reinforcement sizes in a particular layer should not exceed 40 % of the breadth of the section at that level.

3.12.8.15 Design of compression laps

The length should be at least 25 % greater than the compression anchorage length (see 3.12.8.3 and 3.12.8.4) necessary to develop the required stress in the reinforcement. Lap lengths for unequal size bars (or wires in fabric) may be based upon the smaller bar.

Values for lap lengths are given in Table 3.27 as multiples of bar size.

³⁾ For further information see CIRIA Report 92, 1981, available from Construction Industry Research and Information Association, 6 Storey's Gate, Westminster, London SW1P 3AU.

Table 3.27 — Ultimate anchorage bond lengths and lap lengths as multiples of bar size

Reinforcement types	Grade 250 plain	Grade 460			
		Plain	Deformed type 1	Deformed type 2	Fabric
Concrete cube strength 25					
Tension anchorage and lap length	43	79	55	44	34
1.4 × tension lap	60	110	77	62	48
2.0 × tension lap	85	157	110	88	68
Compression anchorage length	34	63	44	35	28
Compression lap length	43	79	55	44	84
Concrete cube strength 30					
Tension anchorage and lap length	39	72	50	40	31
1.4 × tension lap	55	100	70	56	44
2.0 × tension lap	78	143	100	80	62
Compression anchorage length	32	58	40	32	25
Compression lap length	39	72	50	40	31
Concrete cube strength 35					
Tension anchorage and lap length	36	67	47	38	29
1.4 × tension lap	51	93	65	52	40
2.0 × tension lap	72	133	93	75	57
Compression anchorage length	29	53	38	30	23
Compression lap length	36	67	47	38	29
Concrete cube strength 40					
Tension anchorage and lap length	34	62	44	35	27
1.4 × tension lap	48	87	61	49	38
2.0 × tension lap	68	124	81	70	54
Compression anchorage length	27	50	35	28	22
Compression lap length	34	62	44	35	27
NOTE The values are rounded up to the nearest whole number and the length derived from these values may differ slightly from those calculated directly for each bar or wire size.					

3.12.8.16 Butt joints

3.12.8.16.1 Bars in compression

In such cases the load may be transferred by end bearing of square sawn-cut ends held in concentric contact by a suitable sleeve or other coupler. The concrete cover for the sleeve should be not less than that specified for normal reinforcement.

3.12.8.16.2 Bars in tension

The only acceptable form of full-strength butt joint for a bar in tension comprises a mechanical coupler satisfying the following criteria.

- When a test is made of a representative gauge length assembly comprising reinforcement of the size, grade and profile to be used and a coupler of the precise type to be used, the permanent elongation after loading to $0.6f_y$ should not exceed 0.1 mm.
- The tensile strength of the coupled bar should exceed 287.5 N/mm^2 for grade 250, 483 N/mm^2 for grade 460 A and 497 N/mm^2 for grade 460 B.

3.12.8.17 Welded joints in bars

For welded joints in bars, the following recommendations apply:

- a) welded joints should not occur at bends;
- b) where possible, joints in parallel bars of the principal tensile reinforcement should be staggered in the longitudinal direction.

3.12.8.18 Strength of welds

The following values may be used where the strength of the weld has been proved by tests to be at least as great as that of the parent bar.

- a) *Joints in compression*: 100 % of the design strength of joined bars.
- b) *Joints in tension*: 80 % of the design strength of joined bars (100 % if welding strictly supervised and if at any cross-section of the member not more than 20 % of the tensile reinforcement is welded).

3.12.8.19 Design shear strength of filler material in lap-joint welds

The design shear strength of filler material in lap-joint welds should be taken as 0.38 times its yield or proof stress as given in the appropriate British Standards.

3.12.8.20 Design of welded lap joints

The length of weld should be sufficient to transmit the design load in the bar.

3.12.8.21 Limitation of length of weld in laps

The length of a run of weld should not normally exceed five times the size of the bar. If a longer length of weld is required, it should be divided into sections and the space between runs made not less than five times the size of the bar.

3.12.8.22 Hooks and bends

End anchorages in the form of hooks and bends should only be used to meet specific design requirements and should conform to BS 4466.

3.12.8.23 Effective anchorage length of a hook or bend

The effective anchorage length of a hook or bend is the length of straight bar which would be equivalent in anchorage value to that portion of the bar between the start of the bend and a point four times the bar size beyond the end of the bend. This effective anchorage length may be taken as follows:

- a) *For a 180° hook*: either 1) eight times the internal radius of the hook with a maximum of 24 times the bar size; or 2) the actual length of bar in the hook including the straight portion, whichever is greater.
- b) *For a 90° bend*: either 1) four times the internal radius of the bend with a maximum of 12 times the bar size; or 2) the actual length of the bar, whichever is greater.

Any length of bar in excess of four bar-diameters beyond the end of the bend and which lies within the concrete in which the bar is to be anchored may also be included for effective anchorage.

3.12.8.24 Minimum radius of bends

In no case should this be less than twice the radius of the test bend guaranteed by the manufacturer of the bar, nor less than the radius required to ensure that the bearing stress at the mid-point of the curve does not exceed the values given in **3.12.8.25**.

3.12.8.25 Design bearing stress inside bends**3.12.8.25.1 Cases where checking is not needed**

Cases where the design bearing stress inside bends need not be checked are:

- a) where the bar does not extend beyond a point four bar-diameters past the end of the bend;
- b) where the bar is assumed not to be stressed beyond a point four bar-diameters past the end of the bend at the ultimate limit state.

3.12.8.25.2 Other bars

The design bearing stress should be calculated from the following equation:

$$\text{bearing stress} = \frac{F_{bt}}{r\varphi} \leq \frac{2f_{cu}}{1 + 2(\varphi/\alpha_b)} \quad \text{equation 50}$$

where

- F_{bt} is the tensile force due to ultimate loads in a bar or group of bars in contact at the start of a bend;
- r is the internal radius of the bend;
- φ is the size of the bar (or, for a group, the size of a bar of equivalent area);
- a_b for a given bar (or group of bars in contact) is the centre-to-centre distance between bars (or groups of bars) perpendicular to the plane of the bend; for a bar or group of bars adjacent to the face of the member, a_b should be taken as the cover plus φ .

NOTE The equation includes an allowance for γ_m .

3.12.9 Curtailment and anchorage of bars

3.12.9.1 General

Except at end supports (see 3.12.9.4) in every flexural member every bar should extend beyond the point at which in theory it is no longer needed, for a distance at least equal to the greater of:

- a) the effective depth of the member; or
- b) twelve times the bar size.

In addition for a bar in the tension zone, one of the following distances for all arrangements of design ultimate load should be considered:

- c) an anchorage length appropriate to its design strength ($0.95f_y$) from the point at which it is no longer required to assist in resisting the bending moment; or
- d) to the point where the design shear capacity of the section is greater than twice the design shear force at that section; or
- e) to the point where other bars continuing past that point provide double the area required to resist the design bending moment at that section.

Simplified rules for curtailment are also given in 3.12.10.

3.12.9.2 Point at which a bar is no longer required

The point at which a bar is no longer required is the point where the design resistance moment of the section, considering only the continuing bars, is equal to the design moment.

3.12.9.3 Curtailment of a large number of bars

As curtailment of substantial areas of reinforcement at a single section can lead to the development of large cracks at that point, it is therefore advisable to stagger the curtailment points in heavily reinforced members.

3.12.9.4 Anchorage of bars at a simply-supported end of a member

At a simply-supported end of a member, each tension bar should be anchored by one of the following:

- a) an effective anchorage length equivalent to 12 times the bar size beyond the centre-line of the support; no bend or hook should begin before the centre of the support;
- b) an effective anchorage length equivalent to 12 times the bar size plus $d/2$ from the face of the support, where d is the effective depth of member; no bend or hook should begin before $d/2$ from the face of the support;
- c) for slabs, if the design ultimate shear stress at the face of the support is less than half the appropriate value, v_c , recommended in 3.4.5, a straight length of bar beyond the centre-line of the support equal to either one-third of the support width or 30 mm, whichever is the greater.

3.12.10 Curtailment of reinforcement

3.12.10.1 General

The rules given in 3.12.10.2 and 3.12.10.3 do not necessarily provide the area or continuity of reinforcement required to satisfy the tie provisions of 3.12.3.

Where a cantilever forms an extension beyond the end support of a continuous beam or slab, care should be taken to ensure that the top steel in the adjacent span extends beyond the point of contraflexure.

3.12.10.2 *Simplified rules for beams*

The simplified curtailment rules illustrated in Figure 3.24 may be used for beams in the following circumstances.

- a) The beams are designed for predominantly uniformly distributed loads.
- b) In the case of continuous beams, the spans are approximately equal.

3.12.10.3 *Simplified rules for slabs*

3.12.10.3.1 *General*

The simplified curtailment rules illustrated in Figure 3.25 may be used for slabs in the following circumstances (but see 3.5.3.5 for details of torsion reinforcement at the corners of two-way slabs, 3.7.4.4 for detailing rules at the edges of flat slabs and 3.12.10.3.2 for end supports of continuous slabs):

- a) the slabs are designed for predominantly uniformly distributed loads;
- b) in the case of continuous slabs, the design has been carried out for the single load case of maximum design load on all spans and the spans are approximately equal.

3.12.10.3.2 *Curtailment of bars at end support of slabs (where simple support has been assumed in assessment of moments)*

Despite this assumption, negative moments may arise which could lead to cracking. To control this, an amount of reinforcement equal to half the area of bottom steel at mid-span but not less than the minimum given in 3.12.5.3 should be provided in the top of the slab at the support. It should have a full effective tensile anchorage into the support and extend not less than $0.15l$ or 45 times the bar size into the span. Bottom reinforcement may be detailed:

- a) as indicated in Figure 3.25 for a simply-supported end, in which case the shear strength at the support may be based on the area of bottom steel continuing into the support; or
- b) as indicated in Figure 3.25 for a simply-supported end except that the bottom steel is stopped at the line of effective support; in this case the shear strength at the support should be based on the area of top steel.

3.12.11 *Spacing of reinforcement*

3.12.11.1 *Minimum distance between bars*

The horizontal distance between bars should not be less than $h_{agg} + 5$ mm, where h_{agg} is the maximum size of coarse aggregate. Where there are two or more rows:

- a) the gaps between corresponding bars in each row should be vertically in line;
- b) the vertical distance between bars should be not less than $2h_{agg}/3$.

When the bar size exceeds $h_{agg} + 5$ mm, a spacing less than the bar size or equivalent bar size should be avoided.

3.12.11.2 *Maximum distance between bars in tension*

3.12.11.2.1 *General*

In normal internal or external conditions of exposure where the limitation of crack widths to 0.3 mm is appropriate, unless the calculation of crack widths (see 3.8 of BS 8110-2:1985) shows that a greater spacing is acceptable, the bar spacings given in 3.12.11.2.2 to 3.12.11.2.9 may be used for beams and for slabs where the cover does not exceed 50 mm. Where other conditions apply see BS 8110-2.

3.12.11.2.2 *Bars of mixed sizes*

In the application of these rules any bar with a diameter less than 0.45 times that of the largest bar in the section should be ignored except when considering those in the side faces of beams.

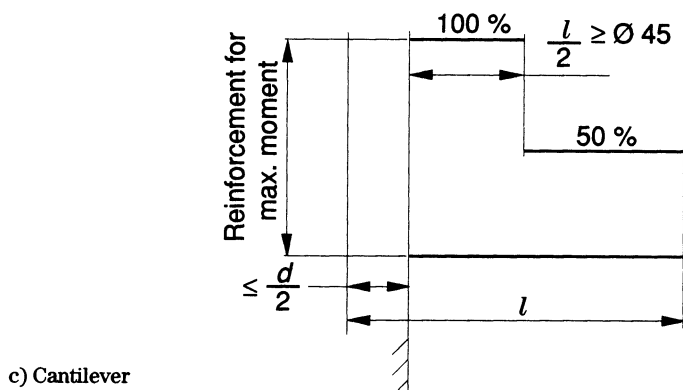
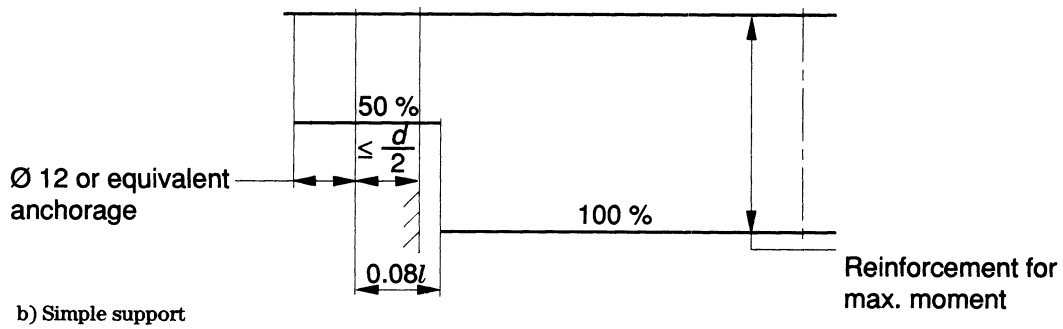
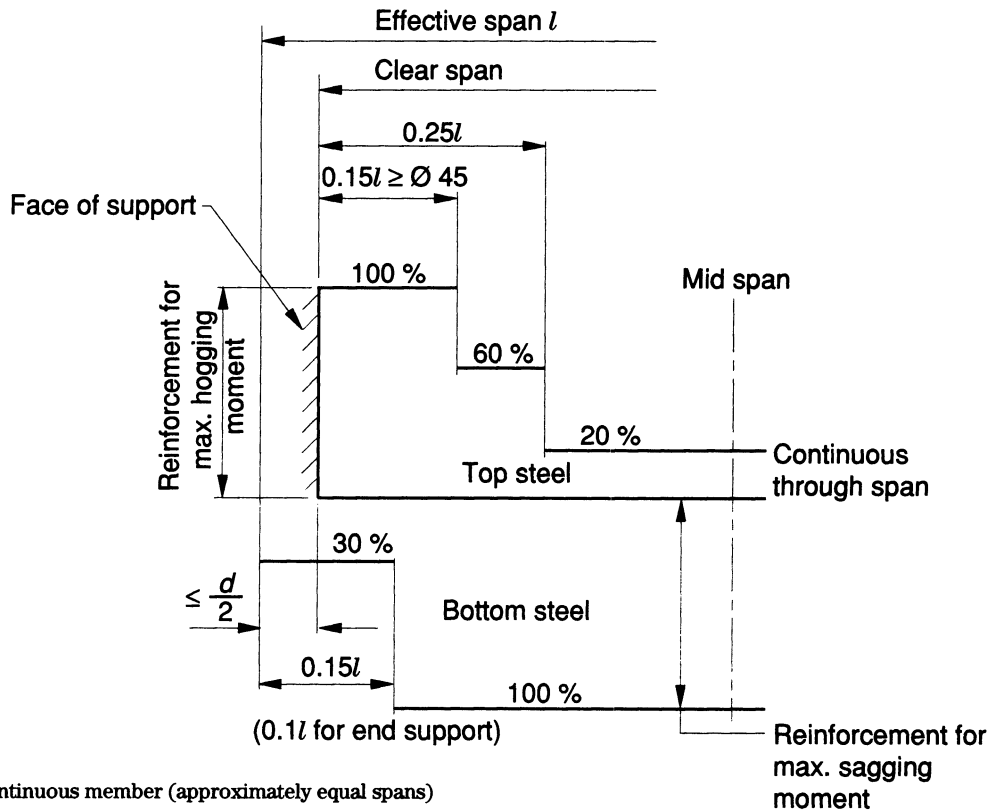

NOTE *d* is the effective depth;
l is the effective span;
 φ is the bar size.

Figure 3.24 — Simplified detailing rules for beams

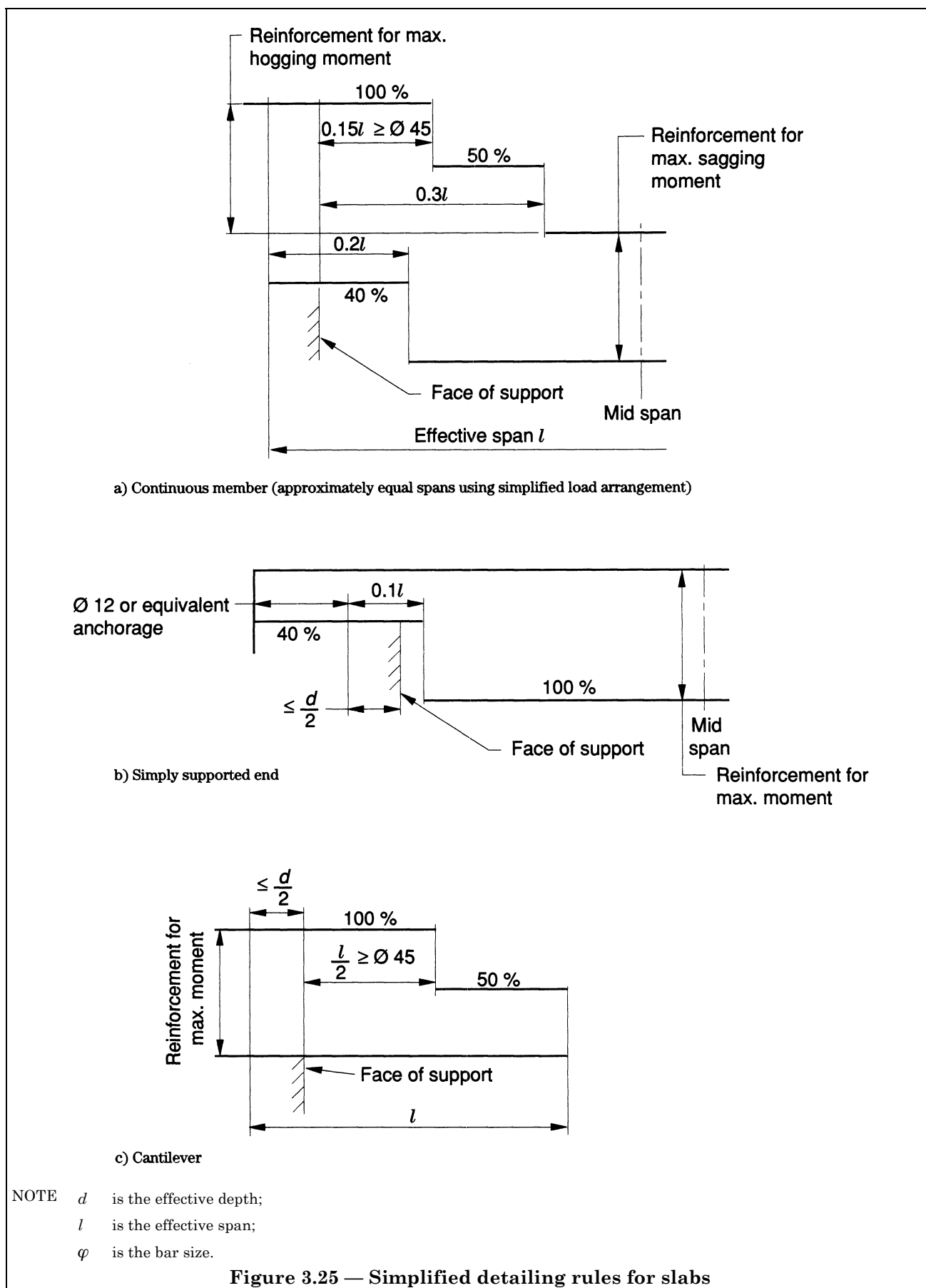

3.12.11.2.3 Clear horizontal distance between bars in tension

The clear horizontal distance between adjacent bars, or groups, near the tension face of a beam should be not greater than the value given in Table 3.28 depending on the amount of redistribution carried out in analysis and the characteristic strength of the reinforcement. Sub-clauses 3.12.11.2.4 to 3.12.11.2.9 give details of cases where Table 3.28 does not apply or its recommendations may be adjusted.

Table 3.28 — Clear distance between bars according to percentage redistribution

f_y	% redistribution to or from section considered						
	- 30	- 20	- 10	0	+ 10	+ 20	+ 30
	mm	mm	mm	mm	mm	mm	mm
250	200	225	255	280	300	300	300
460	110	125	140	155	170	185	200

NOTE The values are derived from the expression:

$$\text{clear spacing} \leq \frac{70\,000\beta_b}{f_y} \leq 300$$

where

β_b is the ratio:

$$\frac{\text{(moment at the section after redistribution)}}{\text{(moment at the section before redistribution)}}$$

from the respective maximum moments diagram.

3.12.11.2.4 Clear distance between bars in tension

Instead of using the values given in Table 3.28 the clear spacing may be assessed from the relationship:

$$\text{clear spacing} \leq \frac{47\,000}{f_s} \leq 300$$

where

f_s is the estimated service stress in the reinforcement which may be obtained from equation 8 (see 3.4.6.5).

3.12.11.2.5 Clear distance between the face of the beam and nearest longitudinal bar in tension

The distance between the face of the beam and the nearest longitudinal bar in tension should not be greater than half the clear distance given in Table 3.28 or as derived from 3.12.11.2.4.

3.12.11.2.6 Bars near side faces of beams exceeding 750 mm overall depth

To control cracking longitudinal bars should be distributed at a spacing not exceeding 250 mm near the side faces of the beam. This distribution should be over a distance of two-thirds of the beam's overall depth measured from its tension face. The bar size should be in accordance with 3.12.5.4.

3.12.11.2.7 Slabs

In no case should the clear spacing between bars exceed the lesser of three times the effective depth or 750 mm.

In addition, unless crack widths are checked by direct calculation, the following rules will ensure adequate control of cracking for slabs subjected to normal internal and external environments:

- a) no further check is required on bar spacing if either.
 - 1) grade 250 steel is used and the slab depth does not exceed 250 mm; or
 - 2) grade 460 steel is used and the slab depth does not exceed 200 mm; or
 - 3) the reinforcement percentage ($10A_s/bd$) is less than 0.3 %.

where

A_s is the area of tension reinforcement required for the ultimate limit state;

b is the breadth of section at the point considered;

d is the effective depth;

b) where none of the conditions 1), 2) and 3) apply, the bar spacings should be limited to the values given in Table 3.28 for slabs where the reinforcement percentage exceeds 1 % or the values given in Table 3.28 divided by the reinforcement percentage for lesser amounts.

3.12.11.2.8 *Slabs where amount of redistribution is unknown*

When using Table 3.28 for slabs, a value of (– 15 %) may be assumed for support moments and zero for span moments.

3.12.11.2.9 *Spacing of shrinkage reinforcement*

When reinforcement is needed to distribute cracking arising from shrinkage and temperature effects, the recommendations given in **3.9.4.19** and **3.9.4.20** for plain walls should be followed.

Section 4. Design and detailing: prestressed concrete

NOTE In this section the design strengths of materials are expressed in all tables and equations in terms of the characteristic strength of the material. Unless specifically stated otherwise, all equations and tables include allowances for γ_m .

4.1 Design basis

4.1.1 General

This section follows the limit state philosophy set out in section 2. As it is not possible to assume that a particular limit state will always be the critical one, design methods are given for the ultimate limit state and the serviceability limit states.

For lightweight aggregate concrete, design should be with reference to section 5 of BS 8110-2:1985. The prestress losses will, in general, be greater than those for dense aggregate concrete; specialist literature gives guidance.

This section gives methods of analysis and design which will in general ensure that, for prestressed concrete construction, the design requirements given in section 2 are met.

Other methods may be used provided they can be shown to be satisfactory for the type of structure or member considered.

4.1.2 Alternative methods

In certain cases the assumptions made in this section may be inappropriate and a more suitable method should be adopted which takes account of the special nature of the structure.

4.1.3 Serviceability classification

In the assessment of the likely behaviour of a prestressed concrete structure or element, the amount of flexural tensile stress allowed under service load defines its class as follows:

- class 1: no flexural tensile stresses;
- class 2: flexural tensile stresses but no visible cracking;
- class 3: flexural tensile stresses but surface width of cracks not exceeding 0.1 mm for members in very severe environments (see Table 3.2) and not exceeding 0.2 mm for all other members.

4.1.4 Critical limit state

In general, the design of class 1 and 2 members is controlled by the concrete tension limitations for service load conditions, but the design ultimate strength in flexure, shear and torsion should be checked. The design of class 3 members is usually controlled by ultimate limit state conditions or by deflection.

4.1.5 Durability and fire resistance

Durability and fire resistance depend on the amount of concrete cover to reinforcement and prestressing tendons and the quality of all materials and workmanship. Recommendations are given in 4.12.3 and sections 6, 7 and 8. Fire test results or other evidence may be used to ascertain the fire resistance of a member or reference may be made to section 4 of BS 8110-2:1985.

4.1.6 Stability, robustness and other considerations

For recommendations on vibration and other considerations including stability, reference should be made to sections 2 and 3, and to 2.6 and section 3 of BS 8110-2:1985.

4.1.7 Loads

4.1.7.1 Load values

The values of the design ultimate loads are those given in 2.4.3. The design loads to be used for the serviceability limit states (see 4.3.4 and 4.3.5) are the characteristic values.

4.1.7.2 Design load arrangements

In general, when assessing any particular effect of loading, the arrangement of loads should be that causing the most severe effect. Consideration should be given to the construction sequence and to the secondary effects due both to the construction sequence and to the prestress particularly for the serviceability limit states.

4.1.8 Strength of materials

4.1.8.1 Characteristic strength of concrete

The appropriate grade of concrete should be selected from the preferred grades in 6 and 8.5 of BS 5328-1:1997. Grades C35 and C40 are the minimum recommended for post-tensioning and pre-tensioning respectively. In both cases the concrete strength at transfer should be not less than 25 N/mm².

4.1.8.2 Characteristic strength of steel

The specified characteristic strengths of prestressing tendons are given in the appropriate British Standards, and those for reinforcement are given in 3.1.7.4.

4.2 Structures and structural frames

4.2.1 Analysis of structures

Complete structures and complete structural frames may be analysed in accordance with the recommendations of 2.5 and 2.6 but, when appropriate, the methods given in 4.3 may be used for the analysis of individual members.

4.2.2 Relative stiffness

Relative stiffness should generally be based on the concrete section as described in 2.5.2.

4.2.3 Redistribution of moments

4.2.3.1 General

Redistribution of moments obtained by elastic analysis may be carried out, for the ULS only, provided the following conditions are satisfied.

- a) Equilibrium between internal forces and external loads is maintained under each appropriate combination of design ultimate load.
- b) The reduction made to the maximum design moment within each region of hogging or sagging moments, derived from an elastic maximum moments diagram covering all appropriate combinations of design ultimate load, does not exceed 20 % (but see 4.2.3.2 for certain structures over four storeys).
- c) Where the design moment is reduced at a section described in b), the neutral axis depth x should be checked to see that it is not greater than $(\beta_b - 0.5)d$,

where

d is the effective depth;

β_b is the ratio:

$$\frac{\text{(moment at the section after redistribution)}}{\text{(maximum elastic moment at the section)}}$$

NOTE In general, condition c) will limit or prevent redistribution in class 1 and 2 members, unless the prestress is small. Redistribution involving a reduction of moment in columns will generally be ruled out, unless the design ultimate axial load and the prestress in the column are small.

4.2.3.2 Restriction in structures over four storeys where structural frame provides lateral stability

The provisions of 4.2.3.1 apply except that the limit of b) is 10 %.

4.3 Beams

4.3.1 General

The definitions and limitations of the geometric properties for prestressed beams are as given for reinforced concrete beams in 3.4.1 except that the overall depth of the member should be used instead of the effective depth.

4.3.2 Slender beams

Beams should not be unnecessarily slender (see 3.4.1.6). Particular attention should be paid to possible instability during construction as well as when under load in their final positions. Members may collapse by tilting about a longitudinal axis through the lifting points. This initial tilting, which may be due to imperfections in beam geometry and in locating the lifting points, could cause lateral bending moments and these, if too high, could result in lateral instability. The problem is complex and experience is the best guide. The following factors may require consideration:

- a) beam geometry, i.e. type of cross-section, span/breadth/depth ratios, etc;
- b) location of lifting points;
- c) method of lifting, i.e. inclined or vertical slings, type of connection between the beam and the slings;
- d) tolerances in construction, e.g. maximum lateral bow.

The design stresses due to the combined effects of lateral bending, dead load and prestress may need to be assessed; if cracking is possible the lifting arrangements should be changed or the beam should be provided with adequate lateral support.

4.3.3 Continuous beams

An elastic analysis may be made considering the following arrangements of load. The design loads should be those relating to the limit state considered (see 2.4.3 of this standard and 2.2 of BS 8110-2:1985 for ULS and 3.3 of BS 8110-2:1985 for SLS). The arrangements of load are:

- a) alternate spans loaded with the maximum design load and all other spans loaded with the minimum design load;
- b) all spans loaded with the maximum design load.

Redistribution of the moments obtained by this method may be carried out for the ULS only, within the limits recommended in 4.2.3.

4.3.4 Serviceability limit state for beams

4.3.4.1 Section analysis

The following assumptions should be made:

- a) plane sections remain plane;
- b) elastic behaviour exists for concrete stresses up to the values given in 4.3.4.2, 4.3.4.3 and 4.3.5;
- c) the elastic modulus for steel is given in Figure 2.2 and Figure 2.3; for concrete see 7.2 of BS 8110-2:1985;
- d) in general, it is only necessary to calculate design stresses due to the load arrangements (see 4.1.7.2 or 4.3.3) immediately after the transfer of prestress and after all losses of prestress have occurred; in both cases the effects of dead and imposed loads on the strain and force in the tendons may be ignored.

4.3.4.2 Compressive stresses in concrete

In flexural members compressive stresses should not exceed $0.33f_{cu}$ at the extreme fibre, except in continuous beams and other statically indeterminate structures where they may be increased to $0.4f_{cu}$ within the range of support moments. In direct compression the stress should not exceed $0.25f_{cu}$.

4.3.4.3 Flexural tensile stresses in concrete

Tension should not be allowed at mortar or concrete joints of members made up of precast units under the design load. Elsewhere stresses should not exceed the following for different classes.

- a) *Class 1 members*. No tensile stress.
- b) *Class 2 members*. The design tensile stresses should not exceed the design flexural tensile strength of the concrete for pre-tensioned members nor 0.8 of the design flexural tensile strength for post-tensioned members. The limiting tensile stresses are $0.45\sqrt{f_{cu}}$ for pre-tensioned members and $0.36\sqrt{f_{cu}}$ for post-tensioned members. Values are given in Table 4.1⁴⁾

⁴⁾ Although f_{cu} is in newtons per square millimetre, the values of terms in $\sqrt{f_{cu}}$ are also, numerically, in newtons per square millimetre. Similar provisions apply in later sub-clauses.

The design stress given in Table 4.1 may be increased by up to 1.7 N/mm^2 provided that it is shown by tests that such enhanced stress does not exceed three-quarters of the tensile stress calculated from the loading in the performance test corresponding to the appearance of the first crack. Where such increase is used, the stress in the concrete, due to prestress after losses, should be at least 10 N/mm^2 .

Table 4.1 — Design flexural tensile stresses for class 2 members: serviceability limit state: cracking

Type of prestressed member	Design stress for concrete grade			
	30 N/mm ²	40 N/mm ²	50 N/mm ²	60 N/mm ²
Pre-tensioned	—	2.9	3.2	3.5
Post-tensioned	2.1	2.3	2.6	2.8

Where a design service load is of a temporary nature and is exceptionally high in comparison with the load normally carried, the values given in Table 4.1 may be further increased by up to 1.7 N/mm^2 , provided that under normal service conditions the stress is compressive to ensure that any cracks which might have occurred close up.

When the stresses in Table 4.1 are exceeded for either of the reasons given above, any pre-tensioned tendons should be well distributed throughout the tension zone of the section and post-tensioned tendons should be supplemented if necessary by additional reinforcement located near the tension face of the member.

c) *Class 3 members.* Although cracking is allowed it is assumed that the concrete section is uncracked and that design hypothetical tensile stresses exist at the limiting crack widths in 4.1.3. The design hypothetical tensile stresses for use in these calculations for members with either pre-tensioned or grouted post-tensioned tendons are given in Table 4.2, modified by the coefficients in Table 4.3 and by the following.

The cracking in prestressed concrete flexural members is dependent on the member depth and the design stress given in Table 4.2 should be modified by multiplying by the appropriate factor from Table 4.3.

For composite construction when the flexural stresses given in Table 4.2 are not exceeded during construction the full depth of the section should be used when using Table 4.3.

Table 4.2 — Design hypothetical flexural tensile stresses for class 3 members

Group	Limiting crack width mm	Design stress for concrete grade		
		30 N/mm ²	40 N/mm ²	50 and over N/mm ²
a) Pre-tensioned tendons	0.1	—	4.1	4.8
	0.2	—	5.0	5.8
b) Grouted post-tensioned tendons	0.1	3.2	4.1	4.8
	0.2	3.8	5.0	5.8
c) Pre-tensioned tendons distributed in the tensile zone and positioned close to the tension faces of the concrete	0.1	—	5.3	6.3
	0.2	—	6.3	7.3

Table 4.3 — Depth factors for design tensile stresses for class 3 members

Depth of member mm	Factor
200 and under	1.1
400	1.0
600	0.9
800	0.8
1 000 and over	0.7
NOTE Intermediate values are found by interpolation.	

When additional reinforcement is contained within the tension zone, and is positioned close to the tension faces of the concrete, these modified design hypothetical tensile stresses may be increased by an amount that is in proportion to the cross-sectional area of the additional reinforcement (expressed as a percentage of the cross-sectional area of the concrete in the tension zone). For 1 % of additional reinforcement, the stresses may be increased by 4.0 N/mm² for members in groups a) and b) and by 3.0 N/mm² for members in group c). For other percentages of additional reinforcement, the stresses may be increased in proportion up to a limit of 0.25 f_{cu} .

When a significant proportion of the design service load is transitory (see 3.3.3 of BS 8110-2:1985) so that the whole section is in compression under the permanent (dead plus frequently occurring imposed) load, the foregoing hypothetical tensile stresses may be exceeded under the full service load.

4.3.5 Stress limitations at transfer for beams

4.3.5.1 Design compressive stresses

Design compressive stresses should not exceed 0.5 f_{ci} at the extreme fibre nor 0.4 f_{ci} for near uniform distributions of prestress, where f_{ci} is the concrete strength at transfer.

4.3.5.2 Design tensile stresses in flexure

Design tensile stresses in flexure should not exceed the following values (see 4.1.3).

- a) *Class 1 members.* 1.0 N/mm².
- b) *Class 2 members.* 0.45 $\sqrt{f_{ci}}$ for pre-tensioned members or 0.36 $\sqrt{f_{ci}}$ for post-tensioned members where f_{ci} is as defined in 4.3.5.1. Members with pre-tensioned tendons should have some tendons or additional reinforcement well distributed throughout the tensile zone of the section. Members with post-tensioned tendons should, if necessary, have additional reinforcement located near the tension face of the member.
- c) *Class 3 members.* The design tensile stress should not, in general, exceed the appropriate value for a class 2 member. Where this stress is exceeded, the section should, in design, be considered as cracked.

4.3.6 Deflection of beams

4.3.6.1 General

The serviceability requirements for deflection are given in 2.2.3.2, but no numerical limits are set. For reinforced concrete, in all normal cases, deflections are controlled by limiting the ratio of span to effective depth. In general, this approach is not possible for prestressed concrete, because of major influence of the level of prestress. When it is considered necessary to calculate deflections, the methods outlined in 4.3.6.2 may be used.

4.3.6.2 Method of calculation

Elastic analysis based on the concrete section properties may be used for instantaneous and long term deflection of class 1 and class 2 members, and for class 3 members where the design permanent loads result on stresses no greater than those in Table 4.1. In other cases, more rigorous calculations based on the moment-curvature relationship for cracked sections should be carried out.

Suitable levels of design loading and design criteria should be selected from section 3 of BS 8110-2:1985 where values for the relevant material properties may also be obtained. In determining the effective modules of elasticity for the calculation of long term deflections, values for the creep coefficient may be determined from either 4.8.5 or 7.3 of BS 8110-2:1985.

4.3.7 Ultimate limit state for beams in flexure

4.3.7.1 Section analysis

The following assumptions should be made.

- a) The strain distribution in the concrete in compression is derived from the assumption that plane sections remain plane.
- b) The design stresses in the concrete in the compression are derived either from the stress-strain curve given in Figure 2.1 with $\gamma_m = 1.5$ or taken as $0.45f_{cu}$ for a depth (from the compression face) equal to 0.9 times the depth of the compression zone.

NOTE In both cases the strain at the outermost compression fibre is taken as 0.0035.

- c) The tensile strength of concrete is ignored.
- d) The strains in bonded prestressing tendons and in any additional reinforcement, whether in tension or compression, are derived from the assumption that plane sections remain plane.
- e) The design stresses in bonded prestressing tendons, whether initially tensioned or untensioned, and in any additional reinforcement are derived from the appropriate stress-strain curve; the stress-strain curves for prestressing tendons are given in Figure 2.3 and those for reinforcement in Figure 2.2. (An alternative approach for obtaining the stress in the tendons is given in 4.3.7.3 and Table 4.4.)
- f) The design stress in unbonded prestressing tendons is limited to the values given by equation 52 unless a higher value can be justified by a more rigorous analysis or on the basis of tests.

4.3.7.2 Symbols

For the purposes of 4.3.7, the following symbols apply.

- A_{ps} area of prestressing tendons in the tension zone.
- A_s area of reinforcement.
- b width or effective width of the section or flange in the compression zone.
- d effective depth to the centroid of the steel area A_{ps} .
- d_n depth to the centroid of the compression zone.
- f_{pb} design tensile stress in the tendons.
- f_{pe} design effective prestress in the tendons after all losses.
- M_u design moment of resistance of the section.
- x depth of the neutral axis.

4.3.7.3 Design formulae

The resistance moment of a beam M_u , containing bonded or unbonded tendons, all of which are located in the tension zone, may be obtained from the following equation:

$$M_u = f_{pb}A_{ps}(d - d_n) \quad \text{equation 51}$$

For a rectangular beam, or a flanged beam in which the flange thickness is not less than $0.9x$, d_n may be taken as $0.45x$.

For bonded tendons, values of f_{pb} and x may be obtained from Table 4.4. These values have been derived from the assumptions in 4.3.7.1.

For unbonded tendons, values of f_{pb} and x may be obtained from equations 52 and 53. The value of f_{pb} should not be taken as greater than $0.7f_{pu}$.

$$f_{pb} = f_{pe} + \frac{7000}{l/d} \left(1 - 1.7 \frac{f_{pu}A_{ps}}{f_{cu}bd} \right) \quad \text{equation 52}$$

$$x = 2.47 \left[\left(\frac{f_{pu}A_{ps}}{f_{cu}bd} \right) \left(\frac{f_{pb}}{f_{pu}} \right) d \right] \quad \text{equation 53}$$

Equation 52 has been derived by taking the length of the zone of inelasticity within the concrete as $10x$. The length l should normally be taken as the length of the tendons between end anchorages. This length may be reduced in the case of continuous multi-span members when an analysis is carried out to determine the minimum number of zones of inelasticity associated with each arrangement of design load.

Table 4.4 — Conditions at the ultimate limit state for rectangular beams with pre-tensioned tendons or post-tensioned tendons having effective bond

$\frac{f_{pu}A_{ps}}{f_{cu}bd}$	Design stress in tendons as a proportion of the design strength, $f_{pb}/0.95f_{pu}$			Ratio of depth of neutral axis to that of the centroid of the tendons in the tension zone, x/d		
	f_{pe}/f_{pu}			f_{pe}/f_{pu}		
	0.6	0.5	0.4	0.6	0.5	0.4
0.05	1.00	1.00	1.00	0.12	0.12	0.12
0.10	1.00	1.00	1.00	0.23	0.23	0.23
0.15	0.95	0.92	0.89	0.33	0.32	0.31
0.20	0.87	0.84	0.82	0.41	0.40	0.38
0.25	0.82	0.79	0.76	0.48	0.46	0.45
0.30	0.78	0.75	0.72	0.55	0.53	0.51
0.35	0.75	0.72	0.70	0.62	0.59	0.57
0.40	0.73	0.70	0.66	0.69	0.66	0.62
0.45	0.71	0.68	0.62	0.75	0.72	0.66
0.50	0.70	0.65	0.59	0.82	0.76	0.69

4.3.7.4 Allowance for additional reinforcement in the tension zone

In the absence of a rigorous analysis, the area of reinforcement A_s may be replaced by an equivalent area of prestressing tendons $A_s f_y / f_{pu}$.

4.3.8 Design shear resistance of beams

4.3.8.1 Symbols

For the purposes of 4.3.8 the following symbols apply.

- A_{sv} cross-sectional area of the two legs of a link.
- b_v breadth of the member, or for T-, I- and L-beams, the breadth of the rib.
NOTE Where a duct occurs in a rib, the value of b_v should be reduced by the size of the duct if ungrouted and two-thirds of the size if grouted.
- d distance from the extreme compression fibre to the centroid of the steel area ($A_{ps} + A_s$) in the tension zone.
- d_t depth from the extreme compression fibre either to the longitudinal bars (see 4.3.8.9) or to the centroid of the tendons, whichever is the greater.
- f_{cp} design compressive stress at the centroidal axis due to prestress, taken as positive.
- $f_{cp,x}$ design stress at a distance x from the end of member.
- f_{pe} design effective prestress in the tendons after all losses have occurred, which should not be taken as greater than $0.6f_{pu}$.
NOTE Where the steel area in the tension zone consists of tendons and reinforcement, f_{pe} may be taken as the value obtained by dividing the effective prestressing force by an equivalent area of tendons equal to $(A_{ps} + A_s f_y / f_{pu})$.
- f_t maximum design principal tensile stress.
- f_{yv} characteristic strength of the reinforcement, which should not be taken as greater than 460 N/mm^2 .
- l_p length of prestress development.
- M_0 moment necessary to produce zero stress in the concrete at the extreme tension fibre; in this calculation only 0.8 of the stress due to prestress should be taken into account.

s_v	link spacing along the length of the member.
v_c	design concrete shear stress obtained from Table 3.8 in which A_s is replaced by $(A_{ps} + A_s)$ where A_{ps} and A_s are the respective areas of tendons and reinforcement in the tension zone.
V and M	design shear force and bending moment values at the section due to the particular ultimate load condition.
V_c	design ultimate shear resistance of the concrete.
V_{co}	design ultimate shear resistance of a section uncracked in flexure.
V_{cr}	design ultimate shear resistance of a section cracked in flexure.

4.3.8.2 Maximum design shear stress

In no circumstances should the maximum design shear stress (see 4.3.8.4 and 4.3.8.5) exceed $0.8\sqrt{f_{cu}}$ or 5 N/mm^2 , whichever is the lesser (this includes an allowance of 1.25 for γ_m).

4.3.8.3 Calculation of design shear resistance

The design ultimate shear resistance of the concrete alone V_c should be considered at sections that are uncracked ($M < M_o$) and at sections that are cracked ($M \geq M_o$) in flexure, as follows.

- At uncracked sections, V_{co} should be evaluated from 4.3.8.4.
- At cracked sections, V_{co} and V_{cr} should be evaluated from 4.3.8.4 and 4.3.8.5 and the lesser value taken.

If necessary, shear reinforcement should be provided in accordance with 4.3.8.7 and 4.3.8.8.

4.3.8.4 Sections uncracked in flexure

The design ultimate shear resistance of a section uncracked in flexure V_{co} corresponds to the occurrence of a maximum design principal tensile stress at the centroidal axis of the section of $f_t = 0.24\sqrt{f_{cu}}$.

In the calculation of V_{co} , the design value of the prestress at the centroidal axis should be taken as $0.8f_{cp}$. The value of V_{co} is given in the following equation:

$$V_{co} = 0.67b_v h \sqrt{f_t^2 + 0.8f_{cp}f_t} \quad \text{equation 54}$$

Values of $V_{co}/b_v h$ obtained from equation 54 are given in Table 4.5 for applicable values of f_{cp} . In flanged members where the centroidal axis occurs in the flange the principal tensile stress should be limited to $0.24\sqrt{f_{cu}}$ at the intersection of the flange and web; in this calculation, 0.8 of the stress due to prestress at this intersection should be used in calculating V_{co} .

For a section uncracked in flexure and with inclined tendons or compression zones, the design shear forces produced should be combined algebraically with the external design load effects.

Table 4.5 — Values of $V_{co}/b_v h$

f_{cp} N/mm ²	Concrete grade			
	30 N/mm ²	40 N/mm ²	50 N/mm ²	60 N/mm ²
2	1.30	1.45	1.60	1.70
4	1.65	1.80	1.95	2.05
6	1.90	2.10	2.20	2.35
8	2.15	2.30	2.50	2.65
10	2.35	2.55	2.70	2.85
12	2.55	2.75	2.95	3.10
14	2.70	2.95	3.15	3.30

In a pre-tensioned member the critical section should be taken at a distance from the edge of the bearing equal to the height of the centroid of the section above the soffit. Where the section occurs within the prestressed development length, the compressive stress at the centroidal axis due to prestress, f_{cpx} , to be used in equation 54 may be calculated from the following relationship:

$$f_{cpx} = \frac{x}{l_p} \left(2 - \frac{x}{l_p} \right) f_{cp}$$

where

f_{cp} is the design stress at the end of the prestress development length l_p .

The prestress development length should be taken as either the transmission length (see 4.10) or the overall depth of the member, whichever is the greater.

4.3.8.5 Sections cracked in flexure

The design ultimate shear resistance of a section cracked in flexure V_{cr} may be calculated using equation 55.

$$V_{cr} = (1 - 0.55 \frac{f_{pe}}{f_{pu}}) v_c b_v d + M_o \frac{V}{M} \quad \text{equation 55}$$

The value of V_{cr} should be taken as not less than $0.1b_v d \sqrt{f_{cu}}$.

The value of V_{cr} calculated using this equation at a particular section may be assumed to be constant for a distance equal to $d/2$, measured in the direction of increasing moment, from that particular section.

For a section cracked in a flexure and with inclined tendons or compression cords, the design shear forces produced should be combined with the external design load effects where these effects are increased.

4.3.8.6 Cases not requiring shear reinforcement

Providing V is less than V_c cases not requiring shear reinforcement are:

- where V is less than $0.5V_c$;
- in members of minor importance;
- where tests carried out in accordance with 2.6.2 have shown that shear reinforcement is not required.

4.3.8.7 Shear reinforcement where V does not exceed $V_c + 0.4 b_v d$

Except for the cases described in 4.3.8.6 links should be provided to satisfy equation 56.

$$\frac{A_{sv}}{s_v} = \frac{0.4b_v}{0.95f_{yv}} \quad \text{equation 56}$$

4.3.8.8 Shear reinforcement where V exceeds $V_c + 0.4 b_v d$

Links should be provided to satisfy equation 57.

$$\frac{A_{sv}}{s_v} = \frac{V - V_c}{0.95f_{yv}d_t} \quad \text{equation 57}$$

4.3.8.9 Arrangement of shear reinforcement

At both corners in the tensile zone, a link should pass round a longitudinal bar, a tendon, or a group of tendons having a diameter not less than the link diameter.

A link should extend as close to the tension and compression faces as possible, with due regard to cover. The links provided at a cross-section should between them enclose all the tendons and additional reinforcement provided at the cross-section and should be adequately anchored (see 3.12.8.6 and 3.12.8.7).

4.3.8.10 Spacing of shear reinforcement

The spacing of links along a member should not exceed $0.75d_t$ or four times the web thickness for flanged members. When V exceeds $1.8V_c$, the maximum spacing should be reduced to $0.5d_t$. The lateral spacing of the individual legs of the links provided at a cross-section should not exceed d_t .

4.3.9 Torsion

Calculations are required when torsional resistance is necessary for equilibrium or when significant torsional stresses may occur. The method adopted for reinforced concrete beams in 2.4 of BS 8110-2:1985 may generally be used.

4.4 Slabs

4.4.1 General

The recommendations given in 4.3 for beams apply also to slabs. The methods of analysis described in 3.5.2 and 3.5.3 may be used for the ultimate limit state but elastic analysis should be used for the serviceability limit states. The design for shear should be in accordance with 4.3.8 except that shear reinforcement need not be provided if V is less than V_c , or where tests carried out in accordance with 2.6.2 have shown that shear steel is not required.

4.4.2 Flat slabs

The analysis and design of flat slabs should be carried out in accordance with appropriate specialist literature.

4.5 Columns

In framed structures where the mean design stress in the concrete section imposed by the tendons is less than 2.0 N/mm^2 , these may be analysed as reinforced columns in accordance with 3.8.

4.6 Tension members

Tensile strength should be based on the design strength ($0.95f_{pu}$) of the prestressing tendons and the strength developed by any additional reinforcement. The additional reinforcement may usually be assumed to be acting at its design stress ($0.95f_y$); in special cases it may be necessary to check the stress in the reinforcement using strain compatibility.

4.7 Prestressing

4.7.1 Maximum initial prestress

The jacking force should not normally exceed 75 % of the characteristic strength of the tendon but may be increased to 80 % provided additional consideration is given to safety and to the load/extension characteristics of the tendon. At transfer, the initial prestress should not normally exceed 70 % of the characteristic strength of the tendon, and in no case should it exceed 75 %.

4.7.2 Deflected tendons in pre-tensioning systems

Consideration should be given, in determining the maximum initial prestress, to the possible influence of the size of the deflector on the strength of the tendons (see 8.7.4.3). Attention should also be paid to the effect of any frictional forces that may occur.

4.8 Loss of prestress, other than friction losses

4.8.1 General

In the calculation of the design forces in tendons at various stages considered in design, allowance should be made for the appropriate losses of prestress resulting from:

- a) relaxation of the tendon steel;
- b) the elastic deformation and subsequent shrinkage and creep of the concrete;
- c) slip or movement of tendons at anchorages during anchoring; and
- d) other causes in special circumstances.

If experimental evidence on performance is not available, account should be taken of the properties of the steel and of the concrete in calculating the losses of prestress, from these causes. For a wide range of structures the simple recommendations given in 4.8.2 to 4.8.6 may be used. However, these recommendations are necessarily general and approximate. A better estimate may often be obtained from experience, particularly with factory-produced units, where both the properties of the materials and of the units themselves are known and checked on a regular basis.

4.8.2 Relaxation of steel

4.8.2.1 General

The long term loss of force in the tendon allowed for in the design is obtained by multiplying the appropriate factor given in Table 4.6 by the 1 000 h relaxation test value (see 4.8.2.2). The initial force should be taken as the value immediately after stressing in the case of pre-tensioning and immediately after transfer in the case of post-tensioning. The relaxation factors given in Table 4.6 include allowances for the effects of strain reductions due to creep and shrinkage of the concrete and, in the case of pre-tensioning, due to the elastic deformation of the concrete at transfer.

Table 4.6 — Relaxation factors

	Wire and strand		Bar
	Relaxation class as defined in BS 5896:1980		
	1	2	
Pre-tensioning	1.5	1.2	—
Post-tensioning	2.0	1.5	2.0

4.8.2.2 The 1 000 h relaxation value

The 1 000 h relaxation value should be taken from the manufacturer's UK Certificate of Approval. The information will normally be available for initial loads of 60 %, 70 % and 80 % of the breaking load and values for intermediate loads may be interpolated. For initial loads of less than 60 % of the breaking load, the 1 000 h relaxation value may be assumed to decrease linearly from the stated value at 60 % to zero at an initial load of 30 % of the breaking load. In the absence of the UK Certificate of Approval the 1 000 h relaxation value should be taken as the maximum value for the appropriate initial load stated in the British Standard for the product, BS 4486 for high tensile (HT) bars and BS 5896 for HT wire and strand.

4.8.2.3 Abnormal relaxation losses

Abnormal relaxation losses may occur in special cases, such as with tendons at high temperatures or when subjected to large lateral loads. Specialist literature should be consulted in these cases.

4.8.3 Elastic deformation of concrete

4.8.3.1 General

Calculation of the immediate loss of force in the tendons due to elastic deformation of the concrete at transfer may be based on the values for the modulus of elasticity of the concrete given in section 7 of BS 8110-2:1985; in the use of these data the concrete strength at transfer should be used instead of f_{cu} , when the actual experimental values of elastic modulus are not available. The modulus of elasticity of the tendons may be obtained from BS 4486 for HT bars and BS 5896 for HT wire and strand. In making these calculations it may usually be assumed that the tendons are located at their centroid.

4.8.3.2 Pre-tensioning

The loss of prestress in the tendons should be calculated on a modular ratio basis using the stress in the adjacent concrete.

4.8.3.3 Post-tensioning

Where tendons are not stressed simultaneously a progressive loss occurs. This should be calculated on the basis of half the product of the modular ratio and the stress in the concrete adjacent to the tendons averaged along their length; alternatively, the loss of prestress may be exactly computed on the basis of the sequence of tensioning.

4.8.4 Shrinkage of concrete

The loss of prestress in the tendons is obtained as the product of the shrinkage per unit length of the concrete and the modulus of elasticity of the tendons (see BS 4486 for HT bars and BS 5896 for HT wire and stand).

The shrinkage strain to be considered depends upon the following:

- a) aggregate used;
- b) original water content;

- c) effective age at transfer;
- d) effective section thickness;
- e) ambient relative humidity.

However, in the absence of experimental evidence, values of 100×10^{-6} for UK outdoor exposure and 300×10^{-6} for indoor exposure may generally be used. For other conditions or in exceptional circumstances, reference should be made to section 7 of BS 8110-2:1985 or other specialist literature.

4.8.5 Creep of concrete

4.8.5.1 General

The loss of prestress in the tendons may be calculated on the assumption that creep is proportional to the stress in the concrete. The loss of prestress is obtained as the product of the creep per unit length of the concrete adjacent to the tendons and the modulus of elasticity of the tendons (see BS 4486 for HT bars and BS 5896 for HT wire and strand). In this calculation it is usually sufficient to consider the tendons as located at their centroid.

4.8.5.2 Specific creep strain

This value (creep per unit length per unit applied stress) may be obtained by dividing an appropriate creep coefficient by the modulus of elasticity of the concrete at transfer (see 4.8.3). The creep coefficient to be considered depends upon the following:

- a) original water content;
- b) effective age at transfer;
- c) effective section thickness;
- d) ambient relative humidity;
- e) ambient temperature.

Values between 1.8 for transfer within 3 days and 1.4 for transfer after 28 days may generally be used for UK outdoor exposure. These values may also be used for the conventional design of class 1 and class 2 members for indoor exposure. The stress in the concrete should be taken as the initial value immediately after transfer. For other conditions or in exceptional circumstances, reference should be made to section 7 of BS 8110-2:1985 or other specialist literature.

4.8.6 Draw-in during anchorage

In post-tensioning systems allowance should be made for any movement of the tendon at the anchorage when the prestressing force is transferred from the tensioning equipment to the anchorage. The loss due to this movement is particularly important in short members, and the allowance made in design should be checked on site.

4.9 Loss of prestress due to friction

4.9.1 General

In post-tensioning systems there will be movement of the greater part of the tendon relative to the surrounding duct during the tensioning operation. If the tendon is in contact with either the duct or any spacers provided, friction will cause a reduction in the prestressing force as the distance from the jack increases. In addition, a certain amount of friction will be developed in the jack itself and in the anchorage through which the tendon passes.

In the absence of satisfactory evidence the stress variation likely to be expected along the design profile should be assessed in accordance with 4.9.2 to 4.9.5, in order to obtain the prestressing force at the critical sections considered in design. The extension of the tendon should be calculated allowing for the variation in tension along its length.

4.9.2 Friction in jack and anchorage

Friction in jack and anchorage varies considerably and should be determined by calibration for the actual jack and the type of anchorage to be used.

4.9.3 Friction in the duct due to unintentional variation from the specified profile

4.9.3.1 General

Whether the desired duct profile is straight or curved or a combination of both, there will be slight variations in the actual line of the duct, which may cause additional points of contact between the tendon and the sides of the duct, and so produce friction.

4.9.3.2 Calculation of force

The prestressing force P_x at any distance x from the jack may be calculated from the following equation:

$$P_x = P_o e^{-Kx} \quad \text{equation 58}$$

where

- P_o is the prestressing force in the tendon at the jacking end;
- e is the base of Napierian logarithms (2.718);
- K is the coefficient depending on the type of duct or sheath employed, the nature of its inside surface, the method of forming it and the degree of vibration employed in placing the concrete (see 4.9.3.3).

4.9.3.3 Profile coefficient

The value of K per metre length in 4.9.3.2 should generally be taken as not less than 33×10^{-4} but where strong rigid sheaths or duct formers are used, closely supported so that they are not displaced during the concreting operation, the value of K may be taken as 17×10^{-4} , and for greased strands running in plastic sleeves the value of K may be taken as 25×10^{-4} . Other values may be used provided they have been established by suitable tests.

4.9.4 Friction due to curvature of tendons

4.9.4.1 General

In this case the loss of tension due to friction is dependent on the angle turned through and the coefficient of friction, μ , between the tendon and its supports.

4.9.4.2 Calculation of force

The prestressing force P_x at any distance x along the curve from the tangent point may be calculated from the following equation:

$$P_x = P_o e^{-\mu x / r_{ps}} \quad \text{equation 59}$$

where

- P_o is the prestressing force in the tendons at the tangent point near the jacking end;
- μ is the coefficient of friction;
- r_{ps} is the radius of curvature;
- e is as defined in 4.9.3.2.

The value of μ depends upon the type and the surface condition of the tendon and the duct, and so is subject to wide variations (see 4.9.4.3).

4.9.4.3 Coefficient of friction

Typical values of μ to be used in equation 59 are as follows, and may be used in the absence of more exact information. Heavy rusting of either the tendon or the duct will give rise to higher values.

- Lightly-rusted strand running on unlined concrete duct: 0.55.
- Lightly-rusted strand running on lightly-rusted steel duct: 0.30.
- Lightly-rusted strand running on galvanized duct: 0.25.
- Bright strand running on galvanized duct: 0.20.
- Greased strand running on plastic sleeve: 0.12.

The value of μ may be reduced where special precautions are taken and where results are available to justify the value assumed; for example, a value of $\mu = 0.10$ has been observed for strand moving on rigid steel spacers coated with molybdenum disulfide (see also 4.9.5).

4.9.5 Lubricants

If of satisfactory formulation, lubricants may be used to ease the movement of tendons in the ducts. Lower values for μ than those given in 4.9.4.3 may then be used subject to their being determined by trial. The criteria of 8.3 should then be satisfied if the tendons are subsequently to be bonded into the structure.

4.10 Transmission lengths in pre-tensioned members

4.10.1 General

The transmission length is defined as the length of the member required to transmit the initial prestressing force in a tendon to the concrete.

4.10.2 Factors affecting the transmission length

The most important of these factors are:

- a) the degree of compaction of the concrete;
- b) the size and type of tendon;
- c) the strength of the concrete;
- d) the deformation and surface condition of the tendon.

The transmission length can vary a great deal for different factor or site conditions; for example, it has been shown that the transmission length for wire can vary between 50 and 160 diameters. As far as possible, therefore, the transmission length assumed should be based on experimental evidence for known site or factory conditions.

Where tendons are prevented from bonding to the concrete near the ends of the units by the use of sleeves or tape, the transmission lengths should be taken from the ends of the de-bonded portions.

The transmission lengths for tendons near the top of units may well be greater than those for identical tendons placed lower in the unit since the concrete near the top is less likely to be as well compacted.

The sudden release of tendons leads to a considerable increase in the transmission lengths near the release position.

4.10.3 Assessment of transmission length

For calculating the transmission length l_t in the absence of experimental evidence, the following equation may be used for initial prestressing forces up to 75 % of the characteristic strength of the tendon when the ends of the units are fully compacted:

$$l_t = \frac{K_t \varphi}{\sqrt{f_{ci}}} \quad \text{equation 60}$$

where

- f_{ci} is the concrete strength at transfer,
- φ is the nominal diameter of the tendon;
- K_t is a coefficient for the type of tendon and is selected from the following:
- a) plain or indented wire (including crimped wire with a small wave height): $K_t = 600$;
 - b) crimped wire with a total wave height not less than 0.15φ : $K_t = 400$;
 - c) 7-wire standard or super strand: $K_t = 240$;
 - d) 7-wire drawn strand: $K_t = 360$.

4.11 End blocks in post-tensioned members

4.11.1 General

In the design of end blocks, consideration should be given to:

- a) bursting forces around individual anchorages (see 4.11.2 and 4.11.3);

- b) overall equilibrium of the end block;
- c) spalling of the concrete from the loaded face around anchorages.

NOTE Information on items b) and c) is given in specialist literature.

4.11.2 Serviceability limit state

At the SLS the design bursting tensile force F_{bst} in an individual square end block loaded by a symmetrically-placed square bearing plate, may be derived from Table 4.7 on the basis of the tendon jacking load. With rectangular anchorages and/or rectangular end blocks, the bursting tensile forces in the two principal directions should be assessed in relation to the value of y_{po}/y_o for each direction where

- y_o is half the side of the end block;
- y_{po} is half the side of the loaded area;
- P_o is the tendon jacking force.

Circular bearing plates should be treated as square plates of equivalent area.

**Table 4.7 — Design bursting tensile forces
in end blocks**

y_{po}/y_o	0.2	0.3	0.4	0.5	0.6	0.7
F_{bst}/P_o	0.23	0.23	0.20	0.17	0.14	0.11

NOTE Intermediate values may be interpolated.

This force, F_{bst} , will be distributed in a region extending from $0.2y_o$ to $2y_o$ from the loaded face, and should be resisted by reinforcement in the form of spirals or closed links, uniformly distributed throughout this region, and acting at a stress of 200 N/mm^2 .

When a large block contains several anchorages it should be divided into a series of symmetrically-loaded prisms and each prism treated in the above manner. However, additional reinforcement will be required around the groups of anchorages to ensure overall equilibrium of the end block.

Special attention should also be paid to end blocks having a cross-section different in shape from that of the general cross-section of the beam.

4.11.3 Ultimate limit state

For members with unbonded tendons the design bursting tensile force, F_{bst} , should be assessed from Table 4.7 on the basis of the characteristic tendon force; the reinforcement provided to sustain this force may be assumed to be acting at its design strength ($0.95f_y$). No such check is necessary in the case of members with bonded tendons.

4.12 Considerations affecting design details

4.12.1 General

The considerations in 4.12.2 to 4.12.8 are intended to supplement those for reinforced concrete given in 3.12.

4.12.2 Limitations on area of prestressing tendons

The size and number of prestressing tendons should be such that cracking of the concrete would precede failure of the beam.

This requirement may be considered to be satisfied if the ultimate moment of resistance (see 4.3.7) exceeds the moment necessary to produce a flexural tensile stress in the concrete at the extreme tension fibres equal to $0.6\sqrt{f_{cu}}$. In this calculation the prestress in the concrete may be taken as the value after all losses have occurred.

4.12.3 Cover to prestressing tendons

4.12.3.1 Bonded tendons

4.12.3.1.1 General

The cover to bonded tendons should conform to the relevant recommendations of 3.3 together with those of 4.12.3.1.2 for protection of the steel against corrosion and of 4.12.3.1.3 for protection of steel against fire.

The ends of individual pre-tensioned tendons do not normally require concrete cover and should preferably be cut off flush with the end of the concrete member.

4.12.3.1.2 Cover against corrosion

The exposure conditions for the structural element should be assessed in accordance with 3.3.4 and the required nominal cover, grade and associated mix limitations obtained from Table 4.8. The recommendations of 2.4.7, 3.3.5.1 and 3.5.5.2 for concrete materials and mixes also apply to Table 4.8 except that the minimum cement content should not be reduced below 300 kg/m³.

4.12.3.1.3 Cover as fire protection

The general recommendations for protection against fire given in 3.3.6 also apply to prestressed concrete except that the values of cover for various structural elements should be taken from Table 4.9. Section 4 of BS 8110-2:1985 gives further information on design for fire including information on surface treatments for improving fire resistance.

4.12.3.2 Tendons in ducts

The cover to any duct should be not less than 50 mm. Precautions should be taken to ensure a dense concrete cover, particularly with large or wide ducts.

4.12.3.3 External tendons

Where external tendons are to be protected by dense concrete of at least grade C40, added subsequently, the thickness of this cover should not be less than that required for tendons inside the structural concrete under similar conditions. The concrete cover should be anchored by reinforcement to the prestressed member and should be checked for crack control in accordance with section 3.

4.12.3.4 Curved tendons

For cover to curved tendons, see 4.12.5.2.

Table 4.8 — Nominal cover to all steel (including links) to meet durability requirements
(see NOTES 1, 2 and 3)

Conditions of exposure (see 3.3.4)	Nominal cover			
	mm			
Mild	20	20 ^a	20 ^a	20 ^a
Moderate	35	30	25	20
Severe	—	40	30	25
Very severe	—	50 ^b	40 ^b	30
Most severe	—	—	—	50
Abrasive	—	—	See NOTE 3	See NOTE 3
Maximum free water/cement ratio	0.60	0.55	0.50	0.45
Minimum cement content (kg/m ³)	300	325	350	400
Lowest grade of concrete	C35	C40	C45	C50

NOTE 1 This table relates to normal-weight aggregate of 20 mm nominal maximum size. Adjustments to minimum cement contents for aggregates other than 20 mm nominal maximum size are detailed in Table 8 of BS 5328-1:1997.

NOTE 2 Use of cement conforming to BS 4027 is assumed. These cements have lower resistance to chloride ion migration. If they are used in reinforced concrete in very severe or most severe exposure conditions, the covers in Table 4.8 should be increased by 10 mm.

NOTE 3 Cover should be not less than the nominal value corresponding to the relevant environmental category plus any allowance for loss of cover due to abrasion.

^a These covers may be reduced to 15 mm provided that the nominal maximum size of aggregate does not exceed 15 mm.

^b Where concrete is subject to freezing whilst wet, air-entrainment should be used (see 5.3.3 of BS 5328-1:1997) and the strength grade may be reduced by 5.

Table 4.9 — Nominal cover to all steel to meet specified periods of fire resistance
(see NOTES 1 and 2)

Fire resistance	Nominal cover mm					
	Beams ^a		Floors		Ribs	
	Simply supported	Continuous	Simply supported	Continuous	Simply supported	Continuous
0.5	20 ^b	20 ^b	20	20	20	20
1	20	20 ^b	25	20	35	20
1.5	35	20	30	25	45	35
2	60	35	40	35	55	45
3	70	60	55	45	65	55
4	80	70	65	55	75	65

NOTE 1 The nominal covers given relate specifically to the minimum member dimensions given in Figure 3.2. Guidance on increased covers necessary if smaller members are used is given in section 4 of BS 8110-2:1985.

NOTE 2 Cases that lie below the line require attention to the additional measures necessary to reduce the risks of spalling (see section 4 of BS 8110-2:1985).

^a For the purposes of assessing a nominal cover for beams, the cover to main bars which would have been obtained from Table 4.3 of BS 8110-2:1985 have been reduced by a notional allowance for stirrups of 10 mm to cover the range 8 mm to 12 mm (see also 3.3.6).

^b These covers may be reduced to 15 mm provided that the nominal maximum size of aggregate does not exceed 15 mm.

4.12.4 Spacing of prestressing tendons

4.12.4.1 General

In all prestressed members, there should be sufficient gaps between the tendons or groups of tendons to allow the largest size of aggregate used to move, under vibration, to all parts of the mould.

4.12.4.2 Bonded tendons

The recommendations of 3.12.11 concerning minimum spacing of reinforcement apply. In pre-tensioned members, where anchorage is achieved by bond, the spacing of the wires or strands in the ends of the members should be such as to allow the transmission lengths given in 4.10 to be developed. In addition, if the tendons are positioned in two or more widely spaced groups, the possibility of longitudinal splitting of the member should be considered.

4.12.4.3 Tendons in ducts

The clear distance between ducts or between ducts and other tendons should not be less than the following, whichever is the greatest:

- $h_{agg} + 5$ mm, where h_{agg} is the nominal maximum size of the coarse aggregate (in mm);
- in the vertical direction, the vertical internal dimension of the duct;
- in the horizontal direction, the horizontal internal dimension of the duct; where internal vibrators are used sufficient space should be provided between ducts to enable the vibrator to be inserted.

Where two or more rows of ducts are used, the horizontal gaps between the ducts should be vertically in line wherever possible, for ease of construction.

4.12.4.4 Curved tendons

For spacing to curved tendons, see 4.12.5.3.

4.12.5 Curved tendons

4.12.5.1 General

Where these are used in post-tensioning, the positioning of the tendon ducts and the sequence of tensioning should be such as to prevent:

- bursting of the side cover perpendicular to the plane of curvature of the ducts;
- bursting of the cover in the plane of curvature of the ducts;

c) crushing of the concrete separating ducts in the same plane of curvature.

Pending the availability of further research data the recommendations in 4.12.5.2 and 4.12.5.3 may be applied.

4.12.5.2 Cover

In order to prevent bursting of the cover perpendicular to the plane of curvature, and in the plane of curvature, e.g. where the curved tendons run close to and approximately parallel to the surface of a member, the cover should be in accordance with the values given in Table 4.10.

In the latter case, if the tendon develops radial forces perpendicular to the exposed surface of the concrete, the duct should be restrained by stirrup reinforcement anchored into the members.

4.12.5.3 Spacing

In order to prevent crushing of the concrete between ducts minimum spacing should be as follows:

- a) in the plane of curvature: the distance given in Table 4.11 or the distance given in 4.12.4.3, whichever is the greater.
- b) perpendicular to the plane of curvature: the distance given in 4.12.4.3.

4.12.5.4 Special measures to reduce spacing of ducts

Exceptionally it may be possible to tension and grout first the tendon having the least radius of curvature, and to allow an interval of 48 h to elapse before tensioning the next tendon. In this case the recommendations for spacing given in 4.12.4.3 apply.

4.12.6 Longitudinal reinforcement in prestressed concrete beams

Reinforcement may be used in prestressed concrete members either to increase the strength of sections or to conform to 4.3.8.9.

Any calculation taking account of additional reinforcement should still be in accordance with 4.3.4.1 and 4.3.7.1.

Reinforcement may be necessary, particularly where post-tensioning systems are used, to control any cracking resulting from restraint to longitudinal shrinkage of members provided by the formwork during the time before the prestress is applied.

4.12.7 Links in prestressed concrete beams

The amount and disposition of links in rectangular beams and in the webs of flanged beams will normally be governed by considerations of shear (see 4.3.8).

Links to resist the bursting tensile forces in the end zones of post-tensioned members should be provided in accordance with 4.11

Where links are required in the transmission length of pre-tensioned members, they should be provided in accordance with 4.3.8, using the information given in 4.10.

4.12.8 Shock loading

When a prestressed concrete beam may be required to resist shock loading, it should be reinforced with closed links and longitudinal reinforcement preferably of mild steel. Other methods of design and detailing may be used, provided it can be shown that the beam can develop the required ductibility.

Table 4.10 — Minimum cover to curved ducts

Radius of curvature of duct m	Duct internal diameter mm															
	19	30	40	50	60	70	80	90	100	110	120	130	140	150	160	170
	Tendon force kn															
	296	387	960	1 337	1 920	2 640	3 360	4 320	5 183	6 019	7 200	8 640	9 424	10 388	11 248	13 200
	mm	mm	mm	mm	mm	mm	mm	mm	mm	mm	mm	mm	mm	mm	mm	mm
2	50	55	155	220	320	445										
4		50	70	100	145	205	265	350	420							
6			50	65	90	125	165	220	265	310	375	460				
8				55	75	95	115	150	185	220	270	330	360	395		
10				50	65	85	100	120	140	165	205	250	275	300	330	
12					60	75	90	110	125	145	165	200	215	240	260	315
14					55	70	85	100	115	130	150	170	185	200	215	260
16					55	65	80	95	110	125	140	160	175	190	205	225
18					50	65	75	90	105	115	135	150	165	180	190	215
20						60	70	85	100	110	125	145	155	170	180	205
22							55	70	80	95	105	120	140	150	160	175
24							55	65	80	90	100	115	130	145	155	165
26							50	65	75	85	100	110	125	135	150	160
28								60	75	85	95	105	120	130	145	155
30								60	70	80	90	105	120	130	140	150
32									55	70	80	90	100	115	125	135
34									55	65	75	85	100	110	120	130
36									55	65	75	85	95	100	115	125
38									50	60	70	80	90	105	115	125
40									50	60	70	80	90	100	110	120

NOTE 1 The tendon force shown is the maximum normally available for the given size of duct (taken as 80 % of the characteristic strength of the tendon).

NOTE 2 Where tendon profilers or spacers are provided in the ducts, and these are of a type which will concentrate the radial force, the values given in the table will need to be increased.

NOTE 3 The cover for a given combination of duct internal diameter and radius of curvature shown in the table, may be reduced in proportion to the square root of the tendon force when this is less than the value tabulated, subject to the recommendations of 4.12.3.2 and 4.12.3.3.

Table 4.11 — Minimum distance between centre-lines of ducts in plane of curvature

Radius of curvature of duct m	Duct internal diameter mm																
	19	30	40	50	60	70	80	90	100	110	120	130	140	150	160	170	
	Tendon force kn																
	296	387	960	1 337	1 920	2 640	3 360	4 320	5 183	6 019	7 200	8 640	9 424	10 388	11 248	13 200	
	mm	mm	mm	mm	mm	mm	mm	mm	mm	mm	mm	mm	mm	mm	mm	mm	
2	110	140	350	485	700	960											Radii not normally used
4	55	70	175	245	350	480	610	785	940								
6	38	60	120	165	235	320	410	525	630	730	870	1 045					
8			90	125	175	240	305	395	470	545	655	785	855	940			
10			80	100	140	195	245	315	375	440	525	630	685	750	815		
12						160	205	265	315	365	435	525	570	625	680	800	
14						140	175	225	270	315	375	450	490	535	585	785	
16							160	195	235	275	330	395	430	470	510	600	
18								180	210	245	290	350	380	420	455	535	
20									200	220	265	315	345	375	410	480	
22											240	285	310	340	370	435	
24												265	285	315	340	400	
26												260	280	300	320	370	
28																345	
30																340	
32																	
34																	
36																	
38																	
40	38	60	80	100	120	140	160	180	200	220	240	260	280	300	320	340	

NOTE 1 The tendon force shown is the maximum normally available for the given size of duct (taken as 80 % of the characteristic strength of the tendon).

NOTE 2 Values less than two times the duct internal diameter are not included.

NOTE 3 Where tendon profilers or spacers are provided in the ducts, and these are of a type which will concentrate the radial force, the values given in the table will need to be increased. If necessary reinforcement should be provided between ducts.

NOTE 4 The distance for a given combination of duct internal diameter and radius of curvature shown in the table may be reduced in proportion to the tendon force when this is less than the value tabulated, subject to the recommendations of 4.12.4.3.

Section 5. Design and detailing: precast and composite construction

5.1 Design basis and stability provisions

5.1.1 General

This section deals with the design and detailing considerations special to structures partly or wholly of precast construction.

5.1.2 Basis of design

The limit state philosophy set out in section 2 applies equally to precast and in situ construction. In general, therefore, the recommended methods of design and detailing for reinforced concrete given in 3.1 and those for prestressed concrete given in 4.1 apply also to precast and composite construction. Those sub-clauses in 3.1 and 4.1 that do not apply are either specifically worded for in situ construction or are modified by this section.

5.1.3 Handling stresses

Precast units should be designed to resist without permanent damage all stresses induced by handling, storage, transport and erection (see also 4.3.2 and 6.2.11).

5.1.4 Compatibility

The design of connections is of fundamental importance in precast construction and should be carefully considered. Especially when responsibilities for design and details are divided, checks to ensure compatibility should be made.

5.1.5 Anchorage at supports

Where reinforcement is being used to provide the structural integrity of beam or slab ends on corbels or nibs, it should be very carefully overlapped and anchored (see 5.2.7.2.2 and 5.2.8.3). Full regard should be paid to constructional tolerances.

5.1.6 Joints for movement

Allowance for movements due to shrinkage, thermal effects and possible differential settlement of foundations is of as great importance in precast as in in situ construction. The number and spacing of joints should be determined at an early stage in the design (see section 8 of BS 8110-2:1985).

5.1.7 Stability

There should be a single responsibility for the stability of a structure which may be separate from the responsibility for design and details of parts or elements.

The recommendations regarding robustness given in 2.6 of BS 8110-2:1985 and in 2.2 of this standard apply also to precast and composite construction.

5.1.8 Provision of ties

NOTE These sub-clauses should be read in conjunction with 3.1.4 and 3.12.3.

5.1.8.1 Ties generally

Ties may be provided wholly within in situ concrete toppings or connections partly within in situ concrete and partly within precast members or wholly within precast members but they should be effectively continuous.

5.1.8.2 Continuity of ties

A tie may be considered effectively continuous if it satisfies 5.3.4 and the minimum dimension of any in situ concrete section in which tie bars are provided is not less than the sum of the bar size (or twice the bar size at laps) plus twice the maximum aggregate size plus 10 mm.

The tie should also satisfy one of the following conditions.

- a) A bar or tendon in a precast member lapped with a bar in in situ connecting concrete bounded on two opposite sides by rough faces of the same precast member (see Figure 5.1).
- b) A bar or tendon in a precast concrete member lapped with a bar in in situ topping or connecting concrete anchored to the precast member by enclosing links. The ultimate tensile resistance of the links should be not less than the ultimate tension in the tie (see Figure 5.2).
- c) Bars projecting from the ends of precast members joined by any method conforming to 5.3.4.

d) Bars lapped within in situ topping or connecting concrete to form a continuous reinforcement with projecting links from the support of the precast floor or roof members to anchor such support to the topping or connecting concrete (see Figure 5.3).

5.1.8.3 Anchorage of floor and roof members

In buildings of five or more storeys where precast floor or roof members are not used to provide the ties required by 3.12.3, they should nevertheless be effectively anchored, such anchorage being capable of carrying the dead weight of the member, to that part of the structure which contains the ties.

5.1.8.4 Avoidance of eccentricity

Ties connecting floor and roof members should be so arranged as to minimize out-of-balance effects.

5.1.9 Durability

Durability should be considered in the design and detailing of connections.

5.2 Precast concrete construction

5.2.1 Framed structures and continuous beams

When the continuity of reinforcement or tendons through the connections and/or the interaction between members is such that the structure will behave as a frame or as a continuous beam, the analysis, redistribution of moments and the design and detailing of individual members may all be in accordance with sections 3 or 4, as appropriate.

5.2.2 Slabs

5.2.2.1 Design of slabs

Slabs consisting of wide precast units or of a series of narrow precast units with effective jointing between them capable of shear transfer may be designed in accordance with 3.5 or 4.4.1 as appropriate.

5.2.2.2 Concentrated loads on slabs without reinforced topping

The width of slab assumed to contribute to the support of concentrated loads (including partitions in the direction of the span) should not exceed the width of three precast units and joints plus the width of the loaded area or extend more than a quarter of the span on either side of the loaded area. In some forms of construction, e.g. long span wide units, these limits may be inappropriate and more detailed considerations may be made.

5.2.2.3 Concentrated loads on slabs with reinforced topping

The provisions of 5.2.2.2 apply in all respects except that, instead of three, the width of four precast units and joints may be allowed to contribute.

5.2.2.4 Slabs carrying concentrated loads

Where test results justify the assumption of a wider effective area than allowed by 5.2.2.2 or 5.2.2.3, this is acceptable subject to the overriding limit of one-quarter of the span on either side of the loaded area.

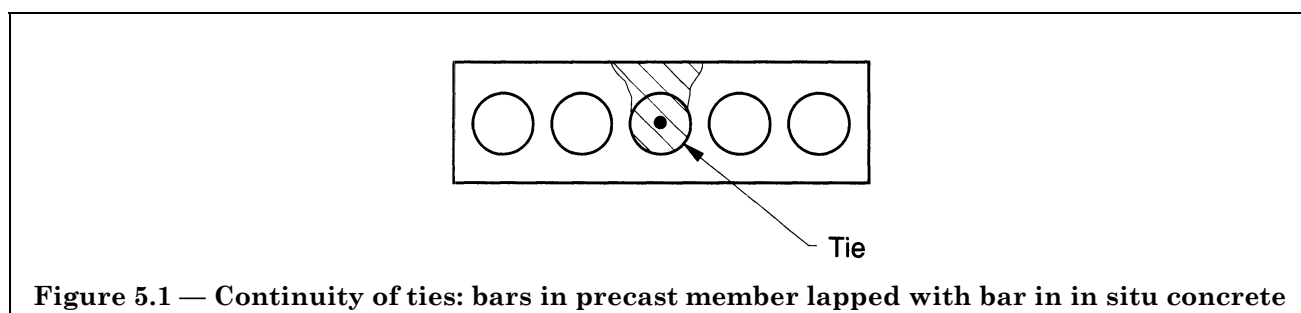

Figure 5.1 — Continuity of ties: bars in precast member lapped with bar in in situ concrete

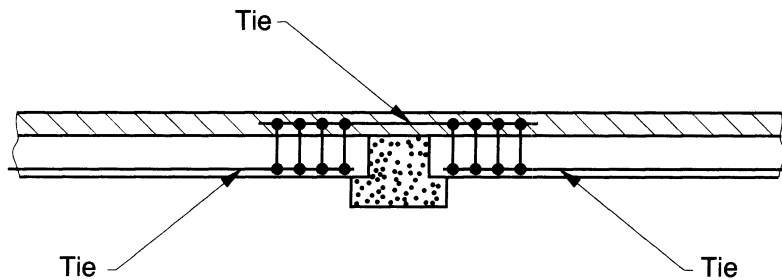

Figure 5.2 — Continuity of ties: anchorage by enclosing links

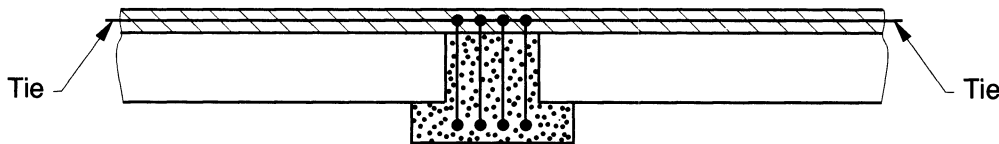

Figure 5.3 — Continuity of ties: bars lapped within in situ concrete

5.2.3 Bearings for precast members

NOTE For definitions specific to bearings for precast members, see 1.3.5.

5.2.3.1 General

It is important to recognize that the integrity of a bearing is dependent upon two essential safeguards:

- a) an overlap of reinforcement in reinforced bearings;
- b) a restraint against loss of bearing through movement.

This sub-clause treats the design of bearings in a step-by-step way in which allowances for various effects are added to a basic net bearing width. When both supporting and supported members are reinforced, the method ensures a reasonable minimum overlap of reinforcement at the bearing.

5.2.3.2 Calculation of net bearing width of non-isolated members

The net bearing width should be 40 mm or the value calculated from the equation:

$$\frac{(\text{design ultimate support reaction per member})}{(\text{effective bearing length} \times \text{design ultimate bearing stress})}$$

whichever is the greater. (See 5.2.3.3 for the determination of the effective bearing length and 5.2.3.4 for the design ultimate bearing stress).

Where a member is free to move relative to a support, the net bearing width should be increased to allow for any likely movement. Where a member is tied to a support and the tie is provided away from the level of the support, the net bearing width should be increased to allow for any loss of bearing that could arise through rotation of the support about the tie.

5.2.3.3 Effective bearing length

In the equation given in 5.2.3.2 the effective bearing length is the least of:

- a) bearing length per member;
- b) one-half of bearing length per member plus 100 mm;
- c) 600 mm.

5.2.3.4 Design ultimate bearing stress

The design ultimate bearing stress is based on the weaker of the bearing surfaces and has the following value:

- a) for dry bearing on concrete: $0.4f_{cu}$;
- b) for bedded bearing on concrete: $0.6f_{cu}$;

c) for contact face of a steel bearing plate cast into a member or support with each dimension not exceeding 40 % of the corresponding concrete dimension: $0.8f_{cu}$.

Bearings using flexible padding may be designed using stresses intermediate between those for dry and for bedded bearings.

NOTE 1 These values include an allowance for γ_m .

NOTE 2 Values for masonry are given in BS 5628.

5.2.3.5 Net bearing width of isolated members

The net bearing width of isolated members should be 20 mm greater than for non-isolated members.

5.2.3.6 Detailing for simple bearing

The nominal bearing width selected should make allowance for spalling and constructional inaccuracies over and above the net bearing width calculated in accordance with 5.2.3.2. The minimum anchorage lengths of reinforcement required by 3.12.8 and 3.12.9 should be provided and the effects of accidental displacement of a supported member during erection should be considered.

5.2.3.7 Allowances for effects of spalling at supports

5.2.3.7.1 Outer edges are subject to spalling. Sub-clauses 5.2.3.7.2 to 5.2.3.7.4 give recommendations for the distances to be assumed ineffective as bearing surfaces. Chamfers occurring within areas subject to spalling may be discounted when determining the outer edge of a support or the end of a supported member.

5.2.3.7.2 The distance to be assumed ineffective, measured from the outer edge of a support, is as given in Table 5.1.

5.2.3.7.3 The distance to be assumed ineffective, measured from the end of a supported member, is as given in Table 5.2.

5.2.3.7.4 If steel packs are used in erection, they should be kept clear of the areas that are assumed to be subject to spalling. To reduce the incidence of spalling, contact may be avoided in those areas by the use of chamfers or controlled joint packing.

5.2.4 Allowance for construction inaccuracies

The allowance for construction inaccuracies should cover deviations in setting out, site construction, manufacture and erection and it may be assessed from a statistical analysis of measured or predicted deviation. Alternatively, for supported members up to 15 m span and with average standards of accuracy, the allowance may be taken as the greater of:

- a) 15 mm, or 3 mm per metre distance between the faces of steel or precast concrete supports;
- b) 20 mm, or 4 mm per metre distance between the faces of masonry supports;
- c) 25 mm, or 5 mm per metre distance between the faces of in situ concrete supports.

5.2.5 Bearings transmitting compressive forces from above

Where a bearing is required to transmit load from above from a column or wall extending over the end of a supported member, a bedded bearing should be used.

For buildings of up to four storeys of masonry construction where the compressive forces are low, dry bearings may be used.

Guidance on compressive forces between precast members is given in 5.3.6.

5.2.6 Other forces at bearings

5.2.6.1 Horizontal forces at bearing

Horizontal forces at bearing can reduce the load-carrying capacity of the supporting member considerably by causing premature splitting or shearing. The forces may be due to creep, shrinkage and temperature effects or may result from misalignment, lack of plumb or other causes. When likely to be significant, allowances should be made for these forces in designing and detailing the connection by the provision of:

- a) sliding bearings; or
- b) suitable lateral reinforcement in the top of the supporting member; or
- c) continuity reinforcement to tie together the ends of the supported members.

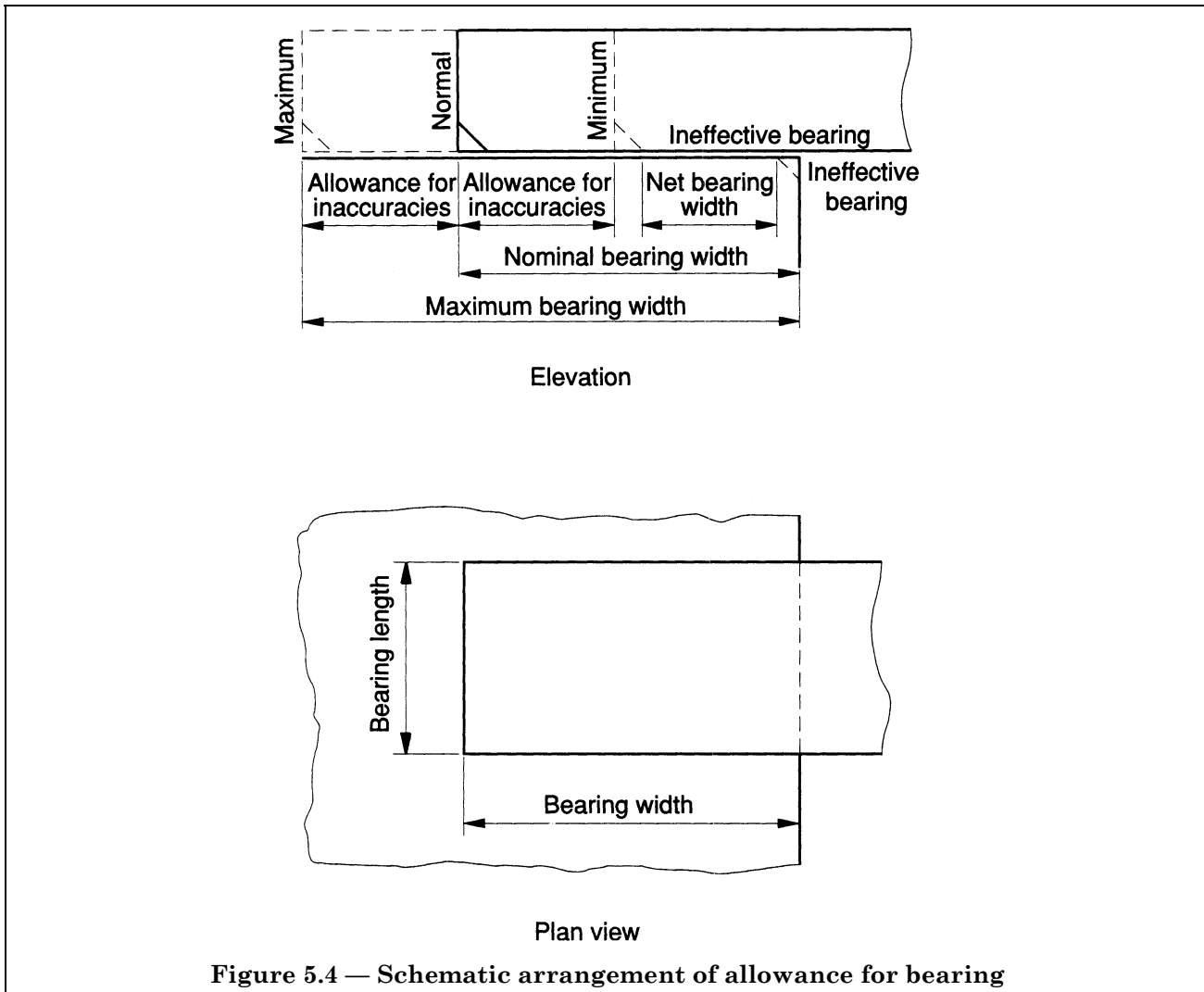

Figure 5.4 — Schematic arrangement of allowance for bearing

Table 5.1 — Allowances for effects of spalling at supports

Material of support	Distance assumed ineffective mm
Steel	0
Concrete grade 30 or over, plain or reinforced (in general) ^a	15
Brickwork or masonry ^a	25
Concrete below grade 30, plain or reinforced (in general) ^a	25
Reinforced concrete less than 300 mm deep at outer edge	Not less than nominal cover to reinforcement on outer face of support
Reinforced concrete less than 300 mm deep at the outer edge where vertical loop reinforcement exceeds 12 mm diameter	Nominal cover plus inner radius of bend

^a Where unusual spalling characteristics are known to apply when particular constituent materials are being used, adjustment should be made to the distance recommended.

Table 5.2 — Allowances for effects of spalling at supported members

Reinforcement at bearing of supported member	Distance assumed ineffective mm
Straight bars, horizontal loops or vertical loops not exceeding 12 mm in diameter, close to end of member	10 or end cover, whichever is the greater
Tendons or straight bars exposed at end of member	0
Vertical loop reinforcement of bar size exceeding 12 mm	End cover plus inner radius of bend of bars

5.2.6.2 Rotation at bearing of flexural members

Where large rotations are likely to occur at the end supports of flexural members, suitable bearings capable of accommodating these rotations should be used. The rotations may also throw the line of action of loads on to the extreme edges of bearings; in such cases allowance should be made for consequential increases in bending moments or local bearing stresses.

5.2.7 Concrete corbels**5.2.7.1 General**

A corbel is a short cantilever projection which supports a load-bearing member and where:

- the distance a_v between the line of the reaction to the supported load and the root of the corbel is less than d (the effective depth of the root of the corbel); and
- the depth at the outer edge of the contact area of the supported load is not less than one-half of the depth at the root of the corbel.

The depth of the corbel at the face of the support is determined from shear conditions in accordance with 3.4.5.8 but using the modified definition of a_v given in a).

5.2.7.2 Design**5.2.7.2.1 Simplifying assumptions**

The concrete and reinforcement may be assumed to act as elements of a simple strut-and-tie system, with the following guidelines.

- The corbel should be designed at the ultimate limit state using the appropriate partial safety factors on the reinforcement and concrete, but the magnitude of the resistance provided to horizontal force should be not less than one-half of the design vertical load on the corbel (see also 5.2.7.2.4).
- Compatibility of strains between the strut-and-tie at the corbel root should be ensured.

It should be noted that the horizontal link requirement described in 5.2.7.2.3 will ensure satisfactory serviceability performance.

5.2.7.2.2 Reinforcement anchorage

At the front face of the corbel, the reinforcement should be anchored either by:

- welding to a transverse bar of equal strength; in this case the bearing area of the load should stop short of the transverse bar by a distance equal to the cover of the tie reinforcement; or
- by bending back the bars to form a loop; in this case the bearing area of the load should not project beyond the straight portion of the bars forming the main tension reinforcement.

5.2.7.2.3 Shear reinforcement

Shear reinforcement should be provided in the form of horizontal links distributed in the upper two-thirds of the effective depth of root of the corbel; this reinforcement should be not less than one-half of the area of the main tension reinforcement and should be adequately anchored.

5.2.7.2.4 Resistance to applied horizontal force

Additional reinforcement connected to the supported member in accordance with 5.3 should be provided to transmit this force in its entirety.

5.2.8 Continuous concrete nibs

5.2.8.1 General

Where a continuous nib is less than 300 mm deep, it should normally be designed as a short cantilever slab, where:

- a) the line of action of design load is assumed to occur at the outer edge of the loaded area, e.g. at the front edge of a nib without a chamfer, at the upper edge of a chamfer or at outer edge of a bearing pad; and
- b) the maximum design ultimate bending moment is the distance from the line of action of the load to the nearest vertical leg of the links in the beam member from which the nib projects times the load (see 5.2.8.5).

5.2.8.2 Area of tension reinforcement

The area of tension reinforcement should be not less than that given in 3.12.5.

5.2.8.3 Position of tension reinforcement

The position of tension reinforcement should project from the supporting member across the top of the nib to a point as near to the front face of the nib as considerations of adequate cover will allow. It should be anchored in this position either by welding to a transverse bar of equal strength or by bending the bars through 180° to form loops in the horizontal or vertical plane. Vertical loops should be of bar size not greater than 12 mm.

5.2.8.4 Design shear resistance

The design shear resistance should be checked in accordance with 3.5.6 except that the values of v_c given in Table 3.8 may be multiplied by $2d/a_v$, where a_v is taken as the distance described in 5.2.8.1 b).

5.2.8.5 Links in the member from which the nib projects

Links should be provided which, in addition to any other forces they may be required to resist, are capable of transmitting the load from the nib to the compression zone of the member.

5.3 Structural connections between precast units

5.3.1 General

The overall stability of the building, including its stability during construction or after accidental damage, should be considered and the recommendations of section 3 of this standard or section 2 of BS 8110-2:1985 followed. In addition, handling and construction stresses should be considered. When prestressed members are built in to supports, restrained creep effects should be considered.

5.3.2 Design of connection

5.3.2.1 Methods

Where possible these should be those applicable to reinforced concrete, prestressed concrete or structural steel. Where such methods are not applicable, the efficiency of the connection should be checked by appropriate tests in accordance with 2.6.

5.3.2.2 Manufacturing and construction

In the design stage attention should be paid to the following.

- a) Where projecting bars or sections are required, they should be kept to a minimum and made as simple as possible. The lengths of such projections should not be more than necessary for security.
- b) Fragile fins and nibs should be avoided.
- c) Fixing devices should be located in concrete sections of adequate strength.
- d) The practicability of both casting and assembly should be considered.
- e) Most connections require the introduction of suitable jointing material. Sufficient space should be allowed in the design for such material to ensure that the proper filling of the joint is practicable.
- f) It may be desirable that levelling devices, e.g. nuts and wedges, having no load-bearing function in the completed structure should be slackened, released or removed as necessary. Where this is necessary, the details should be such that inspection (to ensure that this has been done) can be carried out without undue difficulty.

5.3.2.3 *Design for protection*

Connections should be designed to maintain the level of protection against weather, fire and corrosion required for the remainder of the structure.

5.3.3 *Instructions to site*

The strength and stiffness of any connection can be significantly affected by workmanship on site. The diversity of joint types and their critical part in the strength and stability of the structure make it particularly important to make clear those details that are essential to the correct operation of the joint. The following points should be considered and specific instructions passed to the site where necessary.

- a) Sequence of forming the joint.
- b) Critical dimensions allowing for permitted deviations, e.g. minimum permissible bearing.
- c) Critical details, e.g. accurate location required for a particular reinforcing bar.
- d) Method of correcting possible lack of fit in the joint.
- e) Details of temporary propping and time when it may be removed (see 6.2.6).
- f) Description of general stability of the structure with details of any necessary temporary bracing.
- g) Extent to which the uncompleted structure may proceed above the completed and matured section.
- h) Details of any special materials.
- i) Fully specified weld sizes. (Where weld symbols as given in BS 499 are used, it should be ascertained that these are understood on site).

5.3.4 *Continuity of reinforcement*

5.3.4.1 *General*

Where continuity is required through the connection, the jointing method used should be such that the assumptions made in analysing the structure and critical sections are realized.

5.3.4.2 *Lapping of bars*

Where straight bars passing through the joint are lapped, the recommendations of 3.12.8 and 5.1.8.2 apply.

5.3.4.3 *Reinforcement grouted into aperture*

An adequate capacity to restrain pull-out should be provided on the inside of the pocket or recess.

5.3.4.4 *Overlapping reinforcement loops*

Where continuity over a support is achieved by having dowel bars passing through overlapping loops of reinforcement, which project from each supported member, the bearing stresses inside the loops should be in accordance with 3.12.8.25.

5.3.4.5 *Sleeving*

Provided their strength and deformation have been determined by tests (see 2.6.2), either of the following types of sleeve jointing may be used:

- a) grouted, resin-filled or swaged sleeve capable of transmitting both tensile and compressive forces;
- b) sleeves that mechanically align the square-sawn ends of two bars to allow the transmission of compressive forces only.

The detailed design of the sleeve and the method of manufacture and assembly should be such as to ensure that the ends of the two bars can be accurately aligned into the sleeve. The concrete cover provided for the sleeve should be not less than that specified for normal reinforcement.

5.3.4.6 *Threading of reinforcement*

Where there is a risk of the threaded connection working loose, e.g. during vibration of in situ concrete, a locking device should be used. Acceptable methods for joining threaded bars include the following.

- a) The threaded ends of bars are jointed by a coupler having left- and right-hand threads. This type of threaded connection requires a high degree of accuracy in manufacture in view of the difficulty of ensuring alignment.
- b) One set of bars is welded to a steel plate drilled to receive the threaded ends of the second set of bars; the second set of bars is fixed to the plate by means of nuts.

- c) Threaded anchors are cast into a precast unit to receive the threaded ends of reinforcement.

5.3.4.7 *Strength of threaded couplings*

The design of threaded couplings should be in accordance with 3.12.8.

5.3.4.8 *Welding of bars*

The design of welded connections may be in accordance with 3.12.8 provided the welding is carried out in accordance with 7.6.

5.3.5 *Connections other than those involving continuity of reinforcement*

5.3.5.1 *Joints with structural steel inserts*

Such joints generally consist of a steel plate or rolled steel section projecting from the face of a column to support the end of a beam. The reinforcement in the ends of the supported member should be designed in accordance with section 3. Detailed design provisions include the following.

- a) The steel sections and any bolted or welded connections should be designed in accordance with the appropriate recommendations.
- b) Design ultimate bearing stresses up to $0.8f_{cu}$ may be used unless higher values can be justified as the result of tests.
- c) Consideration should be given in the design to the possibility of vertical splitting under the steel section as a result of shrinkage effects and localized bearing stresses, e.g. under narrow steel plate.

5.3.5.2 *Resin adhesives*

Resin adhesives may be used to form joints subjected to compression but not to resist tension or shear. They should only be used where they are adequately protected against the effects of fire.

5.3.5.3 *Other types*

Any other type of connection that can be shown to be capable of carrying the ultimate loads acting on it may be used. Amongst those suitable for resisting shear and flexure are those made by prestressing across the joint.

5.3.6 *Joints transmitting mainly compression*

This type of joint is most commonly used for horizontal joints between load-bearing walls or columns. The joint should be designed to resist all the forces and moments implicit in the assumptions made in analysing the structure as a whole and in designing the individual member to be joined. In the absence of more accurate information derived from a comprehensive programme of suitable tests, the area of concrete to be considered in calculating the strength of the joint in a wall or column should be the greater of:

- a) the area of the in situ concrete ignoring the area of any intruding floor or beam units (this area should not be taken as greater than 90 % of the wall or column area); or
- b) 75 % of the area of contact between wall or column and joint.

NOTE Only those parts of the floor beam units that are solid over the bearing should be considered and the units should be properly bedded on concrete or mortar of adequate quality.

Particular attention should be paid to detailing the joint and joint reinforcement to prevent premature splitting or spalling of the concrete in the ends of the precast members.

5.3.7 *Joints transmitting shear*

Joints transmitting shear may occur when a wall acts as a wind-bracing wall or a floor acts as a wind girder. They may be assumed effective if the joint is grouted with a suitable concrete or mortar mix and the appropriate condition is satisfied.

- a) *Units transmitting shear in plane.* These should be restrained to prevent their moving apart. No reinforcement need be provided in or across the joint, and the sides of the units forming the joint may have a normal finish, when the design ultimate shear stress in the joint does not exceed 0.23 N/mm^2 . Very smooth moulded finishes should be roughened.
- b) *Joints under compression in all design conditions.* No reinforcement need be provided when the sides or ends of the panels or units forming the joint have a rough as-cast finish and when the design ultimate shear stress does not exceed 0.45 N/mm^2 .

c) *Shear stress due to ultimate loads less than 1.3 N/mm², calculated on the minimum root area of a castellated joint.* Separation of the units normal to the joints should be prevented by either steel ties across the ends of the joint or by the compressive force normal to the joint under all loading conditions. A taper is usually provided to the projecting keys of a castellated joint to ease the removal of formwork. To limit movements in the joint, this taper should not be excessive.

d) *Reinforcement provided to resist the entire shear force due to design ultimate loads.* In this case the shear force V should not exceed the value given by:

$$V = 0.6F_b \tan \alpha_f \quad \text{equation 61}$$

where

F_b is $0.95f_y A_s$; or the anchorage value of the reinforcement, whichever is the lesser,

A_s is the minimum area of reinforcement;

α_f is the angle of internal friction between the faces of the joint.

NOTE $\tan \alpha_f$ can vary between 0.7 and 1.7 and is best determined by tests. However, for concrete-to-concrete connections, the values used may be taken from Table 5.3.

Table 5.3 — Values of $\tan \alpha_f$ for concrete connections

Type of surface	$\tan \alpha_f$
Smooth interface, as in untreated concrete	0.7
Roughened or castellated joint without continuous in situ strips across the ends of joints	1.4
Roughened or castellated joint with continuous in situ strips across the ends of joints	1.7

e) *Resistance to sliding provided by other means.* Other means of providing resistance to sliding would normally involve testing in accordance with 2.6.1 and 2.6.2.

5.4 Composite concrete construction

5.4.1 General

This sub-clause is applicable where precast reinforced or precast prestressed concrete units combine with added in situ concrete to resist flexure, provision for horizontal shear transfer having been made at the contact surface.

5.4.2 Analysis and design of composite concrete structures and members

The analysis and design of composite concrete structures and members should be in accordance with section 3 or 4 (modified where appropriate by 5.4.6 and 5.4.7).

5.4.3 Effects of construction methods

The design of component parts as well as composite sections should take account of construction methods and whether props are used; stresses and deflections will both be affected.

5.4.4 Relative stiffness of members

The relative stiffness of members should be based on the concrete gross or transformed section; if the concrete in the two components of a composite member differs by more than 10 N/mm² an appropriate allowance should be made.

5.4.5 Assessment of strengths of sections of precast pre-tensioned units designed as continuous members

When such units are designed as continuous members and continuity is obtained with reinforced concrete cast in situ over the supports, the compressive stresses due to prestress in the ends of the units may be ignored over the transmission length for the tendons.

5.4.6 Serviceability limit states

5.4.6.1 Serviceability

5.4.6.1.1 General

In addition the recommendations given in section 3 and section 4 concerned with deflection and control of cracking, for composite construction (except generally, with simply-supported members) differential shrinkage may be relevant (see 5.4.6.4.2 and 5.4.6.4.3). Horizontal shear is governed by the ultimate limit state. The methods given in 5.4.7.1 to 5.4.7.4 ensure that composite action does not break down for the serviceability limit states and that the design shear strength is adequate for the ultimate limit state.

5.4.6.1.2 Prestressed precast units

Where these are used, the methods of the analysis may be given in 4.3.4. However, the compressive stresses in the precast unit at the interface may be increased above the values given in 4.3.4.2 by not more than 50 % provided the failure of the composite member would be by excessive elongation of the steel.

5.4.6.2 Tension in in situ concrete

5.4.6.2.1 Prestressed precast units in direct contact with in situ concrete

When flexural tensile stresses are induced in the in situ concrete by imposed service loading, the design tensile stresses in the in situ concrete at the contact surface should be limited to the values given in Table 5.4. However, these values may be increased by 50 % provided the design tensile stress in the prestressed concrete unit is reduced by the same numerical amount.

**Table 5.4 — Design flexural tensile stresses
in in situ concrete**

Grade of in situ concrete	Maximum tensile stress N/mm ²
25	3.2
30	3.6
40	4.4
50	5.0

5.4.6.2.2 Prestressed precast units not in direct contact with in situ concrete

In this case the design flexural tensile stresses in the in situ concrete should be limited by cracking considerations in accordance with 3.12.11.2.3 to 3.12.11.2.9. If greater bar spacings are required, e.g. between groups of bars, the crack widths should be checked by calculation (see 3.8 of BS 8110-2:1985).

5.4.6.3 Tension in prestressed precast units

Where continuity is obtained with reinforced concrete cast in situ over the supports, the design flexural tensile stresses and the hypothetical tensile stresses in the prestressed precast units at the supports should normally be limited in accordance with 4.3.4.3.

5.4.6.4 Differential shrinkage

5.4.6.4.1 General

Where there is an appreciable difference between the age and quality of the concrete in the components, differential shrinkage may lead to increased stresses in the composite section and these should be investigated. The effects of differential shrinkage are likely to be more severe when the precast component is of reinforced concrete or of prestressed concrete with an approximately triangular distribution of stress due to prestress. In particular, the tensile stresses due to differential shrinkage may require consideration in design; the engineer should refer to the specialist literature in deciding when these stresses may be significant (see also section 7 of BS 8110-2:1985).

5.4.6.4.2 Calculation of tensile stresses

When calculating tensile stresses, it is necessary to know the differential shrinkage coefficient (the difference in total free strain between the two components of the composite member), the magnitude of which will depend on many variables.

5.4.6.4.3 Approximate value of differential shrinkage coefficient for building in a normal environment

In the absence of more exact data, a value of 100×10^{-6} may be assumed for the differential shrinkage in computing T-beams with an in situ concrete flange.

5.4.7 Ultimate limit state**5.4.7.1 Horizontal shear force due to design ultimate loads**

At the interface of the precast and in situ components the horizontal shear force due to design ultimate loads is either:

- a) where the interface is in the tension zone: the total compression (or tension) calculated from the ultimate bending moment; or
- b) where the interface is in the compression zone: the compression from that part of the compression zone above the interface, calculated from the ultimate bending moment.

5.4.7.2 Average horizontal design shear stress

The average horizontal design shear stress is calculated by dividing the design horizontal shear force (see 5.4.7.1) by the area obtained by multiplying the contact width by the beam length between the point of maximum positive or negative design moment and the point of zero moment.

The average design shear stress should then be distributed in proportion to the vertical design shear force diagram to give the horizontal shear stress at any point along the length of the member. The design shear stress v_h , should be less than the appropriate value in Table 5.5.

5.4.7.3 Nominal links

When provided, nominal links should be of cross-section at least 0.15 % of the contact area. Spacing should not be excessive. The spacing of links in T-beam ribs with composite flanges should not exceed four times the minimum thickness of the in situ concrete nor 600 mm, whichever is the greater. Links should be adequately anchored on both sides of the interface.

5.4.7.4 Links in excess of minimum

Where the horizontal shear stress from 5.4.7.2 exceeds the value given in Table 5.5, all the horizontal shear force should be carried on reinforcement anchored either side of the interface.

The amount of steel required A_h (in mm^2/m) should be calculated from the following equation:

$$A_h = \frac{1000bv_h}{0.95f_y} \quad \text{equation 62}$$

5.4.7.5 Vertical shear**5.4.7.5.1 General**

The design of composite members resisting vertical shear due to design ultimate loads should be carried out in accordance with 3.4.5 for reinforced concrete and with 4.3.8 for prestressed concrete.

For prestressed members, no shear calculations are necessary for the serviceability limit state.

5.4.7.5.2 In situ concrete between precast prestressed units

In such cases, when the composite concrete section is used in design, the design principal tensile stress should not exceed $0.24\sqrt{f_{cu}}$ anywhere in the prestressed units; this stress should be calculated by making due allowance for the construction sequence and by taking 0.8 times the compressive stress due to prestress at the section considered.

5.4.8 Differential shrinkage between added concrete and precast members

Differential shrinkage between added concrete and precast members need not be considered for the ultimate limit state.

5.4.9 Thickness of structural topping

The minimum thickness recommended is 40 mm nominal with a local minimum of 25 mm.

5.4.10 Workmanship

Workmanship is important in providing a good shear connection. In general, the topping should be well vibrated onto a surface that has been dampened but is without standing water (see 6.2.2 and 6.2.3).

Table 5.5 — Design ultimate horizontal shear stresses at interface

Precast unit	Surface type	Grade of in situ concrete		
		25 N/mm ²	30 N/mm ²	40 and over N/mm ²
Without links	As-cast or as-extruded	0.4	0.55	0.65
	Brushed, screeded or rough-tamped	0.6	0.65	0.75
	Washed to remove laitance or treated with retarder and cleaned	0.7	0.75	0.80
With nominal links projecting into in situ concrete	As-cast or as-extruded	1.2	1.8	2.0
	Brushed, screeded or rough-tamped	1.8	2.0	2.2
	Washed to remove laitance or treated with retarder and cleaned	2.1	2.2	2.5

NOTE 1 The description "as-cast" covers those cases where the concrete is placed and vibrated leaving a rough finish. The surface is rougher than would be required for finishes to be applied directly without a further finishing screed but not as rough as would be obtained if tamping, brushing or other artificial roughening had taken place.

NOTE 2 The description "as-extruded" covers those cases in which an open-textured surface is produced direct from an extruding machine.

NOTE 3 The description "brushed, screeded or rough-tamped" covers those cases where some form of deliberate surface roughening has taken place but not to the extent of exposing the aggregate.

NOTE 4 For structural assessment purposes, it may be assumed that the appropriate value of γ_m included in the table is 1.5.

Section 6. Concrete, materials, specification and construction

6.1 Materials and specification

Recommendations for the selection of materials for concrete and for the concrete to be specified to produce the required properties in the fresh and hardened state are given in 3 and 4 of this standard and BS 5328-1, which also gives guidance on sampling for strength conformity testing and action to be taken in the event of non-conformity. Further information on special aspects is included in BS 8110-2.

Recommended methods for specifying concrete are given in BS 5328-2. The methods are applicable only when used in conjunction with other applicable Parts of BS 5328.

Specifications for producing and transporting concrete and for sampling, testing and assessing conformity are detailed in BS 5328-3 and BS 5328-4 respectively.

The procedures detailed in BS 5328-4:1990 may need to be supplemented in the following cases.

- a) Alternative control procedures may be necessary in connection with certification and quality systems and product conformity (see introduction and 8.2.5 of BS 5328-1:1997).
- b) For properties not covered by BS 5328 the sampling and test procedure should be specified together with conformity tolerances that take account of the variability due to manufacture, sampling and testing.
- c) Additional cubes may be required for special purposes. These should be made and tested in accordance with BS 1881 but the methods of sampling and the condition under which the cubes are stored should be specified according to the purpose for which they are required. These include:
 - 1) the strength of concrete in prestressed concrete at transfer (see 4.1.8.1);
 - 2) the time at which to strike formwork (see 6.2.6.3);
 - 3) the strength of concrete under cold and hot weather conditions (see 6.2.4 and 6.2.5);
 - 4) sampling should preferably be at the point of placing and any such additional cubes should be stored as far as possible under the same conditions as the concrete in the members;
 - 5) the additional cubes should be identified at the time of manufacture and should not be used for the conformity procedures of BS 5328.

6.2 Concrete construction

6.2.1 General

The properties of concrete can be significantly affected by requirements for those aspects of workmanship that are covered by this section of this standard. It is for the specifier to ensure that the project specification is appropriate for the particular circumstances under which the concrete is to be constructed and the particular conditions to which it will subsequently be subjected. The following sub-clauses give general guidance on matters to be included in the project specification and typical requirements for consideration by the designer.

6.2.2 Placing and compacting concrete

A high degree of compaction without segregation should be ensured by providing suitable workability and by employing appropriate placing and compacting equipment and procedures. Full compaction is particularly important in the vicinity of construction and movement joints and of embedded water bars and reinforcement (see 6.2.9 and 6.2.10) and against previously placed, unhardened concrete.

Good finishing practices are essential for durable concrete (see 6.2.7). Overworking the surface and the addition of water to aid in finishing should be avoided; the resulting laitance will have impaired strength and durability and will be particularly vulnerable to freezing and thawing under wet conditions and to the action of de-icing salts.

All placing and compacting should be carried out under suitable supervision and as soon after mixing as is practicable. Delays in placing may be permitted providing that the concrete can still be placed and fully compacted without the addition of further water except as permitted by 4.10 of BS 5328-3:1990.

To conform to **2.3** control procedures should be established covering all aspects of workmanship including placing, compacting, finishing and curing concrete and working in cold or hot weather (see **6.2.3**, **6.2.4** and **6.2.5** of this standard). General guidance on placing and compaction is given in the following.

- a) Care should be taken to avoid displacing reinforcement, tendon, ducts and anchorages, or formwork, and damage to the faces of formwork, particularly when the concrete is allowed to fall freely through the depth of lift. In such cases a cohesive, non-segregating mix is required. The depth of lift to be concreted should be agreed and consideration given to the effect of lift height in massive sections on the temperature rise of the concrete.
- b) Concrete should not be moved across the surface of open textured formwork, such as wood wool, by means of internal vibration as this may lead to localized honey-combing and inadequate bonding between the concrete and the reinforcement.
- c) No concrete should be placed in flowing water. Under water, concrete should be placed in position by tremies or by pipeline from the mixer and never allowed to fall freely through the water unless specifically designed for this purpose.
- d) Concrete should be thoroughly compacted by vibration or other means during placing, and worked around the reinforcement, tendons or duct formers, embedded fixtures and into corners of the formwork to form a solid void-free mass having the required surface finish. When vibrators are used, vibration should be applied until the expulsion of air has practically ceased and in a manner that does not promote segregation. Over-vibration should be avoided to minimize the risk of forming a weak surface layer.
- e) Air-entraining admixtures and plasticizing admixtures can improve the handling and placing characteristics of fresh concrete.
- f) When external vibrators are used, the design of formwork and disposition of vibrators should be such as to ensure efficient compaction and to avoid surface blemishes.
- g) Where permanent formwork is incorporated in the structure, its energy absorption should be taken into account when deciding on the method of vibration to be used. Extra care is required to ensure full compaction of the concrete since this cannot be checked when the formwork is removed.

6.2.3 Curing

6.2.3.1 General

Curing is the process of preventing the loss of moisture from the concrete whilst maintaining a satisfactory temperature regime. The curing regime should prevent the development of high temperature gradients within the concrete.

The rate of strength development at early ages of concrete made with supersulfated cement is significantly reduced at lower temperatures. Supersulfated cement concrete is seriously affected by inadequate curing and the surface has to be kept moist for at least 4 days.

Curing and protection should start immediately after the compaction of the concrete to protect it from:

- a) premature drying out, particularly by solar radiation and wind;
- b) leaching out by rain and flowing water;
- c) rapid cooling during the first few days after placing;
- d) high internal thermal gradients;
- e) low temperature or frost;
- f) vibration and impact which may disrupt the concrete and interfere with its bond to the reinforcement.

Where members are of considerable bulk or length, the cement content of the concrete is high, the surface finish is critical, or special or accelerated curing methods are to be applied, the method of curing should be specified in detail.

6.2.3.2 Minimum periods of curing and protection

Surfaces should normally be cured for a period not less than that given in Table 6.1. Depending on the type of cement, the ambient conditions and the temperature of the concrete, the appropriate period is taken from Table 6.1 or calculated from the last column of that table. During this period, no part of the surface should fall below a temperature of 5 °C.

The surface temperature is lowest at arrises and depends upon several factors, including the size and shape of the section, the cement class and cement content of the concrete, the insulation provided by the formwork or other covering, the temperature of the concrete at the time of placing and the temperature and movement of the surrounding air. If not measured or calculated, the surface temperature should be assumed equal to the temperature of the surrounding air (see CIRIA Report No. 43).

6.2.3.3 Methods

The most common methods of curing are:

- a) maintaining formwork in place;
 - b) covering the surface with an impermeable material such as polyethylene, which should be well sealed and fastened;
 - c) spraying the surface with an efficient curing membrane;
- NOTE An efficiency index of 90 % should be obtained when tested in accordance with BS 7542 [see clause 1027 of Department of Transport Manual of Contract Documents for Highway Works Volume 1: *Specification of Highway Works* (December 1991)].
- d) covering the surface with a damp absorbent material;
 - e) by continuous or frequent applications of water to the surface, avoiding alternate wetting and drying and the application of cold water to warm concrete surfaces;

NOTE Methods d) and e) should not be used when there is the possibility of freezing conditions.

Table 6.1 — Minimum periods of curing and protection

Type of cement	Ambient conditions after casting	Minimum periods of curing and protection	
		Average surface temperature of concrete	
		5 °C to 10 °C	t °C (any temperature between 10 °C and 25 °C)
PC 42.5 or PC 52.5 to BS 12 SRPC 42.5 to BS 4027	Average	4	$\frac{60}{t+10}$
	Poor	6	$\frac{80}{t+10}$
All cements indicated in Table 1 of BS 5328-1:1997 except for PC 42.5 or PC 52.5 to BS 12, SRPC 42.5 to BS 4027 and supersulfated cement.	Average	6	$\frac{80}{t+10}$
	Poor	10	$\frac{140}{t+10}$
All	Good	No special requirements	

NOTE 1 Abbreviations for the type of cement used are as follows:

- PC 42.5: Portland cement (class 42.5) (see BS 12);
 PC 52.5: Portland cement (class 52.5) (see BS 12);
 SRPC 42.5: Sulfate-resisting Portland cement (class 42.5) (see BS 4027).

NOTE 2 Ambient conditions after casting are as follows:

- good: damp and protected (relative humidity greater than 80 %; protected from sun and wind);
 average: intermediate between good and poor;
 poor: dry or unprotected (relative humidity less than 50 %; not protected from sun and wind).

6.2.4 Concreting in cold weather

6.2.4.1 General

In cold weather, consideration should be given to the following:

- a) prevention of freezing of the immature concrete;
- b) extended stiffening times which may lead to increased formwork pressures and delays in finishing;
- c) low rate of concrete strength development which may lead to delays in subsequent construction operation such as striking formwork.

Concrete may suffer permanent damage if its temperature falls below 0 °C before it is mature enough to resist disruption by freezing. The extent and severity of such damage is not readily determined and therefore the emphasis should be placed on measures to prevent it occurring.

To provide confidence that the concrete can resist permanent damage from freezing the temperature of the concrete should, at no point, fall below 5 °C until the concrete in the structural element reaches a strength of 5 N/mm² nor should water curing be applied in conditions where freezing of the concrete is anticipated. This should apply regardless of the air temperature at the point of placing. The 5 N/mm² strength requirement may be assessed by tests on cubes cured, as far as possible, under the same conditions as the concrete in the element (see 6.1).

NOTE Alternatively, guidance may be obtained from CIRIA Report No. 136.

Any concrete that is damaged by freezing should be removed from the work.

Measures can be taken for both the fresh concrete and the construction methods to assist in achieving the above requirements.

6.2.4.2 Fresh concrete

Measures which can be adopted for fresh concrete, up to the point of delivery, to assist in controlling the risk of damage from freezing, are:

- a) increase the specified minimum temperature of the fresh concrete in accordance with 4.9.1 of BS 5328-3:1990;
- b) incorporation of an accelerating admixture; chloride free admixtures should be used when the concrete contains reinforcement or other embedded metal;
- c) use of cement that hardens more rapidly;
- d) increase in cement content to raise the heat of hydration and early strength. Other measures may be needed to ensure the initial temperature of the concrete is sufficient for hydration to proceed.

6.2.4.3 Construction method

A range of measures can be adopted during the construction sequence to avoid the risk of damage from freezing. These include:

- a) all surfaces with which the fresh concrete will come into contact including those of formwork, reinforcement, prestressing steel and hardened concrete, should be free from snow, ice and frost and preferably be at a temperature close to that of the fresh concrete. Special care is needed when small quantities of fresh concrete are placed against larger quantities of hardened concrete at a lower temperature, or in frozen ground;
- b) covering the faces, particularly the exposed top faces of slabs and beams, with insulating materials;

NOTE Where permanent or temporary formwork of high thermal conductivity is used, additional thermal protection on formwork surfaces may be advisable.

- c) shielding newly placed concrete from the wind;
- d) using a heated enclosure, completely surrounding the freshly placed concrete, care being taken to prevent excessive evaporation of water or surface carbonation by the products of combustion;
- e) using heated formwork panels, precautions being taken to prevent excessive evaporation of water.

6.2.5 Concreting in hot weather

In hot weather special precautions may be necessary to avoid the loss of moisture and/or rapid stiffening of the concrete which prevents its proper compaction. High temperatures and loss of moisture after compaction can cause thermal and plastic cracking and a reduction in strength and durability.

Guidance on the selection of materials and specifying concrete for work in hot weather is given in 7.4.2 of BS 5328-1:1997.

At the time of placing no part of the concrete should have a temperature exceeding 30 °C, unless it can be demonstrated that a higher temperature will not have any detrimental effects on the concrete.

The temperature of the concrete can be reduced by cooling the water and aggregate; the temperature of the cement is less important although the use of warm cement is best avoided.

Particular attention should be given to placing, compacting and protecting the concrete as soon as possible after mixing. To prevent moisture loss from the concrete, the curing of surfaces not protected by forms should commence immediately after compaction. If the surface is not to be marked, it is best to provide the initial curing with sheets of impervious material, preferably pigmented to reflect radiation, supported away from the surface and fastened at the edges to prevent droughts.

6.2.6 Formwork

6.2.6.1 Design and construction

The design and construction of formwork should take account of safety and of the surface finish required. The formwork should be sufficiently rigid and tight to prevent loss of grout or mortar from the fresh concrete. Consideration should be given to the need to nominate a falsework coordinator whose duties would be similar to those outlined in BS 5975.

Formwork and its supports should maintain their correct position and be to correct shape and profile so that the final concrete structure is within the limits of the dimensional tolerances specified. They should be designed to withstand the worst combination of self-weight, reinforcement weight, wet concrete weight, concrete pressure, construction and wind loads, together with all incidental dynamic effects caused by placing, vibrating and compacting the concrete. Guidance on these loadings is given in *The Concrete Society Manual Formwork — Guide to good practice*⁵⁾, and in CIRIA Report 108, *Concrete Pressure on Formwork*,⁶⁾ and in BS 5975.

Before permanent formwork is used in the structure, its durability and compatibility with adjoining concrete should be established. It should be properly anchored to the concrete.

Formwork spacers left in situ should not impair the desired appearance or durability of the structure, e.g. by causing spalling, rust staining or allowing the passage of moisture. Recommendations for spacers are given in 7.3.

The formwork should be capable of being dismantled and removed from the cast concrete without shock, disturbance or damage. Where necessary, the arrangement should be such that the soffit form, properly supported on props, can be retained in position for such period as may be required to achieve the required strength and satisfy the specification. If the component is to be prestressed whilst still resting on the soffit form, provision should be made to allow for elastic deformation and any variation in mass distribution.

6.2.6.2 Cleaning and treatment of forms

Rubbish should be removed from the interior of the forms before the concrete is placed. The faces of the forms in contact with the concrete should be clean and treated with a suitable release agent, where applicable.

Release agents should be applied so as to provide a thin uniform coating to the forms without contaminating the reinforcement.

6.2.6.3 Striking of formwork

6.2.6.3.1 General

The time at which formwork is struck will be influenced by the following factors:

- a) concrete strength;
- b) stresses in the concrete at any stage in the construction period which, in the case of precast units, includes the stresses induced by disturbance at the casting position and subsequent handling;
- c) curing (see 6.2.3);
- d) subsequent surface treatment requirements;

⁵⁾ Available from The Concrete Society Ltd., 3 Etongate, Windsor Road, Slough SL1 2JA.

⁶⁾ Available from Construction Industry Research and Information Association, 6 Storey's Gate, Westminster, London SW1P 3AU.

e) presence of re-entrant angles requiring formwork to be removed as soon as possible after concrete has set, to avoid thermal cracking.

The formwork should be removed without shock, as the sudden removal of wedges is equivalent to an impact load on the partially hardened concrete.

Materials and plant should not be placed on any new construction in such a manner as to cause damage.

6.2.6.3.2 Striking period for cast in situ concrete

In the absence of other information the recommended periods before striking formwork given in Table 6.2 may be used for concrete made with Portland or sulfate-resisting Portland cements of strength class 42.5 or higher. Table 6.2 relates to the surface temperature of the concrete but, when this cannot be obtained, air temperatures may be used. Table 6.2 should not be used if accelerated curing methods or sliding forms are used.

Alternatively, striking times can be determined from tables published in CIRIA Report No. 136 *Formwork striking times — Criteria, prediction and methods of assessment*. These take account of the cement type, the grade of concrete, the dimensions of the section, the type of formwork, the temperature of the concrete when placed and the mean air temperature.

It may be possible to use shorter periods before striking formwork by determining the strength of the concrete in the structural element. Formwork supporting cast in situ concrete in flexure may be struck when the strength of the concrete in the element is 10 N/mm^2 or twice the stress to which it will be subjected, whichever is the greater, provided that striking at this time will not result in unacceptable deflection⁷⁾.

This strength may be assessed by test on cubes cured, as far as possible, under the same conditions as the concrete in the element (see 6.1).

When formwork to vertical surfaces, such as beam sides, walls and columns, is removed at early ages, care should be exercised to avoid damage to the concrete especially to arrises and features. If necessary, the provision of relevant curing methods should immediately follow the removal of the vertical formwork at such early ages and the concrete should be protected from low or high temperatures by means of suitable insulation (see 6.2.3.3).

6.2.7 Surface finish

6.2.7.1 Type of finish

A wide variety of finishes can be produced. Surfaces cast against forms may be left as cast, e.g. plain or profiled, the initial surface may be removed, e.g. by tooling or sandblasting, or the concrete may be covered, e.g. by paint or tiles; a combination of these techniques may be adopted, e.g. a ribbed profile with bush-hammered ribs. Upper surfaces not cast against forms may be trowelled smooth or profiled, e.g. by tamping; the initial surface may be removed, e.g. by spraying, or it may be covered, e.g. by a screed or plastics floor finish. When selecting the type of finish, consideration should be given to the ease of producing a finish of the required quality (see 6.2.7.2), the viewing distance and the change of appearance with time. In the case of external surfaces, account should be taken of the weather pattern at the particular location, any impurities in the air and the effect of the shape of the structure upon the flow of water across its surface. Such considerations will often preclude the specification of surfaces of uniform colour as these are very difficult to produce and deteriorate with time, particularly if exposed to the weather.

The type of finish may be specified by reference to 6.2.7.3, to the method of production, e.g. cast against close-jointed sawn boards, by describing the surface, e.g. by indicating the required profile, by photographs or by samples.

6.2.7.2 Quality of finish

A high quality finish is one that is visually pleasing; it may include colour variations and physical discontinuities but these are likely to be distributed systematically or randomly over the whole surface rather than being concentrated in particular areas. When deciding on the quality of finish to be specified, consideration should be given to the viewing distance and the exposure conditions.

⁷⁾ Unacceptable deflection may be defined as deflection that is harmful for the member concerned.

There is no method whereby the quality of finish that will be accepted can unequivocally be defined. To achieve the quality required calls for good communication between experienced personnel conversant with the production of finishes and close collaboration with the site. The quality of finish can be identified in the following very broad terms:

- a) *class 2*: applies to surfaces that are to be exposed to view but where appearance is not critical; such surfaces might be the walls of fire escape stairs or plant rooms and columns and beams to structures that are normally viewed in the shade e.g. car parks and warehouses;
- b) *class 1*: is appropriate to most surfaces exposed to view including the external walls of industrial, commercial and domestic buildings;
- c) *special class*: is appropriate to the highest quality of finish of appearance, such as might be found in cathedrals and other prestigious buildings, where it is possible to justify the high cost of their production.

These broad descriptions may be amplified by written descriptions of the method of finish, by photographs, by samples or by reference to existing structures.

6.2.7.3 *Type of surface finish*

Smooth off-the-form and board marked finishes are not recommended for external use, but where they are specified for interior use the following types may be quoted for the guidance of both designers and contractors.

NOTE Designers should appreciate that it is virtually impossible to achieve dense, flat, smooth, even-coloured, blemish-free concrete surfaces directly from the formwork. Some degree of making good is inevitable, even with precast work.

- a) *Type A finish*. This finish is obtained by the use of properly designed formwork or moulds of timber, plywood, plastics, concrete or steel. Small blemishes caused by entrapped air or water may be expected, but the surface should be free from voids, honeycombing and other blemishes.
- b) *Type B finish*. This finish can only be obtained by the use of high quality concrete and formwork. The concrete should be thoroughly compacted and all surfaces should be true, with clean arrises. Only very minor surface blemishes should occur, with no staining or discoloration from the release agent.
- c) *Type C finish*. This finish is obtained by first producing a type B finish. The surface is then improved by carefully removing all fins and other projections, thoroughly washing down, and then filling the most noticeable surface blemishes with a cement and fine aggregate paste to match the colour of the original concrete. The release agent should be carefully chosen to ensure that the concrete surface will not be stained or discoloured. After the concrete has been properly cured, the face should be rubbed down, where necessary, to produce a smooth and even surface.

6.2.7.4 *Production*

The quality of a surface depends on the constituents and proportions of the concrete mix, the efficiency of mixing, the handling and compaction of the concrete and its curing. The characteristics of the formwork and the release agent may also be of critical importance. Requirements may be stated for any aspects of production that might contribute towards the achievement of the required type or quality of finish.

6.2.7.5 *Inspection and making good*

The surface of the concrete should be inspected for defects and for conformity to the surface finish specified and where appropriate, for comparison with approved sample finishes.

Subject to the strength and durability of the concrete being unimpaired, the making good of surface defects may be permitted but the level of acceptance should be appropriate to the type and quality of the finish specified and ensure satisfactory permanence and durability.

On permanently exposed surfaces great care is essential in selecting the materials and the mix proportions to ensure that the final colour of the faced area blends with the parent concrete in the finished structure.

Voids can be filled with a fine mortar, preferably incorporating styrene-butadiene rubber (SBR) or polyvinyl acetate (PVA), while the concrete is still green or when it has hardened. Fine cracks can be filled by wiping a cement grout, an SBR, PVA or latex emulsion, a cement/SBR or a cement/PVA slurry across them. Fins and other projections can be rubbed down.

6.2.7.6 Protection

High quality surface finishes are susceptible to damage during subsequent construction operations and temporary protection may have to be provided in vulnerable areas. Examples of such protective measures include the strapping of lathes to arrises and the prevention of rust being carried from exposed starter bars to finished surfaces.

6.2.8 Dimensional deviations

6.2.8.1 General

Absolute accuracy exists only in theory and dimensional variability is inevitable in practice. The permissible deviation specified should be as large as possible, without rendering the finished building or any part of it unacceptable for the purpose for which it is intended.

6.2.8.2 In situ concrete

Permissible deviations should be specified only for those dimensions that are important to the construction, performance or appearance of the structure. Guidance for designers on the accuracy that can be achieved is provided in Table 1 of BS 5606:1990.

6.2.8.3 Precast concrete members

Whilst dimensional variations are inevitable, precast concrete units can be manufactured to comparatively fine permissible deviations.

Permissible deviations should be specified only for those dimensional characteristics that are important to the correct assembly, performance and appearance of the structure, and these should be as large as practicable. The permissible deviations on other dimensional characteristics should be left to the discretion of the manufacturer, but these should be reasonable for the conditions of production and use. The manufacturer should on request make these permissible deviations known.

Care should be taken that the permissible deviations for the units are consistent with the variations in the position of the adjoining components in the building, and attention is drawn to BS 6954 which deals with the calculation of work sizes and joints clearances for building components.

The permissible deviations given below are a general guide and where closer values are necessary they can be halved. This however, should be restricted to the particular dimensions whose accuracy is important, as it will necessitate a very high standard of construction of the mould and the closest supervision and inspection at all stages of manufacture with consequent increased costs. In exceptional circumstances, it may be possible to reduce certain permissible deviations even further by means of specially designed moulds, but such reductions should only be made after giving careful consideration to the possible consequences of requiring such a high level of accuracy.

It is strongly recommended that the advice of manufacturers be obtained at the early design stages when very small permissible deviations are likely to be required, as those which can in practice be achieved depend on a number of factors including:

- a) *the shape of the units*, particularly as it affects the stiffness of the mould;
- b) *the mould materials and the method of assembly*;
- c) *the number of castings from each mould*;
- d) *the position and shape of any projections through the moulded faces*.

For irregular, curved or specially shaped units, the necessary dimensions and permissible deviations should be clearly defined in the specification and shown on drawings.

Particular attention is drawn to the fact that deviations can be cumulative (see BS 5606), the overall effects of which should then be taken into account in designing joints etc.

Where appropriate, the following permissible deviations are given as both plus and minus values on a specific dimension rather than as a deviation from a maximum or minimum value; working drawings to be used by the manufacturer should give dimensions and permissible deviations expressed in this form;

- e) *length* (major dimensions of unit):

up to 3 m	± 6 mm;
3 m to 4.5 m	± 9 mm;
4.5 m to 6 m	± 12 mm;

additional deviation for ± 6 mm;
every subsequent 6 m

f) *cross-section* (each direction):

up to 500 mm ± 6 mm;
500 mm to 750 mm ± 9 mm;
additional deviation for ± 3 mm;
every subsequent 250 mm

g) *straightness or bow* (deviation from intended line):

up to 3 m 6 mm;
3 m to 6 m 9 mm;
6 m to 12 m 12 mm;
additional deviation for 6 mm;
every subsequent 6 m

h) *squareness*. When considering the squareness of a corner, the longer of the two adjacent sides being checked should be taken as the base line. The shorter side should not vary in its distance from a perpendicular so that the difference between the greatest and shortest dimensions exceeds the following.

Length of shorter sides:

up to and including 1.2 m 6 mm;
over 1.2 m but less than 1.8 m 9 mm;
1.8 m and over 12 mm.

For item h) any error due to lack of straightness should be ignored; squareness should be measured with respect to the straight lines that are closest to parallel with the features being checked.

When the nominal angle is other than 90°, the included angle between check lines should be varied accordingly.

i) *twist*. Any corner should not be more than the deviation stated from the plane containing the other three corners:

up to 600 mm wide and up to 6 mm
6m in length;
over 600 mm wide and for any 12 mm;
length

j) *flatness*. The maximum deviation from a 1.5 m straight edge placed in any position on a nominally plane surface should not exceed 6 mm.

6.2.8.4 Prestressed units

In specifying permissible deviations for prestressed units, the creep, shrinkage, elastic shortening of the concrete, eccentricity of the steel and other significant factors should be taken into account. Generally, the permissible deviations given in 6.2.8.3 for length, cross-section, twist and flatness will apply until the application of the stressing force.

At a given age and by the use of factors appropriate to that age applied to the method recommended in 4.3, a camber can be predicted. This predicted camber, the age and other controlling conditions, e.g. when supported at ends and subject to self-weight only, should be stated on the drawings or in the specification. The actual camber should not exceed the predicted camber by more than 50 %.

Where it is critical the variation in camber between closely associated units, e.g. floor units, laid side by side and practically touching and receiving plaster and/or topping, should not be greater than 6 mm for units up to 4.5 m in length, or 9 mm for longer units.

Where variations in camber are not critical, e.g. closely associated units with a false ceiling and thick top screed, or units not closely associated one with another, variations in camber in excess of that stated above may be acceptable and should be judged in relation to the condition they should fulfil.

6.2.8.5 Position of reinforcement and tendons

For permissible deviations on the position of reinforcement and tendons, see **7.3** and **8.6** respectively.

6.2.8.6 Position of concrete bolts and other devices in precast concrete components

The position of individual connecting bolts, bolt holes, projecting steel or other steel or other devices should be within 6 mm of the specified datum line (frequently the edge of the component). Groups and lines of such bolts, etc. should be located similarly, but with the centre of the group or with the best line within 6 mm of the specified value when measured with reference to the datum. Within a group or line of such bolts, etc, each individual item should be within 3 mm of the specified dimension or specified alignment in relation to the other items in the group or line. It may be necessary to ensure that cast in connecting bolts, etc., are used to locate precast components with reference to site grid or datum lines, and drawings should indicate what is required. In this case the edges of the component should not be used for location purposes, and the tolerance in the adjacent structure may need to be greater than would normally be the case.

The position of bolt holes and other insertions for the attachment of timber, cladding and other non-structural items should not normally be required to be closer to their true position than twice the above deviations.

6.2.8.7 Control of dimensional accuracy

Deviations arise at three stages of construction: during initial setting out, during in situ construction and in the process of erecting and assembling precast units. It is important that effective control measures are adopted to ensure that deviations are kept within permissible limits. Reference should be made to BS 5606 for data on deviations arising during construction operations and for guidance on the principal factors affecting the accuracy of in situ construction and the accuracy of the erection of precast units. Close supervision of all aspects of the erection process is essential to ensure that components are positioned within the permissible deviations.

6.2.8.8 Checking of dimensional accuracy

Where permissible deviations have been specified, the method of measurement, making allowance for permitted variations, should be agreed in advance of manufacture.

The effect of temperature, shrinkage and imposed load should be taken into account.

Dimensions should be within the permissible deviations, and the positions of bars, tendons or ducts should be checked where these are visible (see **7.3** and **8.6**).

In the case of precast units the checking of twist, bow, squareness and flatness may entail removal of the unit from its stacked position to a special measuring frame.

Extensive checking of units in this manner may materially affect the cost. The frequency and scope of measurement checks should therefore be strictly related to the production method, the level of quality control at the place of casting and the function that the unit has to fulfil.

When checking the camber or upward deflection due to prestress, the precast unit should be placed on proper bearings at full span and a central reference point should be provided level with the bearings. The amount of upward deflection to be expected at any stage should be assessed as described in **4.3.7.1**. A thin wire stretched across the bearings and tensioned sufficiently to take out the sag is an alternative method of checking. Upward deflection is preferably measured on the underside.

6.2.9 Construction joints

The number of construction joints should be kept to the minimum necessary for the execution of the work. Their location should be carefully considered and agreed before concrete is placed. They should normally be at right angles to the general direction of the member.

The concrete at the joint should be bonded with that subsequently placed against it, without provision for relative movement between the two. Concrete should not be allowed to run to a feather-edge and vertical joints should be formed against a stop end. High quality workmanship is necessary when forming the joints to insure that the load-bearing capacity of the concrete in the area of the joint is not impaired.

The top surface of a layer of concrete should be level and reasonably flat unless design considerations make this undesirable. If a kicker, i.e. a starter stub, is used, it should be at least 70 mm high and carefully constructed. It is sometimes necessary for a kicker to be cast with the previous concrete.

If it is necessary for a joint to transfer tensile or shear stresses, the surface of the first pour should be roughened to increase the bond strength and to provide aggregate interlock. With horizontal joints, the joints surface should, if possible, be roughened, without disturbing the coarse aggregate particles, by spraying the joint surface approximately 2 h to 4 h after the concrete is placed with a fine spray of water and/or brushing with a stiff brush. Vertical joints can be treated similarly if the use of a retarder on the stop end is authorized, to enable the joint surface to be treated after the stop end has been removed.

Alternatively, mesh or expanded metal stop ends, not extending into the cover zone, may be approved to provide a rough face to the joint which can, in some cases, be sprayed whilst the concrete is still green.

If it is not possible to roughen the joint surface until the concrete has hardened, the large aggregate particles near the surface should be exposed by sand-blasting or by applying a scale hammer or other mechanical device. Powerful hammers should not be used as they may damage or dislodge aggregate particles so reducing, rather than increasing the capacity of the joint to transfer stresses.

Care should be taken that the joint surface is clean immediately before the fresh concrete is placed against it. It may need to be slightly wetted prior to the new concrete being placed, to prevent excessive loss of mix water into it by absorption. Particular care should be taken in the placing of new concrete close to the joint to ensure that it has an adequate fines content and is fully compacted and dense.

It is not normally necessary to incorporate water stops at horizontal construction joints. A vertical joint in any element retaining a liquid or moist material should be treated as a movement joint if it is considered that it may open sufficiently to permit the passage of liquid (see 6.2.10).

6.2.10 Movement joints

When forming movement joints, any joint filler should be fixed firmly to the first-placed concrete. If more than one strip is used within a joint, it is essential to butt the ends tightly or tape them together to prevent grout leakage restricting the closure of the joint.

It is essential that the concrete on both sides of the joint, when placed, is thoroughly compacted to form a dense uniform mass. Where stop ends comprise more than one element, particular care is necessary to ensure that joints between elements are sufficiently tight to allow no grout loss through them during compaction of the concrete. Alternatively, contraction joints may be introduced by the use of crotch inducers.

Where flexible water stops are used, they should be fixed so as to ensure that they are not displaced from their intended position during compaction of the concrete and that the concrete surrounding them is fully compacted. The design of the water stop should be practical and take account of the problems often associated with integral water stop construction in difficult placing conditions.

Water stops laid horizontally and located within the concrete mass should be avoided since they attract the greatest risk of local honeycombing.

6.2.11 Handling and erection of precast concrete units

Precast concrete units should be manufactured, handled and assembled by methods that are safe and yield a completed structure which is satisfactory in relation to its stability, performance, durability and appearance. The recommendations in BS 5531 should be followed and, in addition, the following items should be specified or agreed:

- a) minimum ages of handling and transporting;
- b) the position and design of lifting points;
- c) the method of lifting;
- d) the type of lifting equipment;
- e) method of supporting and stacking, both while being stored and transported;
- f) method of assembly and erection;
- g) the accuracy of assembly and erection: guidance is given in Table 1 of BS 5606:1990;
- h) method of providing temporary support;
- i) method of providing final structural connections;
- j) composition of concrete or mortar used to fill joints;
- k) method of protecting the units from damage at all times.

Checks should be made to ensure that:

- 1) the units bear adequate identity, location and orientation marks;

- 2) units are not damaged by freezing;
- 3) temporary supports or connections to newly positioned units are provided as soon as practicable, these being completed before the lifting equipment is removed;
- 4) final structural connections are completed as soon as practicable;
- 5) contact surfaces intended to be bonded with in situ concrete have been properly prepared;
- 6) reinforcement is accurately located, particularly in the ends of members;
- 7) structural steel sections in ends of members and additional reinforcement needed to complete the connection, are accurately located;
- 8) joints are properly packed, particular attention being given to joints packed with concrete or mortar, especially if these are horizontal loaded-bearing joints;
- 9) all levelling devices, such as nuts and wedges, which have no load-bearing function in the finished structure should be slackened, released or removed as necessary.

Table 6.2 — Minimum period before striking formwork (concrete made with Portland cement 42.5 to BS 12:1991 or sulfate-resisting Portland cement 42.5 to BS 4027:1991)

Type of framework	Minimum period before striking	
	Surface temperature of concrete	
	16 °C and above	t °C (any temperature between 0 °C and 16 °C)
Vertical formwork to columns, walls and large beams	12 h	$\frac{300}{t + 10}$ h
Soffit formwork to slabs	4 days	$\frac{100}{t + 10}$ days
Soffitt formwork to beams and props to slabs	10 days	$\frac{250}{t + 10}$ days
Props to beams	14 days	$\frac{360}{t + 10}$ days
NOTE This table can be applied to PC and SRPC of higher cement strength classes.		

Section 7. Specification and workmanship: reinforcement

7.1 General

Reinforcement should conform to BS 4449, BS 4482 or BS 4483. Different types of reinforcement may be used in the same structural member.

7.2 Cutting and bending

It is essential that reinforcement (particularly grade 460) should not be subjected to mechanical damage or shock loading prior to embedment.

Reinforcement should be cut and/or bent in accordance with BS 4466.

Bends in reinforcement should have a substantially constant curvature. Where the temperature of the steel is below 5 °C, special precautions may be necessary such as reducing the speed of bending or, with the engineer's approval, increasing the radius of bending. If necessary, reinforcement may be warmed to a temperature not exceeding 100 °C.

Where necessary to bend reinforcement projecting from concrete, care should be taken to ensure that the radius of bend is not less than that specified in BS 4466.

Where it is necessary to reshape steel previously bent, this should only be done with the engineer's approval and each bar should be inspected for signs of fracture.

It is permissible to bend grade 250 reinforcement projecting from concrete provided that care is taken to ensure that the radius of bend is not less than that specified in BS 4466. Grade 460 bars should not be bent, rebent or straightened without the engineer's approval.

7.3 Fixing

Rough handling, shock loading (prior to embedment) and the dropping of reinforcement from a height should be avoided. Reinforcement should be secured against displacement outside the specified limits. Unless specified otherwise:

- a) the actual concrete cover should be not less than the required nominal cover minus 5 mm;
- b) where reinforcement is located in relation to only one face of a member, e.g. a straight bar in a slab, the actual concrete cover should be not more than the required nominal cover plus:
 - 1) 5 mm on bars up to and including 12 mm size;
 - 2) 10 mm on bars over 12 mm up to and including 25 mm size;
 - 3) 15 mm on bars over 25 mm size.

Nominal cover should be specified to all steel reinforcement including links. Spacers between the links (or the bars where no links exist) and the formwork should be of the same nominal size as the nominal cover. Spacers, chairs and other supports detailed on drawings, together with such other supports as may be necessary, should be used to maintain the specified nominal cover to the steel reinforcement. Spacers or chairs should be placed at a maximum spacing of 1 m and closer spacing may sometimes be necessary.

Spacers should be of such materials and designs as will be durable, not lead to corrosion of the reinforcement and not cause spalling of the concrete cover.

The mix used for spacer blocks made from cement, sand and small aggregate should be comparable in strength, durability, porosity and appearance to the surrounding concrete as far as is practicable. Concrete spacer blocks made on the construction site should not be used.

Non-structural connections for the positioning of reinforcement should be made with steel wire, tying devices, or by welding (see 7.6). Care should be taken to ensure that projecting ends of ties or clips do not encroach into the concrete cover.

The position of reinforcement should be checked before and during concreting, particular attention being directed to ensuring that the nominal cover is maintained within the limits given, especially in the case of cantilever sections. The importance of cover in relation to durability justifies the regular use of a covermeter to check the position of the reinforcement in the hardened concrete.

7.4 Surface condition

Reinforcement should not be surrounded by concrete unless it is free from mud, oil, paint, retarders, loose rust, loose mill scale, snow, ice, grease or any other substance which can be shown to adversely affect the steel or concrete chemically, or reduce the bond. Normal handling prior to embedment in the concrete is usually sufficient for the removal of loose rust and scale from reinforcement.

7.5 Laps and joints

Laps and joints should be made only by the methods specified in the contract or design specifications and at the positions shown on the drawings or as agreed by the engineer.

7.6 Welding

7.6.1 General

Welding on site should be avoided if possible, but where suitable safeguards and techniques are employed and provided that the types of steel (including “weldable” and “readily weldable” reinforcement as defined in BS 4449) have the required welding properties, it may be undertaken. Generally, however, all welding should be carried out under controlled conditions in a factory or workshop. The competence of the operators should be demonstrated prior to, and periodically during, welding operations. All welding should be carried out in accordance with the relevant British Standard and the recommendations of the reinforcement manufacturer.

7.6.2 Use of welding

Welding may be used for the following purposes.

- a) Fixing in position, for example, by welding between crossing or lapping reinforcement, or between bars and other steel members. Metal-arc welding or electric resistance welding may be used on suitable steels.
- b) Structural welds involving transfer of load between reinforcement or between bars and other steel members. Butt welds may be carried out by flash butt welding or metal-arc welding. For lapped joints, metal-arc welding or electric resistance welding may be used.

7.6.3 Types of welding

7.6.3.1 Metal-arc welding

Metal-arc welding of reinforcement conforming to BS 4449 should be carried out in accordance with BS 5135 and the recommendations of the reinforcement manufacturer.

7.6.3.2 Flash butt welding

Flash butt welding should be carried out with the correct combination of flashing, heating, upsetting and annealing, and only those machines that automatically control this cycle of operations should be used.

7.6.3.3 Electric resistance welding

Electric resistance welding should be carried out by methods that ensure the correct preparation of the bars to be welded and using welding machines that have adequate control of the welding parameters.

7.6.3.4 Other methods

Other methods of welding may be used subject to the approval of the client and reinforcement manufacturer.

7.6.4 Location of welded joints

Structural welds [see 7.6.2 b)] should not occur at bends in reinforcement. Unless otherwise agreed by the engineer, joints in parallel bars of the principal tension reinforcement should be staggered in the longitudinal direction. For joints to be considered as staggered, the distance between them should be not less than the end anchorage length for the bar.

7.6.5 Strength of structural welded joints

The strength of all structural welded joints should be assessed following tests on trial joints (see 3.12.8.18).

7.6.6 Welded lapped joints

The length of run deposited in a single pass should not normally exceed five times the size of the bar. If a longer length of weld is required, it should be divided into sections and the space between runs made not less than five times the size of the bar.

Section 8. Specification and workmanship: prestressing tendons

8.1 General

Prestressing tendons should conform to BS 4486 and BS 5896.

8.2 Handling and storage

Care should be taken to avoid mechanically damaging, work-hardening or heating prestressing tendons while handling. All prestressing tendons should be stored clear of the ground and protected from the weather, from splashes from any other materials and from splashes from the cutting operation of an oxy-acetylene torch, or arc-welding processes in the vicinity.

In no circumstances may prestressing tendons after manufacture be subjected to any welding operation or on-site heat treatment or metallic coating such as galvanizing. This does not preclude cutting as given in 8.5.

Protective wrappings for tendons should be chemically neutral and suitable protection should be provided for the threaded ends of bars.

When prestressing tendons have been stored on site for a prolonged period, the engineer should ensure by tests that the quality of the prestressing tendons has not been significantly impaired by either corrosion, stress corrosion, loss of cross-sectional area or changes in any other mechanical characteristics.

8.3 Surface condition

All prestressing tendons and internal and external surfaces of sheaths or ducts should be free from loose rust, oil, paint, soap or other lubricants, or other harmful matter at the time of incorporation in the structural member. Under certain circumstances oiled or greased tendons may be used by agreement between the parties involved. A film of rust is not necessarily harmful and may improve the bond. It will, however, also increase the loss due to friction.

Cleaning the tendons may be carried out by wire brushing. Solvent solutions should not be used for cleaning without appropriate approval.

8.4 Straightness

8.4.1 Wire

Low relaxation and normal relaxation wire should be in sufficiently large diameter coils to ensure that the wire pays off straight.

8.4.2 Strand

Prestressing strand, however manufactured, should be in sufficiently large diameter coils to ensure that the strand pays off reasonably straight.

8.4.3 Bars

Prestressing bars as delivered should be straight. Any small adjustments for straightness, necessary on site, should be made by hand under the supervision of the engineer. Bars bent in the threaded portion should be rejected. Any straightening of bars should be carried out cold but at a temperature not less than 5 °C. Any necessary heating should be by means of steam or hot water.

8.5 Cutting

All cutting to length and trimming of ends should be by either.

- a) high-speed abrasive cutting wheel, friction saw or any other mechanical method approved by the engineer; or
- b) oxy-acetylene cutting flame, using excess oxygen to ensure a cutting rather than a melting action.

Care should be taken that neither the flame nor splashes come into contact with either the anchorage or other tendons.

In post-tensioning systems, the cutting action as in a) and b) should be not less than one diameter from the anchor, and the heating effect on the tendon should be kept to a minimum (the temperature of the tendon adjacent to the anchor should be not greater than 200 °C).

8.6 Positioning of tendons and sheaths

The tendons and sheaths should be accurately located and maintained in position both vertically and horizontally as shown on the drawings. Unless otherwise shown on the drawings, the permitted deviation in the location of the tendon, sheath or duct former should be ± 5 mm.

The method of supporting and fixing the tendons (or the sheaths or duct formers) in position should be such that they will not be displaced by heavy or prolonged vibration, by pressure of the wet concrete, by workmen or by construction traffic. The means of locating prestressing tendons should not unnecessarily increase the friction when they are being tensioned.

Sheaths and extractable cores should retain their correct section and profile and should be handled carefully to avoid damage. Extractable cores should be coated with release agent only with the approval of the engineer and should not be extracted until the concrete has hardened sufficiently to prevent it being damaged. Joints in sheaths should be securely taped to prevent penetration of the duct by concrete or laitance, and ends of ducts should be sealed and protected after the stressing and grouting operations. Joints in adjacent sheaths should be spaced at least 300 mm apart. Damage can occur during the concreting operation, and if the tendon is to be inserted later, the duct should be dollied during the concreting process to ensure a clear passage for the tendon. Inflatable rubber ducts are not suitable for this purpose.

8.7 Tensioning the tendons

8.7.1 General

Tendons may be stressed either by pre-tensioning or by post-tensioning, according to the particular needs of the form of construction. In each system, different procedures and types of equipment are used and these govern the method of tensioning, the form of anchorage and, in post-tensioning, the protection of the tendons.

All wires or strands stressed in one operation should be taken, where possible, from the same parcel. Each cable should be tagged with its number and the coil number or numbers of the steel used. Cables should not be kinked or twisted, and individual wires and strands should be readily identifiable at each end of the member. No strand that has become unravelled should be used.

8.7.2 Safety precautions

A tendon when tensioned contains a considerable amount of stored energy, which, in the event of any failure, anchorage or jack, may be released violently. All possible precautions should be taken during and after tensioning to safeguard persons from injury and equipment from damage which may be caused by the sudden release of this energy.

8.7.3 Tensioning apparatus

Hydraulic jacks are the normal means for tensioning tendons, although weights or levers may sometimes be used. The tensioning apparatus should be in accordance with the following.

- a) The means of attachment of the tendon to the jack or tensioning device should be safe and secure.
- b) Where two or more wires or strands are stressed simultaneously, care should be taken that they are of approximately equal length between anchorage points at the datum of load and extension measurement.
- c) The tensioning apparatus should be such that a controlled total force is imposed gradually and no dangerous secondary stresses are induced in the tendons, anchorage or concrete.
- d) The force in the tendons during tensioning should be measured by direct-reading load cells or obtained indirectly from gauges fitted in the hydraulic system to determine the pressure in the jacks. Facilities should be provided for the measurement of the extension of the tendon and of any movement of the tendon in the gripping devices. The load-measuring device should be calibrated to an accuracy within ± 2 % and checked at frequent intervals. Elongation of the tendon should be measured to an accuracy within 2 % or 2 mm, whichever is the more accurate.

8.7.4 Pre-tensioning

8.7.4.1 General

Where pre-tensioning methods are used, the tension should be fully maintained by some positive means during the period between tensioning and transfer. The transfer of stress should take place slowly to minimize shock, which would adversely affect the transmission length.

8.7.4.2 Straight tendons

In the long-line method of pre-tensioning, sufficient locator plates should be distributed throughout the length of the bed to ensure that the wires or strands are maintained in their proper position during concreting. Where a number of units are made in line, they should be free to slide in the direction of their length and thus permit transfer of the prestressing force to the concrete along the whole line.

In the individual mould system, the moulds should be sufficiently rigid to provide the reaction to the prestressing force without distortion.

8.7.4.3 Deflected tendons

Where possible, the mechanisms for holding-down or holding-up tendons should ensure that the part in contact with the tendon is free to move in the line of the tendon so that frictional losses are nullified. If, however, a system is used which develops a frictional force, this force should be determined by test and due allowance made.

For single tendons, the deflector in contact with the tendon should have a radius of not less than five times the tendon diameter for wire or 10 times the tendon diameter for a strand and the total angle of deflection should not exceed 15°.

The transfer of the prestressing force to the concrete should be effected in conjunction with the release of hold-down and hold-up forces, so that any tensile stresses in the concrete resulting during the process do not exceed permissible limits.

8.7.5 Post-tensioning

8.7.5.1 Arrangement of tendons

Where wires or strands in a cable are not stressed simultaneously, spacing members should be sufficiently rigid not to be displaced during the successive tensioning operations.

Tendons, whether in anchorages or elsewhere, should be so arranged that they do not pass round sharp bends or corners likely to provoke rupture when the tendons are under stress.

8.7.5.2 Anchorages

All anchorages should conform to BS 4447. The anchorage system in general comprises the anchorage itself and the arrangement of tendons and reinforcement designed to act with the anchorage. The form of anchorage system should facilitate the even distribution of stress in the concrete at the end of the member and should be capable of maintaining the prestressing force under sustained and fluctuating load and under the effect of shock.

Split-wedge and barrel-type anchors should be of such material and construction that, under the loads imposed during the tensioning operation, the strain in the barrel does not allow such movement of the wedges that the wedges reach the limit of their travel before causing sufficient lateral force to grip the tendon, or at or before the limit of travel the wedges cause an excessive force in the tendon.

If proprietary forms of anchorage are used, the anchoring procedure should be strictly in accordance with the manufacturer's instructions and recommendations.

All bearing surfaces of the anchorages, of whatever form, should be clean prior to the tensioning operation.

Any allowance for draw-in of the tendon during anchoring should be in accordance with the engineer's instructions, and the actual slip occurring should be recorded for each individual anchorage.

After tendons have been anchored, the force exerted by the tensioning apparatus should be decreased gradually and steadily so as to avoid shock to the tendon or the anchorage.

Provision should be made for the protection of the anchorage against corrosion.

8.7.5.3 Deflected tendons

The deflector in contact with the tendon should, where possible, have a radius of not less than 50 times the diameter of the tendon, and the total angle of deflection should not exceed 15°.

Where the radius is less than 50 times the diameter of the tendon or the angle of deflection exceeds 15°, the loss of strength of the tendon should be determined by test and due allowance made.

8.7.5.4 Tensioning procedure

Before tensioning, it should be demonstrated that all tendons are free to move in the ducts. Tensioning should be carried out under competent supervision in such a manner that the stress in the tendons increases at a gradual and steady rate. Tensioning should not be carried out at temperatures below 0 °C without the approval of the engineer.

The supervisor in charge of stressing should be provided with particulars of the required tendon loads and extensions. Allowance should be made during stressing for the friction in the jack and in the anchorage although the former is not necessary when using load cells.

Stressing should continue until the required extension and/or tendon load is reached. The extension should allow for any draw-in of the tendon occurring at the non-jacking end, but measurement should not commence until any slack in the tendon has been taken up. A comparison between the measured tendon force and that calculated from the extension provides a check on the accuracy of the assumption made for the frictional losses at the design stage; if the difference is greater than 6 %, corrective action should be taken but only with the approval of the engineer. Full records should be kept of all tensioning operations, including the measured extensions, pressure-gauge or load-cell readings and the amount of pull-in at each anchorage.

Where a large number of tendons or tendon elements is being tensioned and the full force cannot be achieved in an element because of breakage, slip or blockage of duct, if the replacement of the element is not practicable, the engineer should consider whether a modification in the stress levels can still conform to the relevant limit state.

In the case of curved tendons, or tendons made up of a number of constituent elements, or tendons loaded in stages, the engineer should specify the order of loading and the magnitude of the load for each component of the tendon.

Tensioned tendons, anchorages and duct forms should be effectively protected against corrosion during the period between stressing and covering with grout, concrete or other permanent protection. Ducts should be plugged at their ends and vents.

8.8 Protection and bond of prestressing tendons

8.8.1 General

It is essential to protect prestressing tendons from both mechanical damage and corrosion. Protection may also be required against fire damage.

It may also be an important design requirement for the stressed tendon to be bonded to the structure it is prestressing.

8.8.2 Protection and bond of internal tendons

Internal tendons may be protected and bonded to the member by either cement grout or sand cement grout in accordance with 8.9. Alternatively, the tendons may be protected by other materials based on bitumen, epoxy resins, rubber, etc., provided that the effects on bond and fire resistance are not important.

8.8.3 Protection and bond of external tendons

A tendon is considered external when after stressing and incorporation in the work, but before protection, it is outside the structure. It does not apply, for example, to a floor comprising a series of precast beams themselves stressed with external tendons and subsequently concreted or grouted in so that the prestressing tendons are finally contained in that filling with adequate cover.

Protection of external prestressing tendons against mechanical damage and corrosion from the atmosphere or other environment should generally be provided by an encasement of dense concrete or dense mortar of adequate thickness. It may also be provided by other materials hard enough and stable enough in the particular environment.

In determining the type and quality of the material to be used for the encasement, full consideration should be given to the differential movement between the structure and the applied protection that arises from changes of load and stress, creep, relaxation, drying shrinkage, humidity and temperature in either. If the applied protection is dense concrete or mortar and investigations show the possibility of undesirable cracking, then a primary corrosion protection should be used that will be unimpaired by differential movement.

If it is required that external prestressing tendons be bonded to the structure, this should be achieved by suitable reinforcement of the concrete encasement to the structure.

8.9 Grouting of prestressing tendons

The grouting of prestressing tendons should be in accordance with BS EN 445⁸⁾, BS EN 446⁸⁾ and BS EN 447⁸⁾. For further information see also Annex A.

⁸⁾ In preparation.

Annex A (informative)

Grouting of prestressing tendons

A.1 General

The two main objectives when grouting ducts in post-tensioned concrete members are:

- a) to prevent corrosion of the tendons;
- b) to ensure efficient transfer of stress between the tendons and the concrete member.

To meet the first of these objectives, the grout should remain alkaline, should completely cover the tendons, and should contain no material that may promote corrosion.

The second objective requires that all voids in the ducts should be filled completely with a grout that, when hardened, has the required strength, elastic modulus and shrinkage characteristics and is bonded effectively to the tendons and the sides of the ducts. Upon freezing, the grout should not expand to an extent that will damage the concrete members.

These objectives can be met by following the recommendations given in BS EN 445⁹⁾, BS EN 446⁸⁾ and BS EN 447⁸⁾. It is essential, however, that all operations are carried out by experienced staff and that a high standard of workmanship is achieved. Records of the grout and the grouting operation should be kept.

A.2 Ducts

A.2.1 Duct design

Ducts are usually formed from the corrugated steel ducting; this may be galvanized to protect the ducting prior to it being cast into the concrete. Short sections of ducts may be formed by inflated or compressed rubber tubing.

Sudden changes in the diameter or alignment of ducts should be avoided. Vents should be provided at crests in the duct profile, at any unavoidable major change in the section of the duct and elsewhere if required. Vents should be provided at high points if the difference in level between them and low points is greater than 0.5 m. Anchorage vents should be provided. It should be possible to close all vents.

The ingress of water into lined ducts should be prevented, it may, however, be necessary to wet unlined ducts in which case drainage vents should then be provided at low points. Vents to be used as entry points should be threaded to permit the use of a screwed connector from the grout pump. Preferably, it should be possible to grout lengths of horizontal duct from either end.

Vents and injection connections to the duct should be secure and tight. They should be able to withstand disturbance before concreting and pressures generated in testing and grouting. The lining to a vertical duct should be rigid and thick enough to resist distortion under the pressure exerted by the concrete whilst it is being placed. It may be advantageous to extend a vertical duct by a riser pipe and header tank to collect any water separating from the grout whilst it is being placed.

If the delay between inserting the tendons and grouting the duct is likely to permit corrosion of the tendons, consideration should be given to the possible use of protective soluble oils on the steel or dry air in the sheath via vapour phase inhibitors. These materials should be in accordance with the recommendations of the manufacturer and it should be verified that their use will not have an adverse effect upon the properties of the grout or its bond with the tendons.

A.2.2 Construction

Before the concrete is placed, duct linings should be inspected for continuity, correct alignment, secure fixing, dents, splits and holes and any defects rectified; particular attention should be paid to joints between ducts and anchorages and joints between adjacent precast units. Leaks may be traced by pressurizing the air within the duct using pressure relief valves to ensure that allowable limits are not exceeded.

Vents should be inspected to ensure that they are not blocked. Ease of movement of prestressing tendons generally indicates a free passage for the grout.

⁹⁾ In preparation.

Lined ducts should be kept dry before grouting to prevent corrosion of the tendon, possible frost damage or excess water in the grout. It may be necessary to blow dry oil-free air through a lined duct occasionally to prevent condensation if it is left ungrouted for a considerable time. Unlined ducts may have to be wetted before grouting to prevent absorption of water from the grout by the surrounding concrete. It may be preferable to flush with a diluted cement slurry using, if necessary, a suitable dispersing agent.

Vertical ducts should be sealed at all times before grouting to prevent the ingress of rain and debris.

A.3 Properties of grout

A.3.1 General

The grout should be of high fluidity and cohesion when plastic, have low shrinkage when hardening and have adequate strength when hard. These properties depend upon the correct choice of materials and mixing procedure.

A.3.2 Fluidity

The fluidity should be sufficiently high for ease of pumping and, if appropriate, for penetration of the grout into the strand but sufficiently low to expel the air and any water in the duct. The fluidity can be increased by increasing the water/cement ratio but this may make the grout more prone to bleeding and will decrease the strength when hardened. An increase in fluidity without decrease in strength can be achieved by the use of a plasticizing agent although this may again promote bleeding.

The fluidity of the grout can be assessed using the procedures set out in BS EN 445¹⁰⁾. Two test methods are described in BS EN 445 ie. the immersion method and the cone method, of which the cone test is the simpler.

Required values for those tests are given in BS EN 447¹⁰⁾.

A.3.3 Cohesion

Cohesion is a measure of the resistance to segregation, bleeding and settlement. Whilst the cohesion can be increased by reducing the water/cement ratio, it is preferable to use admixtures to modify the viscosity or to produce the grout by high shear mixing. However, higher shear mixing may increase the rate of stiffening. Some admixtures cause a slight loss in the rate at which the hardened grout gains in strength. For test requirements for bleeding see BS EN 445¹⁰⁾ and BS EN 447¹⁰⁾.

A.3.4 Compressive strength

The strength of 100 mm cubes of grout, made, cured and tested in accordance with BS 1881-108, BS 1881-111 and BS 1881-116 should be not less than 27 N/mm² at 28 days.

A.4 Composition of grout

A.4.1 General

Grout is composed of ordinary Portland cement and water; sand, fillers and admixtures are sometimes also included.

A.4.2 Cement

At the time of use, the cement should conform to BS 12.

A.4.3 Water

Potable water is usually suitable for making grout. Tests for assessing the suitability of water are given in BS 3148.

A.4.4 Sand and fillers

Sand and fillers are normally only included in grouts placed in ducts with a diameter of more than 150 mm. Sand should conform to the grading requirements of BS 882 and should pass through a 1.18 mm sieve conforming to BS 410. P.f.a or g.g.b.f.s. may be used providing there is adequate information on its suitability.

A.4.5 Admixtures

Admixtures should be used as recommended by the manufacturer and should be free of any chemical liable to promote corrosion of the tendon or cause damage to the grout, e.g. chlorides, nitrates and sulfates. Advice should be sought before including more than one admixture in a grout.

¹⁰⁾ In preparation.

Plasticizing agents, viscosity modifying agents and gas generating admixtures may all be used. Gas generating admixtures will not remove entrapped air voids but only reduce their volume. The unrestrained expansion of a grout containing an expanding agent should not exceed 5 % at 20 °C. The expansion will increase with increase of temperature and decrease with increase of pressure.

Retarders may be useful when long sections of duct are grouted.

A.4.6 Chloride content

Chlorides from all sources, i.e. cement, water, sand, filler and admixture should not exceed 0.1 % by mass of the cement.

A.5 Batching and mixing of grout

All materials should be hatched by mass except the mixing water which may be batched by mass or volume. The water/cement ratio should not exceed 0.44. For a neat cement grout the optimum water/cement ratio will probably be about 0.40 and, with a suitable admixture, a water/cement ratio of 0.35 may be adequate. The quantity of sand or filler used should not exceed 30 % of the mass of the cement.

Sufficient material should be batched to ensure complete grouting of a duct making due allowance for overflow.

The grout should be mixed in a machine capable of producing a homogeneous colloidal grout and, after mixing, keeping the grout in slow continuous agitation, until it is ready to be pumped into the duct. Water should be added to the mixer first, followed by the cement. When these two materials are thoroughly mixed, sand or filler may be added.

The minimum time of mixing will depend upon the type of mixer and the manufacturer's recommendations should be followed. Generally, the minimum mixing time will be between 0.5 min and 2 min. Mixing should not normally be continued for more than 4 min. Where admixtures are used, the manufacturer's recommendations should be followed.

A.6 Grouting procedure

See BS EN 446¹¹⁾.

¹¹⁾ In preparation.

Index

- Admixtures **A.4.5**
 air-entraining **6.2.2 e)**
 Age allowance for concrete **3.1.7.3**
 Analysis
 flat slab structures **3.7.2**
 lateral loading **3.2.1.3**
 sections **2.5.3; 2.5.4**
 simplified analysis **3.2.1.2.1; 3.2.1.2.3; 3.2.1.2.4**
 structure **2.5.2**
 sub-frames **3.2.1.2**
 sway frame **3.2.1.3**
 vertical loading **3.2.1.2.2; 3.5.2.3**
 Anchorage
 bends **3.12.8.22; 3.12.8.23**
 bond stresses **3.12.8.4**
 hooks **3.12.8.22; 3.12.8.23**
 links **3.12.8.6**
 prestressed **8.7.5.2**
 Bases **3.11**
 pad footings **3.11.3**
 pile caps **3.11.4**
 reinforcement **3.11.3.2; 3.12.1.3**
 shear **3.11.3.3; 3.11.3.4; 3.11.4.3**
 Beams **2.5.3; 2.5.4**
 analysis **3.2.1.2; 3.2.1.3; 3.4.4**
 compressive reinforcement **3.4.4.4; 3.12.5.3; 3.12.7**
 deflection **3.4.6**
 design formulae **3.4.4.4**
 effective span **3.4.1.2; 3.4.1.3**
 flanged **3.4.4.5**
 links **3.4.5.5**
 loading arrangements **3.2.1.2.2**
 moments **3.4.3; 3.4.4**
 moment redistribution **3.2.2**
 prestressed **4.3**
 section analysis **3.4.4.1**
 shear **3.4.5**
 shear force coefficient Table 3.15
 shear enhancement **3.4.5.8; 3.4.5.10**
 simplified stress block **3.4.4.1; Figure 3.3**
 slender **3.4.1.6**
 span/effective depth ratio **3.4.5.5; 3.4.6.3**
 T-Beams and L-Beams **3.4.1.5**
 tension reinforcement **3.12.5.1; 3.12.5.3**
 Bearings **1.3.5; 5.2.3**
 Bending moments
 columns **3.8.2**
 flat slabs **3.7.2.7**
 one-way slabs **3.5.2.4; Table 3.12**
 two-way slabs **3.5.3; Table 3.13**
 Bent-up bars *see* reinforcement
 Bond **3.12.8**
 anchorage length **3.12.8.4**
 effective perimeter **3.7.7.7; 3.7.7.8**
 stresses **3.12.8.2; 3.12.8.3**
 Bonded tendons **4.12.4.2; 8.8**
 Cement
 content **3.3.5.1**
 water/cement ratio **3.3.5.1**
 Characteristic loads **2.4.1.1**
 Characteristic strength
 concrete **2.4.2.1**
 reinforcement **2.4.2.1; 3.1.7.4**
 prestressing tendons **2.4.2.1; 4.1.8.2**
 Columns **3.8**
 additional moments **3.8.3.9**
 biaxial bending **3.8.4.5**
 braced/unbraced **3.8.1.5**
 deflection **3.8.5**
 effective height **3.8.1.6**
 moments **3.8.2**
 reinforcement **3.12.5.3**
 short **3.8.1.3**
 slender **3.8.1.3**
 ultimate limit state **3.8.4**
 Composite concrete construction **5.4**
 Concrete
 admixtures **6.2.2 e)**
 age allowance **3.1.7.3**
 cement content **3.3.5.1**
 cold weather **6.2.4**
 compaction **6.2.2**
 creep **2.4.2.3; 2.5.4; 3.4.6.7; 4.8.5**
 cube tests **6.1**
 curing **6.2.3**
 durability **3.1.5.2**
 grade **3.1.7.2**
 heat of hydration **6.2.3.1**
 hot weather **6.2.5**
 placing **6.2.2**
 precast **5.2**
 protection **6.2.3.1**
 sampling **6.1**
 shrinkage **3.12.11.2.9**
 strength
 for reinforced concrete **3.1.7.2**
 for prestressed concrete **4.1.8.1**
 surface finish **6.2.7**
 vibration **6.2.2**
 Construction joints **3.12.2.1; 5.3; 6.2.9**
 Corbels **5.2.7**
 Cover **3.3**
 actual **3.3.1**
 durability **3.3.3**
 fire **3.3.6**
 nominal **3.3.1**
 Cracking **2.2.3.4; 4.1.3; 4.1.4; 4.3.4.3; 4.3.5.2**
 Creep
 deflection **3.4.6.7**
 general **2.4.2.3; 2.5.4**
 loss of prestress **4.8.5**
 Curing **6.2.3**
 Curved tendons **4.12.3.4**
 Deflected tendons **4.7.2; 8.7.4.3; 8.7.5.3**
 Deflection
 beams **3.4.6**
 columns **3.8.5**
 flat slabs **3.7.8**
 general **2.2.3.2**
 ribbed slabs **3.6.5**
 single-way slabs **3.5.7**
 span/effective depth **3.4.6.3; 3.4.6.5; 3.4.6.6; 3.4.6.7**
 two-way slabs **3.5.7**
 Design
 aim **2.1.1**
 basis **2.1**
 load *see* loads
 material properties **2.4.2**
 method **2.1.2**
 process **2.1.4**
 Detailing **3.12**
 Deviations **6.2.8**
 Differential shrinkage **5.4.6.4**
 Ducts **8.9.2**
 Durability **2.2.4; 2.4.7; 3.1.5; 4.1.5; 6.2**
 Effective length of cantilever **3.4.1.4**
 Effective span **3.4.1.2; 3.4.1.3**
 Effective width **3.4.1.5**
 Elastic modulus *see* modulus of elasticity
 Fatigue **2.2.5**
 Fire protection
 cover **3.3.1.1; 3.3.6; 4.1.5; 4.12.3.1.3**
 general **2.2.6**
 Flat slabs
 analysis **3.6.2; 3.7.2**
 bending moment coefficients **3.5.3.3**
 column heads **3.7.1.3**
 column strip **3.7.2.8; 3.7.2.9**
 crack control **3.7.9**
 deflection **3.7.8**
 definitions **1.3.2**
 division of panels into strips **3.7.2.8**
 drops **3.7.1.5**
 equivalent frame **3.7.2.4**
 load patterns **3.5.2.3**
 methods of design **3.7.3; 3.7.4**
 middle strip **3.7.2.8**
 moments **3.7.2.1**
 moment coefficients **3.7.2.10**
 moment transfer **3.7.4.2; 3.7.4.3**
 openings in panels **3.7.5**
 reinforcement arrangement **3.7.3.1; 3.12.10**
 shear **3.7.6; 3.7.7**
 shear perimeter **3.7.7.6; 3.7.7.7; 3.7.7.8**
 simplified method **3.7.2.7**
 Footings *see* bases

- Formwork **6.2.6**
 - cleaning and treatment **6.2.6.2**
 - design **6.2.6.1**
 - deviation **6.2.8.3**
 - striking **6.2.6.3**
- Friction losses **4.9**
- Grouting **8.9**
- Grouting procedure Annex A
- Holes **3.7.7.7**
- Hooks *see* reinforcement
- Hot weather concreting **6.2.5**
- Inspection of construction **2.3**
- Jacking force **4.7.1; 8.7.3**
- Joints
 - construction **3.12.2.1; 5.3**
 - movement **3.12.2.2;**
 - precast concrete **5.3**
- Lateral reinforcement
 - beams **3.4.5.2; 3.12.7**
 - columns **3.12.7**
 - general **3.6.6.2; 3.12.5.3; Table 3.25**
- Limit states **2.2**
- Loads
 - accidental *see* exceptional
 - characteristic **2.4.1.1**
 - combinations **2.4.3.1; 3.2.1.2.2; 3.5.2.3;**
 - Table 2.1
 - dead **2.4.1.1**
 - definitions **1.3.1.1; 1.3.1.2**
 - design **1.3.1.1; 1.3.1.2**
 - earth **2.4.1.2**
 - exceptional **2.4.3.2**
 - factor **2.4.1.3; 2.4.3.1; 2.4.3.2**
 - imposed **2.4.1.1**
 - nominal **2.4.1.2**
 - service **2.4.5**
 - ultimate **2.4.3**
 - water **2.4.3.1.2; Table 2.1**
 - wind **2.4.1.1; 2.4.3.1; Table 2.1**
- Materials
 - concrete section **6**
 - prestressing anchorages **8.7.5.2**
 - prestressing tendons section **8**
 - properties **2.4.2**
 - reinforcement section **7**
 - testing **6.1**
- Model tests **2.6.1**
- Modular ratio **2.5.2**
- Modulus of elasticity of reinforcement **2.5.4**
- Moment redistribution **3.2.2**
- Moment transfer
 - flat slabs **3.7.4.2**
 - footings **3.11.3.1**
- Movement joints **6.2.10**
- Nibs **5.2.8**
- Openings
 - flat slabs **3.7.3**
 - two-way slabs **3.5.3**
- Pad footings **3.11.3**
- Pile caps **3.11.4**
- Placing concrete **6.2.2**
- Poisson's ratio **2.4.2.4**
- Precast concrete **5.2**
 - bearings **5.2.3**
 - bearing stresses **5.2.3.4**
 - connections **5.3**
 - deviations **6.2.8.3**
 - corbels **5.2.7**
 - joints **5.3.5**
 - ties **5.1.8**
- Prestressed concrete
 - anchorages **8.7.5.2**
 - beams **4.3**
 - creep **4.8.5**
 - deflected tendons **4.7.2; 8.7.4.3**
 - design and detailing section **4**
 - design flexural tensile stresses **4.3.4.3**
 - ducts **4.12.4.3; 8.9.2**
 - end blocks **4.11**
 - friction **4.9**
 - grouting **8.9**
 - losses **4.8; 4.9**
 - prestressing force **4.7**
 - shear resistance **4.3.8**
 - cracked in flexure **4.3.8.5**
 - uncracked in flexure **4.3.8.4**
 - shrinkage **4.8.4**
 - steel relaxation **4.8.2.1; Table 4.6**
 - tendons
 - curved **4.12.5**
 - deflected **4.7.2; 8.7.5.3**
 - relaxation **4.8.2**
 - specification **8.1**
 - transmission length **4.10.3**
- Prototype tests **2.6.2**
- Redistribution of moments **3.2.2; 4.2.3**
- Reinforced concrete section **3**
- Reinforcement **3.12.4**
 - anchorage **3.12.8**
 - beams **3.12.6.1**
 - bends **3.12.8.22**
 - anchorage value **3.12.8.23**
 - bearing stresses **3.12.8.25**
 - minimum radii **3.12.8.24**
 - bent-up bars **3.4.5.6**
 - bond **3.12.8.2; 3.12.8.3; 3.12.8.4**
 - characteristic strength **3.1.7.4**
 - compression **3.12.7**
 - cover **3.3.6; 3.3.7; 4.12.3**
 - curtailment **3.12.9; 3.12.10**
 - deformed bars **3.12.8.4**
 - distance between bars **3.12.11**
 - elastic modulus **2.5.4**
 - fabric **3.12.8.5**
 - hooks *see* Reinforcement, bends
 - in columns *see* columns
 - in tension, bond and anchorage **3.12.8**
 - in walls **3.12.7.5**
 - laps **3.12.8.9**
 - links **3.4.4.5; 3.4.5.5; 3.7.7.5; 3.12.7**
 - mechanical splices **3.12.8.16**
 - minimum area **3.12.5.3**
 - minimum size of bars **3.12.5.4**
 - placing **7.3**
 - shear **3.4.5.3**
 - shrinkage **3.12.11.2.9**
 - spacing **3.12.11**
 - spacing blocks **7.3**
 - specifications **7.1**
 - stirrups *see* links
 - stress-strain curve Figure 2.2
 - surface condition **7.4**
 - ties **3.12.3**
 - welding **7.6**
- Ribbed slabs **3.6**
- Robustness **2.2.2.2**
 - reinforced concrete **3.1.4**
- Serviceability limit states **2.2.3**
- Shear resistance
 - bases **3.11.3.3; 3.11.3.4; 3.11.4.3**
 - beams **3.4.5**
 - bent-up bars **3.4.5.6**
 - columns **3.8.4.6**
 - effective perimeter in slabs **3.7.7.6; 3.7.7.7; 3.7.7.8**
 - enhanced shear strength **3.4.5.8**
 - flat slabs **3.7.6**
 - horizontal **5.4.7.1; 5.4.7.2**
 - links **3.4.5.5; 3.7.7.5; 3.7.7.6; 4.3.8.7; 4.3.8.8; 4.3.8.9; 4.3.8.10**
 - punching failure **3.7.7.1**
 - reinforcement **3.4.5.3; 3.5.5.3**
 - slabs **3.5.5; 3.7.6; 3.7.7**
 - walls **3.9.4.2; 4.2**
- Shrinkage
 - differential **5.4.6.4**
 - losses **4.8.4**
 - reinforcement **3.12.11.2.9**
- Shuttering *see* formwork
- Slabs
 - concentrated loads **3.5.2.2; 3.7.7**
 - flat **3.7**
 - holes **3.7.5**
 - hollow block **3.6.1.2**
 - middle and edge strips **3.5.3.5**
 - minimum reinforcement **3.12.5.3**
 - moments **3.5.2; 3.7.4**
 - one-way **3.5.2.4**
 - restrained on four sides **3.5.3.4; 3.5.3.5; 3.5.3.6**
 - ribbed **3.6**
 - shear **3.7.6; 3.7.7**
 - two-way **3.5.3**
 - torsional reinforcement **3.5.3.5**
 - Spalling **5.2.3.7; Table 5.1; Table 5.2**

Stability **2.2.2.1**

Staircases

depth of section **3.10.1.5**

effective span **3.10.1.3; 3.10.1.4**

general **3.10.1**

Steel *see* reinforcement

Strength of reinforcement **3.1.7.4; 4.1.8.2**

Stresses in concrete

compressive **4.3.4.2**

tensile **4.3.4.3**

transfer **4.3.5**

Structures and structural frames **3.2; 4.2**

Ties **2.2.2.2; 3.1.4.3; 3.12.3**

Ultimate limit state **2.2.2**

Vibration of concrete **6.2.2**

Walls

braced **1.3.4.3**

definitions **1.3.4**

effective height **3.9.3.2**

minimum reinforcement **3.12.5.3**

plain **3.9.4**

reinforced **3.9.3**

slender **1.3.4.9**

stocky **1.3.4.8**

unbraced **1.3.4.2**

Welding **3.12.8.17; 3.12.8.18; 3.12.8.19;**
3.12.8.20; 3.12.8.21; 7.6

Wind loads **2.4.1.1; 3.2.1.3.2**

Young's Modulus *see* Modulus of
elasticity

List of references (see clause 1.2)

Normative references

BSI publications

BRITISH STANDARDS INSTITUTION, London

- BS 12:1996, *Specification for Portland cement.*
- BS 410:1986, *Specification for test sieves.*
- BS 882:1992, *Specification for aggregates from natural sources for concrete.*
- BS 1881, *Testing concrete.*
- BS 1881-108:1983, *Method for making test cubes from fresh concrete.*
- BS 1881-111:1983, *Method of normal curing of test specimens (20 °C method).*
- BS 1881-116:1983, *Method for determination of compressive strength of concrete cubes.*
- BS 3148:1980, *Methods of test for water for making concrete (including notes on the suitability of the water).*
- BS 3921:1985, *Specification for clay bricks.*
- BS 4027:1996, *Specification for sulfate-resisting Portland cement.*
- BS 4447:1973, *Specification for the performance of prestressing anchorages for post-tensioned construction.*
- BS 4449:1997, *Specification for carbon steel bars for the reinforcement of concrete.*
- BS 4466:1989, *Specification for scheduling, dimensioning, bending and cutting of steel reinforcement for concrete.*
- BS 4482:1985, *Specification for cold reduced steel wire for the reinforcement of concrete.*
- BS 4483:1985, *Specification for steel fabric for the reinforcement of concrete.*
- BS 4486:1980, *Specification for hot rolled and hot rolled and processed high tensile alloy steel bars for the prestressing of concrete.*
- BS 5135:1984, *Specification for arc welding of carbon and carbon manganese steels.*
- BS 5328, *Concrete.*
- BS 5328-1:1997, *Guide to specifying concrete.*
- BS 5328-2:1997, *Methods for specifying concrete mixes.*
- BS 5328-3:1990, *Specification for the procedures to be used in producing and transporting concrete.*
- BS 5328-4:1990, *Specification for the procedures to be used in sampling, testing and assessing compliance of concrete.*
- BS 5531:1988, *Code of practice for safety in erecting structural frames.*
- BS 5606:1990, *Guide to accuracy in building.*
- BS 5896:1980, *Specification for high tensile steel wire and strand for the prestressing of concrete.*
- BS 5975:1982, *Code of practice for falsework.*
- BS 6399, *Loading for buildings.*
- BS 6399-1:1984, *Code of practice for dead and imposed loads.*
- BS 6399-2:1995, *Code of practice for wind loads.*
- BS 6399-3:1988, *Code of practice for imposed roof loads.*
- BS 6651:1992, *Code of practice for protection of structures against lightning.*
- BS 6954, *Tolerances for building.*
- BS 8110, *Structural use of concrete.*
- BS 8110-2:1985, *Code of practice for special circumstances.*
- BS 8110-3:1985, *Design charts for singly reinforced beams, doubly reinforced beams and rectangular columns.*
- BS EN 445, *Grout for prestressing tendons — Test methods¹²⁾.*

¹²⁾ In preparation.

BS EN 446, *Grout for prestressing tendons — Grouting procedures*¹³⁾.

BS EN 447, *Grout for prestressing tendons — Specification for common grout*¹³⁾.

Informative references

BSI publications

BRITISH STANDARDS INSTITUTION, London

BS 499, *Welding terms and symbols*.

BS 5628, *Code of practice for use of masonry*.

BS 6349, *Maritime structures*.

BS 7542:1992, *Method of test for curing compounds for concrete*.

BS 8004:1986, *Code of practice for foundations*.

BS 8204, *Screeds, bases and in situ floorings*.

Other references

Reinforcement connector and anchorage systems. CIRIA Report 92. Construction Industry Research and Information Association, London 1981.

Concrete Pressure on Formwork. CIRIA Report 108. Construction Industry Research and Information Association, London 1985.

Formwork striking times. Criteria, prediction and method of assessment. CIRIA Report 136. Construction Industry Research and Information Association, London 1995.

Formwork — Guide to good practice. The Concrete Society Ltd., Slough 1995.

¹³⁾ In preparation.

BSI — British Standards Institution

BSI is the independent national body responsible for preparing British Standards. It presents the UK view on standards in Europe and at the international level. It is incorporated by Royal Charter.

Revisions

British Standards are updated by amendment or revision. Users of British Standards should make sure that they possess the latest amendments or editions.

It is the constant aim of BSI to improve the quality of our products and services. We would be grateful if anyone finding an inaccuracy or ambiguity while using this British Standard would inform the Secretary of the technical committee responsible, the identity of which can be found on the inside front cover. Tel: 020 8996 9000. Fax: 020 8996 7400.

BSI offers members an individual updating service called PLUS which ensures that subscribers automatically receive the latest editions of standards.

Buying standards

Orders for all BSI, international and foreign standards publications should be addressed to Customer Services. Tel: 020 8996 9001. Fax: 020 8996 7001.

In response to orders for international standards, it is BSI policy to supply the BSI implementation of those that have been published as British Standards, unless otherwise requested.

Information on standards

BSI provides a wide range of information on national, European and international standards through its Library and its Technical Help to Exporters Service. Various BSI electronic information services are also available which give details on all its products and services. Contact the Information Centre. Tel: 020 8996 7111. Fax: 020 8996 7048.

Subscribing members of BSI are kept up to date with standards developments and receive substantial discounts on the purchase price of standards. For details of these and other benefits contact Membership Administration. Tel: 020 8996 7002. Fax: 020 8996 7001.

Copyright

Copyright subsists in all BSI publications. BSI also holds the copyright, in the UK, of the publications of the international standardization bodies. Except as permitted under the Copyright, Designs and Patents Act 1988 no extract may be reproduced, stored in a retrieval system or transmitted in any form or by any means – electronic, photocopying, recording or otherwise – without prior written permission from BSI.

This does not preclude the free use, in the course of implementing the standard, of necessary details such as symbols, and size, type or grade designations. If these details are to be used for any other purpose than implementation then the prior written permission of BSI must be obtained.

If permission is granted, the terms may include royalty payments or a licensing agreement. Details and advice can be obtained from the Copyright Manager. Tel: 020 8996 7070.