

StudioLive™ RML-Series Mixers

Touch-Software-Controlled, Rack-mount Digital Mixing System with Active Integration™

Quick Start Guide



Table of Contents

1.0 Overview — 1

- 1.1 Introduction — 1
- 1.2 What's In The Box — 2
- 1.2 Register your Studiolive RML-series mixer! — 3
- 1.3 Download UC-Surface for iPad® and Qmix™-Ai — 3
- 1.4 Update all Firmware and Software — 3

2.0 Networking the RML-series mixer — 4

- 2.1 IP Address Modes — 4
- 2.2 Wired Ethernet Control Setup — 4

3 Making the Connections — 5

- 3.1 Mixer Anatomy — 5
- 3.2 Single RML Mixer Setup — 6
- 3.3 Cascading RML Mixer Setup — 7
 - 3.3.1 RML Mixers with UC Surface — 7
 - 3.3.2 RML Mixers with CS18AI and UC Surface — 8
 - 3.3.3 Connecting a computer for recording/playback — 9
 - 3.3.4 Turning on Cascading — 10

4.0 Getting Started with UC-Surface — 11

- 4.1 Anatomy of the UC-Surface Screen — 11
 - 4.1.1 Connected device tabs. — 12
 - 4.1.2 Settings button. — 12
 - 4.1.3 Fat Channel Area — 13
 - 4.1.4 Presets Button — 14
 - 4.1.5 Channel Strip Area — 14
 - 4.1.6 Flex Master Channel Strip — 15
 - 4.1.7 Mix Selection Area — 15
 - 4.1.8 Main Output Area — 16
 - 4.1.9 Input Meter Bridge and Navigation — 16

1.0 Overview

1.1 Introduction



Thank you for purchasing a PreSonus® StudioLive™ RML-series Active Integration™ digital mixer. PreSonus Audio Electronics, Inc., has designed the RML32AI and RML16AI utilizing high-grade components to ensure optimum performance that will last a lifetime.

The powerful, scalable, and compact StudioLive RML32AI and RML16AI 32x16x3 rack-mount mixers combine the all new, battle-ready UC Surface touch-control software for Windows®, Mac® OS X, and iOS® with a powerful and comprehensive set of facilities for up to 64-channel mixing.

Based on the StudioLive AI-series engine, the StudioLive RML-series' Active Integration™ technology provides direct Wi-Fi and Ethernet networking, along with a tightly integrated software suite that includes Capture™ recording software with true virtual soundcheck and Studio One® Artist DAW software for Mac and Windows. Put all of this together and your StudioLive RML-series mixer provides you with a complete solution for live-sound mixing and studio recording.

We encourage you to contact us with questions or comments regarding this product. PreSonus Audio Electronics, Inc., is committed to constant product improvement, and we value your suggestions highly. We believe the best way to achieve our goal of constant product improvement is by listening to the real experts: our valued customers. We appreciate the support you've shown us through the purchase of this product.

For technical support, please visit www.presonus.com/support/Contact-Technical-Support.

1.2 What's In The Box

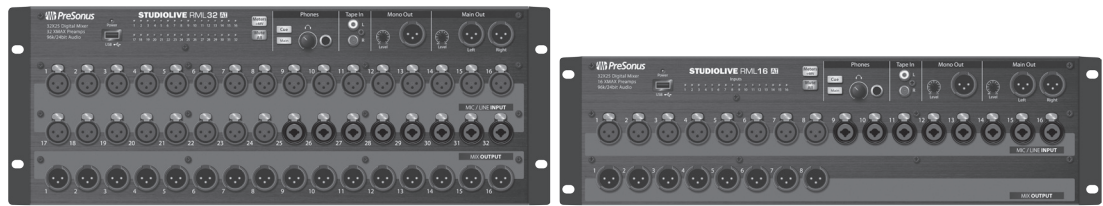

- StudioLive™ RML32AI or RML16AI

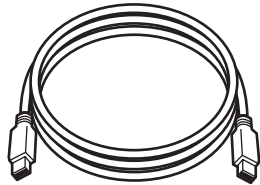

- FireWire 800 cable

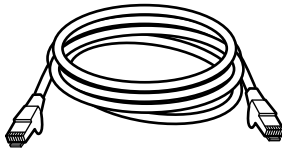

- Ethernet cable

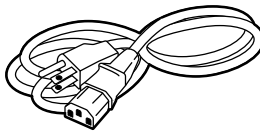

- Power cable



- Product registration and software authorization card

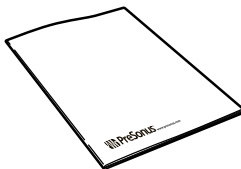

- This Quick Start Guide

1.2 Register your Studiolive RML-series mixer!

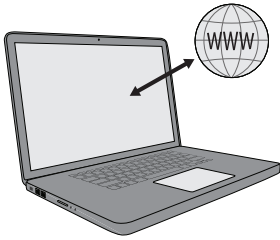

Before you do anything else, please register your StudioLive RML-series mixer online at <https://my.PreSonus.com> so you can download and authorize the included software, manuals, and video guides.

Your StudioLive RML-series mixer is more than a mixer; it's a powerful suite of integrated hardware and software solutions that take you from stage to studio. The following software is included with the StudioLive RML32AI and RML16AI.

- UC-Surface battle-ready mix-control application
- QMix™-AI personal monitor control
- Capture™ multitrack recording and virtual sound check
- Studio One® Artist professional DAW

1.3 Download UC-Surface for iPad® and Qmix™-Ai

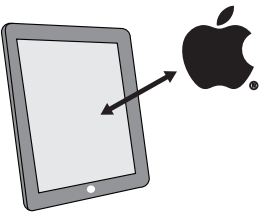

PreSonus' UC-Surface battle-ready mix-control app for iPad® and QMix™-AI aux-mix control app for iPhone®/iPod touch® are free downloads from the Apple App Store. You'll need this software to control your StudioLive RML-series mixer, so please download it now.

1.4 Update all Firmware and Software

First be sure you've updated all associated firmware and software including the RML-series mixers, CS18AI, UC Surface, Capture, and Studio One.

Please consult the **RML-Series Owner's Manual** or the [CS18AI Owner's Manual](#) for instructions on updating the associated firmware.

See the **RML-Series downloads page** about updating UC Surface and Capture software.

Consult your [My Presonus account](#) for updates to Studio One software.

Note: If using a **MOTU AVB Switch** be sure to update to the latest firmware available from MOTU.

2.0 Networking the RML-series mixer

2.1 IP Address Modes

An IP Address is a unique string of numbers that identifies each computer or device using the Internet Protocol to communicate over a network. StudioLive RM Mixers support three IP Address modes.

Dynamic

This is the most common and the default setting for StudioLive devices. In dynamic mode, the mixer is assigned an IP Address by a DHCP server which is included in most routers. When a mixer comes online, the router sees it and assigns a unique IP Address. The mixer will continue to wait for a DHCP server to provide an address.

Static Self Assigned

This mode is used if you're doing a direct connection between the mixer and another device like an AI Console mixer or CS18AI without the use of a router. In this mode the mixer will assign itself an IP Address based on a compatible range.

Static Manual

This mode is typically reserved for more complex networking installations and is usually setup by an IT professional. In this mode you can manually assign an IP Address, Subnet Mask, and Gateway. Please consult your IT Administrator before attempting to configure a Static Manual IP Address Mode.

Setting up the IP Address modes can be done in the Settings view of UC Surface in the Network tab. Alternatively, you can change the IP Address modes during bootup with the following method.

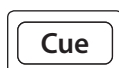

Hold down the Cue Source button while booting the mixer to reset from Static/Self-assigned to Dynamic mode - (The LED meters will flash Yellow to indicate the mode has been changed)



Hold down the Main Source button while booting the mixer to reset to Self-assigned IP - (The LED meters will flash Red to indicate the mode has been changed)

2.2 Wired Ethernet Control Setup

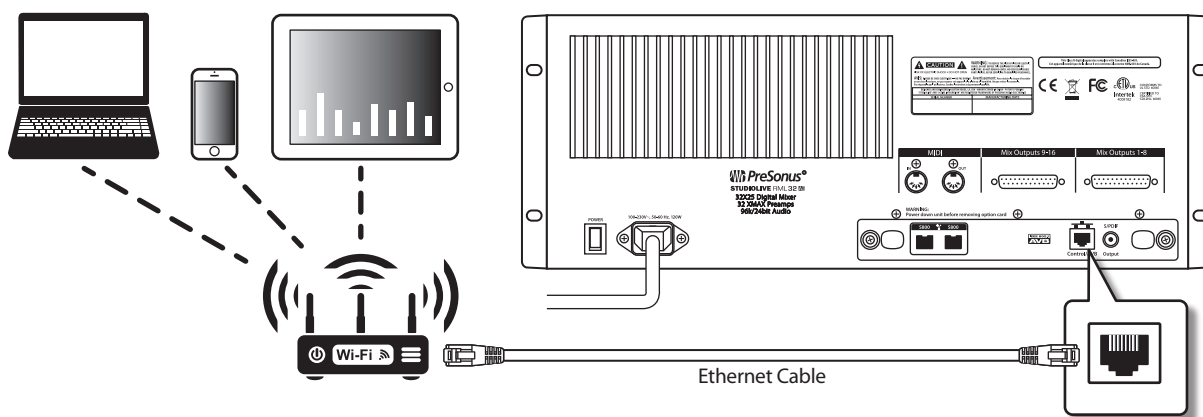

Your StudioLive RML32AI and RML16AI can be set up for control with a wired Ethernet connection in seconds. Simply connect the included Ethernet cable to the Ethernet control port on the back of the mixer and to a network router that is also connected to your computer or iPad.

When you launch UC-Surface with the computer or iPad and StudioLive RML32AI or RML16AI connected to the same network, the software should automatically see the mixer.

3 Making the Connections

3.1 Mixer Anatomy

Front Panels

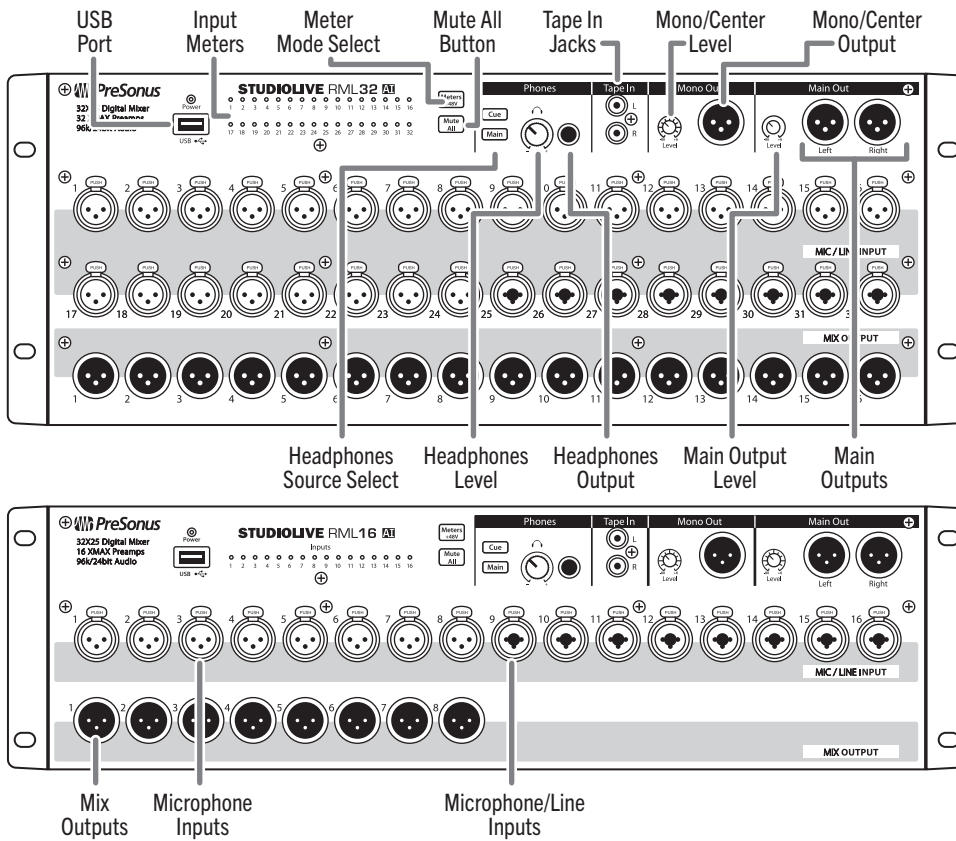

Rear Panels

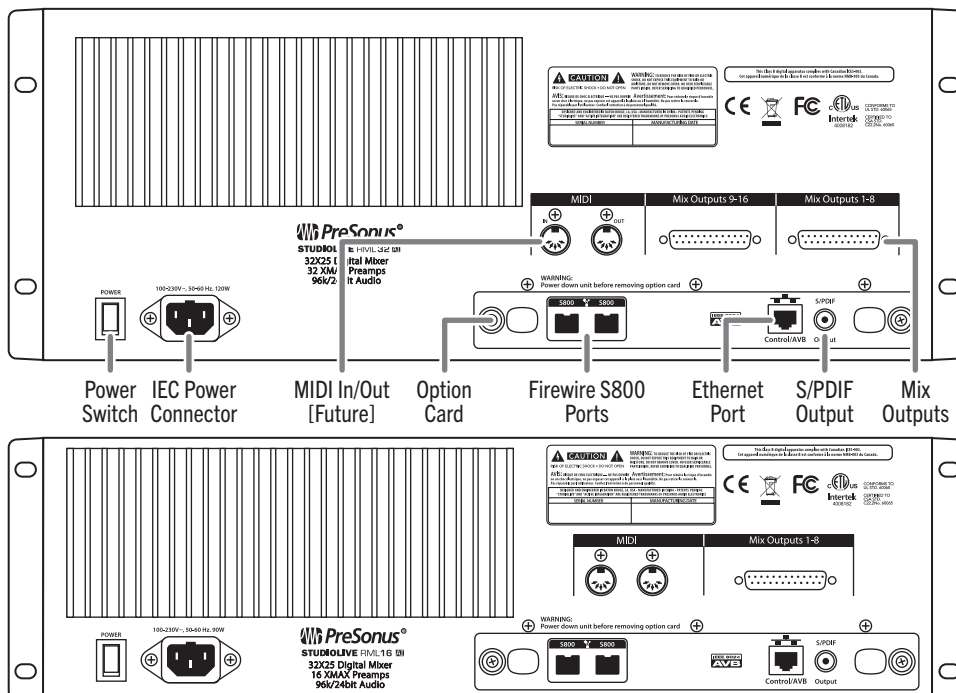

3.2 Single RML Mixer Setup

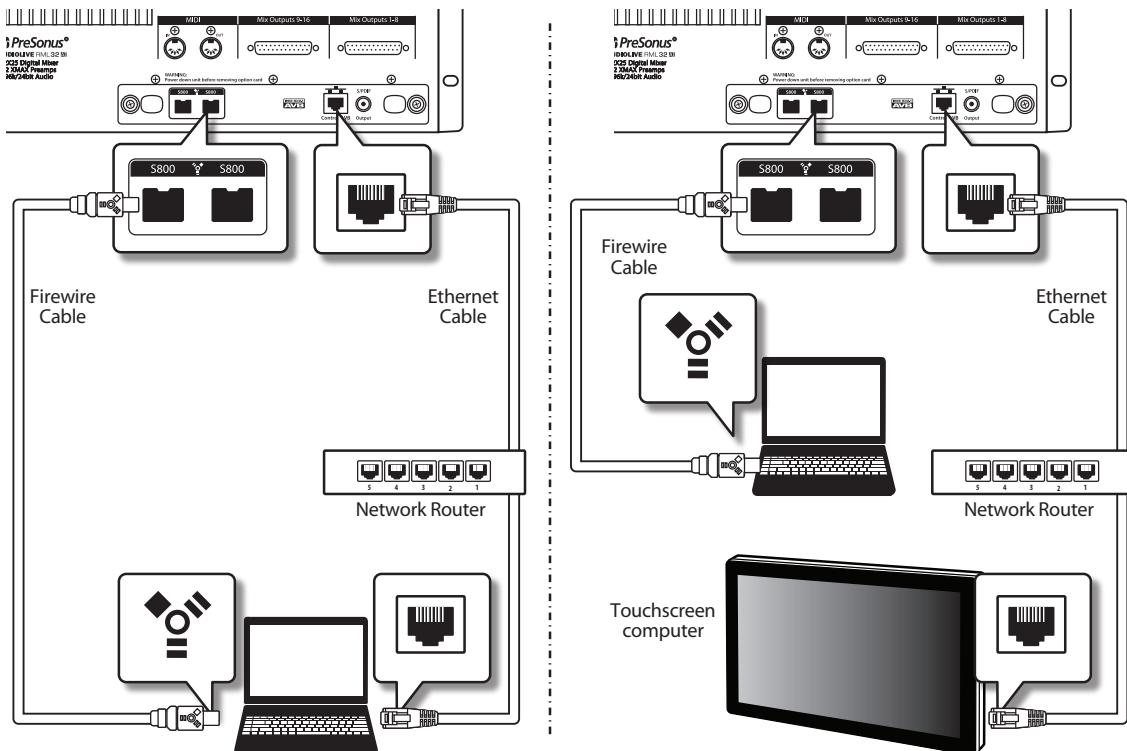

StudioLive RML32AI and RML16AI have been designed for tight integration with the included Capture and Studio One Artist software. You can record a live show quickly and with confidence to Capture, save the StudioLive AI mixer scene with the Capture Session, and then open that recording, complete with mixer scene, in Studio One. The Studio One mixer will be set to match your StudioLive AI mixer scene, including fader values, mutes, pan, and effects-send mixes. Fat Channel settings will be loaded into Studio One's new Fat Channel Native Effects™ plug-in.

You can also use the StudioLive AI mixer as an audio interface and monitor mixer for studio recording.

1. After registering your StudioLive AI mixer, download the Universal Control installer for Mac or Windows from your My PreSonus account. This installer includes the UC-Surface mix-control software and necessary drivers.
2. Launch the installer and follow the onscreen instructions. When the installer is finished, reboot your computer to complete the installation.
3. When the installation is complete simply connect your StudioLive AI mixer to your computer with the included FireWire cable and ensure both are on the same network.

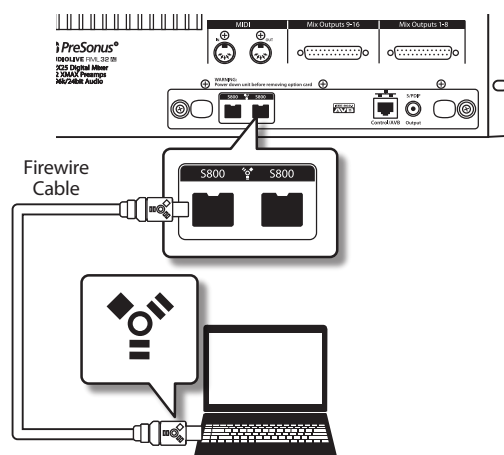

3.3 Cascading RML Mixer Setup

There are a few different ways to use cascaded RML-series mixers. This section shows how to make the connections between your RML mixers, control devices and network switches and routers.

For all configurations you'll need to connect the mixers via Ethernet using a compatible AVB switch. [Refer to our Knowledge Base for the most current list of compatible AVB switches.](#)

Note: If using a **MOTU AVB Switch** be sure to update to the latest firmware available from MOTU

3.3.1 RML Mixers with UC Surface

When cascading RML mixers with control from UC Surface there are three main ways you can connect the control device.

- Wired to the AVB Switch via Ethernet
- Wired to the Wireless Router via Ethernet
- Wireless connected to the Router

NOTE: If you connect directly to the AVB switch and are NOT using a wireless router, you'll need to configure your mixers to use a Static IP Address. If you need to use a manually assigned static IP address please consult your IT administrator to ensure you are using a compatible IP address and Subnet Mask. Refer to [section 2.1 IP Addresses](#) for more information.

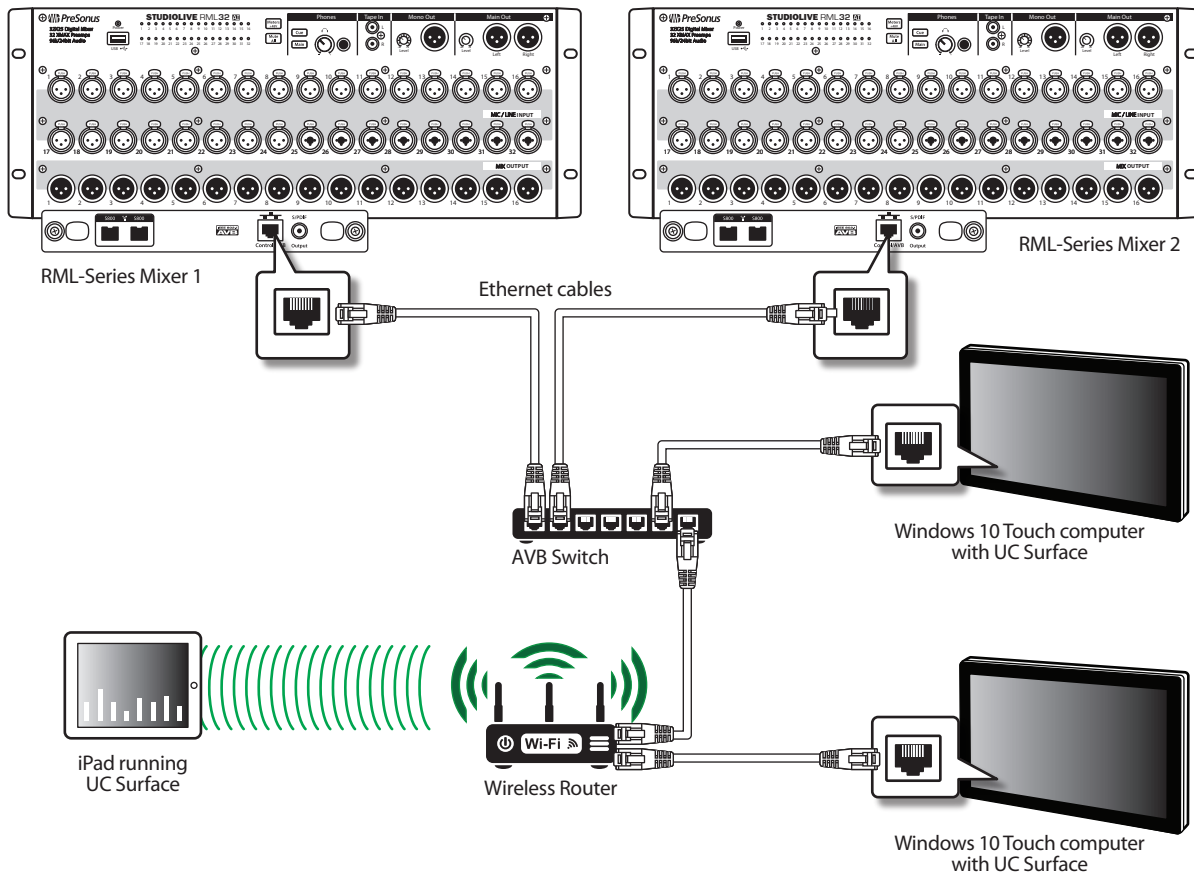

3.3.2 RML Mixers with CS18AI and UC Surface

When using a CS18AI for control of your cascaded RML mixers you'll want to connect it via the AVB Ethernet switch. This way you can take full advantage of the onboard audio IO. You can also connect your UC Surface device wired or wirelessly using one of the three methods mentioned above.

Note: Cascading of the mixer must be setup with UC Surface before connecting the CS18AI.

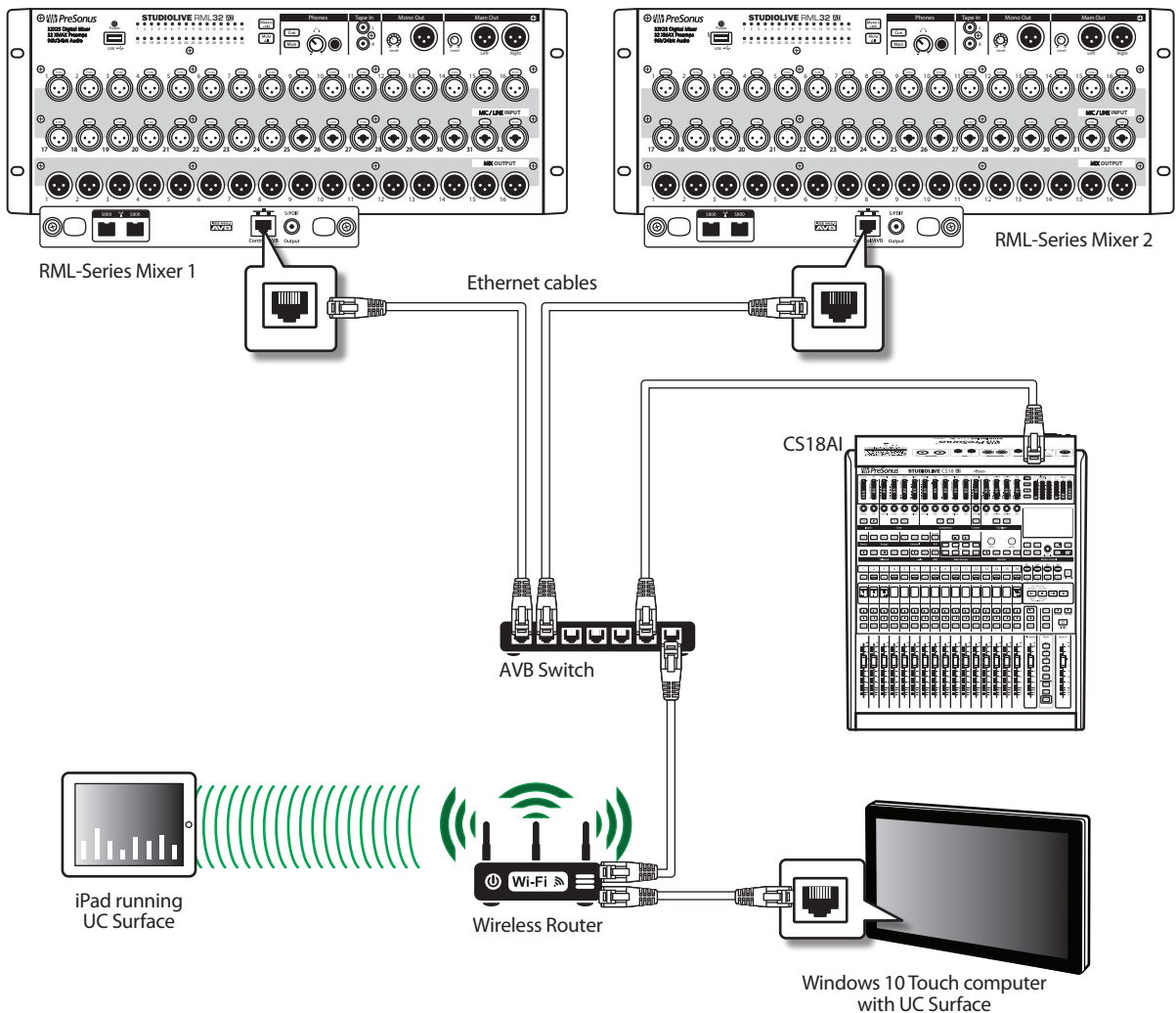

3.3.3 Connecting a computer for recording/playback

To take advantage of computer recording and playback your computer must be connected to the Master RML mixer via FireWire. If your computer is also connected to the Wireless Router (either wired or wirelessly) you can remote control Capture from your CS18AI or UC Surface for true remote operation.

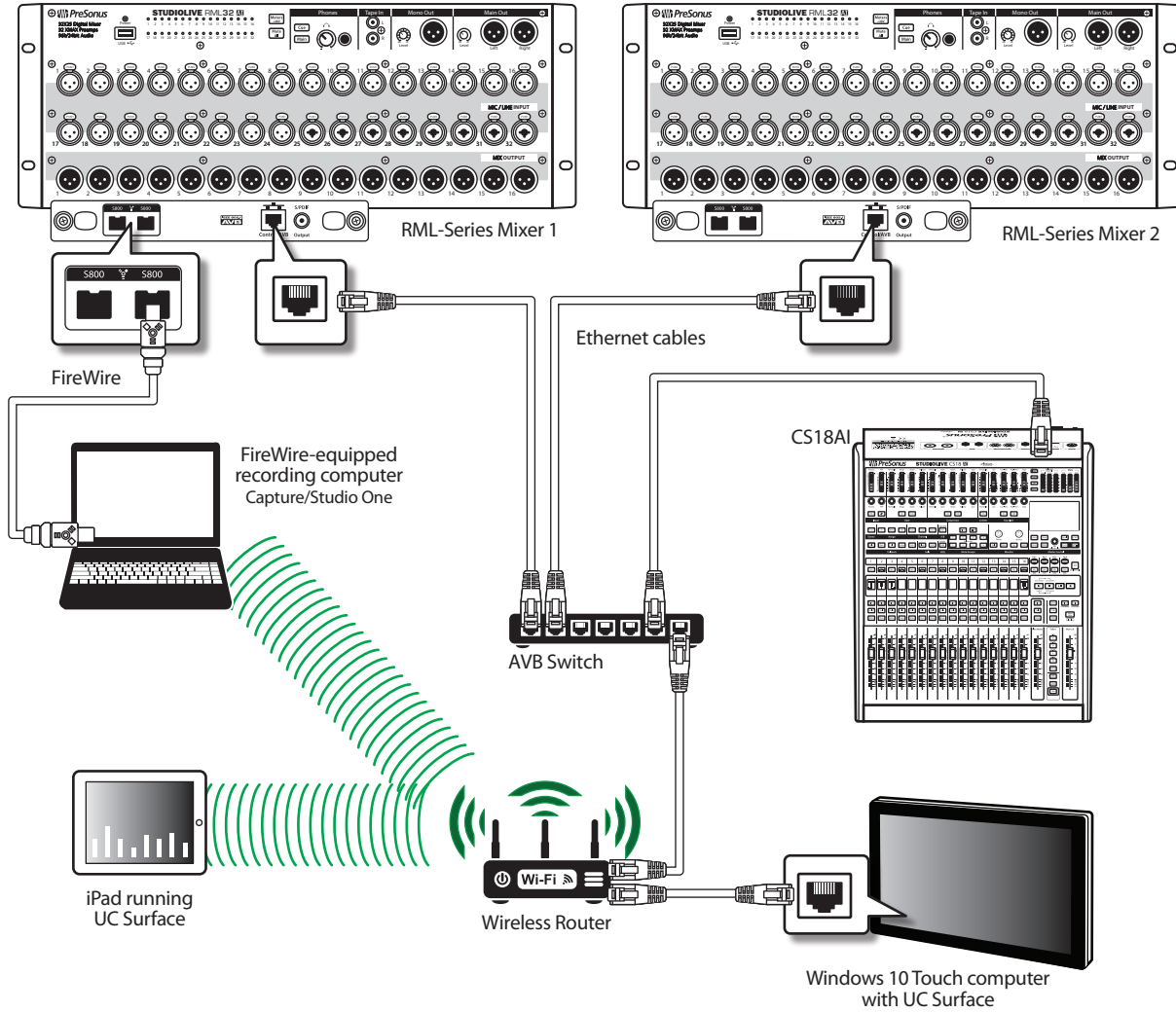

3.3.4 Turning on Cascading

Setting up cascading for the RML mixers is done using UC Surface. First, select the mixer you'd like to use as the master for channels 1-32.

An easy way to verify that you're connected to the right mixer is to press the Mute All button on the front panel of the mixer. If all the channels in UC Surface mute, you're connected to the right mixer.



Open the Settings view in UC Surface and then open the Networking tab.

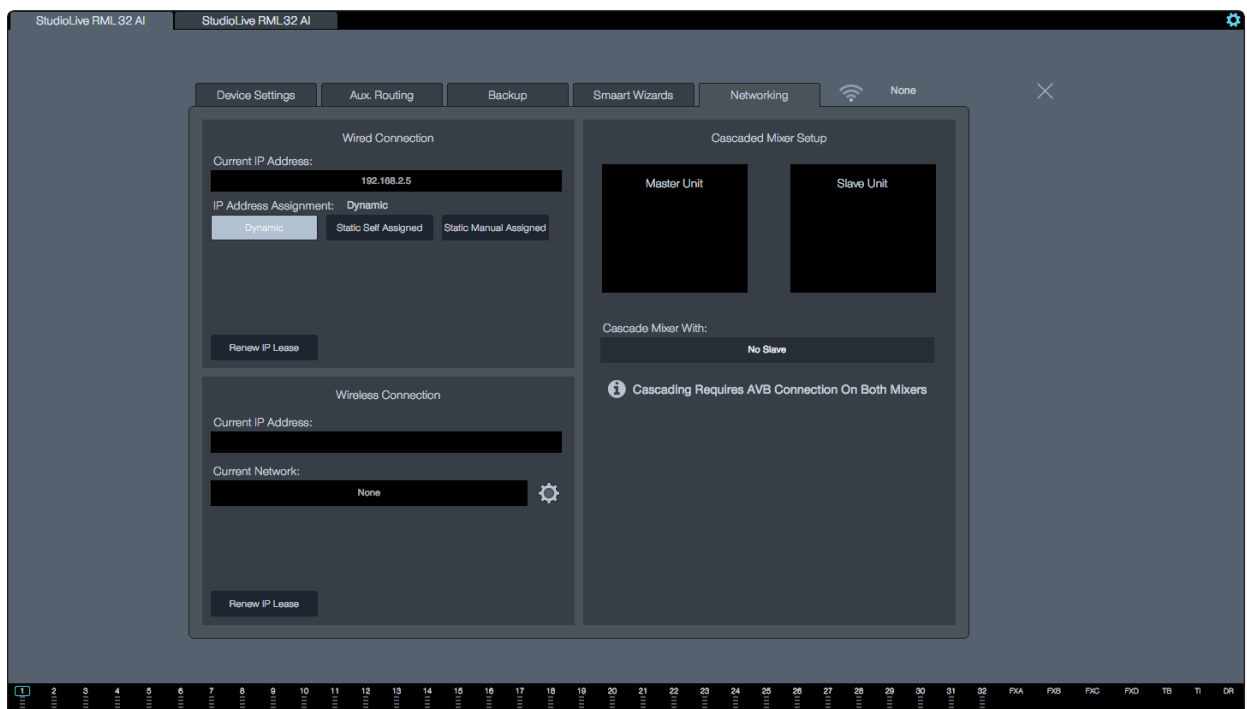

Here you'll see a section for cascading mixers. Select the mixer you'd like to be channels 33-64 from the drop down list.

Note: Establishing the cascaded connection may take several seconds. When complete, you'll see each mixer displayed in the Master and Slave unit spaces.

You're now cascaded and using the mixers as a single 64-channel mixer.

1. The tab at the top of the screen for the slave mixer will go away
2. When looking at the mixer view it will now show all 64-channels for both mixers
3. To remove the Cascade simply select None from the "Cascade with mixer" drop down list

If you're using a CS18AI, simply select either mixer from the dropdown list in the UCNET screen and you'll have control of both mixers as a single 64-channel system.

You are now set up with the amazing StudioLive AVB 64-channel mixing system!

For additional details and instruction on configuring your StudioLive AI as your default sound input and output device, please refer to your manual and the video guides in your My PreSonus account.

4.0 Getting Started with UC-Surface

StudioLive RML32AI and RML16AI are controlled with the UC-Surface battle-ready mix-control application, which is designed specifically for live mixing. All primary mixing functionality is at your fingers without the need to navigate complex views or deep menus.

4.1 Anatomy of the UC-Surface Screen

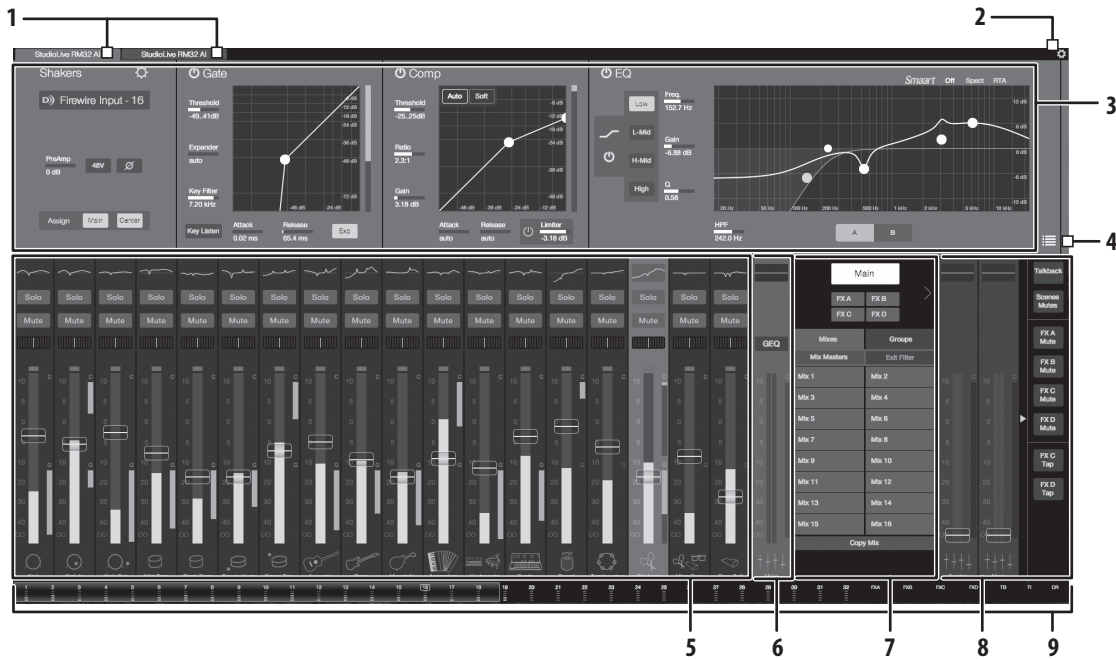

1. Connected device tabs
2. Settings button
3. Fat Channel area
4. Presets button
5. Channel strip area
6. Flex channel strip
7. Mix selection area
8. Main output area
9. Input Meter Bridge and navigation

4.1.1 Connected device tabs.

These tabs switch between different mixers available for control on the network. Selecting a tab will open the associated mixer control.



4.1.2 Settings button.



Selecting this button will open the mixer settings screen. This is where you can configure global mixer settings such as sampling rate, permissions, wireless network settings, and more.

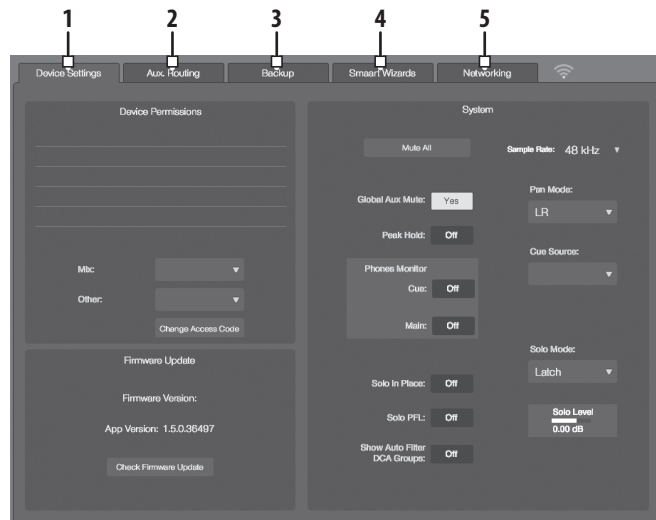

1. **Device Settings Tab.** General settings options for the selected mixer.
2. **Aux. Routing Tab.** Provides routing options for the additional digital outputs (FireWire and Network)
3. **Backup Tab.** Allows you to create and restore a backup of all scenes and presets on the mixer. Note that Backup does NOT save the current state of the mixer, only saved scenes and presets.
4. **Smart Wizards Tab.** Integrated Smart Wizards for room tuning, setting up delays, and checking outputs.
5. **Networking Tab.** Contains options for setting up IP Address modes and configuring Cascading.

4.1.3 Fat Channel Area

The information displayed in this area will change based on where you are in your workflow.

- Select any input channel, the Flex Master Channel, or a Main output to display the associated Fat Channel DSP.
- Select the Flex Master Channel GEQ or FX Edit to display the associated graphic EQ or effects settings.
- Select Scenes/Mutes (main output area) to display the Quick Scenes and Mute Groups.

Parameter Box

In UC-Surface, we've replaced the traditional "knob" graphics with a more informative parameter box. This area displays the name of the parameter, text of the current value, and a meter showing the value.

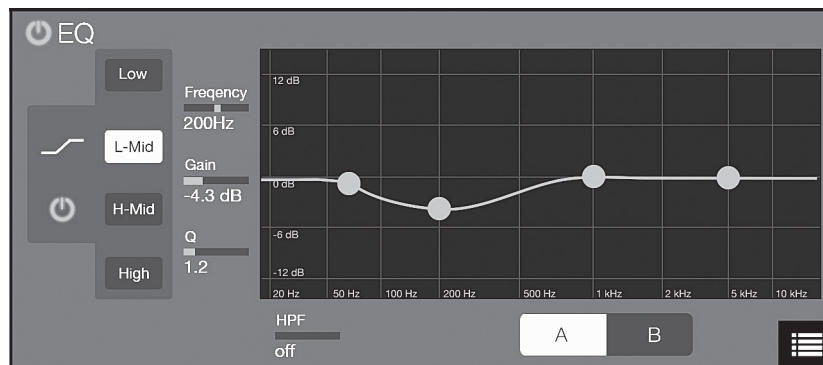

- When working on a touchscreen, touching the parameter box will open an adjustment meter under your finger. Move your finger along the meter to change the value. Remove your finger when done, and the meter will snap back to show the compact parameter box.

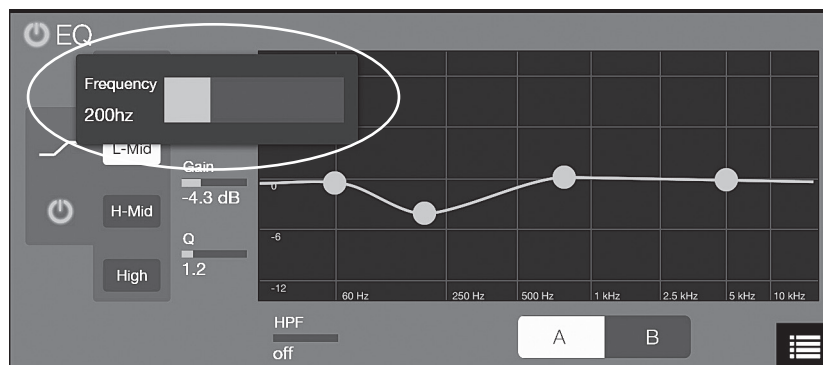

- When working with a mouse, click on the parameter box to display the adjustment meter or use the scroll wheel to adjust the value without opening the adjustment meter.

Channel and Mix Settings



In the Fat Channel view, you can open the channel options to edit the channel name and choose an input source, the channel type and icon, and stereo linking.

Channel types and icons provide a host of great benefits to your workflow. When you select a channel type, it will name your channel, display the icon type, and tag the channel type for contextual filtering of other channel options. For example, when choosing a Fat Channel preset, if the selected channel is assigned to “guitar,” the presets displayed will be filtered to only show you presets tagged for guitar, making it easier to find the preset you need. Choosing a channel type will also create automatic Filter Groups for quicker navigation and enhanced mixing workflows. Learn more about Filter Groups in the section describing the Mix selection area or in the user manual and video guides in your My PreSonus account.

For mixes, opening the settings give you access to the options for Stereo Linking mixers, changing a mix between an Aux and a Subgroup, naming the mix, and setting the output Delay for the four mixes with delay available.

4.1.4 Presets Button



This button brings up the Presets menu when working with the Fat Channel, graphic EQ, or FX bus and calls up the Complete Scenes menu when working in the Scenes/Mute Groups. For details on working with presets and scenes, please refer to the user manual and video guides in your My PreSonus account.

4.1.5 Channel Strip Area

This area displays the input channels and fader levels for the selected mix.

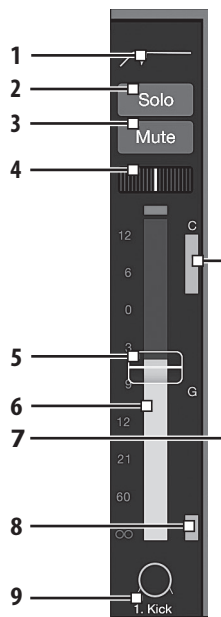

1. **EQ micro view.** Selects the associated channel and brings up the Fat Channel.
2. **Solo**
3. **Mute**
4. **Pan**
5. **Channel fader.** Controls the channel level for the selected mix.
6. **Input meter**
7. **Compressor gain-reduction meter**
8. **Gate gain-reduction meter**
9. **Channel number, name, and type icon.** Selects the associated channel and brings up the Fat Channel.

4.1.6 Flex Master Channel Strip

The Flex Master channel strip shows the master channel for the selected mix. For example, when Mix 3 is selected, the Flex Master is the main output for Mix 3.

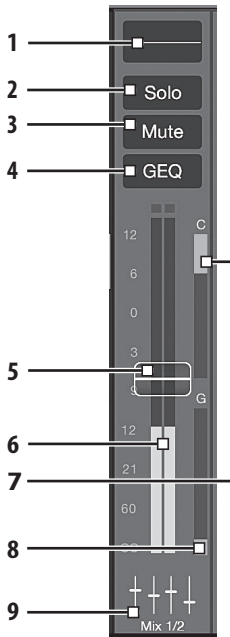

1. **EQ micro view.** Selects the associated Mix master and brings up the Fat Channel.
2. **Solo**
3. **Mute**
4. **GEQ or FX Edit.** Opens the associated graphic EQ or effects editor in the Fat Channel area.
5. **Mix fader**
6. **Output meter**
7. **Compressor gain-reduction meter**
8. **Gate gain-reduction meter**
9. **Mix number, name, and type icon.** Selects the associated Mix master and brings up the Fat Channel.

4.1.7 Mix Selection Area

This is the primary navigation area for your mixer. Here you'll select the mix that's currently being controlled by the channel faders. This is also where you'll find the settings for each mix.

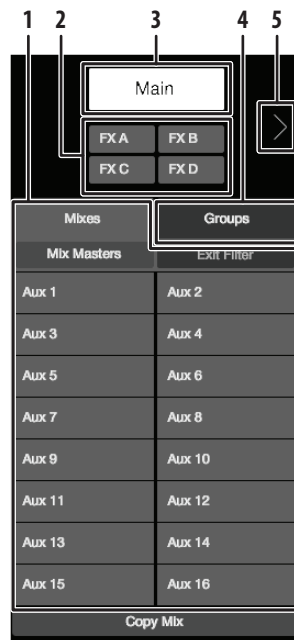

1. **Mix selection buttons**
2. **FX Mix selection buttons**
3. **Main Mix select button**
4. **Filter DCA Groups tab**
5. **Hide Main Mix Faders arrow**

Quick Access Panel

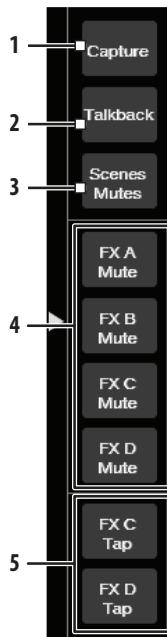

When an FX mix is selected, this area provides quick access to all FX mutes and Tap Tempo buttons for the delay effects.

1. **Capture.** Opens the remote Capture control view
2. **Talkback.** Turns Talkback on/off.
3. **Scenes/Mutes.** Displays the Quick Scenes and Mute Groups in the Fat Channel area
4. **FX Mutes.** Mute buttons for the four FX sends.
5. **FX Tap.** Tap Tempo buttons for the two delay FX.

4.1.8 Main Output Area

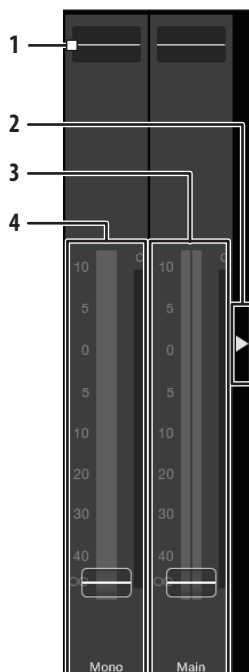

1. **EQ microview.** Selects the associated main mix and brings up the Fat Channel
2. **Quick Access Bar Arrow.** Opens the Quick Access Bar.
3. **Main Left/Right channel strip.** Displays the fader and meters for the Main Left/Right mix bus.
4. **Main Mono/Center channel strip.** Displays the fader and meter for the Main Mono mix bus.

4.1.9 Input Meter Bridge and Navigation



The Meter Bridge along the bottom the application shows the input meters for all available channels. A highlighted window shows the channels that are currently displayed in the input channel area. You can use the Meter Bridge to navigate to a specific channel by selecting the channel to “jump” the input channel view to that area or drag the highlighted window to scroll to that area. You can also swipe the input channel area to scroll through the available channel, and the highlighted window in the Meter Bridge will follow your location.

There's a lot more you can do with the battle-ready UC-Surface control application. Please refer to the user manual and video guides in your MyPreSonus account to learn more.

Added bonus: PreSonus' previously Top Secret recipe for...

Rice Dressing

Ingredients:

- 1 lb ground beef
- 1 lb chopped chicken liver
- 1 onion (diced)
- 2 green peppers (diced)
- 4-6 celery stalks (diced)
- 2 garlic cloves (minced)
- ¼ C. chopped fresh parsley
- 3 C. chicken stock
- 6 C. cooked rice
- 1 Tbs. oil
- Salt and pepper to taste
- Cayenne pepper to taste

Cooking Instructions:

1. In a large pot, heat oil on medium high and add meat, salt, and pepper to taste. Stir until meat begins to brown.
2. Lower heat and add all vegetables. Cook until onions are transparent and celery is very tender. Add stock as necessary to prevent burning.
3. Stir in cooked rice. Add remaining stock and simmer on low until ready to serve.

StudioLive™ RML-Series Mixers

Touch-Software-Controlled, Rack-mount Digital Mixing System with Active Integration™

Quick Start Guide



18011 Grand Bay Ct. • Baton Rouge,
Louisiana 70809 USA • 1-225-216-7887
www.presonus.com

Part# 825-WLV0073-A