

Sub PMIC with Dual-Output Boost Converter with I²C Interface for Flash LED and Backlight LED, Dual-Output LCD Bias and DSV

General Description

The RT4832A is an integrated total power solution for Flash LED Driver, Backlight WLED Driver, and DSV Driver. Flash LED Driver provides up to 2-CH 1.5A applications. Back Light WLED Driver supports up to 36V output for 10 WLEDs applications. And it provides 1024 steps LED current with logarithmic/linear curve. DSV is implemented by one single inductor boost and inverting charge pump, which provide customers minimum EVB area compared to dual inductors. The negative output power (CPOUT) comes from boost output (LCMOUT). It also provides DSV positive voltage (POS), which power noise is reduce by passing though LDO. Their ranges can be programmed from ±4V to ±6V per 50mV step respectively. Flash Boost Converter operates at 2MHz/4MHz frequency. The 4MHZ frequency solution allows tinny and low-profile components. Torch Mode Current can be set from 25mA to 375mA per 25mA step. And Strobe Mode Current range is from 100mA to 1.5A per 100mA step.

DSV drives TFT-LCD panels up to 10" (from SFF to MFF like tablets). These two output rails are usually connected to Source Driver IC. Wide input voltage range from 2.5V to 5.5V optimizes the single-cell battery applications (Li-Ion, Ni-Li, Li-Polymer) and which symmetrical output current is up to 80mA.

The RT4832A provides complete protection such as VIN under voltage lockout, Vin monitor protection, over current protection, over voltage protection, LED short protection, VOUT short protection and over temperature protection.

The RT4832A is available in WL-CSP-30B 2.24x2.64 (BSC) package.

Applications

- Smart Phones
- Probable Instruments

Features

- Input Voltage Range : 2.5V to 5.5V
- Internal Soft-start, UVLO, OTP, OCP
- Typical Shutdown Current : < 1μA
- -40 to 85°C Temperature Range
- 2CH Back Light LED Driver
 - ▶ Drives Up to 10 WLEDs in Two Strings
 - ▶ External PWM Pin Control and I²C Programmable 11 bit Linear and Exponential Brightness
 - ▶ LED Current Accuracy ±5% (>500μA), ±3% (>5mA)
 - ▶ I²C Programmable OVP 18/22/25/29/33/36V
- 2CH Flash LED Driver
 - ▶ Torch Mode Current from 25mA to 375mA per 25mA Step with 2 Channels
 - ▶ Strobe Mode Current from 100mA to 1.5A per 100mA Step with 2 Channels
 - ▶ I²C Programmable Flash Safety Timer from 32ms to 1024ms per 32ms Step
 - ▶ High Accurate Safety Timer ±10%, Current Accuracy ±4% (>375mA), Current Matching ±7% (>375mA)
 - ▶ VIN Monitor Protection from 2.5V to 3.2V per 0.1V Step
 - ▶ Selectable Input Current Limit 1.9/2.8A
 - ▶ 2MHz/4MHz Switching Frequency for Flash LED
 - ▶ Flash LED1/2 Short Protection, and Output Short Protection
 - ▶ Txmask Protection by Independent Pin
- DSV
 - ▶ I²C Programmable Output Voltages
 - ▶ Flexible Boost Voltage, POS, CPOUT Default Setting
 - ▶ Regulated Voltage Output : 4V to 6V per 50mV Step
 - ▶ Positive Voltage Output : 4 to 6V per 50mv Step
 - ▶ Negative Voltage Output : -4 to -6V per 50mV Step
 - ▶ User Selectable Output Fast Discharge Mode or

Float Mode when Turned Off

- ▶ Independent Positive and Negative Enable Control by Two External Pins
- ▶ True Load Disconnect, OCP, and Positive/Negative SCP Function

Marking Information

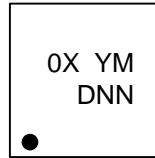

0X : Product Code
YMDNN : Date Code

Ordering Information

RT4832A □
Package Type
WSC : WL-CSP-30B 2.24x2.64 (BSC)

Note :

Richtek products are :

- ▶ RoHS compliant and compatible with the current requirements of IPC/JEDEC J-STD-020.
- ▶ Suitable for use in SnPb or Pb-free soldering processes.

Pin Configuration

(TOP VIEW)

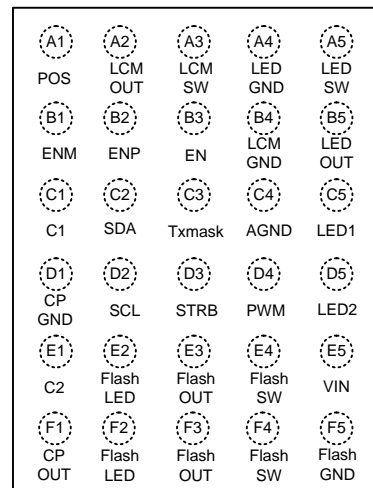

WL-CSP-30B 2.24x2.64 (BSC)

Typical Application Circuit

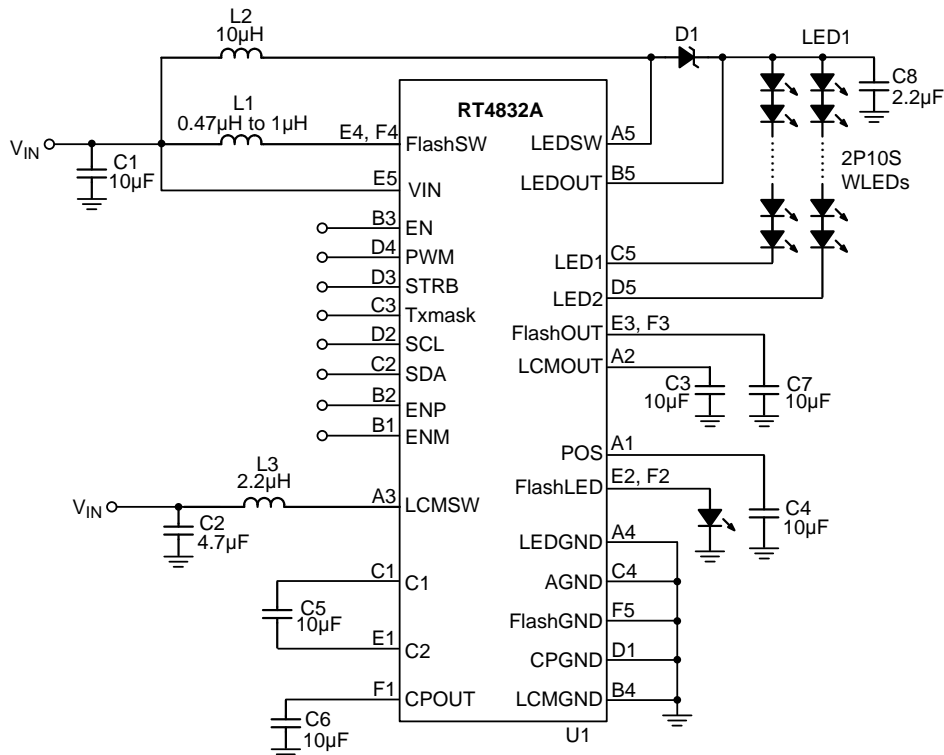

Reference	Part Number	Value	Description
C1, C3, C4, C5, C6, C7	C2012X7R1A106KT0AHE	10 μ F/10V/X5R	Ceramic capacitor
C2	C2012X7R1A475KT0AHE	4.7 μ F/10V/X5R	Ceramic capacitor
C8	UMK316BJ225KD-T	2.2 μ F/50V/X7R	Ceramic capacitor
L1	NR4018T1R0N	1 μ H	Inductor
L2	NR4018T100M	10 μ H	Inductor
L3	NR4018T2R2M	2.2 μ H	Inductor
D1	SS14	40V/1A	Schottky diode

Timing Diagram

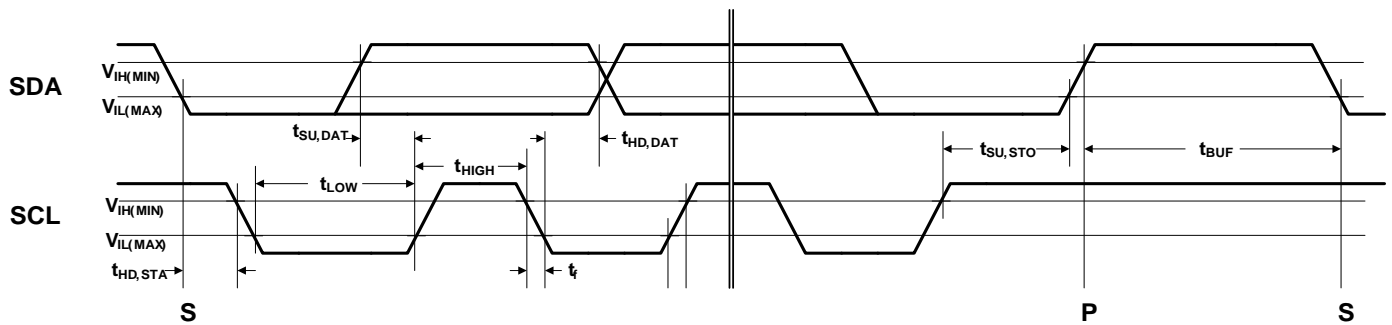

Functional Pin Description

Pin No.	Pin Name	Pin Function
A1	POS	Positive terminal LDO output. Connect a 10 μ F ceramic capacitor between this pin and Ground.
A2	LCMOUT	DSV boost converter output pin. Connect a 10 μ F ceramic capacitor between this pin and Ground.
A3	LCMSW	Switching node of DSV boost converter. Connect a 2.2 μ H inductor between LCMSW and VIN.
A4	LEDGND	Back light LED ground.
A5	LEDSW	Switch node of boost converter. Connect a 4.7 μ H to 10 μ H inductor between LEDSW and VIN.
B1	ENM	Enable the CPOUT.
B2	ENP	Enable the POS.
B3	EN	Chip enable.
B4	LCMGND	DSV boost converter ground pin.
B5	LEDOUT	Back light LED boost output pin.
C1	C1	Fly capacitor 1 positive connection of inverter charge pump.
C2	SDA	I ² C serial data input/output. An external pull-up resistor is required.
C3	Txmask	Configurable power amplifier synchronization input or configurable active high torch enable. Has an internal pull-down resistor of 400k Ω between TX and ground.
C4	AGND	Analog ground.
C5	LED1	Single output 1 for backlight LED.
D1	CPGND	Inverter charge pump ground.
D2	SCL	I ² C serial clock input. An external pull-up resistor is required.
D3	STRB	Active high hardware flash enable. Drive STRB high to turn on flash pulse. Has an internal pull-down resistor of 400k Ω between STRB and ground.
D4	PWM	PWM dimming input for backlight LED.
D5	LED2	Single output 2 for backlight LED.
E1	C2	Fly capacitor 1 negative connection of inverter charge pump. Connect a 10 μ F ceramic capacitor between this pin and C1.
E2, F2	FlashLED	High-side current source output for flash LED.
E3, F3	FlashOUT	Step-up flash DC-DC converter output. Connect a 10 μ F ceramic capacitor between this pin and Ground.
E4, F4	FlashSW	Drain connection for internal N-MOSFET and synchronous P-MOSFET switches. Connect a 0.47 to 1 μ H inductor between FlashSW and VIN.
E5	VIN	Input voltage connection. Connect VIN to the input supply, and bypass to Ground with a 10 μ F or larger ceramic capacitor.
F1	CPOUT	Charge pump negative terminal output. Connect a 10 μ F ceramic capacitor between this pin and ground.
F5	FlashGND	Flash boost power ground.

Functional Block Diagram

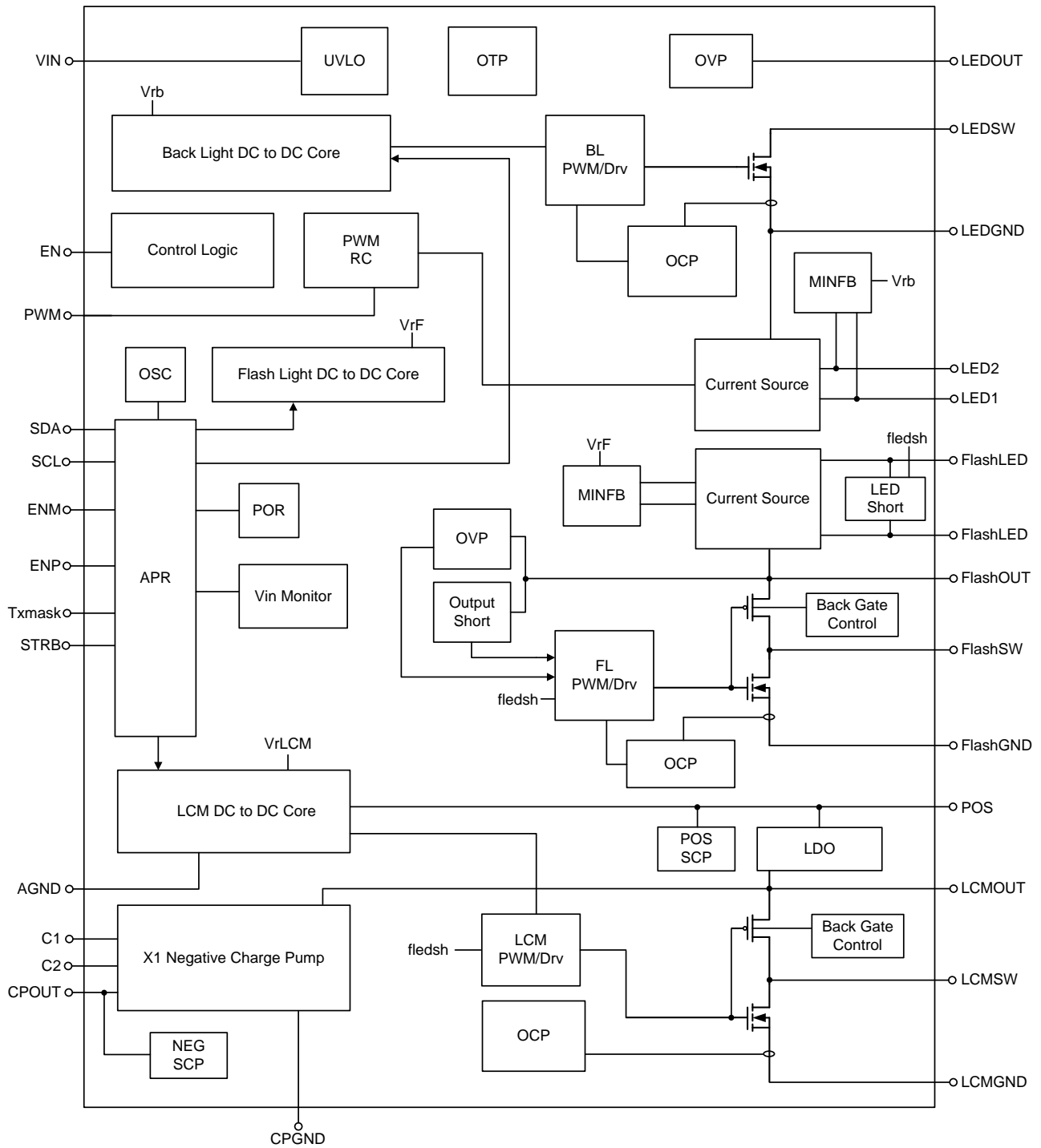

Absolute Maximum Ratings (Note 1)

- Supply Voltage (VIN) ----- -0.3V to 6V
- LED Boost Output Voltage (LEDOUT) ----- -0.3V to 37V
- LED Switching Voltage (LEDSW) ----- -0.3V to 37V
- LED Current Source Voltage (LED1, LED2) ----- -0.3V to 36V
- LCM Boost Output Voltage (LCMOUT, POS) ----- -0.3V to 6.3V
- LCM Switching Voltage (LCMSW, C1) ----- -0.3V to 6.3V
- Negative Charge Pump Switching Voltage (C2) ----- 0.3V to -6.5V
- Negative Charge Pump Voltage (CPOUT) ----- 0.3V to -6.5V
- Flash Switching Voltage (FlashSW) ----- -0.3V to 6V
- Flash Output Voltage (FlashOUT) ----- -0.3V to 6V
- Flash LED Voltage (FlashLED) ----- -0.3V to 6V
- Digital Clock Control Pins (SDA, SCL, PWM) ----- -0.3V to 6V
- Other Pins (EN, ENM, ENP, Txmask, STRB) ----- -0.3V to 6V
- Power Dissipation, P_D @ $T_A = 25^\circ\text{C}$
 WL-CSP-30B 2.24x2.64 (BSC) ----- 3.15W
- Package Thermal Resistance (Note 2)
 WL-CSP-30B 2.24x2.64 (BSC), θ_{JA} ----- 31.7°C/W
- Lead Temperature (Soldering, 10 sec.) ----- 260°C
- Junction Temperature ----- 150°C
- Storage Temperature Range ----- -65°C to 150°C
- ESD Susceptibility (Note 3)
 HBM (Human Body Model) ----- 2kV

Recommended Operating Conditions (Note 4)

- Supply Voltage, VIN ----- 2.5V to 5.5V
- Ambient Temperature Range ----- -40°C to 85°C
- Junction Temperature Range ----- -40°C to 125°C

Electrical Characteristics

($V_{IN} = 3.6\text{V}$, $C_{VIN} = 10\mu\text{F}$, $T_A = 25^\circ\text{C}$, unless otherwise specified)

Parameter	Symbol	Test Conditions	Min	Typ	Max	Unit
Power Supply						
Input Voltage Range	V_{IN}		2.5	--	5.5	V
UVLO	UV	V_{IN} falls	--	2.2	2.3	V
UVLO Hysteresis Voltage	UVhys	V_{IN} rises after UVLO	30	50	200	mV
VIN Supply Current	I_Q	LCD Bias enable, Back Light turned off, EN = H, LCMOUT = 5.2V	--	0.5	--	mA
VIN Shutdown Current	I_{SHDN}	$V_{IN} = 5\text{V}$, EN = L	--	1	--	μA
Thermal Shutdown	T_{SD}		--	145	--	$^\circ\text{C}$

Parameter	Symbol	Test Conditions	Min	Typ	Max	Unit
Thermal Shutdown Hysteresis	T _{SDHYS}		--	15	--	°C
Flash LED						
Accuracy of Flash Output Current 1/2	AIFL1	I _{FLED} > 375mA	-4	--	4	%
	AIFL2	I _{FLED} = 25mA to 375mA	-10	--	10	
FLED Sense Voltage 1/2	V _{DSFL}	FlashOUT – FlashLED, I _{FLED} = 750mA (per channel)	--	300	--	mv
Flash 1/2 Start-up Current	I _{FLST}	FlashOUT = 3.6V, FlashLED to Ground (per channel)	2	2.5	4	mA
Flash Pre-charge Current	I _{FLPRE}	FlashOUT = V _{IN} – 0.15V	40	150	300	mA
Flash Switching Frequency	f _{FOSC}	0x07[7:6] = 01	1.8	2	2.2	MHz
Safety Timeout	t _{OUT}	0x07[4:0] = 10000, Strb goes high until 0x0B[1] = 0→1	460	512	563	ms
Maximum Duty Cycle	D _{maxFL}	0x07[6] = 01	--	70	--	%
Flash N-MOSFET Ron	R _{onFLN}		20	65	130	mΩ
Flash P-MOSFET Ron	R _{onFLP}	FlashOUT = 3.6V	20	80	160	mΩ
Flash N-MOSFET Current Limit	I _{OCPL}	0x07[5] = 1	2.24	2.8	3.36	A
VIN Monitor Voltage	V _{MON}	V _{IN} falls until 0x0B[4] = 0→1, 0x08[2:0] = 100, 0x09[0] = 1	2.82	2.9	2.98	V
VIN Monitor Hysteresis Voltage	V _{MONhys}	V _{IN} rises until 0x0B[4] = 1→0, 0x08[2:0] = 100, 0x09[0] = 1	1	5	--	%
Flash Output Short Voltage	V _{FLSH}	FlashOUT < 1.5V for 1msec, 0x0B[5] = 0→1	0	--	1.5	V
Flash LED 1/2 Short Voltage	V _{FLEDSh}	FlashLED < 1.5V for 1msec, 0x0B[2] = 0→1 (per channel)	0	--	1.5	V
Flash Over Voltage Protection	V _{FLOVP}	FlashOUT > V _{IN} , 0x0B[6] = 0→1	5	5.3	5.6	V
Back Light LED						
Accuracy of Back Light Output Current 1/2	AIBL1	I _{BLED} = 5mA to 25mA	-3	--	3	%
	AIBL2	I _{BLED} = 0.5mA to 5mA	-5	--	5	
Matching of Output Current	MIBL	I _{BLED} = 5mA to 25mA	-3	--	3	%
BLED Sense Voltage 1/2	V _{DSBL}	V _{IN} = 3V, I _{FBx} = 25mA	--	500	--	mV
Back Light Switching Frequency	f _{blosc}	0x03[7] = 1	0.9	1	1.1	MHz
Maximum Duty Cycle	D _{maxBL}	0x03[7] = 1	90	93	--	%
Back Light N-MOSFET Ron	R _{onBLN}		100	270	400	mΩ
Back Light Current Limit	I _{OCPL}		0.96	1.2	1.44	A
Back Light Over Voltage Protection	V _{BLOVP}	0x02[7:5] = 001	21	22	23	V
DSV						
Accuracy of POS Voltage	V _{POS}	0x0E[5:0] = 010100, I _{OUT} = 0mA	-1	--	1	%
Accuracy of CPOUT	V _{CPOUT}	0x0F[5:0] = 010100, I _{OUT} = 0mA	-1.5	--	1.5	%
Drop-Out Voltage	V _{DO}	V _{LCMOUT} = V _{POS} = 5.2V, I _{OUT} = 50mA	--	100	--	mV

Parameter	Symbol	Test Conditions	Min	Typ	Max	Unit
DSV Switching Frequency	f _{DSV}		0.9	1	1.1	MHz
Maximum Duty Cycle	DMXDSV		90	93	--	%
DSV N-MOSFET Ron	R _{onNDSV}		0.05	0.3	0.6	Ω
DSV P-MOSFET Ron	R _{onPDSV}	0x0F[5:0] = 010100	0.05	0.5	1	Ω
Charge Pump Equivalent Resistance	Req _{x1}	V _{LCMOUT} = 5.2V, I _{OUT} = 50mA	--	2	--	Ω
VPOS Discharge Resistor	R _{DP}	0x0C[4] = 1	--	70	--	Ω
VCPOUT Discharge Resistor	R _{DN}	0x0C[3] = 1	--	20	--	Ω
LCMOUT Current Limit	I _{OCPLCM}	0x0E[5:0] = 010100	0.88	1.1	1.32	A
POS Short Protection Voltage	V _{SCPP}		--	0.8 x V _{POS}	--	V
CPOUT Short Protection Voltage	V _{SCPN}		--	0.25 – 0.8 x (-V _{CP OUT})	--	V
Logic Control (PWM, EN, ENP, ENM, SCL, SDA, TXMASK, STRB)						
Input Logic Low	V _{IL}		--	--	0.4	V
Input Logic High	V _{IH}		1.4	--	--	V

Note 1. Stresses beyond those listed “Absolute Maximum Ratings” may cause permanent damage to the device. These are stress ratings only, and functional operation of the device at these or any other conditions beyond those indicated in the operational sections of the specifications is not implied. Exposure to absolute maximum rating conditions may affect device reliability.

Note 2. θ_{JA} is measured under natural convection (still air) at T_A = 25°C with the component mounted on a high effective-thermal-conductivity four-layer test board on a JEDEC 51-7 thermal measurement standard.

Note 3. Devices are ESD sensitive. Handling precaution recommended.

Note 4. The device is not guaranteed to function outside its operating conditions.

Typical Operating Characteristics

DSV Power On

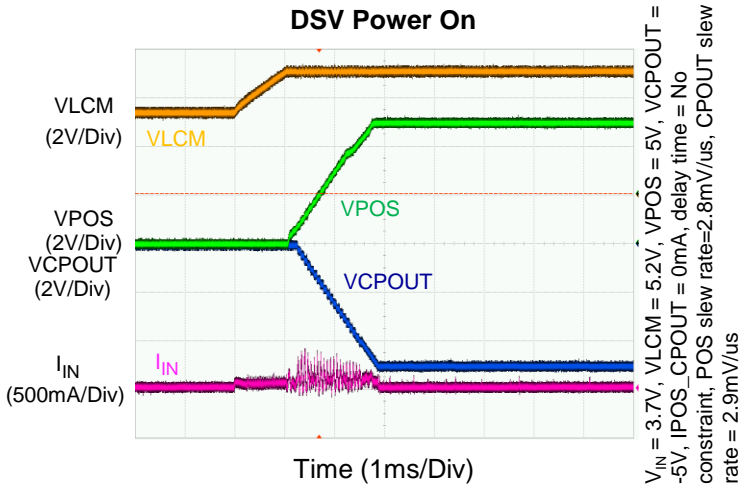

DSV Power off with Discharge

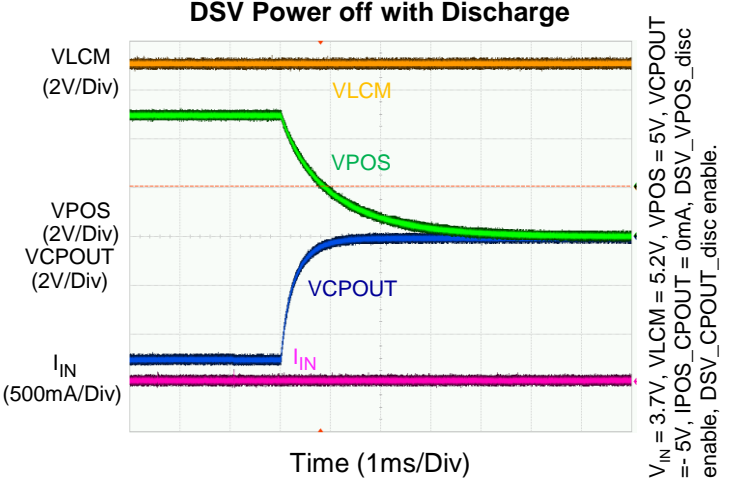

DSV Load Transient

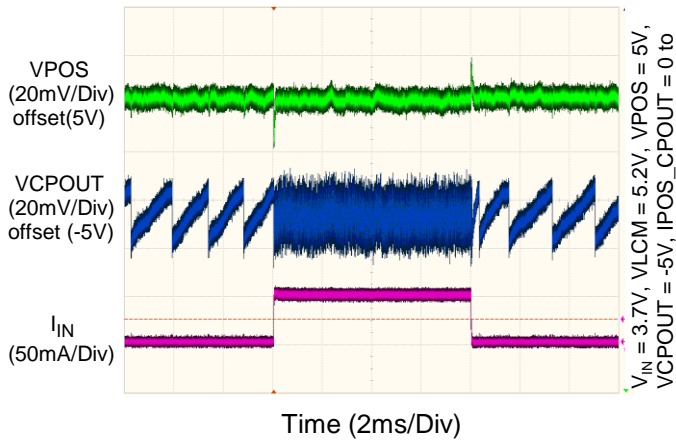

DSV Ripple 0mA

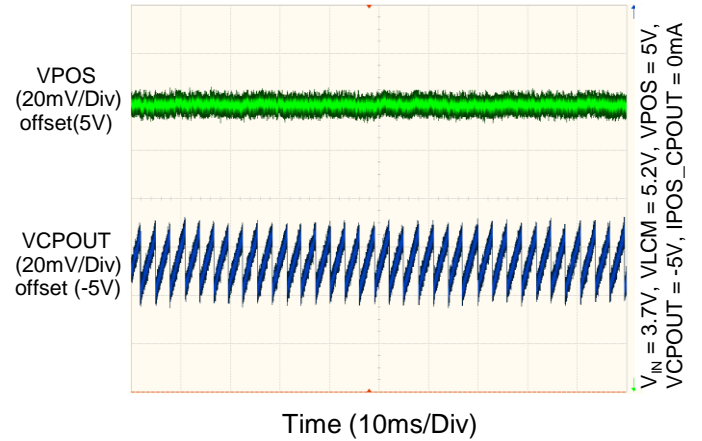

DSV Ripple 50mA

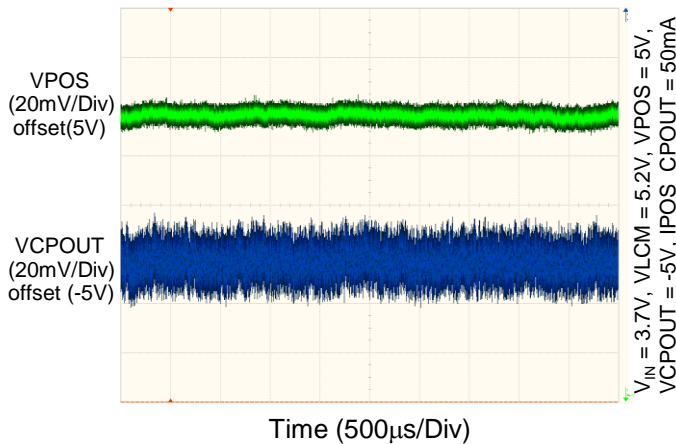

DSV Accuracy_POS

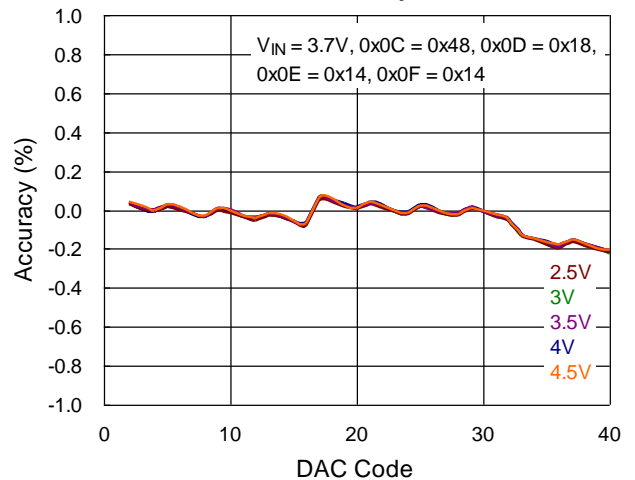

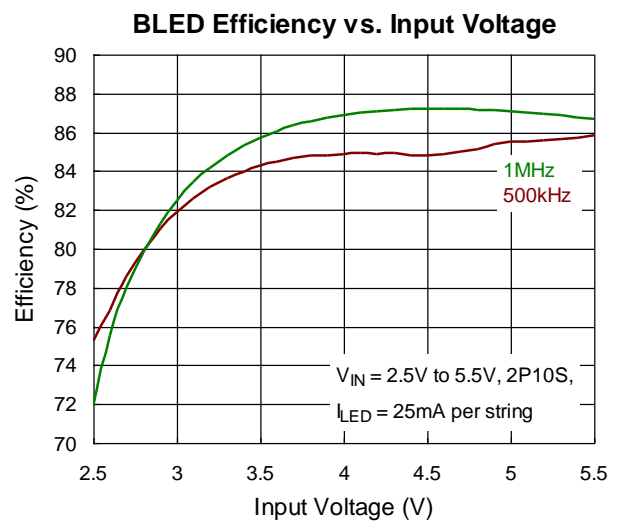
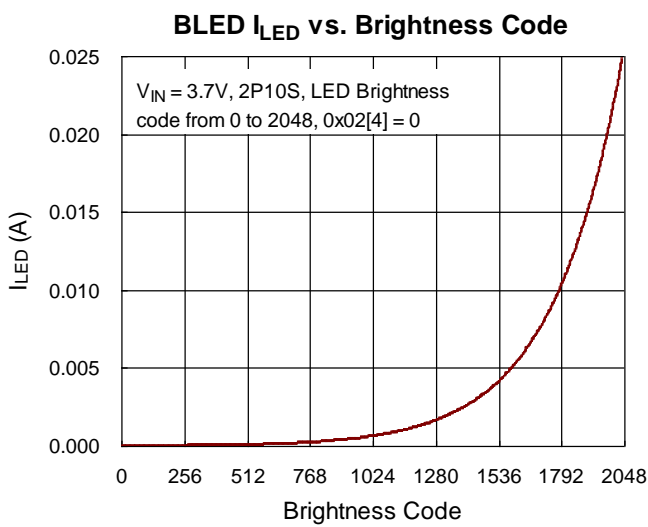
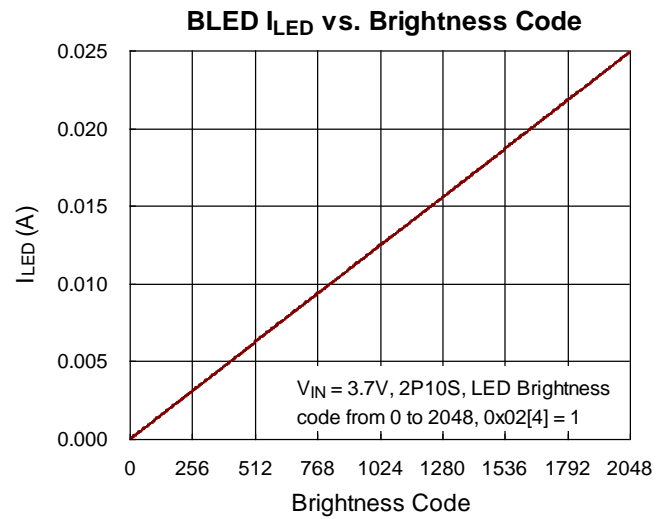
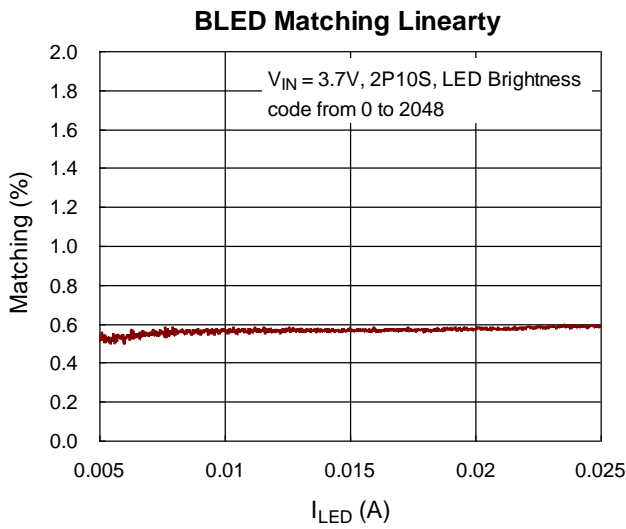
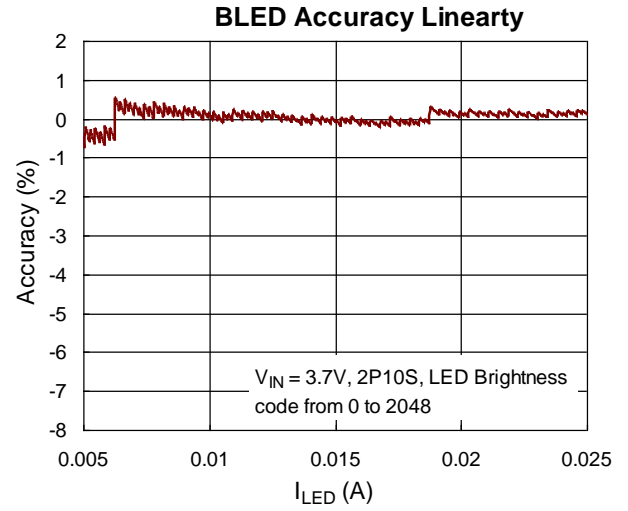
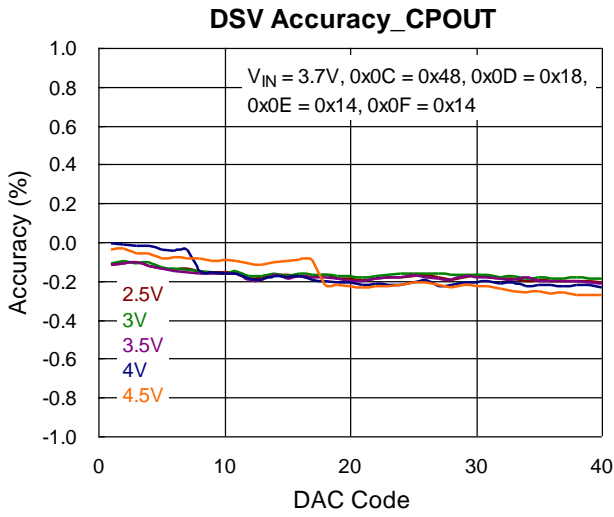

BLED Line Transient

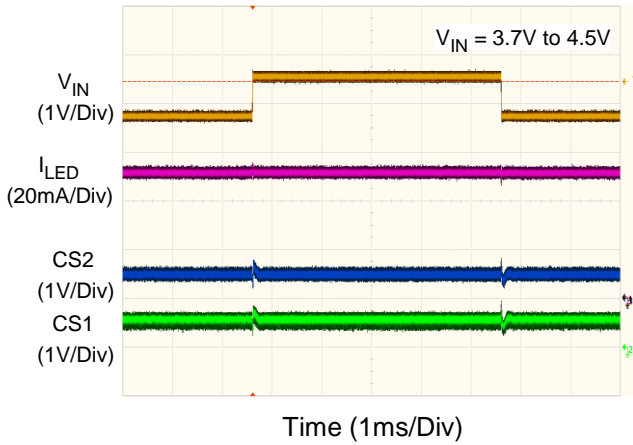

Txmask

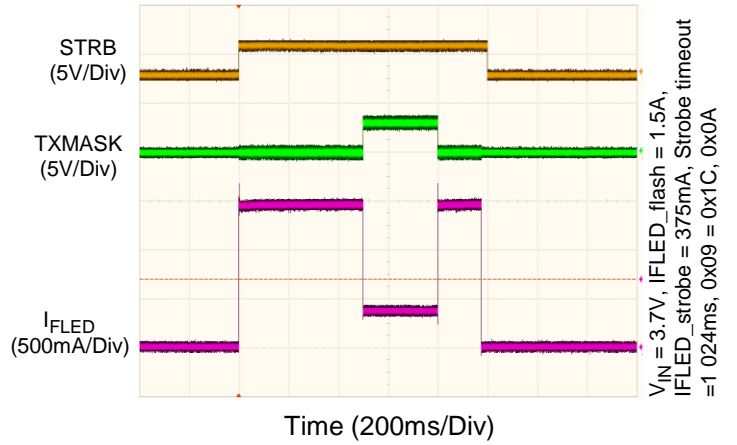

Register Map

RT4832A IC slave address = 7'b 0010001. I²C interface supports fast mode (bit rate up to 400kb/s).

Address	Address Name	BIT	R/W	Default (Reset Value)	Description
0x01	Vendor Code	1:0	R	10	10 RICHTEK
0x02	BLED OVP	7:5	R/W	001	[000] = 18V, [001] = 22V, [010] = 25V, [011] = 29V, [100] = 33V, [101 to 111] = 36V
	BLED Mapping Code	4	R/W	1	[0] = Exponential, [1] = Linear.
	BLED PWM Config.	3	R/W	0	[0] = Active High, [1] = Active Low.
	Reserved	2:0	R/W	000	
0x03	BL SW Frequency	7	R/W	0	[0] = 500kHz, [1] = 1MHz
	BL Ramp Rate	6:3	R/W	0011	[0000] = 0μs, [0001] = 500μs, [0010] = 750μs, [0011] = 1ms, [0100] = 2ms, [0101] = 5ms, [0110] = 10ms, [0111] = 20ms, [1000] = 50ms, [1001] = 100ms, [1010] = 250ms, [1011] = 800ms, [1100] = 1s, [1101] = 2s, [1110] = 4s, [1111] = 8s
	Reserved	2:1	R/W	00	
	Bled11th	0	R/W	1	11 th bit enable of bled brightness control [0] = 10 bit brightness control, reg0x40[1] is MSB, reg0x04[2] is ignore. [1] = 11 bit brightness control, reg0x40[2] is MSB.
0x04	Reserved	7:3	R/W	00000	
	11 th LSB	2	R/W	1	
	BLED Brightness MSB	1:0	R/W	11	1024 steps, MSB
0x05	BLED Brightness LSB	7:0	R/W	11111111	1024 steps, LSB
0x06	FLED LED1/2 Torch Current	7:4	R/W	0011	[0000] = 25mA, [0001] = 50mA, [0010] = 75mA, [0011] = 100mA, [0100] = 125mA, [0101] = 150mA, [0110] = 175mA, [0111] = 200mA, [1000] = 225mA, [1001] = 250mA, [1010] = 275mA, [1011] = 300mA, [1100] = 325mA, [1101] = 350mA, [1110 to 1111] = 375mA
	FLED LED1/2 Strobe Current	3:0	R/W	1110	[0000] = 100mA, [0001] = 200mA, [0010] = 300mA, [0011] = 400mA, [0100] = 500mA, [0101] = 600mA, [0110] = 700mA, [0111] = 800mA, [1000] = 900mA, [1001] = 1000mA, [1010] = 1100mA, [1011] = 1200mA, [1100] = 1300mA, [1101] = 1400mA, [1110 to 1111] = 1500mA

Address	Address Name	BIT	R/W	Default (Reset Value)	Description
0x07	FLED SW Freq.	7:6	R/W	00	[00] = 4MHz, [01] = 2MHz
	FL Current Limit	5	R/W	1	[0] = 1.9A, [1] = 2.8A
	FL Strobe Timeout	4:0	R/W	01111	[00000] = 32ms [01111] = 512ms [11111] = 1024ms, each step = 32ms
0x08	dsv_periodic_mode	7	R/W	0	DSV periodic mode [0] = always on if DSV is enable, [1] = DSV periodic mode
	dsv_freq_pm	6	R/W	0	[0] = 20Hz, [1] = 33Hz
	dsv_en_mode	5	R/W	0	[0] = turn on DSV only if EN = 1, [1] = turn on DSV only if (EN+ENP+ENM) = 1
	Reserved	4	R/W	0	--
	fla_ovp_sden	3	R/W	1	Flash OVP shutdown enable [0]=Report only, [1] = OVP Shutdown
	FLED VIN Monitor	2:0	R/W	100	[000] = 2.5V, [001] = 2.6V, [010] = 2.7V, [011] = 2.8V, [100] = 2.9V, [101] = 3V, [110] = 3.1V, [111] = 3.2V
0x09	Rst_sw_all	7	WC	0	Software reset [0] = Disable, [1] = Reset
	PWM Enable	6	R/W	0	[0] = PWM Ignored, [1] = PWM Enable
	dsv_ext_en	5	R/W	0	DSV external control enable [0] I ² C control, [1] external pin control
	Strobe Enable	4	R/W	0	[0] = I ² C Flash, [1] = Strobe Flash
	Tx Polarity	3	R/W	1	[0] = Active Low, [1] = Active High
	Tx Enable	2	R/W	0	[0] = Tx Ignored, [1] = Tx Enabled
	VIN Monitor Mode	1	R/W	1	[0] = Torch, [1] = Standby
	VIN Monitor En	0	R/W	0	[0] = Disable, [1] = VIN Monitor Enabled
0x0A	Rst_sw	7	WC	0	Software reset [0] = Disable, [1] = Reset excluding DSV
	Fla_ch2_enb	6	R/W	0	[0] = FLASH channel2 enable, [1] = FLASH channel2 disable
	BL OVP Disable	5	R/W	0	[0] = Report only, [1] = OVP Shutdown
	BLED1 En	4	R/W	0	[0] = Disable, [1] = Enable
	BLED2 En	3	R/W	0	[0] = Disable, [1] = Enable
	Torch/Flash	2	R/W	0	[0] = Torch, [1] = Flash
	Flash Enable	1	R/W	0	[0] = Off, [1] = Enable Flash
	Back Light Enable	0	R/W	0	[0] = Off, [1] = Enable Back Light
0x0B	Back Light OVP	7	R	0	[0] = Normal, [1] = Fault
	Flash OVP	6	R	0	[0] = Normal, [1] = Fault
	Flash Output Short	5	R	0	[0] = Normal, [1] = Fault
	VIN Monitor	4	R	0	[0] = Normal, [1] = VIN Monitor Threshold Crossed
	Tx Interrupt	3	R	0	[0] = Normal, [1] = Tx Event Occurs
	FLED1/2 Short	2	R	0	[0] = Normal, [1] = Fault
	Flash Timeout	1	R	0	[0] = Normal, [1] = Time out
	Thermal Shutdown	0	R	0	[0] = Normal, [1] = Fault

Address	Address Name	BIT	R/W	Default (Reset Value)	Description
0x0C	pwr_sav	7	R/W	0	Power saving mode, [0] = Disable, [1] = Enable
	DSV_VPOS_en	6	R/W	0	DSV VPOS enable, [0] = Disable, [1] = Enable
	DSV_VPOS_gnd	5	R/W	1	DSV VPOS Ground, [0] = Floating, [1] = Grounding only function when VPOS is disable
	DSV_VPOS_disc	4	R/W	0	DSV VPOS discharge 20ms when shutdown, [0] = Disable, [1] = Enable
	DSV_VCPOUT_en	3	R/W	0	DSV VCPOUT enable, [0] = Disable, [1] = Enable
	DSV_VCPOUT_gnd	2	R/W	1	DSV VCPOUT Ground, [0] = Floating, [1] = Grounding only function when VCPOUT is disable
	DSV_VCPOUT_disc	1	R/W	0	DSV VCPOUT discharge 20ms when shutdown, [0] = Disable, [1] = Enable
	DSV_Startup	0	R/W	0	DSV startup mode [0] = closed loop, waiting 80% [1] = open loop, go after soft-start dimming
0x0D	DSV_delay	7:6	R/W	00	DSV delay time between VPOS and VCPOUT [00] = No constraint [01] = 1ms [10] = 2ms [11] = 5ms
	Vboost Voltage	5:0	R/W	101000	[000000] = 4V [010100] = 5V [101011] = 6.15V (0.05V per step)
0x0E	DSV_VPOS_slew	7:6	R/W	01	VPOS rising slew rate control [00] = 8.5mV/μs [01] = 5.6mV/μs, [10] = 4.6mV/μs [11] = 2.8mV/μs
	VPOS Voltage	5:0	R/W	011110	[000000] = 4V [011110] = 5.5V [101000] = 6V (0.05V per step)
0x0F	DSV_VCPOUT_slew	7:6	R/W	10	VCPOUT falling slew rate control [00] = 9.9mV/μs [01] = 6.2mV/μs, [10] = 4.9mV/μs [11] = 2.9mV/μs
	VCPOUT Voltage	5:0	R/W	011100	[000000] = -4V [011100] = -5.4V [101000] = -6V (0.05V per step)

Address	Address Name	BIT	R/W	Default (Reset Value)	Description
0x10	Reserved	7	R	0	[0] = Normal, [1] = Fault
	VPOS_SCP	6	R	0	[0] = Normal, [1] = Fault
	VCPOUT_SCP	5	R	0	[0] = Normal, [1] = Fault
	LCMOUT OCP	4	R	0	[0] = Normal, [1] = Fault
	VPOS OCP	3	R	0	[0] = Normal, [1] = Fault
	VCPOUT OCP	2	R	0	[0] = Normal, [1] = Fault
	Flash OCP	1	R	0	[0] = Normal, [1] = Fault
	Back Light OCP	0	R	0	[0] = Normal, [1] = Fault

Application Information

I²C

I²C Write Control

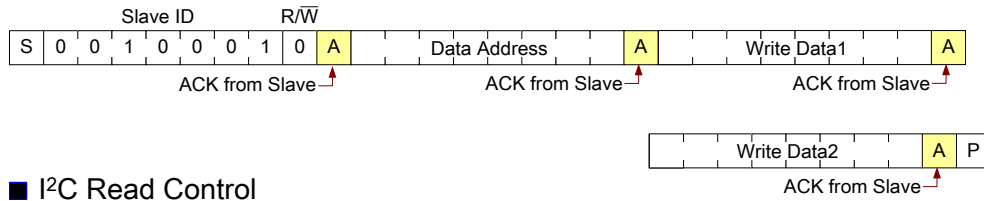

I²C Read Control

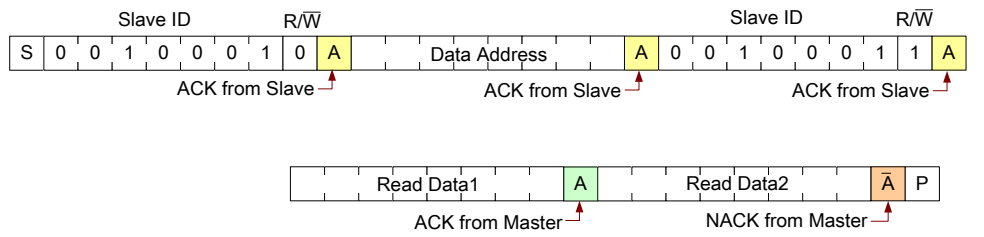

DSV

The RT4832A provides programmable LCMOUT, POS, CPOUT value. Table 1 contains the detail for DSV operation setting. The LCMOUT should be selected to provide enough headroom for good ripple and load transient performance. The headroom voltage between LCMOUT and the maximum value of VPOS and

|VCPOUT| should be higher than 150mV for good performance but the headroom voltage between LCMOUT and |VCPOUT| should not be higher than 200mV to avoid the larger ripple at VCPOUT.

The OCP level of POS is 250mA and CPOUT is 150mA typically.

Table 1. DSV Operation Setting

Channel	Range	Step	Register	Default Value	Suggest Setting
LCMOUT	4V to 6.15V	50mV/LSB	0x0D[5:0]	6V	5.7V
VPOS	4V to 6V	50mV/LSB	0x0E[5:0]	5.5V	5.5V
CPOUT	-4V to -6V	50mV/LSB	0x0F[5:0]	-5.4V	-5.5V

The DSV can be controlled either by pins or register bits. Table 2 is the DSV operation control table.

Table 2. DSV Operation Control Table

EN pin	ENP pin	ENM pin	Dsv_ext_en 0x09[5]	DSV_vpos_en 0x0C[6]	DSV_vneg_en 0x0C[3]	Status
0	X	X	X	X	X	Shutdown
1	X	X	0	0	0	Standby
1	0	0	1	X	X	Standby
1	X	X	0	1	0	VPOS enable
1	X	X	0	0	1	VNEG enable
1	X	X	0	1	1	VPOS & VNEG enable
1	1	0	1	X	X	VPOS enable
1	0	1	1	X	X	VNEG enable
1	1	1	1	X	X	VPOS & VNEG enable

Discharge and Short to GND Function

The RT4832A provides internal switch resistor to discharge voltage of VPOS and CPOUT during the channel power off. Set the 0x0C[4] = 1 for VPOS discharge enable and 0x0C[1]=1 for CPOUT discharge enable. When the voltage discharge to GND, set the 0x0C[5] = 1 and 0x0C[2] = 1 will keep the output connect to GND.

Power Saving Mode

The RT4832A provides the power saving mode to bypass the input voltage to VPOS. Enable the 0x0C[7]

= 1 to control the high side switch of boost converter and the LDO fully turn on to save the quiescent current and switching current. The POS is equal to Vin and CPOUT is equal to -Vin when power saving mode.

Delay Time Control of POS & CPOUT

The RT4832A provides the delay time control between POS and CPOUT power on and off. The bits of the 0x0D[7:6] is used to set the delay time. Table 3 and Figure 2 shows the delay time and the sequence for DSV power on and off.

Table 3. DSV Delay Time Control Table

0x0D[7:6]	Delay time	Power on	Power off
00	No constraint	POS start ramp up when ENP = H or dsv_vpos_en = 1, CPOUT start ramp down when ENM = H or dsv_vcpout_en = 1.	CPOUT start discharge when ENM = L or dsv_vcpout_en = 0, POS start discharge when ENP = L or dsv_vpos_en = 0.
01	1ms	POS start ramp up when ENP = H or dsv_vpos_en = 1 CPOUT start ramp down after POS ramp up to target and delay 1ms even the ENM = H or dsv_vcpout_en = 1	CPOUT start discharge when ENM = L or dsv_vcpout_en = 0 POS start discharge after CPOUT discharge to GND and delay 1ms even the ENP = L or dsv_vpos_en = 0
10	2ms	POS start ramp up when ENP = H or dsv_vpos_en = 1 CPOUT start ramp down after POS ramp up to target and delay 2ms even the ENM = H or dsv_vcpout_en = 1	CPOUT start discharge to GND when ENM = L or dsv_vcpout_en = 0 POS start discharge after CPOUT discharge to GND and delay 2ms even the ENP = L or dsv_vpos_en = 0
11	5ms	POS start ramp up when ENP = H or dsv_vpos_en = 1 CPOUT start ramp down after POS ramp up to target and delay 5ms even the ENM = H or dsv_vcpout_en = 1	CPOUT start discharge when ENM = L or dsv_vcpout_en = 0 POS start discharge after CPOUT discharge to GND and delay 5ms even the ENP = L or dsv_vpos_en = 0

Periodic Mode

The RT4832A supports the DSV periodic mode with the enable bit 0x08[7] and frequency select bit 0x08[6].

In the periodic mode, the enable channel of the POS and CPOUT repeat on/off. The delay time, slew rate, discharge and GND connect follow the register setting.

Table 4. Periodic Mode Control Table

dsv_periodic_mode 0x08[7]	dsv_freq_pm 0x08[6]	ton (ms)	tperiod (ms)
0	0	X	X
0	1	X	X
1	0	2	50
1	1	1.6	30

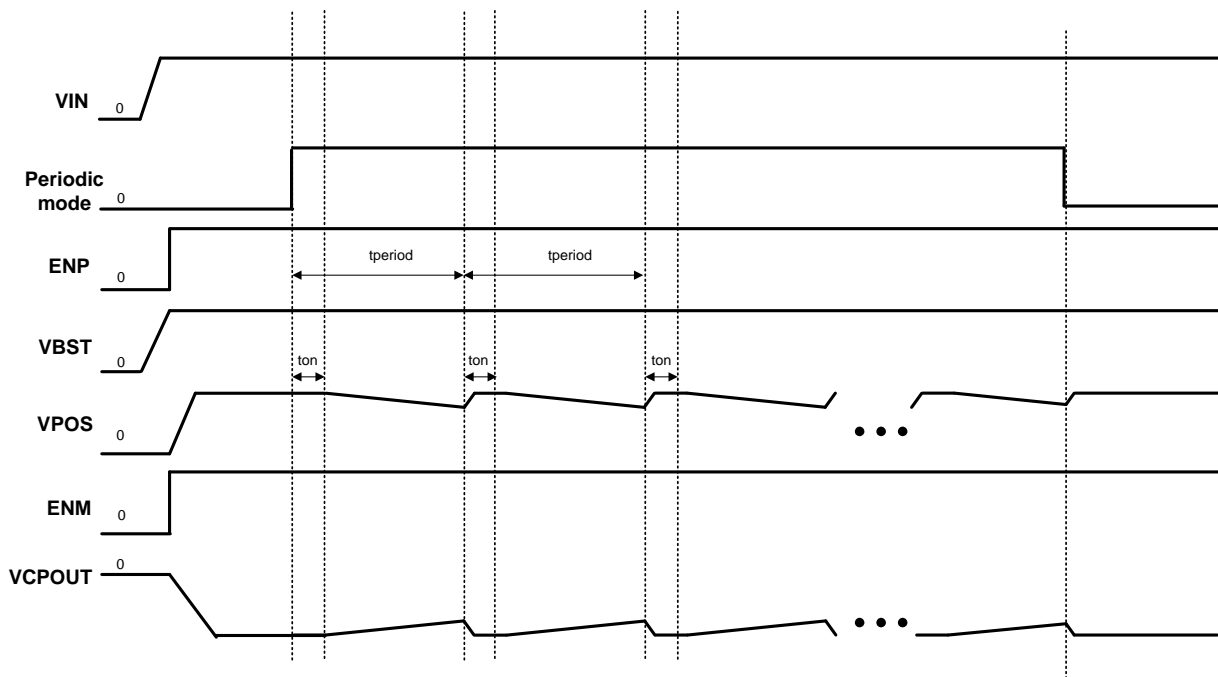

Figure 3. Periodic Mode Control

Backlight LED

The RT4832A provides brightness controllable backlight LED for maximum 2P10S application. The LED current be set via register and external PWM pin. Each channel can be control by enable bits (LED1 in register 0x0A [4] and LED2 in register 0x0A [3]). The ramp time from one brightness current to another current can be adjusted from 0ms to 8000ms in the register 0x03[6:3]. There are two different ways to map

the brightness code (or PWM duty cycle) to the LED current: linear and exponential mapping.

The RT4832A LED serial number depends on the minimum voltage of the battery and the forward voltage(VF) of the LED. If the minimum voltage is 2.7V and the VF of the backlight LED is 3.2V, the maximum number of each string is 8.

Table 5. BLED Operation Control Table

Back Light Enable 0x0A[0]	BLED1 En 0x0A[4]	BLED2 En 0x0A[3]	PWM Enable 0x09[6]	PWM pin	Status
0	X	X	X	X	Standby
1	0	0	X	X	LED Bias enable
1	1	0	0	X	ILED1 = BLED Brightness
1	0	1	0	X	ILED2 = BLED Brightness
1	1	1	0	X	ILED1 & ILED2 = BLED Brightness
1	1	0	1	Duty	ILED1 =(BLED Brightness*PWM Duty)
1	0	1	1	Duty	ILED1 =(BLED Brightness*PWM Duty)
1	1	1	1	Duty	ILED1 = ILED2 = (BLED Brightness*PWM Duty)

Brightness Control

a. PWM Brightness Dimming

Besides programmable built-in I²C backlight LED current control, the RT4832A features a built-in PWM dimming current control by setting register 0x09[6]=1, offering a linear current dimming by external clock source. In order to guarantee the PWM dimming resolution (7 bit at > 15kHz application), recommending dimming frequency have to be operated at range of 400Hz to 20kHz.

b. I²C Brightness Dimming

The RT4832A is built-in an I²C 10-bit or 11-bit resolution brightness control with maximum 25mA per string.

When LED brightness is controlled from the I²C brightness registers (register 0x09[6]=0) , the 11-bit brightness data is default to controls the LED current in LED1 and LED2.

The I²C brightness dimming is the concatenation of the two brightness registers (registers 0x04[2:0] and 0x05[7:0]). The LED current only changes when the MSBs are written, meaning that to do a full 11-bit current change via I²C, first the 3 MSBs are written and then the 8 LSBs are written. It can be selected as either linear or exponential. (register 0x02[4]).

In linear mapped mode the LED current follows the relationship :

$$I_{LED} = 0.0122mA * \text{Brightness Code}$$

In exponential mapped mode the LED current follows the relationship:

$$I_{LED} = 0.0183mA * (1.0035^{\text{Brightness Code}})$$

The 11-bit exponential mapping is small enough such that the transition from one code to the next in terms of LED brightness is not distinguishable to the eye.

c. LED Brightness Current and PWM

The LED brightness current is controlled with the register and the PWM Duty Cycle. LED current mapping can be selected as either linear or exponential, shows as the Figure 4. The LED current is approximated by the equation :

With linear mapping the 10 bit code to current is approximates by the equation :

$$I_{LED} = 0.0244mA * \text{Brightness Code} * \text{PWM Duty}$$

With linear mapping the 11 bit code to current is approximates by the equation :

$$I_{LED} = 0.0122mA * \text{Brightness Code} * \text{PWM Duty}$$

With exponential mapping the 10 bit code to current is approximates by the equation :

$$I_{LED} = 0.0183mA * (1.0071^{\text{Brightness Code} * \text{PWM Duty}})$$

With exponential mapping the 11 bit code to current is approximates by the equation :

$$I_{LED} = 0.0183mA * (1.0035^{\text{Brightness Code} * \text{PWM Duty}})$$

10 bit LED Current vs. Linearty Brightness Code

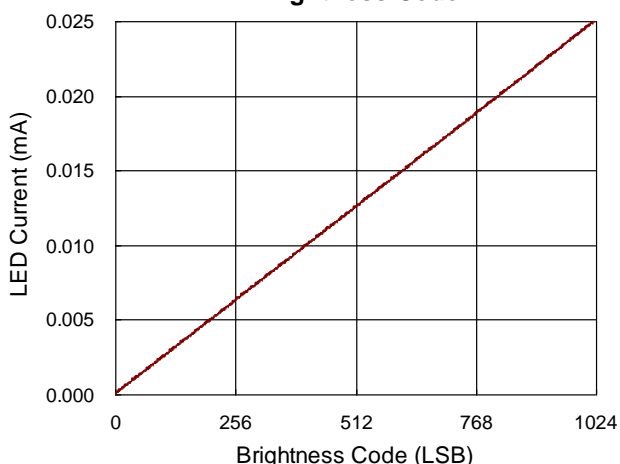

10 bit LED Current vs. Exponential Brightness Code

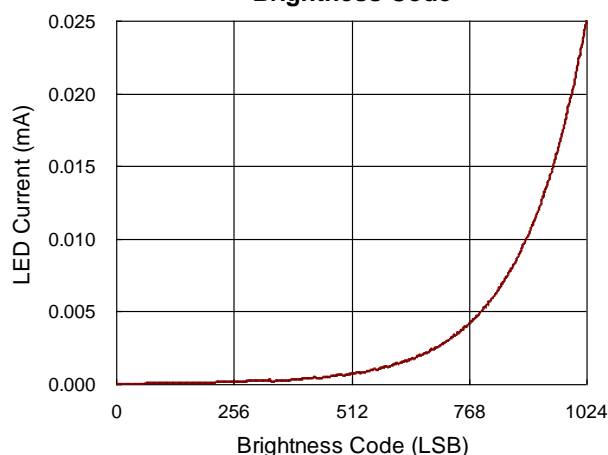

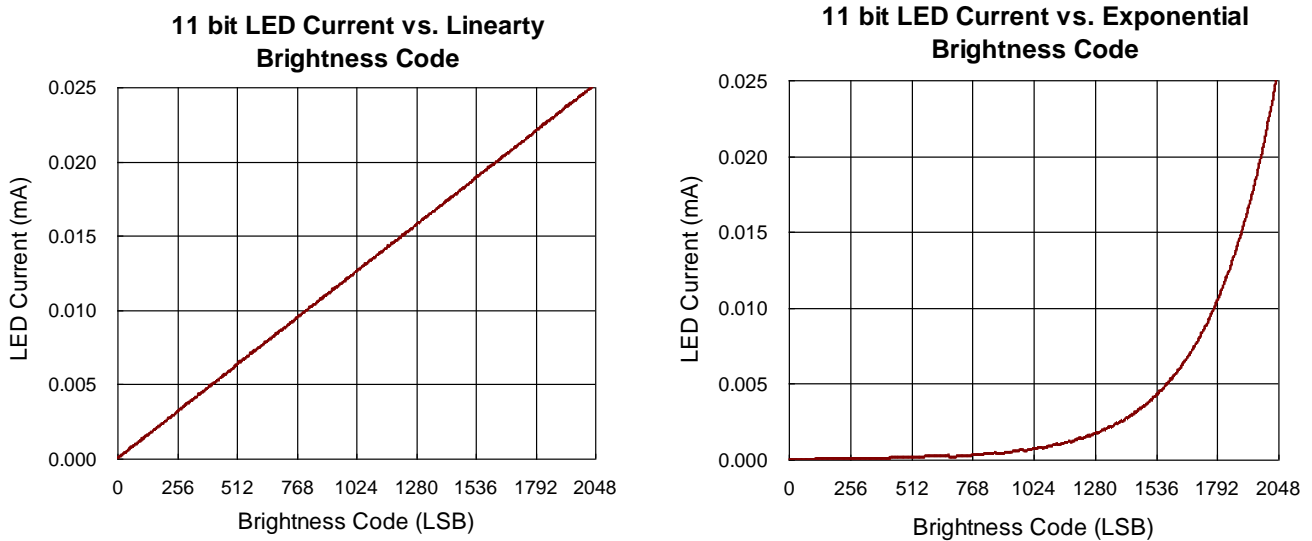

Figure 4. LED Current vs Brightness Code

Ramp Rate

There are 16 programmable ramp rates available in the RT4832A. These ramp rates are programmable as a time. Therefore, the ramp time from one current set-point to the next, depends on the register 0x03[6:3].

Over-Voltage Protection (Open LED, Open Circuit)

The RT4832A provides an internal over voltage protection to limit its output voltage. The OVP function prevents the RT4832A from damaging while open LED or open circuit condition occurs. Once the open circuit condition is removed, and the RT4832A will return to normal operation.

Over-Current Protection

The RT4832A features a 1.2A OCP. The driver provides cycle-by-cycle current limit function to control the current on power switch. The boost switch turns off when the inductor current reaches this current threshold and it remains off until the beginning of the next switching cycle. This protects the RT4832A and external component under overload conditions.

Flash LED

The RT4832A FLED provides a current regulated output to drive high current white LEDs for camera flash applications. The output current provides up to 375mA for torch and 1.5A for strobe per channel white

LEDs for camera flash applications. It adopts two channels to provide accurately regulated current flow through two separate white LEDs.

The RT4832A FLED can be set in Flash or Torch mode by the register and the STRB pin. Figure 5 shows the RT4832A FLED operation and Table 6 contains the FLED operation control table.

Flash Mode

In Flash Mode, FLED provides 15 different current levels from 100mA to 1500mA in step of 100mA. The flash currents are adjusted via the register 0x06[3:0] for flash brightness. RT4832A provides 32 steps timeout from 32ms to 1024ms in step of 32ms for flash mode only. The Flash mode can be set via the register 0x0A[1] = 1 and 0x0A[2] = 1.

Timeout

To avoid the thermal increase from flash current, RT4832A provides 32 steps timeout from 32ms to 1024ms in step of 32ms for flash mode only. The timeout can be set via the register 0x07[4:0]. Once a flash event is completed, the Flash Timeout flag in register 0x0B bit [1] is set. This is a status only flag so the Flash Enable bit is not cleared. If a Flash event is activated via the STROBE pin and STROBE transitions low after the end of the programmed flash timeout, the Flash event is terminated at the programmed Flash

Timeout and the Flash time out flag is set.

VIN Monitor

In Flash mode, to avoid the flash current to let VIN drop to UVLO, RT4832A provides VIN monitor function for the battery voltage detecting. If the battery voltage less than the VIN monitor value, FLED will be into Torch mode and output the torch current. This function can be enable via set register 0x09[0] = 1 and 0x08[2:0] is the Vin monitor value. The Register 0x0B [4] has the fault flag set when the input voltage crosses the VIN value.

0x08[2:0]	FLED VIN Monitor Level
000	2.5V
001	2.6V
010	2.7V
011	2.8V
100	2.9V (default)
101	3V
110	3.1V
111	3.2V

Torch Mode

In Torch Mode, FLED provides 15 different current levels from 25mA to 375mA in step of 25mA. Torch current is activated by setting register 0x06 [7:4]. Once Torch Mode is enabled, the current sources will ramp up to the programmed torch current level by stepping.

The torch mode can be set via the register 0x0A[1] = 1 and 0x0A[2] = 0.

Table 6. FLED Operation Control Table

Flash Enable 0x0A[1]	Strobe Enable 0x09[4]	STRB pin	Torch/Flash 0x0A[2]	Status
0	X	X	X	Standby
1	1	0	X	Standby
1	1	1	0	Torch mode
1	1	Rising edge	1	Flash mode
1	0	X	0	Torch mode
1	Falling edge	X	1	Flash mode

Txmask

The TXmask pin is designed to clamp the flash LED to torch current or no current that depend on the register setting when the PA transmit. This function can be enable by set the reg 0x09[2] = 1 and the reg 0x09[3] is used to define this pin active high or low.

Torch Mode

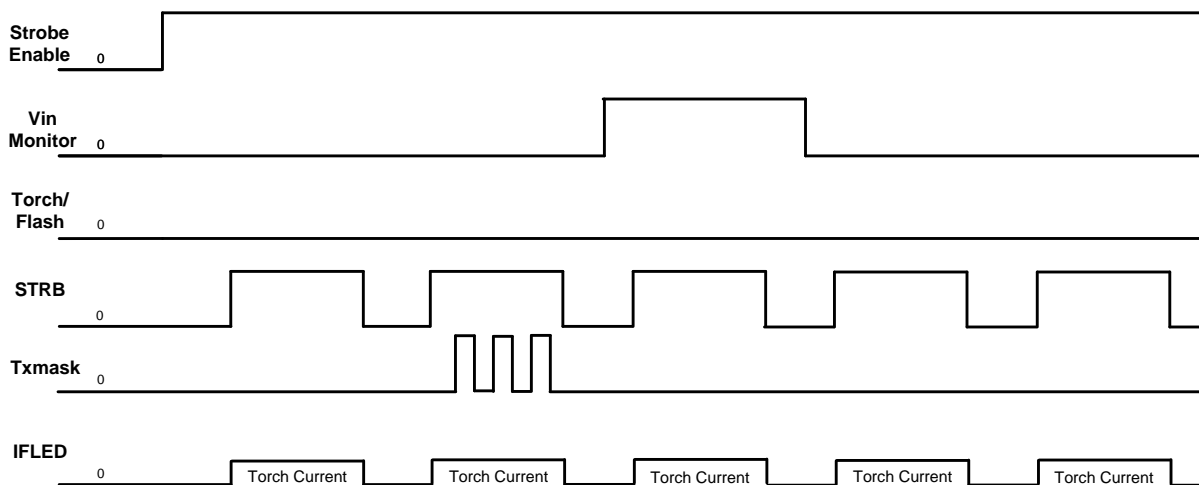

Flash Mode

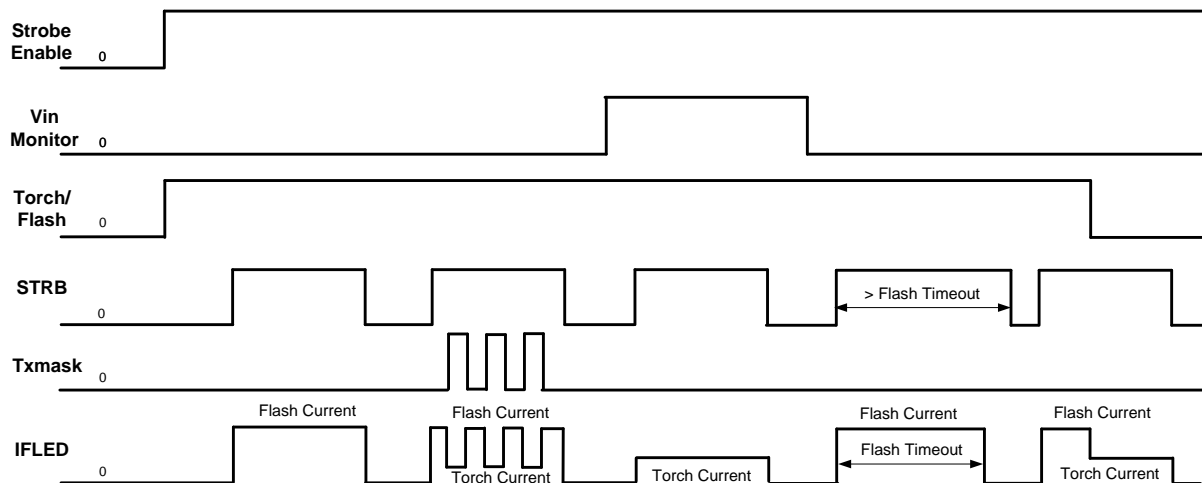

Figure 5. Flash LED Operation

Over-Voltage Protection (Open LED, Open Circuit)

The RT4832A FLED provides an internal over voltage protection to limit its output voltage. The OVP function prevents the RT4832A from damaging while open LED or open circuit condition occurs. Once the open circuit condition is removed, and the RT4832A will return to normal operation.

Over-Current Protection

The RT4832A features two selectable flash inductor current limits that are programmable through the I²C compatible interface. When the inductor current limit is reached, the RT4832A terminates the charging phase

of the switching cycle. Switching resumes at the start of the next switching period. If the overcurrent condition persists, the device operates continuously in current limit. This prevents damage to the RT4832A and excessive current draw from the battery during output short-circuit conditions. When Flash occurs the current Limit event, the FLASH_OCP flag (register 0x10 bit [1]) is set.

Over-Temperature Protection

The RT4832A provides an over-temperature protection to prevent the IC from overheating. When the junction temperature rises above 145°C, the OTP function will

be triggered and then the LED driver will be shut down. The OTP hysteresis is 15°C. Once the junction temperature reduces below the over temperature protection threshold by 25°C, the IC will enter normal operation again.

Thermal Considerations

The junction temperature should never exceed the absolute maximum junction temperature $T_{J(MAX)}$, listed under Absolute Maximum Ratings, to avoid permanent damage to the device. The maximum allowable power dissipation depends on the thermal resistance of the IC package, the PCB layout, the rate of surrounding airflow, and the difference between the junction and ambient temperatures. The maximum power dissipation can be calculated using the following formula :

$$P_{D(MAX)} = (T_{J(MAX)} - T_A) / \theta_{JA}$$

where $T_{J(MAX)}$ is the maximum junction temperature, T_A is the ambient temperature, and θ_{JA} is the junction-to-ambient thermal resistance.

For continuous operation, the maximum operating junction temperature indicated under Recommended Operating Conditions is 125°C. The junction-to-ambient thermal resistance, θ_{JA} , is highly package dependent. For a WL-CSP-30B 2.24x2.64 (BSC) package, the thermal resistance, θ_{JA} , is 31.7°C/W on a standard JEDEC 51-7 high effective-thermal-conductivity four-layer test board. The maximum power dissipation at $T_A = 25^\circ\text{C}$ can be calculated as below :

$$P_{D(MAX)} = (125^\circ\text{C} - 25^\circ\text{C}) / (31.7^\circ\text{C/W}) = 3.15\text{W for a WL-CSP-30B 2.24x2.64 (BSC) package.}$$

The maximum power dissipation depends on the operating ambient temperature for the fixed $T_{J(MAX)}$ and the thermal resistance, θ_{JA} . The derating curves in Figure 6 allows the designer to see the effect of rising ambient temperature on the maximum power dissipation.

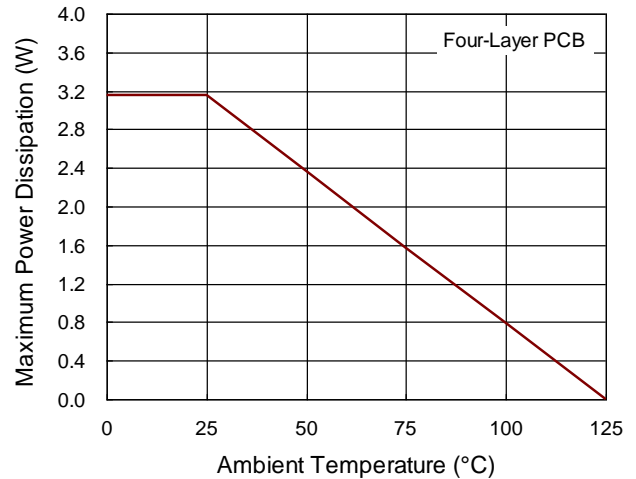

Figure 6. Derating Curve of Maximum Power Dissipation

Layout Considerations

For high frequency switching power supplies, the PCB layout is important to get good regulation, high efficiency and stability. The following descriptions are the guidelines for better PCB layout.

- ▶ For good regulation, place the power components as close to chip as possible. The traces should be wide and short enough especially for the high-current loop.
- ▶ Minimize the size of the LX node and route on the top layer only.
- ▶ Place the capacitor C_{IN} as close to VIN pin as possible.
- ▶ Place the CPOS, CCPOUT capacitor as close to the output pins as possible. Also place the charge pump flying capacitor close to the RT4832A.
- ▶ Place the capacitor CFLED as close to FLEDOUT pin as possible. Connect the Flash LED cathode directly to the FLEDGND pin of the RT4832A.
- ▶ Route the LED return with a dedicated path and keep the LED1 and LED2 path short and close to RT4832A for the good LED current performance.

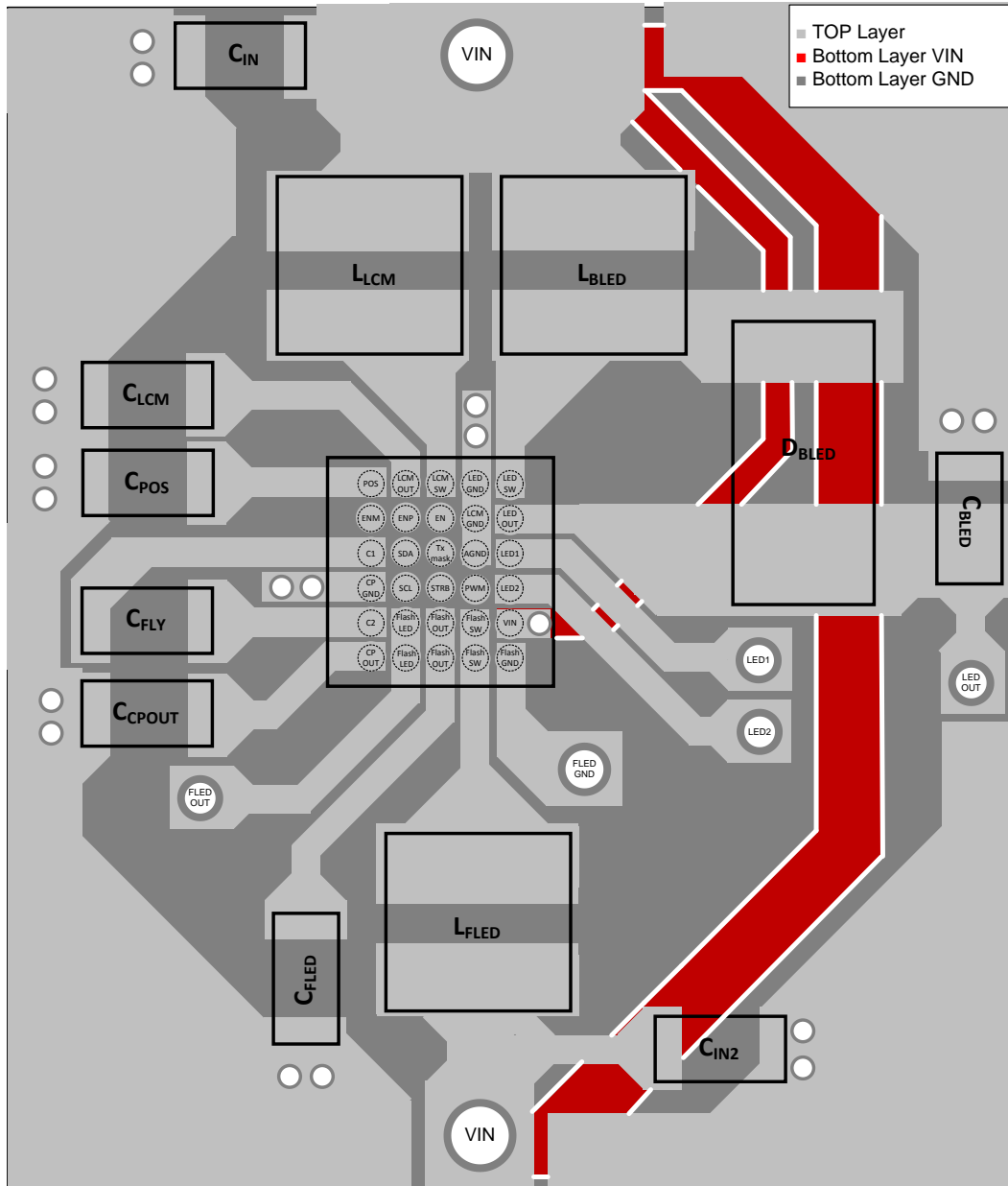
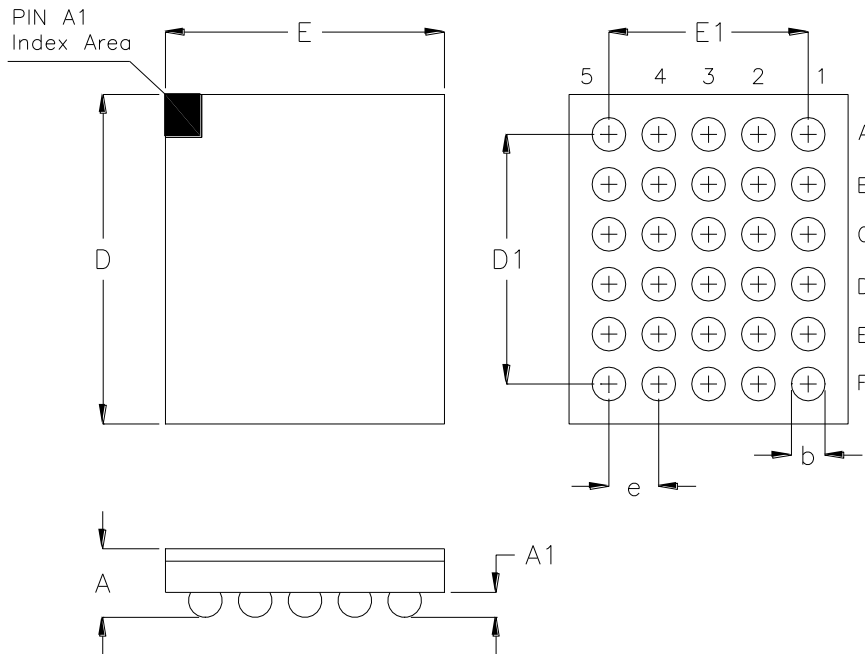

Figure 7. PCB Layout Guide

Outline Dimension



Symbol	Dimensions In Millimeters		Dimensions In Inches	
	Min	Max	Min	Max
A	0.500	0.600	0.020	0.024
A1	0.170	0.230	0.007	0.009
b	0.240	0.300	0.009	0.012
D	2.590	2.690	0.102	0.106
D1	2.000		0.079	
E	2.190	2.290	0.086	0.090
E1	1.600		0.063	
e	0.400		0.016	

30B WL-CSP 2.24x2.64 Package (BSC)

Footprint Information

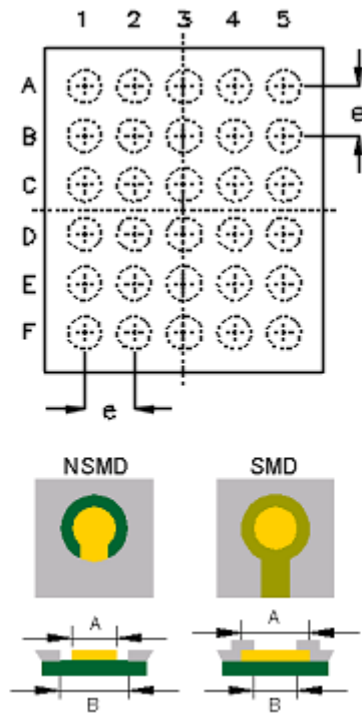

Package	Number of Pin	Type	Footprint Dimension (mm)			Tolerance
			e	A	B	
WL-CSP2.24*2.64-30(BSC)	30	NSMD	0.400	0.240	0.340	±0.025
		SMD		0.270	0.240	

Richtek Technology Corporation

14F, No. 8, Tai Yuen 1st Street, Chupei City

Hsinchu, Taiwan, R.O.C.

Tel: (8863)5526789

Richtek products are sold by description only. Richtek reserves the right to change the circuitry and/or specifications without notice at any time. Customers should obtain the latest relevant information and data sheets before placing orders and should verify that such information is current and complete. Richtek cannot assume responsibility for use of any circuitry other than circuitry entirely embodied in a Richtek product. Information furnished by Richtek is believed to be accurate and reliable. However, no responsibility is assumed by Richtek or its subsidiaries for its use; nor for any infringements of patents or other rights of third parties which may result from its use. No license is granted by implication or otherwise under any patent or patent rights of Richtek or its subsidiaries.

Copyright © 2017 Richtek Technology Corporation. All rights reserved. **RICHTEK** is a registered trademark of Richtek Technology Corporation.