



SummaCut Series[™] S Class 2 Series[™]

World renowned
vinyl and contour cutters

www.summa.eu



SUPERIOR VINYL AND CONTOUR CUTTERS



The Summa S Class 2 cutter has a processor, which is seven times more powerful than its predecessor.

A vibrant color touchscreen, a network port, fast and reliable USB connection and an even faster OPOS sensor make the S Class 2 cutter prepared for many years to come.

Equipped with a new trim and sheet cut functionality, the cutter is now more than ever the perfect companion for large format printers.



S2 75
Drag or Tangential Knife



S2 120
Drag or Tangential Knife



S2 140
Drag or Tangential Knife



S2 160
Drag or Tangential Knife

ADVANCED CUTTER FOR HIGH-VOLUME VINYL AND DIGITAL PRINT SHOPS

Signmaking has evolved, which means, you need equipment that is both flexible and durable. Summa S Class 2 cutters are built on a foundation of rock-solid reliability and offer features to handle virtually any material you feed them with.

Like the finely-tuned suspension in a sports car, our precision tracking lets us put more power under the hood to improve your performance. The S Class 2 cutter features a dual servomotor design that cuts amazingly fast, and Summa tracking lets you do it with complete confidence.

From cutting vinyl to accurate, digital die-cutting to plotting on paper and beyond, the Summa S Class 2 cutter is a do-it-all cutter with the strength to do the job day in and day out.

The accuracy of our European-crafted cutters is precisely what makes them so durable. Not only do you receive amazing reliability, you also get the confidence of knowing your expensive films and valuable vinyl prints will be cut precisely, each and every time.

FEATURES & TECHNICAL SPECIFICATIONS

1 The Summa S Class 2 cutter is unquestionably the world's most advanced cutter. With its **exclusive touch-control panel**, it is also, by far, the easiest to use.

2 **OPOS X contour cutting alignment** delivers OPOS unparalleled accuracy and automation, even on laminated images.

3 The cutting head includes an **automatic cut-off knife**, which can optionally be set as to slice your media at the end of each job.

4 The Summa S Class 2 cutter is standardly equipped with an **Ethernet port** for fast and reliable connection to a network and a USB stick can be used to store jobs for later use.

Eight built-in and quickly accessible **user configurations** make switching between different jobs and media fast and easy.



Powerful tangential head



Accurate OPOS X contour cutting



Vibrant color touch screen



Legendary tracking



Quick accessible user configurations



FlexCut feature



Model	S2 75	S2 120	S2 140	S2 160
Dimensions	141 x 68 x 111 cm	187 x 68 x 111 cm	202 x 68 x 111 cm	225 x 68 x 111 cm
Media Width	6 to 84 cm	12 to 130 cm	17 to 145 cm	17 to 168 cm
Cutting Area	74.2 cm x 50 m	120 cm x 50 m	135 cm x 50 m	158 cm x 50 m
	'Oversized' mode allows a wider cutting area : +/- 7 cm			
Alignment Type	<ul style="list-style-type: none"> • OPOS X (OPOS CAM : Factory upgrade on new Summa S Class 2 S75T and S160T) • Barcode Jobrecognition 		<ul style="list-style-type: none"> • Up to 2 x 64 marks on the X-line • Y- Line compensation 	
Tracking Performance	Within +/- 0.1 mm on plots: up to 12 m long on rolls up to 760 mm wide* up to 4 m long on rolls over 760 mm wide*			
Accuracy	0.2 % of movement or 0.25 mm, whichever is greater*			
Speed	Up to 141 cm/sec diagonal			
Acceleration	Up to 5.5 G diagonal			
Knife Pressure	Drag Knife: Up to 400 grams / Tangential Knife: Up to 600 grams			
Connectivity	USB; Ethernet			
Included Software	Cutter Control software; Winplot™ & MacSign™ Cut cutting software			

*For complete specifications, please visit www.summa.eu

PERFORMANCE VINYL AND CONTOUR CUTTERS

SUMMACUT® SERIES

Since 1996, the SummaCut Series has evolved to become the world's most advanced performance-price leader. The new SummaCut Series is the product of decades of Summa's brilliant European engineering.

Numerous refinements have been made, such as the OPOS X technology, which is known from our most advanced S Class 2 cutting plotters. The OPOS X technology is now integrated into a newly designed drag knife cutting head.

The SummaCut Series is capable of reading registration marks for contour cutting on standard materials but also on reflective, holographic or mirroring materials, and on the many different types of laminates being used today.



D60
D60FX



D120



D140
D140FX



D160

VINYL CUTTERS THAT SET THE INDUSTRY STANDARD FOR PERFORMANCE AND VALUE

The SummaCut cutter features highly complex algorithms to compensate for any deformation of the print, using the world's most reliable sensor technology. This makes the SummaCut cutter a winning contour cutter for any sign or print shop.

Summa engineers know there is not a more important vinyl cutter feature than tracking. This is why every cutter we build starts with our exclusive and patented MicroSprocket™ grit roller.

Milled from the finest materials in a unique process assuring each roller has an exacting diameter, we then specially coat each roller to eliminate the risk of wear and oxidation which could degrade tracking over time.

Quality craftsmanship is about more than low price. It is about value. With cutting performance that rivals other top-of-the-line cutters, it comes as no surprise that the affordably priced SummaCut D60 is one of the most popular vinyl cutters ever built.

FEATURES & TECHNICAL SPECIFICATIONS

1 The large, easy-to-use control panel allows you to quickly and easily change settings such as speed, pressure and plot mode in order to perform test cuts.

2 Our high-speed cutting head features the utmost accuracy for exceptionally reliable and effortless vinyl cutting.

3 Integrated media rollers and roll flanges load your vinyl straight and keep your media on track, even when cutting at top speed.

4 OPOS X contour cutting alignment means you can die-cut valuable printed vinyl graphics with complete confidence and reliability.



Intuitive control panel



Accurate OPOS X contour cutting



FlexCut feature



Legendary tracking

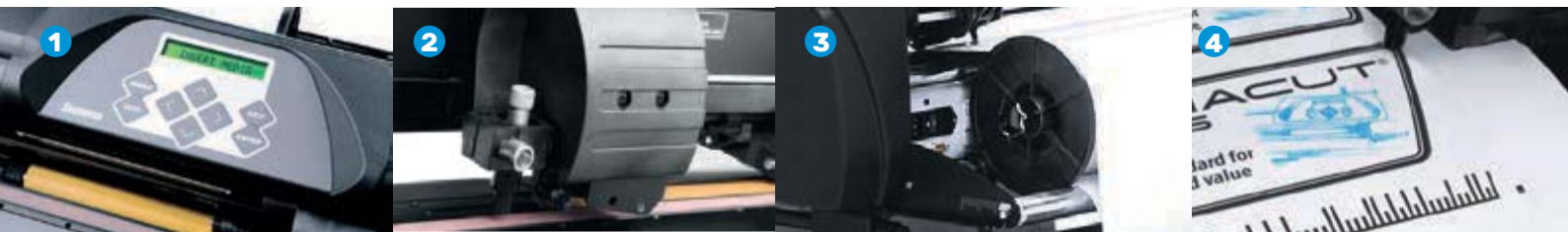

Model	D60 (FX)	D120	D140 (FX)	D160
Dimensions	100 x 35 x 30 cm	160 x 68 x 112 cm	175 x 68 x 114.5 cm	198 x 68 x 114.5 cm
Media Width	7 to 66 cm	12 to 126 cm	18 to 141 cm	18 to 164 cm
Cutting Area** extended mode	60 cm x 50 m** 63 cm	120 cm x 50 m 123 cm	135 cm x 50 m** 138 cm	157.5 cm x 50 m 160.5 cm
Alignment Type	<ul style="list-style-type: none"> • OPOS X • Barcode Jobrecognition 		<ul style="list-style-type: none"> • Up to 2 x 64 marks on the X-line • Y- Line compensation 	
Tracking Performance	Within +/- 0.1 mm on plots: up to 8 m long on rolls up to 760 mm wide* up to 4 m long on rolls over 760 mm wide*			
Accuracy	0.2 % of movement or 0.25 mm, whichever is greater*			
Speed	Up to 113 cm/sec diagonal			
Acceleration	Up to 3 G diagonal			
Knife Pressure	0 - 400 grams, in 5 gram increments			
Connectivity	USB RS232 (serial)	USB Ethernet	USB Ethernet	USB Ethernet
Included Software	Cutter Control software; Winplot™ & MacSign™ Cut cutting software			

*For complete specifications, please visit www.summa.eu

** SummaCut FX series differ from the regular series, please see the next page for the SummaCut FX series specifications

FEATURES OF BOTH THE **S CLASS 2** & THE **SUMMACUT** SERIES

DRAG KNIFE TECHNOLOGY

Its simplicity has made Drag Knife (or swivel knife) technology the most commonly used.

An offset parameter defines the distance between the knife tip and the rotating center.

In order to know the position of the freely rotating knife inside the knife holder, a drag movement is made, assuming the knife tip will follow accordingly.

Summa cutters include enhanced methods to optimize this drag movement in order to obtain the best possible cutting quality.



DRAG MOVEMENT

- 1** The Drag Knife stops cutting right before entering a corner.
- 2** The eccentric blade is rotated by performing a drag movement to the desired angle, never leaving the media.
- 3** Once the drag-movement is completed, the corner cutting continues.

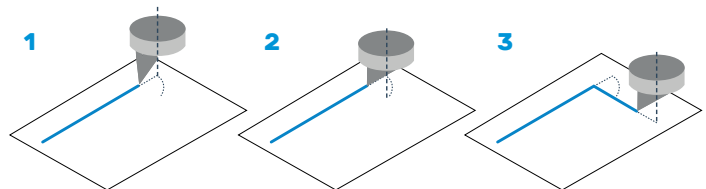

DUAL HEAD

As an option, the S Class 2 T Series and the SummaCut Series can be equipped with a cutting head with dual functionality. This special Dual Head features an extra pen adaptor, instead of the OPOS sensor, allowing you to work alternately with each tool.

The perfect solution for drawing and cutting patterns in one easy step!



CUTTING THROUGH WITH FLEXCUT

Summa's FlexCut feature enables you to cut simple designs completely through the material.

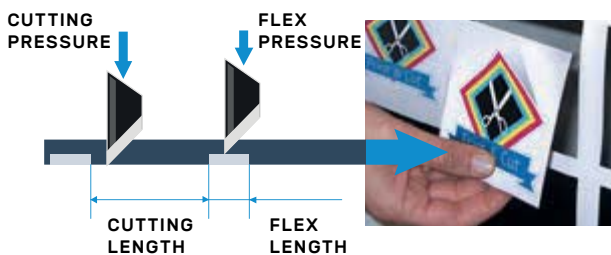

Alternately, one length is cut completely through the material, and one length is cut halfway through. This way a kind of tear-off line is created, ensuring the material keeps a certain rigidity during transportation through the Summa cutter, while remaining easy to remove from the design afterwards.

MATERIAL TRANSPORT

Tracking is the ability to transport the media through the machine in a repetitive way. This ability makes sure that one single job is cut within specifications, covering the complete guaranteed tracking length. Nevertheless, also longer jobs are accepted by the cutter.

The guaranteed tracking length also indicates the possibility of doing multiple jobs sequentially, exceeding the guaranteed tracking length several times without the need of reloading the media.



INTERNAL INTELLIGENCE

Summa cutters are loaded with intelligent routines, optimizing the cutting data.

All Summa cutters use an advanced vector look-ahead technology that cuts complex images and lettering with improved efficiency.

The benefits are extensive. The cutting time is reduced considerably, curves are smoother, and the motors are less loaded, which increases the lifetime of the plotter.

Other intelligent features include:

OverCut

OverCut extends the vector at the beginning and at the end of a curve. This ensures the design is cut through completely. Without the OverCut function, the cut line may not be completely closed, causing difficulties when weeding.

OptiCut

OptiCut, a function specially developed for drag knife cutters, simulates tangential cutting. Due to performance of complex movements, the OptiCut feature compensates for changes in the blade offset, caused by wear and tear. The OptiCut feature makes sure the knife is orientated correctly. This revolutionary technology gives you optimal quality during your blade's lifetime.

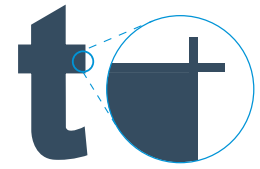

OverCut



without / with OptiCut
5 mm character

CONTOUR CUTTING WITH OPOS

The automated contour alignment system OPOS stands for Optical Positioning System. The OPOS X sensor technology senses marks on a wide range of materials. Some of its features include a fully-automated workflow using **OPOS barcodes**, enabling you to contour cut multiple jobs without intervention.

Another feature automates the contour cutting of multiple sheets with repeating graphics. During this workflow, the OPOS sensor will start to look for marks, immediately after a new sheet is loaded.

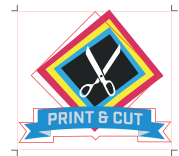

Without
OPOS



With
OPOS

MULTIPLE STRENGTHS

One of the strengths of OPOS is the unique ability to register multiple marks: a minimum of 4 and a maximum of 128 marks along a job and an OPOS XY-line in front of the job. The OPOS XY-line makes it possible to compensate deformations along the width of the machine as well.

This combination allows our system to contour cut large jobs more accurately.



SUMMARY

	SummaCut FX Series	SummaCut Series	S Class 2 D series	S Class 2 T series	OPOS CAM series
Description	Reliable, No-Nonsense Contour & Vinyl Cutter	Reliable, Efficient, No-Nonsense Vinyl & Contour Cutter	Maximum Performance, Reliable, Efficient, Vinyl & Contour Cutter	Maximum Possibilities, Versatile, Flexible, Vinyl & Contour Cutter	Maximum Possibilities, Versatile, Flexible, Vinyl & Contour Cutter
Maximum Media Width	60 66 cm	75 - 120 142 cm 160 164 cm	84 cm	130 cm 145 cm 168 cm	84 cm
Cutting Technology	Drag Knife	Drag Knife	Drag Knife	True Tangential Knife	True Tangential Knife
Opos X (Contour Cutting)	✓	✓	✓	✓	✓
Opos CAM (Camera)	-	-	-	-	✓
Barcode Support	✓	✓	✓	✓	✓
FlexCut (Cutting Through)	✓	✓	✓	✓	✓
Roll-up	-	-	Optional	Optional	Optional
Velocity	**	***	*****	*****	*****
Flexible Working Sizes	-	✓	✓	✓	✓

FEATURES SPECIFICALLY FOR THE **S CLASS 2** SERIES



TANGENTIAL KNIFE TECHNOLOGY

Tangential cutting technology guarantees a superior performance compared to commonly used swivel knife techniques. The direction of the Tangential Knife is electronically controlled, enabling the T Series to cut very precisely and with very high pressures. The perfect cut ensures easy weeding, saving you valuable time. The patented nose piece prevents small pieces from being pushed out of the vinyl while cutting.

With up to 600 grams of cutting force, the Summa S Class 2 cutter powers through heavy sandblast, paint mask and reflective materials with incredible ease, speed and accuracy.

With a T model, you know you can do the job!

TANGENTIAL MOVEMENT

- 1** The Tangential Knife stops cutting right before a corner.
- 2** A motor lifts and re-ori-ents the blade.
- 3** Once the blade has reached the desired angle, it is lowered and continues to cut the corner.

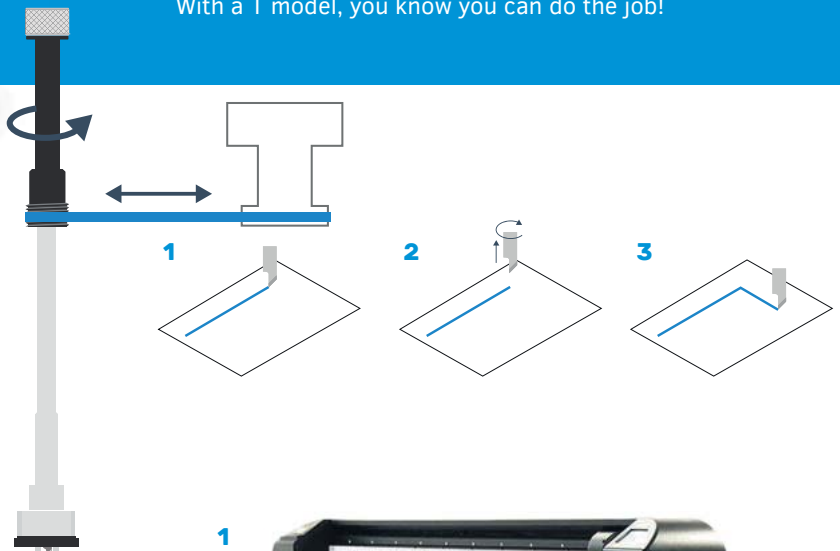

MEDIA OPTIONS

A servo-powered roll-up system ⁽¹⁾

(S2 140 & S2 160)

After a job is finished, the system will roll up the artwork neatly and prepare the machine for the next unattended job. The integrated paneling feature splits long-length runs into shorter consecutive jobs.

The S Class 2 can therefore cut complete rolls unattended and deliver the output nicely rolled-up.



A solid, most effective media rack ⁽²⁾

(S2 140 & S2 160)

Note: The roll-up system and the media rack cannot be combined.

Extra pinchrollers ⁽³⁾

(S Class 2 Series & SummaCut Series)

Extra pinchrollers can be installed when required.



OPOS CAMERA

With OPOS CAM, Summa delivers yet another amazing innovation with the printing industry's first camera recognition alignment solution for friction-driven vinyl drum cutters.

Summa customers in volume-driven workflow environments will now be able to excel against the competition with extremely fast precision and accurate cutting of short or long run contour cutting jobs.

OPOS CAM is a factory upgrade option now available on all new Summa S Class 2 S75T, S140T and S160T vinyl cutting plotters.

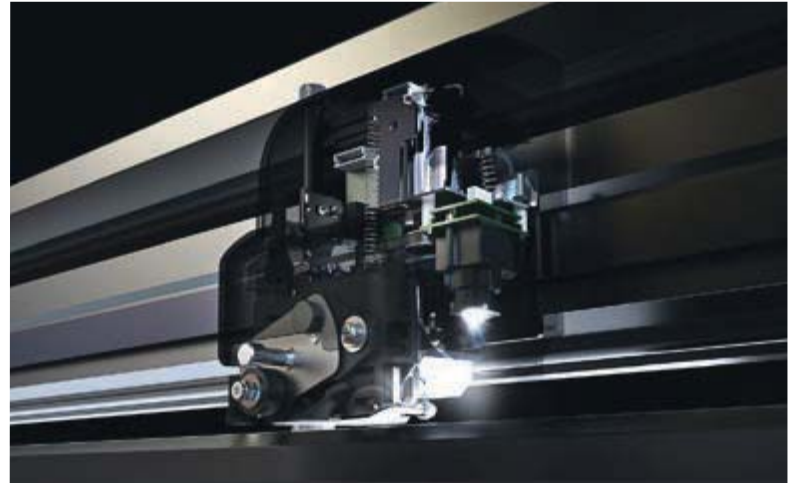

FEATURES SPECIFICALLY FOR THE **SUMMACUT** SERIES

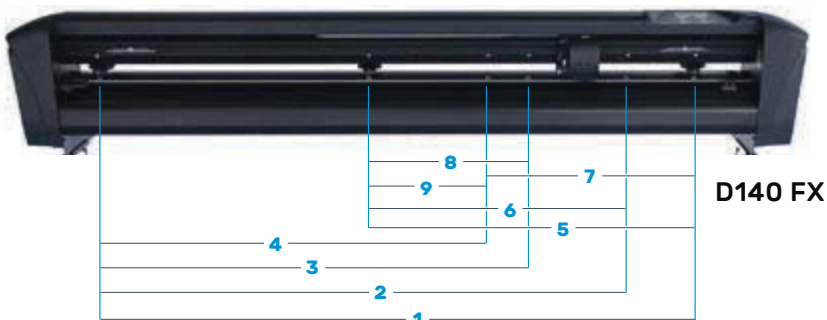

D140 FX

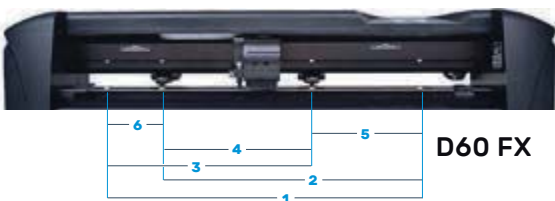

D60 FX

MEDIA BASKET

(OPTIONAL D60, D60FX & D140FX)

As the media advances, the output will be neatly collected in a textile basket, optional on D60, D60FX and D140FX models, preventing dust and debris from collecting onto the media. This eliminates the problem of media coming in contact with dirty floors, which could contaminate work surfaces and result in particles being trapped between the vinyl and substrate. The basket also neatly organizes vinyl and other media when processing multiple jobs.

For the S Class 2 Series and SummaCut D120-D140-D160, the media basket is always standard included.

SUMMACUT FX SERIES

Price Breaker

Benefit from all the features of the SummaCut Series at an affordable price.

With pinch roller positions handling most common sizes and an extended cutting mode, the SummaCut FX Series is optimized for most common media sizes.

	1 1324 mm	2 1174 mm	3 954 mm
D140 FX Working Area	4 864 mm	5 720 mm	6 570 mm
	7 454 mm	8 350 mm	9 260 mm
D140 FX Target Media Width	1 1372 mm	2 1220 mm	3 1000 mm
	4 914 mm	5 762 mm	6 610 mm
	7 500 mm	8 406 mm	9 297 mm
D60 FX Working Area	1 575 mm	2 470 mm	3 375 mm
	4 270 mm	5 190 mm	6 95 mm
D60 FX Target Media Width	1 610 mm	2 500 mm	3 400 mm
	4 297 mm	5 210 mm	6 115 mm



OPTIONAL STANDS FOR SUMMACUT D60 (FX)

- 1** Sturdy Metal Stand on 4 roller casters (#399-050)
- 2** Sturdy Metal Stand with fabric basket on 4 roller casters (#399-075)

TWO BEATS ONE

UNIQUE BENEFITS OF SUMMA'S DEDICATED CUTTING EQUIPMENT

- ✓ Cutters can do things no printer-cutter is designed to do. That is especially true with Summa cutters. Not only do they perform the simple kiss-cutting, needed to contour cut labels and graphics, but they can also **cut completely through** the backing in order to eliminate the need to manually cut individual labels. Or the user can kiss-cut and cut a separate path that goes through the backing in a **single operation** to create sheets of labels or large contour cut graphics that do not need to be sectioned manually by the cutter operator.
- ✓ **Alignment systems** Summa OPOS X can handle up to **128 marks**.
- ✓ Manual tasks are eliminated, which **improves** operator **productivity** and **reduces** job **costs**.
- ✓ Professional-grade cutters are far more capable than the light-duty cutting heads on inkjet printer-cutters, and they have **more cutting force** (grams of down force).
- ✓ Summa cutters can handle **very rigid materials**, such as Lexan over-laminate, floor graphic kits and other thick and semi-rigid laminates. But that is merely one aspect of what separates a dedicated cutter from a printer with a cutting head.
- ✓ **Material tracking** in cutters is designed for back-and-forth travel on a sheet of labels. It might go back and forth as many as 50 times. Summa cutters have **heavy-duty** motors, which can handle the weight of large, laminated prints. Moreover, they cut with much **greater consistency**, assuring that every label is cut **precisely** and **weeded easily**.
- ✓ Many print shops evolved from screen printing and still do both printing and cutting. Summa cutters are **optimized** for all types of printing and add value throughout the organization.
- ✓ Cutting involves more than just printed vinyl. **Vinyl graphics** and **lettering** are also commonly produced by shops of all sizes. It makes no sense whatsoever to schedule production of cut vinyl in print production.
- ✓ You are far better-served with a vinyl cutter that can do **all cutting**, whether contour cutting or cut vinyl lettering.

DISADVANTAGES OF A HYBRID PRINTER & CUTTER

- ✗ Sending jobs back into print production to perform cutting tasks would **delay** other printing and would significantly limit the capacity of the printer.
- ✗ **Alignment systems** are limited to a **4-point** method. Therefore alignment systems and built in print-and-cut units are slow, inaccurate and limited in use with different materials and laminates.
- ✗ The light-duty cutting heads on inkjet printer-cutters have **less cutting force** (grams of down force) and are far less **uncapable** when compared to the professional-grade cutters.
- ✗ The **cutting speed** of integrated printer-cutters is much lower than the one on Summa cutters, which will **reduce** the printing **capacity** even more.
- ✗ With modern print techniques, a great deal of **heat** is used, **deforming** the printed material significantly.
- ✗ Cutting after printing without reloading and aligning generates significant shift between the print and the cut line. Long jobs will **fail** completely.

Workflow

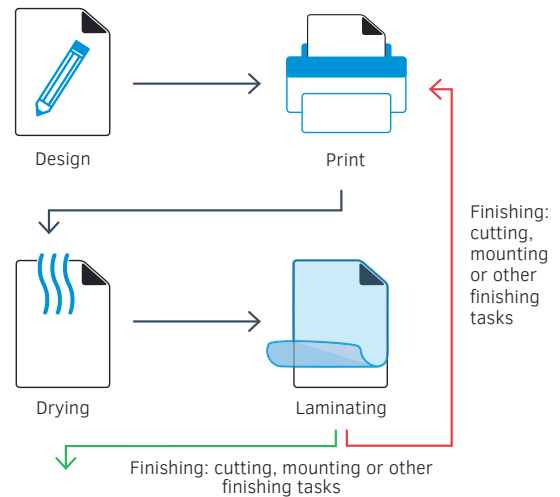

MORE THAN JUST CONTOUR CUTTING









| Greater productivity | More accurate | More cutting modes | More material choices |

CONSUMABLES & SOFTWARE

SUMMACUT & S CLASS 2 D SERIES

 MP06BK Black fiber-tip (4 pcs-0,3 mm pens)	 391-332 / Dia 1.5 mm Standard Drag Knife Holder
 391-595 Pouncing Kit SummaCut	 391-363 / Dia 2 mm Thicker Material Knife Holder
 395-313 Pouncing Kit S Class 2 D Series	 391-360 / Dia 1.5 mm 36° Drag Blade (5 pcs)
 395-430 Roller Ball (5 pcs-Black)	 391-231 / Dia 1.5 mm 60° Drag Blade (1 pc)
 395-431 Roller Ball (5 pcs-Blue)	 391-358 / Dia 2 mm 55° Drag Blade (5 pcs)
 391-592 Pouncing Pin	
 395-434 Universal Pen Holders (2 pcs) Black/Copper Not compatible for extra pen position with dual heads	

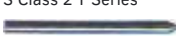
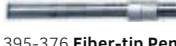
S CLASS 2 T SERIES

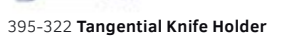
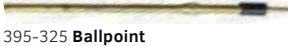
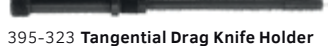
 395-348 Standard Nose Piece	 395-347 Low Nose Piece	 395-330 Dummy Nose Piece
 390-553 Blade Install Tool	 390-534 36° Tangential Blade (5 pcs)	
 395-315 Pouncing Kit S Class 2 T Series	 390-551 36° Double Tip Blade	
 391-592 Pouncing Pin	 390-560 45° Double Wedge	
 395-376 Fiber-tip Pen	 390-550 60° Tangential Blade	
 395-324 Holder for Ballpoint	 395-322 Tangential Knife Holder	
 395-325 Ballpoint	 395-323 Tangential Drag Knife Holder	

GENERAL

 391-386 Cutting Strip (1 Pc) Models : 500 > 760	 400-565 Cutting Strip (1 Pc) Models : 1400 > 1600 & S2 140 & S2 160
 391-886 Cutting Strip (1 Pc) Models : 1000 > 1300 & S2 75 & S2 120	 391-290 Cut-Off Knife Without trackbase
 391-510 Core Holders (2 Pc)	 391-146 Replacement Blades (10 Pack)

Cutter knife guidelines

When you choose a knife to cut your material, always use the lowest degree knife (shallowest angle), assuming the thickness of the material did not exceed the maximum listed for that knife.

	D Series	391-360 36° Drag Blade (5 pcs)	391-231 60° Drag Blade (1 pc)	391-358 55° Drag Blade (5 pcs)	T Series	390-534 36° Tangential Blade	390-551 36° Double Tip	390-560 45° Double Wedge	390-550 60° Tangential Blade
Standard Vinyl	Recommended								
Engineering Reflective	Alternative								
Sandblast (Monument)									
Rhinestone									
Heat Press (Apparel)									
Material thickness is the first specification to determine which knife to use. If the material thickness is unknown, please use the following recommended chart.									
Max. Thickness (mm)		0.25	0.60	0.80		0.25	0.25	1.00	1.20
Max. FlexCut Thickness (mm)		0.50	0.60	0.80		0.25	0.25	1.00	1.20
391-332 / Dia 1,5 mm Standard Drag Knife Holder									
391-363 / Dia 2 mm Thicker Material Knife Holder									
395-322 Tangential Knife Holder									
395-348 Standard Nose Piece									
395-347 Low Nose Piece									
395-330 Dummy Nose Piece		is used for Ballpoint and Holder for Drag Blades							

WINPLOT™ & MACSIGN™ CUT

WinPlot

WinPlot is a cutting software utility for the Microsoft Windows operating systems, which is delivered free of charge with every new Summa cutter.

Compatibility: WinPlot supports all Summa cutting devices, including SummaCut and S Class 2. Supported communication ports: USB, serial (RS 232), ethernet, centronics parallel and any printer port installed on your operating system which enables networked printing.

Input: Includes plug-ins for **CorelDRAW** and **Illustrator** and imports simplified .eps, .ai and .pdf files from other applications.

Edit: Allows scaling, mirroring and rotating of the design or parts of the design.

Output: / **Nesting with support of multiple copies :** WinPlot automatically rotates and positions different designs as well as multiple copies in order to optimize the use of material. / **Paneling :** Jobs larger than the media width will be split in panels. / **Integration of OPOS :** Using Summa's Optical Positioning System has never been easier. / **Weeding Box :** Automatically generates weeding boxes around cut images. / **Cutting by color**

MacSign Cut

MacSign Cut is a "bridge" application that imports artwork saved by popular desktop publishing applications (e.g., Illustrator, Freehand, Canvas, CorelDRAW, and so on) and sends them to Summa vinyl cutters. Imported artwork is displayed on the worksheet before processing and can be resized, positioned, mirrored, turned, distorted, duplicated, etc. The tiling feature separates a design into two or more pieces, with user-specified overlaps, and allows you to cut designs larger than the cutter width.

After a 30-day trial, free registration is required. MacSign Cut is included with every Summa cutter. Compatible with: Mac OS X (10.5 10.12), Mac OS 9





WARNING
HAZARDOUS MOVING PARTS
KEEP FINGERS AND OTHER BODY PARTS AWAY

ATTENTION
PARTIES MOBILES DANGEREUSES
TENIR LES DOIGTS ET AUTRES PARTIES DU CORPS ÉLOIGNÉES

SummaCut Series™ S Class 2 Series™

World renowned vinyl and contour cutters



Summa nv
Rochesterlaan 6
8470 Gistel
Belgium

www.summa.eu

Copyright 2018© Summa nv
Marketing Communications. Summa nv believes that all
illustrations and specifications contained in this catalogue
are correct at the time of publication. Summa nv reserves the
right to make changes at any time, without notice.

RevEN1802 / All rights reserved