

BARRY E.  WALTER SR. CO.

# SUPPLEMENTAL CATALOG

*Send Your Orders To:*

BARRY E.  SR. CO.

*E-mail: [orderdesk@barrywalter.com](mailto:orderdesk@barrywalter.com)*

*Fax: 1.800.886.9831*

*Phone: 1.800.767.5552*



**BRASS**  
AMERICA  
*Quality Replacement Parts*

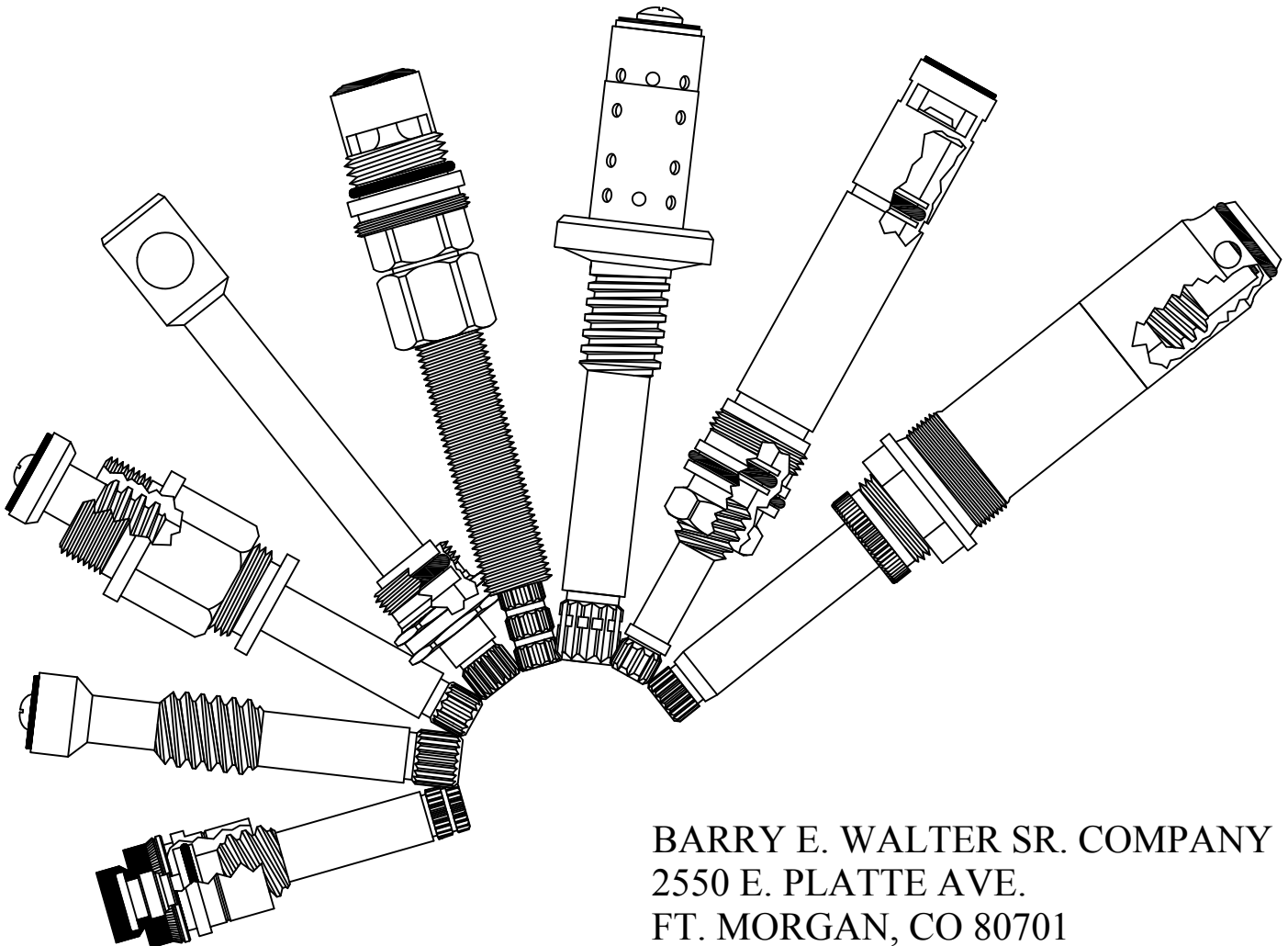

BARRY E. WALTER SR. COMPANY  
2550 E. PLATTE AVE.  
FT. MORGAN, CO 80701

BARRY E.  WALTER SR. CO.

CERAMIC  
DISC  
CARTRIDGES

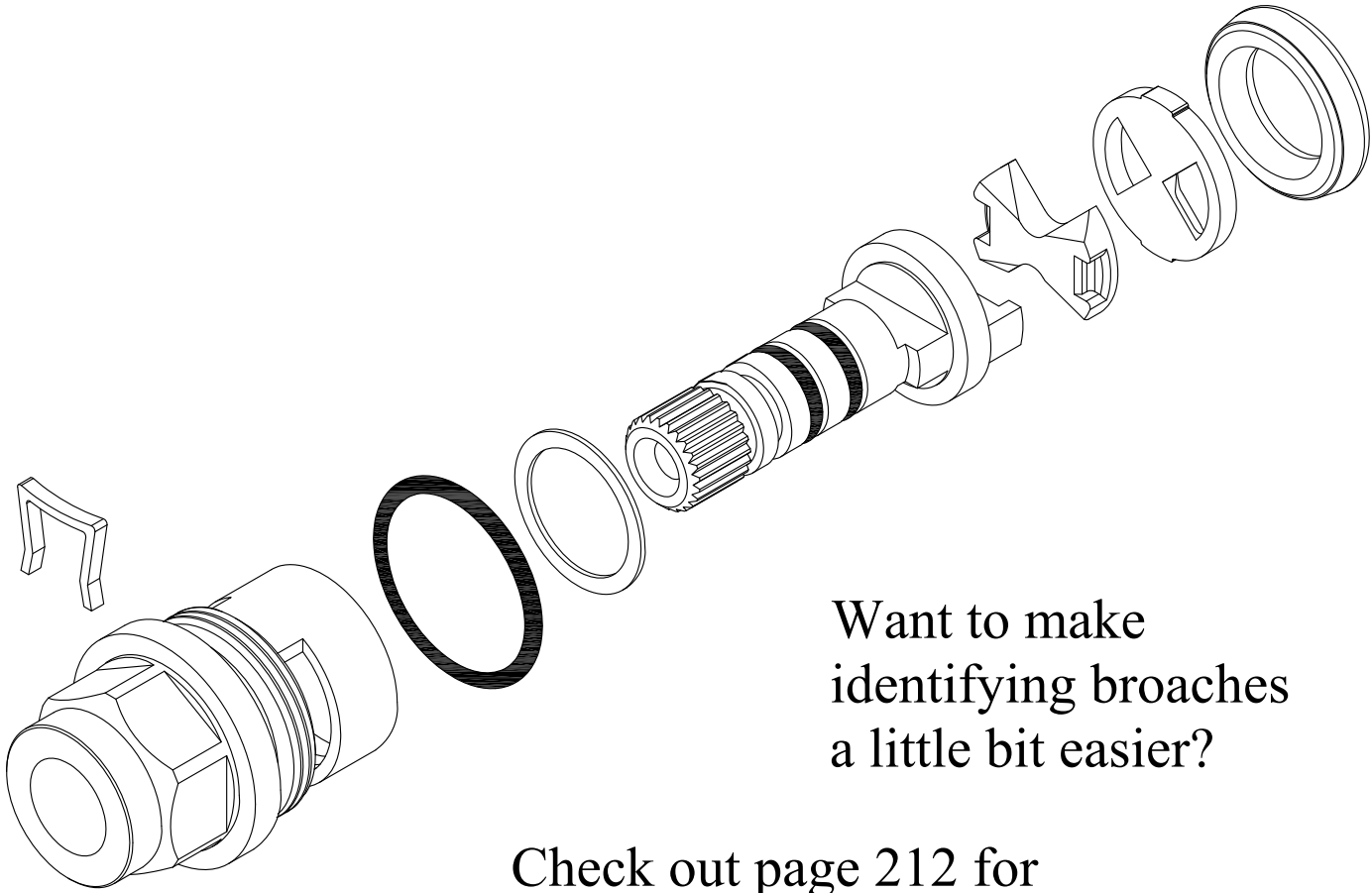

Want to make identifying broaches a little bit easier?

Check out page 212 for our plastic broach gauge!!

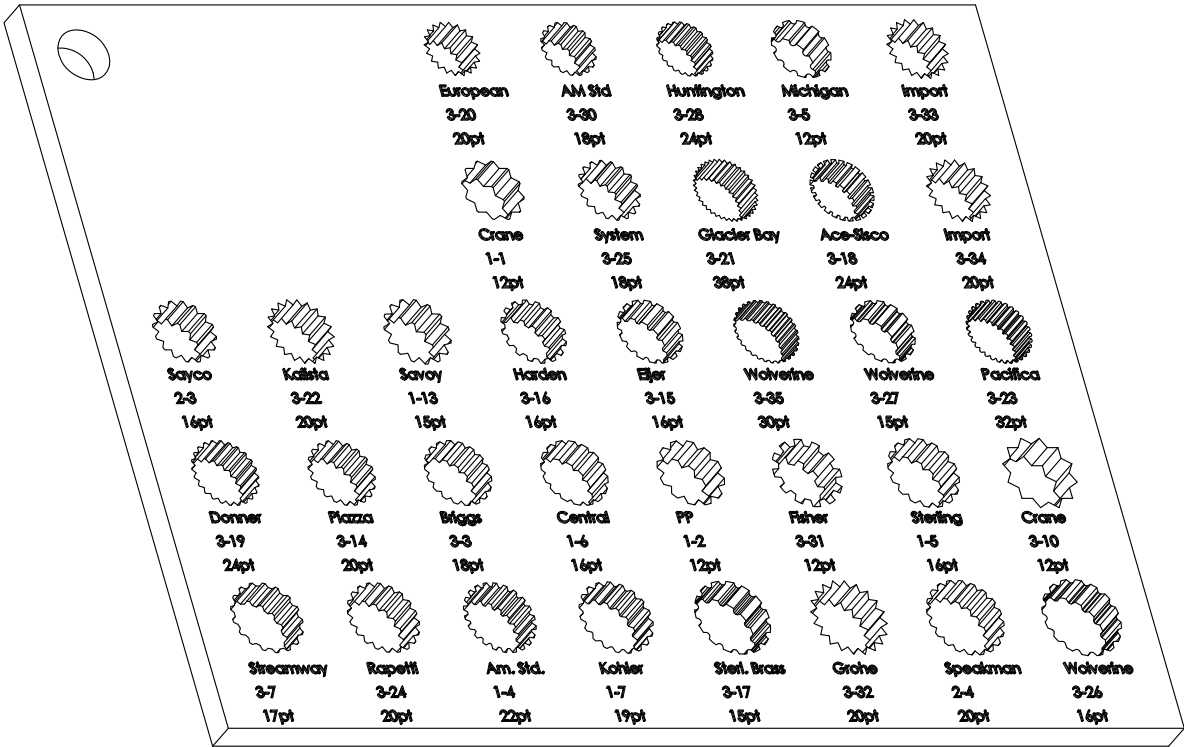

# CERAMIC DISC CARTRIDGES

Ceramic Conversion for:  
Aqua-Seal

FOR AM STD  
LENGTH: 1.39"

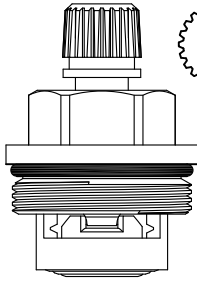

22  
1-4

GASKET: 890180 O-RING INCLUDED  
SEAL: 898500  
DISC SET: 112530-PKG

LF450931  
LF450932

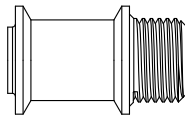

SEAT INCLUDED: LF646950

UNKNOWN  
LENGTH: 1.52"

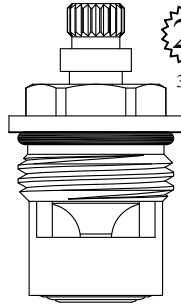

20  
3-20

GASKET: 890170 O-RING INCLUDED  
SEAL: 898500  
DISC SET: 112530-PKG

LF450991  
LF450992

FOR ARTISTIC BRASS  
LENGTH: 1.40"

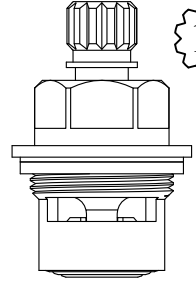

12  
1-2

GASKET: 895100 INCLUDED  
SEAL: 898500  
DISC SET: 112530-PKG

LF450941  
LF450942

FOR UNION BRASS  
LENGTH: 1.45"

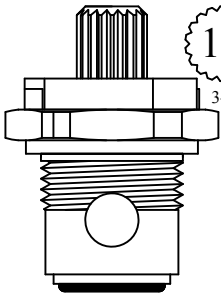

18  
3-3

GASKET: 895100 INCLUDED

LF452121  
LF452122

FOR SAYCO  
LENGTH: 1.49"

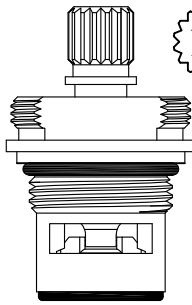

16  
2-3

Chrome Plated  
Gland

GASKET: 890170 O-RING INCLUDED  
SEAL: 898540  
DISC SET: 112530-PKG

LF451231  
LF451232

FOR ARTISTIC BRASS  
LENGTH: 1.53"

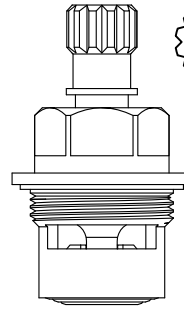

12  
1-2

GASKET: 895100 INCLUDED  
SEAL: 898500  
DISC SET: 112530-PKG

LF451191  
LF451192

UNKNOWN  
LENGTH: 1.54"

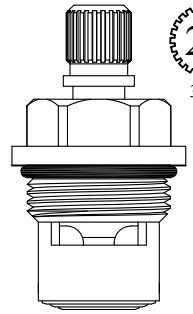

24  
3-18

Chrome Plated  
Unit

GASKET: 890170 O-RING INCLUDED  
SEAL: 898500  
DISC SET: 112530-PKG

LF451201  
LF451202

FOR AUBURN BRASS  
LENGTH: 1.57"

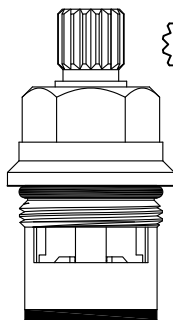

16  
2-3

Nickel Plated  
Gland

GASKET: 890160 O-RING INCLUDED  
SEAL: 893030  
DISC SET: 151380-PKG

LF450901  
LF450902

UNKNOWN  
LENGTH: 1.59"

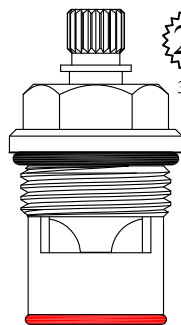

20  
3-20

GASKET: 890170 O-RING INCLUDED  
SEAL: 898580-R/B  
DISC SET: 151380-PKG

LF451261  
LF451262

UNKNOWN  
LENGTH: 1.63"

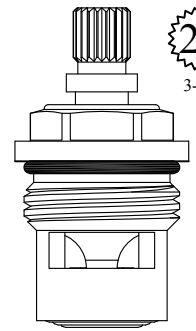

20  
3-20

GASKET: 890170 O-RING INCLUDED  
SEAL: 898500  
DISC SET: 112530-PKG

LF451281  
LF451282

# CERAMIC DISC CARTRIDGES

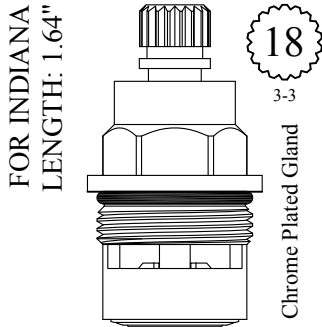

GASKET: 890170 O-RING INCLUDED  
SEAL: 898510-W  
DISC SET: 151380-PKG

LF451901  
LF451902

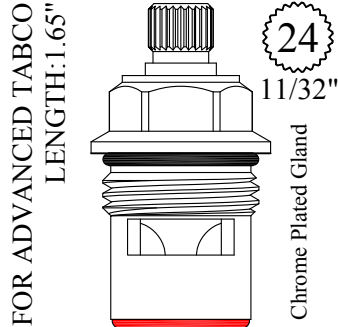

GASKET: 890170 O-RING INCLUDED  
SEAL: 898570-R/B  
DISC SET: 151380-PKG

LF452601  
LF452602

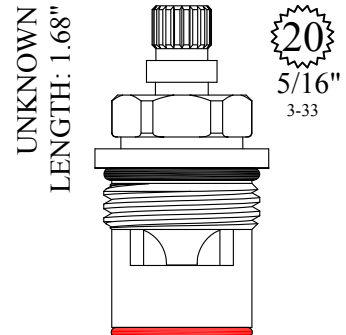

GASKET: 890170 O-RING INCLUDED  
SEAL: 898580-R/B  
DISC SET: 151380-PKG

LF452611  
LF452612



GASKET: 890170 O-RING INCLUDED  
SEAL: 898570-R/B  
DISC SET: 151380-PKG

LF452621  
LF452622

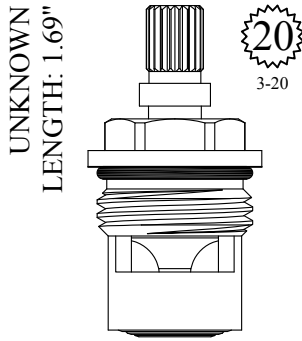

GASKET: 890170 O-RING INCLUDED  
SEAL: 898500  
DISC SET: 112530-PKG

LF452381  
LF452382

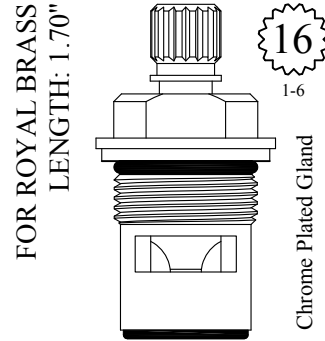

GASKET: 890160 O-RING INCLUDED  
SEAL: 898540  
DISC SET: 112530-PKG

LF451501  
LF451502

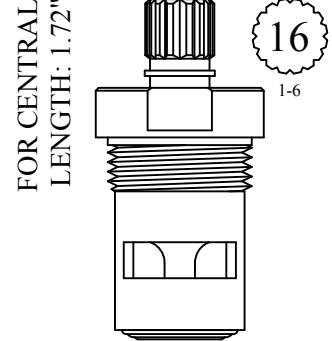

GASKET INCLUDED: 895270  
SEAL: 898500  
DISC SET: 112530-PKG

LF455901  
LF455902

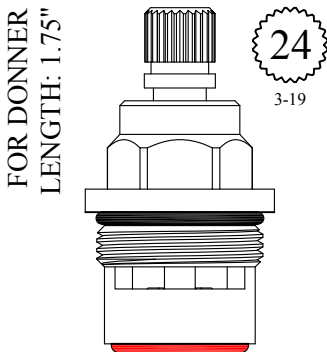

GASKET: 890180 O-RING INCLUDED  
SEAL: 898570-R/B  
DISC SET: 151380-PKG

LF455301  
LF455302

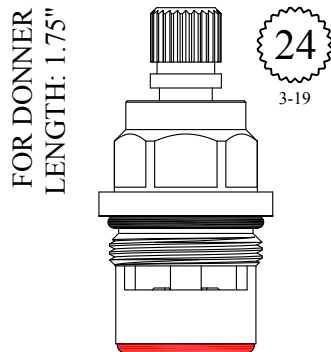

GASKET: 890170 O-RING INCLUDED  
SEAL: 898570-R/B  
DISC SET: 151380-PKG

LF455311  
LF455312

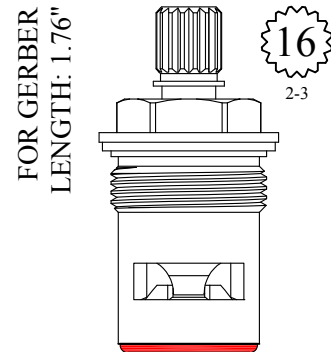

GASKET: 895140 INCLUDED  
SEAL: 898570-R/B  
DISC SET: 151380-PKG

LF455951  
LF455952

# CERAMIC DISC CARTRIDGES

FOR PRICE PFISTER  
LENGTH: 1.78"

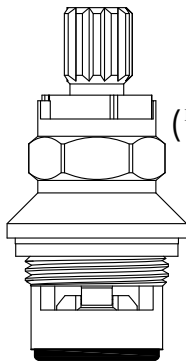

12  
1-2  
(LESS ONE  
SPLINE)

Nickel Plated Unit

FOR PACIFICA  
LENGTH: 1.80"

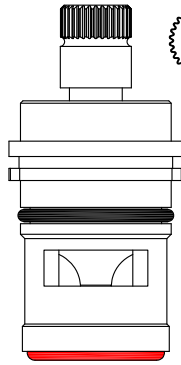

32  
3-23

FOR PREMIER  
LENGTH: 1.81"

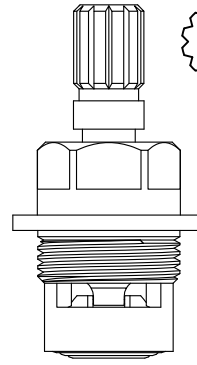

12  
1-2

Chrome Plated Unit

UNKNOWN  
LENGTH: 1.81"

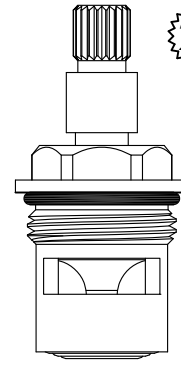

20  
3-20

GASKET: 895190 INCLUDED  
SEAL: 898540  
DISC SET: 112530-PKG

LF452801  
LF452802

GASKET: 890170 O-RING INCLUDED  
SEAL: 898570-R/B  
DISC SET: 151380-PKG

LF456221  
LF456222

SEAL: 898500  
DISC SET: 112530-PKG

LF455981  
LF455982

GASKET: 890170 O-RING INCLUDED  
SEAL: 898500  
DISC SET: 112530-PKG

LF456031  
LF456032

UNKNOWN  
LENGTH: 1.85"

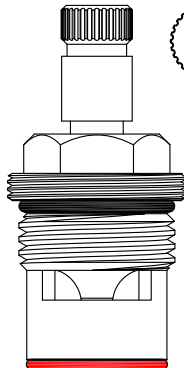

30  
3-35

Chrome Plated Unit

UNKNOWN  
LENGTH: 1.86"

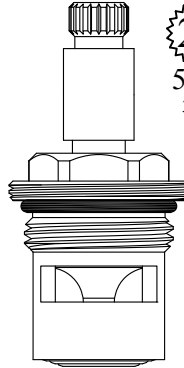

20  
5/16  
3-33

UNKNOWN  
LENGTH: 1.86"

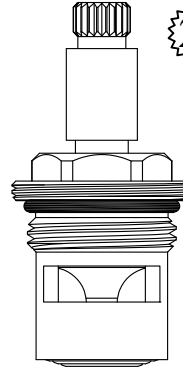

20  
3-20

GASKET: 890170 O-RING INCLUDED  
SEAL: 898580-R/B  
DISC SET: 151380-PKG

LF456481  
LF456482

GASKET: 890170 O-RING INCLUDED  
SEAL: 898500  
DISC SET: 112530-PKG

LF456251  
LF456252

GASKET: 890170 O-RING INCLUDED  
SEAL: 898500  
DISC SET: 112530-PKG

LF456271  
LF456272

UNKNOWN  
LENGTH: 1.86"

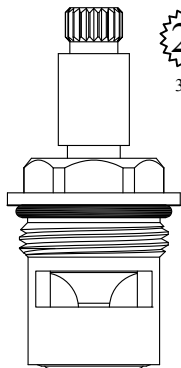

20  
3-20

UNKNOWN  
LENGTH: 1.86"

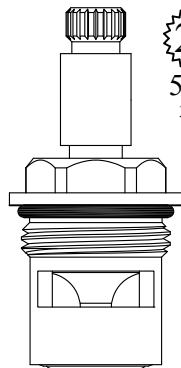

20  
5/16  
3-33

FOR T & S  
LENGTH: 1.87"

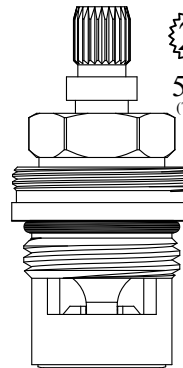

22  
5/16  
(T & S)

GASKET: 890170 O-RING INCLUDED  
SEAL: 898500  
DISC SET: 112530-PKG

LF456281  
LF456282

GASKET: 890170 O-RING INCLUDED  
SEAL: 898500  
DISC SET: 112530-PKG

LF456291  
LF456292

GASKET: 890170 O-RING INCLUDED  
SEAL: 898500  
DISC SET: 112530-PKG

LF456261  
LF456262

# CERAMIC DISC CARTRIDGES

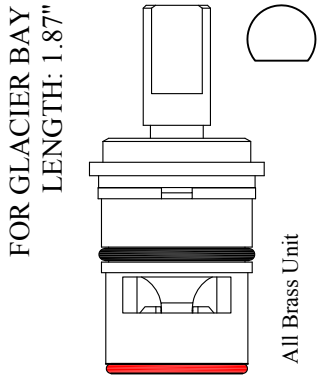

GASKET: 890170 O-RING INCLUDED  
SEAL: 898580-R/B  
DISC SET: 151380-PKG

LF456341  
LF456342

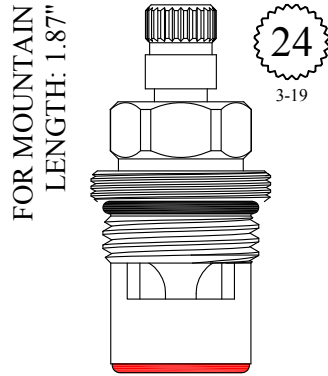

GASKET: 890170 O-RING INCLUDED  
SEAL: 898570-R/B  
DISC SET: 151380-PKG

LF456371  
LF456372

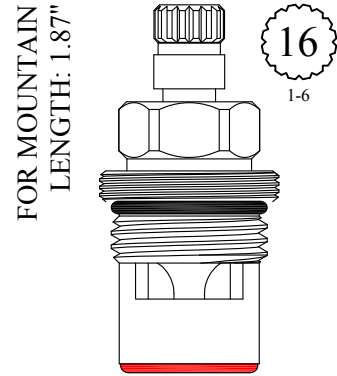

GASKET: 890170 O-RING INCLUDED  
SEAL: 898570-R/B  
DISC SET: 151380-PKG

LF456381  
LF456382

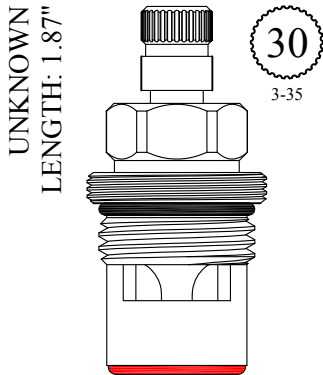

GASKET: 890170 O-RING INCLUDED  
SEAL: 898570-R/B  
DISC SET: 151380-PKG

LF456411  
LF456412

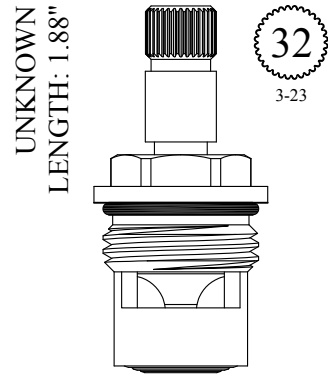

GASKET: 890170 O-RING INCLUDED  
SEAL: 898500  
DISC SET: 112530-PKG

LF455381  
LF455382

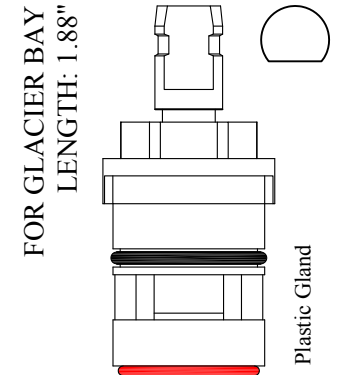

GASKET: 890170 O-RING INCLUDED  
SEAL: 898580-R  
DISC SET: 115520-PKG

LF456201  
LF456202

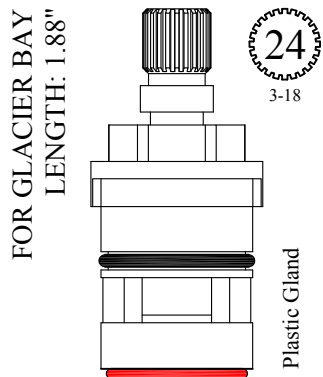

GASKET: 890170 O-RING INCLUDED  
SEAL: 898580-R  
DISC SET: 115520-PKG

LF456231  
LF456232

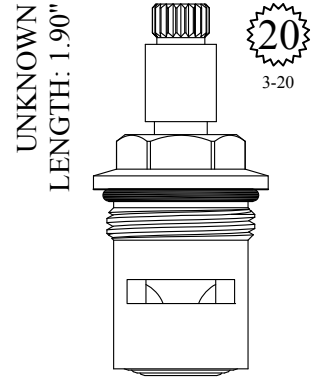

GASKET: 890170 O-RING INCLUDED  
SEAL: 898500  
DISC SET: 112530-PKG

LF456881  
LF456882

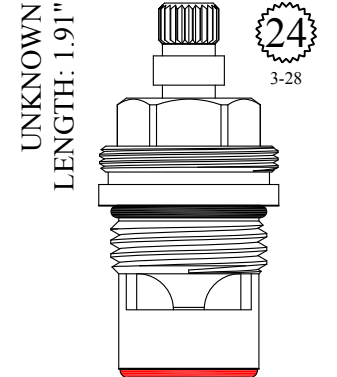

GASKET: 890170 O-RING INCLUDED  
SEAL: 898570-R/B  
DISC SET: 151380-PKG

LF459131  
LF459132



# CERAMIC DISC CARTRIDGES

FOR INDIANA  
LENGTH: 1.91"

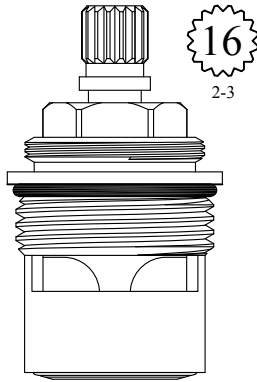

GASKET: 890210 O-RING INCLUDED  
SEAL: 898520  
DISC SET: 109850-PKG

400811  
400812

FOR INDIANA  
LENGTH: 1.91"

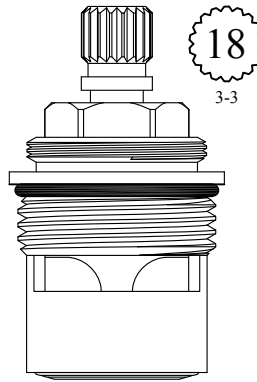

GASKET: 890210 O-RING INCLUDED  
SEAL: 898520  
DISC SET: 109850-PKG

400861  
400862

FOR GLACIER BAY  
LENGTH: 1.91"

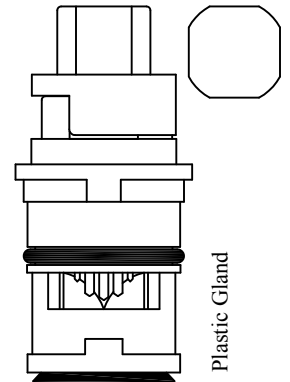

GASKET: 890170 O-RING INCLUDED  
SEAL: 898510  
DISC SET: 151380-PKG

LF456351  
LF456352

FOR MILWAUKEE  
LENGTH: 1.92"

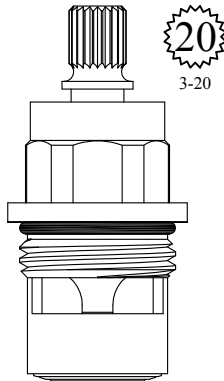

GASKET: 890170 O-RING INCLUDED  
SEAL: 898510-W  
DISC SET: 151380-PKG

LF456401  
LF456402

FOR NICOLAZZI / ROHL  
LENGTH: 1.92"

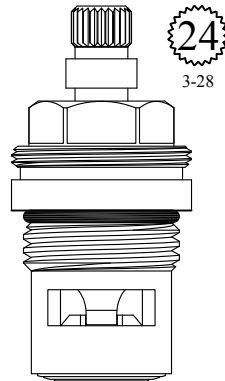

GASKET: 890170 O-RING INCLUDED  
SEAL: 898510-W  
DISC SET: 151380-PKG

LF456921  
LF456922

FOR SIMBOLO  
LENGTH: 1.92"

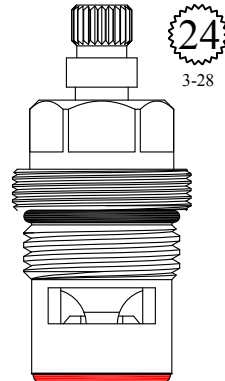

GASKET: 890170 O-RING INCLUDED  
SEAL: 898570-R/B  
DISC SET: 151380-PKG

LF456911  
LF456912

FOR DOBO  
LENGTH: 1.93"

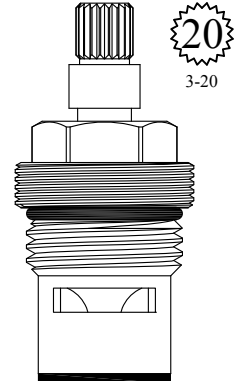

GASKET: 890170 O-RING INCLUDED  
SEAL: 853030  
DISC SET: 151380-PKG

LF456391  
LF456392

FOR OMNI / EAGLE GROUP  
LENGTH: 1.95"

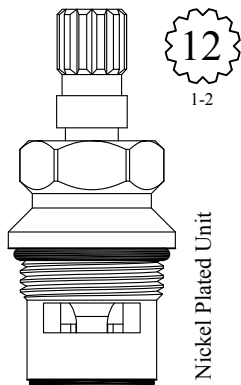

GASKET: 890170 O-RING INCLUDED  
SEAL: 898540  
DISC SET: 112530-PKG

LF458821  
LF458822

FOR STERLING FAUCET  
LENGTH: 1.94"

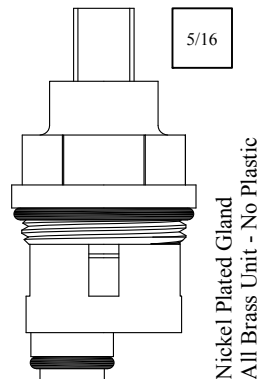

GASKET: 890180 O-RING INCLUDED

LF458171  
LF458172

FOR AQUASOURCE  
LENGTH: 1.94"

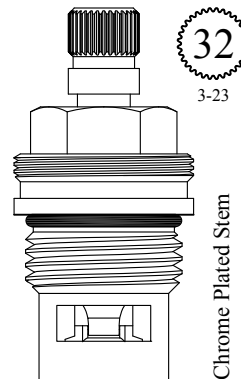

GASKET: 890170 O-RING INCLUDED  
SEAL: 898500  
DISC SET: 112530-PKG

LF457311  
LF457312

# CERAMIC DISC CARTRIDGES

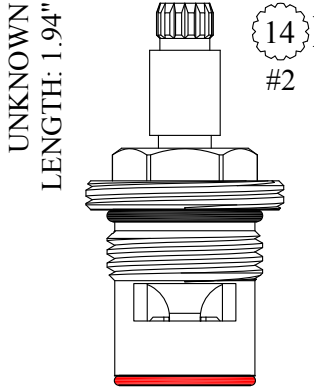

GASKET: 890170 O-RING INCLUDED  
SEAL: 898580-R/B  
DISC SET: 151380-PKG

LF458431  
LF458432

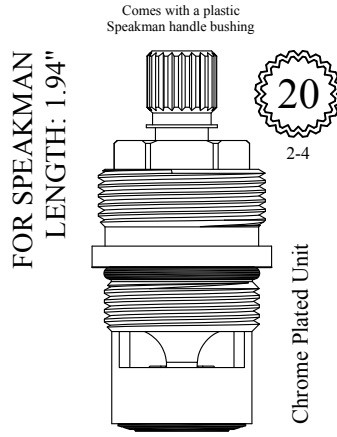

GASKET: 890170 O-RING INCLUDED  
SEAL: 898510-W  
DISC SET: 151380-PKG

LF458801  
LF458802

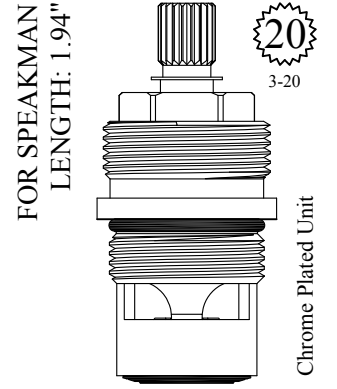

GASKET: 890170 O-RING INCLUDED  
SEAL: 898510-W  
DISC SET: 151380-PKG

LF458811  
LF458812

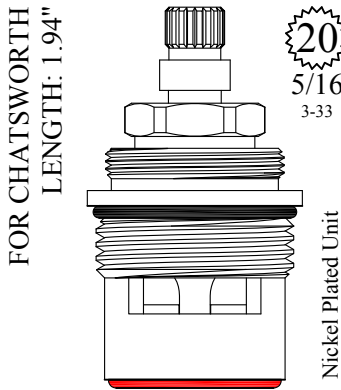

GASKET: 890210 O-RING INCLUDED  
SEAL: 898610-R  
DISC SET: 109850-PKG

400971  
400972

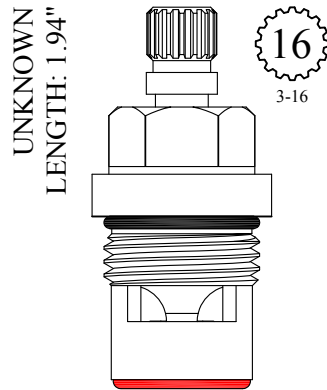

GASKET: 890170 O-RING INCLUDED  
SEAL: 898570-R/B  
DISC SET: 151380-PKG

LF458871  
LF458872

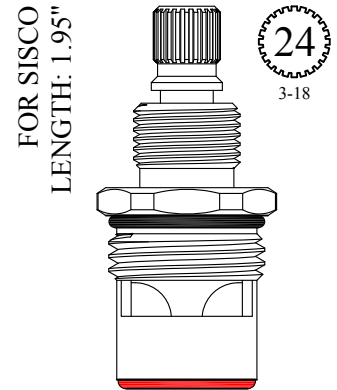

GASKET: 890170 O-RING INCLUDED  
SEAL: 898570-R/B  
DISC SET: 151380-PKG

LF456901  
LF456902

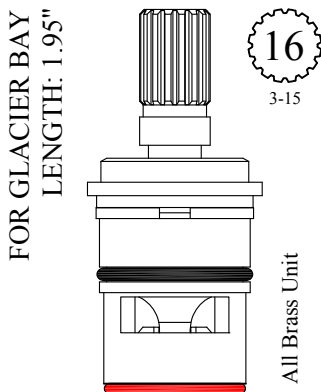

GASKET: 890170 O-RING INCLUDED  
SEAL: 898580-R/B  
DISC SET: 151380-PKG

LF457611  
LF457612

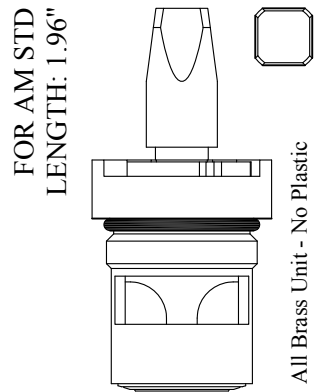

GASKET: 890170 O-RING INCLUDED  
SEAL: 898510-W  
DISC SET: 151380-PKG

LF458901  
LF458902

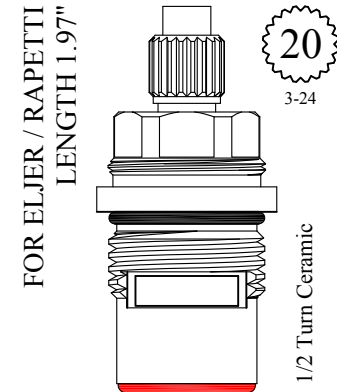

GASKET: 890170 O-RING INCLUDED  
SEAL: 898570-R/B  
DISC SET: 124290-PKG

LF457361  
LF457362

# CERAMIC DISC CARTRIDGES

FOR ARTISTIC BRASS  
LENGTH 1.97"

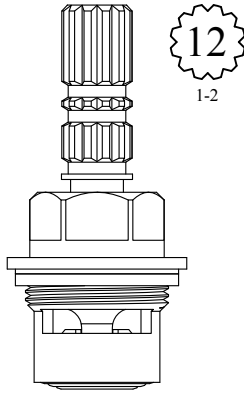

GASKET: 895100 INCLUDED  
SEAL: 898500  
DISC SET: 112530-PKG

LF458161  
LF458162

FOR BROADWAY  
LENGTH 1.97"

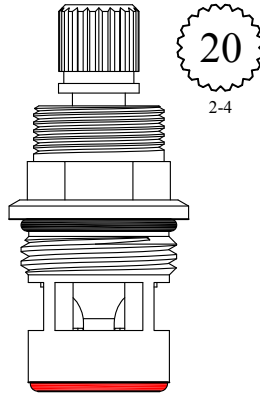

GASKET: 890170 O-RING INCLUDED  
SEAL: 898570-R/B  
DISC SET: 151380-PKG

LF457601  
LF457602

FOR ARTISTIC BRASS  
LENGTH 1.97"

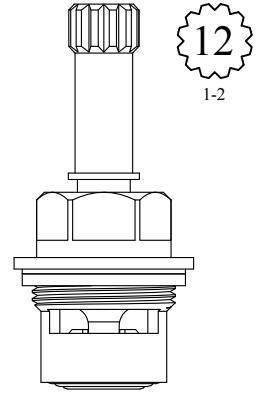

GASKET: 895100 INCLUDED  
SEAL: 898500  
DISC SET: 112530-PKG

LF458151  
LF458152

FOR PRICE PFISTER  
LENGTH: 1.98"

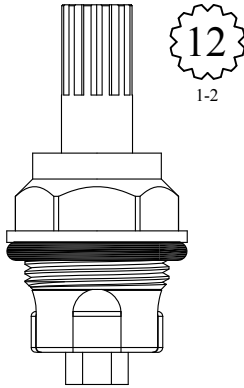

GASKET: 891100 O-RING INCLUDED

LF456331  
LF456332

FOR ELJER  
LENGTH 1.98"

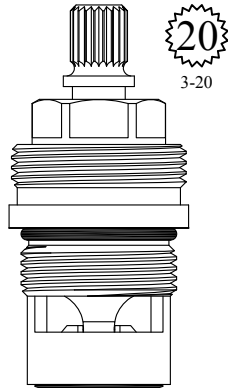

GASKET: 890170 O-RING INCLUDED  
SEAL: 898510  
DISC SET: 151380-PKG

LF457701  
LF457702

FOR J.R. SMITH HYDRANT  
LENGTH 1.98"

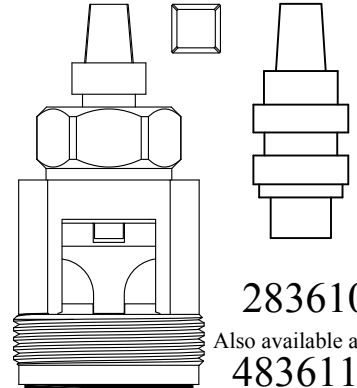

SEAL: 823420  
DISC SET: 109850-PKG

483611

283610-1  
Also available as a kit  
483611-1

Kit includes:  
(1) 283610-1  
(1) 483611

FOR FOREMOST  
LENGTH: 2.00"

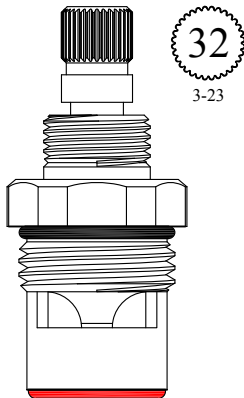

GASKET: 890170 O-RING INCLUDED  
SEAL: 898580-R/B  
DISC SET: 151380-PKG

LF459271  
LF459272

UNKNOWN  
LENGTH 2.00"

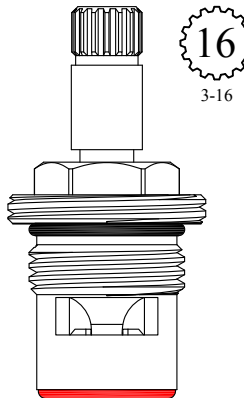

GASKET: 890170 O-RING INCLUDED  
SEAL: 898570-R/B  
DISC SET: 151380-PKG

LF459431  
LF459432

FOR PEGASUS  
FOR SIGN OF THE CRAB  
LENGTH 2.00"

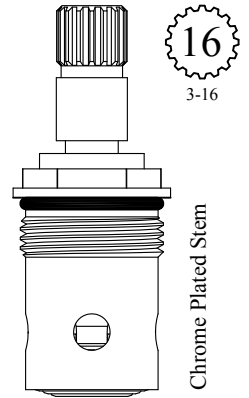

GASKET: 890160 O-RING INCLUDED  
SEAL: 898500  
DISC SET: 112530-PKG

LF457901  
LF457902

# CERAMIC DISC CARTRIDGES

FOR GLACIER BAY  
LENGTH: 2.00"

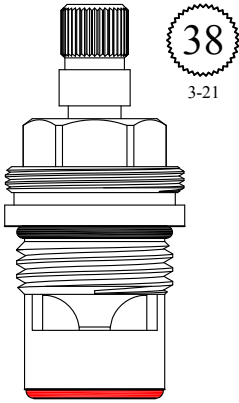

GASKET: 890170 O-RING INCLUDED  
SEAL: 898570-R/B  
DISC SET: 151380-PKG

LF458341  
LF458342

FOR PIONEER  
LENGTH: 2.01"

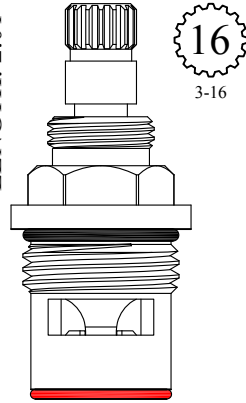

GASKET: 890170 O-RING INCLUDED  
SEAL: 898580-R/B  
DISC SET: 151380-PKG

LF459681  
LF459682

FOR PAINI  
LENGTH: 2.02"

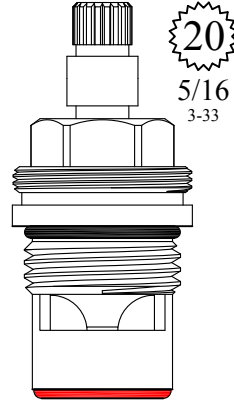

GASKET: 890170 O-RING INCLUDED  
SEAL: 898570-R/B  
DISC SET: 151380-PKG

LF458891  
LF458892

FOR BALOCCHI  
LENGTH: 2.02"

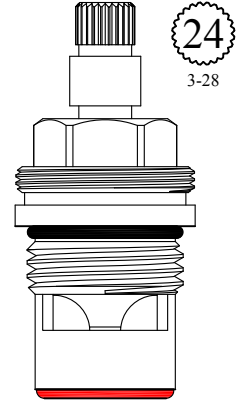

GASKET: 890170 O-RING INCLUDED  
SEAL: 898570-R/B  
DISC SET: 151380-PKG

LF459341  
LF459342

FOR FRANKE

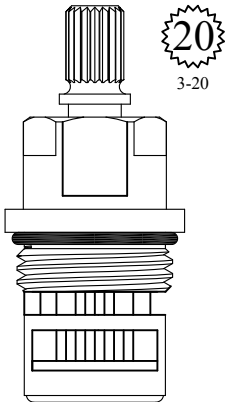

Not Available  
USE LF458941/LF458942

FOR FRANKE  
LENGTH: 2.03"

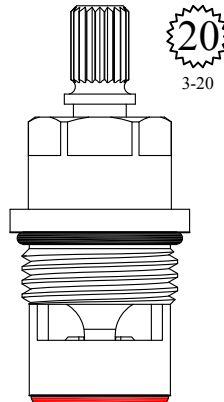

GASKET: 890170 O-RING INCLUDED  
SEAL: 898570-R/B  
DISC SET: 151380-PKG

LF458941  
LF458942

UNKNOWN  
LENGTH: 2.03"

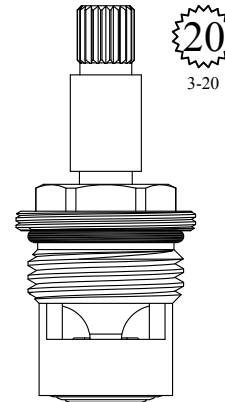

GASKET: 890170 O-RING INCLUDED  
SEAL: 898500  
DISC SET: 112530-PKG

LF459281  
LF459282

UNKNOWN  
LENGTH: 2.03"

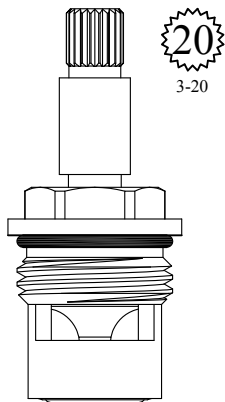

GASKET: 890170 O-RING INCLUDED  
SEAL: 898500  
DISC SET: 112530-PKG

LF459381  
LF459382

FOR SEARS  
LENGTH: 2.03"

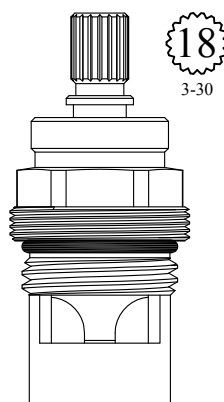

GASKET: 890170 O-RING INCLUDED  
SEAL: 898510  
DISC SET: 151380-PKG

LF459171  
LF459172

FOR ELKAY  
LENGTH: 2.03"

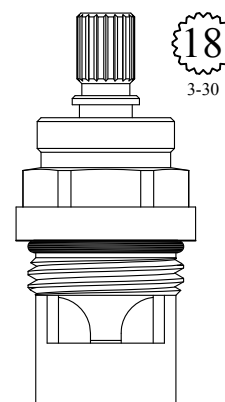

GASKET: 890170 O-RING INCLUDED  
SEAL: 898510  
DISC SET: 151380-PKG

LF459181  
LF459182

# CERAMIC DISC CARTRIDGES

FOR SEPCO  
LENGTH: 2.04"

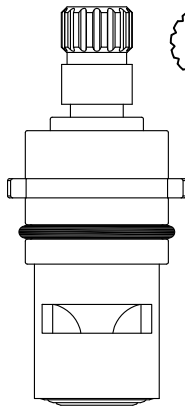

15  
3-27

GASKET: 890170 O-RING INCLUDED  
SEAL: 898500  
DISC SET: 112530-PKG

LF458841  
LF458842

FOR SPRINGHOUSE  
LENGTH: 2.04"

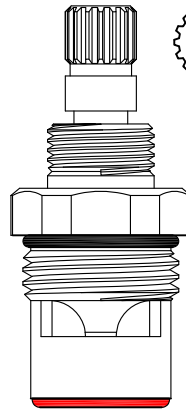

16  
3-16

GASKET: 890170 O-RING INCLUDED  
SEAL: 898580-R/B  
DISC SET: 151380-PKG

LF459771  
LF459772

UNKNOWN  
LENGTH: 2.04"

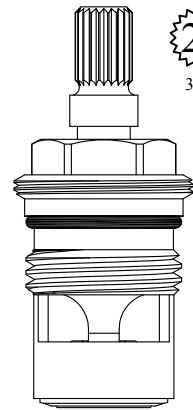

20  
3-20

GASKET: 890170 O-RING INCLUDED  
SEAL: 898510-W  
DISC SET: 151380-PKG

LF459161  
LF459162

FOR PHYLRICH

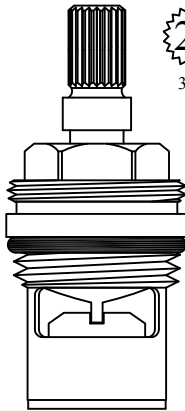

20  
3-20

Style Not Available  
USE LF459201/LF459202

(ALTMANS  
FOR THG)  
(UNIVERSAL RUNDLE)  
LENGTH: 2.04"

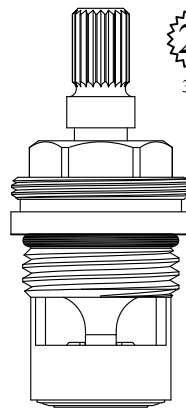

20  
3-20

GASKET: 890170 O-RING INCLUDED  
SEAL: 898510-W  
DISC SET: 151380-PKG

LF459201  
LF459202

Also available with  
nickel plated gland

LF459201-N / LF459202-N

FOR CONCINNY  
LENGTH: 2.04"

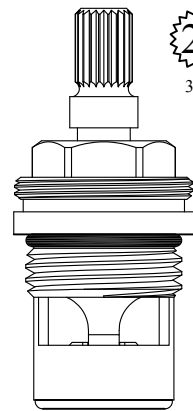

20  
3-20

GASKET: 890170 O-RING INCLUDED  
SEAL: 898570-W  
DISC SET: 151380-PKG

LF459231  
LF459232

Chrome Plated Unit

UNKNOWN  
LENGTH: 2.04"

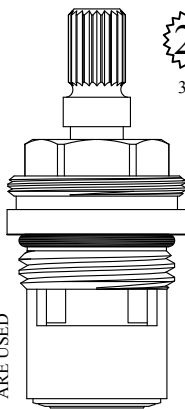

20  
3-20

GASKET: 890170 O-RING INCLUDED  
SEAL: 898510-W  
DISC SET: 124290-PKG

LF459211  
LF459212

FITS ALL BODIES  
WHERE 459201/459202  
ARE USED

1/2 Turn Ceramic

FOR SIGN OF THE CRAB  
LENGTH: 2.04"

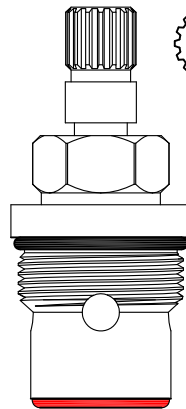

16  
3-16

GASKET: 890170 O-RING INCLUDED  
SEAL: 898570-R/B  
DISC SET: 151380-PKG

LF459371  
LF459372

Chrome Plated Stem

FOR ARSELUX  
LENGTH: 2.04"

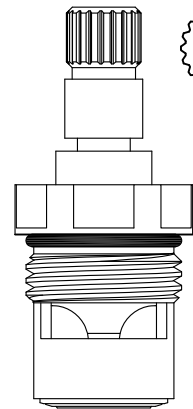

19  
1-7

GASKET: 890170 O-RING INCLUDED  
SEAL: 898510  
DISC SET: 151380-PKG

LF461501  
LF461502

Chrome Plated Gland

# CERAMIC DISC CARTRIDGES

FOR MILWAUKEE  
LENGTH: 2.05"

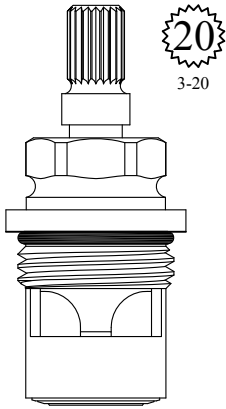

GASKET: 890170 O-RING INCLUDED  
SEAL: 898510-W  
DISC SET: 151380-PKG

**LF458191**  
**LF458192**

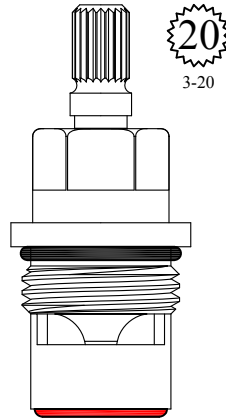

**Old Style Kohler**  
USE LF459331/LF459332

FOR KOHLER  
Nickel Plated Gland  
LENGTH: 2.05"

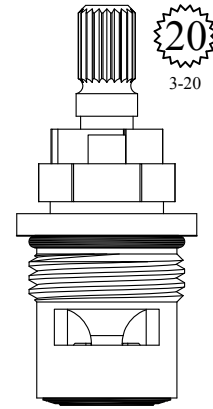

GASKET: 890170 O-RING INCLUDED  
SEAL: 898510  
DISC SET: 151380-PKG

**LF459331**  
**LF459332**



Also available with 19pt  
Kohler Adapter Broach #121230  
**LF460331 / LF460332**

FOR BELMONT  
LENGTH: 2.05"

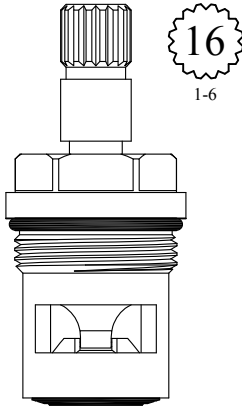

GASKET: 890170 O-RING INCLUDED  
SEAL: 898510  
DISC SET: 151380-PKG

**LF459261**  
**LF459262**

FOR OTTONE & MELODA  
LENGTH: 2.05"

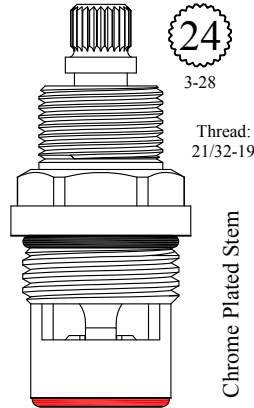

GASKET: 890170 O-RING INCLUDED  
SEAL: 898570-R/B  
DISC SET: 151380-PKG

**LF459691**  
**LF459692**

FOR DORNBRACHT  
LENGTH: 2.05"

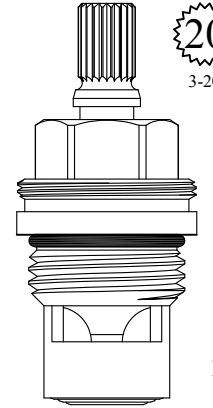

GASKET: 890170 O-RING INCLUDED  
SEAL: 898500  
DISC SET: 112530-PKG

**LF459751**  
**LF459752**

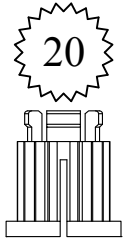

Comes with 20pt  
Dornbracht adapter:  
103200

UNKNOWN  
LENGTH: 2.06"

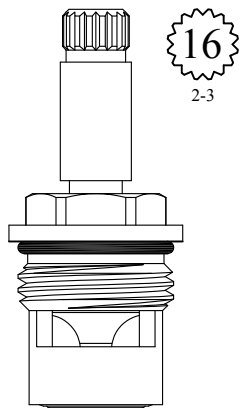

GASKET: 890170 O-RING INCLUDED  
SEAL: 898500  
DISC SET: 112530-PKG

**LF457291**  
**LF457292**

FOR KRONIN BY VIOLA  
LENGTH: 2.06"

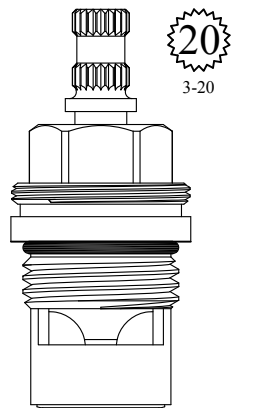

GASKET: 890170 O-RING INCLUDED  
SEAL: 898510-W  
DISC SET: 151380-PKG

**LF459291**  
**LF459292**

UNKNOWN  
LENGTH 2.07"

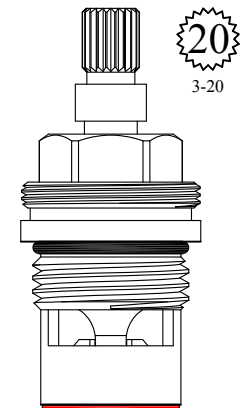

GASKET: 890170 O-RING INCLUDED  
SEAL: 898570-R/B  
DISC SET: 151380-PKG

**LF458861**  
**LF458862**

# CERAMIC DISC CARTRIDGES

FOR BRIZO (DELTA)  
LENGTH: 2.07"

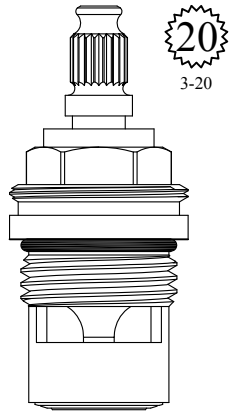

GASKET: 890170 O-RING INCLUDED  
SEAL: 898510-W  
DISC SET: 151380-PKG

LF459191  
LF459192

FOR MANGORI  
LENGTH: 2.07"

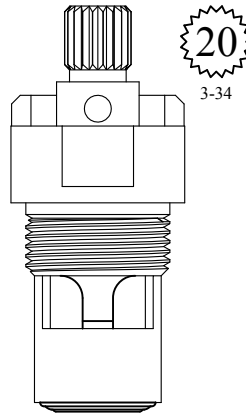

SEAL: 898500  
DISC SET: 112530-PKG

LF459471  
LF459472

FOR WELLINGTON  
LENGTH: 2.08"

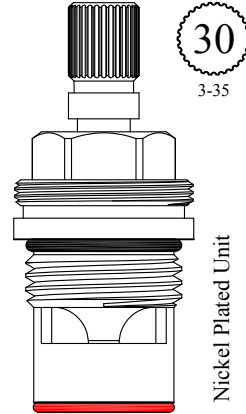

GASKET: 890170 O-RING INCLUDED  
SEAL: 898580-R/B  
DISC SET: 151380-PKG

LF459351  
LF459352

FOR KALLISTA  
LENGTH: 2.08"

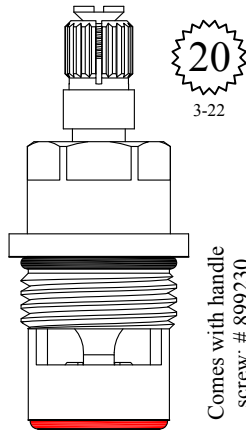

GASKET: 890170 O-RING INCLUDED  
SEAL: 898570-R/B  
DISC SET: 151380-PKG

LF459401  
LF459402

FOR AVILION / FRANKE  
LENGTH: 2.08"

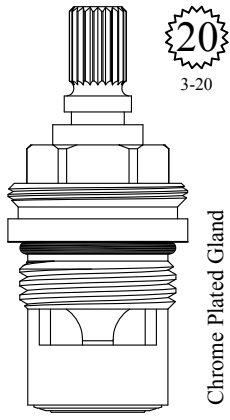

GASKET: 890170 O-RING INCLUDED  
SEAL: 898510-W  
DISC SET: 151380-PKG

LF459491  
LF459492

FOR FRANKE / ROHL  
LENGTH: 2.08"

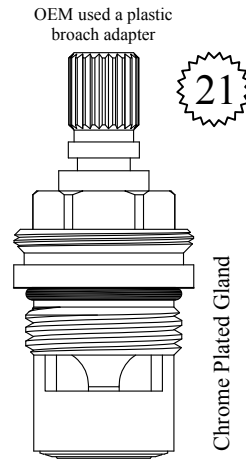

GASKET: 890170 O-RING INCLUDED  
SEAL: 898510-W  
DISC SET: 151380-PKG

LF459541  
LF459542

UNKNOWN  
LENGTH: 2.08"

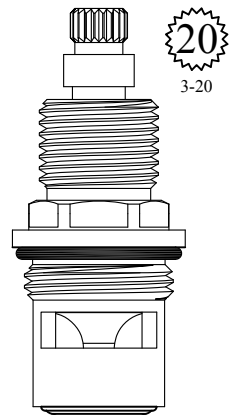

GASKET: 890170 O-RING INCLUDED  
SEAL: 898500  
DISC SET: 112530-PKG

LF459591  
LF459592

FOR NICOLAZZI  
LENGTH: 2.08"

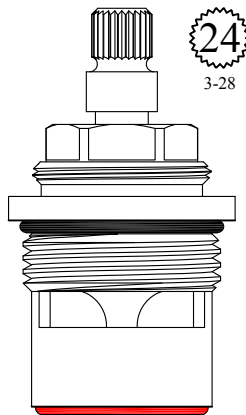

GASKET: 890210 O-RING INCLUDED  
SEAL: 898610-R/B  
DISC SET: 109850-PKG

401011  
401012

FOR CRANE  
CERAMIC CONVERSION FOR DIAL-EZE  
LENGTH: 2.08"

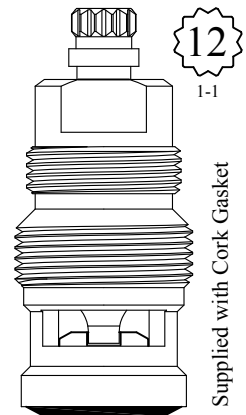

GASKET: 895250 INCLUDED  
DISC SET: 151380-PKG

LF459521  
LF459522

# CERAMIC DISC CARTRIDGES

FOR PAUL / PHYLRICH  
LENGTH: 2.08"

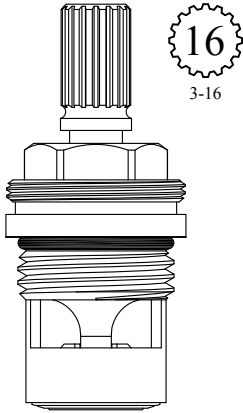

GASKET: 890170 O-RING INCLUDED  
SEAL: 898510-W  
DISC SET: 151380-PKG

LF461901  
LF461902

FOR SANTEC  
LENGTH: 2.08"

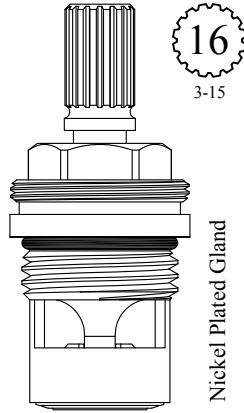

GASKET: 890170 O-RING INCLUDED  
SEAL: 898510-W  
DISC SET: 151380-PKG

LF461911  
LF461912

FOR ZURN  
LENGTH: 2.08"

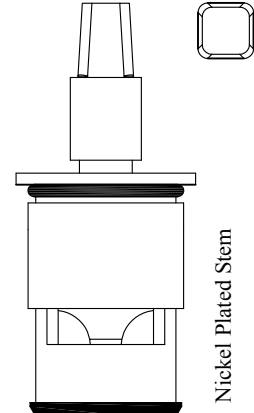

GASKET: 890170 O-RING INCLUDED  
SEAL: 898590 & LF132250  
DISC SET: 151380-PKG

LF459441  
LF459442

FOR CHICAGO  
LENGTH: 2.09"

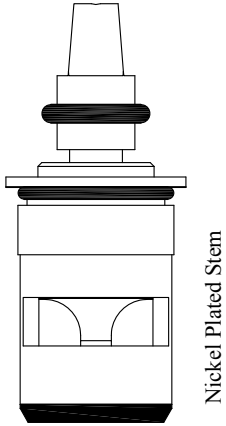

GASKET: 890170 O-RING INCLUDED  
SEAL: 898590 & LF132250  
DISC SET: 151380-PKG

LF459411  
LF459412

UNKNOWN  
LENGTH: 2.09"

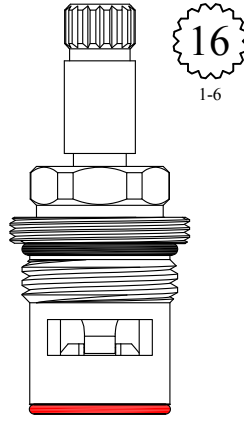

GASKET: 890170 O-RING INCLUDED  
SEAL: 898580-R/B  
DISC SET: 151380-PKG

LF459531  
LF459532

FOR KALLISTA  
LENGTH: 2.09"

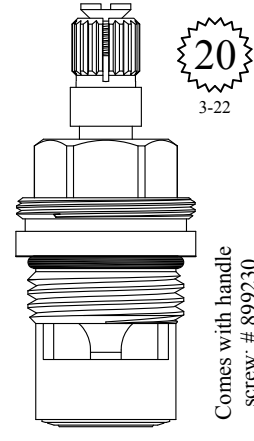

GASKET: 890170 O-RING INCLUDED  
SEAL: 898510-W  
DISC SET: 151380-PKG

LF459391  
LF459392

FOR JADO  
LENGTH 2.10"

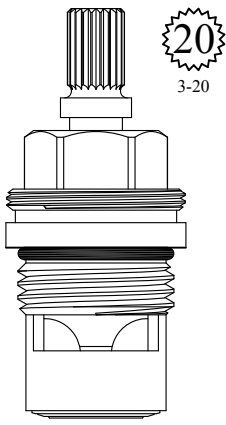

GASKET: 890170 O-RING INCLUDED  
SEAL: 898510-W  
DISC SET: 151380-PKG

LF459301  
LF459302

FOR SANTEC  
LENGTH 2.10"

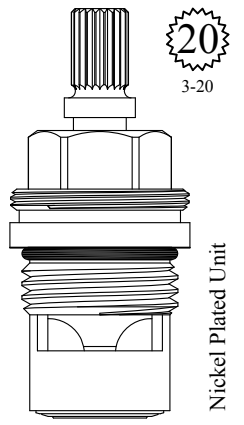

GASKET: 890170 O-RING INCLUDED  
SEAL: 898510-W  
DISC SET: 151380-PKG

LF459311  
LF459312

FOR BROADWAY  
LENGTH: 2.10"

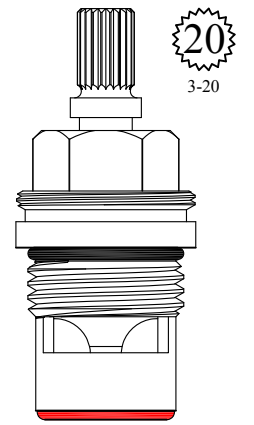

GASKET: 890170 O-RING INCLUDED  
SEAL: 898570-R/B  
DISC SET: 151380-PKG

LF459321  
LF459322



# CERAMIC DISC CARTRIDGES

FOR SISCO  
LENGTH: 2.10"

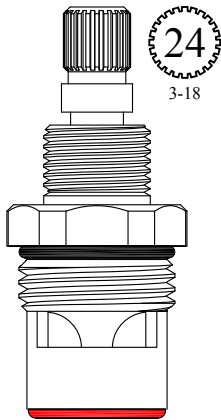

24  
3-18

GASKET: 890170 O-RING INCLUDED  
SEAL: 898580-R/B  
DISC SET: 151380-PKG

LF459221  
LF459222

FOR ELKAY  
LENGTH: 2.10"

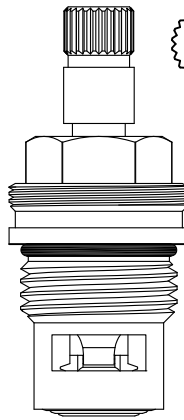

24  
3-19

GASKET: 890170 O-RING INCLUDED  
SEAL: 898500  
DISC SET: 112530-PKG

LF459581  
LF459582

UNKNOWN  
LENGTH: 2.11"

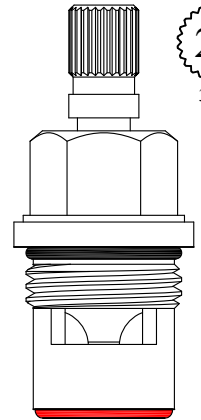

24  
3-19

GASKET: 890170 O-RING INCLUDED  
SEAL: 898570-R/B  
DISC SET: 151380-PKG

LF459421  
LF459422

UNKNOWN  
LENGTH: 2.11"

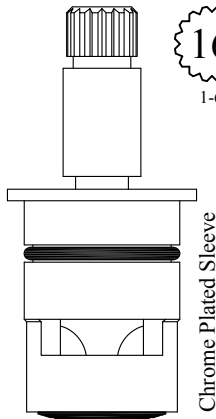

16  
1-6

GASKET: 890170 O-RING INCLUDED  
SEAL: 898510  
DISC SET: 151380-PKG

LF459641  
LF459642

UNKNOWN  
LENGTH: 2.11"

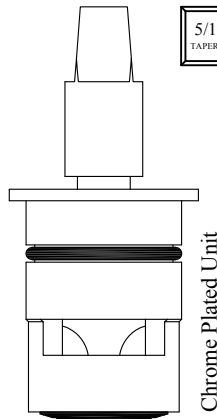

5/16  
TAPERED

GASKET: 890170 O-RING INCLUDED  
SEAL: 898510  
DISC SET: 151380-PKG

LF459671  
LF459672

FOR REID WATSON  
LENGTH: 2.12"

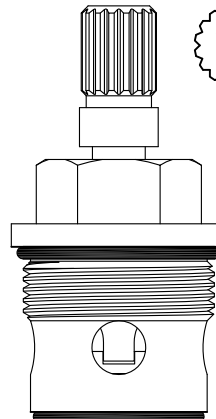

16  
1-5

GASKET: 890210 O-RING INCLUDED  
SEAL: 898530  
DISC SET: 109850-PKG

401151  
401152

FOR GROHE  
LENGTH: 2.12"

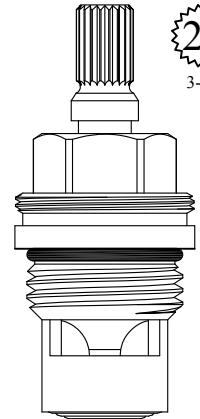

20  
3-20

GASKET: 890170 O-RING INCLUDED  
SEAL: 898500  
DISC SET: 112530-PKG

LF459501  
LF459502

FOR KOHLER  
CERAMIC CONVERSION FOR LF459101/2  
LENGTH: 2.12"

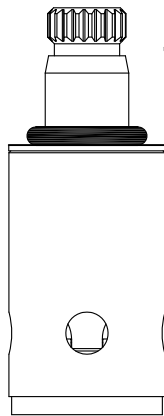

19  
1-7

DISC SET: 151380-PKG

LF459601  
LF459602

UNKNOWN  
LENGTH: 2.12"

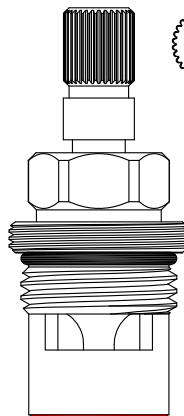

32  
3-23

GASKET: 890170 O-RING INCLUDED  
SEAL: 898570-R/B  
DISC SET: 151380-PKG

LF460371  
LF460372

FOR REID WATSON  
LENGTH: 2.13"

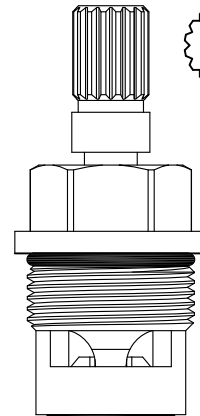

16  
1-5

GASKET: 890180 O-RING INCLUDED  
SEAL: 898510  
DISC SET: 151380-PKG

LF459451  
LF459452

# CERAMIC DISC CARTRIDGES

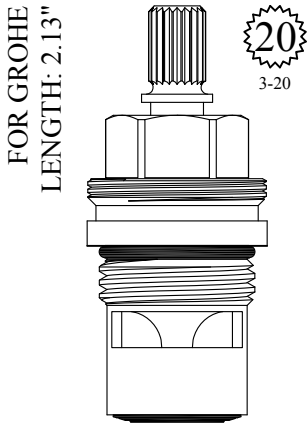

GASKET: 890170 O-RING INCLUDED  
SEAL: 898510  
DISC SET: 151380-PKG

LF459701  
LF459702

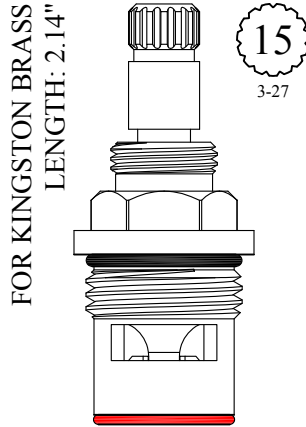

GASKET: 890170 O-RING INCLUDED  
SEAL: 898580-R/B  
DISC SET: 151380-PKG

LF459711  
LF459712

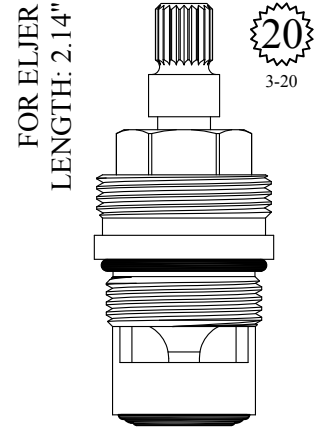

GASKET: 890170 O-RING INCLUDED  
SEAL: 898510  
DISC SET: 151380-PKG

LF459571  
LF459572

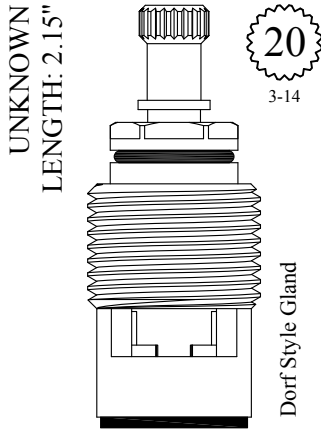

LF458981

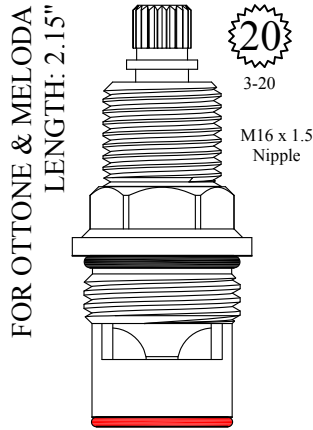

GASKET: 890170 O-RING INCLUDED  
SEAL: 898580-R/B  
DISC SET: 151380-PKG

LF460841  
LF460842

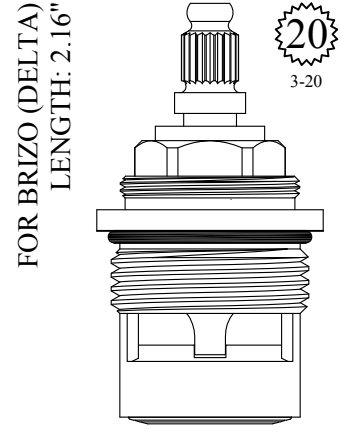

SEAL: 898520  
DISC SET: 109850-PKG

401101  
401102

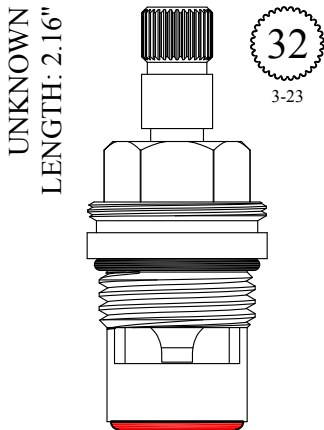

GASKET: 890170 O-RING INCLUDED  
SEAL: 898570-R/B  
DISC SET: 151380-PKG

LF459361  
LF459362

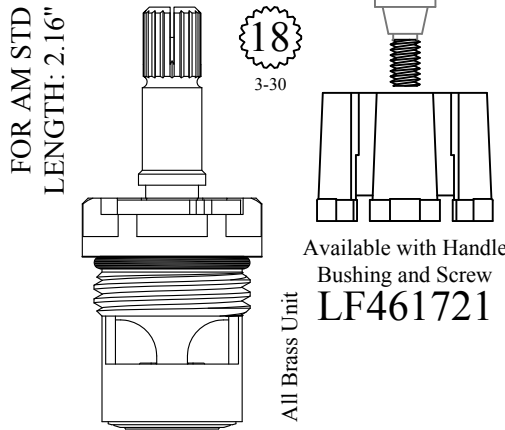

GASKET: 890170 O-RING INCLUDED  
SEAL: 898510-W  
DISC SET: 151380-PKG

LF461701  
LF461702

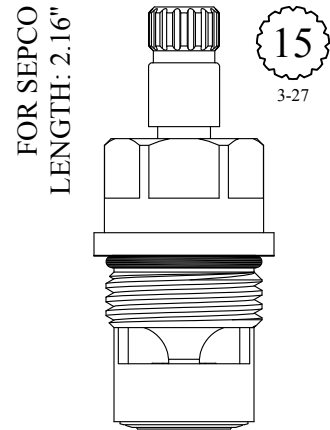

GASKET: 890170 O-RING INCLUDED  
SEAL: 898510-W  
DISC SET: 151380-PKG

LF462451  
LF462452

# CERAMIC DISC CARTRIDGES

FOR GLACIER BAY  
LENGTH: 2.17"

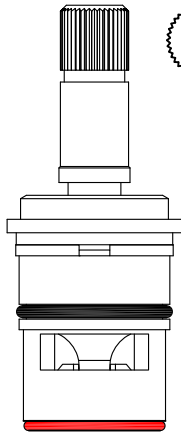

38  
3-21

All Brass Unit

GASKET: 890170 O-RING INCLUDED  
SEAL: 898580-R/B  
DISC SET: 151380-PKG

LF460611  
LF460612

FOR SAYCO  
LENGTH 2.17"

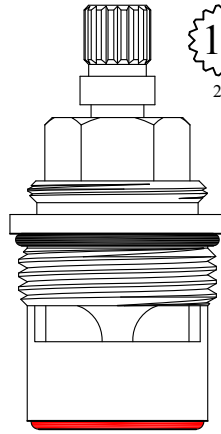

16  
2-3

GASKET: 890210 O-RING INCLUDED  
SEAL: 898610-R/B  
DISC SET: 109850-PKG

401051  
401052

FOR ELKAY  
LENGTH: 2.19"

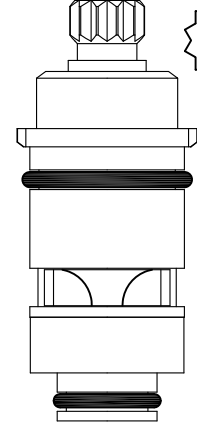

12  
3-10

Nickel Plated Stem

GASKET: 890170 O-RING INCLUDED  
DISC SET: 151380-PKG

LF461171  
LF461172

Also available with cap nut

LF461171-N / LF461172-N

FOR KOHLER OLD STYLE  
LENGTH: 2.18"

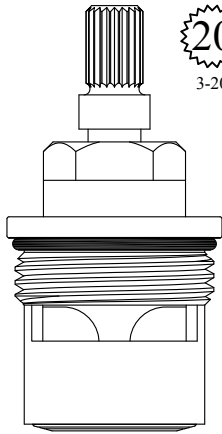

20  
3-20

GASKET: 890210 O-RING INCLUDED  
SEAL: 898520  
DISC SET: 109850-PKG

401271  
401272

FOR PHYLRICH, PAUL,  
MILWAUKEE, THG  
KOHLER (NEW STYLE)  
LENGTH: 2.18"

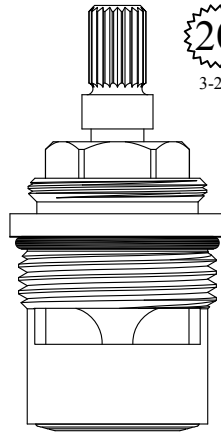

20  
3-20

GASKET: 890210 O-RING INCLUDED  
SEAL: 898520  
DISC SET: 109850-PKG

401121  
401122

FOR STERLING FAUCET  
LENGTH: 2.18"

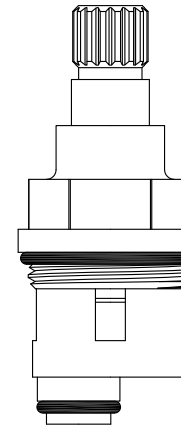

16  
1-5

Nickel Plated Gland  
All Brass Unit - No Plastic

GASKET: 890180 O-RING INCLUDED

LF458181  
LF458182

UNKNOWN  
LENGTH: 2.18"

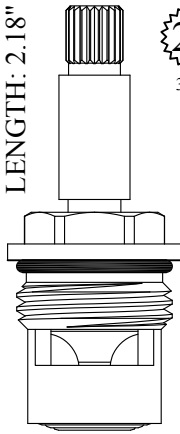

20  
3-20

GASKET: 890170 O-RING INCLUDED  
SEAL: 898500  
DISC SET: 112530-PKG

LF459561  
LF459562

UNKNOWN  
LENGTH: 2.17"

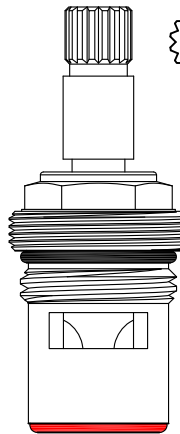

16  
2-3

GASKET: 890170 O-RING INCLUDED  
SEAL: 898570-R/B  
DISC SET: 151380-PKG

LF459661  
LF459662

FOR WATER SAVER  
LENGTH: 2.18"

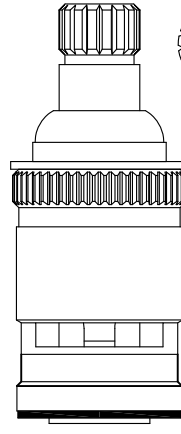

17

Nickel Plated Stem

DISC SET: 151380-PKG

LF461321  
LF461321

FOR SEARS  
LENGTH: 2.19"

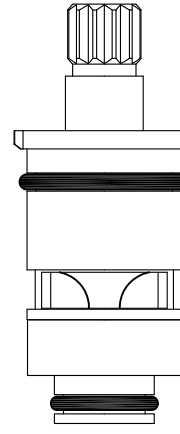

12  
3-10

GASKET: 890170 O-RING INCLUDED  
DISC SET: 151380-PKG

LF461071  
LF461072

# CERAMIC DISC CARTRIDGES

FOR SYSTEM  
LENGTH: 2.19"

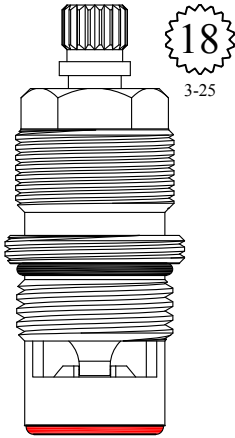

GASKET: 890170 O-RING INCLUDED  
SEAL: 898570-R/B  
DISC SET: 151380-PKG

LF460711  
LF460712

FOR B & K  
LENGTH: 2.20"

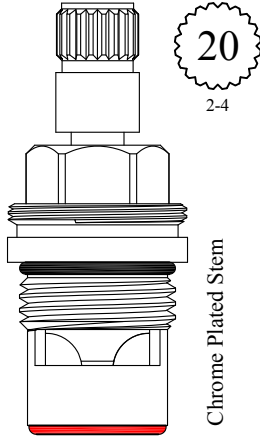

GASKET: 890170 O-RING INCLUDED  
SEAL: 898570-R/B  
DISC SET: 151380-PKG

LF460311  
LF460312

FOR ROHL  
LENGTH: 2.21"

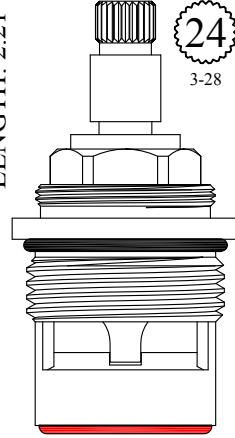

GASKET: 890210 O-RING INCLUDED  
SEAL: 898610-R/B  
DISC SET: 109850-PKG

401031  
401032

FOR JADO  
LENGTH 2.22"

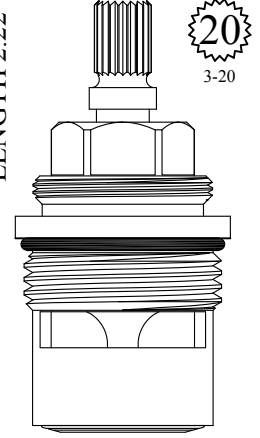

GASKET: 890210 O-RING INCLUDED  
SEAL: 898520  
DISC SET: 109850-PKG

401161  
401162

FOR BRASSCRAFT  
LENGTH: 2.23"

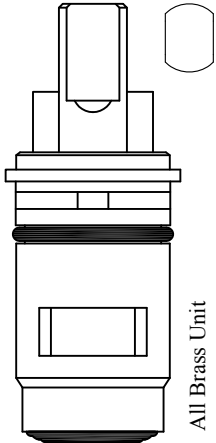

GASKET: 890170 O-RING INCLUDED  
SEAL: 898510  
DISC SET: 124290-PKG

LF460721

FOR SIGN OF THE CRAB  
LENGTH: 2.23"

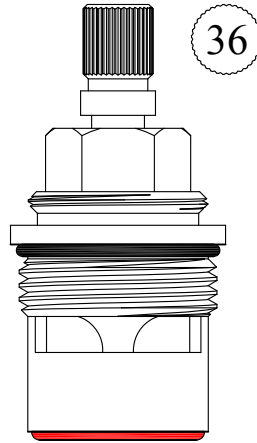

GASKET: 890210 O-RING INCLUDED  
SEAL: 898610-R/B  
DISC SET: 109850-PKG

400981  
400982

FOR KALLISTA  
LENGTH: 2.23"

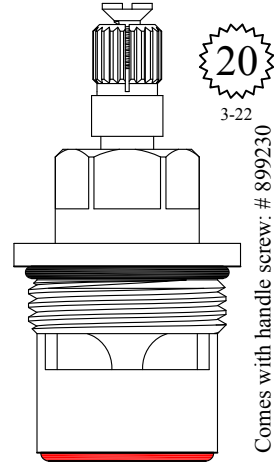

GASKET: 890210 O-RING INCLUDED  
SEAL: 898610-R/B  
DISC SET: 109850-PKG

401091  
401092

UNKNOWN  
LENGTH: 2.24"

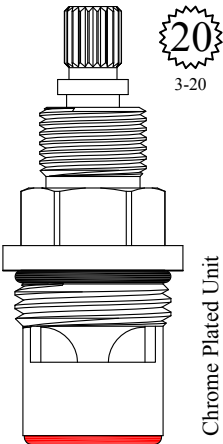

GASKET: 890170 O-RING INCLUDED  
SEAL: 898570-R/B  
DISC SET: 151380-PKG

LF460341  
LF460342

FOR NEWPORT  
LENGTH: 2.24"

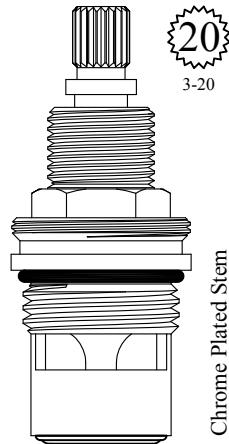

GASKET: 890170 O-RING INCLUDED  
SEAL: 898510-W  
DISC SET: 151380-PKG

LF460361  
LF460362

FOR ARMONIA  
LENGTH: 2.24"

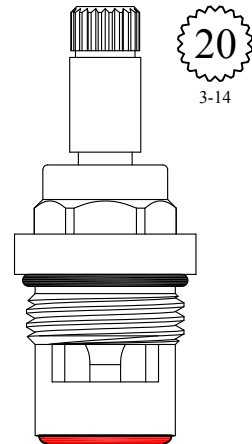

GASKET: 890170 O-RING INCLUDED  
SEAL: 898570-R/B  
DISC SET: 151380-PKG

LF461861  
LF461862

# CERAMIC DISC CARTRIDGES

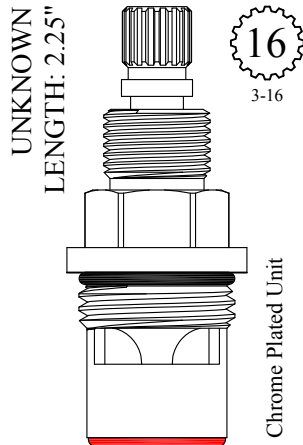

GASKET: 890170 O-RING INCLUDED  
SEAL: 898570-R/B  
DISC SET: 151380-PKG

LF461341  
LF461342

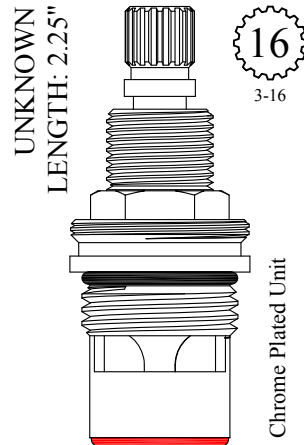

GASKET: 890170 O-RING INCLUDED  
SEAL: 898570-R/B  
DISC SET: 151380-PKG

LF461361  
LF461362

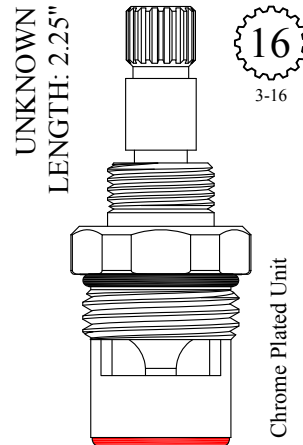

GASKET: 890170 O-RING INCLUDED  
SEAL: 898570-R/B  
DISC SET: 151380-PKG

LF462311  
LF462312

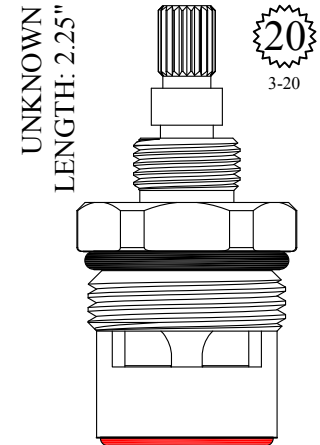

GASKET: 890170 O-RING INCLUDED  
SEAL: 898610-R/B  
DISC SET: 109850-PKG

401441  
401442

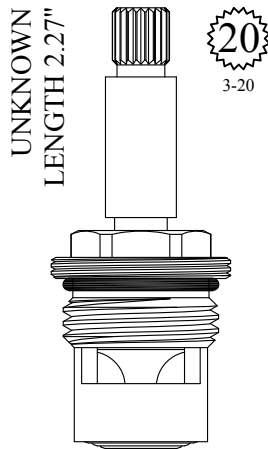

GASKET: 890170 O-RING INCLUDED  
SEAL: 898500  
DISC SET: 112530-PKG

LF462281  
LF462282

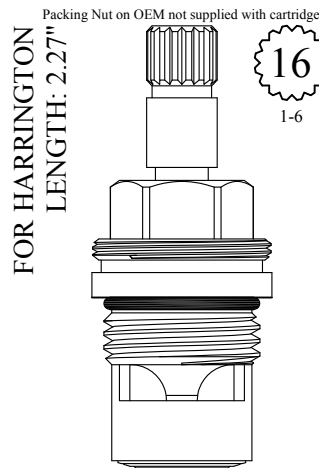

GASKET: 890170 O-RING INCLUDED  
SEAL: 898510-W  
DISC SET: 151380-PKG

LF462541  
LF462542

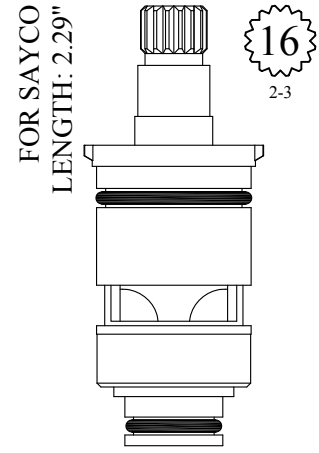

GASKET: 890170 O-RING INCLUDED  
DISC SET: 151380-PKG

LF459611  
LF459612

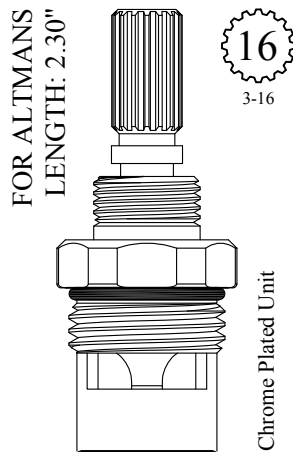

GASKET: 890170 O-RING INCLUDED  
SEAL: 898580-R/B  
DISC SET: 151380-PKG

LF462411  
LF462412

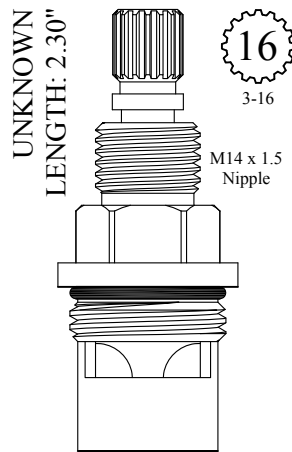

GASKET: 890170 O-RING INCLUDED  
SEAL: 898570-R/B  
DISC SET: 151380-PKG

LF462641  
LF462642

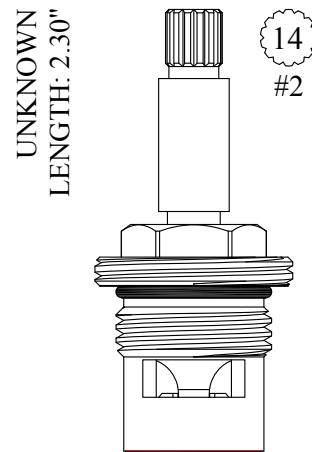

GASKET: 890170 O-RING INCLUDED  
SEAL: 898570-R/B  
DISC SET: 151380-PKG

LF462431  
LF462432

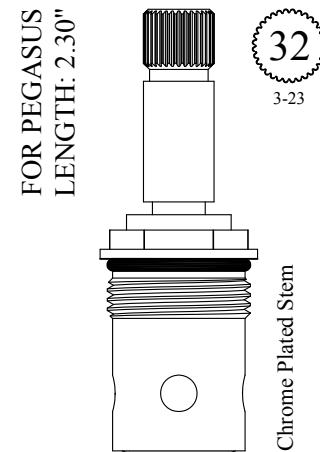

GASKET: 890160 O-RING INCLUDED  
SEAL: 898500  
DISC SET: 112530-PKG

LF462901  
LF462902

# CERAMIC DISC CARTRIDGES

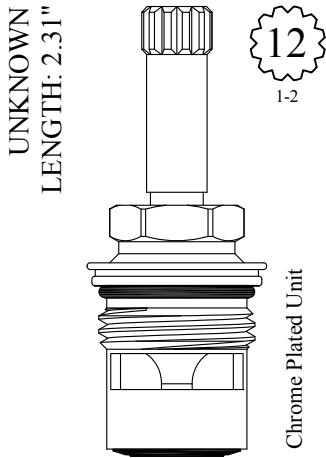

GASKET: 890170 O-RING INCLUDED  
SEAL: 898510  
DISC SET: 151380-PKG

**LF462551**  
**LF462552**

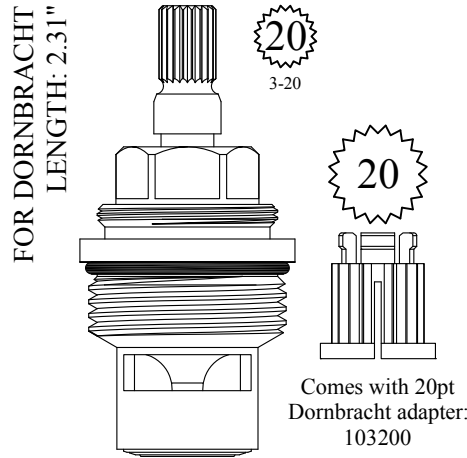

GASKET: 890210 O-RING INCLUDED  
SEAL: 898510-W  
DISC SET: 151380-PKG

**401171**  
**401172**

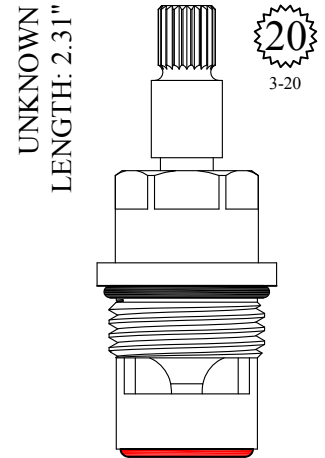

GASKET: 890170 O-RING INCLUDED  
SEAL: 898570-R/B  
DISC SET: 151380-PKG

**LF461401**  
**LF461402**

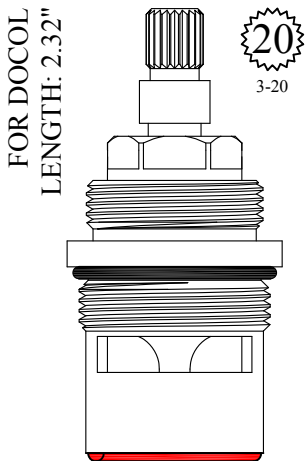

GASKET: 890210 O-RING INCLUDED  
SEAL: 898610  
DISC SET: 109850-PKG

**401041**  
**401042**

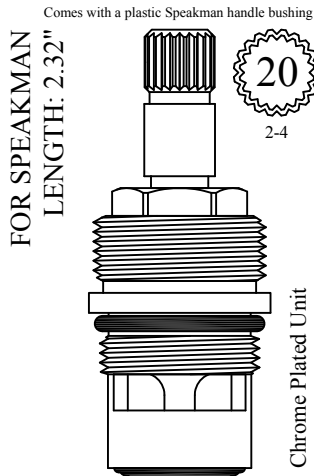

GASKET: 890170 O-RING INCLUDED  
SEAL: 898510  
DISC SET: 151380-PKG

**LF462501**  
**LF462502**

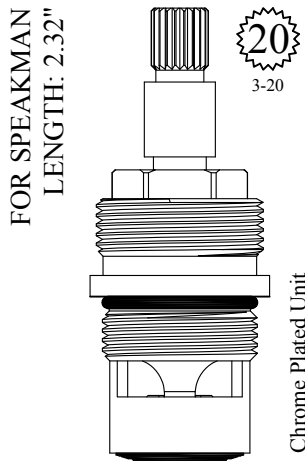

GASKET: 890170 O-RING INCLUDED  
SEAL: 898510  
DISC SET: 151380-PKG

**LF462511**  
**LF462512**

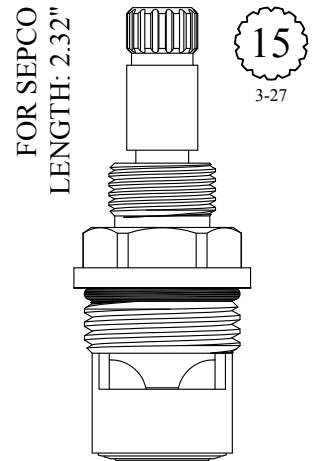

GASKET: 890170 O-RING INCLUDED  
SEAL: 898510-W  
DISC SET: 151380-PKG

**LF459721**  
**LF459722**

# CERAMIC DISC CARTRIDGES

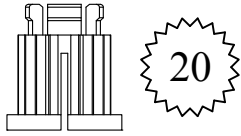

Comes with 20pt Dornbracht adapter: 103200

FOR DORNBRACHT  
LENGTH: 2.34"

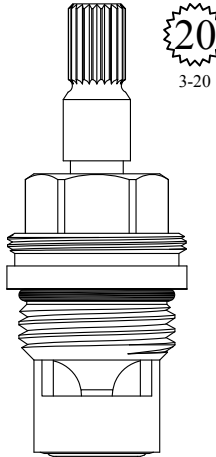

GASKET: 890170 O-RING INCLUDED  
SEAL: 898500  
DISC SET: 112530-PKG

LF462601  
LF462602

FOR DELTA (CER-TECK)  
FOR CAMBRIDGE  
LENGTH: 2.36"

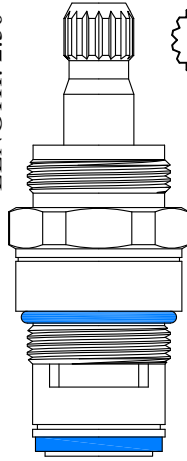

Chrome Plated Unit

LF462711  
LF462712

FOR PIEL  
LENGTH: 2.36"

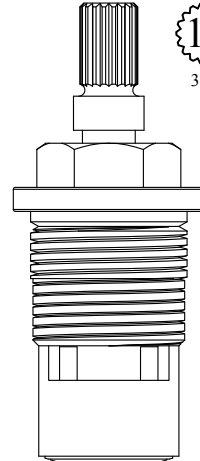

GASKET: 895150 INCLUDED  
SEAL: 898510-W  
DISC SET: 151380-PKG

LF462661  
LF462662

FOR SPRINGHOUSE  
LENGTH: 2.37"

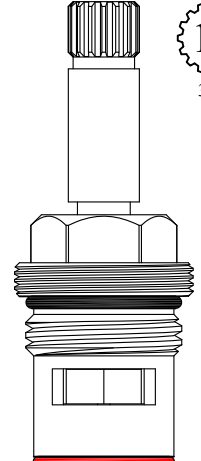

Chrome Plated Unit

GASKET: 890170 O-RING INCLUDED  
SEAL: 898580-R  
DISC SET: 115520-PKG

LF462681  
LF462682

FOR SHERLE WAGNER  
LENGTH: 2.40"

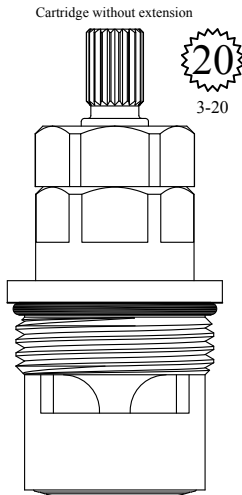

GASKET: 890210 O-RING INCLUDED  
SEAL: 898520  
DISC SET: 109850-PKG

401381  
401382

FOR HELVEX  
LENGTH: 2.40"

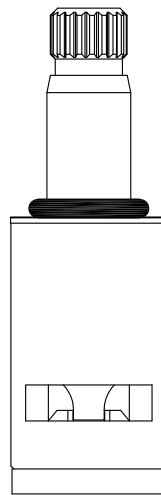

DISC SET: 151380-PKG

LF463801  
LF463802

FOR SHERLE WAGNER  
LENGTH: 2.41"

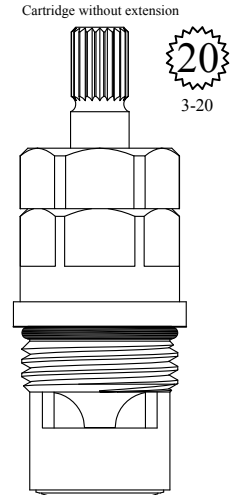

GASKET: 890170 O-RING INCLUDED  
SEAL: 898510-W  
DISC SET: 151380-PKG

LF462521  
LF462522

# CERAMIC DISC CARTRIDGES

UNKNOWN  
LENGTH: 2.41"

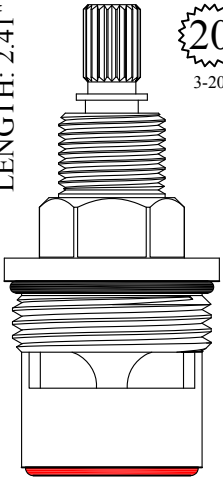

20  
3-20

GASKET: 890210 INCLUDED  
SEAL: 898610-R/B  
DISC SET: 109850-PKG

400961  
400962

UNKNOWN  
LENGTH: 2.41"

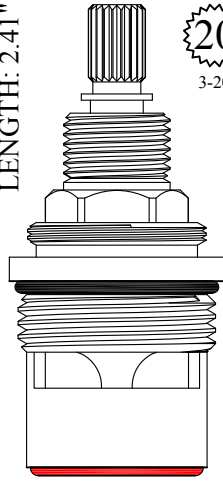

20  
3-20

GASKET: 890210 INCLUDED  
SEAL: 898610-R/B  
DISC SET: 109850-PKG

400991  
400992

FOR SHERLE WAGNER  
LENGTH: 2.43"

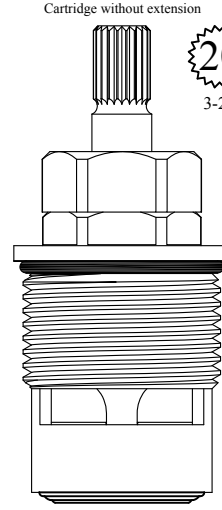

Cartridge without extension  
20  
3-20

GASKET: 890210 O-RING INCLUDED  
SEAL: 898520  
DISC SET: 109850-PKG

401581  
401582

UNKNOWN  
LENGTH: 2.44"

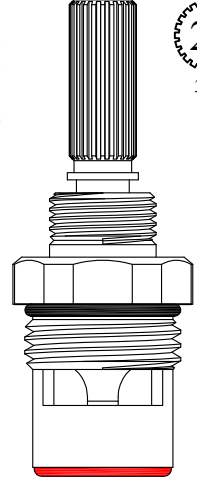

24  
3-18

GASKET: 890170 O-RING INCLUDED  
SEAL: 898570-R/B  
DISC SET: 151380-PKG

LF463661  
LF463662

Also available as a RH/LH Kit

**LF463321-2**

Kit includes: (1) 263321, (1) 263322, (1) 604520

Available: Stem Only

**LF263321 / LF263322**

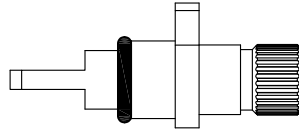

Individual item available  
cap nut: #763320

FOR SEPSCO  
LENGTH: 2.44"

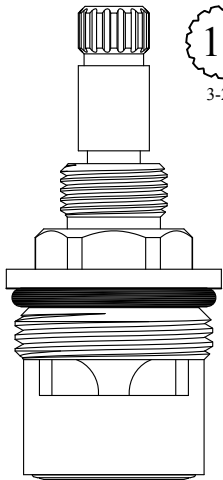

15  
3-27

GASKET: 891180 O-RING INCLUDED  
SEAL: 898520  
DISC SET: 109850-PKG

401251  
401252

FOR WOLVERINE  
LENGTH: 2.44"

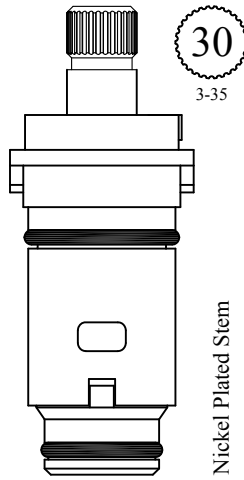

30  
3-35

Nickel Plated Stem

LF463321  
LF463322

FOR WOLVERINE  
LENGTH: 2.44"

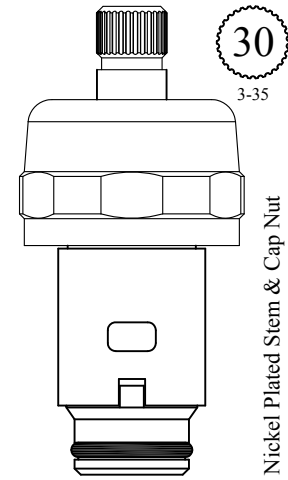

30  
3-35

Nickel Plated Stem & Cap Nut

LF463321-N  
LF463322-N



# CERAMIC DISC CARTRIDGES

Also available as a RH/LH Kit

**LF463361-2**

Kit includes: (1) 263361, (1) 263362, (1) 604520

Available: Stem Only

**LF263361 / LF263362**

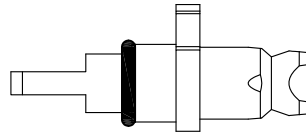

FOR KOHLER  
LENGTH: 2.45"

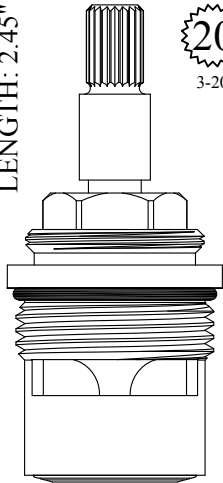

20  
3-20

GASKET: 890210 O-RING INCLUDED  
SEAL: 898520  
DISC SET: 109850-PKG

**401291**  
**401292**

FOR WOLVERINE  
LENGTH: 2.47"

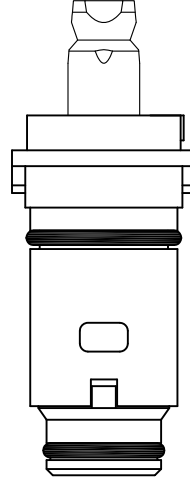

Nickel Plated Stem

**LF463361**  
**LF463362**

FOR SUPER GRIF  
LENGTH: 2.45"

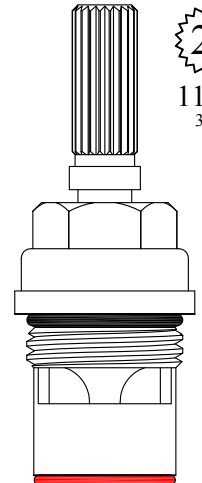

20  
11/32  
3-34

Chrome Plated Gland

GASKET: 890170 O-RING INCLUDED  
SEAL: 898580-R/B  
DISC SET: 151380-PKG

**LF463641**  
**LF463642**

FOR SUPER GRIF  
LENGTH 2.46"

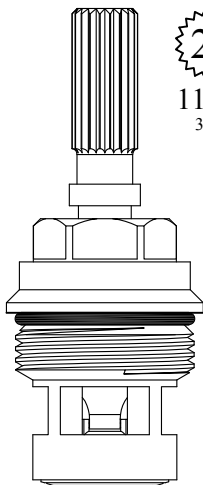

20  
11/32  
3-34

All Brass Unit  
Chrome Plated Gland

GASKET: 890190 O-RING INCLUDED  
SEAL: 898510-W  
DISC SET: 151380-PKG

**LF463621**  
**LF463622**

UNKNOWN  
LENGTH: 2.49"

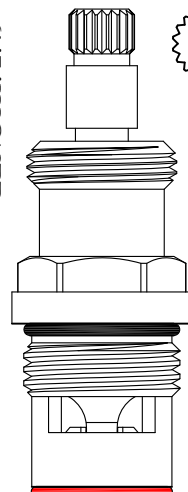

18  
3-25

Thread:  
25/32-18

GASKET: 890170 O-RING INCLUDED  
SEAL: 898580-R/B  
DISC SET: 151380-PKG

**LF401361**  
**LF401362**

FOR WATERMARK  
LENGTH: 2.49"

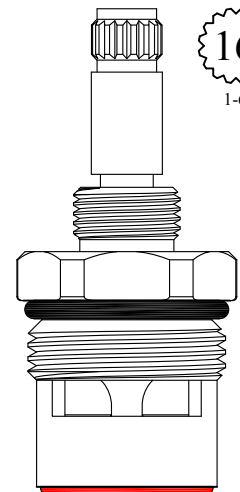

16  
1-6

GASKET: 890170 O-RING INCLUDED  
SEAL: 898610-R/B  
DISC SET: 109850-PKG

**401261**  
**401262**

# CERAMIC DISC CARTRIDGES

FOR KOHLER  
CERAMIC CONVERSION FOR LF460051/2  
LENGTH: 2.49"

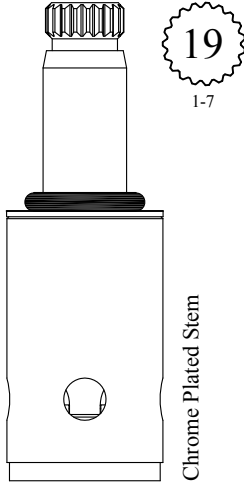

DISC SET: 151380-PKG

LF463811  
LF463812

FOR OTTONE & MELODA  
LENGTH: 2.49"

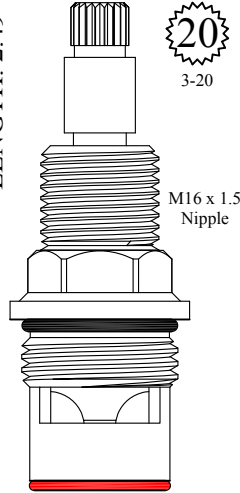

GASKET: 890170 O-RING INCLUDED  
SEAL: 898580-R/B  
DISC SET: 151380-PKG

LF462841  
LF462842

Individual items available  
Stem Ext. 29/32": #128350-PB  
& 128350-CP  
Ext. Adapt. Screw: #103310

FOR PHYLRICH  
LENGTH: 2.49"

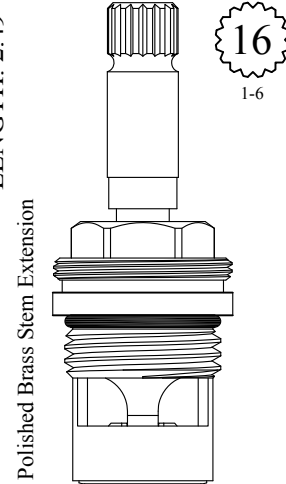

GASKET: 890170 O-RING INCLUDED  
SEAL: 898510-W  
DISC SET: 151380-PKG

LF463651  
LF463652

Also available with chrome plated stem extension  
LF463651-CP / LF463652-CP

FOR SUPER GRIF  
LENGTH: 2.50"

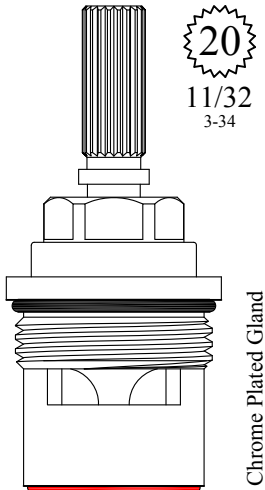

GASKET: 890210 O-RING INCLUDED  
SEAL: 898610-R/B  
DISC SET: 109850-PKG

401281  
401282

UNKNOWN  
LENGTH: 2.52"

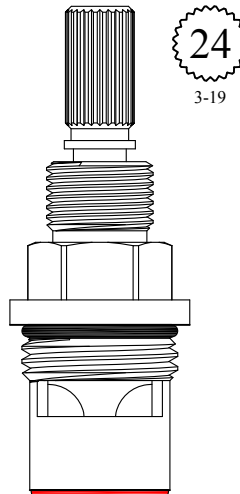

GASKET: 890170 O-RING INCLUDED  
SEAL: 898570-R/B  
DISC SET: 151380-PKG

LF464351  
LF464352

FOR SIGN OF THE CRAB  
LENGTH: 2.54"

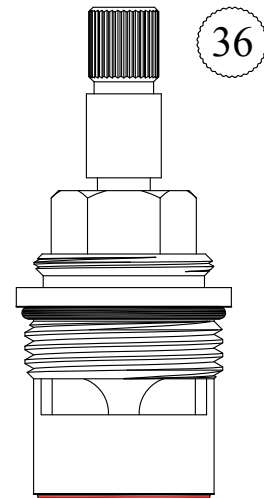

GASKET: 890210 O-RING INCLUDED  
SEAL: 898610-R/B  
DISC SET: 109850-PKG

401481  
401482

# CERAMIC DISC CARTRIDGES

FOR GLACIER BAY  
LENGTH: 2.54"

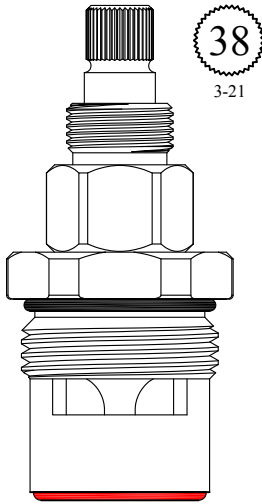

GASKET: 890200 O-RING INCLUDED  
SEAL: 898610-R/B  
DISC SET: 109850-PKG

401421  
401422

FOR DONNER  
LENGTH: 2.54"

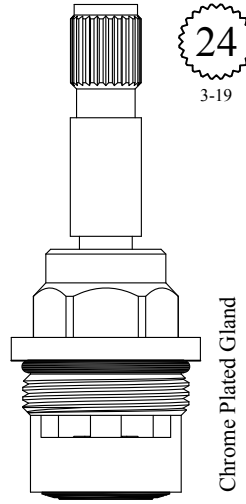

GASKET: 890180 O-RING INCLUDED  
SEAL: 898510  
DISC SET: 151380-PKG

LF464371  
LF464372

FOR ARMONIA  
LENGTH: 2.55"

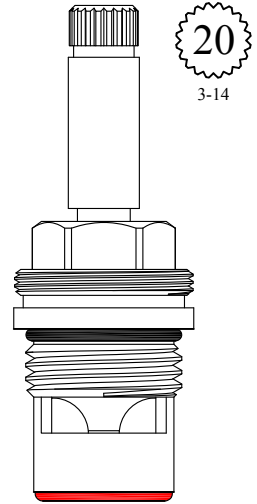

GASKET: 890170 O-RING INCLUDED  
SEAL: 898570-R/B  
DISC SET: 151380-PKG

LF462861  
LF462862

FOR ARMONIA  
LENGTH: 2.55"

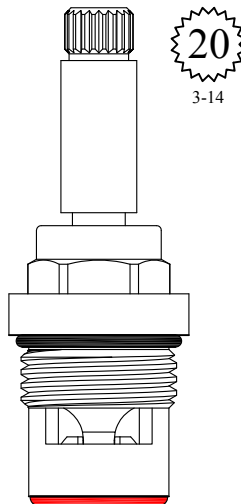

GASKET: 890170 O-RING INCLUDED  
SEAL: 898570-R/B  
DISC SET: 151380-PKG

LF462881  
LF462882

FOR ARMONIA  
LENGTH: 2.55"

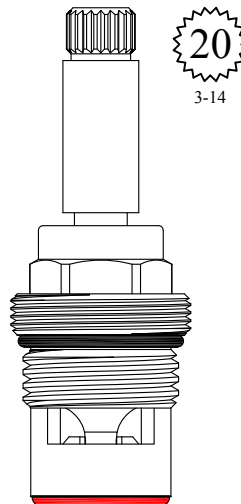

GASKET: 890170 O-RING INCLUDED  
SEAL: 898570-R/B  
DISC SET: 151380-PKG

LF462891  
LF462892

FOR MILWAUKEE  
LENGTH 2.57"

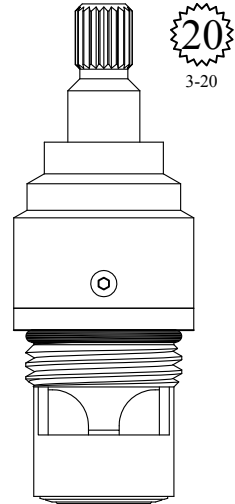

GASKET: 890170 O-RING INCLUDED  
SEAL: 898510-W  
DISC SET: 151380-PKG

LF463941  
LF463942

Individual items available  
Stem Ext.: #118760  
Esc Cap Nut: #124940

# CERAMIC DISC CARTRIDGES

FOR OTTONE & MELODA  
LENGTH: 2.60"

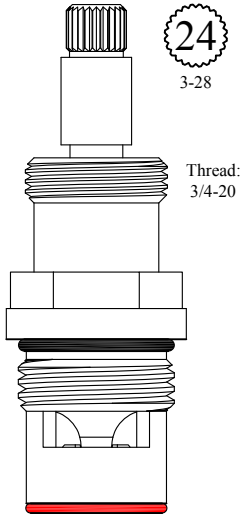

GASKET: 890170 O-RING INCLUDED  
SEAL: 898580-R/B  
DISC SET: 151380-PKG

LF401391  
LF401392

FOR SIGMA  
LENGTH: 2.60"

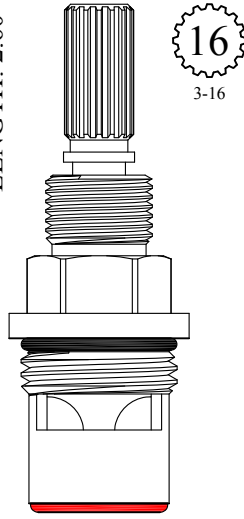

GASKET: 890170 O-RING INCLUDED  
SEAL: 898570-R/B  
DISC SET: 151380-PKG

LF464341  
LF464342

FOR NEWPORT  
LENGTH: 2.60"

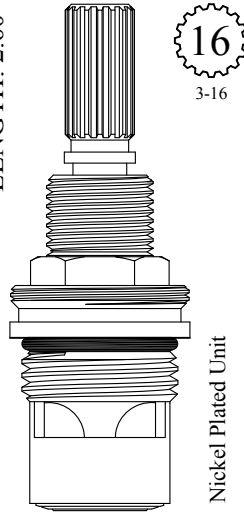

GASKET: 890170 O-RING INCLUDED  
SEAL: 898510-W  
DISC SET: 151380-PKG

LF464361  
LF464362

FOR SEPCO  
LENGTH: 2.60"

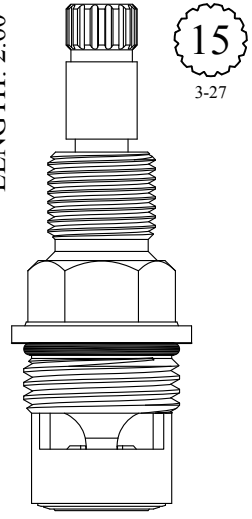

GASKET: 890170 O-RING INCLUDED  
SEAL: 898510-W  
DISC SET: 151380-PKG

LF464381  
LF464382

Individual items available  
Stem Ext. 1-1/16": #105270-PB  
& #105270-CP  
Ext. Adap. Screw: #103310

FOR SIGN OF THE CRAB  
LENGTH: 2.60"

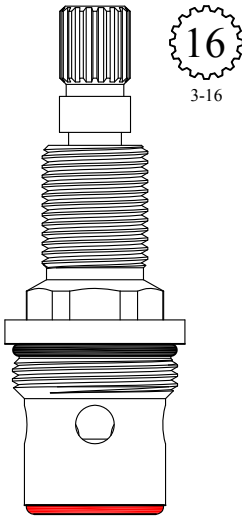

GASKET: 890170 O-RING INCLUDED  
SEAL: 898570-R/B  
DISC SET: 151380-PKG

LF464511  
LF464512

FOR AM STD  
LENGTH: 2.62"

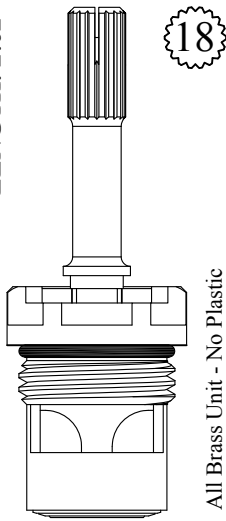

GASKET: 890170 O-RING INCLUDED  
SEAL: 898510-W  
DISC SET: 151380-PKG

401501  
401502

FOR PHYLRICH  
LENGTH: 2.64"

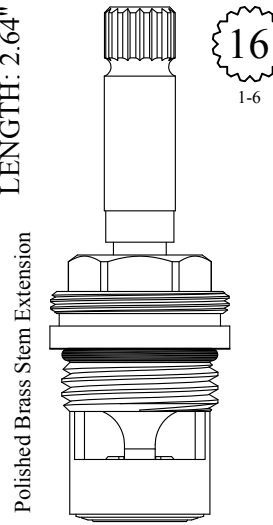

GASKET: 890170 O-RING INCLUDED  
SEAL: 898510-W  
DISC SET: 151380-PKG

LF464661  
LF464662

Also available with chrome plated stem extension  
LF464661-CP / LF464662-CP

# CERAMIC DISC CARTRIDGES

UNKNOWN  
LENGTH: 2.67"

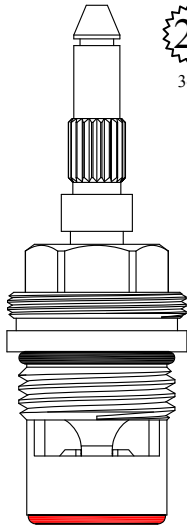

20  
3-20

GASKET: 890170 O-RING INCLUDED  
SEAL: 898570-R/B  
DISC SET: 151380-PKG

LF464681  
LF464682

FOR CRANE  
CERAMIC CONVERSION FOR DIAL-EZE  
LENGTH: 2.67"

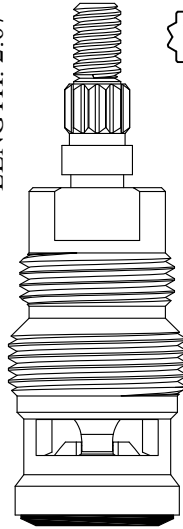

12  
1-1

GASKET: 895250 INCLUDED  
DISC SET: 151380-PKG

LF464311  
LF464312

Supplied as a one-piece stem  
Does not use an extension

FOR SEACREST  
LENGTH: 2.68"

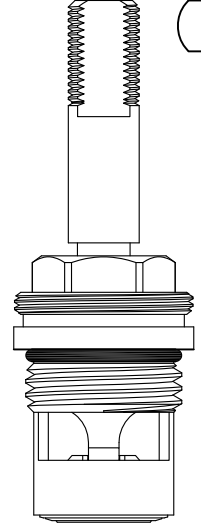

Nickel Plated Unit

GASKET: 890170 O-RING INCLUDED  
SEAL: 898510-W  
DISC SET: 151380-PKG

LF464611  
LF464612

FOR BARBER WILSON  
LENGTH: 2.70"

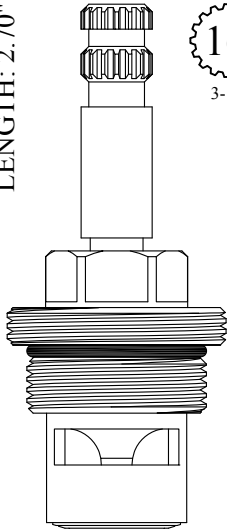

16  
3-16

GASKET: 890190 O-RING INCLUDED  
SEAL: 898510-W  
DISC SET: 151380-PKG

LF464571  
LF464572

FOR OTTONE & MELODA  
LENGTH: 2.70"

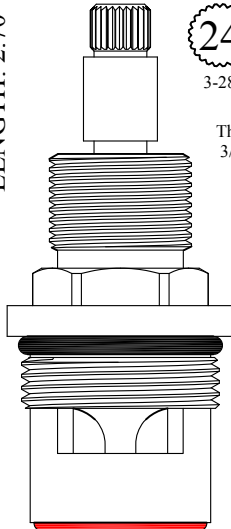

24  
3-28

Thread:  
3/4-19

GASKET: 891180 O-RING INCLUDED  
SEAL: 898610-R/B  
DISC SET: 109850-PKG

401471  
401472

UNKNOWN  
LENGTH: 2.72"

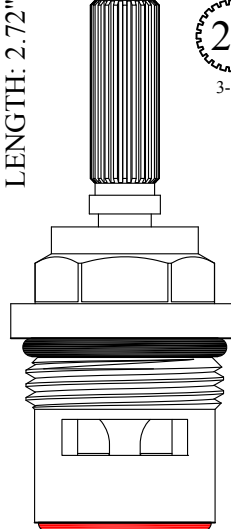

24  
3-18

GASKET: 891180 O-RING INCLUDED  
SEAL: 898610-R/B  
DISC SET: 109850-PKG

401591  
401592

UNKNOWN  
LENGTH: 2.72"

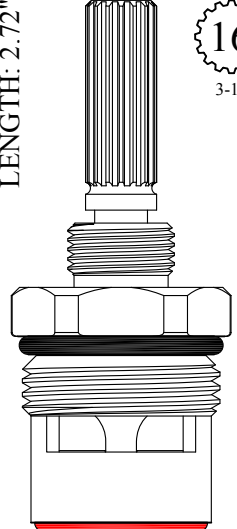

16  
3-16

GASKET: 891180 O-RING INCLUDED  
SEAL: 898610-R/B  
DISC SET: 109850-PKG

401561  
401562

# CERAMIC DISC CARTRIDGES

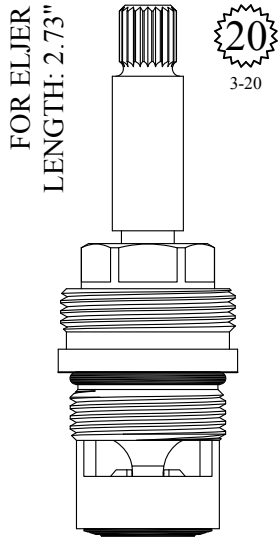

GASKET: 890170 O-RING INCLUDED  
SEAL: 898510  
DISC SET: 151380-PKG

LF464921  
LF464922

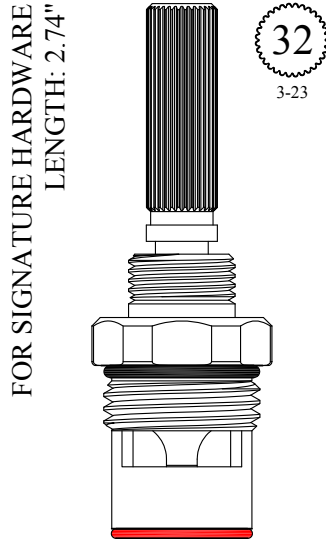

GASKET: 890170 O-RING INCLUDED  
SEAL: 898570-R/B  
DISC SET: 151380-PKG

LF464421  
LF464422

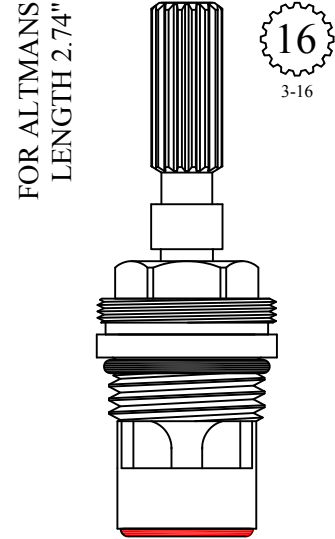

GASKET: 890170 O-RING INCLUDED  
SEAL: 898570-R/B  
DISC SET: 151380-PKG

LF464911  
LF464912

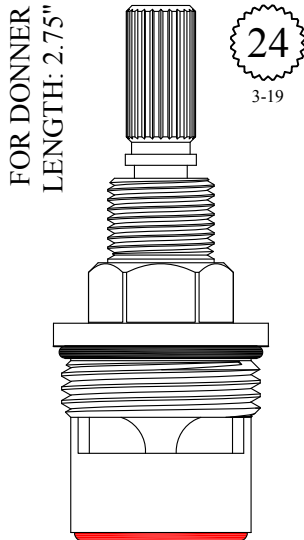

GASKET: 890210 O-RING INCLUDED  
SEAL: 898610-R/B  
DISC SET: 109850-PKG

401491  
401492

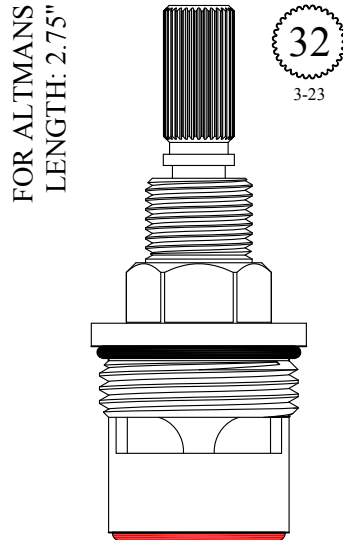

GASKET: 890210 O-RING INCLUDED  
SEAL: 898610-R/B  
DISC SET: 109850-PKG

401571  
401572

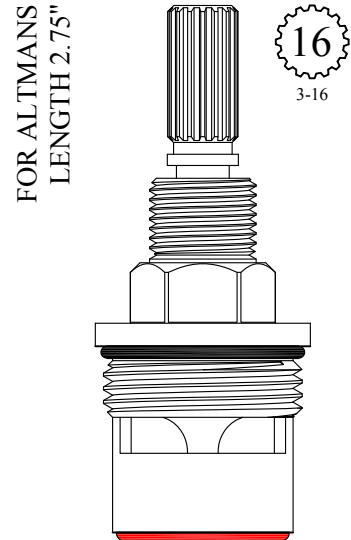

GASKET: 890210 O-RING INCLUDED  
SEAL: 898610-R/B  
DISC SET: 109850-PKG

401641  
401642

# CERAMIC DISC CARTRIDGES

FOR NEWPORT  
LENGTH: 2.75"

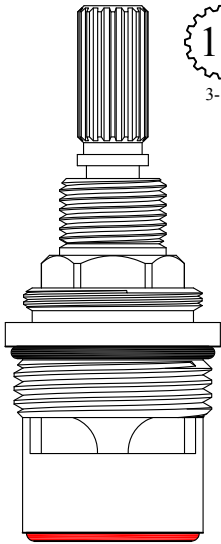

16  
3-16

Also available in a Chrome Plated Unit  
**401651-CP / 401652-CP**

GASKET: 890210 O-RING INCLUDED  
SEAL: 898610-R/B  
DISC SET: 109850-PKG

**401651**  
**401652**

Extension Available  
#135000

FOR KOHLER  
LENGTH 2.77"

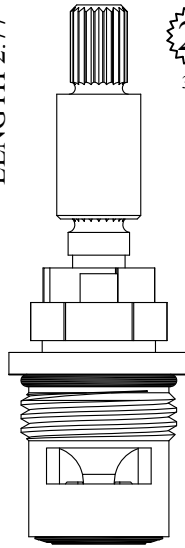

20  
3-20

Nickel Plated Gland

GASKET: 890170 O-RING INCLUDED  
SEAL: 898510  
DISC SET: 151380-PKG

**LF464941**

FOR CHICAGO  
LENGTH: 2.77"

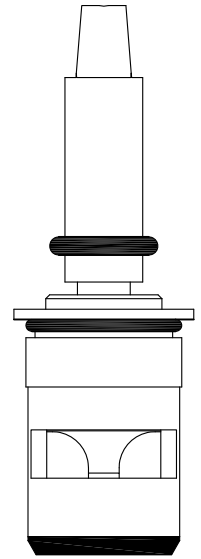

Nickel Plated Stem

GASKET: 890170 O-RING INCLUDED  
SEAL: 898590 & LF132250  
DISC SET: 151380-PKG

**LF465461**  
**LF465462**

FOR ARTISTIC BRASS  
LENGTH: 2.79"

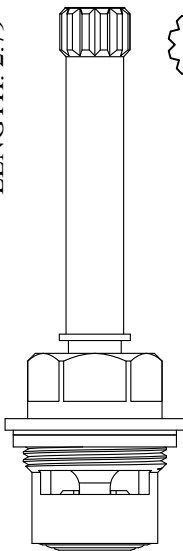

12  
1-2

GASKET: 895100 INCLUDED  
SEAL: 898500  
DISC SET: 112530-PKG

**401661**  
**401662**

UNKNOWN  
LENGTH: 2.79"

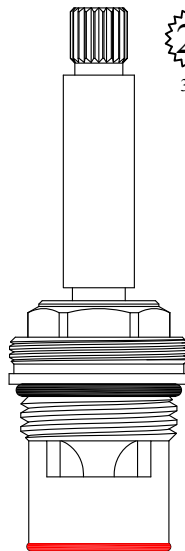

20  
3-20

GASKET: 890170 O-RING INCLUDED  
SEAL: 898580-R/B  
DISC SET: 151380-PKG

**LF465331**  
**LF465332**

FOR ZURN  
LENGTH: 2.81"

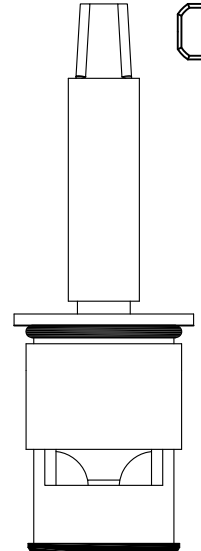

Nickel Plated Stem

GASKET: 890170 O-RING INCLUDED  
SEAL: 898590 & LF132250  
DISC SET: 151380-PKG

**LF465441**  
**LF465442**

# CERAMIC DISC CARTRIDGES

Individual items available  
 Stem Ext. 1-1/4": #105340-PB  
 & 105340-CP  
 Ext. Adap. Screw: #103310

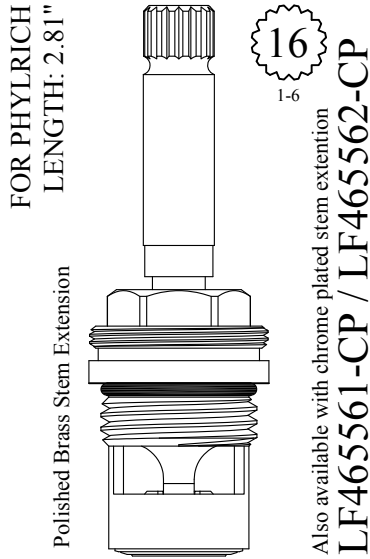

GASKET: 890170 O-RING INCLUDED  
 SEAL: 898510-W  
 DISC SET: 151380-PKG

**LF465561**  
**LF465562**

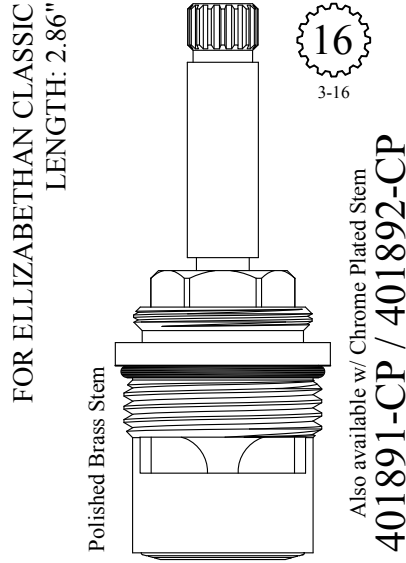

GASKET: 890210 O-RING INCLUDED  
 SEAL: 898520  
 DISC SET: 109850-PKG

**401891**  
**401892**

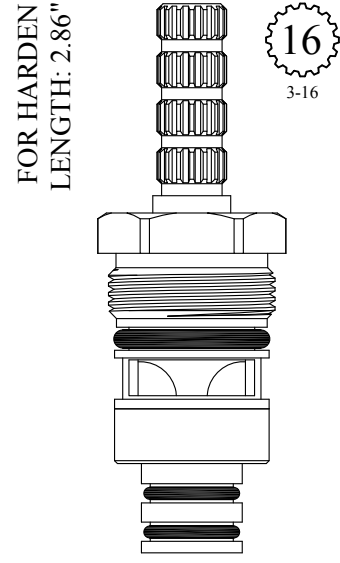

GASKET: 891140 O-RING INCLUDED  
 DISC SET: 151380-PKG

**LF465401**  
**LF465402**

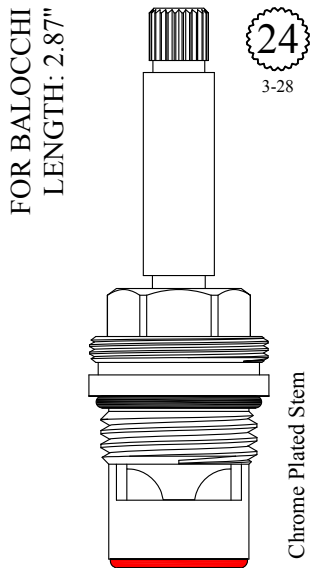

GASKET: 890170 O-RING INCLUDED  
 SEAL: 898570-R/B  
 DISC SET: 151380-PKG

**LF465341**  
**LF465342**

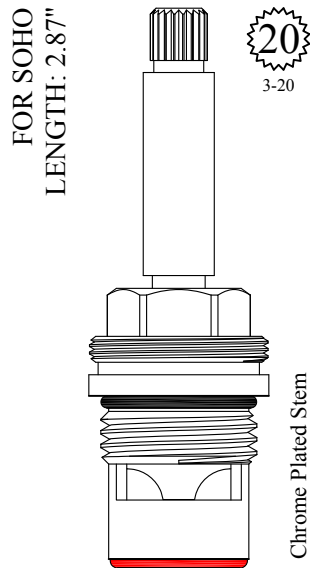

GASKET: 890170 O-RING INCLUDED  
 SEAL: 898570-R/B  
 DISC SET: 151380-PKG

**LF465371**  
**LF465372**

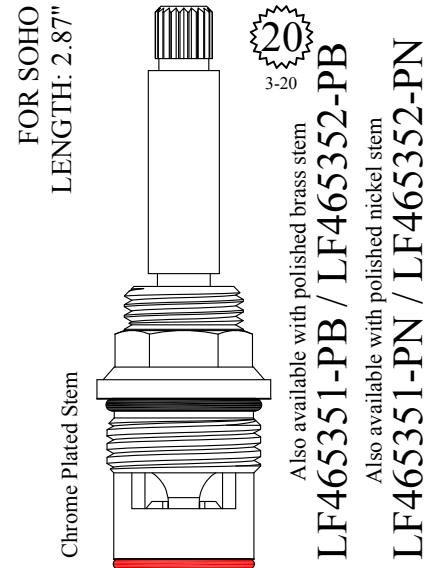

GASKET: 890170 O-RING INCLUDED  
 SEAL: 898580-R/B  
 DISC SET: 151380-PKG

**LF465351**  
**LF465352**



# CERAMIC DISC CARTRIDGES

FOR DORNBRACHT  
LENGTH: 2.88"

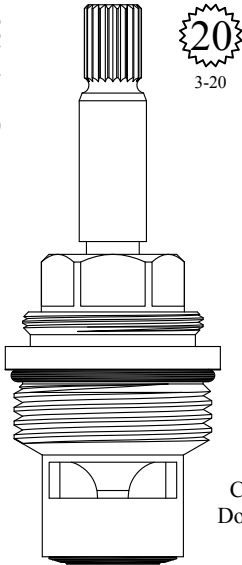

20  
3-20

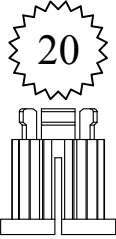

Comes with 20pt  
Dornbracht adapter:  
103200

GASKET: 890210 O-RING INCLUDED  
SEAL: 898510  
DISC SET: 151380-PKG

401691  
401692

FOR LIBERTY  
LENGTH: 2.89"

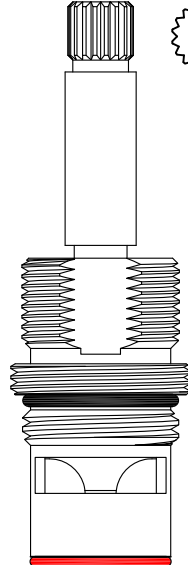

18  
3-25

GASKET: 890170 O-RING INCLUDED  
SEAL: 898570-R/B  
DISC SET: 151380-PKG

LF465431  
LF465432

FOR LIBERTY  
LENGTH: 2.89"

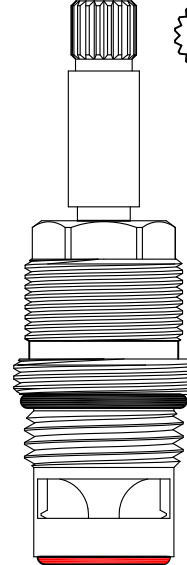

18  
3-25

Alternate Style  
Not Available  
USE LF465431/LF465432

Extension Available  
#135000

FOR THG  
LENGTH 2.90"

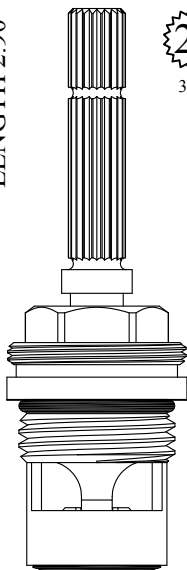

20  
3-20

GASKET: 890170 O-RING INCLUDED  
SEAL: 898510-W  
DISC SET: 151380-PKG

LF465581  
LF465582

FOR KOHLER NEW STYLE  
LENGTH: 2.91"

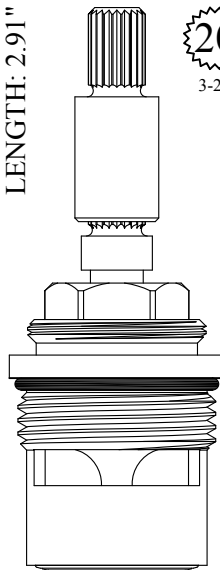

20  
3-20

GASKET: 890210 O-RING INCLUDED  
SEAL: 898520  
DISC SET: 109850-PKG

401671  
401672

Extension Available  
#135000

FOR KOHLER OLD STYLE  
LENGTH: 2.91"

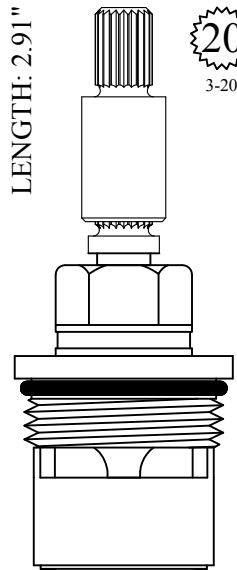

20  
3-20

GASKET: 890210 O-RING INCLUDED  
SEAL: 898520  
DISC SET: 109850-PKG

401671 OS  
401672 OS

# CERAMIC DISC CARTRIDGES

*Send Your Orders To:*

BARRY E.  SR. CO.

*E-mail: [orderdesk@barrywalter.com](mailto:orderdesk@barrywalter.com)*

*Fax: 1.800.886.9831*

*Phone: 1.800.767.5552*

# CERAMIC DISC CARTRIDGES

FOR KOHLER / ROHL  
LENGTH: 2.91"

24  
9/32

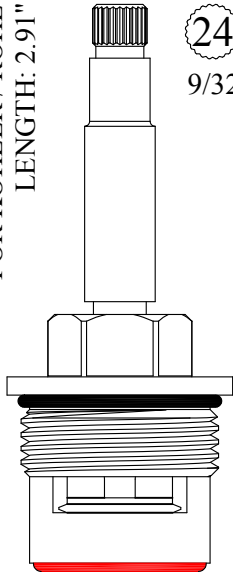

GASKET: 890210 O-RING INCLUDED  
SEAL: 898610-R/B  
DISC SET: 109850-PKG

401601  
401602

FOR KRONIN BY VIOLA  
LENGTH: 2.94"

20  
3-20

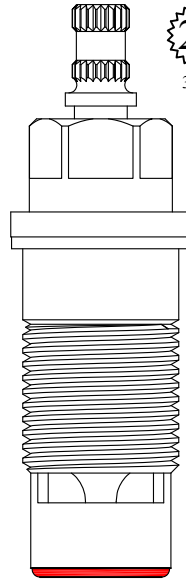

GASKET: 895150 INCLUDED  
SEAL: 898570-R/B  
DISC SET: 151380-PKG

LF466251  
LF466252

FOR DORF  
LENGTH: 2.97"

3/8 - 26 TPI

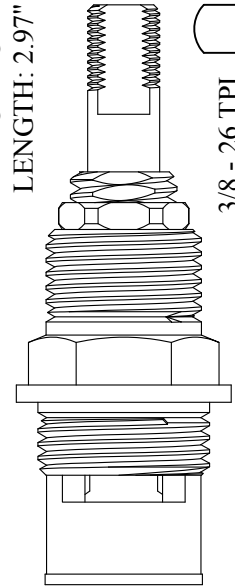

GASKET: 895370 INCLUDED  
DISC SET: 124290-PKG

LF465941  
LF465942

Also available with Chrome Plated Stem  
LF465941-CP / LF465942-CP

FOR PHYLRICH  
LENGTH: 2.96"

16  
1-6

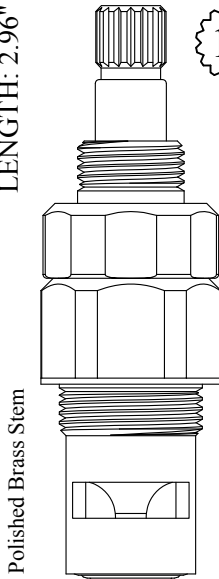

GASKET: 895270 INCLUDED  
SEAL: 898500  
DISC SET: 112530-PKG

LF466201  
LF466202

Also available with Polished Chrome Stem  
LF466201-CP / LF466202-CP

FOR ZURN HYDRANT  
LENGTH: 2.95"

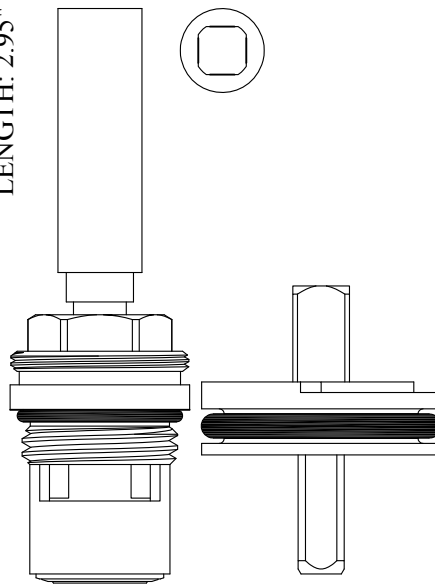

GASKET: 895170 INCLUDED  
SEAL: 898510-W  
DISC SET: 151380-PKG

466311

The above stem is available in the following lengths:

Stem #:	Length	Stem #:	Length
483171-6	6.00"	483171-18	18.00"
483171-8	8.00"	483171-20	20.00"
483171-10	10.00"	483171-22	22.00"
483171-12	12.00"	483171-24	24.00"
483171-14	14.00"	483171-26	26.00"
483171-16	16.00"	483171-30	30.00"

OPERATING STEM  
IS FOR  
REFERENCE ONLY

FOR AUBURN BRASS  
LENGTH: 2.98"

16  
2-3

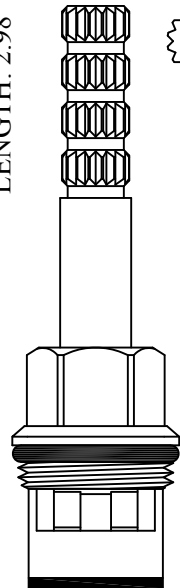

GASKET: 890160 O-RING INCLUDED  
DISC SET: 151380-PKG

LF465451  
LF465452

Nickel Plated Gland

# CERAMIC DISC CARTRIDGES

Individual items available  
 Stem Ext. 1-1/2": #121860-PB  
 & 121860-CP  
 Ext. Adap. Screw: #103310

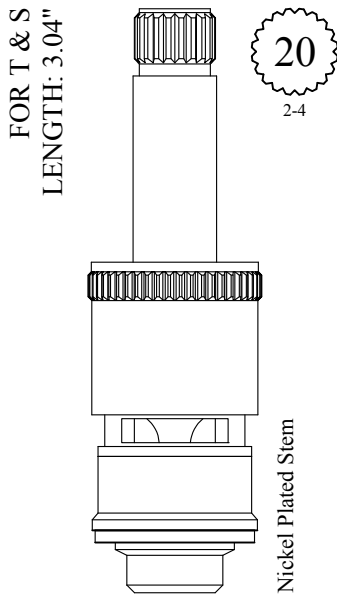

SEAL: 898510  
 DISC SET: 151380-PKG  
**LF466401**  
**LF466402**

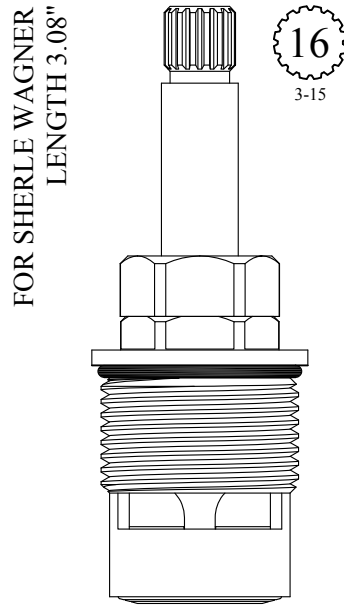

GASKET: 890210 O-RING INCLUDED  
 SEAL: 898520  
 DISC SET: 109850-PKG  
**401881**  
**401882**

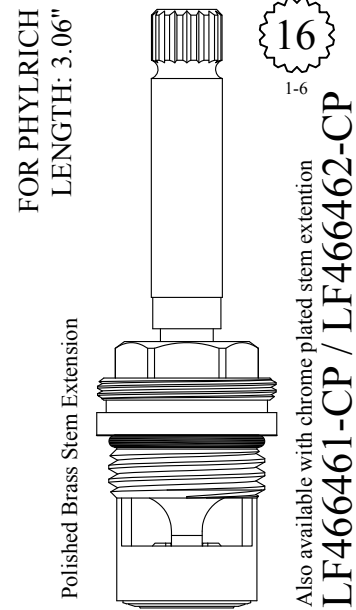

GASKET: 890170 O-RING INCLUDED  
 SEAL: 898510-W  
 DISC SET: 151380-PKG  
**LF466461**  
**LF466462**

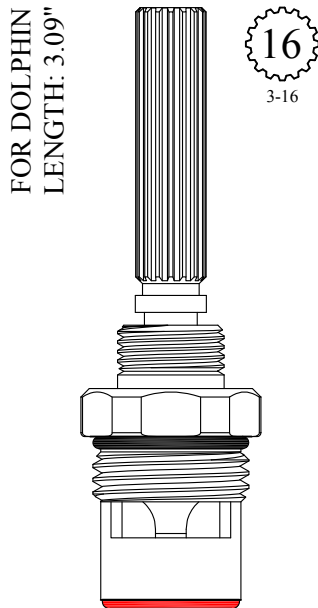

GASKET: 890170 O-RING INCLUDED  
 SEAL: 898570-R/B  
 DISC SET: 151380-PKG  
**LF466421**  
**LF466422**

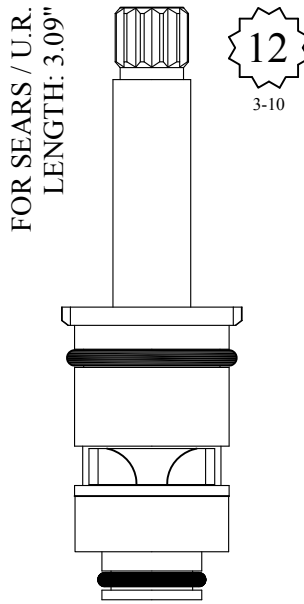

GASKET: 890170 O-RING INCLUDED  
 DISC SET: 151380-PKG  
**LF467031**  
**LF467032**

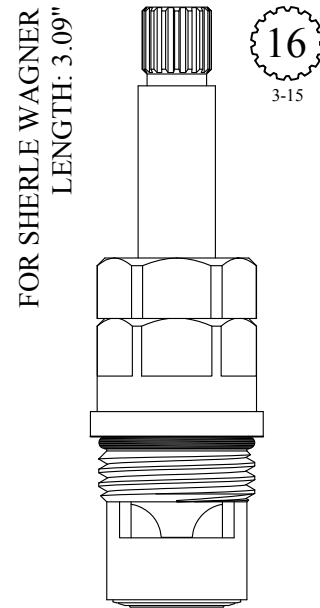

GASKET: 890170 O-RING INCLUDED  
 SEAL: 898510-W  
 DISC SET: 151380-PKG  
**LF466521**  
**LF466522**

# CERAMIC DISC CARTRIDGES

Individual item available  
Esc Cap Nut: #124940

UNKNOWN  
LENGTH: 3.09"

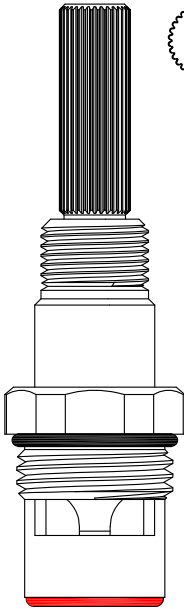

32  
3-23

Individual item available  
9/16-20 x 7/8" ext. nipple: #118320

GASKET: 890170 O-RING INCLUDED  
SEAL: 898570-R/B  
DISC SET: 151380-PKG

LF466441  
LF466442

FOR SOHO  
LENGTH: 3.10"

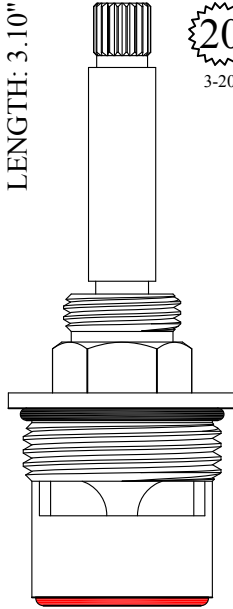

20  
3-20

Chrome Plated Stem

GASKET: 890170 O-RING INCLUDED  
SEAL: 898610-R/B  
DISC SET: 109850-PKG

402351  
402352

UNKNOWN  
LENGTH: 3.14"

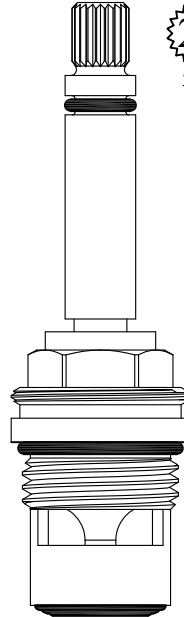

20  
3-20

GASKET: 890170 O-RING INCLUDED  
SEAL: 898510  
DISC SET: 151380-PKG

LF466921  
LF466922

UNKNOWN  
LENGTH: 3.14"

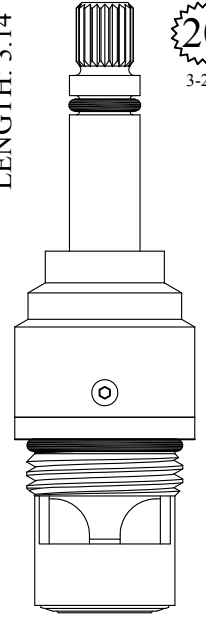

20  
3-20

GASKET: 890170 O-RING INCLUDED  
SEAL: 898510  
DISC SET: 151380-PKG

LF466941  
LF466942

UNKNOWN  
LENGTH: 3.15"

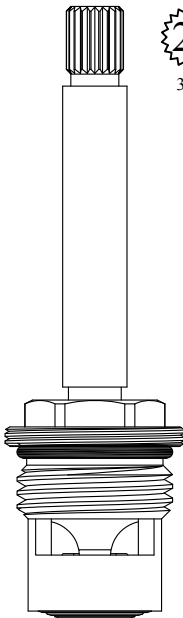

20  
3-20

GASKET: 890170 O-RING INCLUDED  
SEAL: 898500  
DISC SET: 151380-PKG

LF467381  
LF467382

FOR SPEAKMAN  
LENGTH: 3.27"

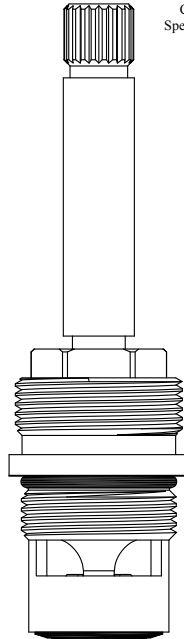

Comes with a plastic  
Speakman handle bushing

20  
2-4

Chrome Plated Unit

GASKET: 890170 O-RING INCLUDED  
SEAL: 898510  
DISC SET: 151380-PKG

LF466901  
LF466902

FOR SPEAKMAN  
LENGTH: 3.27"

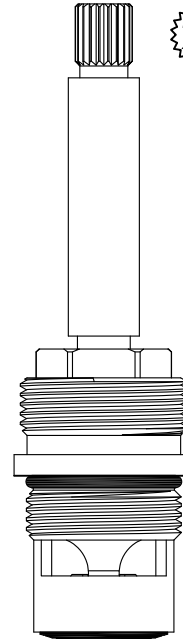

20  
3-20

Chrome Plated Unit

GASKET: 890170 O-RING INCLUDED  
SEAL: 898510  
DISC SET: 151380-PKG

LF466911  
LF466912

# CERAMIC DISC CARTRIDGES

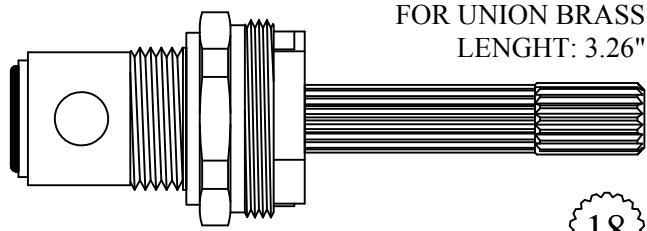

**402511/ 402512**

GASKET: 895100  
SEAL: 898510  
DISC SET: 151380-PKG

18  
3-3

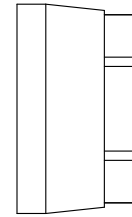

Cap Nut  
available  
# 702510

FOR AM STD  
CERAMIC CONVERSION FOR  
COLONY S/V UNIT (SHORT)  
LENGTH: 3.28"

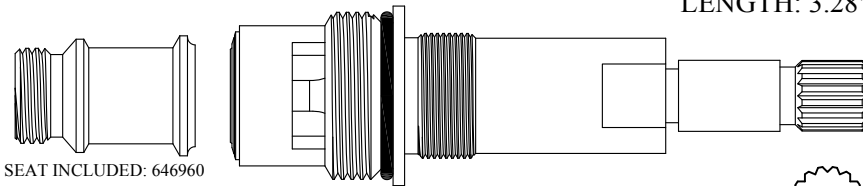

**402441**

GASKET: 890180 O-RING INCLUDED  
SEAL: 898510  
DISC SET: 151380-PKG

16  
1-6

Polished Brass Stem

FOR PHYLRICH  
LENGTH: 3.33"

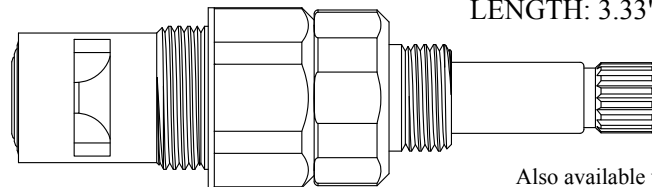

**LF468101/ LF468102**

GASKET: 895270 INCLUDED  
SEAL: 898500  
DISC SET: 112530-PKG

16  
1-6

Also available with  
polished chrome stem  
**LF468101-CP**  
**LF468102-CP**

UNKNOWN  
LENGTH: 3.34"

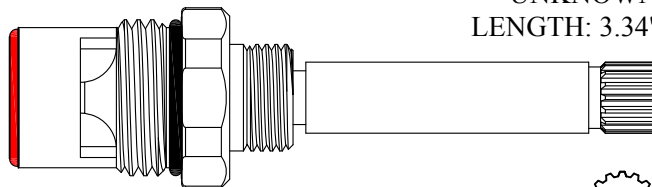

**LF402681/ LF402682**

GASKET: 890170 O-RING INCLUDED  
SEAL: 898570-R/B  
DISC SET: 151380-PKG

16  
3-16

# CERAMIC DISC CARTRIDGES

Polished Brass Stem

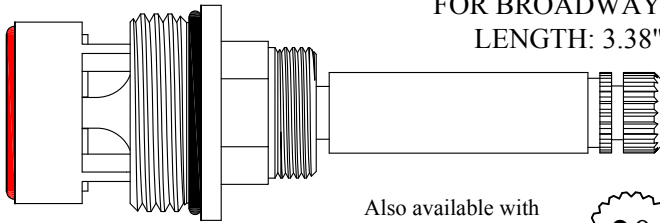

FOR BROADWAY  
LENGTH: 3.38"

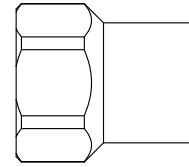

Escutcheon Nut  
# 302740  
available

402651/ 402652

GASKET: 890210 O-RING INCLUDED  
SEAL: 898610-R/B  
DISC SET: 109850-PKG

Also available with  
polished chrome stem  
402651-CP  
402652-CP



2-4

FOR REID WATSON  
LENGTH: 3.38"

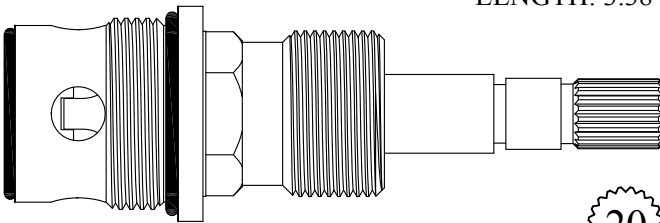

402661/ 402662

GASKET: 890210 O-RING INCLUDED  
SEAL: 898530  
DISC SET: 109850-PKG



3-14

FOR DORNBRACHT  
LENGTH: 3.38"

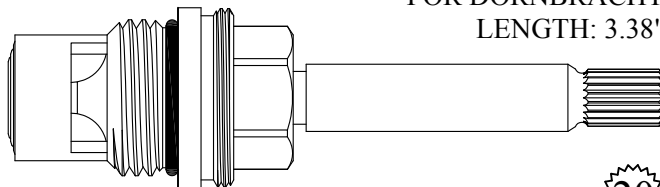

402601/ 402602

GASKET: 890170 O-RING INCLUDED  
SEAL: 898500  
DISC SET: 112530-PKG



3-20

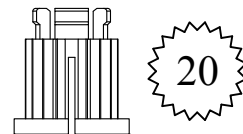

Comes with 20pt Dornbracht  
adapter: 103200

Polished Brass Stem Extension

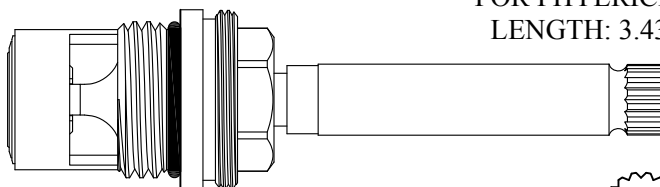

FOR PHYL RICH  
LENGTH: 3.43"

Individual items available  
Stem Ext. 1 7/8": #102890-PB  
& 102890-CP  
Ext. Adap. Screw: #103310

LF468461/ LF468462

GASKET: 890170 O-RING INCLUDED  
SEAL: 898510-W  
DISC SET: 151380-PKG



1-6

Also available with chrome plated stem extension

LF468461-CP/ LF468462-CP

# CERAMIC DISC CARTRIDGES

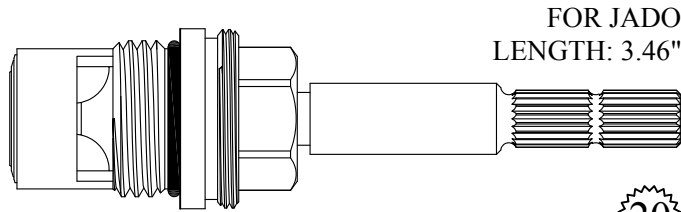

**402841/ 402842**

GASKET: 890170 O-RING INCLUDED  
SEAL: 898510-W  
DISC SET: 151380-PKG

20  
3-20

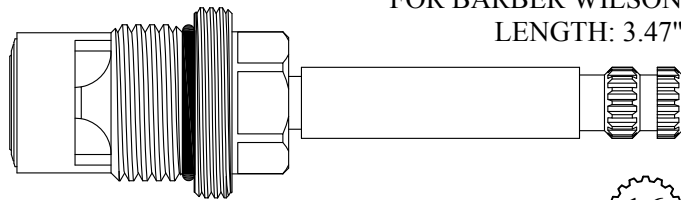

**LF468581/ LF468582**

GASKET: 890190 O-RING INCLUDED  
SEAL: 898510-W  
DISC SET: 151380-PKG

16  
3-16

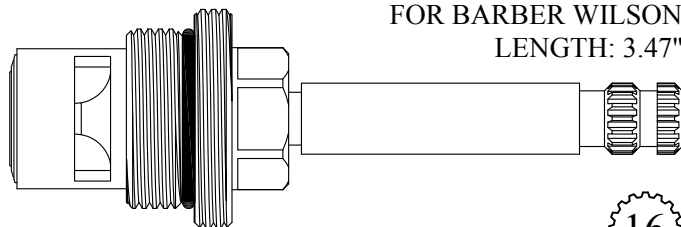

**LF468571/ LF468572**

GASKET: 890190 O-RING INCLUDED  
SEAL: 898510-W  
DISC SET: 151380-PKG

16  
3-16

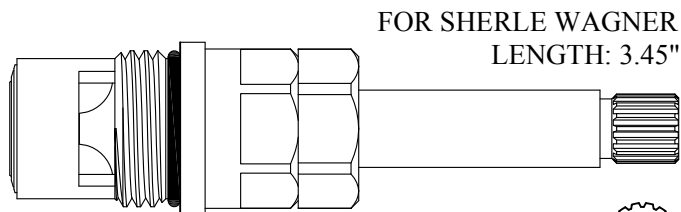

**LF468521/ LF468522**

GASKET: 890170 O-RING INCLUDED  
SEAL: 898510-W  
DISC SET: 151380-PKG

16  
3-15



# CERAMIC DISC CARTRIDGES

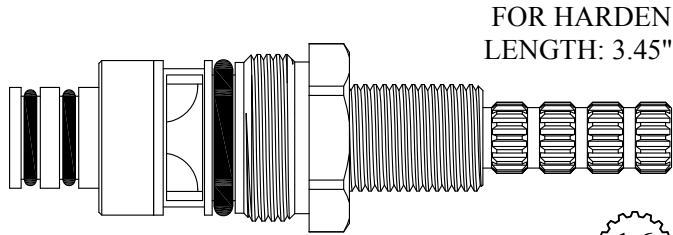

**LF468201/ LF468202**

GASKET: 891140 O-RING INCLUDED  
DISC SET: 151380-PKG

16  
3-16

Polished Brass Stem

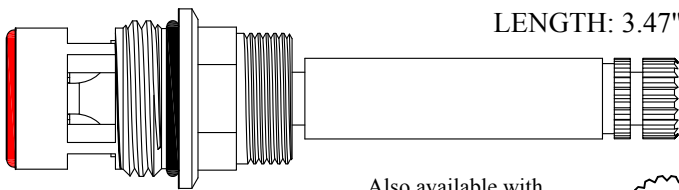

**LF402741  
LF402742**

GASKET: 890170 O-RING INCLUDED  
SEAL: 898570-R/B  
DISC SET: 151380-PKG

Also available with  
polished chrome stem  
**LF402741-CP  
LF402742-CP**

20  
2-4

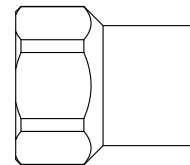

Escutcheon Nut  
# 302740  
available

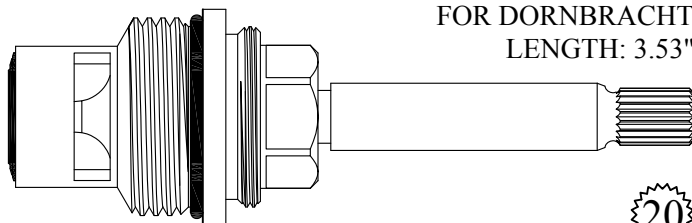

**402861/ 402862**

GASKET: 890210 O-RING INCLUDED  
SEAL: 898510  
DISC SET: 151380-PKG

20  
3-20

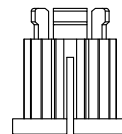

Comes with 20pt Dornbracht  
adapter: 103200

20

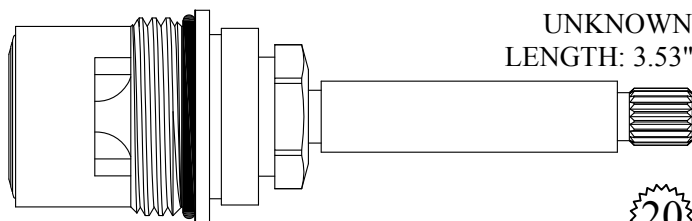

**402571/ 402572**

GASKET: 890210 O-RING INCLUDED  
SEAL: 898520  
DISC SET: 109850-PKG

20  
3-20

# CERAMIC DISC CARTRIDGES

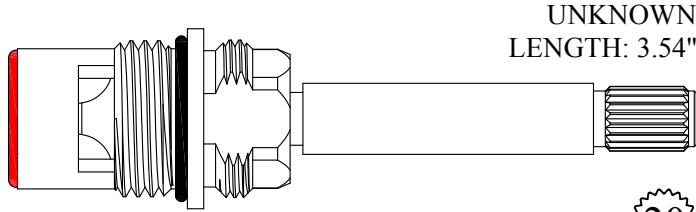

UNKNOWN  
LENGTH: 3.54"

**LF468221/ LF468222**

GASKET: 890170 O-RING INCLUDED  
SEAL: 898570-R/B  
DISC SET: 151380-PKG

20  
11/32  
3-34

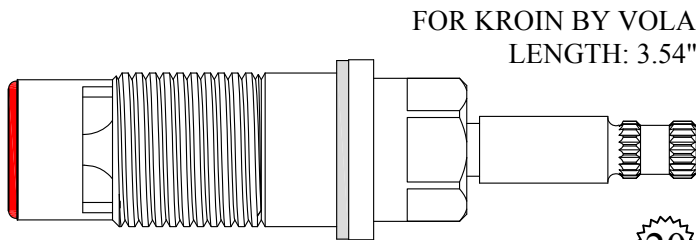

FOR KROIN BY VOLA  
LENGTH: 3.54"

**LF468251/ LF468252**

GASKET: 895150 INCLUDED  
SEAL: 898570-R/B  
DISC SET: 151380-PKG

20  
3-20

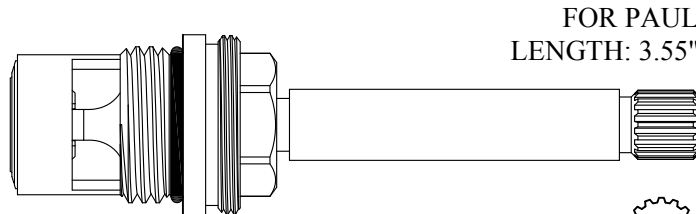

FOR PAUL  
LENGTH: 3.55"

**402931/ 402932**

GASKET: 890170 O-RING INCLUDED  
SEAL: 898510-W  
DISC SET: 151380-PKG

16  
3-16

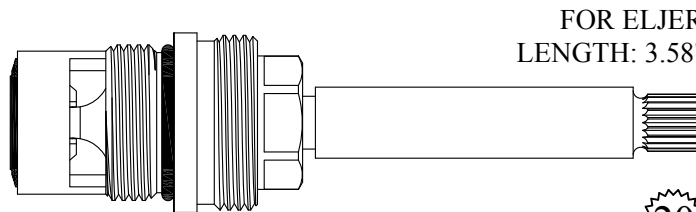

FOR ELJER  
LENGTH: 3.58"

**402911/ 402912**

GASKET: 890170 O-RING INCLUDED  
SEAL: 898510  
DISC SET: 151380-PKG

20  
3-20

# CERAMIC DISC CARTRIDGES

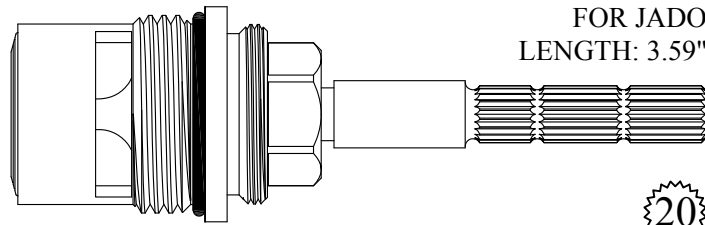

FOR JADO  
LENGTH: 3.59"

20  
3-20

**402971/ 402972**

GASKET: 890210 O-RING INCLUDED  
SEAL: 898520  
DISC SET: 109850-PKG

Chrome Plated Unit

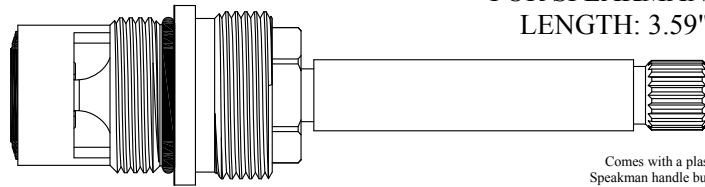

FOR SPEAKMAN  
LENGTH: 3.59"

Comes with a plastic  
Speakman handle bushing

20  
2-4

**402951/ 402952**

GASKET: 890170 O-RING INCLUDED  
SEAL: 898510  
DISC SET: 151380-PKG

Chrome Plated Unit

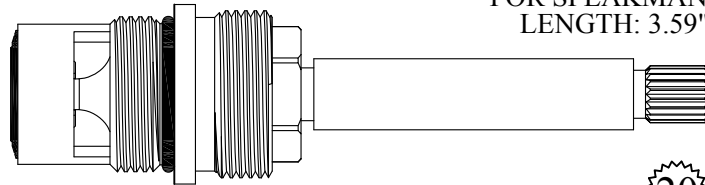

FOR SPEAKMAN  
LENGTH: 3.59"

20  
3-20

**402961/ 402962**

GASKET: 890170 O-RING INCLUDED  
SEAL: 898510  
DISC SET: 151380-PKG

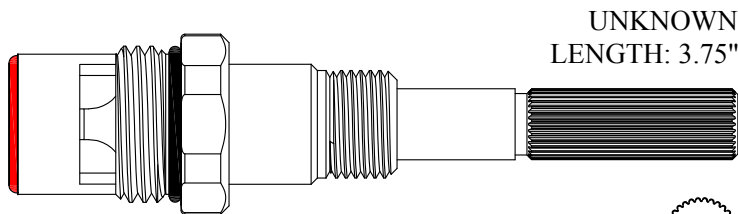

UNKNOWN  
LENGTH: 3.75"

Two nipple extensions are  
used in some applications.  
Order an extra if needed.

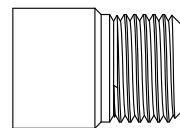

32  
3-23

**LF468441/ LF468442**

GASKET: 890170 O-RING INCLUDED  
SEAL: 898570-R/B  
DISC SET: 151380-PKG

Individual item available  
9/16-20 x 7/8" ext.  
nipple: #118320

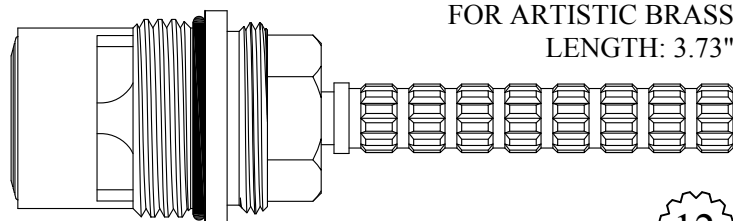

FOR ARTISTIC BRASS  
LENGTH: 3.73"

12  
1-2

**403041/ 403042**

GASKET: 890210 O-RING INCLUDED  
SEAL: 898520  
DISC SET: 109850-PKG

# CERAMIC DISC CARTRIDGES

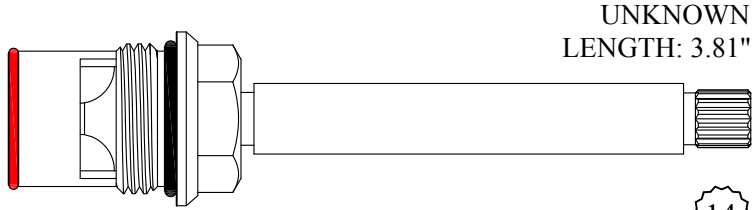

UNKNOWN  
LENGTH: 3.81"

**LF403461/ LF403462**

GASKET: 890170 O-RING INCLUDED  
SEAL: 898580-R/B  
DISC SET: 151380-PKG

14  
5/16

All Brass Unit - No Plastic

FOR AM STD  
LENGTH: 3.87"

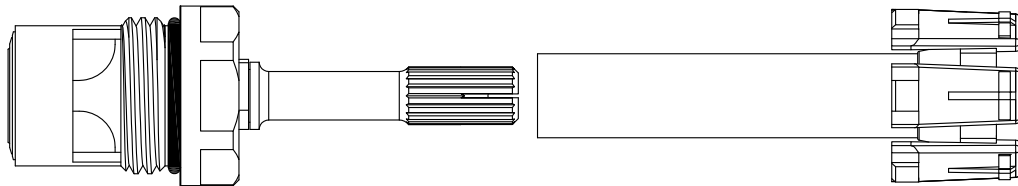

**406101**

GASKET: 890170 O-RING INCLUDED  
SEAL: 898510-W  
DISC SET: 151380-PKG

CERAMIC CONVERSION FOR AM STD COLONY (LONG)  
LENGTH: 3.90"

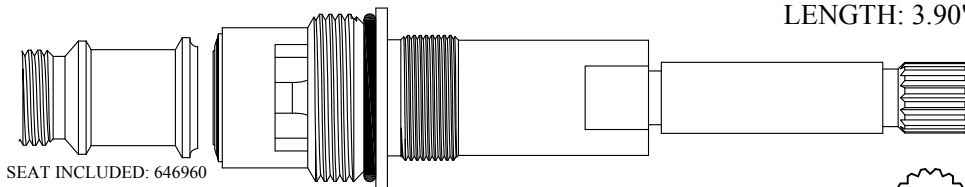

SEAT INCLUDED: 646960

**403481**

GASKET: 890180 O-RING INCLUDED  
SEAL: 898510-W  
DISC SET: 151380-PKG

16  
1-6

FOR JACUZZI  
LENGTH: 3.92"

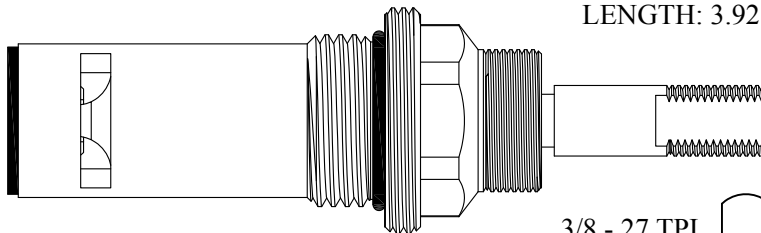

3/8 - 27 TPI

**403821/ 403822**

GASKET: 890190 O-RING INCLUDED  
SEAL: 898550  
DISC SET: 151380-PKG



# CERAMIC DISC CARTRIDGES

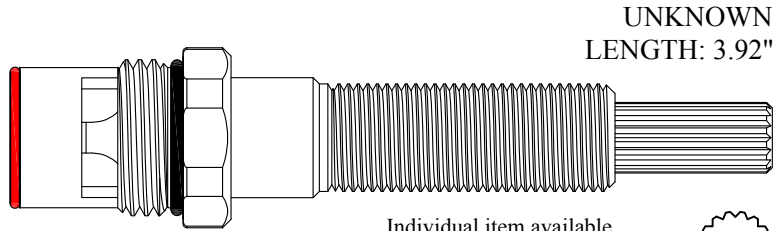

UNKNOWN  
LENGTH: 3.92"

**403631/ 403632**

GASKET: 890170 O-RING INCLUDED  
SEAL: 898580-R/B  
DISC SET: 151380-PKG

Individual item available  
9/16-20 x 2.0" ext. nipple: #135260



1-6

Polished Brass Stem

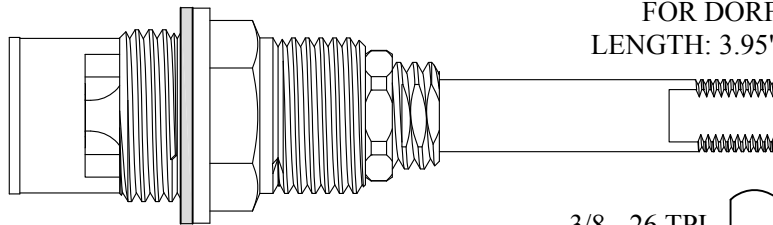

FOR DORF  
LENGTH: 3.95"

3/8 - 26 TPI



**LF469301/ LF469302**

DISC SET: 151380-PKG  
GASKET: 895370 INCLUDED

Also available with a Polished Chrome Plated Stem  
**LF469301-CP / LF469302-CP**

Polished Brass Stem

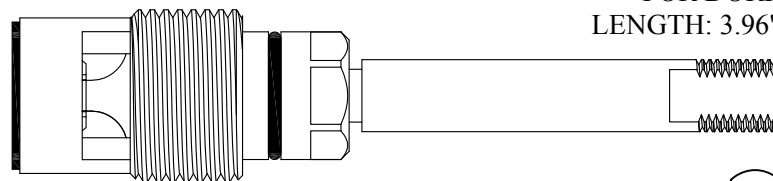

FOR DORF  
LENGTH: 3.96"

3/8 - 26 TPI



**LF469501/ LF469502**

DISC SET: 151380-PKG  
GASKET: 895370

Also available with a Polished Chrome Plated Stem  
**LF469501-CP / LF469502-CP**

Nut Also available  
**369500**

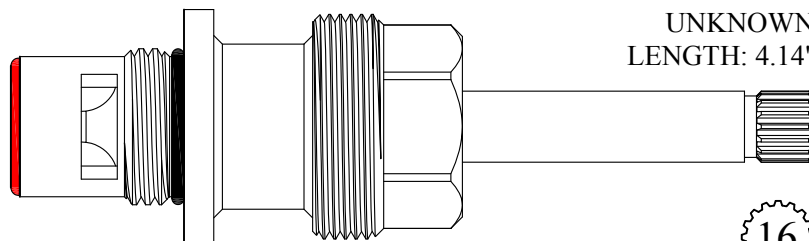
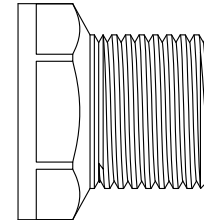

UNKNOWN  
LENGTH: 4.14"

**404301/ 404302**

GASKET: 890170 O-RING INCLUDED  
SEAL: 898580-R/B  
DISC SET: 151380-PKG



3-16

# CERAMIC DISC CARTRIDGES

CERAMIC CONVERSION FOR BROADWAY COMPRESSION

LENGTH: 4.16"

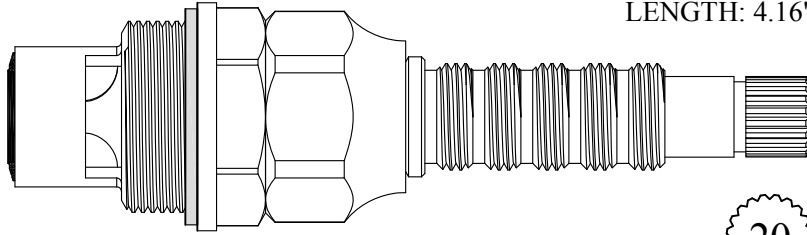

Must use the 647490 seat to convert from a compression to the ceramic

**404621**

GASKET INCLUDED: 895550  
SEAL: 898510  
DISC SET: 151380-PKG

20

2-4

FOR WOLVERINE

LENGTH: 4.19"

Nickel Plated Stem

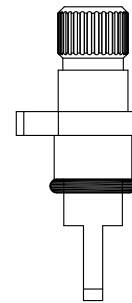
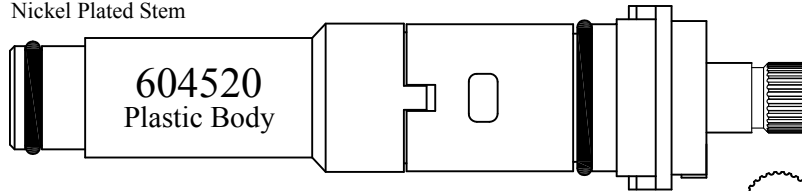

Available: Stem Only

**LF263321**  
**LF263322**

Also available as  
a RH/LH Kit

**LF404521-2**

Kit includes:

- (1) RH Stem
- (1) LH Stem
- (1) Body

**LF404521/ LF404522**

DISC SET: 151380-PKG

30

3-35

FOR WOLVERINE

LENGTH: 4.22"

Nickel Plated Stem

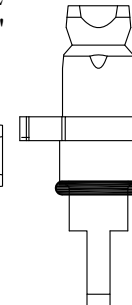
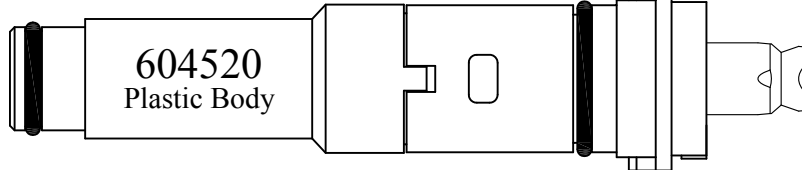

Available: Stem Only

**LF263361**  
**LF263362**

Also available as  
a RH/LH Kit

**LF404531-2**

Kit includes:

- (1) RH Stem
- (1) LH Stem
- (1) Body

**LF404531/ LF404532**

DISC SET: 151380-PKG

30

3-35

CERAMIC CONVERSION FOR KOHLER LF470701/2

LENGTH: 4.25"

Chrome Plated Stem

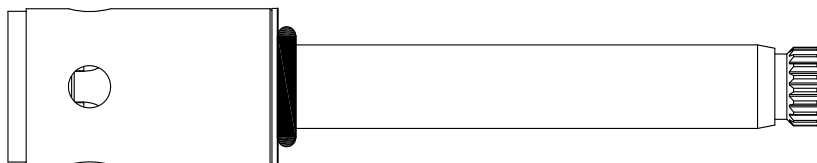

1-7

Also available with a Polished Gold Stem

**LF470741/ LF470742**

DISC SET: 151380-PKG

**LF470741-PG / LF470742-PG**

# CERAMIC DISC CARTRIDGES

CERAMIC CONVERSION FOR KOHLER TREND  
LENGTH: 4.24"

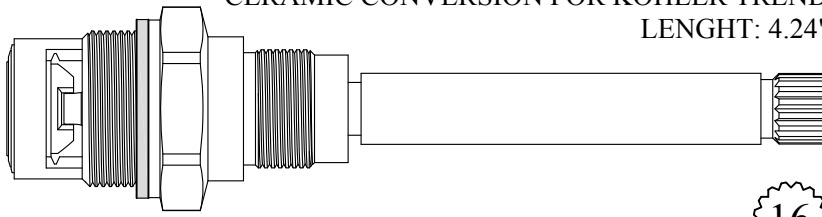

404821/ 404822

GASKET: 895150 INCLUDED  
SEAL: 898510-W  
DISC SET: 151380-PKG

16  
1-6

FOR MILWAUKEE  
LENGTH: 4.32"

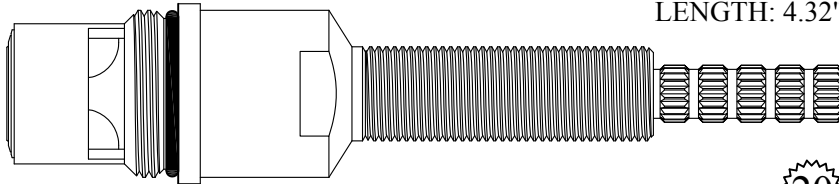

405191/ 405192

GASKET: 890170 O-RING INCLUDED  
SEAL: 898510-W  
DISC SET: 151380-PKG

20  
3-20

FOR ARTI DECO  
LENGTH: 4.32"

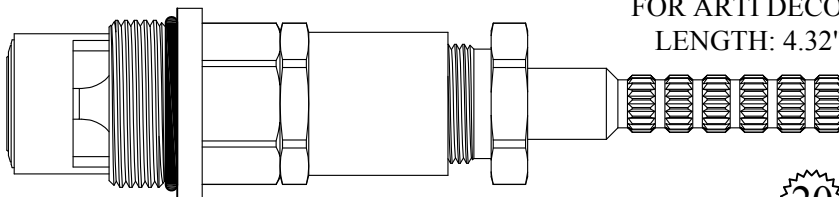

405221/ 405222

GASKET: 890170 O-RING INCLUDED  
SEAL: 898510-W  
DISC SET: 151380-PKG

20  
3-20

FOR ROHL  
LENGTH: 4.32"

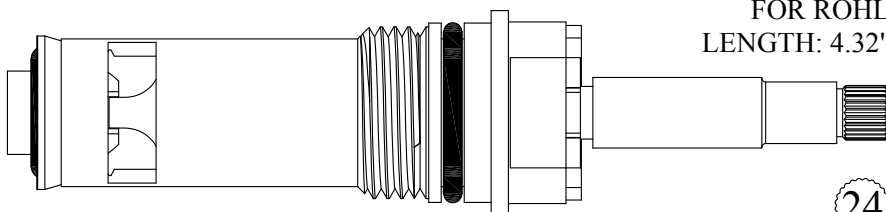

LF471401/ LF471402

GASKET: 891160 O-RING INCLUDED  
DISC SET: 151380-PKG

24  
9/32

# CERAMIC DISC CARTRIDGES

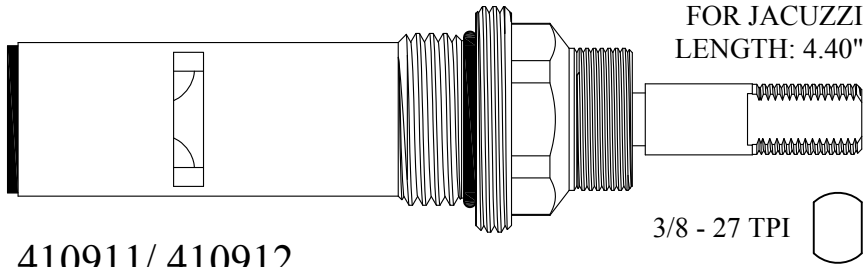

FOR JACUZZI  
LENGTH: 4.40"

3/8 - 27 TPI

**410911/ 410912**

GASKET: 890190 O-RING INCLUDED  
SEAL: 898550  
DISC SET: 151380-PKG

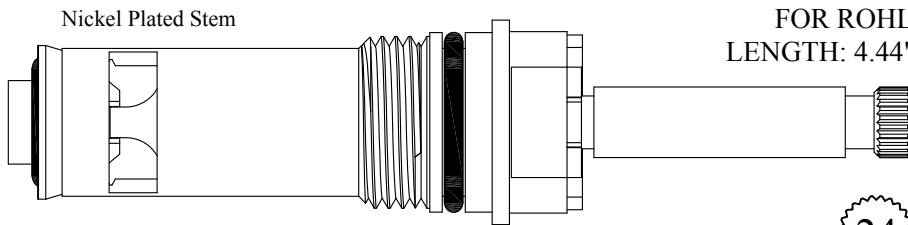

FOR ROHL  
LENGTH: 4.44"

24  
3-19

**LF471601/ LF471602**

GASKET: 891160 O-RING INCLUDED  
DISC SET: 151380-PKG

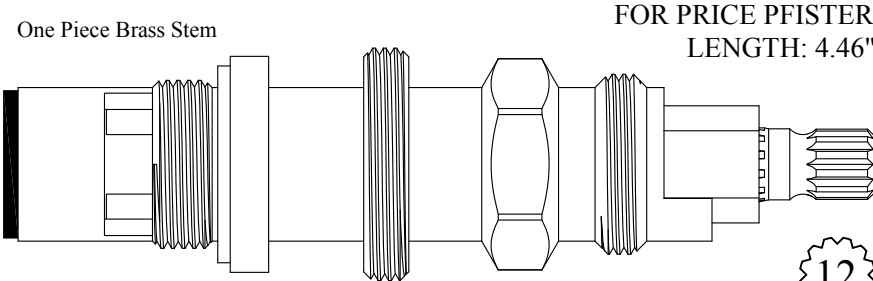

FOR PRICE PFISTER  
LENGTH: 4.46"

12  
1-2

**405411**

GASKET: 895390 INCLUDED  
SEAL: 898550  
DISC SET: 151380-PKG



You can use the 647390 seat to convert the old Beau Art body to accept the 405411 ceramic cartridge

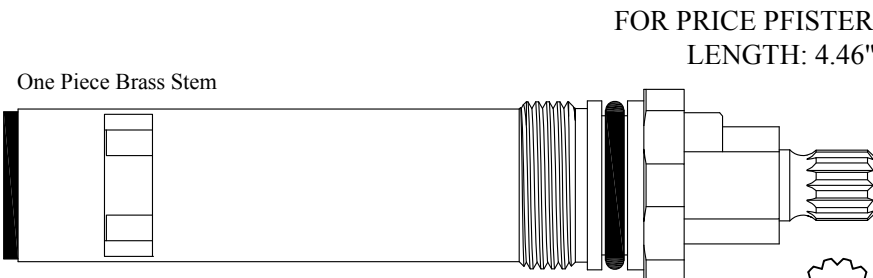

FOR PRICE PFISTER  
LENGTH: 4.46"

12  
1-2

**405421**

GASKET: 891150 O-RING INCLUDED  
SEAL: 898550  
DISC SET: 124290-PKG



# CERAMIC DISC CARTRIDGES

Chrome Plated Stem

FOR PAUL  
LENGTH: 4.45"

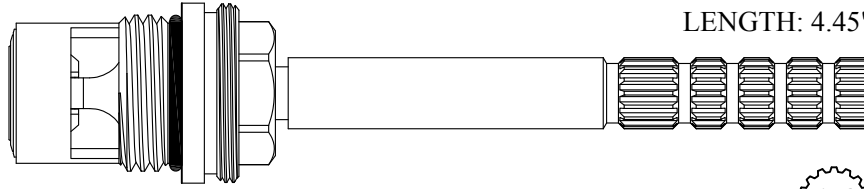

**406731/ 406732**

GASKET: 890170 O-RING INCLUDED  
SEAL: 898510-W  
DISC SET: 151380-PKG

16  
3-16

All Brass Stem - No Plastic

FOR STERLING FAUCET  
LENGTH: 4.56"

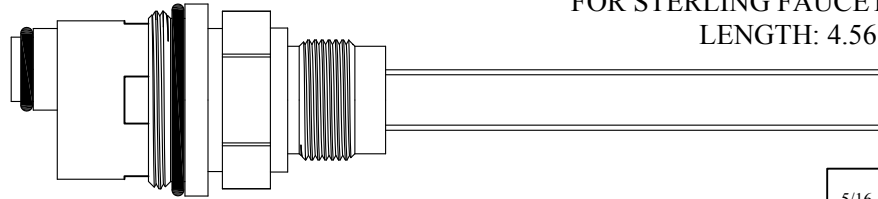

**406741/ 406742**

GASKET: 890190 O-RING INCLUDED

5/16

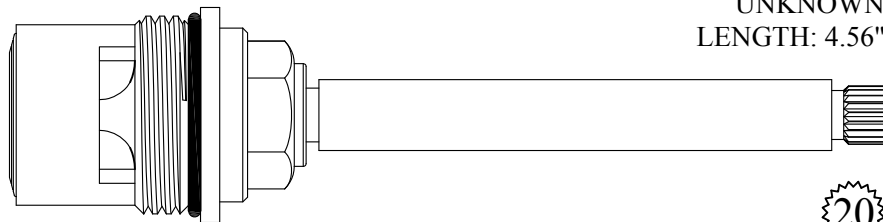

UNKNOWN  
LENGTH: 4.56"

**426271/ 426272**

GASKET: 890210 O-RING INCLUDED  
SEAL: 898520  
DISC SET: 109850-PKG

20  
3-20

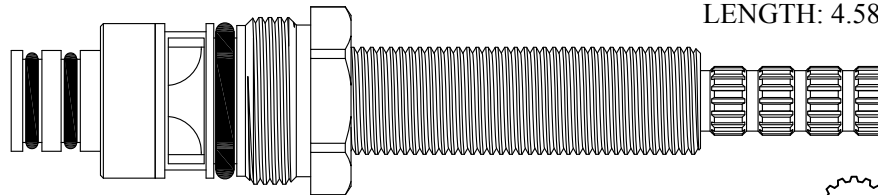

FOR HARDEN  
LENGTH: 4.58"

**408011/ 408012**

GASKET: 891140 O-RING INCLUDED  
DISC SET: 151380-PKG

16  
3-16

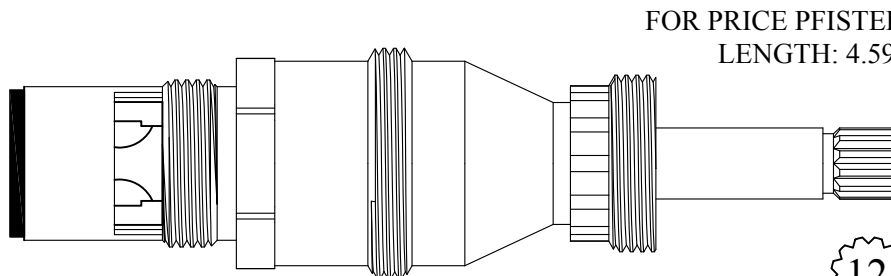

FOR PRICE PFISTER  
LENGTH: 4.59"

**405441**

GASKET: 895390 INCLUDED  
SEAL: 898550  
DISC SET: 151380-PKG

12  
1-2

# CERAMIC DISC CARTRIDGES

1/2 Turn Ceramic  
Polished Brass Stem

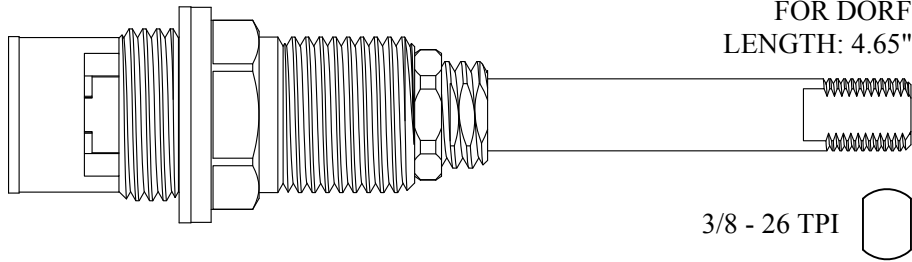

FOR DORF  
LENGTH: 4.65"

3/8 - 26 TPI

**407941/ 407942**

DISC SET: 124290-PKG  
GASKET: 895370 INCLUDED

Also available with a Polished Chrome Plated Stem

**407941-CP / 407942-CP**

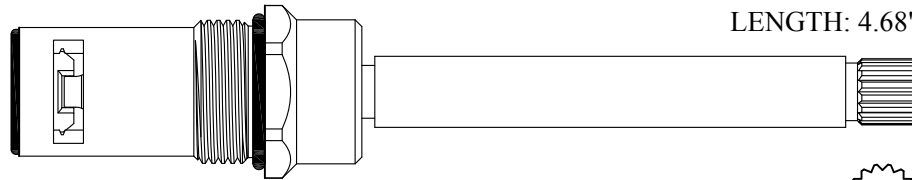

FOR SAYCO  
LENGTH: 4.68"



**408611/ 408612**

GASKET: 890170 O-RING INCLUDED  
SEAL: 898540  
DISC SET: 112530-PKG

Ceramic Conversion for 412811

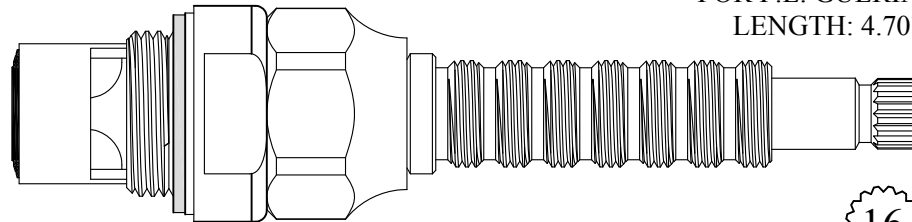

FOR P.E. GUERIN  
LENGTH: 4.70"

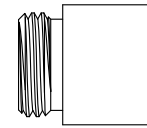

Must use the 647480 seat  
to convert from a  
compression to the ceramic

**407991**

GASKET: 895400 INCLUDED  
SEAL: 898510  
DISC SET: 151380-PKG

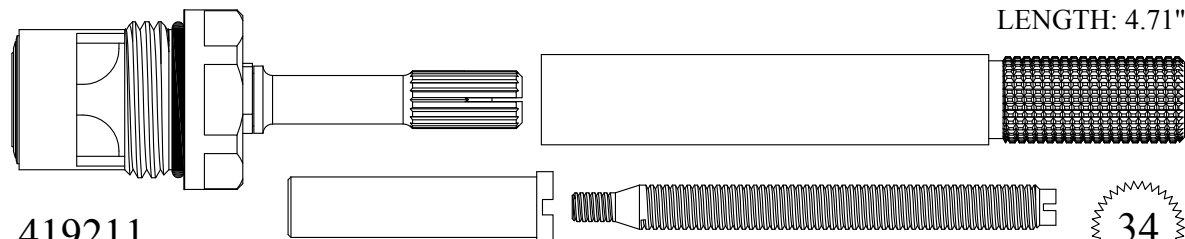

FOR AM STD  
LENGTH: 4.71"



**419211**

GASKET: 890170 O-RING INCLUDED  
SEAL: 898510-W  
DISC SET: 151380-PKG

# CERAMIC DISC CARTRIDGES

Nickel Plated Gland

FOR AUBURN BRASS  
LENGTH: 4.70"

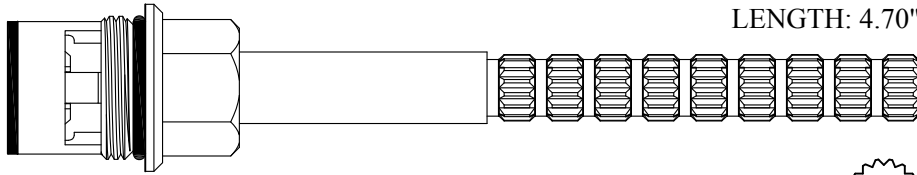

16  
2-3

404831/ 404832

GASKET: 890160 O-RING INCLUDED  
DISC SET: 151380-PKG

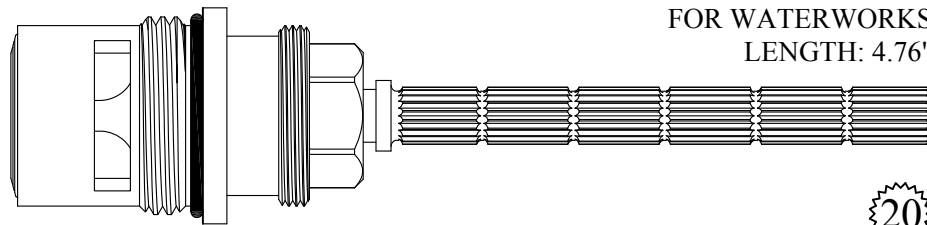

FOR WATERWORKS  
LENGTH: 4.76"

20  
3-20

409941/ 409942

GASKET: 890210 O-RING INCLUDED  
SEAL: 898520  
DISC SET: 109850-PKG

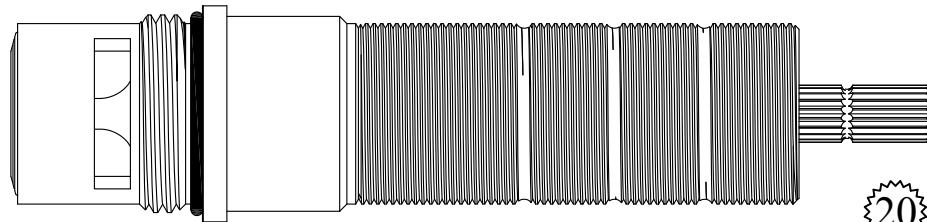

FOR WATERWORKS  
LENGTH: 4.76"

20  
3-20

409941-EN/ 409942-EN

GASKET: 890210 O-RING INCLUDED  
SEAL: 898520  
DISC SET: 109850-PKG

Escutcheon Nipple available separately  
127350

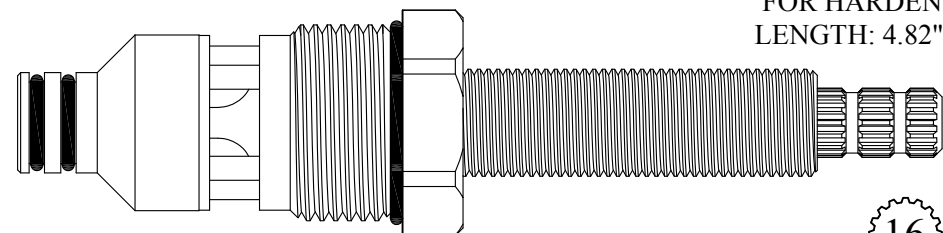

FOR HARDEN  
LENGTH: 4.82"

16  
3-16

409931/ 409932

GASKET: 890210 O-RING INCLUDED  
DISC SET: 151380-PKG

# CERAMIC DISC CARTRIDGES

FOR SEPCO  
LENGTH: 4.83"

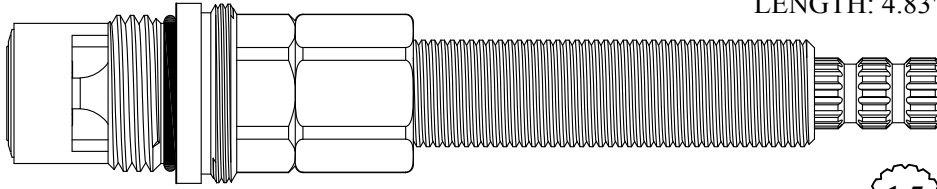

15  
3-27

410031/ 410032

GASKET: 890170 O-RING INCLUDED  
SEAL: 898510-W  
DISC SET: 151380-PKG

Polished Brass Stem Extension

FOR PHYLRICH  
LENGTH: 4.83"

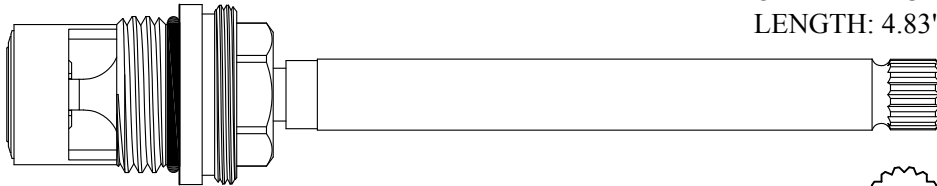

Individual items available  
Stem Ext. 3.25": #132150-PB  
& 132150-CP  
Ext. Adap. Screw: #103310

Also available with chrome plated stem extension

410061/ 410062    410061-CP/ 410062-CP

GASKET: 890170 O-RING INCLUDED  
SEAL: 898510-W  
DISC SET: 151380-PKG

16  
1-6

FOR PHYLRICH  
LENGTH: 4.83"

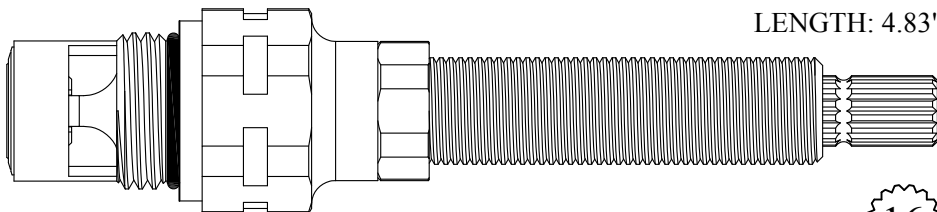

Individual items available  
Stem Ext. 3-1/4": #102960  
Ext. Adap. Screw: #103310

410081/ 410082

GASKET: 890170 O-RING INCLUDED  
SEAL: 898510-W  
DISC SET: 151380-PKG

16  
1-6

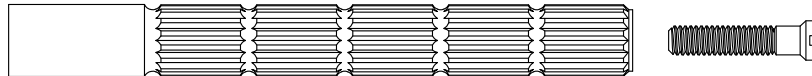

FOR NEWPORT  
LENGTH: 4.88"

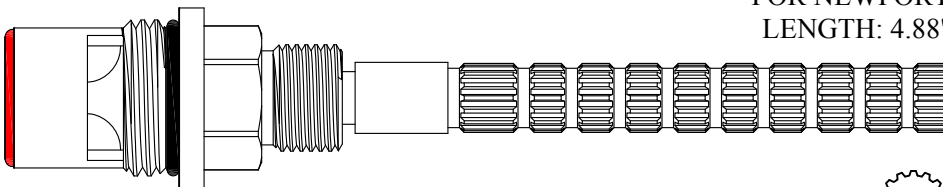

16  
3-16

411221/ 411222

GASKET: 890170 O-RING INCLUDED  
SEAL: 898570-R/B  
DISC SET: 151380-PKG

# CERAMIC DISC CARTRIDGES

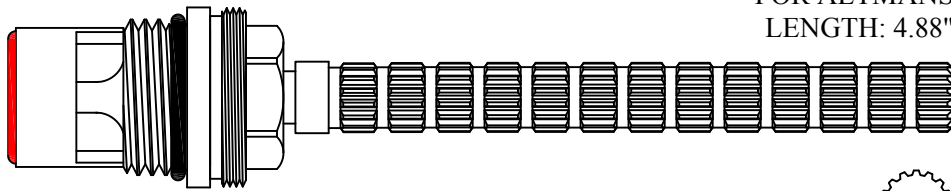

FOR ALTMANS  
LENGTH: 4.88"

417311/ 417312

GASKET: 890170 O-RING INCLUDED  
SEAL: 898570-R/B  
DISC SET: 151380-PKG

16  
3-16

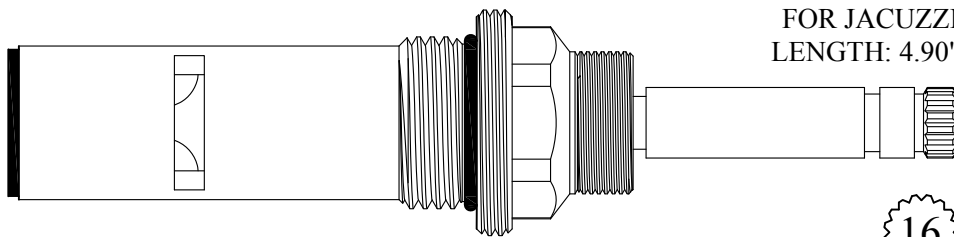

FOR JACUZZI  
LENGTH: 4.90"

410921/ 410922

GASKET: 890190 O-RING INCLUDED  
SEAL: 898550  
DISC SET: 151380-PKG

16  
1-6

Chrome Plated Stem

CERAMIC CONVERSION FOR KOHLER 407001/2  
LENGTH: 4.90"

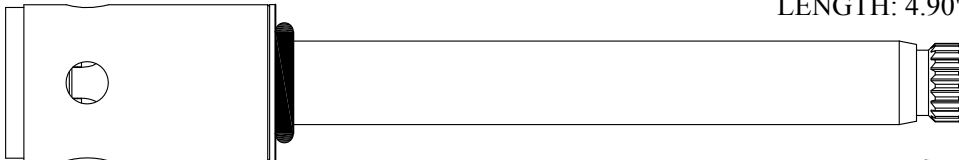

407041/ 407042

DISC SET: 151380-PKG

Also available with gold plated stem  
407041-PG/ 407042-PG

19  
1-7

Polished Brass Stem Extension

FOR PHYLRICH  
LENGTH: 4.97"

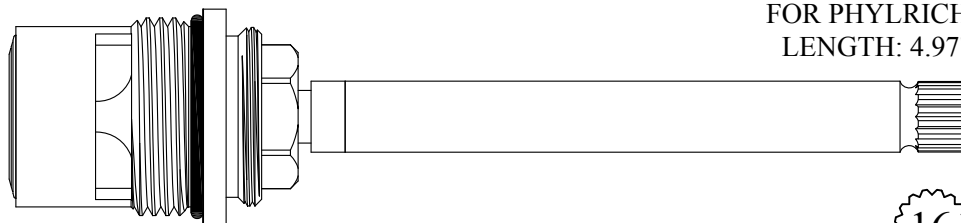

412041/ 412042

GASKET: 890210 O-RING INCLUDED  
SEAL: 898520  
DISC SET: 109850-PKG

Also available with chrome plated stem extension  
412041-CP/ 412042-CP

16  
1-6

Individual items available  
Stem Ext. 3.25": #132150-PB  
& 132150-CP  
Ext. Adap. Screw: #103310

# CERAMIC DISC CARTRIDGES

FOR CONCINITY  
LENGTH: 4.97"

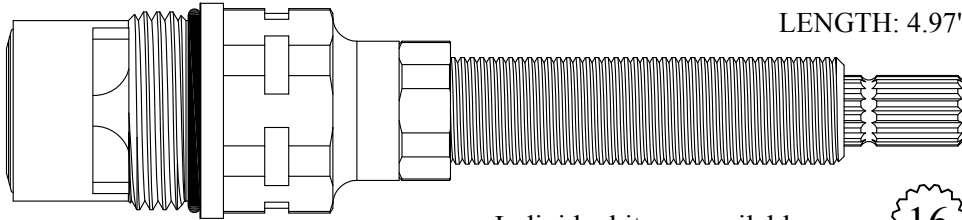

**412031/ 412032**

GASKET: 890210 O-RING INCLUDED  
SEAL: 898520  
DISC SET: 109850-PKG

Individual items available  
Stem Ext. 3-1/4": #102960  
Ext. Adap. Screw: #103310

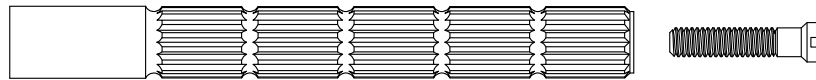

Chrome Plated Unit

UNKNOWN  
LENGTH: 5.00"

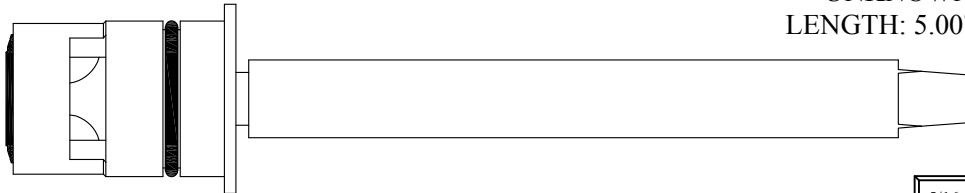

**412641/ 412642**

GASKET: 890170 O-RING INCLUDED  
SEAL: 898510  
DISC SET: 151380-PKG

FOR SAYCO  
LENGTH: 5.04"

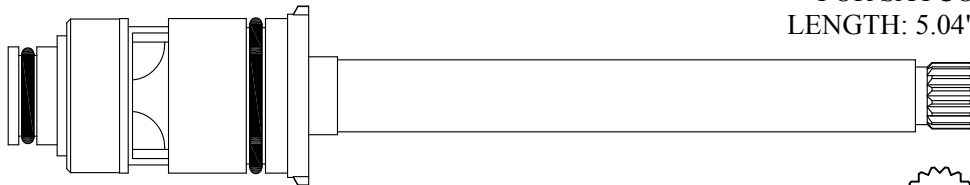

**414421/ 414422**

GASKET: 890170 O-RING INCLUDED  
DISC SET: 151380-PKG



Not Available, Use 414421 / 414422

Chrome Plated Stem

FOR SIGN OF THE CRAB  
LENGTH: 5.01"

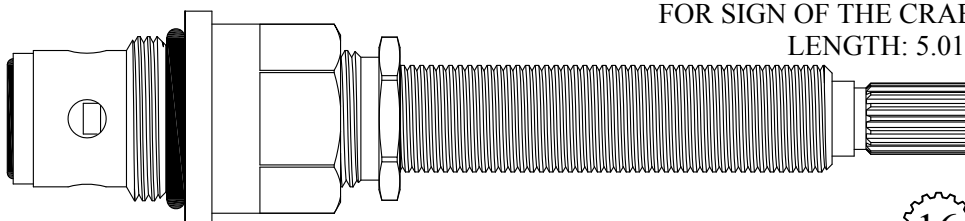

**414911/ 414912**

GASKET: 891160 O-RING INCLUDED  
DISC SET: 112530-PKG

# CERAMIC DISC CARTRIDGES

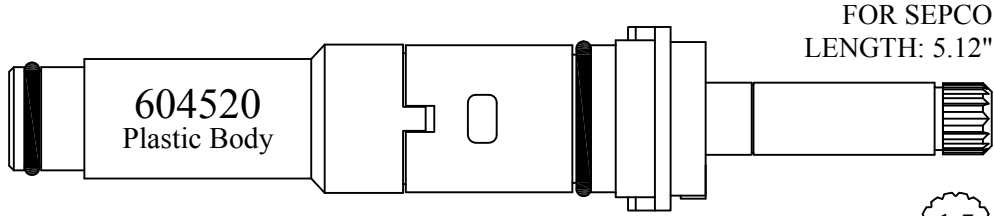

414711/ 414712

15  
3-27

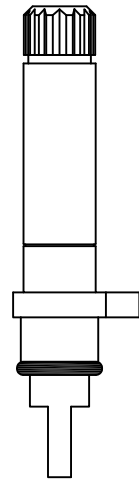

Available: Stem Only  
214711 / 214712

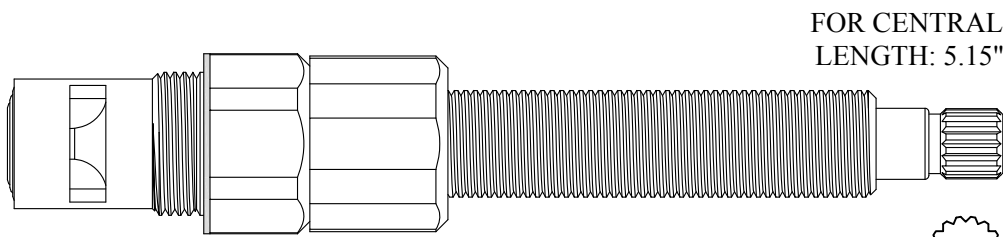

416821/ 416822

GASKET: 895270 INCLUDED  
SEAL: 898500  
DISC SET: 112530-PKG

16  
1-6

Polished Brass Stem

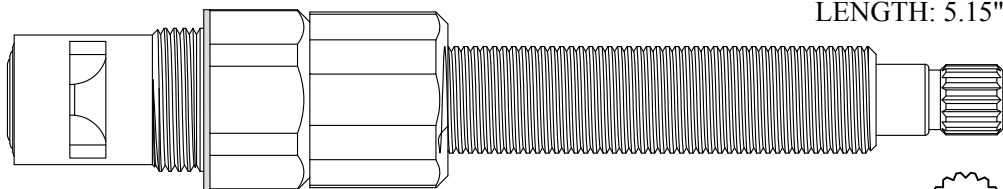

416831/ 416832

GASKET: 895270 INCLUDED  
SEAL: 898500  
DISC SET: 112530-PKG

Also available with chrome plated stem  
416831-CP/ 416832-CP

16  
1-6

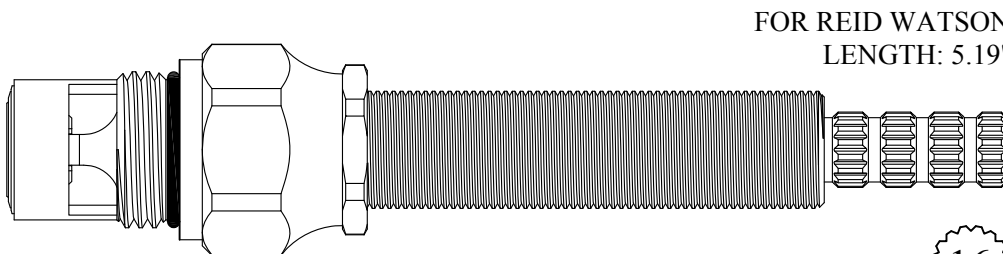

416711/ 416712

GASKET: 890170 O-RING INCLUDED  
SEAL: 898510-W  
DISC SET: 151380-PKG

16  
1-5

# CERAMIC DISC CARTRIDGES

Nickel Plated Stem

FOR CHICAGO  
LENGTH: 5.28"

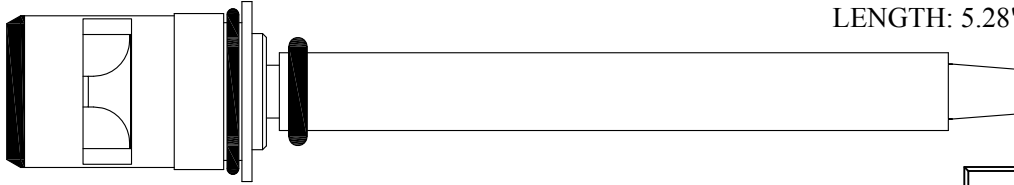

LF475411/ LF475412

GASKET: 890170 O-RING INCLUDED  
SEAL: 898590 & LF132250  
DISC SET: 151380-PKG



FOR NFC / AMERICAN FAUCETS  
LENGTH: 5.30"

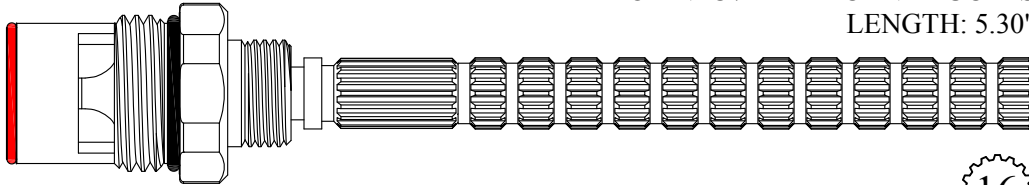

417221/ 417222

GASKET: 890170 O-RING INCLUDED  
SEAL: 898580-R/B  
DISC SET: 151380-PKG



FOR GLACIER BAY  
LENGTH: 5.35"

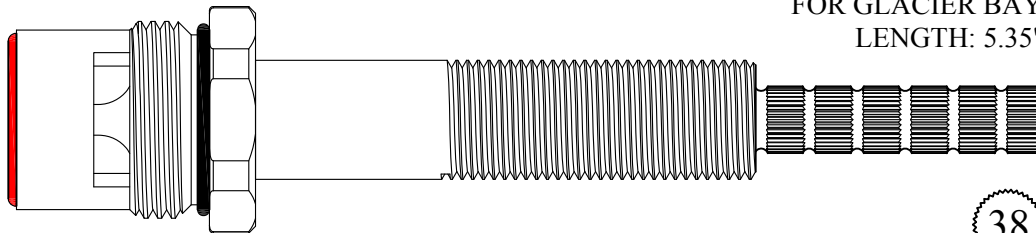

421421/ 421422

GASKET: 890200 O-RING INCLUDED  
SEAL: 898610-R/B  
DISC SET: 109850-PKG



FOR DORNBRACHT  
LENGTH: 5.38"

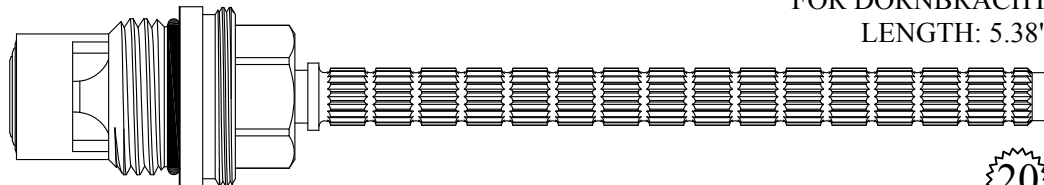

421161/ 421162

GASKET: 890170 O-RING INCLUDED  
SEAL: 898500  
DISC SET: 112530-PKG

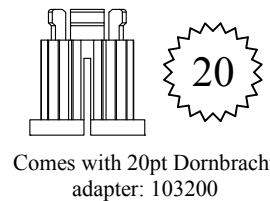

FOR DORNBRACHT  
LENGTH: 5.38"

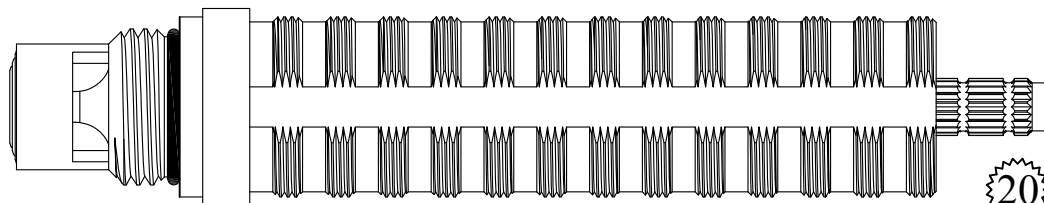

421161-EN/ 421162-EN

GASKET: 890170 O-RING INCLUDED  
SEAL: 898500  
DISC SET: 112530-PKG

Individual item available  
esc.. nipple: #125080

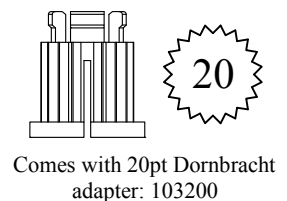



# CERAMIC DISC CARTRIDGES



FOR ONDINE  
LENGTH: 5.43"

421221/ 421222

GASKET: 890170 O-RING INCLUDED  
SEAL: 898570-R/B  
DISC SET: 151380-PKG



FOR ONDINE  
LENGTH: 5.44"

421241/ 421242

GASKET: 890210 O-RING INCLUDED  
SEAL: 898610-R/B  
DISC SET: 109850-PKG

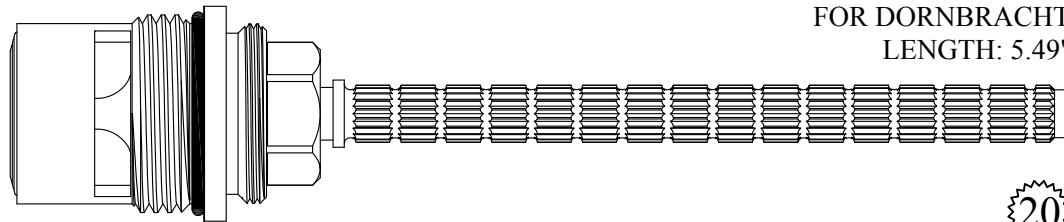

FOR DORNBRACHT  
LENGTH: 5.49"

422601/ 422602

GASKET: 890210 O-RING INCLUDED  
SEAL: 898520  
DISC SET: 109850-PKG

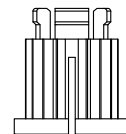

Comes with 20pt Dornbracht  
adapter: 103200

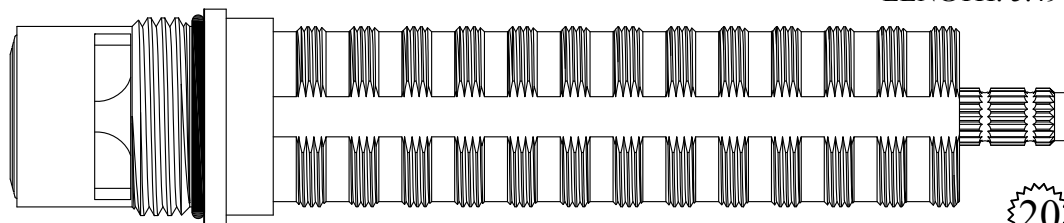

FOR DORNBRACHT  
LENGTH: 5.49"

422601-EN/ 422602-EN

GASKET: 890210 O-RING INCLUDED  
SEAL: 898520  
DISC SET: 109850-PKG

Individual item available  
esc.. nipple: #125080

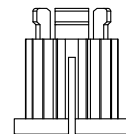

Comes with 20pt Dornbracht  
adapter: 103200



# CERAMIC DISC CARTRIDGES

1/2 Turn Ceramic

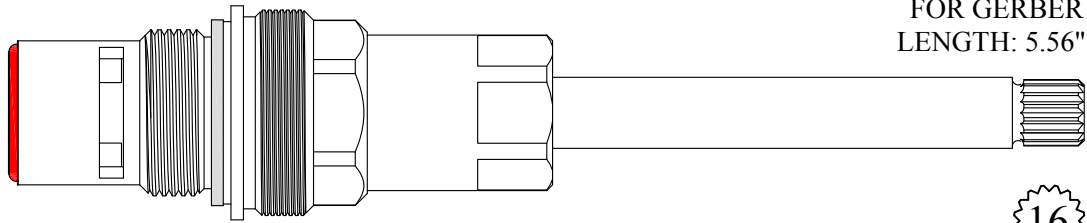

FOR GERBER  
LENGTH: 5.56"

16

2-3

422411/ 422412

GASKET: 895180 INCLUDED  
SEAL: 898570-R/B  
DISC SET: 124290-PKG

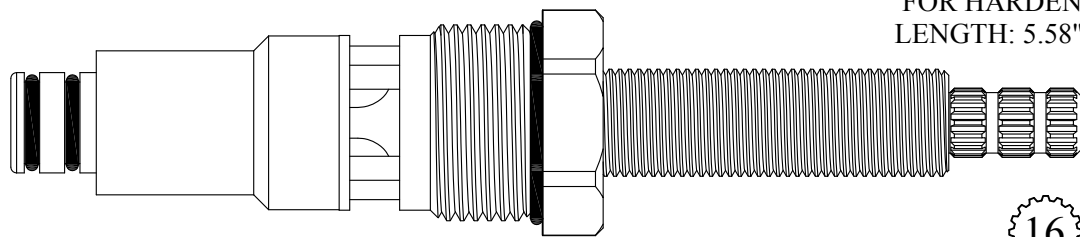

FOR HARDEN  
LENGTH: 5.58"

16

3-16

423931/ 423932

GASKET: 890210 O-RING INCLUDED  
DISC SET: 151380-PKG

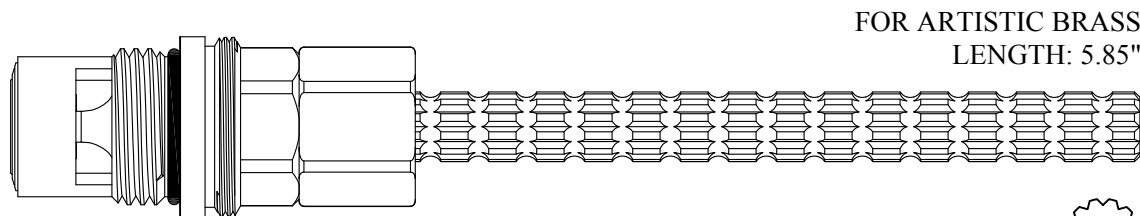

FOR ARTISTIC BRASS  
LENGTH: 5.85"

12

1-2

425721/ 425722

GASKET: 890170 O-RING INCLUDED  
SEAL: 898510-W  
DISC SET: 151380-PKG

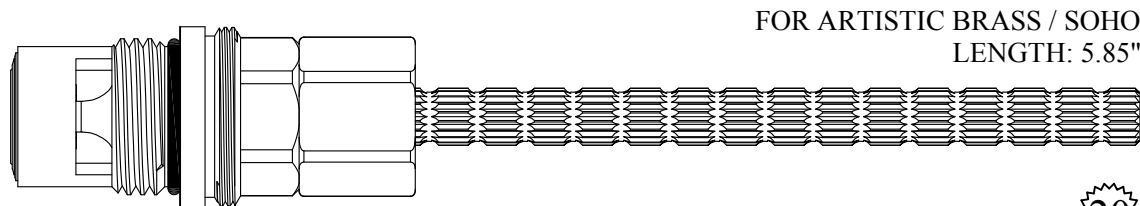

FOR ARTISTIC BRASS / SOHO  
LENGTH: 5.85"

20

3-20

425741/ 425742

GASKET: 890170 O-RING INCLUDED  
SEAL: 898510-W  
DISC SET: 151380-PKG

# CERAMIC DISC CARTRIDGES

FOR NEWPORT  
LENGTH: 5.85"

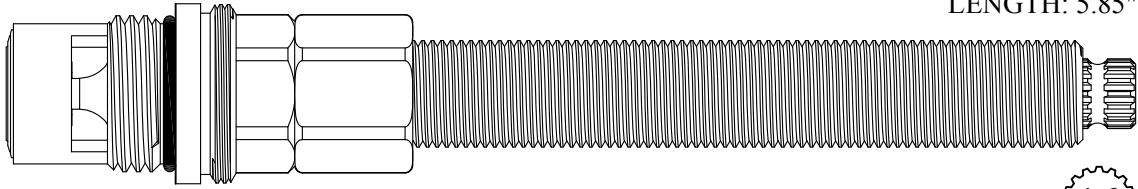

**411271/ 411272**

GASKET: 890170 O-RING INCLUDED  
SEAL: 898510-W  
DISC SET: 151380-PKG



FOR NEWPORT  
LENGTH: 5.88"

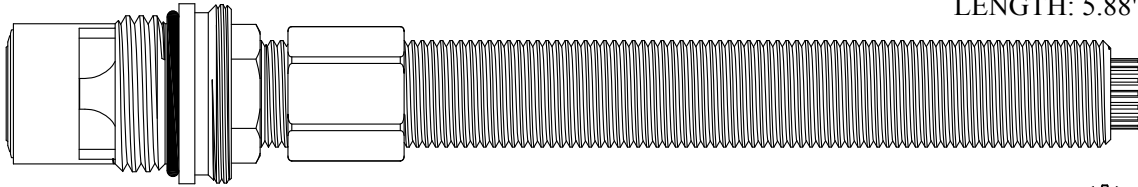

**411281/ 411282**

GASKET: 890170 O-RING INCLUDED  
SEAL: 898510-W  
DISC SET: 151380-PKG

Individual items available  
Nipple Ext. Nut: #611270



FOR CAL FAUCETS  
LENGTH: 5.88"

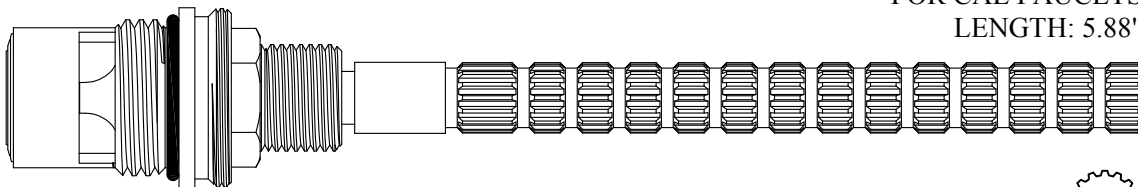

**411291/ 411292**

GASKET: 890170 O-RING INCLUDED  
SEAL: 898510-W  
DISC SET: 151380-PKG



1/2 Turn Ceramic

FOR DOLLY TRIM  
LENGTH: 5.88"

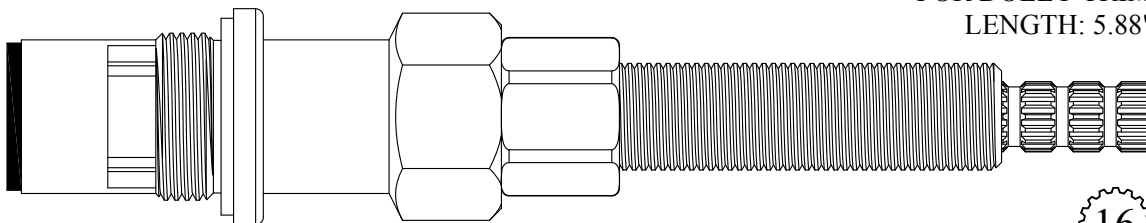

**421641/ 421642**

GASKET: 895390 INCLUDED  
SEAL: 898550  
DISC SET: 124290-PKG



# CERAMIC DISC CARTRIDGES

Ceramic Conversion for 421601 / 421602

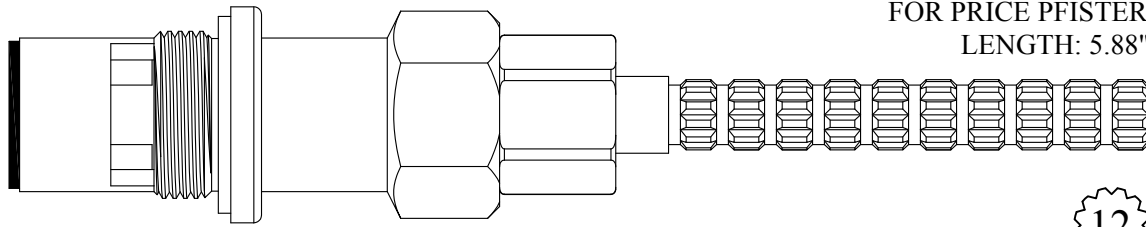

FOR PRICE PFISTER  
LENGTH: 5.88"

**421691/ 421692**

GASKET: 895390 INCLUDED  
SEAL: 898550  
DISC SET: 124290-PKG

12  
1-2

1/2 Turn Ceramic  
Polished Gold Stem

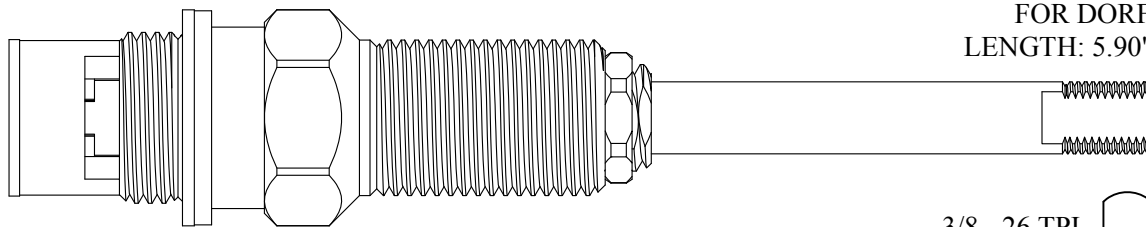

FOR DORF  
LENGTH: 5.90"

**425941/ 425942**

DISC SET: 124290-PKG  
GASKET: 895370 INCLUDED

Also available with Polished Chrome Stem  
**425941-CP/ 425942-CP**

3/8 - 26 TPI

1/4 Turn Ceramic  
Polished Gold Stem

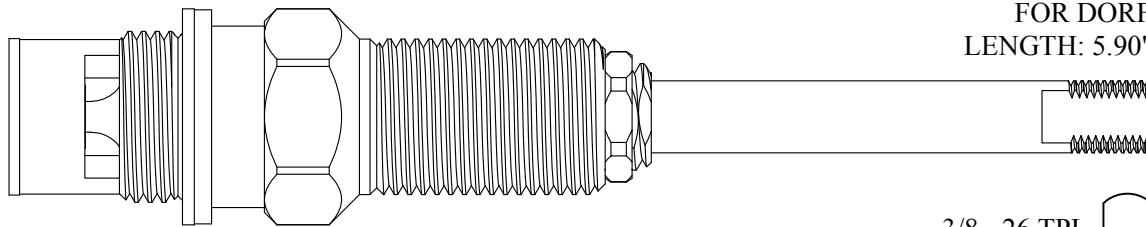

FOR DORF  
LENGTH: 5.90"

**425981/ 425982**

DISC SET: 151380-PKG  
GASKET: 895370 INCLUDED

3/8 - 26 TPI

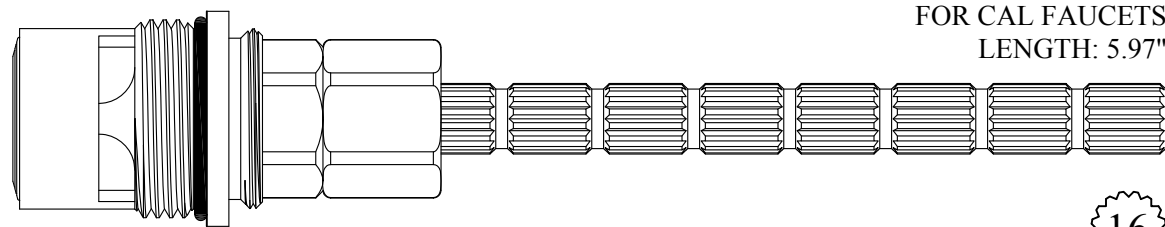

FOR CAL FAUCETS  
LENGTH: 5.97"

**421661/ 421662**

GASKET: 890210 O-RING INCLUDED  
SEAL: 898520  
DISC SET: 109850-PKG

16  
1-6

# CERAMIC DISC CARTRIDGES

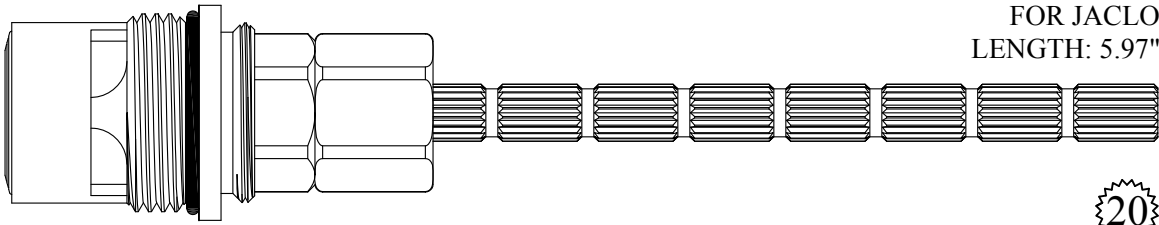

FOR JACLO  
LENGTH: 5.97"

20  
3-20

421681/ 421682

GASKET: 890210 O-RING INCLUDED  
SEAL: 898520  
DISC SET: 109850-PKG

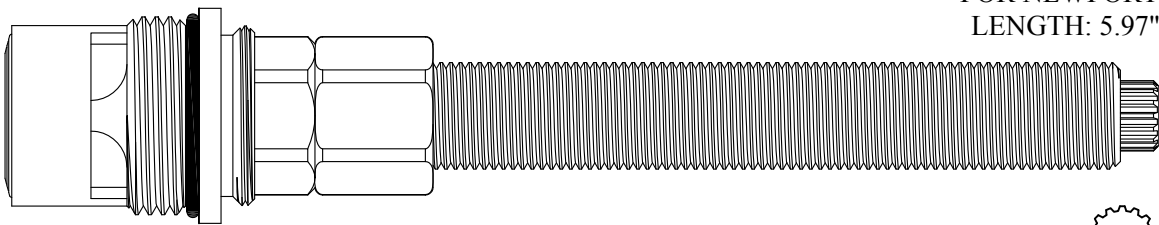

FOR NEWPORT  
LENGTH: 5.97"

16  
3-16

424911/ 424912

GASKET: 890210 O-RING INCLUDED  
SEAL: 898520  
DISC SET: 109850-PKG

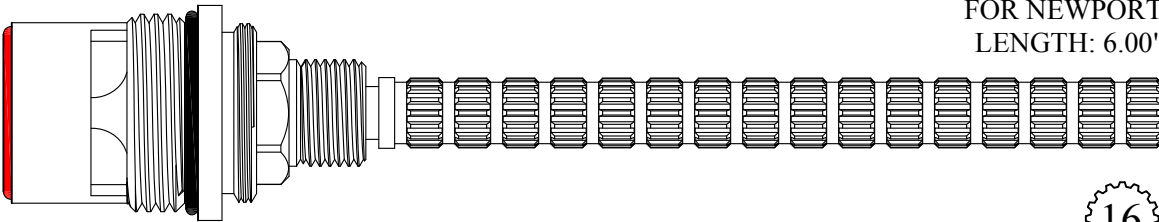

FOR NEWPORT  
LENGTH: 6.00"

16  
3-16

423651/ 423652

GASKET: 890210 O-RING INCLUDED  
SEAL: 898610-R/B  
DISC SET: 109850-PKG

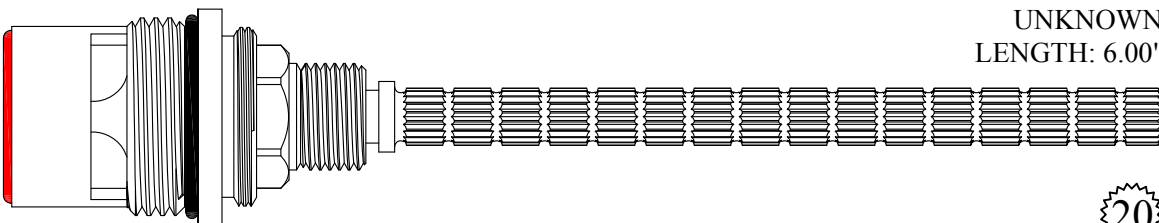

UNKNOWN  
LENGTH: 6.00"

20  
3-20

423671/ 423672

GASKET: 890170 O-RING INCLUDED  
SEAL: 898610-R/B  
DISC SET: 109850-PKG

# CERAMIC DISC CARTRIDGES

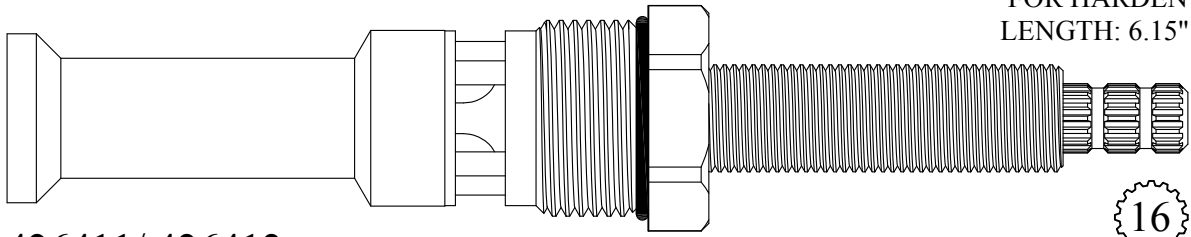

FOR HARDEN  
LENGTH: 6.15"

**426411/ 426412**

GASKET: 890210 O-RING INCLUDED  
SEAL: 64705-07  
DISC SET: 151380-PKG



3-16

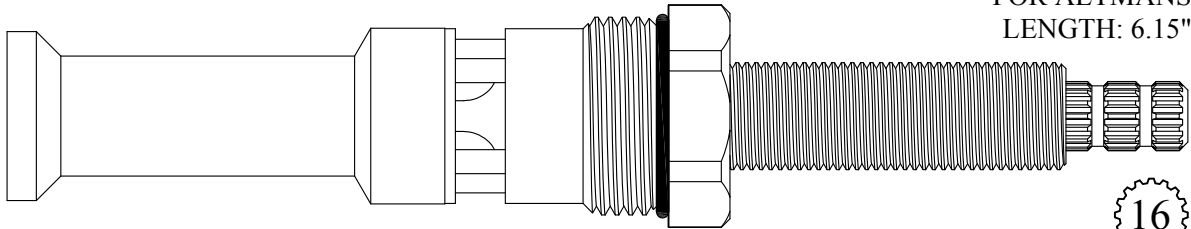

FOR ALTMANS  
LENGTH: 6.15"

**426421/ 426422**

(Replaces Walter# 418811 / 418812 Compression Units)

GASKET: 890210 O-RING INCLUDED  
SEAL: 64705-07  
DISC SET: 151380-PKG



3-16

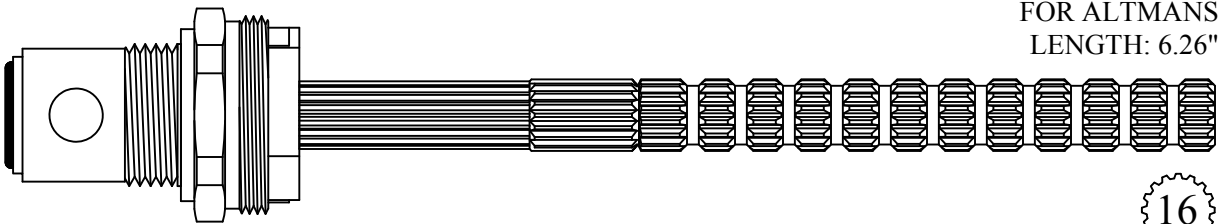

FOR ALTMANS  
LENGTH: 6.26"

**426731/ 426732**

GASKET: 895100 INCLUDED



3-16

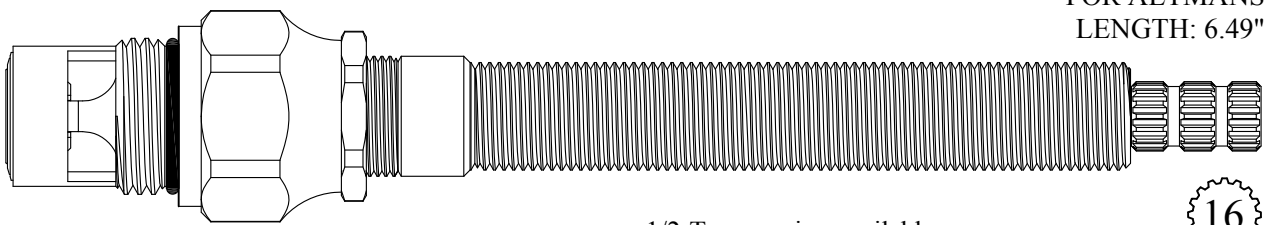

FOR ALTMANS  
LENGTH: 6.49"

**426841/ 426842**

459201 / 459202  
w/ ceramic adapter parts

GASKET: 890170 O-RING INCLUDED  
SEAL: 898510-W  
DISC SET: 151380-PKG

1/2-Turn version available:

**426891/ 426892**

459211 / 459212  
w/ ceramic adapter parts

GASKET: 890170 O-RING INCLUDED  
SEAL: 898510-W  
DISC SET: 124290-PKG



3-16

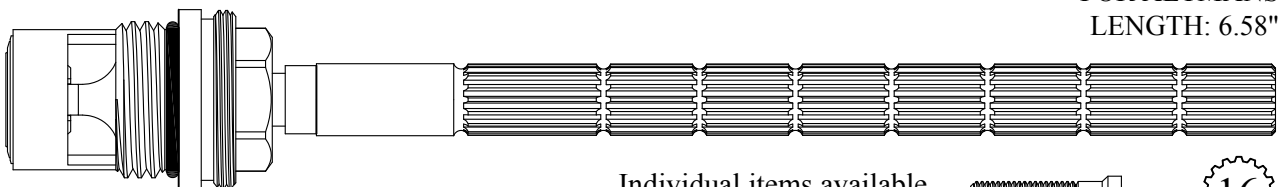

FOR ALTMANS  
LENGTH: 6.58"

**426881/ 426882**

GASKET: 890170 O-RING INCLUDED  
SEAL: 898510-W  
DISC SET: 151380-PKG

Individual items available  
Stem Ext. 5.00": #118290  
Ext. Adap. Screw: #103310



3-16

# CERAMIC DISC CARTRIDGES

FOR PHYLRICH  
LENGTH: 6.58"

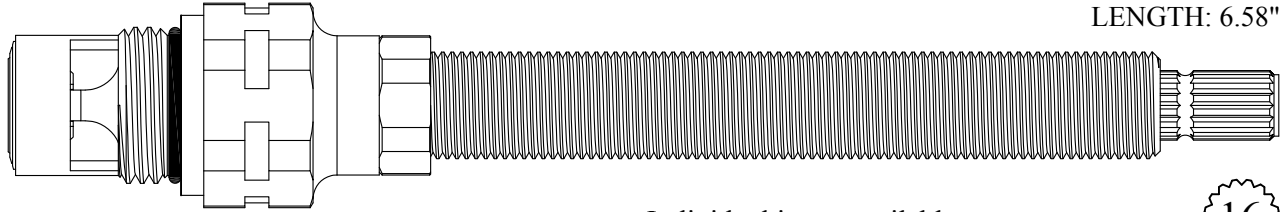

427281/ 427282

GASKET: 890170 O-RING INCLUDED  
SEAL: 898510-W  
DISC SET: 151380-PKG

Individual items available  
Stem Ext. 5.00": #136050  
Ext. Adap. Screw: #103310

16  
1-6

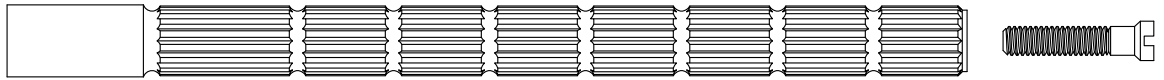

403941/ 403942

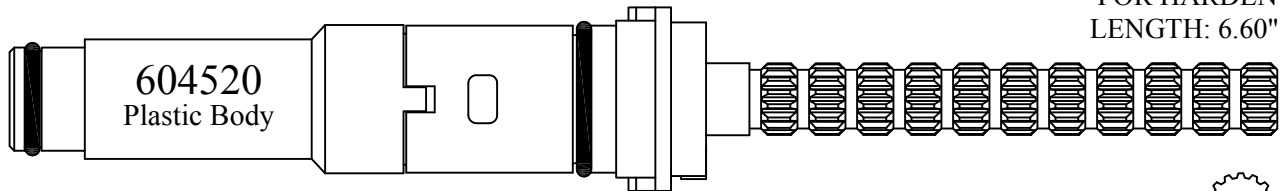

FOR HARDEN  
LENGTH: 6.60"

Available: Stem Only  
203941  
203942

16  
3-16

Nickel Plated Gland

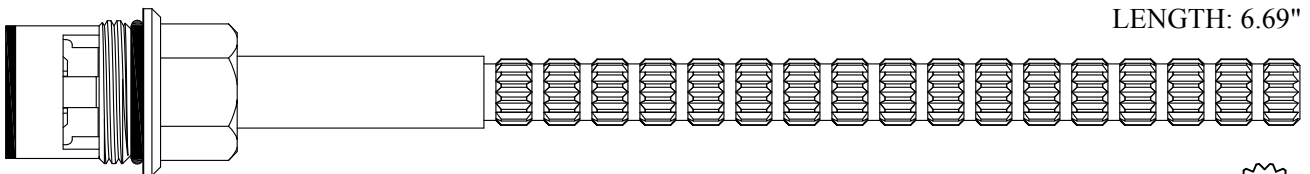

FOR AUBURN BRASS  
LENGTH: 6.69"

427601/ 427602

GASKET: 890160 O-RING INCLUDED  
DISC SET: 151380-PKG

16  
2-3

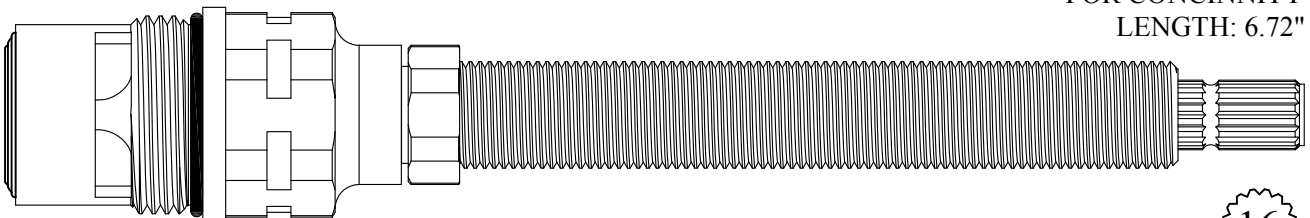

FOR CONCINNITY  
LENGTH: 6.72"

428031/ 428032

GASKET: 890210 O-RING INCLUDED  
SEAL: 898520  
DISC SET: 109850-PKG

Individual items available  
Stem Ext. 5.00": #136050  
Ext. Adap. Screw: #103310

16  
1-6

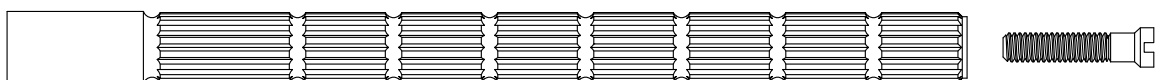

# CERAMIC DISC CARTRIDGES

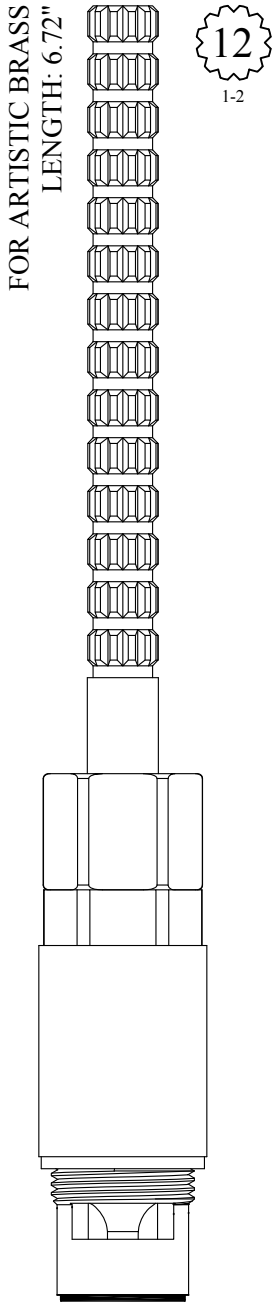

GASKET: 895100 INCLUDED  
SEAL: 898540  
DISC SET: 112530-PKG

427301  
427302

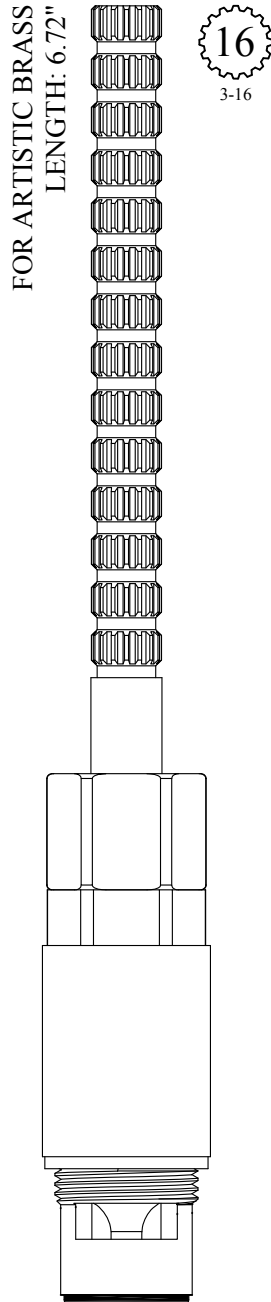

GASKET: 895100 INCLUDED  
SEAL: 898540  
DISC SET: 112530-PKG

427331  
427332

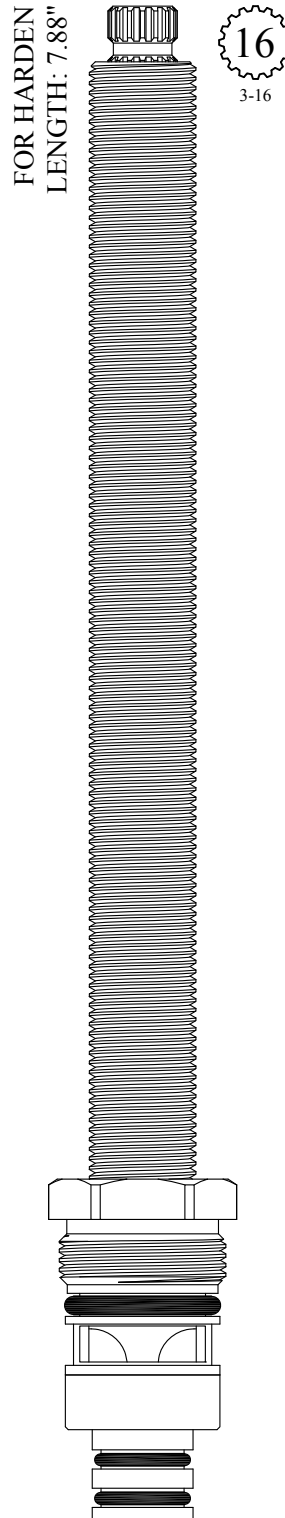

GASKET: 891140 O-RING INCLUDED  
DISC SET: 151380-PKG

428201  
428202

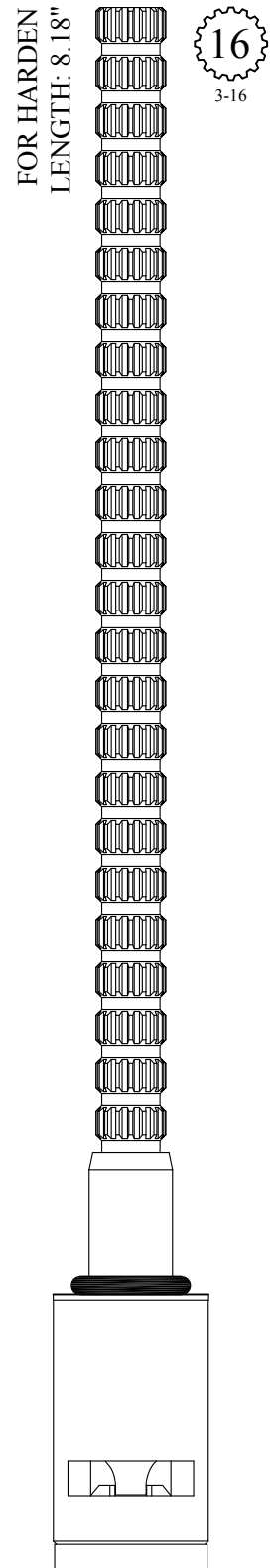

DISC SET: 151380-PKG

428211  
428212



# CERAMIC DISC CARTRIDGES

FOR HARDEN  
LENGTH: 8.32"

16  
3-16

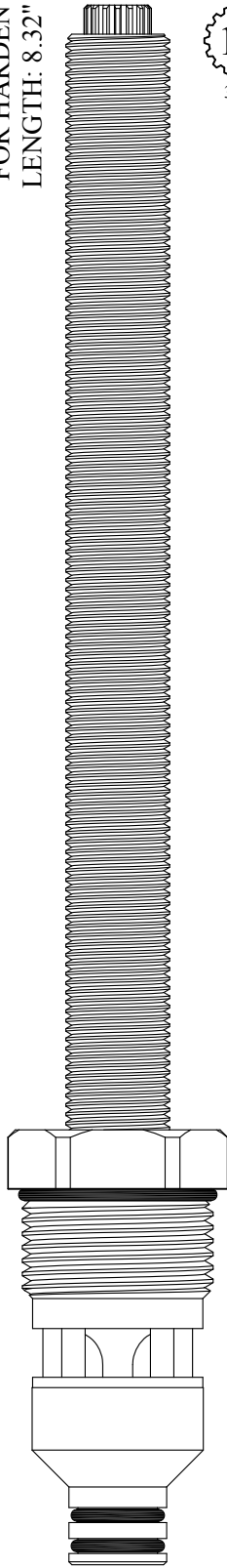

GASKET: 890210 O-RING INCLUDED  
DISC SET: 151380-PKG

428111  
428112

FOR HARDEN  
LENGTH: 9.35"

16  
3-16

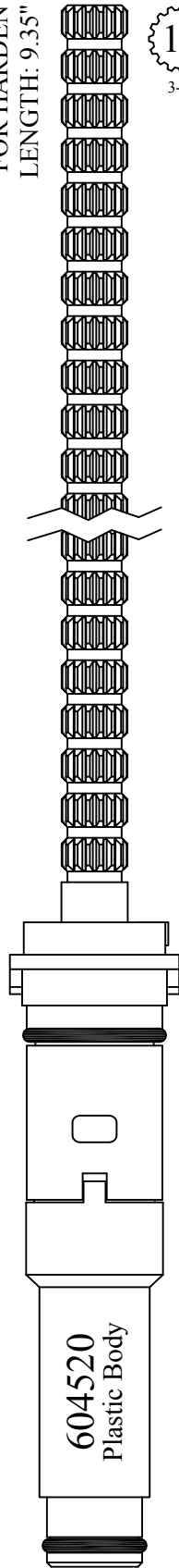

Available: Stem Only

227311 / 227312

427311  
427312

FOR HARDEN  
LENGTH: 9.66"

16  
3-16

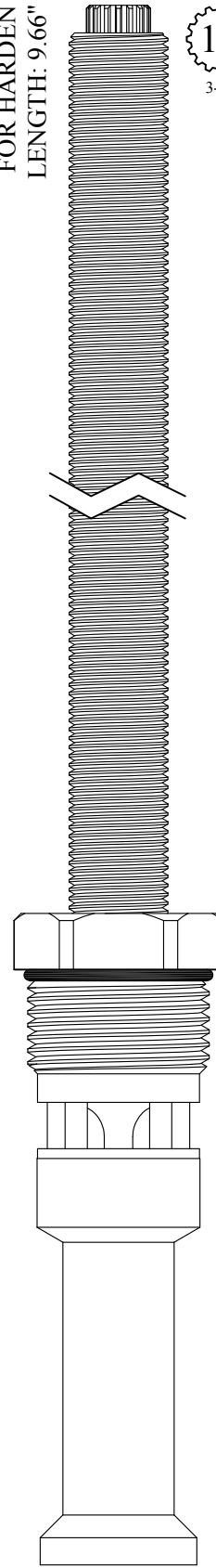

GASKET: 890210 O-RING INCLUDED  
SEAL: 64705-07  
DISC SET: 151380-PKG

428441  
428442

FOR ALTMANS  
LENGTH: 9.66"

16  
3-16

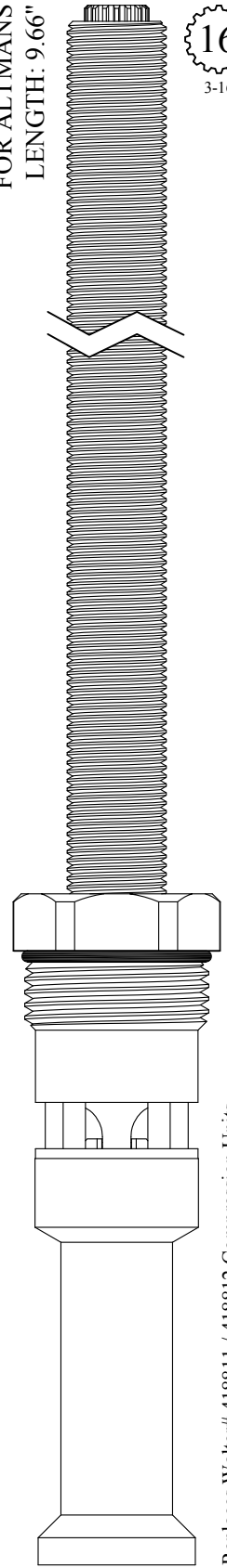

GASKET: 890210 O-RING INCLUDED  
SEAL: 64705-07  
DISC SET: 151380-PKG

428461  
428462

Replaces Walter# 418811 / 418812 Compression Units

# CERAMIC DISC CARTRIDGES

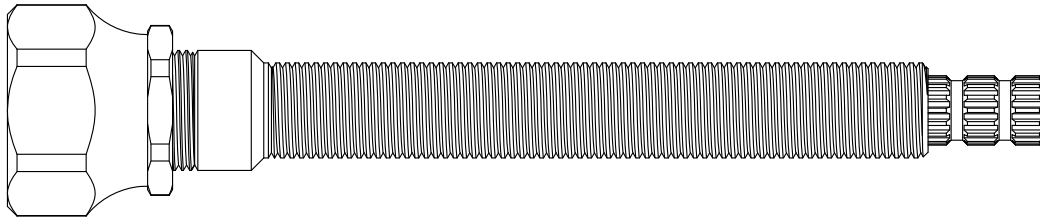

## STEM EXTENSIONS

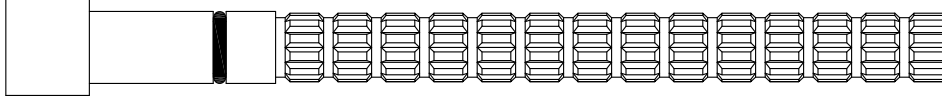

Female 20pt European Broach to:	Part #
Male 16pt Harden, Altmans, Etc.	105090
Male 12pt Price Pfister	105230
Male 20pt Speakman, Broadway	105370
Male 16pt Sayco, Gerber	105510
Male 20pt European	106140

106070  
16pt Harden Stem Ext. with  
1/4-20 Male Thread

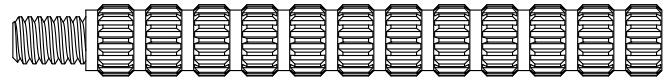

\* For more Stem Extensions see the Stem Extension Section

## NIPPLE EXTENSIONS

5/8-24 x 1/2-24	105720
5/8-24 x 9/16-20	105790
5/8-24 x 5/8-18	105860
5/8-24 x 11/16-24	105930
5/8-24 x 5/8-24	106280

106000  
9/16-20 Nipple Extension

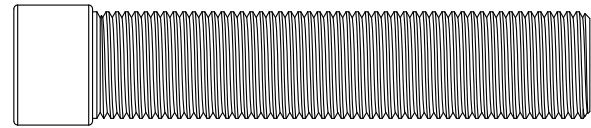

611270  
9/16-20 x 9/16-20  
Nipple Extension Adapter

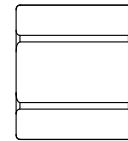
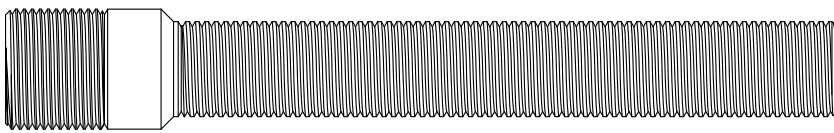

105650  
Tapped 5/8-24  
Locknut for Nipple Adapter

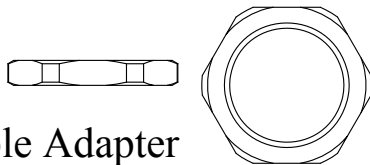

106210  
10-24 Female x 1/4-20 Male  
Handle Screw Adapter



5/8-24

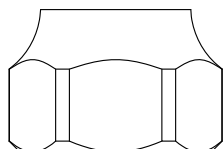

105580  
Nipple Adapter

M24 X 1.00

BARRY E.  WALTER  SR. CO.

# NON-RISING UNITS

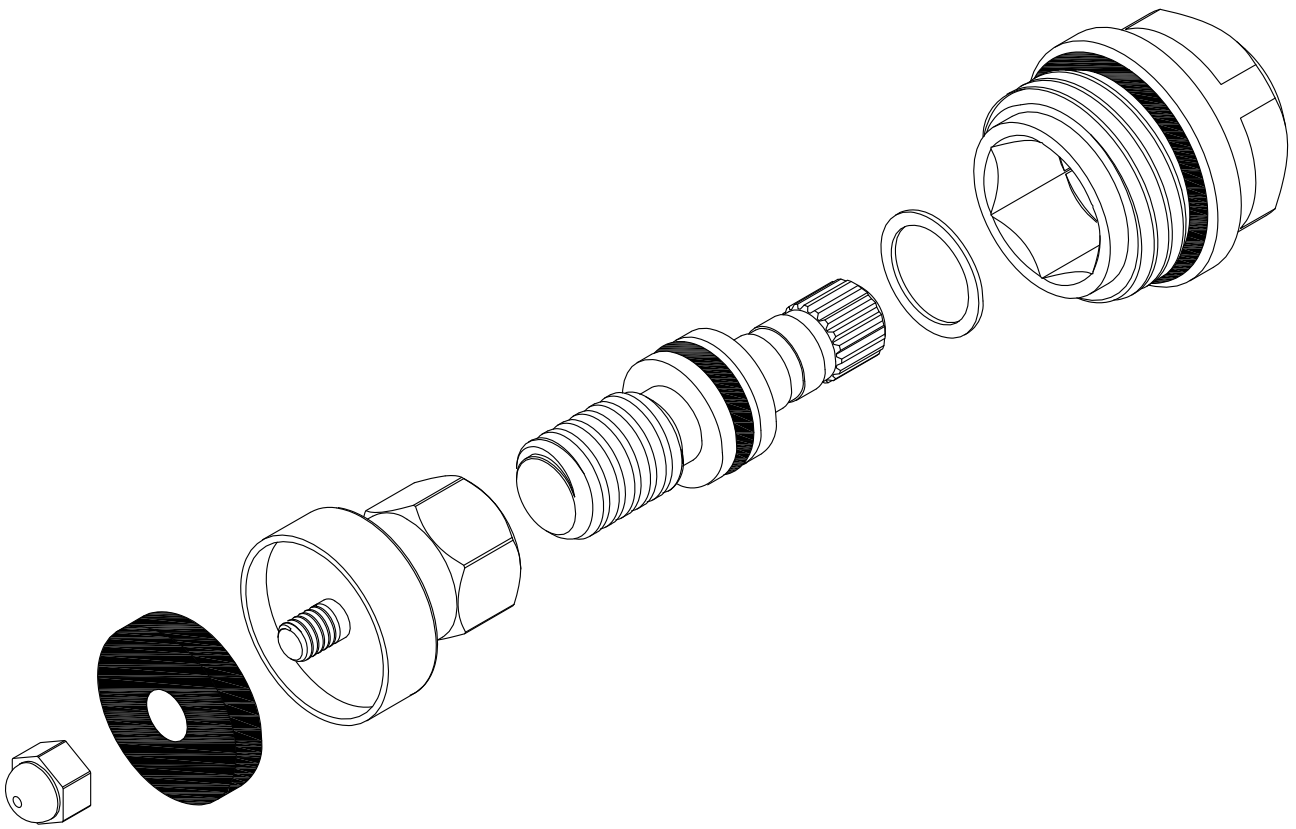

# NON-RISING UNITS

FOR INDIANA  
LENGTH: 1.36"

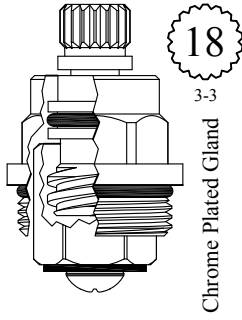

GASKET: 890170 O-RING INCLUDED

LF450501  
LF450502

UNKNOWN  
LENGTH: 1.67"

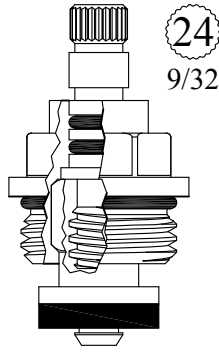

GASKET: 890170 O-RING INCLUDED

LF455942

UNKNOWN  
LENGTH: 1.75"

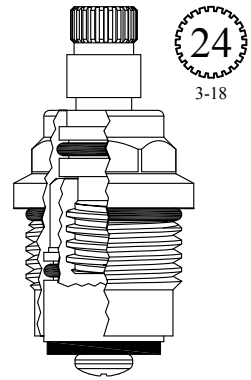

GASKET: 890170 O-RING INCLUDED

LF455422

UNKNOWN  
LENGTH: 1.79"

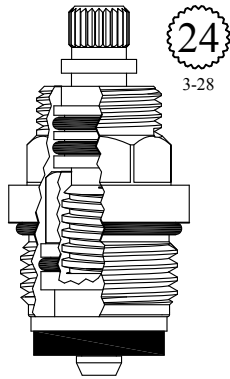

GASKET: 890170 O-RING INCLUDED

LF456422

FOR MOEN  
LENGTH: 1.79"

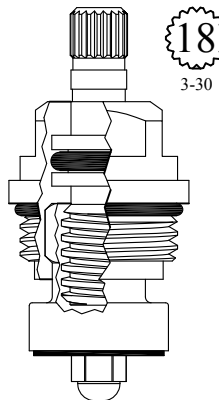

GASKET: 890180 O-RING INCLUDED

LF455362

FOR ELJER  
LENGTH: 1.79"

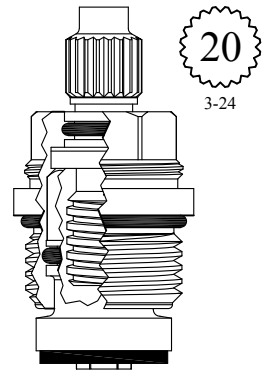

GASKET: 890170 O-RING INCLUDED

LF455962

FOR KINGSBURY  
LENGTH: 1.82"

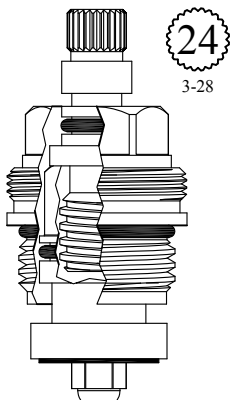

GASKET: 890170 O-RING INCLUDED

LF455972

FOR PIAZZA  
LENGTH: 1.85"

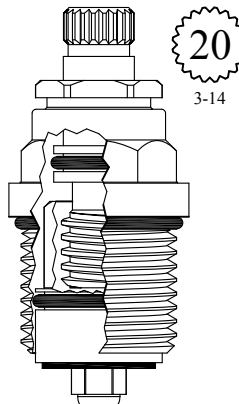

GASKET: 890180 O-RING INCLUDED

LF460802

UNKNOWN  
LENGTH: 1.87"

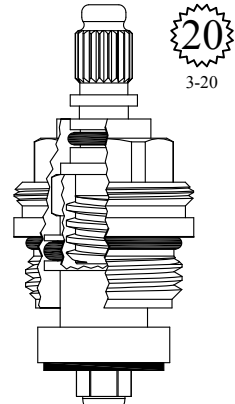

GASKET: 890170 O-RING INCLUDED

LF456462

# NON-RISING UNITS

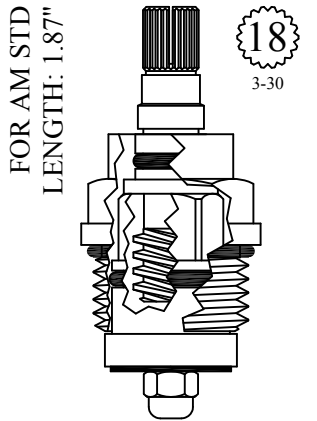

GASKET: 890180 O-RING INCLUDED

**LF456302**

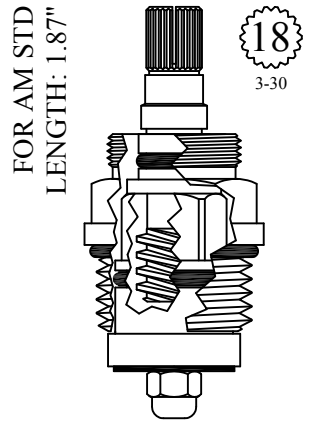

GASKET: 890180 O-RING INCLUDED

**LF456312**

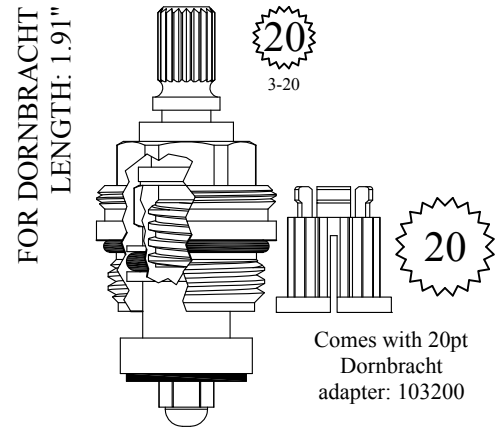

GASKET: 890170 O-RING INCLUDED

**LF456362**

Comes with 20pt  
Dornbracht  
adapter: 103200

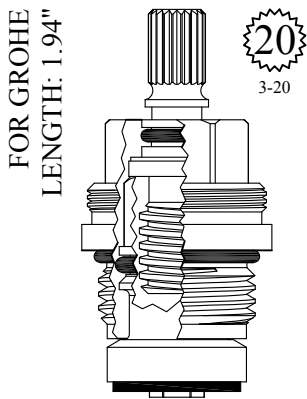

GASKET: 890170 O-RING INCLUDED

**LF457282**

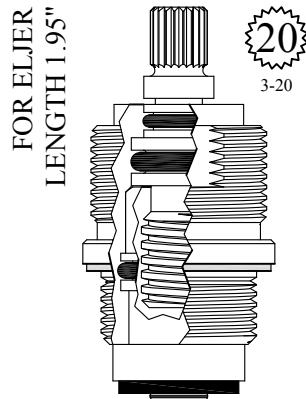

GASKET: 895160 INCLUDED

**LF457242**

Comes with handle screw: # 899230

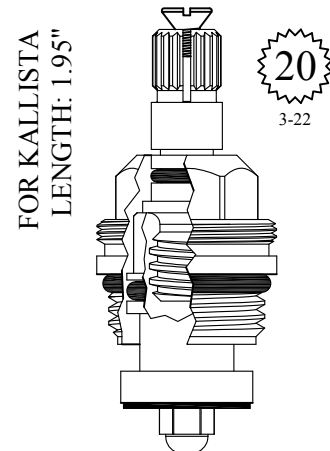

GASKET: 891150 O-RING INCLUDED

**LF458502**

Comes with handle screw: # 899230

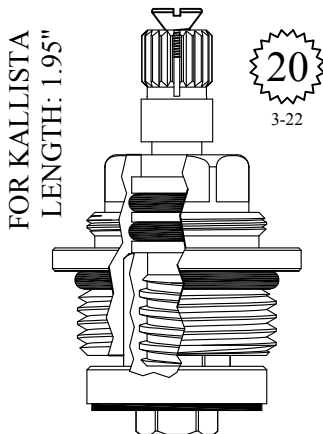

GASKET: 891180 O-RING INCLUDED

**401072**

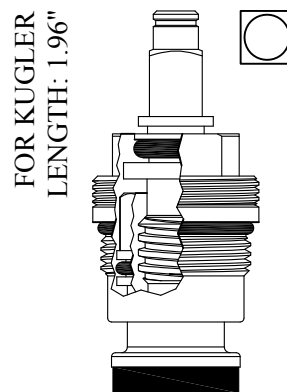

GASKET: 890170 O-RING INCLUDED

**LF457262**

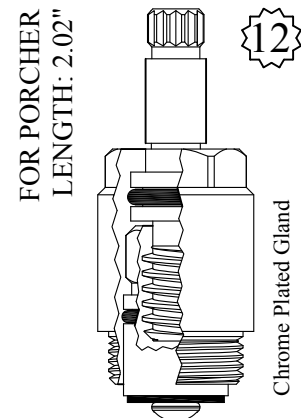

Chrome Plated Gland

**LF458602**

# NON-RISING UNITS

UNKNOWN  
LENGTH: 2.11"

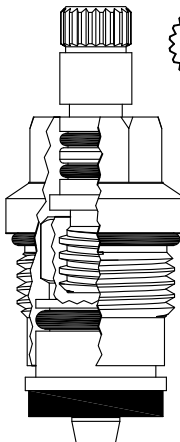

20  
3-14

GASKET: 890180 O-RING INCLUDED

**LF459482**

FOR ARMONIA  
LENGTH: 2.11"

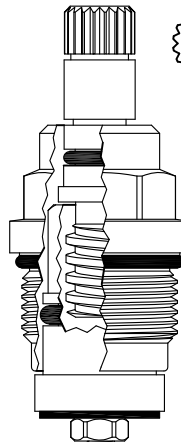

20  
3-14

19TPI Fine Cap Thread

GASKET: 890180 O-RING INCLUDED

**LF460172**

FOR ARMONIA  
LENGTH: 2.11"

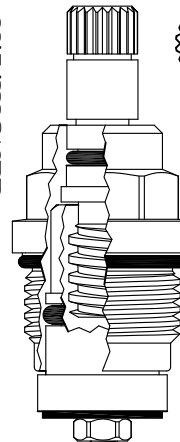

20  
3-14

14 TPI Coarse Cap Thread

GASKET: 890180 O-RING INCLUDED

**LF460182**

FOR KALLISTA  
LENGTH: 2.12"

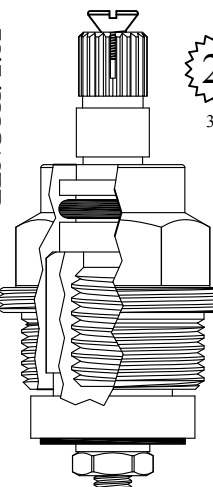

20  
3-22

Comes with handle screw: #899230

GASKET: 895350

**LF463602**

FOR KALLISTA  
LENGTH: 2.14"

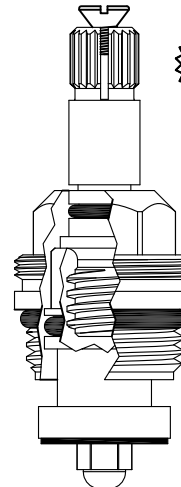

20  
3-22

Comes with handle screw:  
# 899230

GASKET: 891150 O-RING INCLUDED

**LF459801**  
**LF459802**

FOR DORNBRACHT  
LENGTH: 2.16"

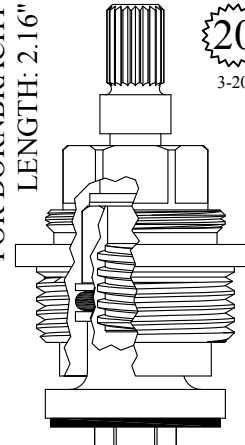

20  
3-20

20

Comes with 20pt  
Dornbracht  
adapter: 103200

GASKET: 895560

**401082**

FOR PRINCIPE  
LENGTH: 2.16"

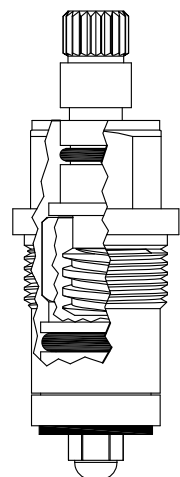

20  
11/32  
3-34

GASKET: 895100

**LF459812**

FOR FANTINI  
LENGTH: 2.17"

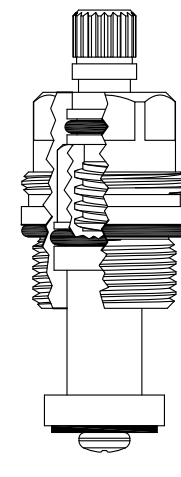

20  
11/32  
3-34

GASKET: 890170 O-RING INCLUDED

**LF463332**

FOR DORNBRACHT  
LENGTH: 2.20"

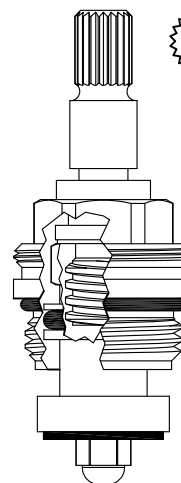

20  
3-20

20

Comes with 20pt  
Dornbracht  
adapter: 103200

GASKET: 890170 O-RING INCLUDED

**LF459512**

# NON-RISING UNITS

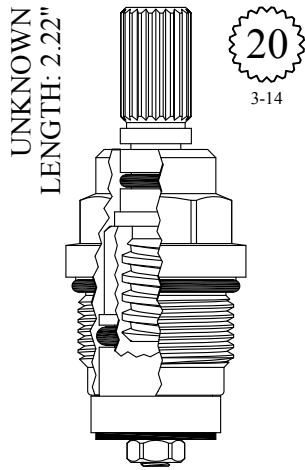

GASKET: 890180 O-RING INCLUDED

LF460272

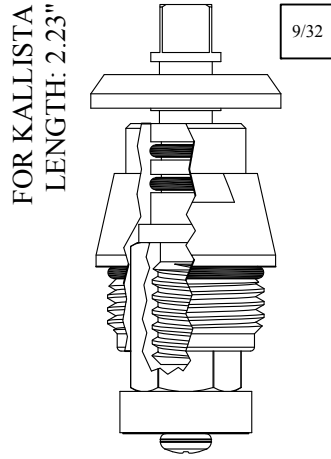

GASKET: 890170 O-RING INCLUDED

LF460652

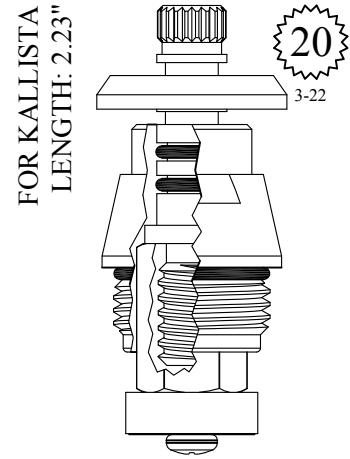

GASKET: 890170 O-RING INCLUDED

LF460672

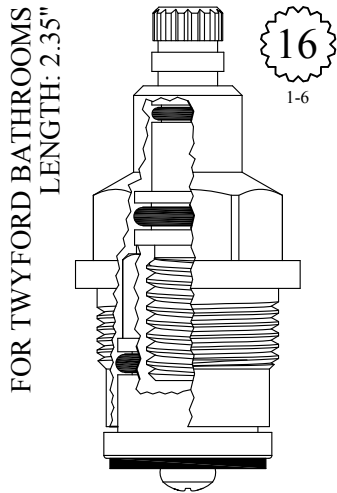

GASKET: 895370

401372

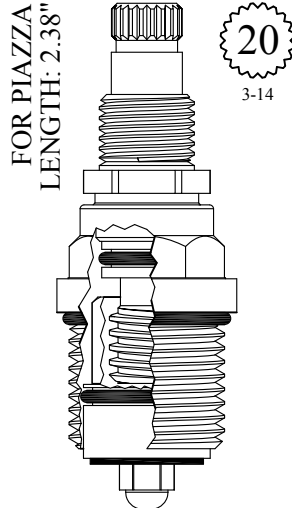

GASKET: 890180 O-RING INCLUDED

LF463702

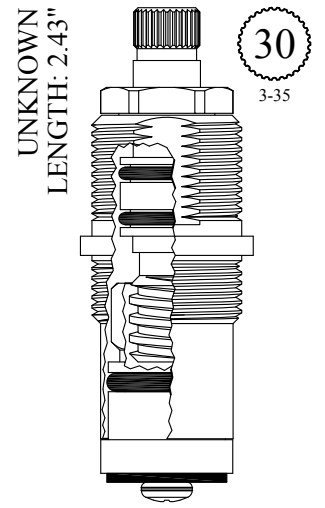

GASKET: 895140

LF463302

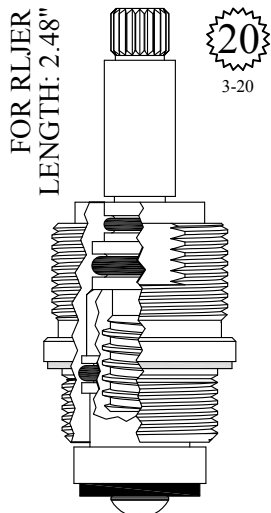

GASKET: 895160 INCLUDED

401342

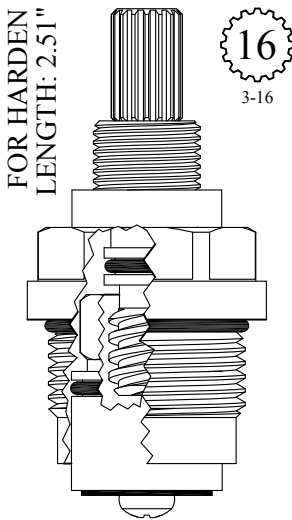

GASKET: 890210 O-RING INCLUDED

LF463901  
LF463902

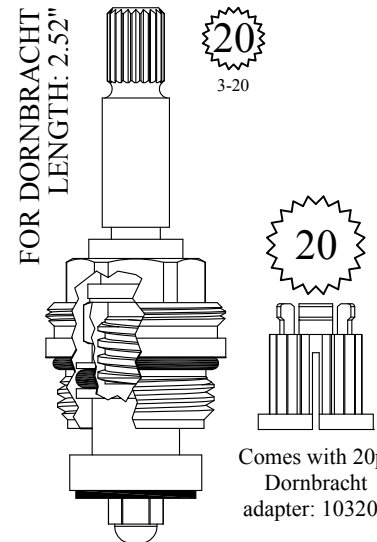

GASKET: 890170 O-RING INCLUDED

LF463872

Comes with 20pt  
Dornbracht  
adapter: 103200



# NON-RISING UNITS

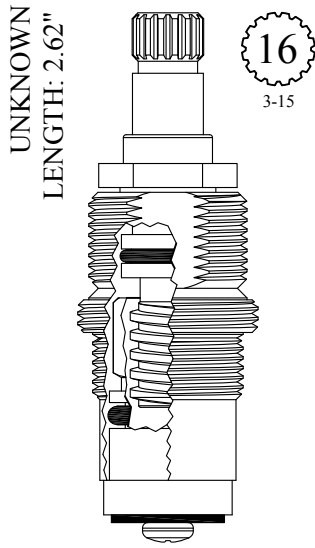

GASKET: 895140

LF464602

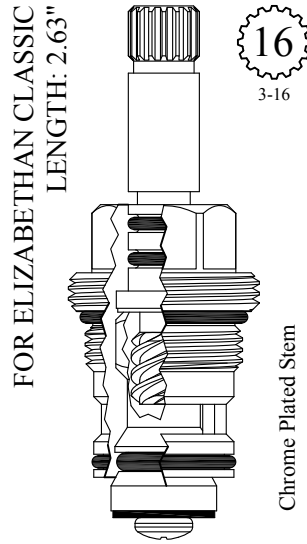

GASKET: 890180 O-RING INCLUDED

430881

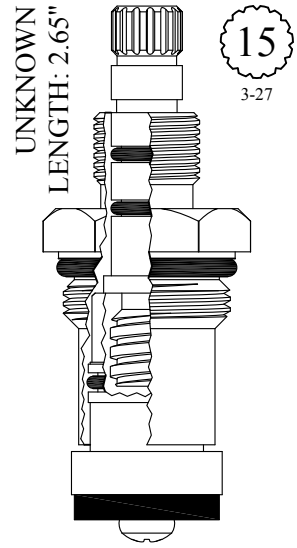

GASKET: 891160 INCLUDED

LF464391  
LF464392

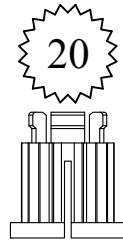

Comes with 20pt Dornbracht  
adapter: 103200

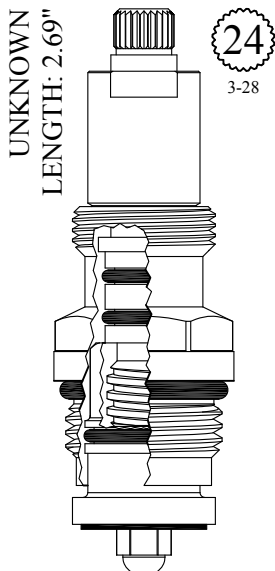

GASKET: 891150 INCLUDED

LF464712

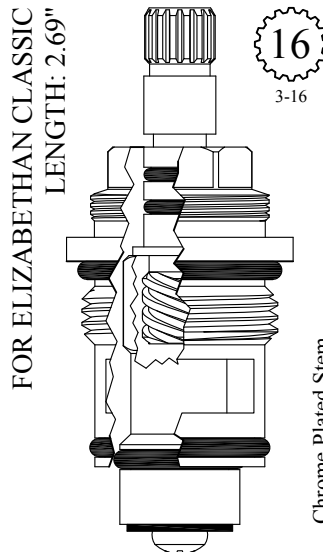

GASKET: 890180 O-RING INCLUDED

431052

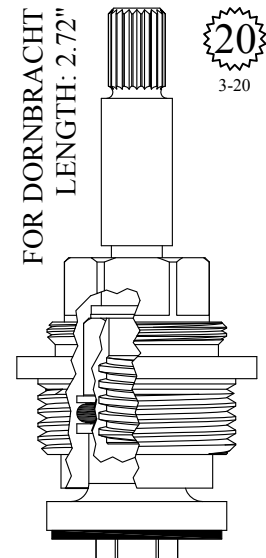

GASKET: 895560

401762

# NON-RISING UNITS

UNKNOWN  
LENGTH: 2.76"

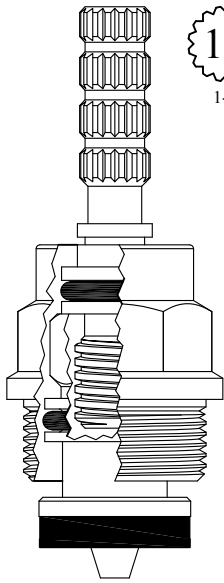

16  
1-6

GASKET: 895330

LF465702

UNKNOWN  
LENGTH: 2.83"

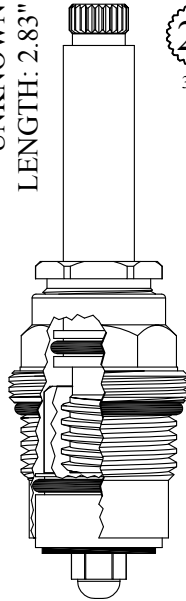

24  
3-28

GASKET: 890180 INCLUDED

LF464962

UNKNOWN  
LENGTH: 2.91"

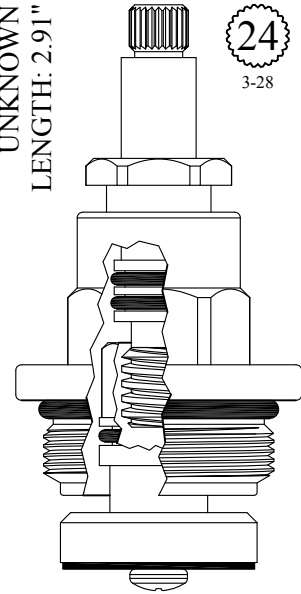

24  
3-28

Chrome Plated Unit

GASKET: 891210 O-RING INCLUDED

401922

UNKNOWN  
LENGTH: 2.94"

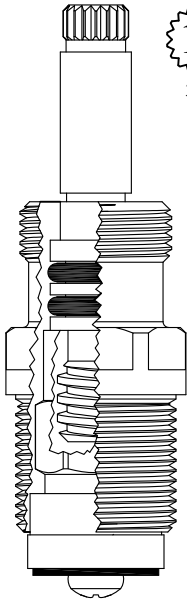

18  
3-25

GASKET: 895180

401722

FOR ARMONIA  
LENGTH: 3.05"

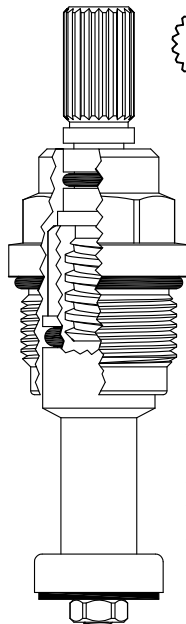

20  
3-14

19 TPI Gland Fine Thread

GASKET: 890180 O-RING INCLUDED

401822

UNKNOWN  
LENGTH: 3.08"

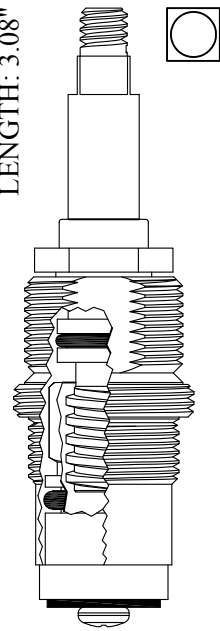

GASKET: 895160

LF466532

# NON-RISING UNITS

Comes with handle screw:  
# 899240

FOR ELJER  
LENGTH: 3.12"

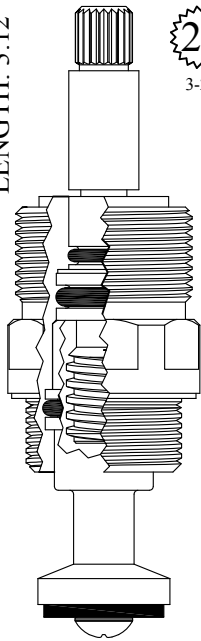

20  
3-20

GASKET: 895160 INCLUDED

402012

FOR AM STD  
LENGTH: 3.14"

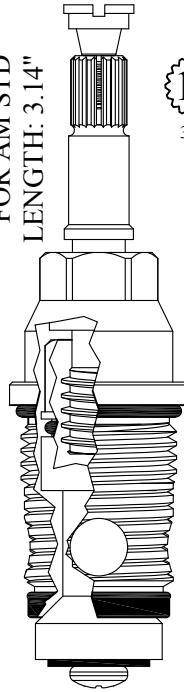

18  
3-30

GASKET: 890170 O-RING INCLUDED

430022

FOR JAMECO  
LENGTH: 3.20"

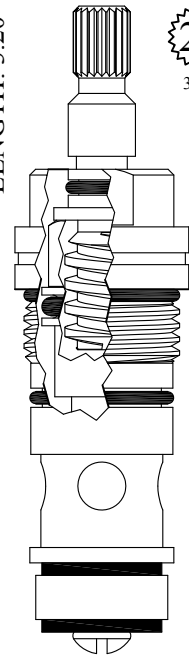

20  
3-20

GASKET: 890170 O-RING INCLUDED

430392

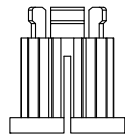

20

Comes with 20pt Dornbracht  
adapter: 103200

FOR LABONGE  
LENGTH: 3.22"

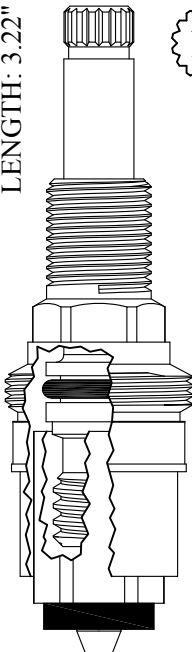

16  
1-6

LF466712

FOR DORNBRACHT  
LENGTH: 3.24"

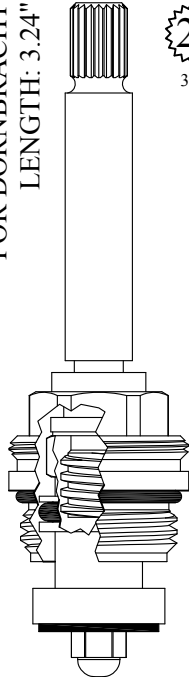

20  
3-20

GASKET: 890170 O-RING INCLUDED

402242

UNKNOWN  
LENGTH: 3.25"

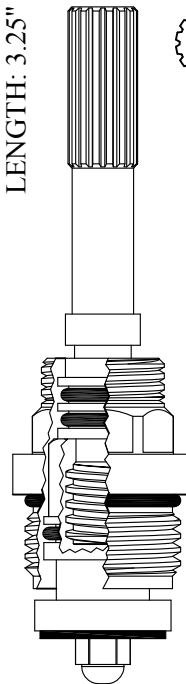

16  
3-15

GASKET: 890170 O-RING INCLUDED

402472

FOR PIAZZA  
LENGTH: 3.26"

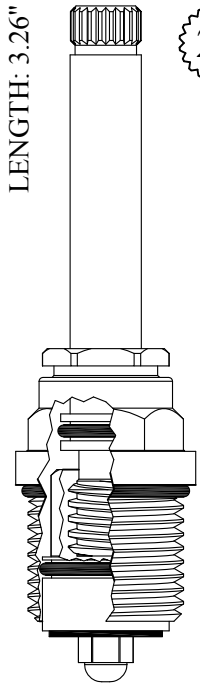

20  
3-14

GASKET: 890180 O-RING INCLUDED

402252

# NON-RISING UNITS

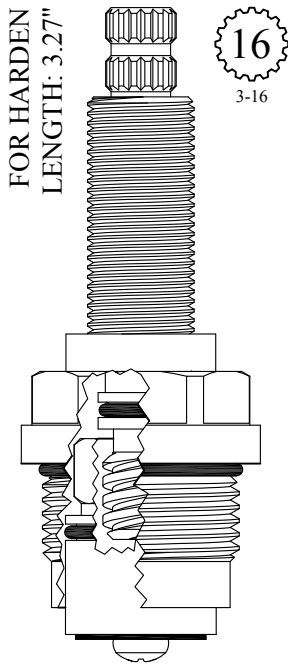

GASKET: 890210 O-RING INCLUDED

402421  
402422

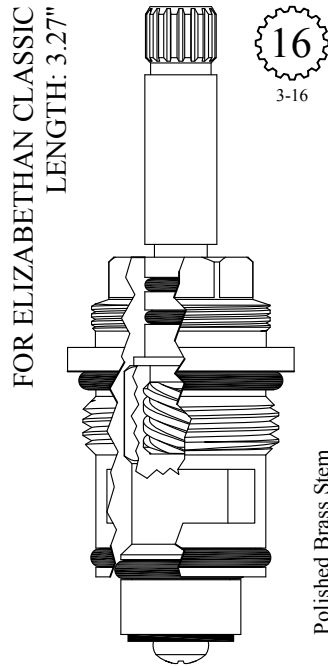

GASKET: 890180 O-RING INCLUDED

431552

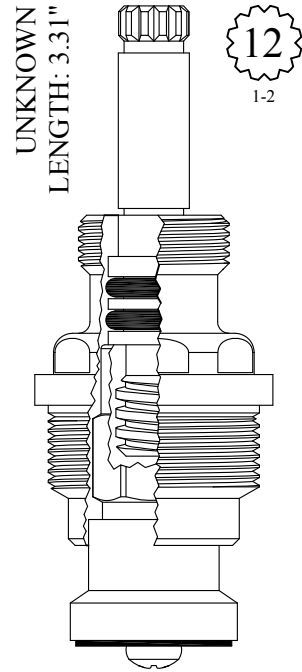

GASKET: 895450

402522

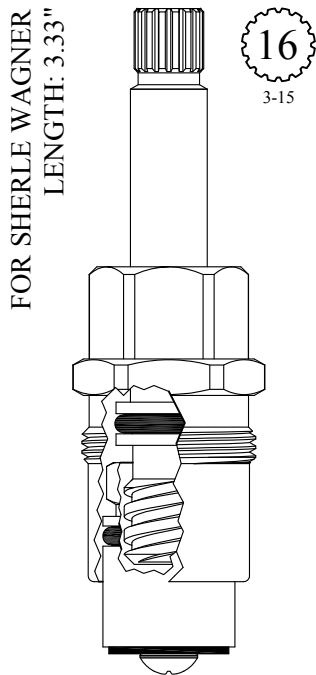

GASKET: 895100

LF467501  
LF467502

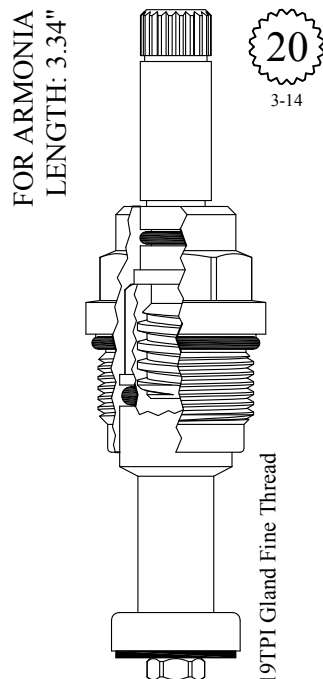

GASKET: 890180 O-RING INCLUDED

402532

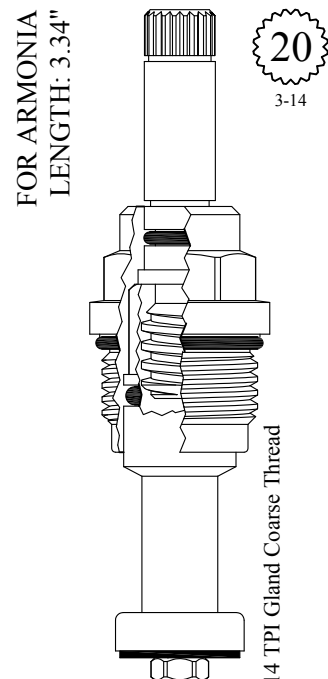

GASKET: 890180 O-RING INCLUDED

402542

# NON-RISING UNITS

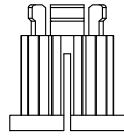

20

Comes with 20pt Dornbracht adapter: 103200

UNKNOWN  
LENGTH: 3.35"

24  
3-28

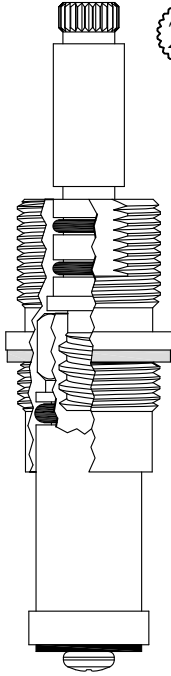

GASKET: 895100 INCLUDED

LF466822

FOR DORNBRACHT  
LENGTH: 3.35"

20  
3-20

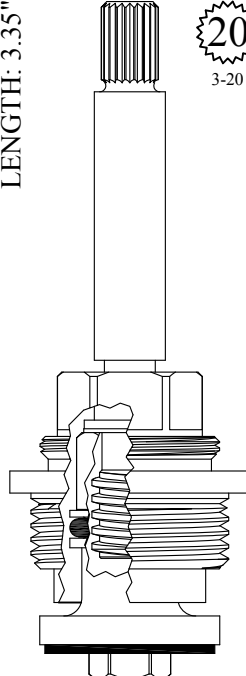

GASKET: 895560

402752

FOR GROHE  
LENGTH 3.38"

20  
3-20

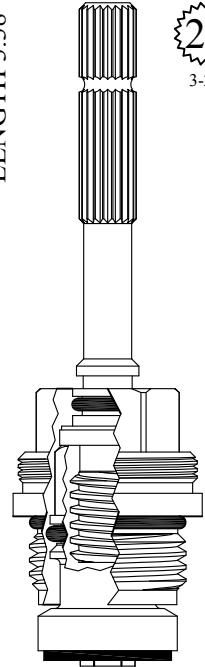

GASKET: 890170 O-RING INCLUDED

402642

FOR AM STD  
LENGTH: 3.39"

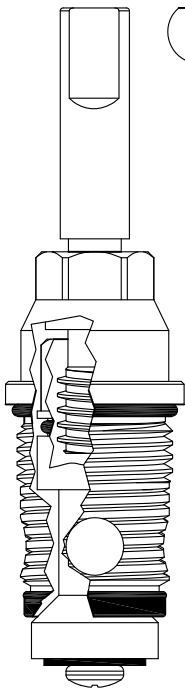

430662

FOR KALLISTA  
LENGTH: 3.44"

9/32

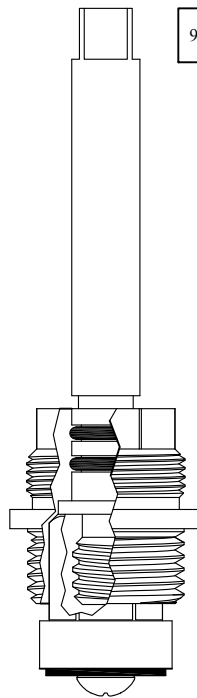

GASKET: 895160

402762

FOR AUBURN BRASS  
LENGTH: 3.51"

16  
2-3

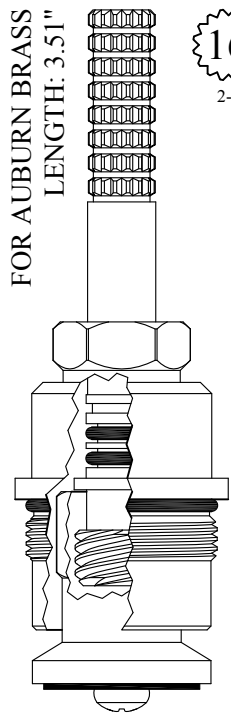

GASKET: 890200 O-RING INCLUDED

403021  
403022

# NON-RISING UNITS

Comes with handle screw:  
# 899230

UNKNOWN  
LENGTH: 3.56"

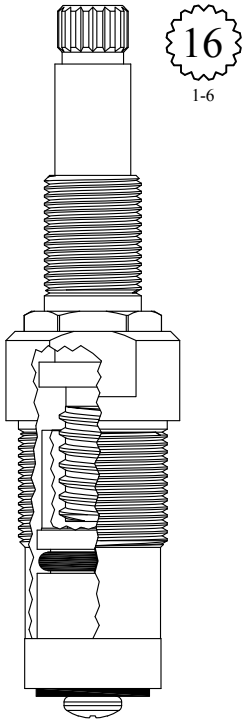

GASKET: 895140  
**402782**

FOR KALLISTA  
LENGTH: 3.57"

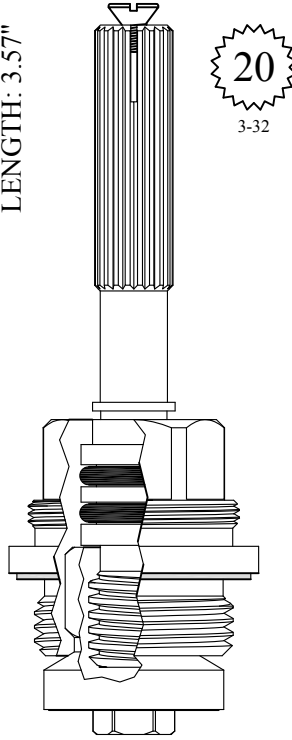

GASKET: 895440 INCLUDED  
**402792**

FOR GROHE  
LENGTH: 3.57"

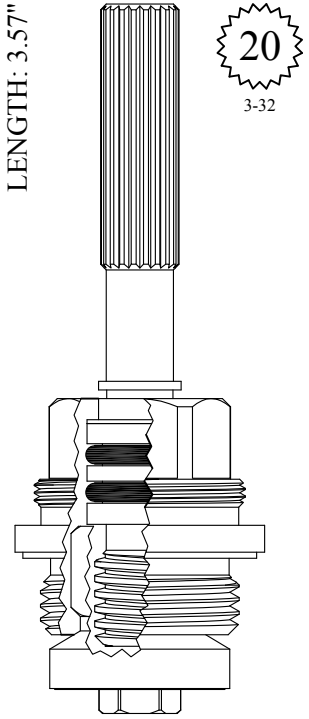

GASKET: 895440 INCLUDED  
**402892**

FOR AM STD  
LENGTH: 3.60"

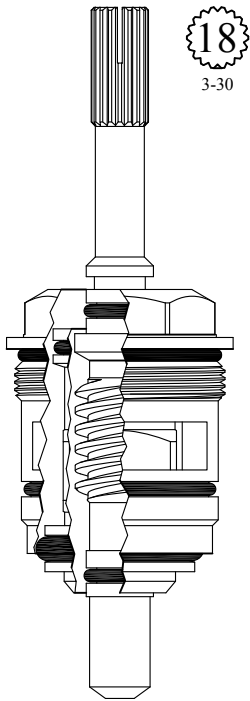

GASKET: 890210 O-RING INCLUDED  
**431681**

FOR ELJER  
LENGTH: 3.65"

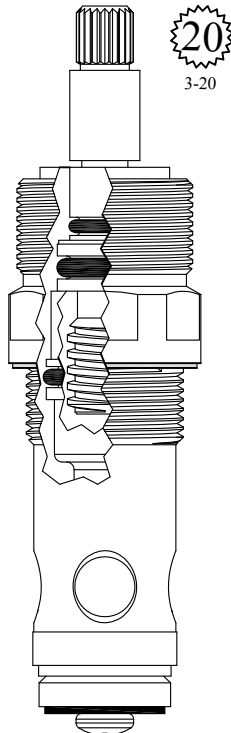

GASKET: 895160 INCLUDED  
**430192**

UNKNOWN  
LENGTH: 3.66"

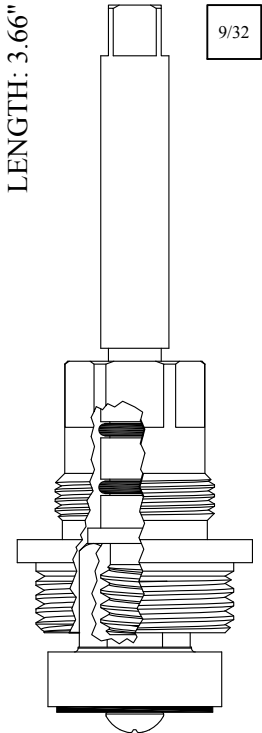

GASKET: 895560  
**403062**

# NON-RISING UNITS

FOR CIFIAL  
LENGTH: 3.74"

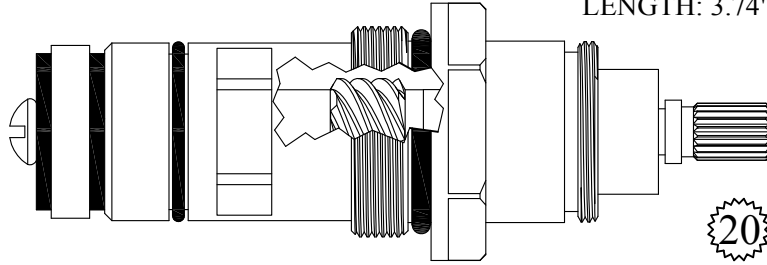

430871

GASKET: 891180 O-RING INCLUDED

20  
3-20

UNKNOWN  
LENGTH: 3.81"

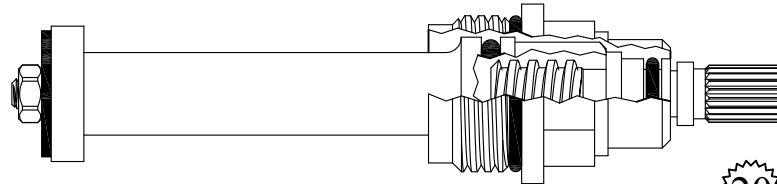

426812

GASKET: 890170 O-RING INCLUDED

20  
3-20

FOR ELJER  
LENGTH: 3.82"

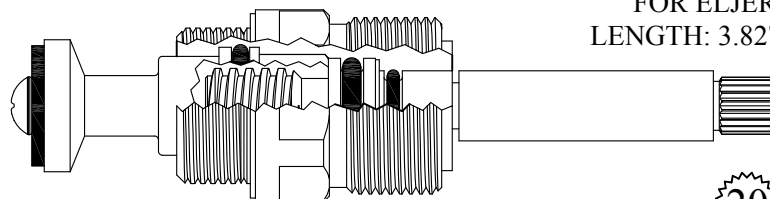

403232

GASKET: 895160 INCLUDED

20  
3-20

FOR KALLISTA  
LENGTH: 3.94"

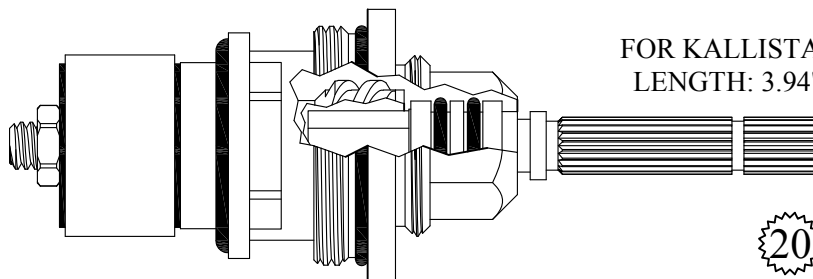

430982

GASKET: 890210 O-RING INCLUDED

20  
3-20

# NON-RISING UNITS

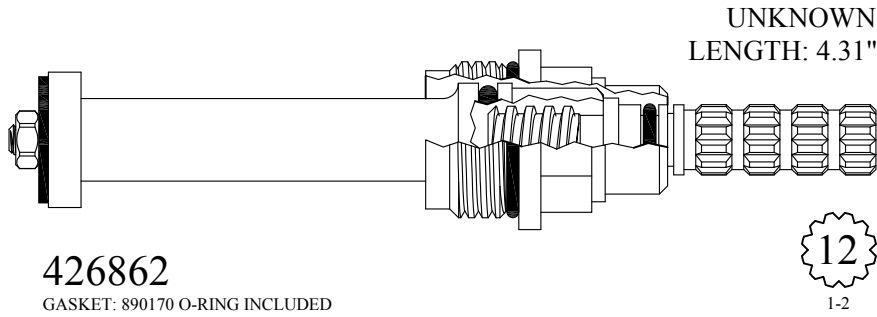

**426862**  
GASKET: 890170 O-RING INCLUDED

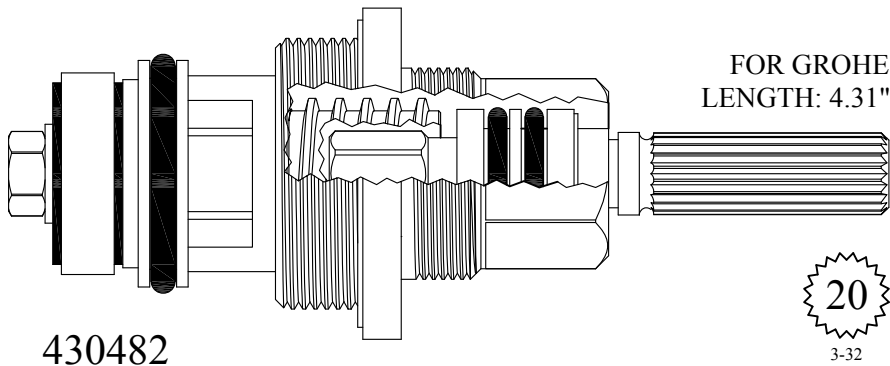

**430482**  
GASKET: 895520 INCLUDED

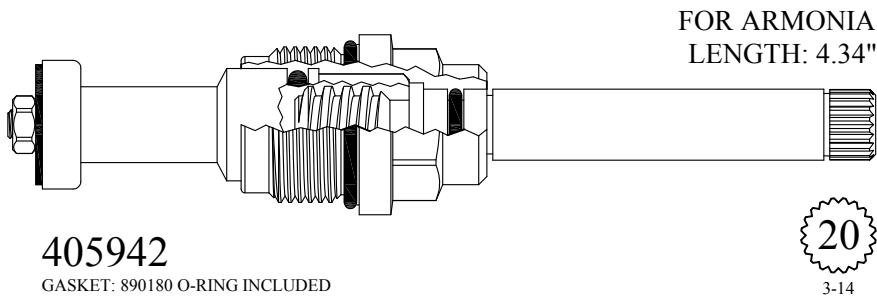
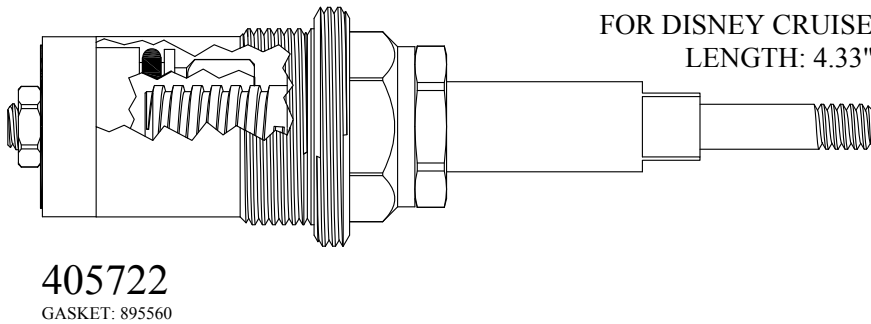

**405942**  
GASKET: 890180 O-RING INCLUDED



# NON-RISING UNITS

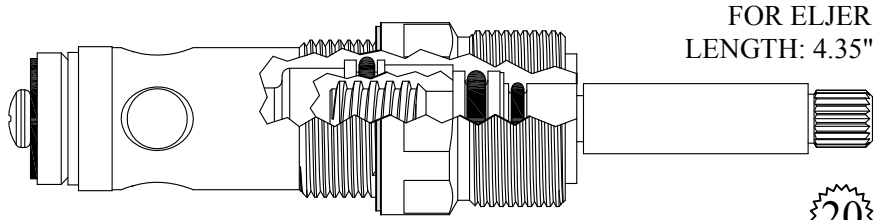

FOR ELJER  
LENGTH: 4.35"

20  
3-20

430552

GASKET INCLUDED: 895160

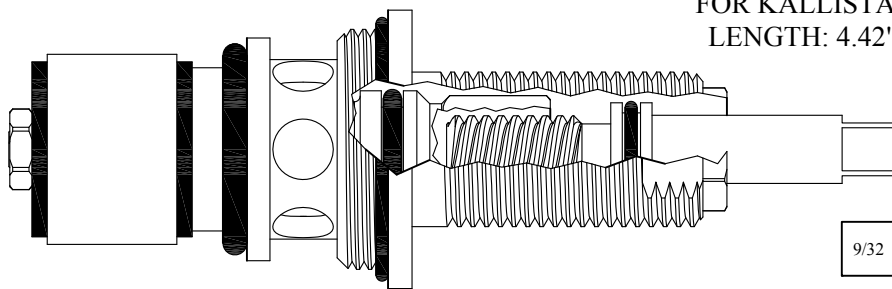

FOR KALLISTA  
LENGTH: 4.42"

9/32

430642

GASKET: 890240 O-RING INCLUDED

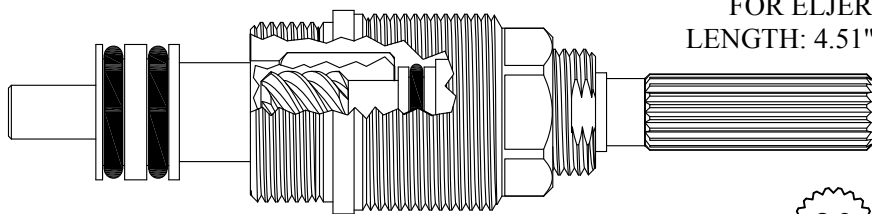

FOR ELJER  
LENGTH: 4.51"

20  
3-24

432071

GASKET: 895300

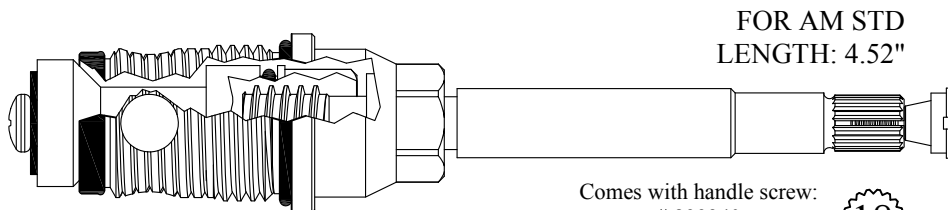

FOR AM STD  
LENGTH: 4.52"

Comes with handle screw:  
# 899240

18  
3-30

430692

GASKET: 890170

# NON-RISING UNITS

FOR KALLISTA  
LENGTH: 4.55"

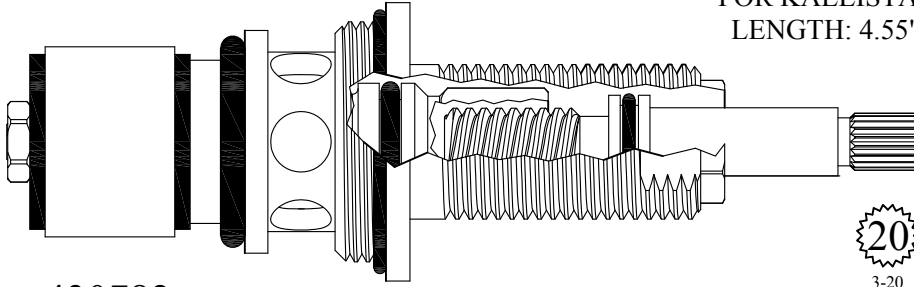

**430782**

GASKET: 890240 O-RING INCLUDED

20  
3-20

Chrome Plated Stem

FOR ARMONIA  
LENGTH: 4.60"

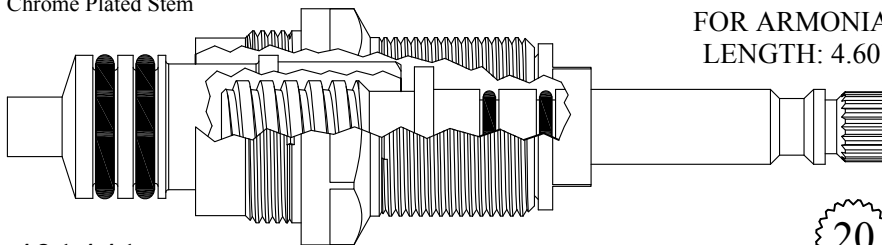

**431441**

GASKET: 895570 INCLUDED

20  
3-14

FOR ELJER  
LENGTH 4.65"

Plastic Plunger End

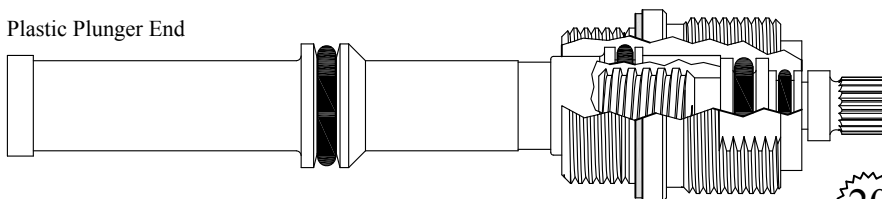

**432822**

GASKET: 895160 INCLUDED

20  
3-20

FOR KALLISTA  
LENGTH: 4.84"

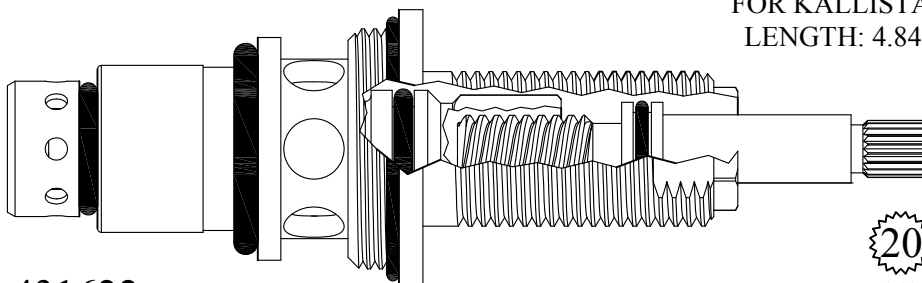

**431622**

GASKET: 890240 O-RING INCLUDED

20  
3-20

# NON-RISING UNITS

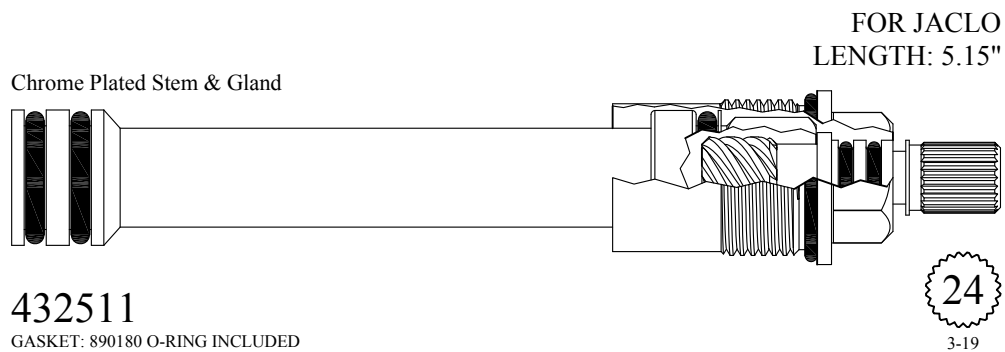
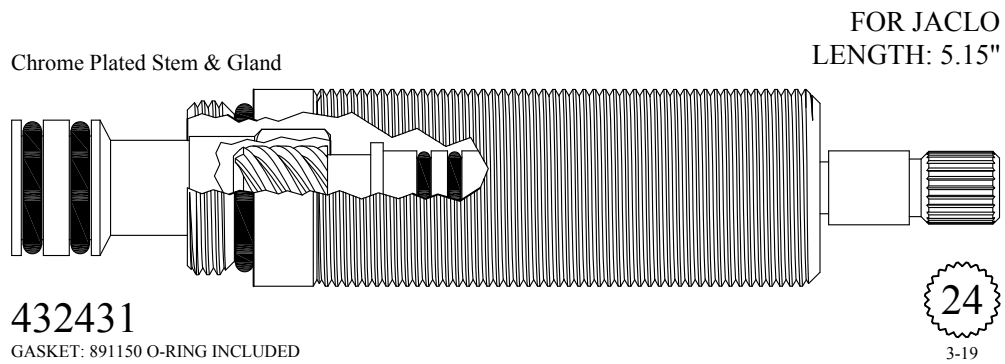
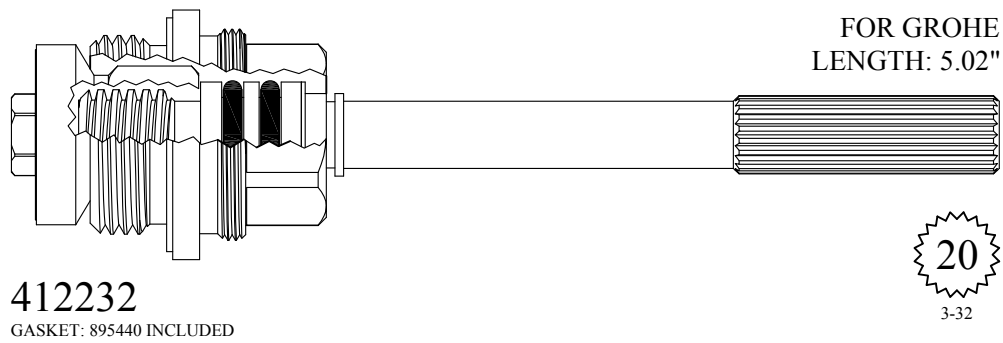
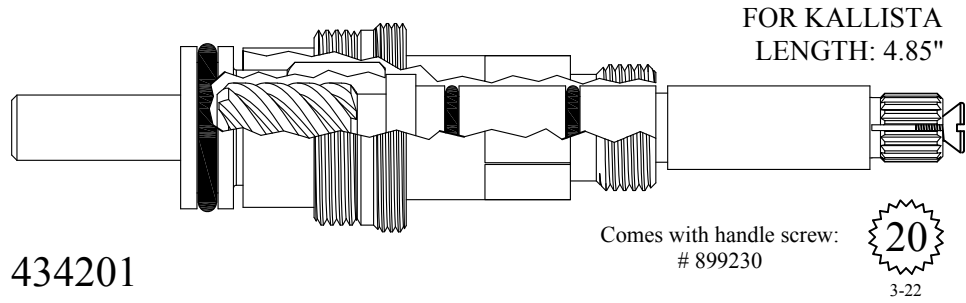

# NON-RISING UNITS

Plastic Plunger End

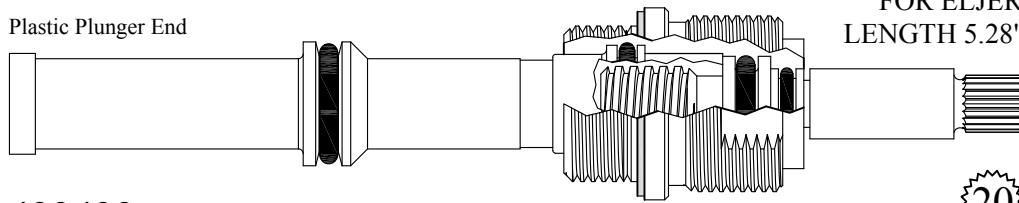

FOR ELJER  
LENGTH 5.28"

433432

GASKET: 895160 INCLUDED

20  
3-20

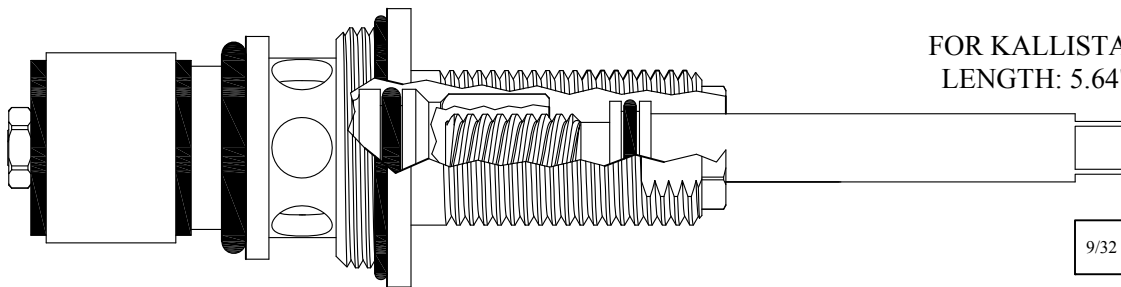

FOR KALLISTA  
LENGTH: 5.64"

437112

GASKET: 890240 O-RING INCLUDED

9/32

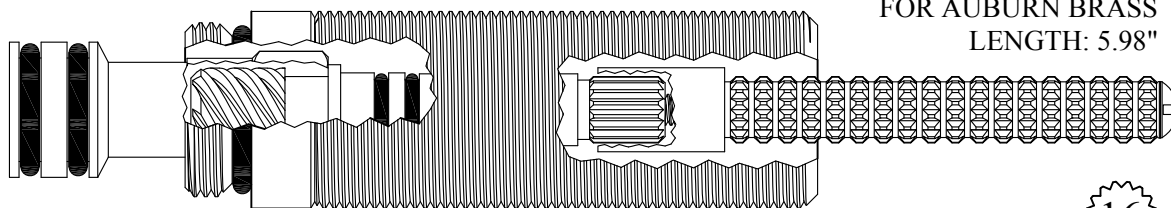

FOR AUBURN BRASS  
LENGTH: 5.98"

437611

GASKET: 891150 O-RING INCLUDED

16  
2-3

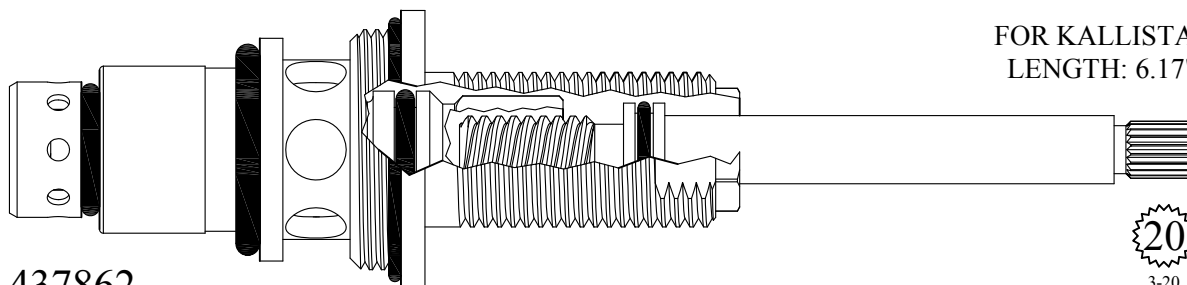

FOR KALLISTA  
LENGTH: 6.17"

437862

GASKET: 890240 O-RNG INCLUDED

20  
3-20

# NON-RISING UNITS

FOR JACLO  
LENGTH: 7.15"

24  
3-19

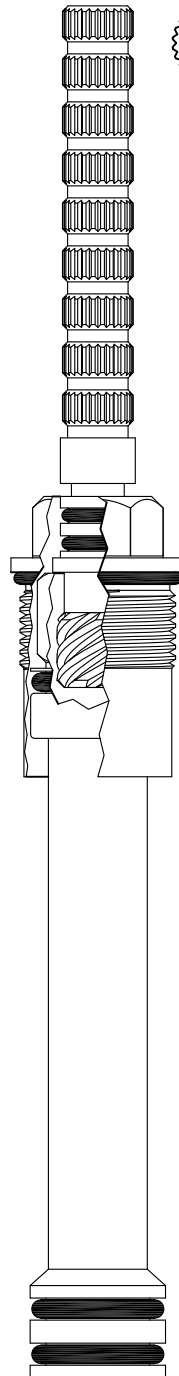

GASKET: 890180 O-RING INCLUDED

439421

*Send Your Orders To:*

BARRY E.  SR. CO.

*E-mail: [orderdesk@barrywalter.com](mailto:orderdesk@barrywalter.com)*

*Fax: 1.800.886.9831*

*Phone: 1.800.767.5552*

BARRY E.  WALTER SR. CO.

# STOP STEMS

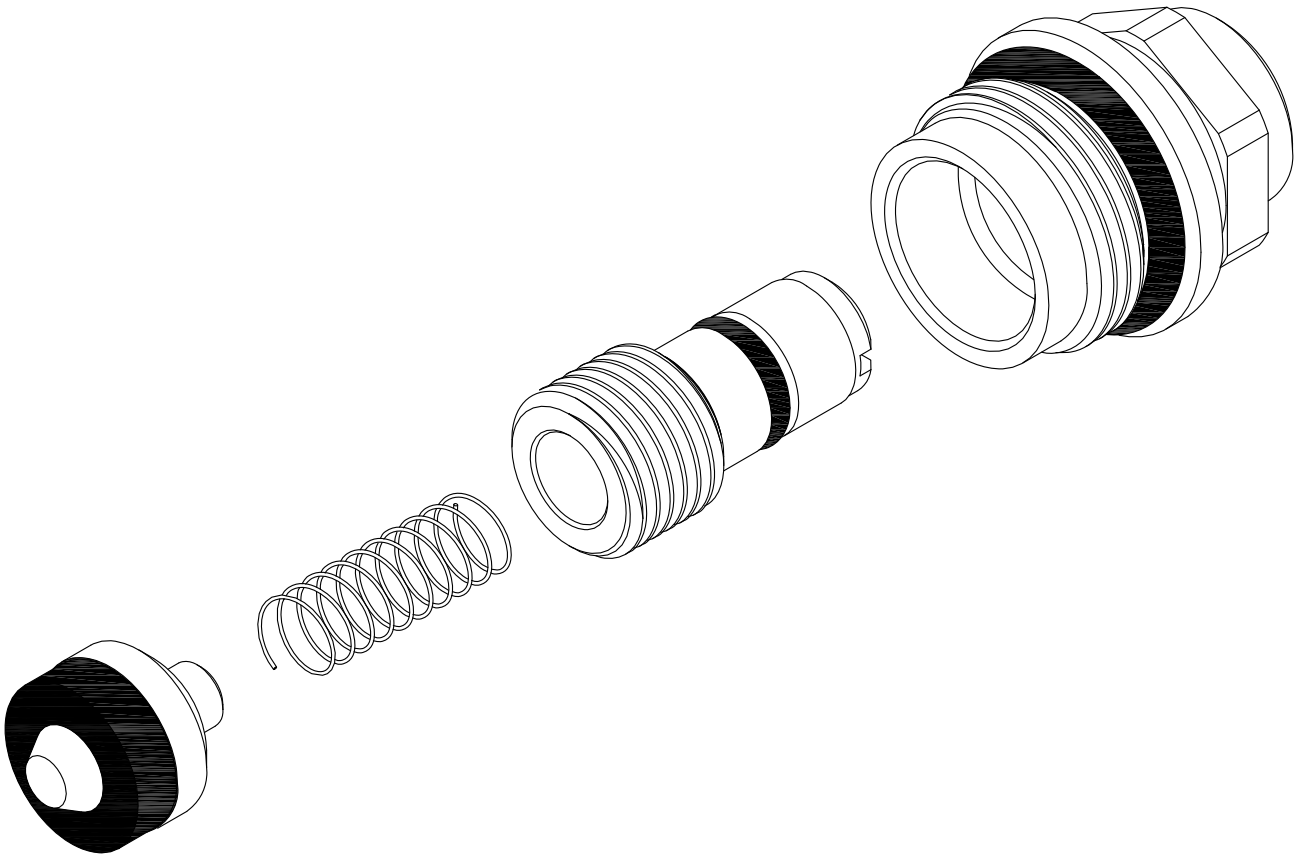



# CHECK STOP STEM UNITS

FOR SPEAKMAN

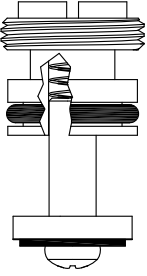

400220

FOR GLACIER BAY

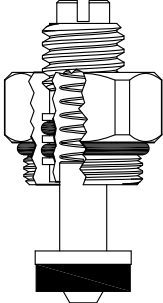

GASKET: 890150 O-RING INCLUDED

400231

FOR ADVANCED TABCO

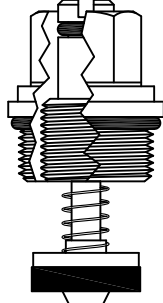

GASKET: 890170 O-RING INCLUDED

400241

FOR SEARS

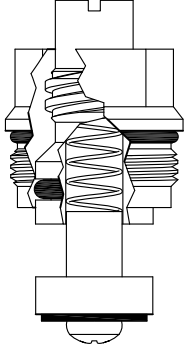

GASKET: 890180 O-RING INCLUDED

400261

FOR MIXET

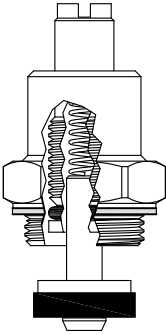

GASKET: 895060 INCLUDED

400371

FOR MOEN

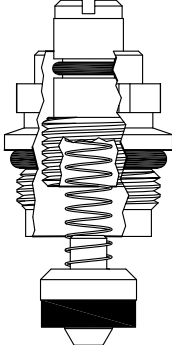

Nickel Plated Stem

GASKET: 891140 O-RING INCLUDED

400421

FOR SAYCO

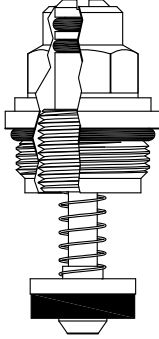

Nickel Plated Stem

GASKET: 890160 O-RING INCLUDED

400121

FOR AM STD

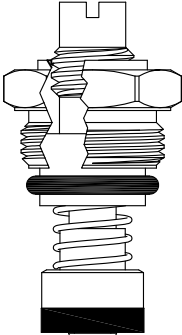

GASKET: 891130 O-RING INCLUDED

400171

FOR DELTA

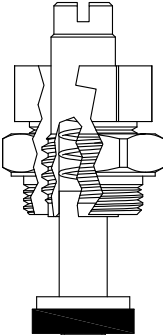

GASKET: 895060 INCLUDED

400151

FOR WILLOUGHBY

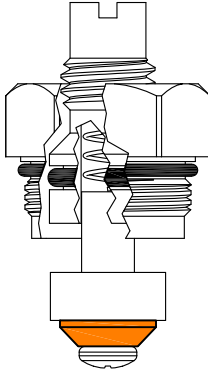

GASKET: 890190 O-RING INCLUDED

LF400451

FOR ACORN

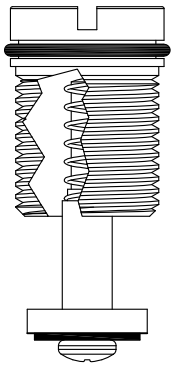

LF400190

# CHECK STOP STEM UNITS

FOR POWERS

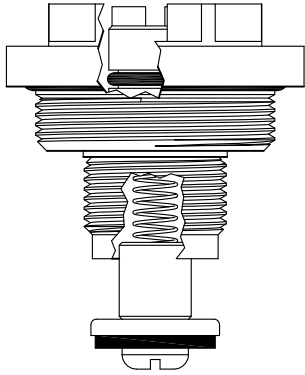

Also available as chrome plated unit  
**400471-CP**  
**200471-CP** Stem Only

GASKET: 891230 O-RING INCLUDED

**400471**  
**200471** Stem Only  
**500470-KIT** Retainer & Spring Only

FOR SPEAKMAN

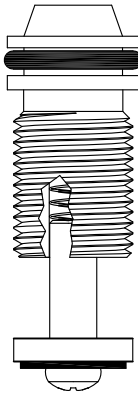

**400390**

FOR METCRAFT

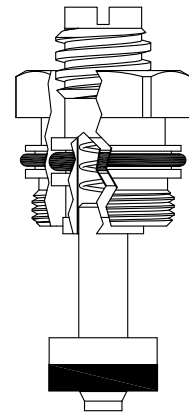

GASKET: 890160 O-RING INCLUDED

**LF400441**

FOR METCRAFT

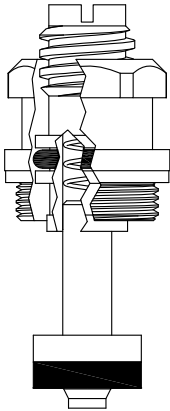

GASKET: 895100 INCLUDED

**LF400461**

FOR METCRAFT

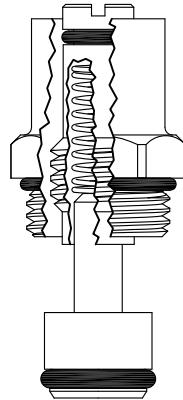

GASKET: 890170 O-RING INCLUDED

**LF400751**

FOR MIXET

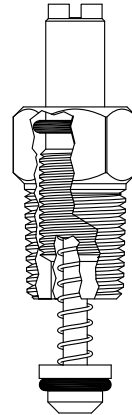

**400731**

FOR ACORN

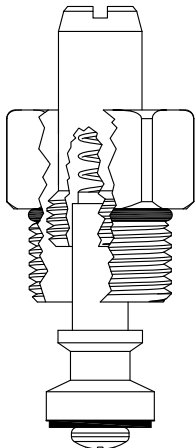

GASKET: 890160 O-RING INCLUDED

**LF400571**  
**LF200571** Stem Only

FOR MIXET

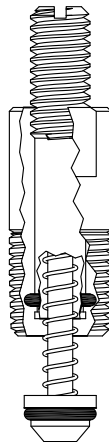

**400901**

FOR AM STD

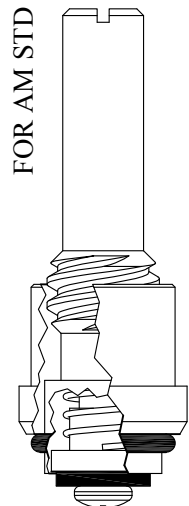

Chrome Plated Stem

GASKET: 8911300-RING INCLUDED

**464221**  
**264221** Stem Only

# CHECK STOP STEM UNITS

FOR CRANE  
LENGTH: 3.71"

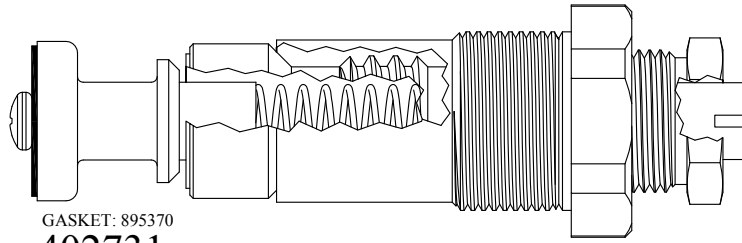

GASKET: 895370  
402731  
202731 Stem Only

## STOP STEMS & UNITS

FOR SPEAKMAN  
LENGTH: 1.07"

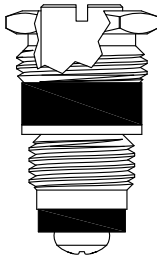

Nickel Plated Stem  
Chrome Plated Pkg Nut

LF400111  
LF200111 Stem Only

FOR ELJER  
LENGTH: 1.05"

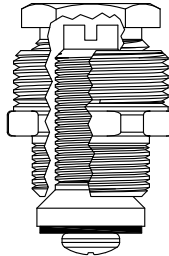

GASKET: 895060

400101

FOR DELTA  
LENGTH: 1.15"

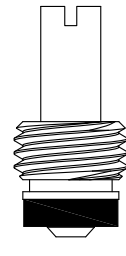

200141

FOR CRANE  
LENGTH: 1.15"

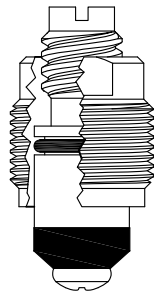

400201  
200201 Stem Only

FOR CRANE  
LENGTH: 1.15"

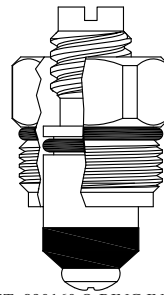

GASKET: 890160 O-RING INCLUDED

400211  
200201 Stem Only

FOR GERBER  
LENGTH: 1.19"

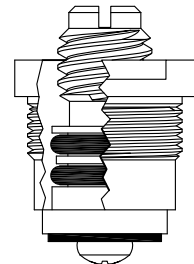

GASKET: 895150

400381

FOR STERLING FAUCET  
LENGTH: 1.24"

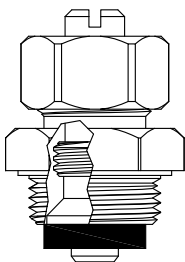

GASKET: 895110

400181

FOR ELJER  
LENGTH: 1.25"



GASKET: 890160 O-RING INCLUDED

400131

FOR PRICE PFISTER  
STEM LENGTH: 1.26"

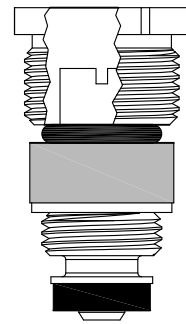

400301  
200301 Stem Only

# STOP STEMS & UNITS

FOR SAVOY  
LENGTH: 1.31"

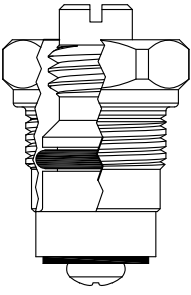

GASKET: 895100

400291

FOR SAYCO  
LENGTH: 1.37"

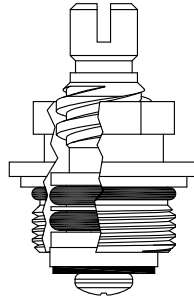

Nickel Plated Gland

GASKET: 890160 O-RING INCLUDED

400271

FOR SAYCO  
LENGTH: 1.37"

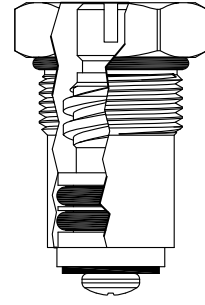

GASKET: 890170 O-RING INCLUDED

400281

FOR ELJER  
LENGTH: 1.38"

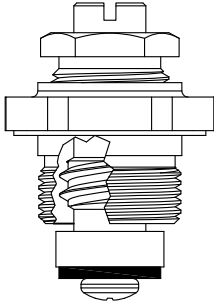

GASKET: 895100

400331  
200331

FOR ELJER  
LENGTH: 1.44"

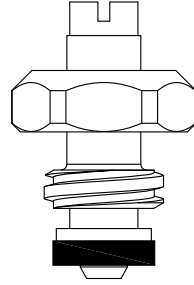

400251

FOR ELJER  
LENGTH: 1.56"

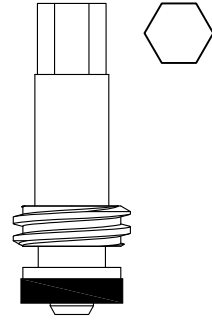

200351

FOR CRANE  
LENGTH: 1.57"

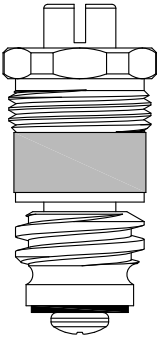

452821  
252821 Stem Only

FOR MIXET  
LENGTH: 1.60"

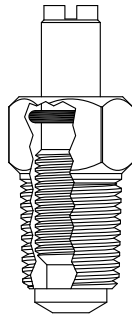

400721

FOR SPEAKMAN  
LENGTH: 1.64"

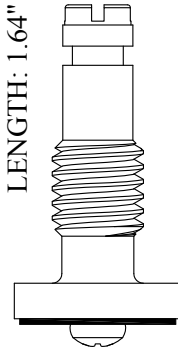

Chrome Plated Stem

252911

# STOP STEMS & UNITS

UNKNOWN  
LENGTH: 1.66"

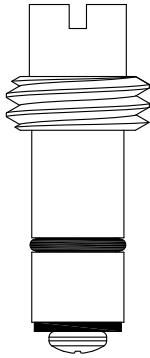

200611

FOR AM STD  
LENGTH: 1.69"

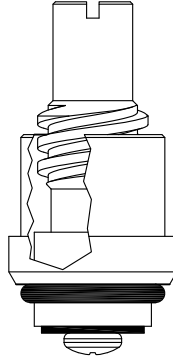

GASKET: 891130 O-RING INCLUDED

453181

253181 Stem Only

FOR AM STD  
LENGTH: 1.71"

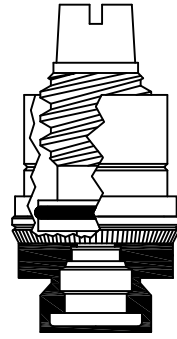

453191

FOR ACORN  
LENGTH: 1.73"

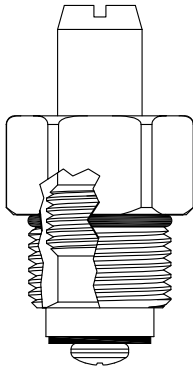

GASKET: 890160 O-RING INCLUDED

LF454071

LF254071 Stem Only

FOR SYMMONS  
LENGTH: 1.75"



400661

200661 Stem Only

FOR PRICE PFISTER  
LENGTH: 1.77"

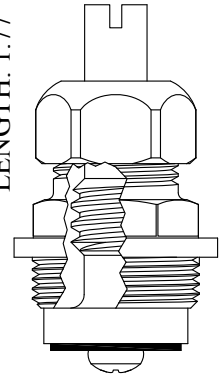

GASKET: 895400

400741

200741 Stem Only

FOR MOEN  
UNIT LENGTH: 1.77"

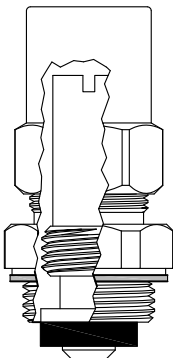

11/16-20 TPI Gland

GASKET: 895110 INCLUDED

400311

FOR MOEN  
UNIT LENGTH: 1.77"

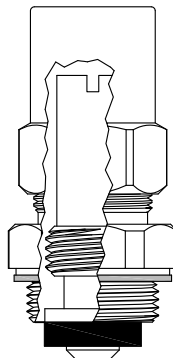

11/16-27 TPI Gland

GASKET: 895110 INCLUDED

400321

FOR MOEN  
UNIT LENGTH: 1.77"

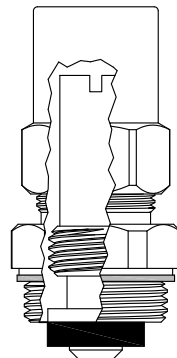

3/4-20 TPI Gland

GASKET: 895110 INCLUDED

400341

# STOP STEMS & UNITS

FOR KOHLER  
LENGTH: 1.80"

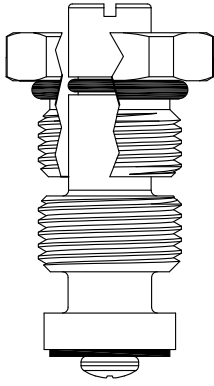

GASKET: 891140 O-RING INCLUDED

400921  
200921 Stem Only

FOR SEARS  
LENGTH: 1.83"

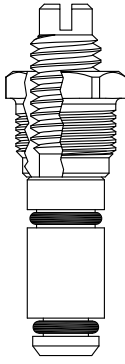

400361

FOR DICK BROS.  
LENGTH: 1.84"

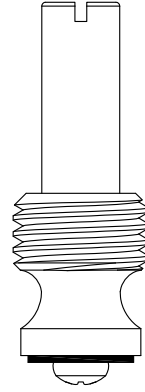

LF257001

FOR COYNE DELANEY  
LENGTH: 1.93"

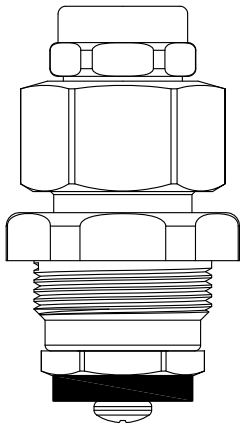

Chrome Plated Unit

GASKET INCLUDED: 895370

460302

FOR AM STD  
LENGTH: 1.95"

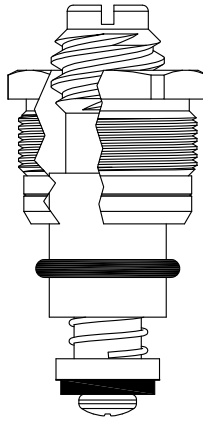

GASKET: 891130 O-RING INCLUDED

400591  
200591 Stem Only

FOR AM STD  
LENGTH: 1.96"



257351

FOR KOHLER  
LENGTH: 1.98"

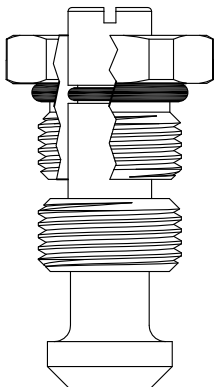

GASKET: 891140 O-RING INCLUDED

400911  
200911 Stem Only

FOR BRIGGS  
LENGTH: 2.08"

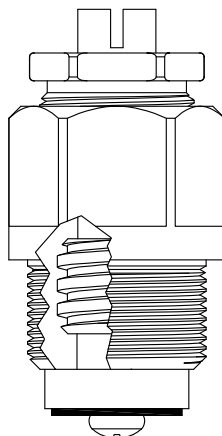

GASKET: 895370

401461  
201461 Stem Only

FOR MUELLER  
LENGTH: 2.15"

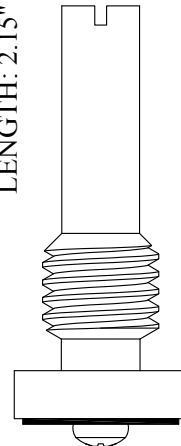

Chrome Plated Stem

201141

# STOP STEMS & UNITS

FOR SPEAKMAN  
LENGTH: 2.15"

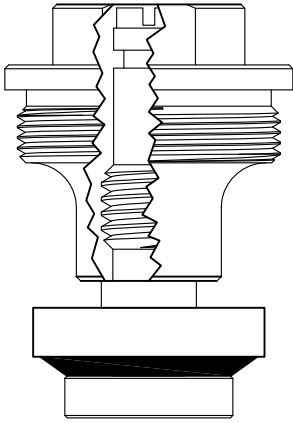

460401

LENGTH: 2.20"

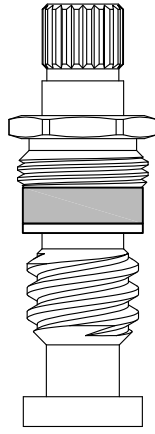

20  
2-4

Chrome Plated Stem

STEM UNIT  
FOR SENTINEL VALVE

401131

UNKNOWN  
LENGTH: 2.24"

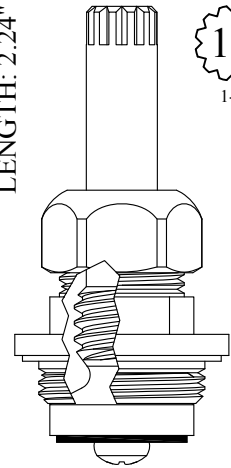

12  
1-2

GASKET: 895400

191041

FOR ACORN  
LENGTH: 2.25"

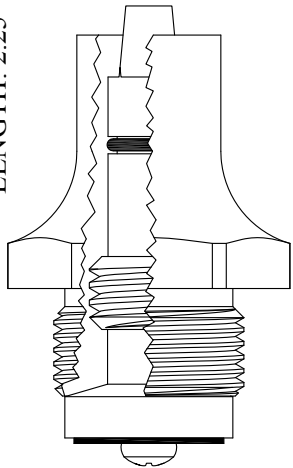

Chrome Plated Bonnet

GASKET: 895570

483121

FOR AM STD  
LENGTH: 2.28"

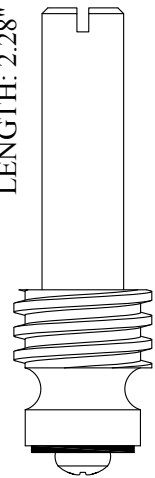

Nickel Plated Stem

22  
1-4

261131

FOR AM STD  
LENGTH: 2.28"

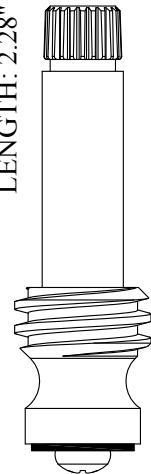

263281

FOR TANNER  
LENGTH: 2.29"

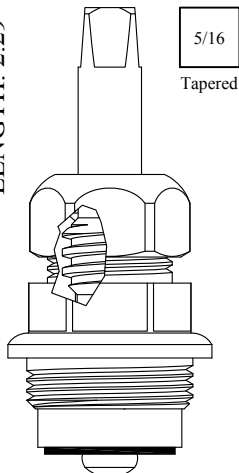

5/16  
Tapered

GASKET: 895400

462561

FOR ACORN  
LENGTH: 2.27"

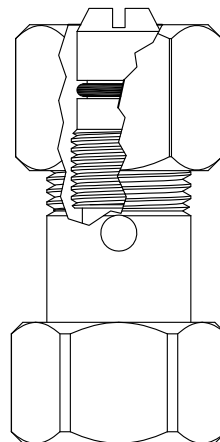

GASKET: 895100 INCLUDED

LF138921  
LF136401 Stem Only

FOR BRADLEY  
LENGTH: 2.46"

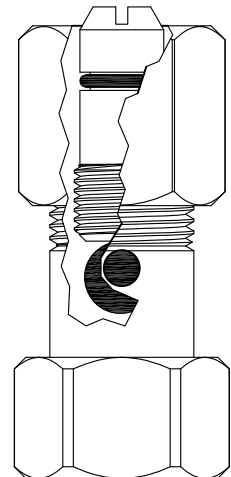

GASKET: 895100 INCLUDED

LF126480

# STOP STEMS & UNITS

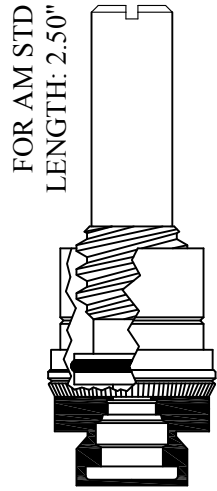

401551

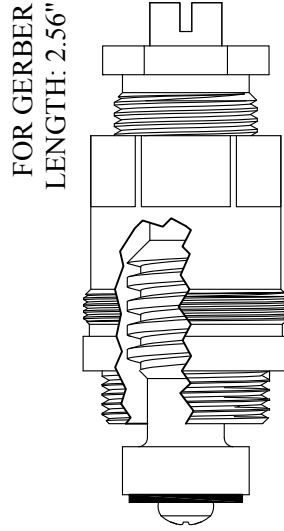

GASKET: 895400

401241  
201241 Stem Only

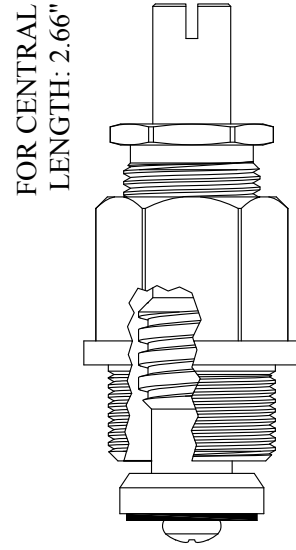

GASKET: 895400

401611  
201611 Stem Only

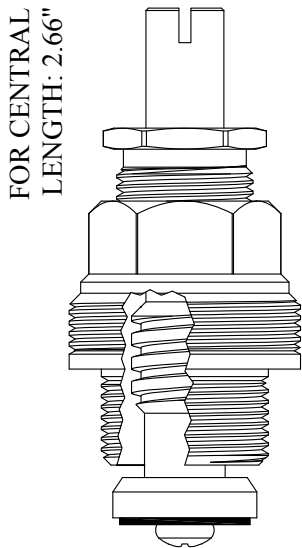
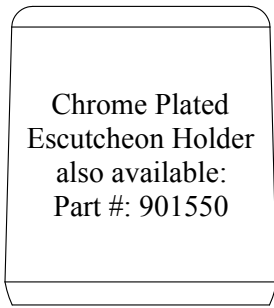

GASKET: 895400

401621  
201611 Stem Only

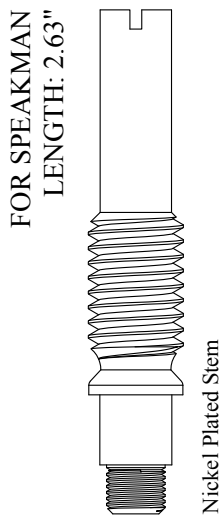

264331

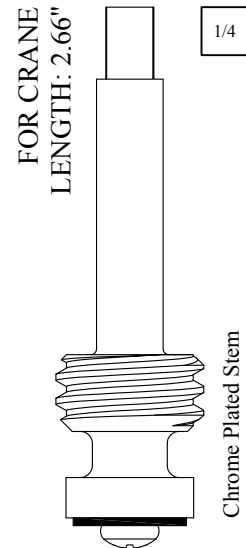

LF264461



# STOP STEMS & UNITS

Also available less gland  
**LF117621**

FOR ACORN  
 LENGTH: 2.72"

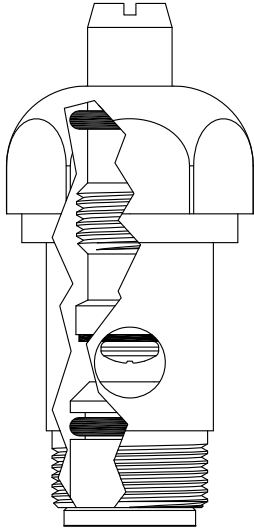

GASKET: 895400 INCLUDED  
 SEAT INCLUDED: LF601780

**LF401781**  
**LF254071** Stem Only

FOR AM STD  
 LENGTH: 2.78"

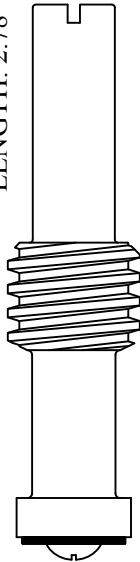

Chrome Plated Stem

**201711**

FOR AM STD  
 LENGTH: 2.88"

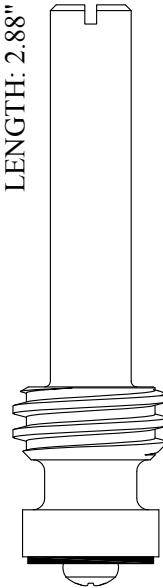

Chrome Plated Stem

**265611**

LENGTH: 3.02"

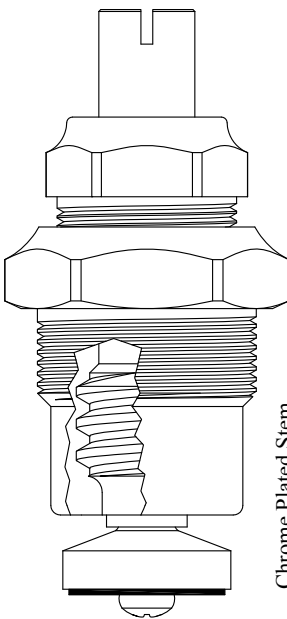

Chrome Plated Stem

GASKET: 895450

**402071**  
**202071** Stem Only

FOR SPEAKMAN  
 LENGTH: 3.06"

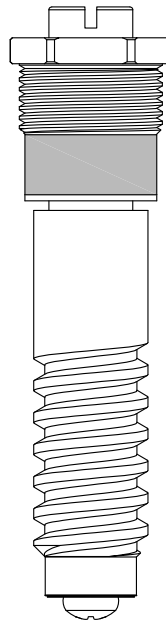

Chrome Plated Stem

**401901**  
**201901** Stem Only

FOR PRICE PFISTER  
 LENGTH: 3.22"

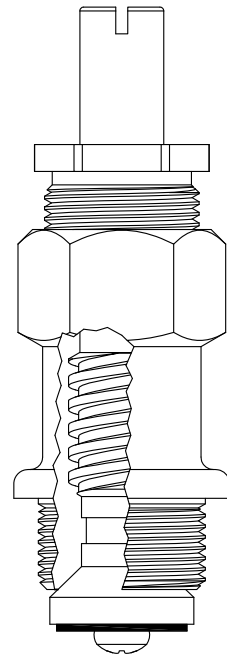

GASKET: 895400

**402621**  
**202621** Stem Only

# STOP STEMS & UNITS

FOR PRICE PFISTER  
LENGTH: 3.22"

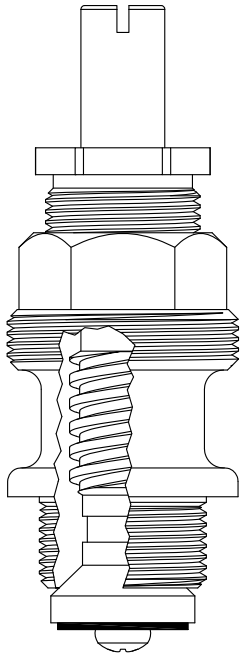

GASKET: 895400

402671

202621 Stem Only

FOR ILLINOIS  
LENGTH: 3.24"

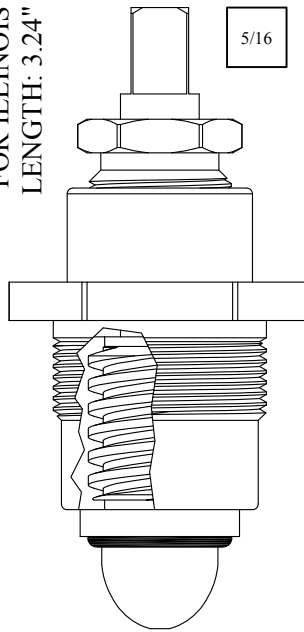

483421

FOR BRIGGS  
LENGTH: 3.25"

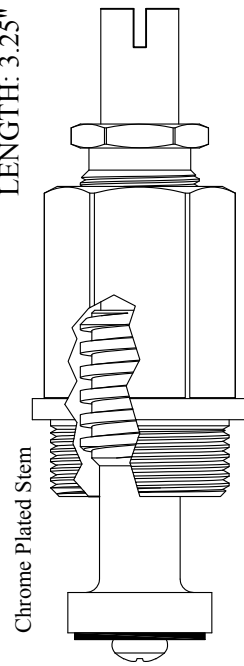

GASKET: 895370

402611

202611 Stem Only

FOR SAVOY  
LENGTH: 3.47"

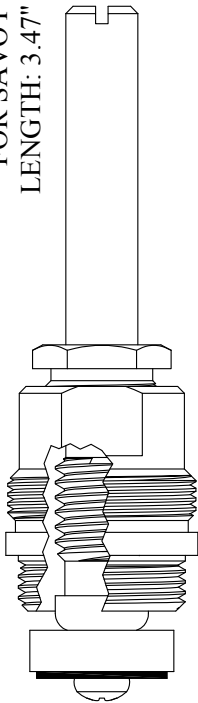

GASKET: 895400

402831

FOR KOHLER  
LENGTH: 3.50"

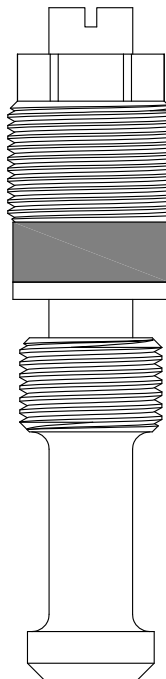

402991

202991 Stem Only

FOR CRANE  
LENGTH: 3.66"

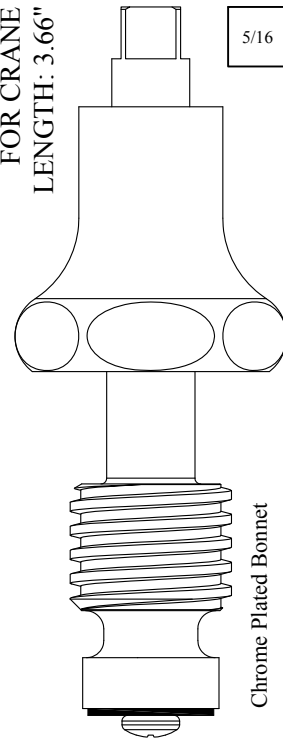

403121

203121 Stem Only

# STOP STEMS & UNITS

FOR GLAUBER WEST COAST  
STEM LENGTH: 3.65"

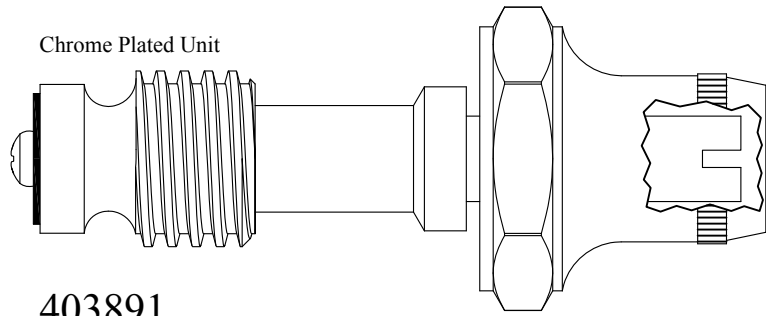

403891  
203891 Stem Only

FOR BRIGGS  
LENGTH: 4.17"

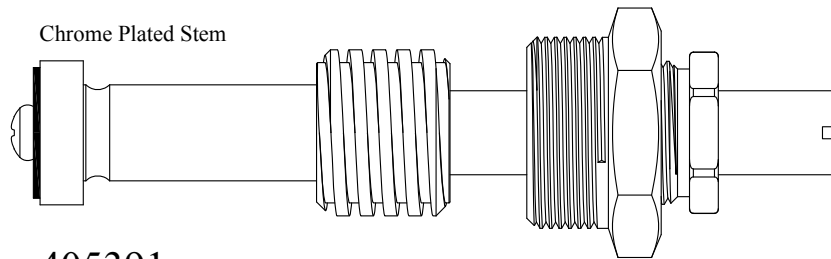

405391  
205391 Stem Only  
GASKET: 895340

FOR SAVOY  
LENGTH: 4.14"

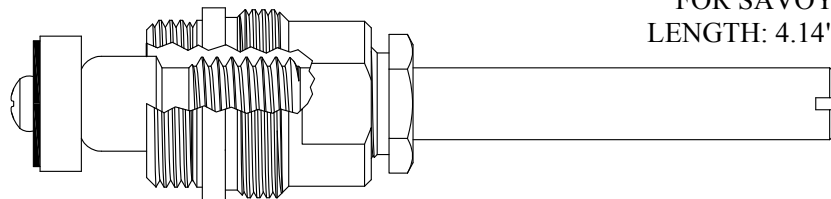

405521  
GASKET: 895400

FOR DICK BROS.  
LENGTH: 4.81"

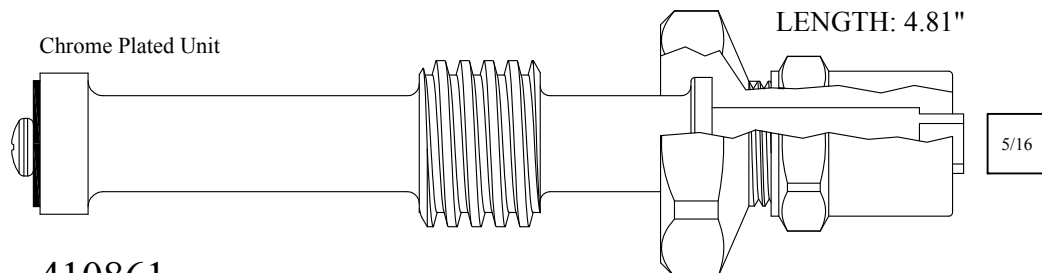

410861  
210861 Stem Only  
GASKET: 895400 INCLUDED

5/16

# STOP STEMS & UNITS

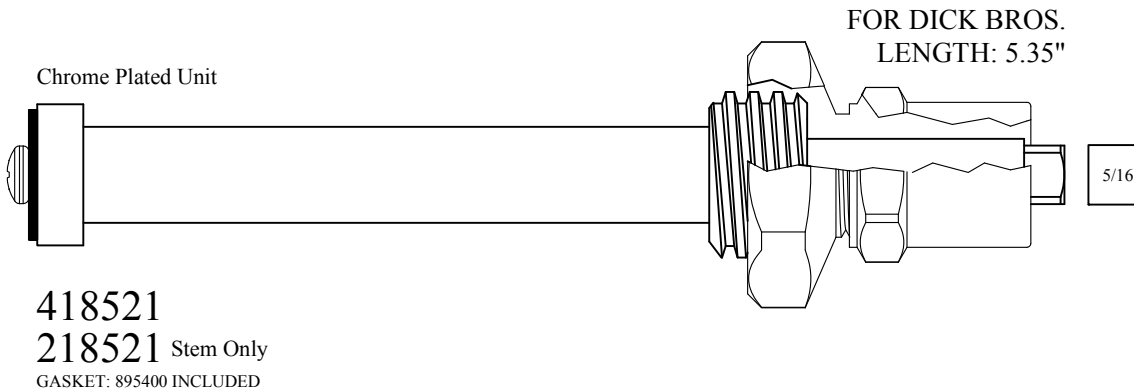
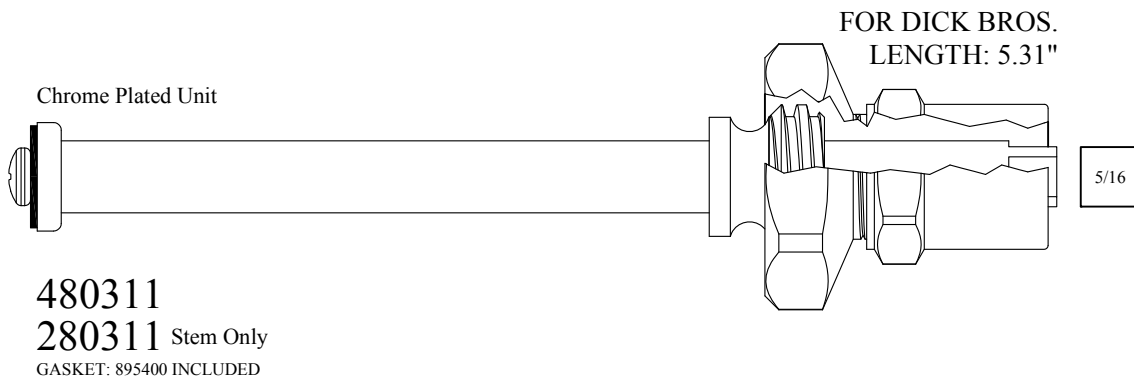
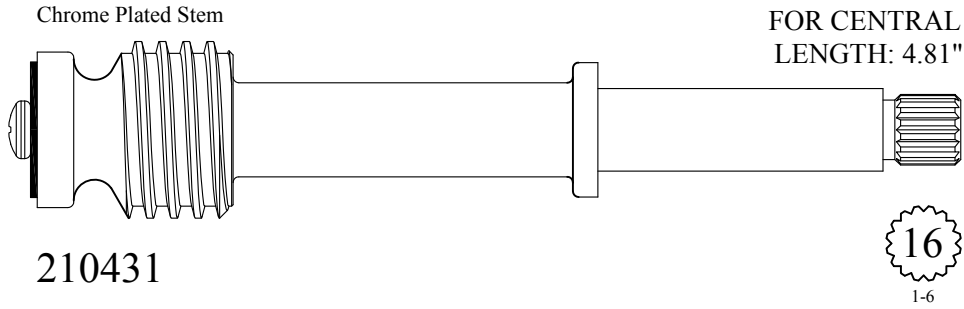

BARRY E.  WALTER SR. CO.

SEATS,  
SEAT KITS &  
BARRELS

***Send Your Orders To:***

BARRY E.  SR. CO.









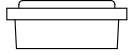
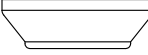

***E-mail: [orderdesk@barrywalter.com](mailto:orderdesk@barrywalter.com)***

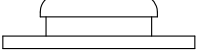
***Fax: 1.800.886.9831***

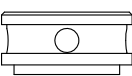
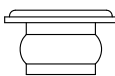
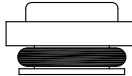
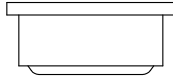
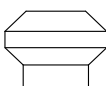
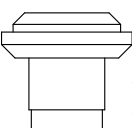
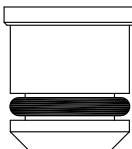
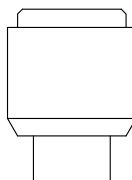
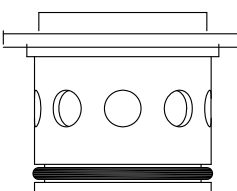
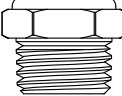
***Phone: 1.800.767.5552***

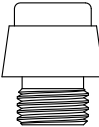
# SEATS

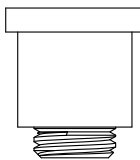
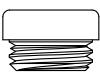
## PRESS-IN

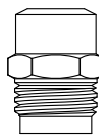
15/64  647140 CONCINNITY* Plastic	1/4  LF648200 REPCAL*	1/4  648750 CHICAGO* - OLD Stainless	7/32  649560 CHICAGO* - NEW Monel	9/32  649510 SPHINX*
21/64  LF649460 KOHLER* Chrome Plated	21/64  LF958070 PRICE PFISTER*	11/32  LF649020 UNION BRASS\ GOPHER*	3/8  LF648310 PRICE PFISTER*	3/8  649520 SPHINX*
13/32  649110 SPEAKMAN* Plastic	39/64  652360 SAYCO* Plastic	3/4  LF601780 ACORN*	29/32  609910 SAYCO* Plastic	15/16  647660 SYMMONS J-18*
<u>1/4 PIPE</u>	<u>3/8-27</u>		<u>27/64-28</u>	<u>7/16-18</u>
1/2  LF648390 AM. STD.*	9/32  LF649130 CHICAGO SPECIALTY*	29/32  649970 SCOVILLE* Plastic	1/2  647830 INDIANA*	25/32  LF647090 ELJER*
<u>7/16-20</u>				
	3/8  LF649050 BORG-WARNER*	5/16  LF647690 ELJER*	21/32  647600 ELJER*	

# SEATS

7/16-24

---

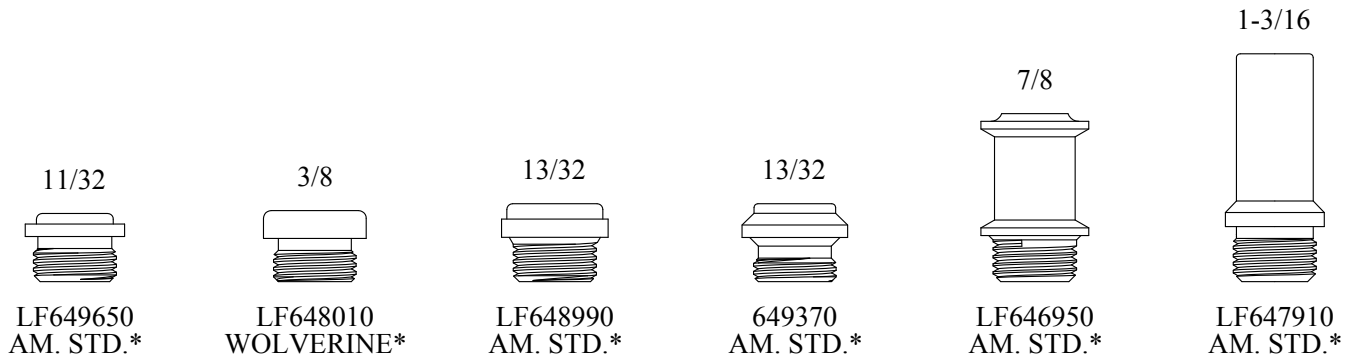

7/16-27

---

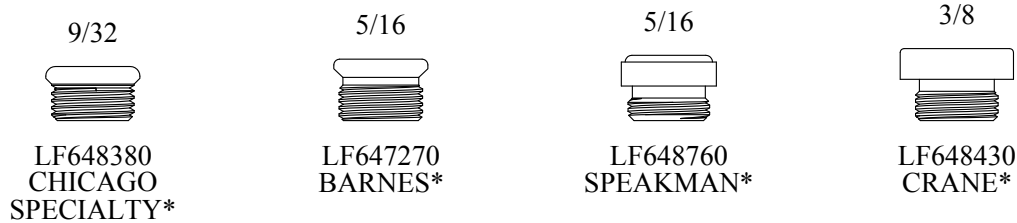

12mm x 1.00



15/32-27



1/2-12

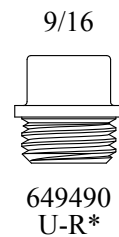

1/2-18

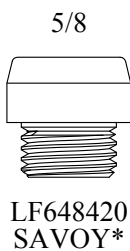

1/2-20

---

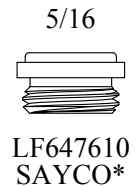
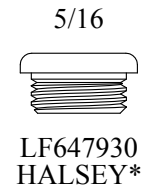



# SEATS

1/2-20

19/64



LF648210  
MICHIGAN\*

11/32

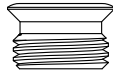

LF648020  
BARNES/ELJER\*

11/32



LF648410  
AM. BRASS\*

11/32

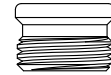

LF648400  
STREAMWAY\*

3/8

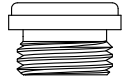

LF647000  
AM. KITCHEN\*

3/8



LF648270 NICKEL  
LF648270-B UNPLATED  
PRICE PFISTER\*

3/8



LF648100  
AM. STD.\*

3/8

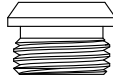

LF648320  
ELJER\*

3/8

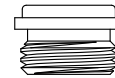

LF647450  
SAYCO\*

3/8

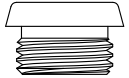

LF648260  
ROYAL BRASS\*

25/64



LF646970  
PRICE PFISTER\*

13/32



LF649740  
SAVOY\*

27/64



LF649810  
GERBER\*

7/16



LF648350  
AM. STD.\*

7/16



LF649270  
GRAND HAVEN\*

5/8

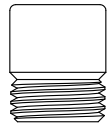

LF648030  
STREAMWAY\*

5/8

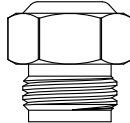

649590  
AM. STD.\*

5/8

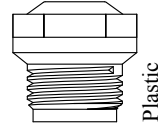

73002-07  
AM. STD.\*

Plastic

5/8

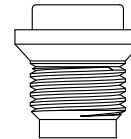

LF649290  
MANSFIELD\*

3/4

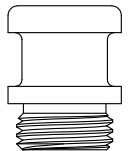

LF648250  
BRIGGS\*

3/4

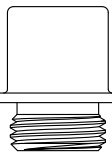

LF648440  
ROYAL/HAWS\*

3/4

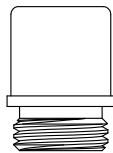

LF649310  
SAYCO\*

13/16

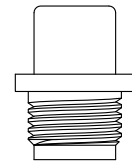

LF649580  
AMERLINE\*

27/32

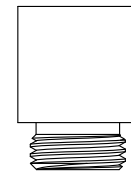

649350  
AUBURN\*

7/8

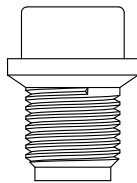

LF649340  
MANSFIELD\*

15/16

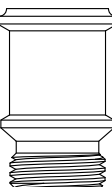

646960  
AM. STD.\*

1-1/32

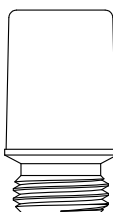

LF649330  
SCHAIBLE\*

1-1/8

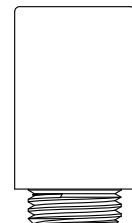

LF649380  
FISHER\*

1-7/32

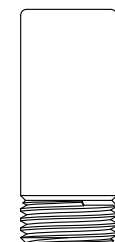

LF648040  
STREAMWAY\*

1-1/4

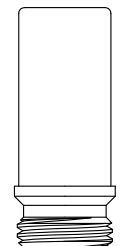

LF648140

# SEATS

1/2-20

1-17/32

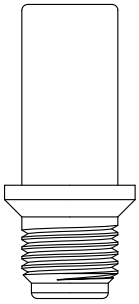

LF648460  
AM. BRASS\*

1-19/32

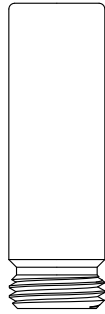

LF647670  
PHOENIX\*

1-19/32

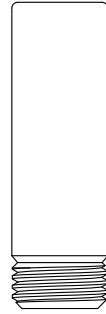

LF647680  
STREAMWAY\*

1-21/32



LF648050  
STREAMWAY\*

1.71"

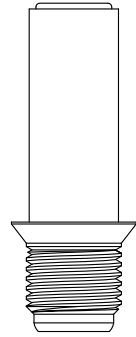

LF647470  
AM. BRASS\*

1-3/4

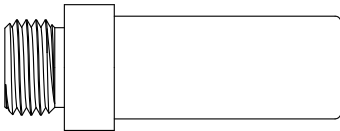

LF649160  
INDIANA\*

1-7/8

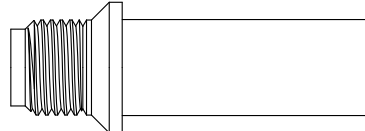

LF649950  
AM. BRASS\*

2-11/32



LF649170  
STREAMWAY\*

2-1/2



LF649180  
AUBURN\*

2-3/32



LF649120  
AUBURN\*

1/2-24

17/64

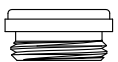

LF649600  
WEST BRASS\*

11/32



LF649190  
STREAMWAY\*

23/64

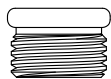

LF648280  
STREAMWAY\*

3/8

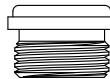

LF648170  
STERLING\*

3/8

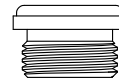

LF649200  
WOLVERINE\*

3/8

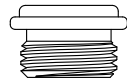

LF649610  
ROYAL BRASS\*

27/64



LF648550  
CENTRAL\*

7/16



LF648120  
BRIGGS/REPCAL\*

5/8

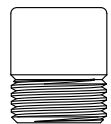

LF648060  
STREAMWAY\*

3/4



LF648470  
CENTRAL\*

15/16

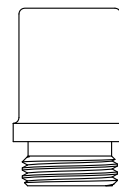

LF647300  
CENTRAL\*

15/16

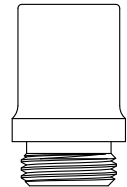

LF649230  
ROYAL BRASS\*

1-7/32



LF648240  
STREAMWAY\*

1-1/4

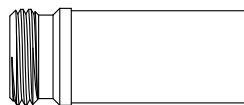

LF649240  
AM. BRASS\*

1-5/8

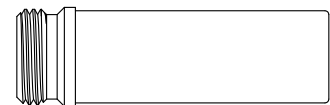

LF647170  
STREAMWAY\*

# SEATS

## 1/2-24

1-5/8

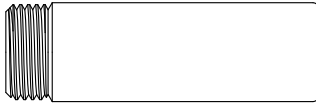

LF648080  
STREAMWAY\*

2-13/32

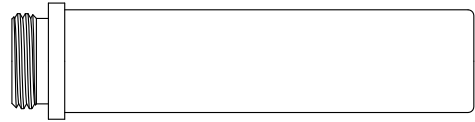

LF649980  
UNKNOWN

## 1/2-27

9/32

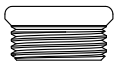

LF648500  
CHICAGO  
SPECIALTY\*

5/16

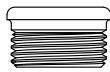

LF649760  
DICK BROS.\*

5/16



LF648070  
KOHLER\*

11/32

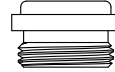

LF647700  
T & S\*

11/32

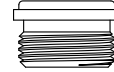

LF649450  
DISHMASTER\*

3/8

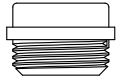

LF647560  
ACORN\*

3/8



LF649390  
KOHLER\*

3/8

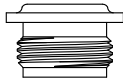

647240  
CASE\*

7/16



LF648860  
UNKNOWN

1/2

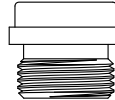

LF648160  
ELJER\*

1/2



LF649280  
KOHLER\*

5/8

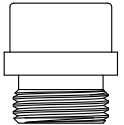

LF648610  
ELJER\*

1-9/32

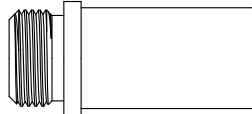

LF648620  
ELJER\*

1-19/32

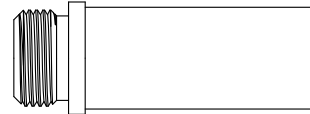

LF648520  
ELJER\*

## 1/2-28

5/16



LF647180  
BURLINGTON\*

13/32



LF648560  
INDIANA\*

## 33/64-18

ALL UNION BRASS\*

5/16



LF648480

5/8

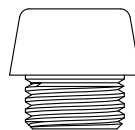

LF647460

1-5/32



LF648090

1-29/32

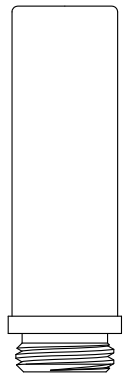

LF648110

# SEATS

33/64-27

ALL MILWAUKEE\*

23/32

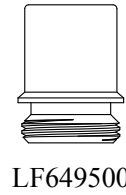
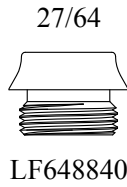

17/32-18

35/64-20

35/64-24

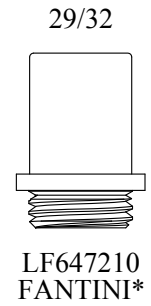
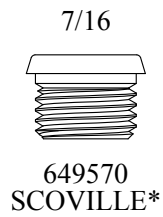

17/32-24

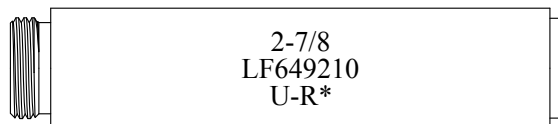
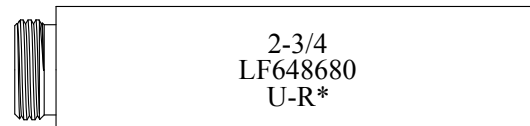
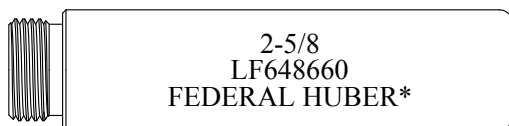
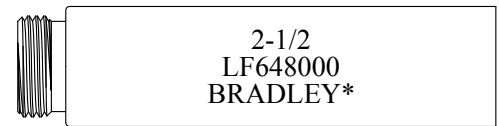
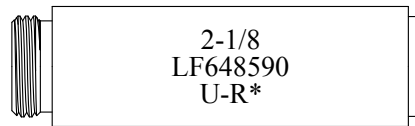
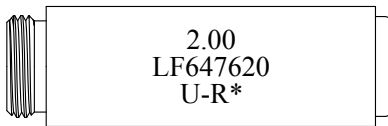
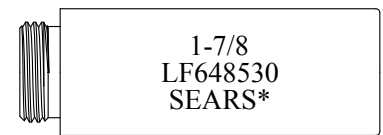
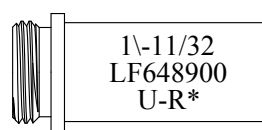
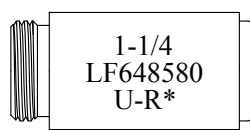
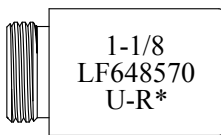
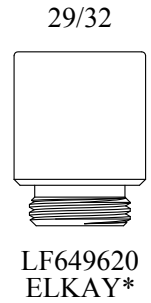
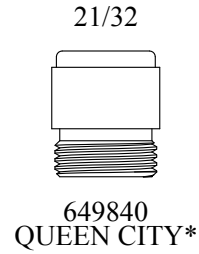

# SEATS

14mm x 1.0

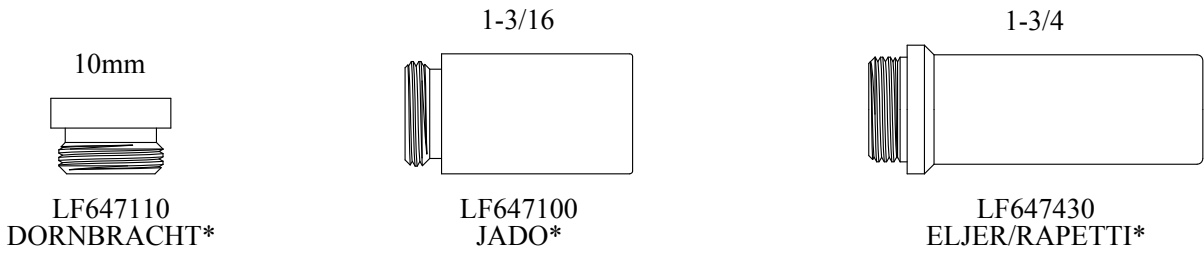

9/16-18

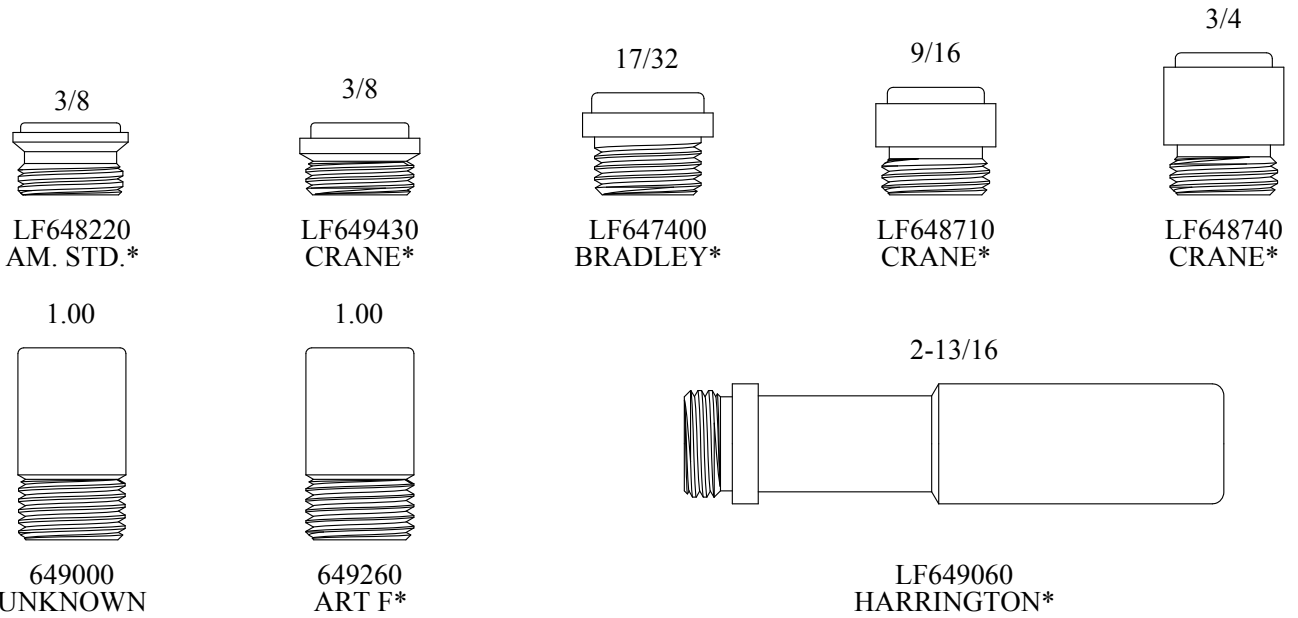

9/16-20

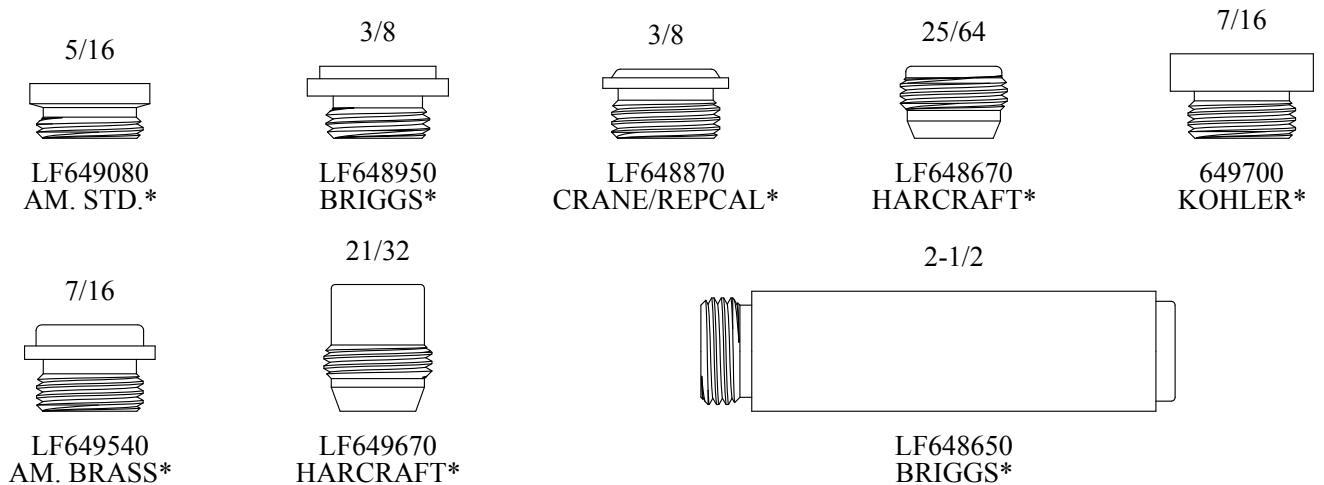

9/16-22

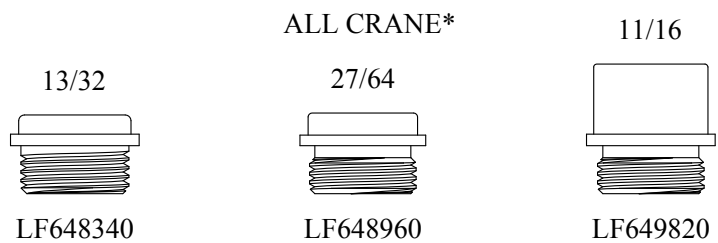

\*Original Mfg's names are used for identification only and are not a representation that the items offered are genuine items of the original Mfg.

# SEATS

9/16-24

9/32



LF649470  
U-R\*

3/8



LF646940  
CAMBRIDGE\*

3/8



LF648330  
BARNES\*

3/8



LF649030  
McDONALD/CRANE\*

7/16

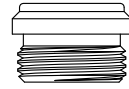

LF649790  
BRIGGS\*

15/16

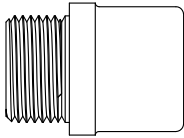

649100  
HAJOCA\*

1-33/64



LF647420  
CAMBRIDGE\*

2-39/64



LF647290  
MILWAUKEE\*

29/64

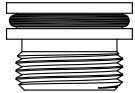

LF663350  
PERLICK\*

2-5/8



647440  
FEDERAL HUBER\*

2-29/32

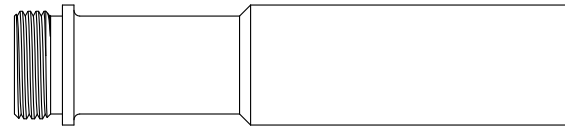

LF647810  
CONCINNITY\*

3-11/64



LF646980  
PHYLIRICH\*

9/16-27

9/32

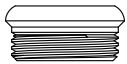

LF648780  
CHICAGO  
SPECIALTY\*

11/32

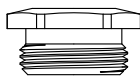

646990  
BRADLEY\*  
Stainless

3/8



LF648930  
SPEAKMAN\*

13/32

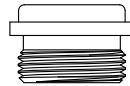

LF648790  
CENTRAL\*

13/32

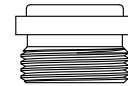

LF648980  
DICK BROS.\*

5/8

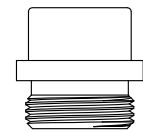

LF649300  
INDIANA\*

1-1/4

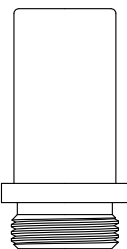

LF649400  
INDIANA\*

1-1/2

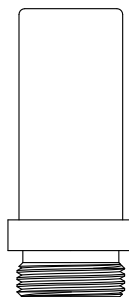

LF648820  
INDIANA\*

1-5/8

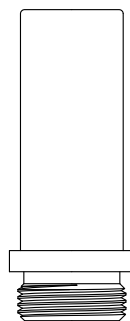

LF649410  
INDIANA\*

1-23/32

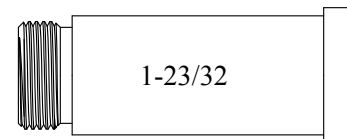

LF649250  
SPEAKMAN\*

2-9/32

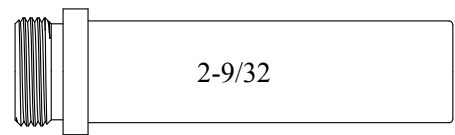

LF647880  
INDIANA\*

# SEATS

9/16-27

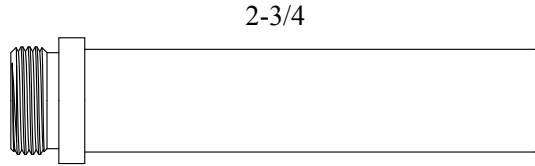

LF647870  
INDIANA\*

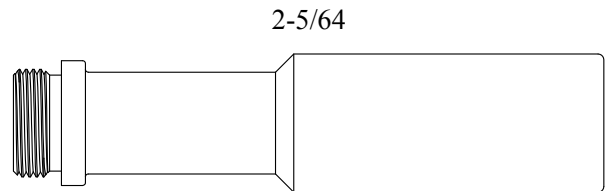

LF647150  
HARRINGTON\*

9/16-28

15mm x 1.25

19/32-20

11/32

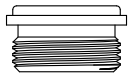

LF649770  
CRANE/REPCAL\*

17/32

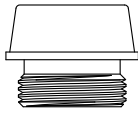

LF648880  
CRANE\*

8mm

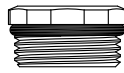

647080  
METCRAFT\*  
Stainless

10mm

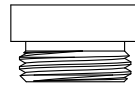

LF646930  
KUGLER\*

31/64

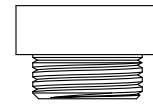

649090  
AM. STD.\*

1-9/64

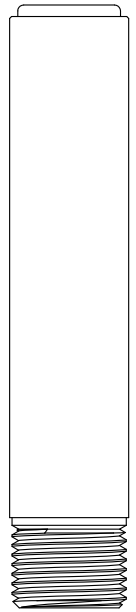

646910  
MUELLER\*

5/8-16

19/32-24

3/8

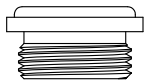

649680  
WOLVERINE\*

19/32-27

7/16

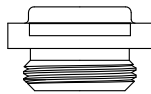

649730  
KOHLER\*

29/32

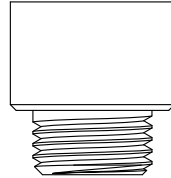

LF647770  
CRANE\*

1-31/32

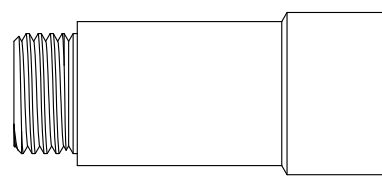

LF647800  
CRANE\*

5/8-18

5/16

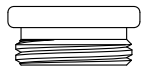

LF649910  
UNION BRASS\*

21/64



LF649720  
UNION BRASS\*

3/8

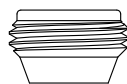

LF648830  
HARCRAFT\*

7/16



LF649010  
CHASE\*

15/32



LF649930  
UNION BRASS\*

11/16

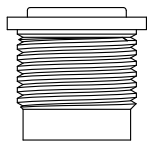

LF646880  
UNKNOWN

3/4

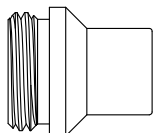

LF649940  
UNION BRASS\*

7/8

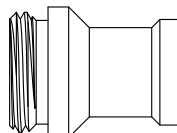

LF649890  
UNION BRASS\*

1-5/32

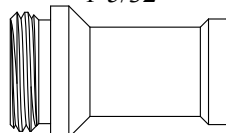

LF649900  
UNION BRASS\*

1-29/32

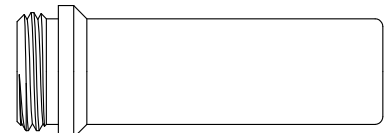

LF649780  
UNION BRASS\*

\*Original Mfg's names are used for identification only and are not a representation that the items offered are genuine items of the original Mfg.

# SEATS

## 5/8-20

3/8

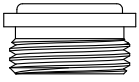

648640  
SAYCO\*

3/8

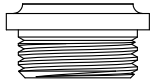

649830  
SYMMONS\*

27/64

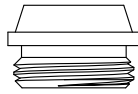

LF649150  
GERBER\*

7/16

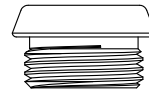

647410  
ARROWHEAD\*

7/16

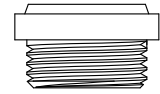

647650  
SYMMONS\*

7/16

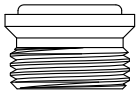

LF648450  
TRACY\*

1/2

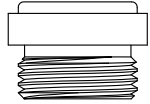

649850  
ROYAL BRASS\*

3/4

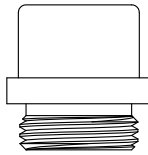

649800  
GLAUBER\*

13/16

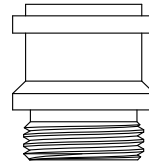

648630  
BRIGGS/  
REPUBLIC\*

13/16

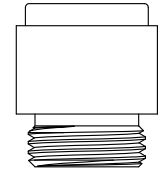

LF649480  
FISHER\*

1-1/8

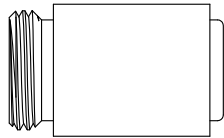

LF649140  
GERBER\*

2.00

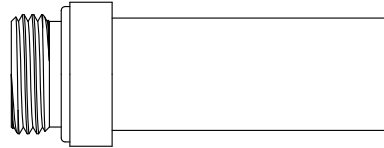

647720  
ROSS & GADE\*

## 5/8-24

11/32

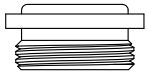

648190  
SPEAKMAN\*

13/32

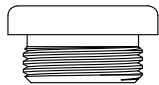

648180  
SPEAKMAN\*

27/64

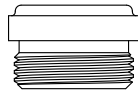

648970  
CENTRAL\*

27/64

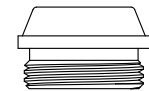

649860  
GERBER\*

7/16



648510  
BRIGGS\*

23/32

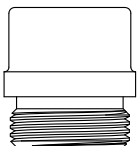

648810  
CENTRAL\*

1-3/4



647490  
BROADWAY\*

3-3/64



647260  
STERLING\*



# SEATS

5/8-27

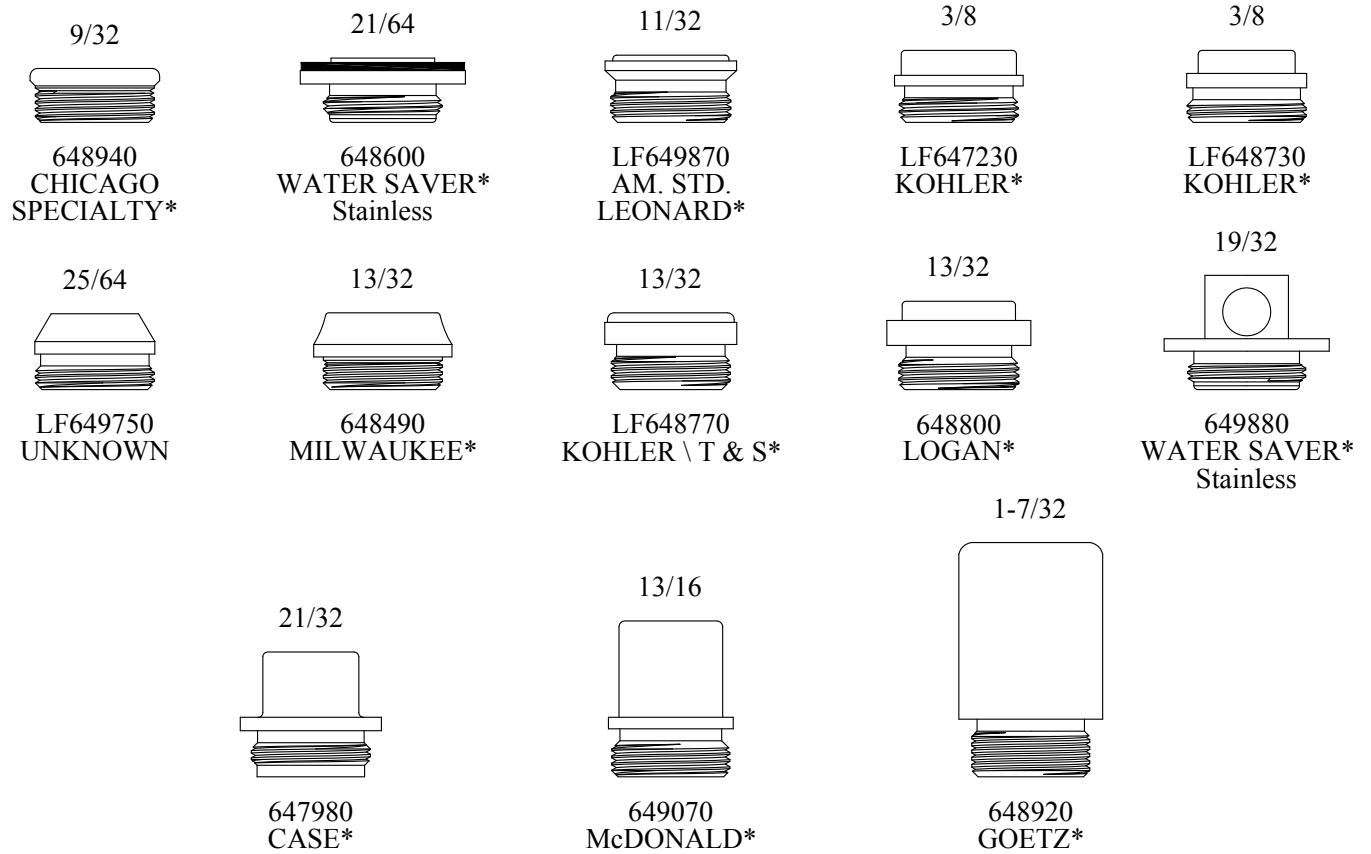

16mm x 1.0

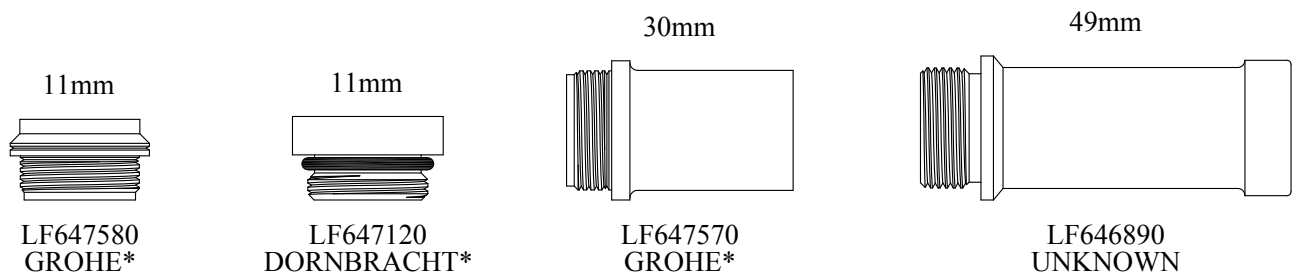

21/32-18 PRICE PFISTER\*

11/16-16

11/16-18

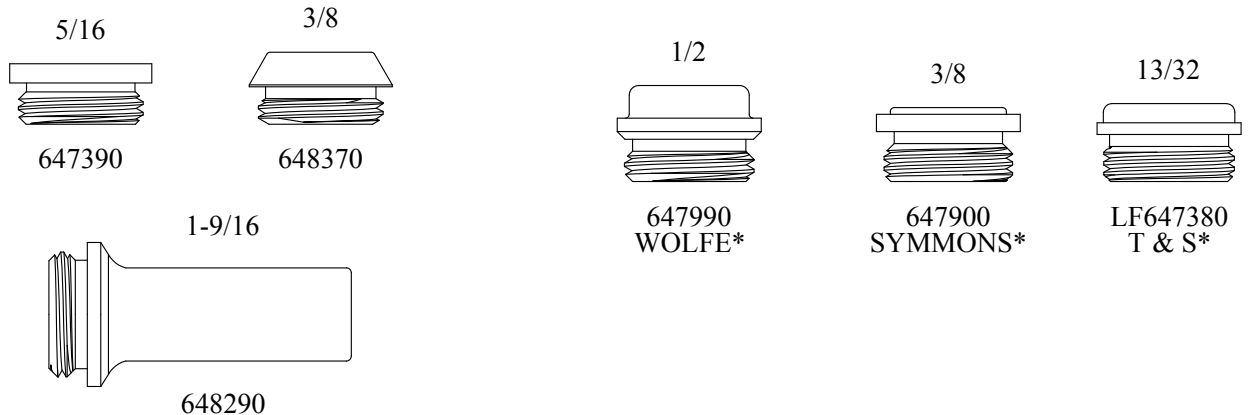

\*Original Mfg's names are used for identification only and are not a representation that the items offered are genuine items of the original Mfg.

# SEATS

11/16-20

13/32

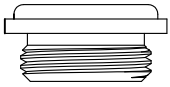

649690  
WOLVERINE\*

7/16

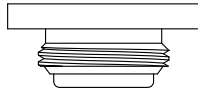

LF647280  
SEARS\*

11/16-22

7/16



LF649660  
CRANE\*

7/16



LF649920  
CRANE\*

1/2

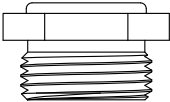

LF649710  
AM. STD.\*

7/8

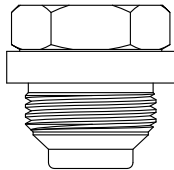

649360  
AM. STD.\*

31/64

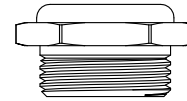

647890  
CRANE\*

11/16-27

11/16-24

3/8



649960  
CRANE\*

25/64



LF647850  
CENTRAL\*

13/32

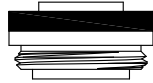

LF648850  
SAVOY\*

13/32

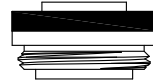

648850-M  
SAVOY\*  
Monel

15/32

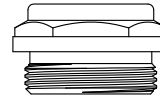

647220  
KOHLER\*

1-1/8

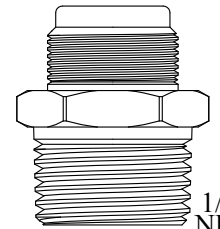

LF647500  
KOHLER\*

1/2  
NPS

3/4-16

3/8



648890  
BRADLEY\*

9/16



646920  
ZURN\*

13/16



647920  
BRADLEY\*

1-1/16

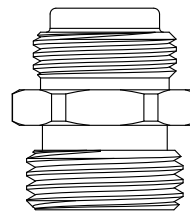

647540  
SAVOY\*

1/2  
NPS

1-1/4

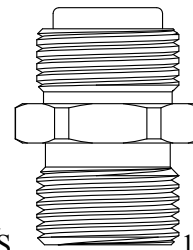

647510  
SAVOY\*

3/4  
16 TPI

1-1/4

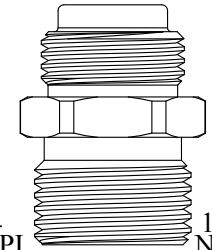

647520  
SAVOY\*

1/2  
NPS

3/4-18

27/64



647950  
UNKNOWN

1-1/4

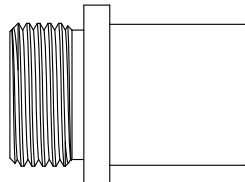

649420  
MORGAN\*

# SEATS

3/4-20

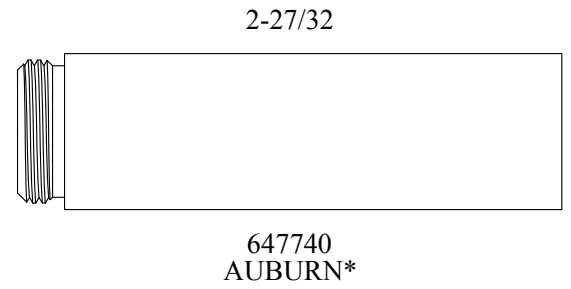
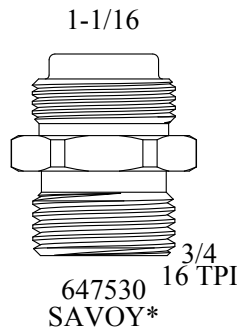

3/4-27

20mm x 1.0

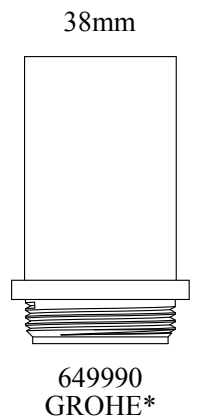
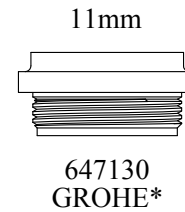
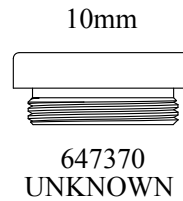
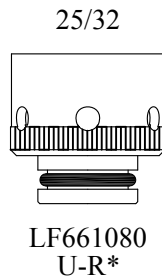
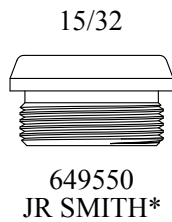

13/16-14

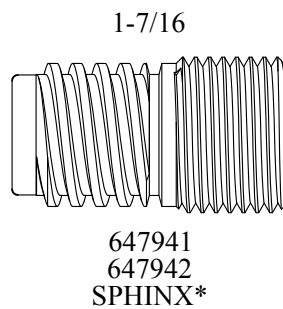

13/16-16

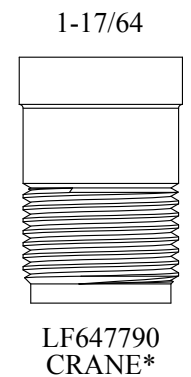
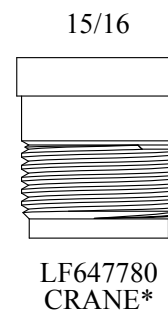
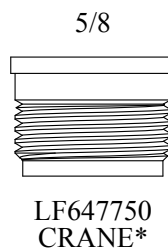
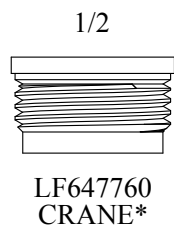
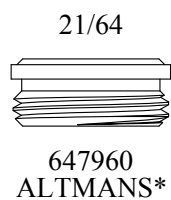

\*Original Mfg's names are used for identification only and are not a representation that the items offered are genuine items of the original Mfg.

# SEATS

13/16-16

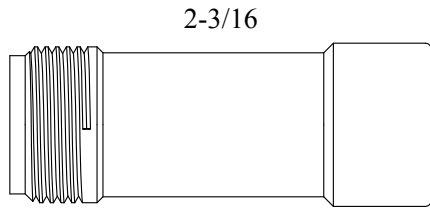

2-3/16

LF647820  
CRANE\*

13/16-24

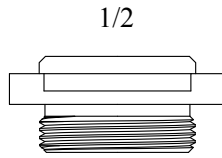

1/2

647190  
KOHLER\*

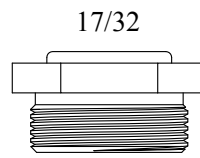

17/32

648910  
AM. STD.\*

13/16-26

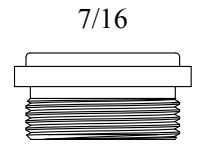

7/16

646870  
UNKNOWN

7/8-20

53/64-24

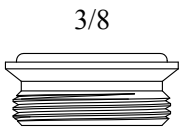

3/8

647840  
LEONARD\*

27/32-18

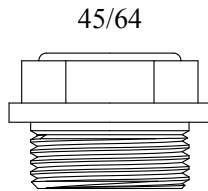

45/64

649630  
UNKNOWN

7/8-18

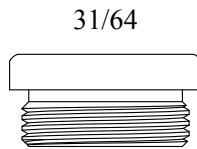

31/64

647160

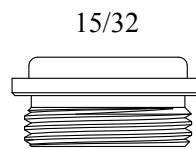

15/32

649320  
MUELLER\*

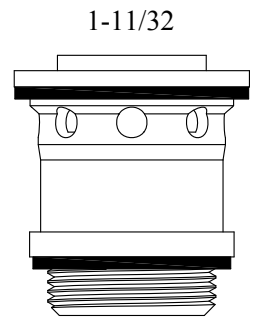

1-11/32

647970  
SYMMONS TS-2\*

7/8-22

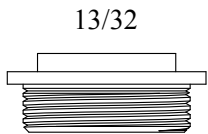

13/32

647730  
CRANE\*

29/32-18

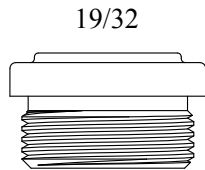

19/32

649440  
LENHART\*

15/16-20

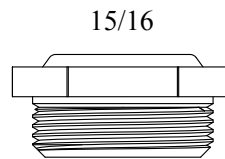

15/16

649530  
AM. STD.\*

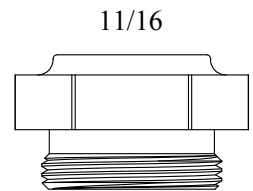

11/16

647710  
SPEAKMAN\*

1-5/32-20

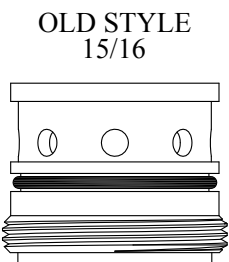

OLD STYLE  
15/16

647630-OS  
SYMMONS\*

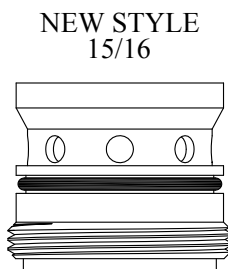

NEW STYLE  
15/16

647630  
SYMMONS T-3\*

1-3/16-16

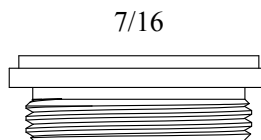

7/16

647550  
UNKNOWN

1-5/16-20

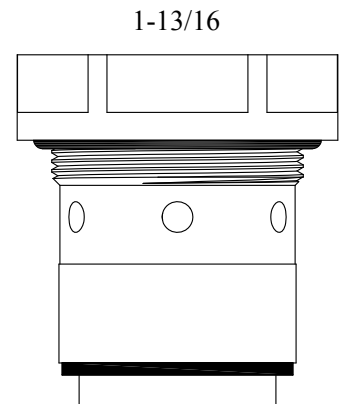

1-13/16

647640  
SYMMONS C-3\*

# SEAT KITS

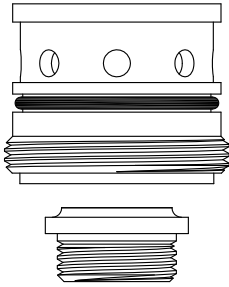

106090-OS  
SYMMONS TA-4\*  
OLD STYLE (SHORT)

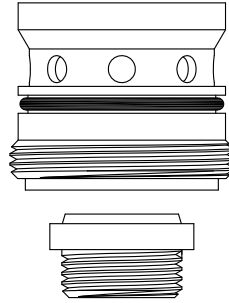

106090  
SYMMONS TA-4\*  
NEW STYLE

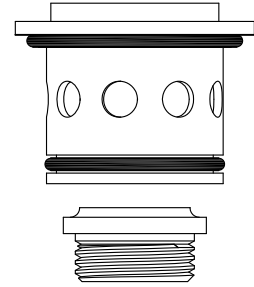

130540  
SYMMONS J-18/22\*

*Send Your Orders To:*

BARRY E.  ALTER  SR. CO.

*E-mail: [orderdesk@barrywalter.com](mailto:orderdesk@barrywalter.com)*

*Fax: 1.800.886.9831*

*Phone: 1.800.767.5552*

# SEAT KITS

144 PIECE SEAT ASSORTMENT

PART# 131010

4 PIECES PER SEAT

COMES IN A PLASTIC COMPARTMENTED BOX

1/4

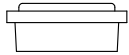

LF648200  
REPCAL\*

5/16



1/2-20  
LF647610  
SAYCO\*

5/16

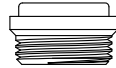

1/2-27  
LF648070  
KOHLER\*

5/16



1/2-20  
LF648230  
ARROWHEAD\*

5/16



33/64-18  
LF648480  
UNION BRASS\*

5/16

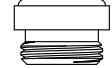

7/16-27  
LF648760  
SPEAKMAN\*

5/16

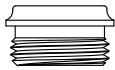

33/64-27  
LF649040  
MILWAUKEE\*

5/16



5/8-18  
LF649910  
UNION BRASS\*

11/32

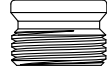

1/2-24  
LF649190  
STREAMWAY\*

11/32



7/16-24  
LF649650  
AM. STD.\*

11/32

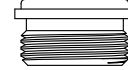

9/16-28  
LF649770  
CRANE/REPCAL\*

3/8

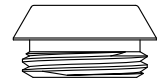

21/32-18  
648370  
PRICE PFISTER\*

3/8



1/2-20  
LF647450  
SAYCO\*

3/8



1/2-20  
LF648100  
AM. STD.\*

3/8



1/2-24  
LF648170  
STERLING\*

3/8



9/16-18  
LF648220  
AM. STD.\*

3/8

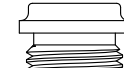

1/2-20  
LF648270  
PRICE PFISTER\*

3/8



1/2-20  
LF648320  
ELJER\*

3/8



35/64-24  
LF648360  
AM. STD.\*

3/8



9/16-27  
LF648930  
SPEAKMAN\*

3/8



1/2-27  
LF649390  
KOHLER\*

3/8



9/16-18  
LF649430  
CRANE\*

25/64

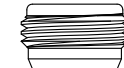

9/16-20  
LF648670  
HARCRAFT\*

13/32



1/2-28  
LF648560  
INDIANA\*

13/32



7/16-24  
LF648990  
AM. STD.\*

27/64

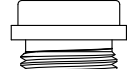

1/2-24  
LF648550  
CENTRAL\*

27/64

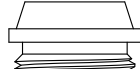

5/8-20  
LF649150  
GERBER\*

7/16



5/8-20  
647410  
ARROWHEAD\*

7/16

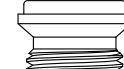

1/2-20  
LF648350  
AM. STD.\*

7/16



35/64-20  
LF648130  
SAVOY\*

1/2

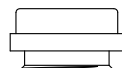

1/2-27  
LF648160  
ELJER\*

5/8

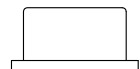

9/16-27  
LF649300  
INDIANA\*

23/32



5/8-24  
648810  
CENTRAL\*

7/8



5/8-18  
LF649890  
UNION BRASS\*

1-3/16



7/16-24  
LF647910  
AM. STD.\*

1-7/32



1/2-20  
LF648040  
STREAMWAY\*

# SEAT KITS

100 PIECE SEAT ASSORTMENT

PART# 131080

COMES IN A PLASTIC COMPARTMENTED BOX

5/16  
  
1/2-20  
LF647610  
SAYCO\*  
10 PCS

5/16  
  
1/2-27  
LF648070  
KOHLER\*  
5 PCS

3/8  
  
1/2-24  
LF648170  
STERLING\*  
10 PCS

3/8  
  
1/2-20  
LF648270  
PRICE PFISTER\*  
5 PCS

3/8  
  
35/64-24  
LF648360  
AM. STD.\*  
5 PCS

3/8  
  
21/32-18  
648370  
PRICE PFISTER\*  
10 PCS

13/32  
  
7/16-24  
LF648990  
AM. STD.\*  
15 PCS

27/64  
  
1/2-24  
LF648550  
CENTRAL\*  
10 PCS

27/64  
  
5/8-20  
LF649150  
GERBER\*  
15 PCS

7/16  
  
1/2-20  
LF648350  
AM. STD.\*  
5 PCS

7/16  
  
35/64-20  
LF648130  
SAVOY\*  
5 PCS

1/2  
  
1/2-27  
LF648160  
ELJER\*  
5 PCS

BARRY E.  SR. CO.











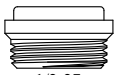
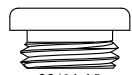
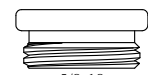
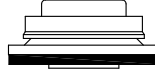



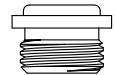
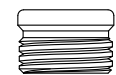

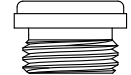

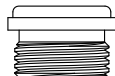
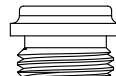
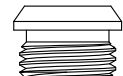





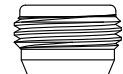

# SEAT KITS

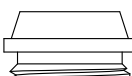
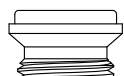
72 PIECE SEAT ASSORTMENT

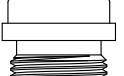
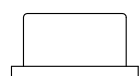
PART# 118810

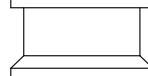
2 PIECES PER SEAT UNLESS OTHERWISE NOTED

COMES IN A PLASTIC COMPARTMENTED BOX

5/16  1/2-27 LF648070 KOHLER*	5/16  33/64-18 LF648480 UNION BRASS*	5/16  5/8-18 LF649910 UNION BRASS*	2 1/4  LF649460 KOHLER*	1 1/2  1/2-20 LF648410 AM. BRASS*	1 1/2  LF648020 ELJER*
1 1/2  7/16-27 LF648760 SPEAKMAN*	1 1/2  7/16-24 LF649650 AM. STD.*	2 3/4  1/2-20 LF648280 STREAMWAY*	3/8  2 1/2-18 648370 PRICE PFISTER*	3/8  1/2-20 LF647000 AM. KITCHEN*	3/8  5/8-27 LF647230 KOHLER*
3/8  1/2-20 LF647450 SAYCO*	3/8  1/2-24 LF648170 STERLING*	3/8  1/2-20 LF648270 PRICE PFISTER*	3/8  1/2-20 LF648320 ELJER* 6 PCS	3/8  35/64-24 LF648360 AM. STD.*	3/8  9/16-18 LF648220 AM. STD.*
3/8  5/8-20 648640 SAYCO*	3/8  1/2-27 LF649390 KOHLER*	3/8  9/16-18 LF649430 CRANE*	3/8  9/16-20 LF648670 HARCRAFT*	1 3/2  1/2-28 LF648560 INDIANA*	1 3/2  7/16-24 LF648990 AM. STD.*
1 3/2  9/16-22 LF648340 CRANE*	2 7/4  5/8-20 LF649150 GERBER*	7/16  1/2-20 LF648350 AM. STD.*	7/16  1/2-24 LF648550 CENTRAL*	7/16  1/2-24 LF648120 BRIGGS / REPCAL*	1/2  1/2-27 LF648160 ELJER*
5/8  9/16-27 LF649300 INDIANA*	2 3/2  5/8-24 648810 CENTRAL*	1 3/16  5/8-20 648630 BRIGGS / REPUBLIC*	7/8  5/8-18 LF649890 UNION BRASS*	1-3/16  7/16-24 LF647910 AM. STD.*	1-7/32  1/2-20 LF648040 STREAMWAY*



# BARRELS

FOR CHG  
LENGTH: 1.29"

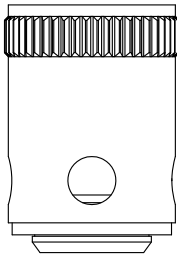

O.D.: 0.870"

LF662571  
LF662572

FOR WATER SAVER  
LENGTH: 1.33"

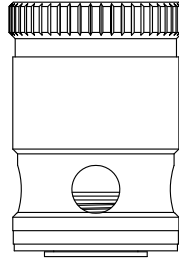

O.D.: 0.865"  
Stainless Steel  
Seat Included: 648600

LF661301  
LF661302

FOR KOHLER  
LENGTH: 1.41"

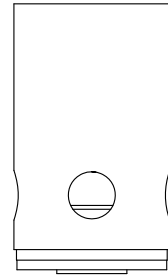

O.D.: 0.812"  
OEM PART # 24822

LF660050

FOR KOHLER  
LENGTH: 1.44"

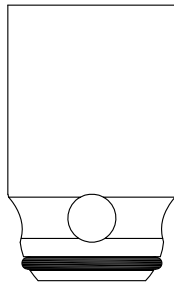

O.D.: 0.875"  
OEM PART # 32462

LF647321  
LF647322

FOR AM STD  
LENGTH: 1.47"

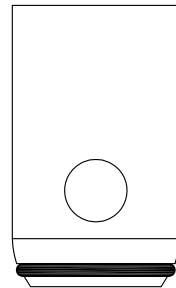

O.D.: 0.870"  
OEM PART # 21376-27

LF647020

FOR AM STD  
LENGTH: 1.47"

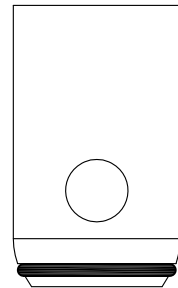

O.D.: 0.870"  
OEM PART # 20336-27

LF647021  
LF647022

FOR T & S  
LENGTH: 1.53"

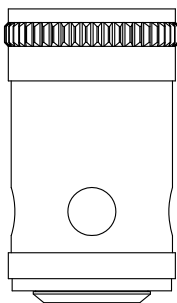

O.D.: 0.840"  
OEM PART # 00788-20

LF664061  
LF664062

FOR CHG  
LENGTH: 1.53"

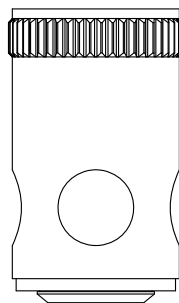

O.D.: 0.870"

LF666481  
LF666482

FOR T & S  
LENGTH: 1.54"

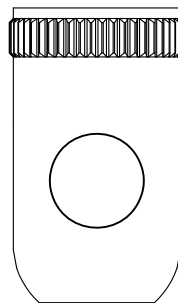

O.D.: 0.870"

LF664561  
LF664562

# BARRELS

FOR AM STD  
LENGTH: 1.56"

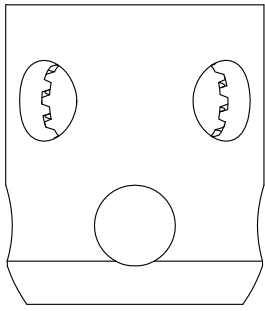

O.D.: 1.345"

635801

Single Lead

FOR AM STD RENU  
LENGTH: 1.59"

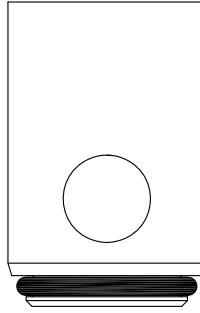

O.D.: 1.030"

OEM PART # 20651-27

LF647031

Double Lead

FOR AM STD RENU  
LENGTH: 1.59"

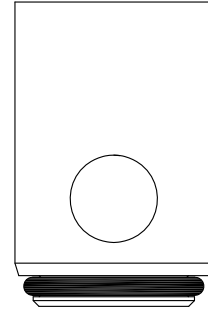

O.D.: 1.030"

OEM PART # 20691-27

LF647041

LF647042

FOR KOHLER  
LENGTH: 1.77"

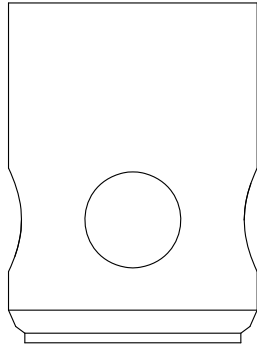

O.D.: 1.30"

OEM PART # 22592

647341

FOR WATER SAVER  
LENGTH: 1.67"

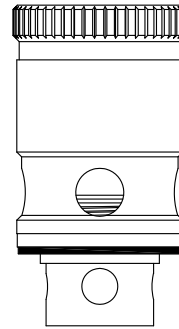

O.D.: 0.865"

Stainless Steel

Seat Included: 648600

LF664041

LF664042

FOR KOHLER  
LENGTH: 1.85"

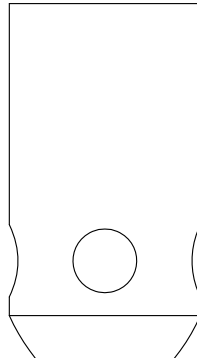

O.D.: 0.995"

OEM PART # 22565

647351

FOR MUELLER RENU  
LENGTH: 2.25"

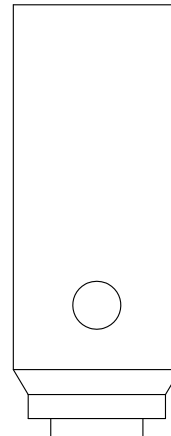

O.D.: 0.875"

623401

# BARRELS

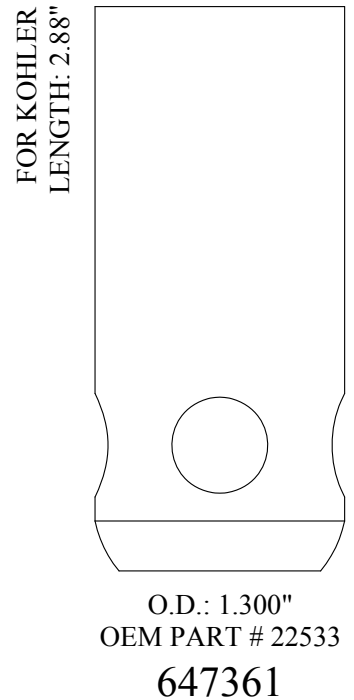
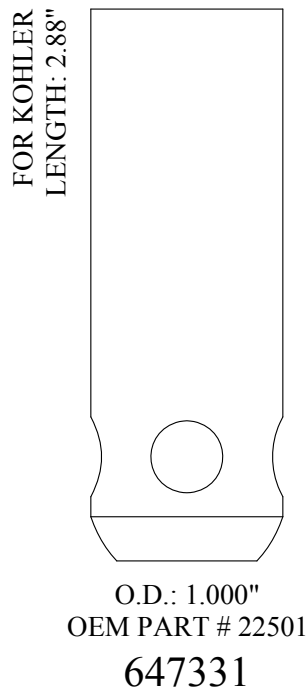
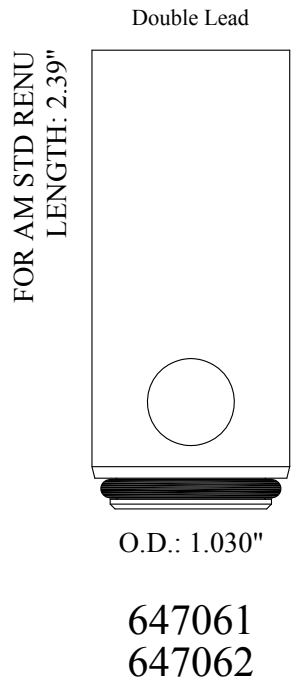
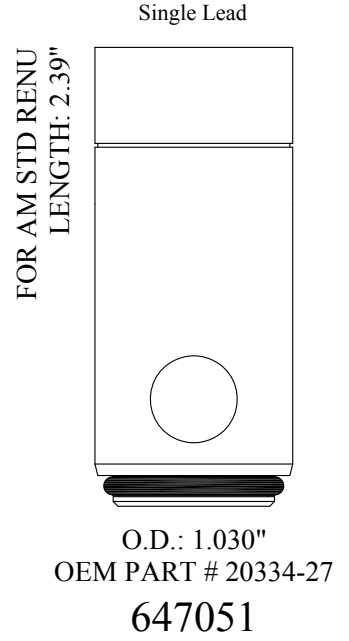
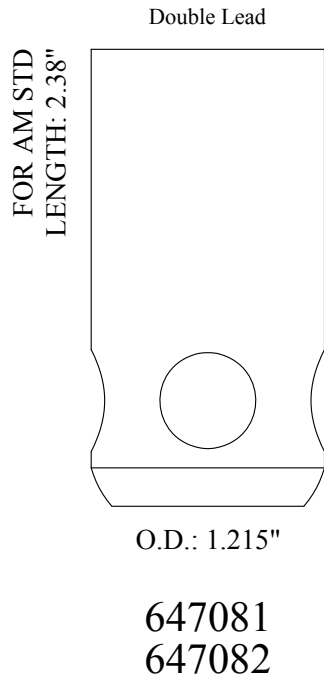
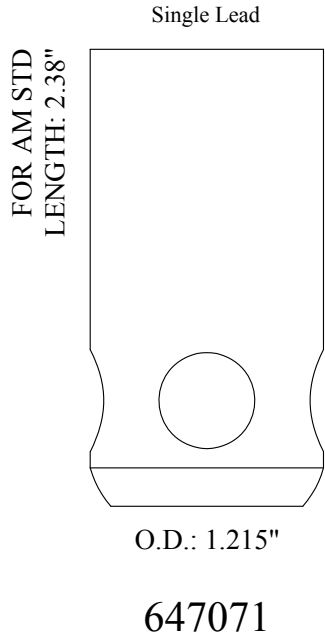

***Send Your Orders To:***

BARRY E.  SR. CO.

***E-mail: [orderdesk@barrywalter.com](mailto:orderdesk@barrywalter.com)***

***Fax: 1.800.886.9831***

***Phone: 1.800.767.5552***

BARRY E.  WALTER SR. CO.

STEM EXTENSIONS,  
STEM EXTENSION KITS &  
HANDLE ADAPTERS

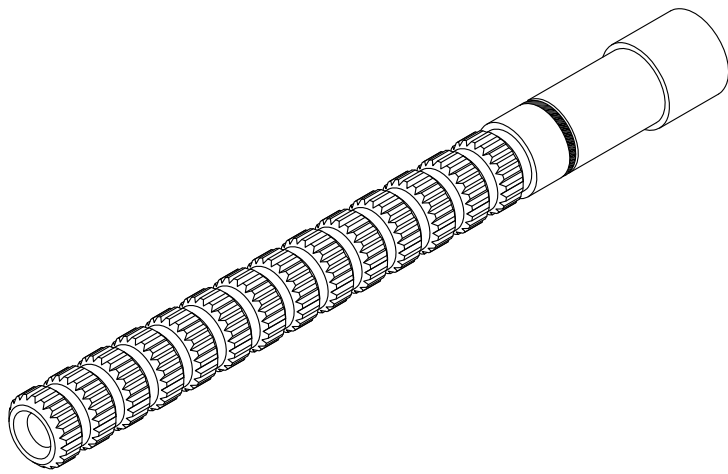

# STEM EXTENSIONS & HANDLE ADAPTERS

FOR SPEAKMAN  
PLASTIC PART

20

2-4

3-14

105740

FOR SPEAKMAN  
NICKEL PLATED

20

Speakman  
9/16

2-4

05-1409

FOR GLACIER BAY  
SOLID BRASS

20

109750

FOR SPEAKMAN  
NICKEL PLATED

20

2-4

05-1423

FOR SPEAKMAN  
NICKEL PLATED

20

3-14

05-1641

FOR CONCINITY

16

1-6

20

3-20

152430

FOR KOHLER  
SOLID BRASS

19

1-7

20

3-20

121230

FOR SYMMONS  
SOLID BRASS

12

Symmons  
Small

122240

FOR SYMMONS  
SOLID BRASS

12

Symmons  
Small

109640

American  
Standard  
Azimuth

FOR AM STD

34

18

3-30

106810

Also available as a kit  
with handle screw

140370

FOR AM STD

Part# 899240  
Screw Only

18

3-30

140300

FOR DORNBRACHT  
PLASTIC PART

20

3-32

20

3-20

103200

FOR AM STD  
PLASTIC PART

18

3-30

144240

FOR SINGLE LEVER

20

3-20

126020

FOR U/R

20

3-20

153690

FOR BROADWAY

20

2-4

16

1-6

167480

# STEM EXTENSIONS & HANDLE ADAPTERS

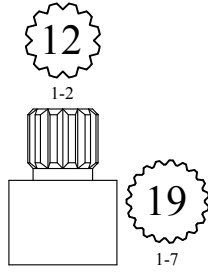

**118250**  
Fits KOHLER

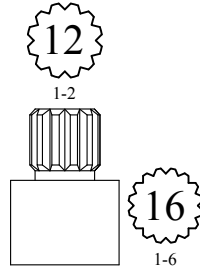

**171740**  
Fits CENTRAL

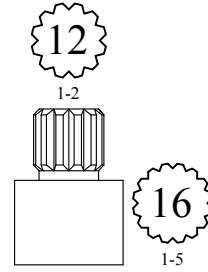

**172860**  
Fits STERLING

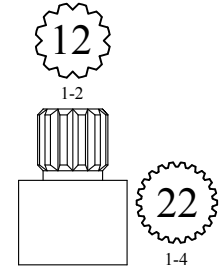

**172930**  
Fits AM STD

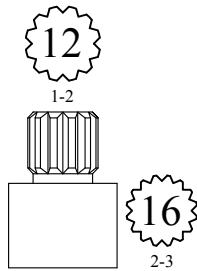

**173000**  
Fits SAYCO

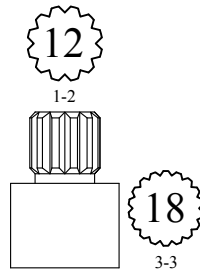

**173070**  
Fits BRIGGS

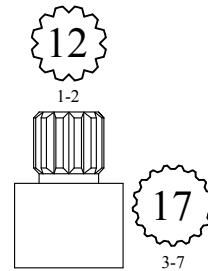

**173140**  
Fits AM BRASS / STREAMWAY

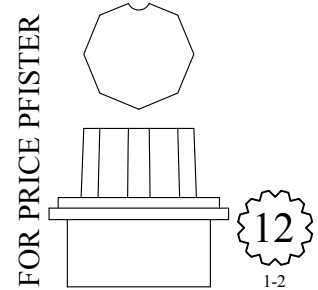

**106440**

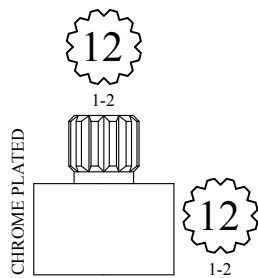

**175310**  
Fits PRICE PFISTER

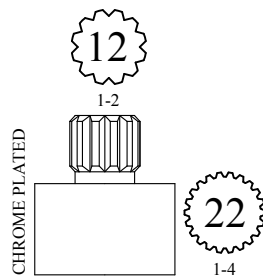

**175380**  
Fits AM STD

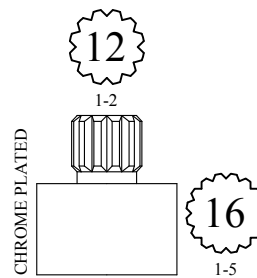

**175450**  
Fits STERLING

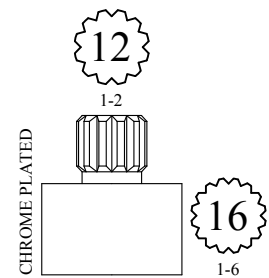

**175520**  
Fits CENTRAL

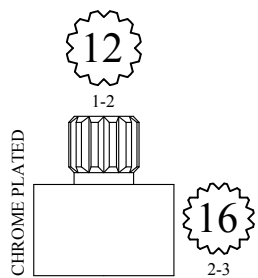

**175590**  
Fits SAYCO

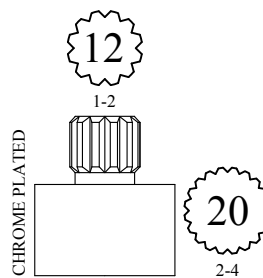

**175660**  
Fits SPEAKMAN

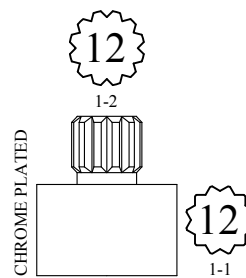

**175730**  
Fits CRANE

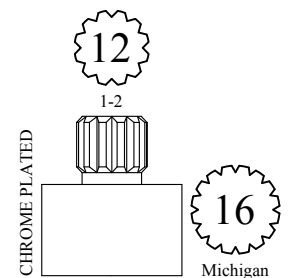

**175800**  
FIT-ALL  
Michigan



# STEM EXTENSIONS & HANDLE ADAPTERS

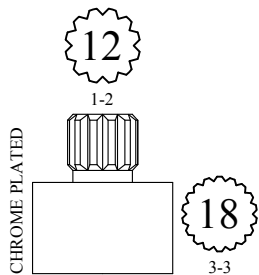

180920

Fits BRIGGS

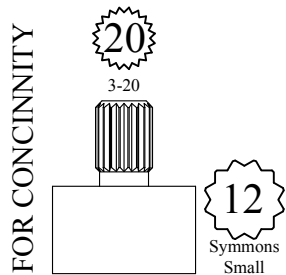

114490

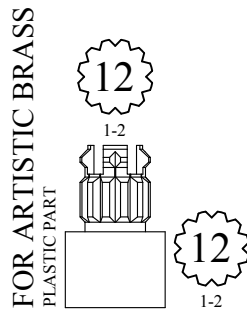

103150

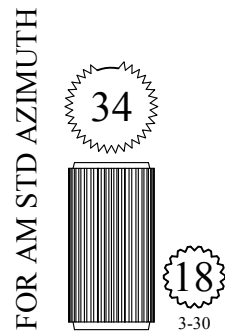

122030

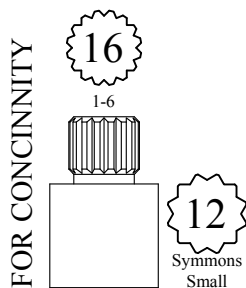

105130

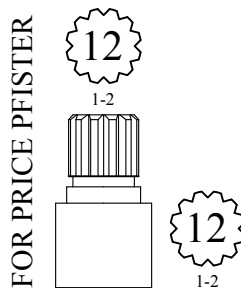

186380

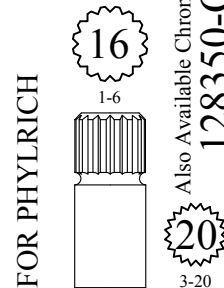

128350

Also Available Chrome Plated  
128350-CP  
Also Available Polished Brass  
128350-PB

Also available as a kit  
with handle screw

140510

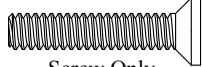

Screw Only  
Part# 899300

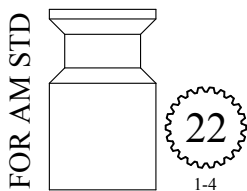

140440



133040

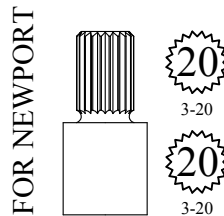

135820

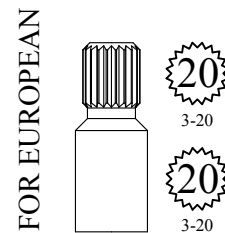

118760

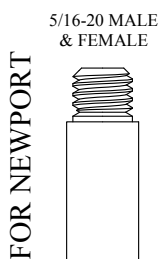

144380

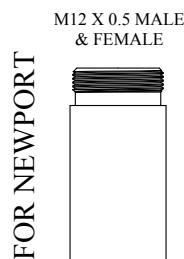

144450

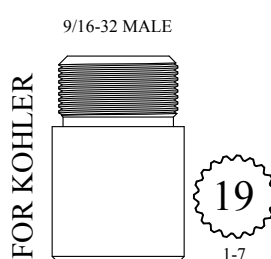

131480

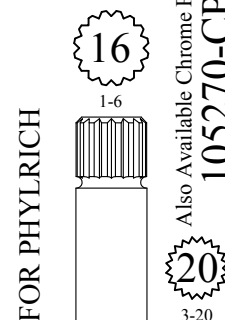

105270

Also Available Chrome Plated  
105270-CP  
Also Available Polished Brass  
105270-PB

# STEM EXTENSIONS & HANDLE ADAPTERS

FOR KOHLER

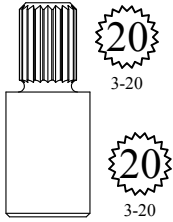

20  
3-20

20  
3-20

135000

FOR GLACIER BAY  
CHROME PLATED

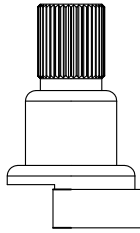

38  
3-21

FOR 115660 (HOT)

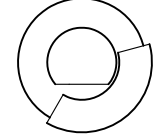

FOR 115670 (COLD)

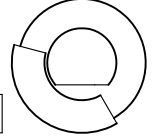

115660  
115670

M4 x 0.7 MALE  
& FEMALE

FOR ROHL

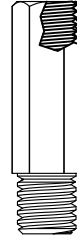

230850-2

FOR PHYLRICH

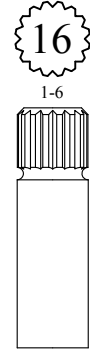

16  
1-6

Also Available Chrome Plated  
105340-CP

Also Available Polished Brass  
105340-PB

20  
3-20

105340

FOR ELJER

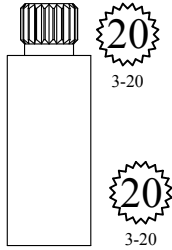

20  
3-20

20  
3-20

113090

FOR PRICE PFISTER

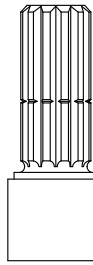

12  
1-2

12  
1-2

125480

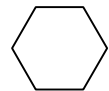
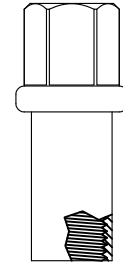

1/4 - 20

113160

Also available as a kit  
with handle screw

140720

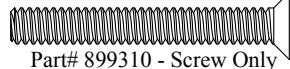

Part# 899310 - Screw Only

FOR PRICE PFISTER  
NICKEL PLATED

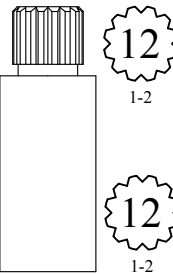

12  
1-2

12  
1-2

645510

FOR CENTRAL

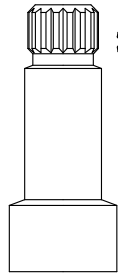

16  
1-6

16  
1-6

149980

FOR AM STD

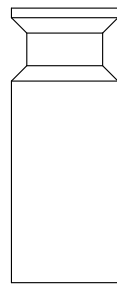

22  
1-4

140580

FOR PHYLRICH

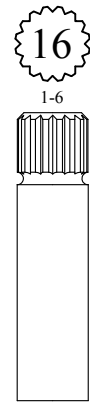

16  
1-6

Also Available Chrome Plated  
121860-CP

Also Available Polished Brass  
121860-PB

20  
3-20

121860

# STEM EXTENSIONS & HANDLE ADAPTERS

FOR SYMMONS

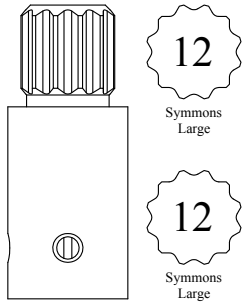

113840

FOR ULTRA MIX

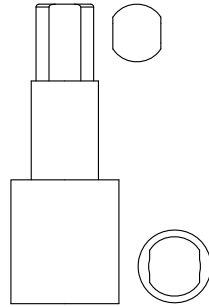

198110

FOR PHYLRICH

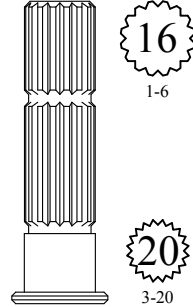

116750

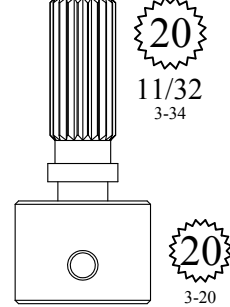

140410

FOR KALISTA

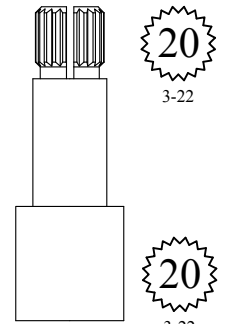

108980

FOR SYSTEM

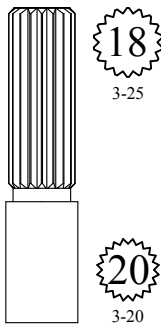

160120

FOR ELJER

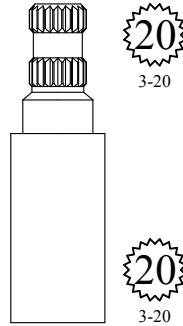

129140

FOR SYMMONS

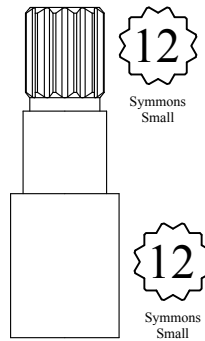

102290

FOR MOEN

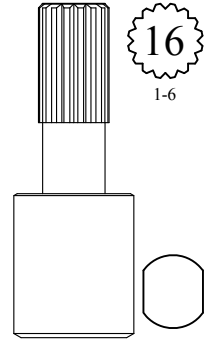

168870

FOR ALTMANS

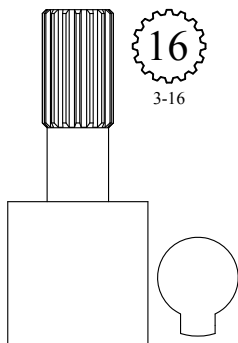

177200

FOR JADO

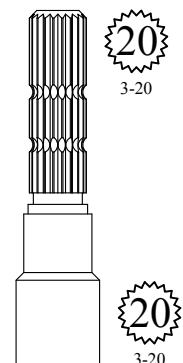

103570

FOR CIFIAL

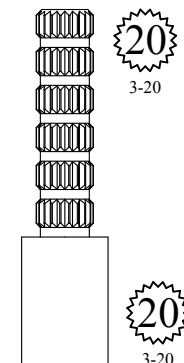

156280

FOR PHYLRICH

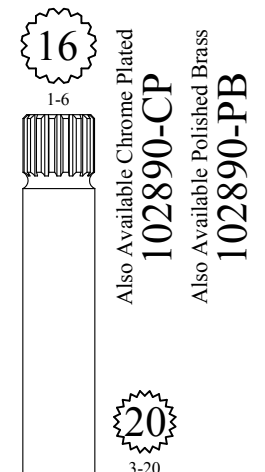

102890

# STEM EXTENSIONS & HANDLE ADAPTERS

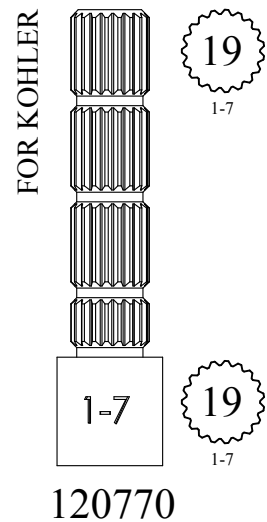
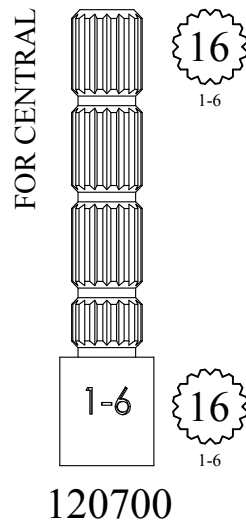
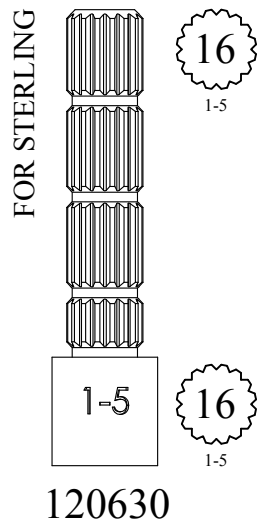
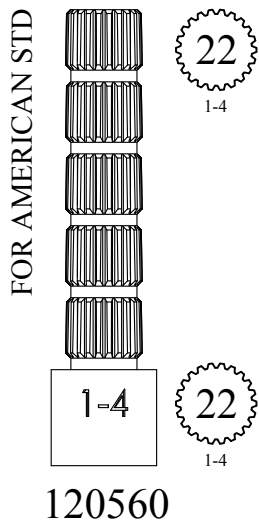
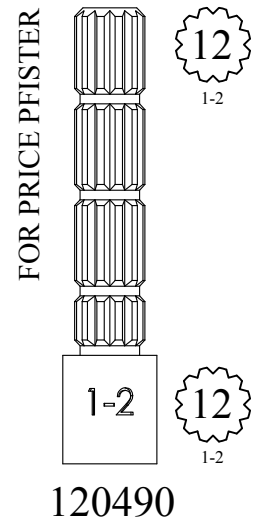
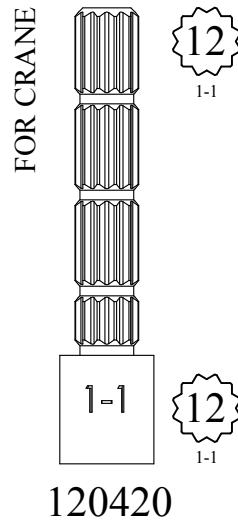
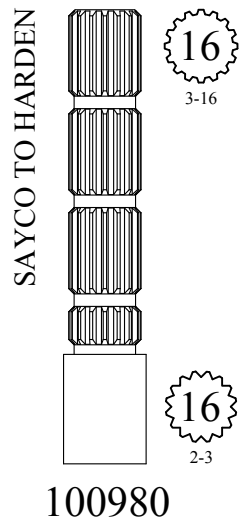
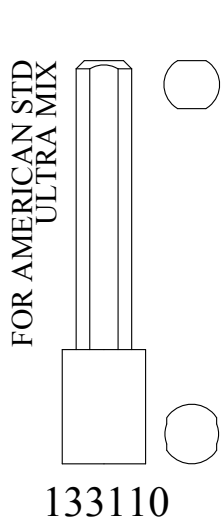
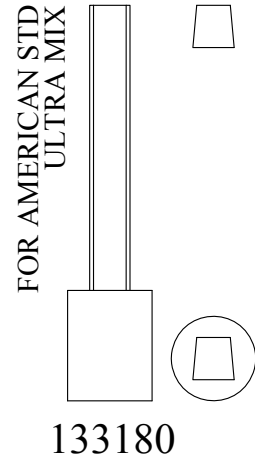
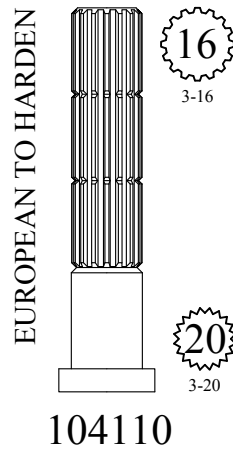
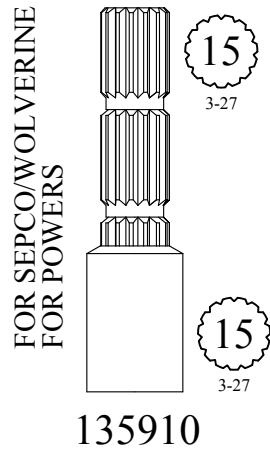
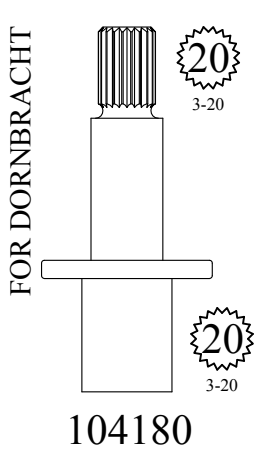

# STEM EXTENSIONS & HANDLE ADAPTERS

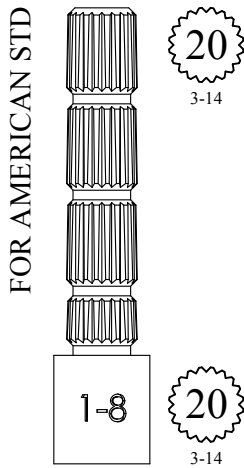

120840

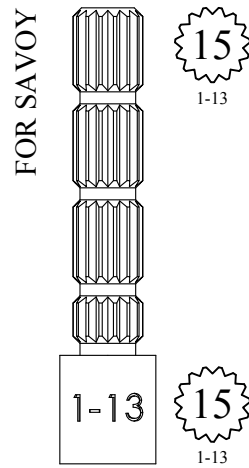

120910

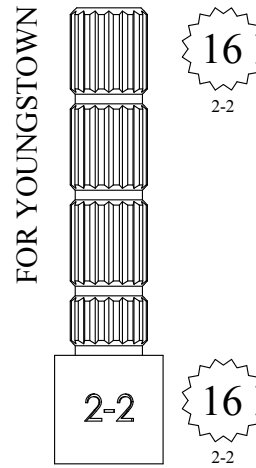

120980

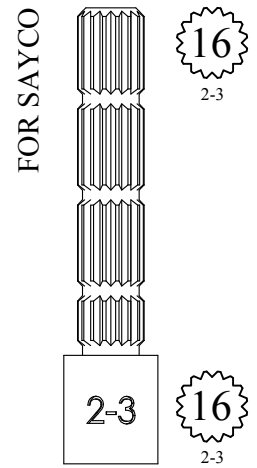

121050

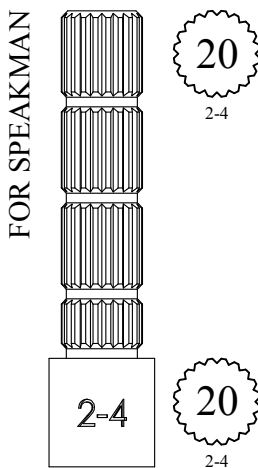

121120

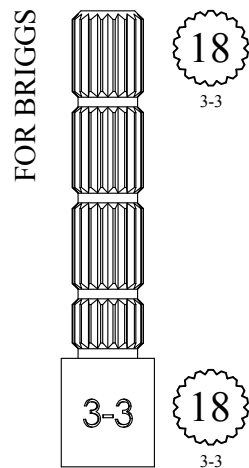

121190

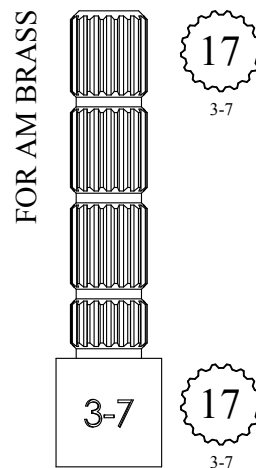

121330

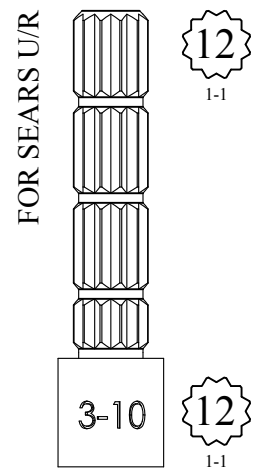

121400

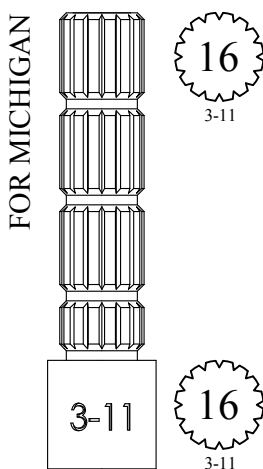

121470

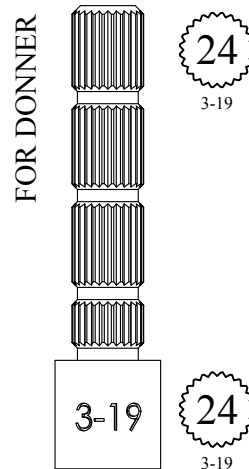

130890

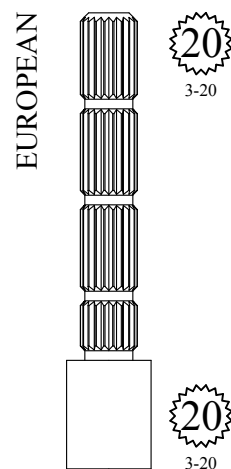

160400

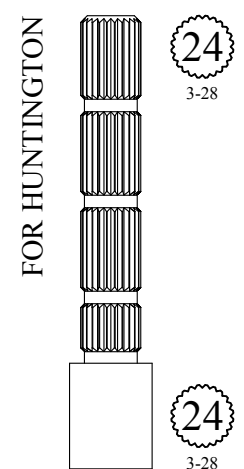

102240

# STEM EXTENSIONS & HANDLE ADAPTERS

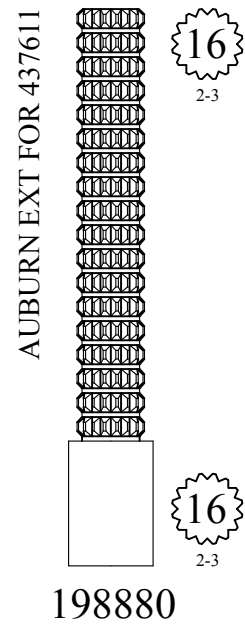
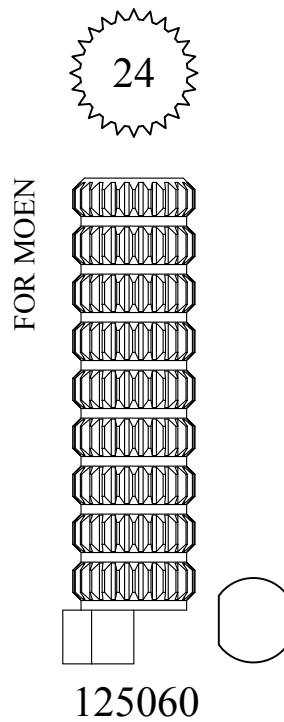
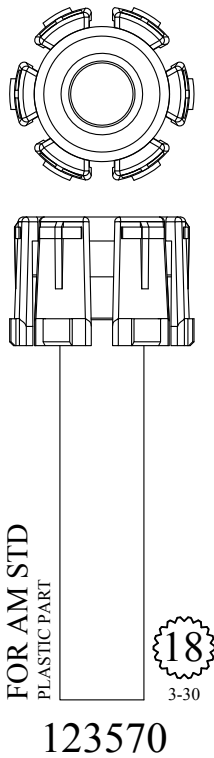
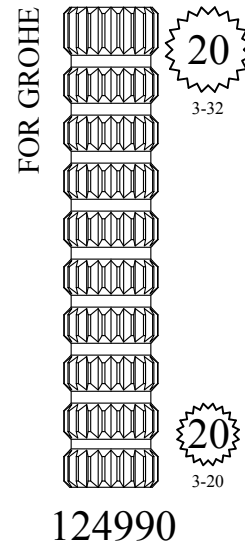
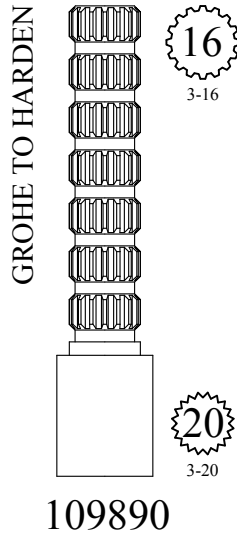
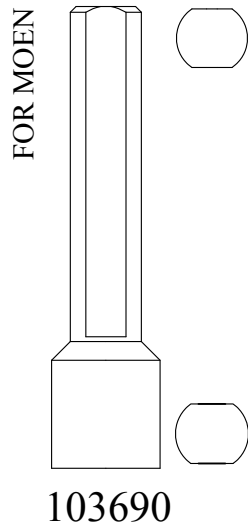

# STEM EXTENSIONS & HANDLE ADAPTERS

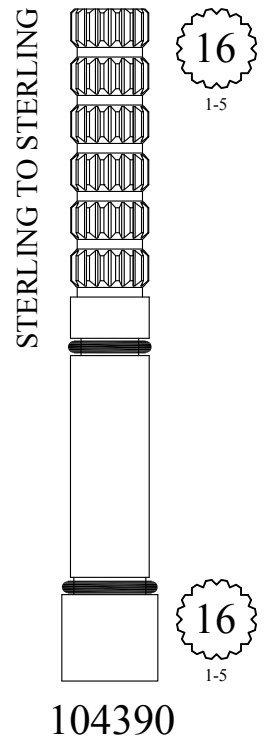
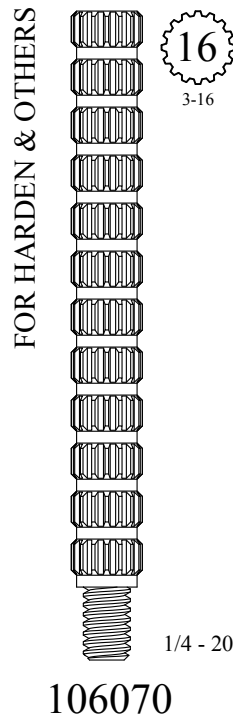
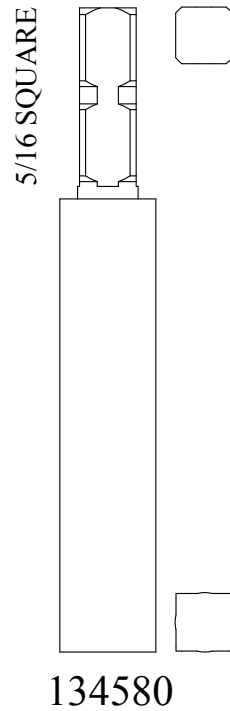
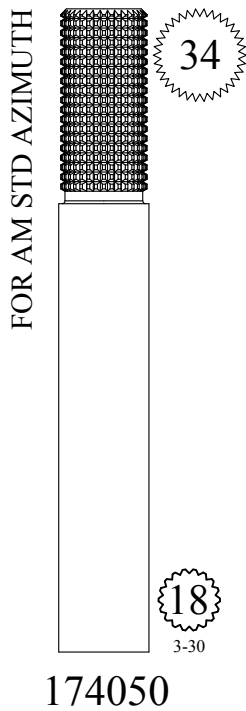
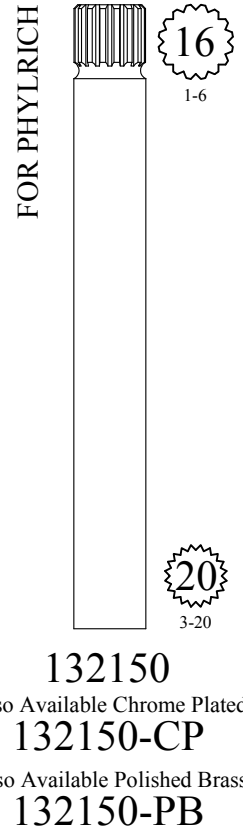
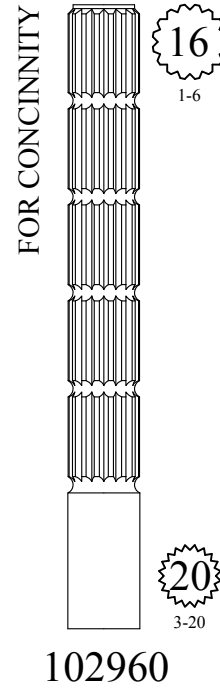
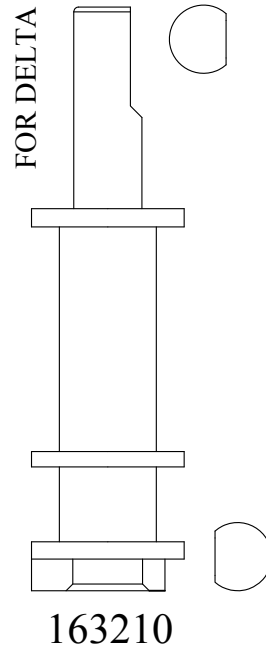
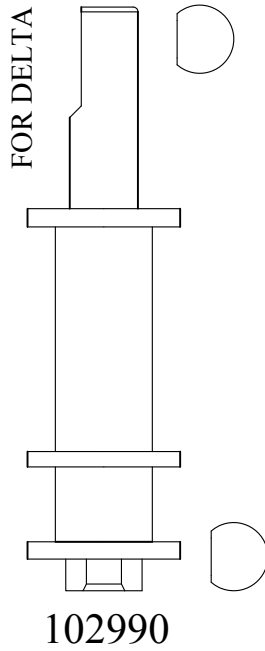

# STEM EXTENSIONS & HANDLE ADAPTERS

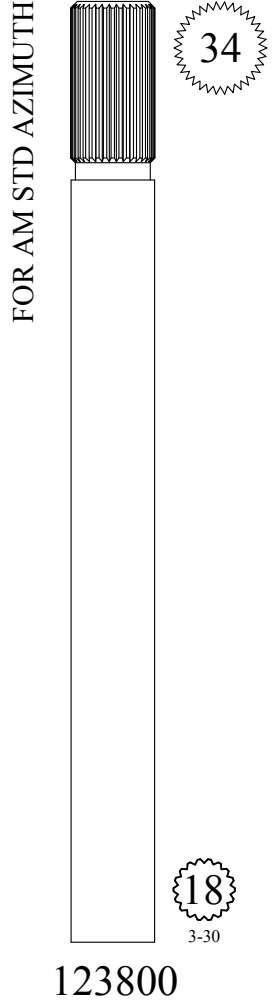
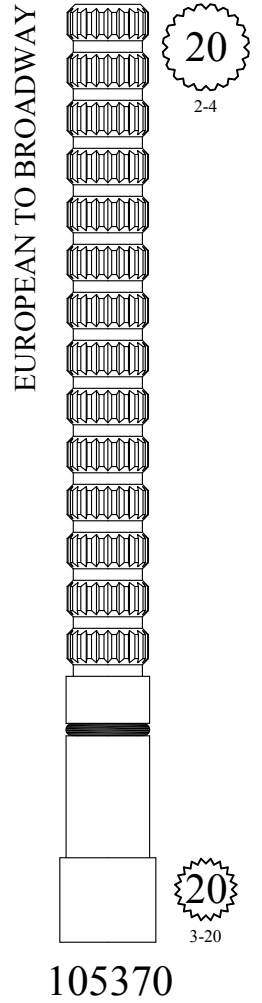
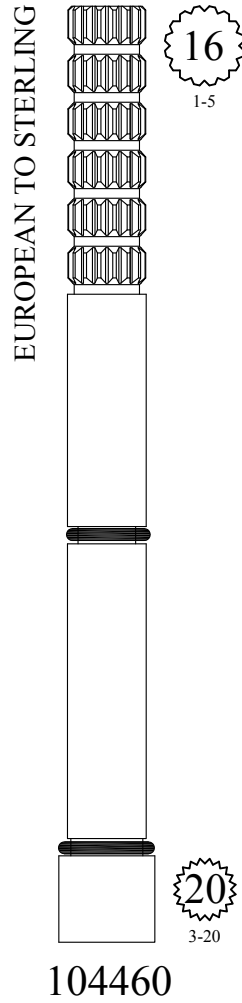
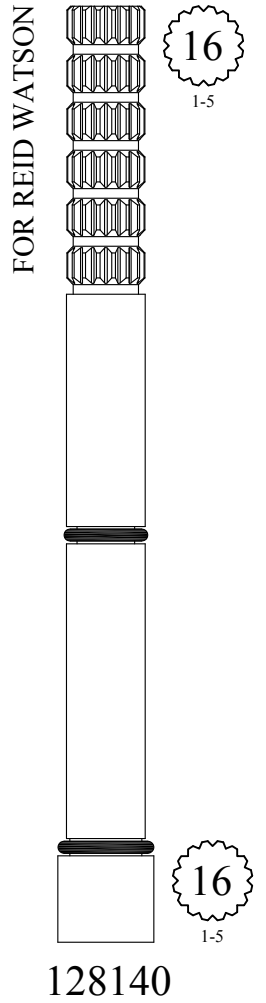
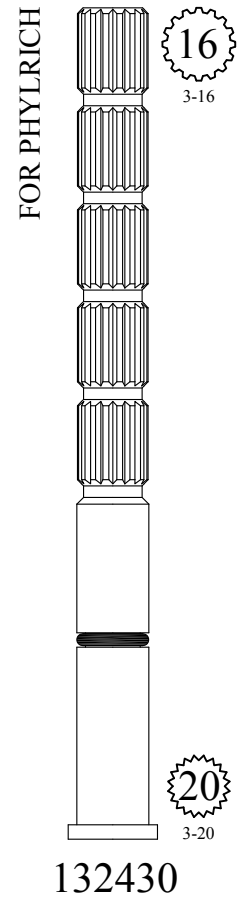
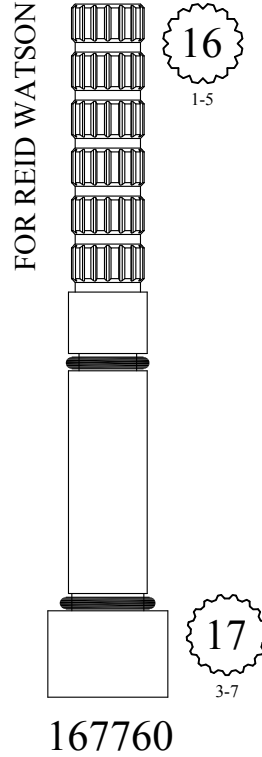
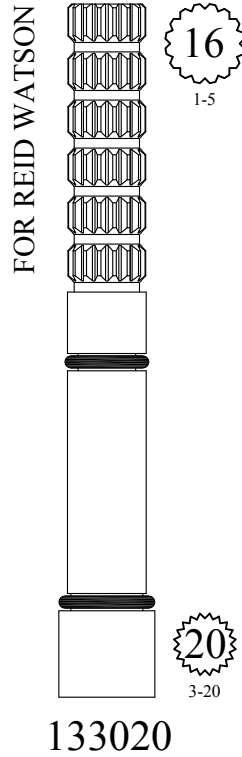
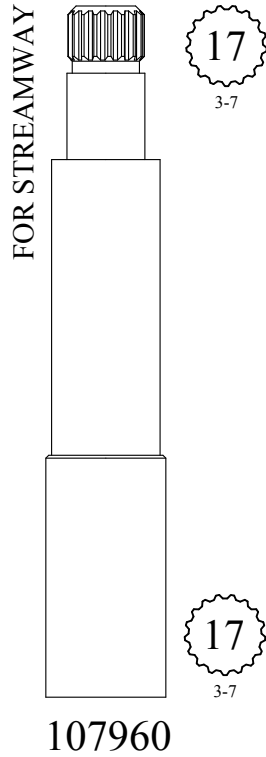



# STEM EXTENSIONS & HANDLE ADAPTERS

EUROPEAN TO GERBER

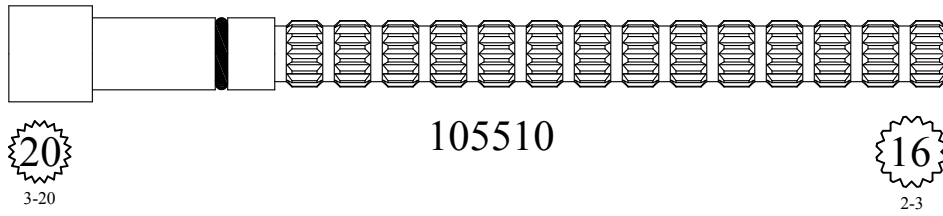

EUROPEAN TO HARDEN

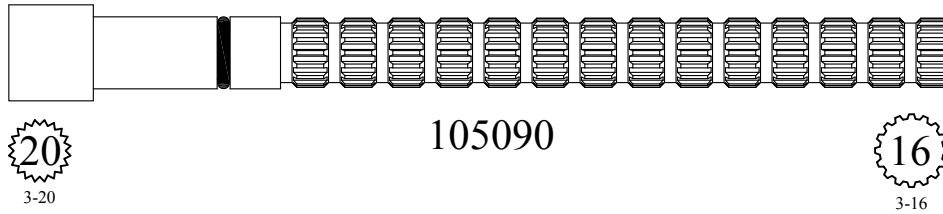

EUROPEAN TO EUROPEAN

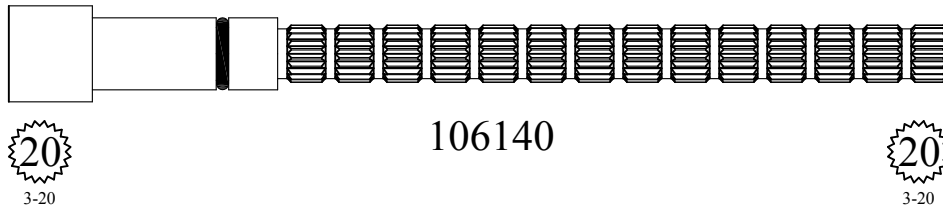

EUROPEAN TO PRICE PFISTER

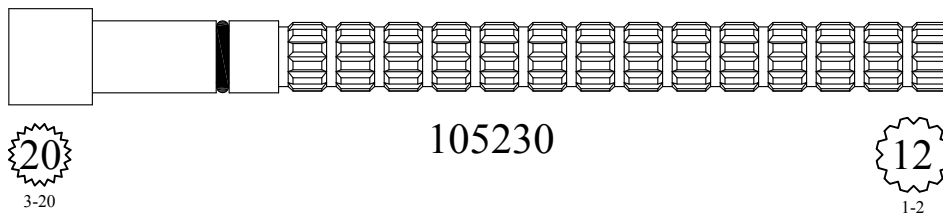

HARDEN BROACH

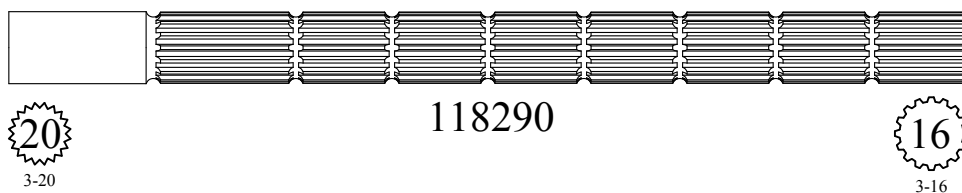

CENTRAL BRASS BROACH

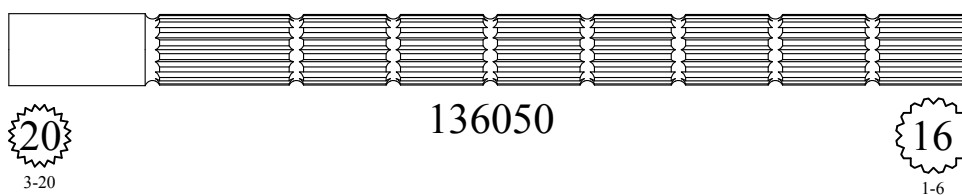

# STEM EXTENSION KITS

FOR AM STD AZIMUTH

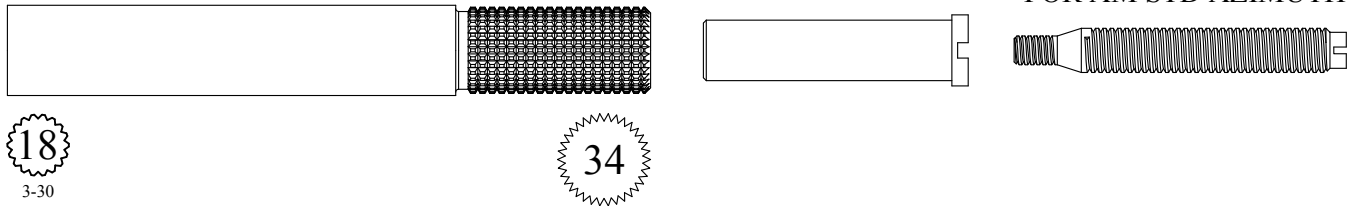

173350

FOR AM STD



123710

FOR AM STD AZIMUTH

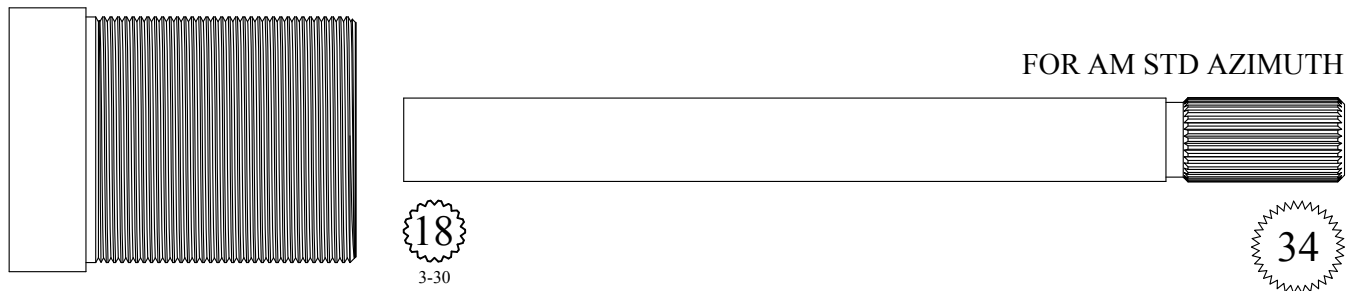

123780

BARRY E.  WALTER SR. CO.

# STEM EXTENSION KITS

FOR AM STD ULTRA-MIX  
WITH VOLUME CONTROL STEM

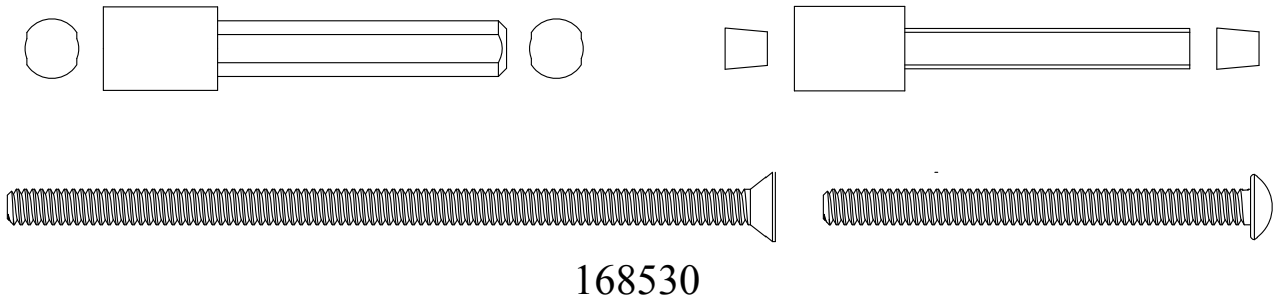

FOR AM STD ULTRA MIX  
LESS VOLUME CONTROL STEM

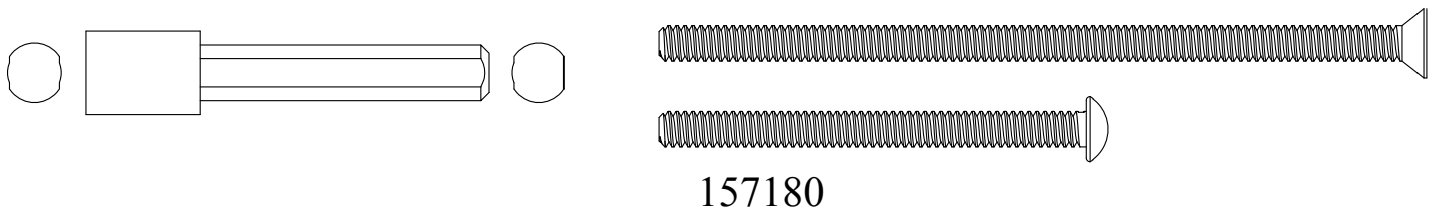

FOR CENTRAL

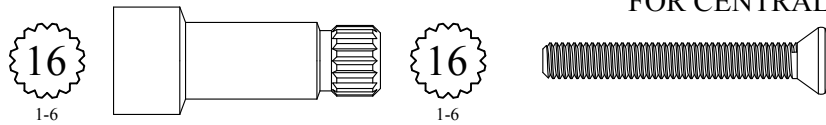

Part numbers 156140 and 156280 used together to make one  
handle adapter

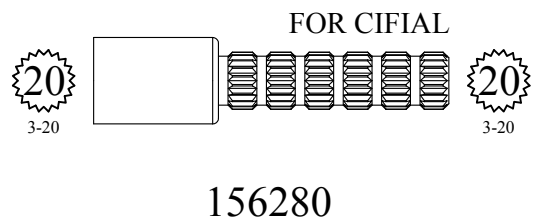
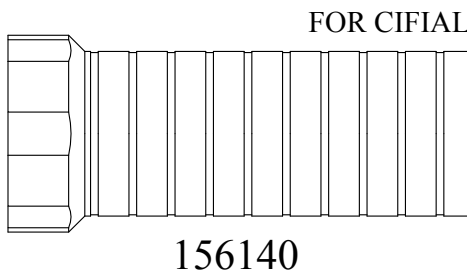

# STEM EXTENSION KITS

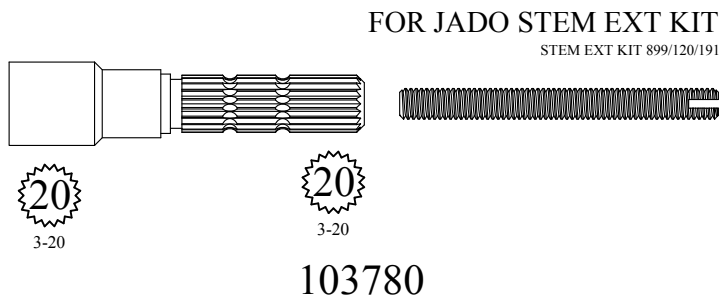
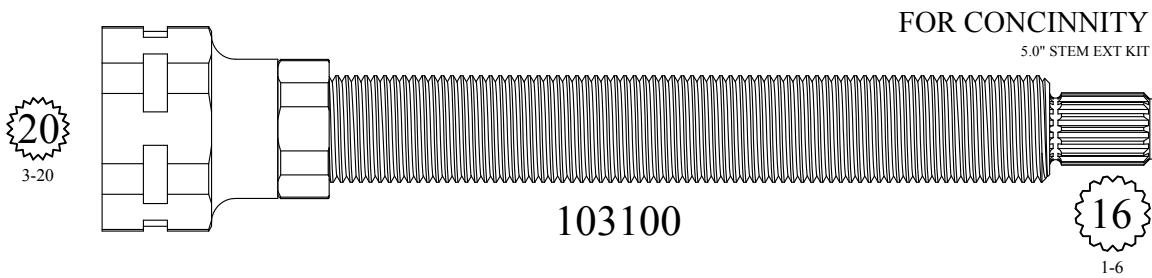
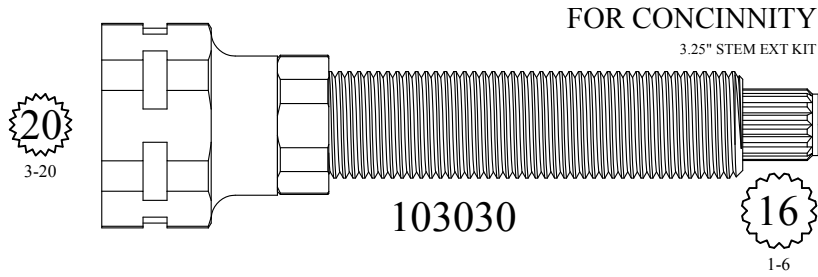

BARRY E.  WALTER  SR. CO.

# STEM EXTENSION KITS

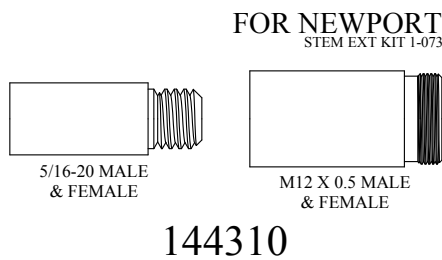
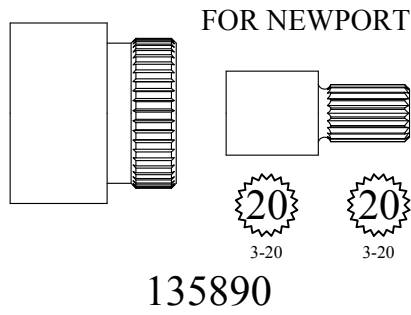
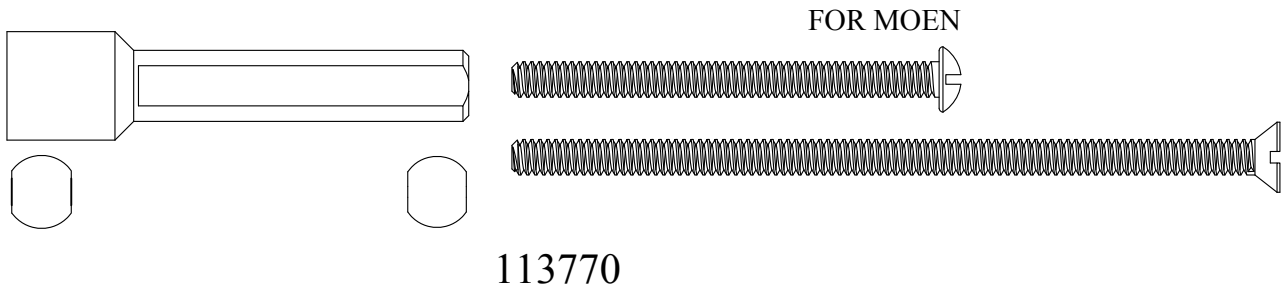

BARRY E.  ALTER SR. CO.

# STEM EXTENSION KITS

FOR PRICE PFISTER  
STEM EXT W/SCREW ADAPTER

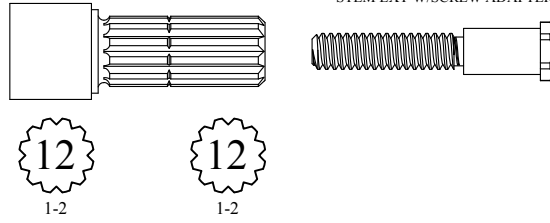

129050

FOR PRICE PFISTER  
STEM EXT KIT 910-007  
FOR CERAMIC UNIT

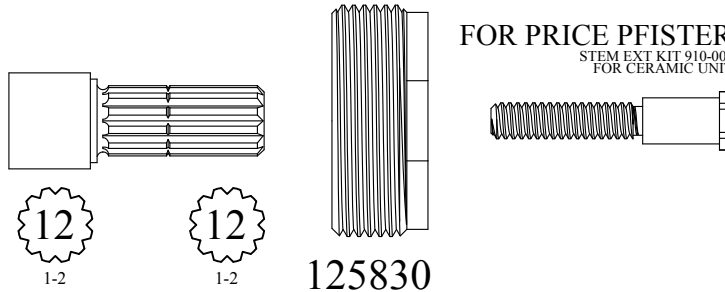

125830

FOR PRICE PFISTER  
STEM EXT KIT 910-682

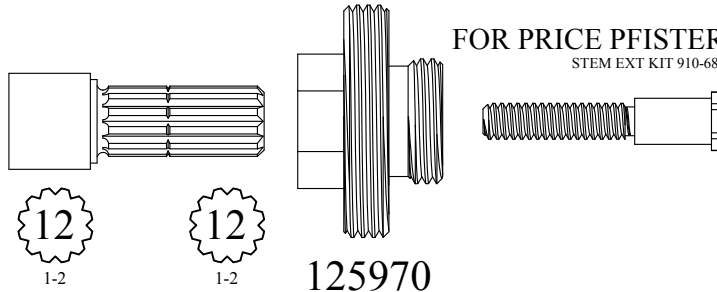

125970

FOR PRICE PFISTER  
STEM EXT KIT 910-561

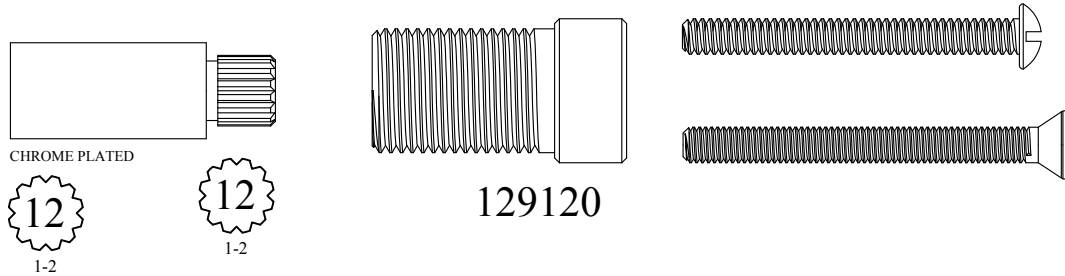

129120

FOR PRICE PFISTER

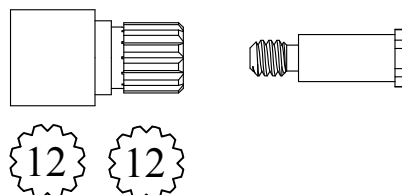

186310

# STEM EXTENSION KITS

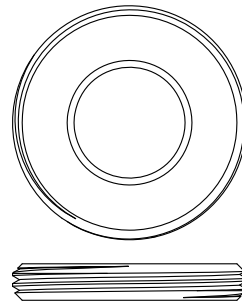
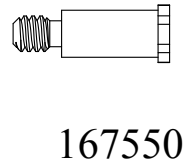
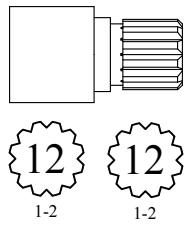

FOR PRICE PFISTER

167550

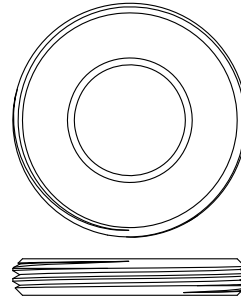
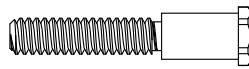
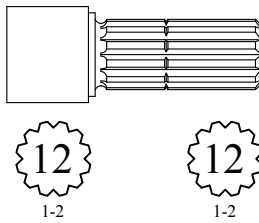

FOR PRICE PFISTER

167620

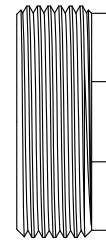
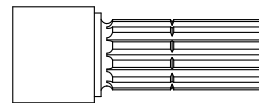
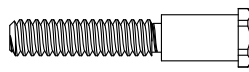
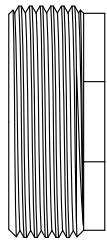
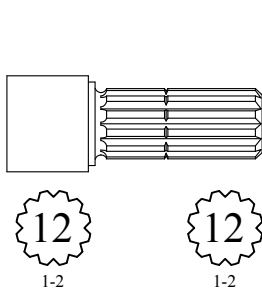

FOR PRICE PFISTER

910-007  
2X 125830

2X

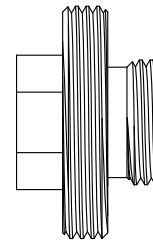
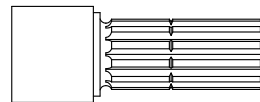
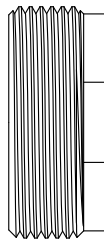
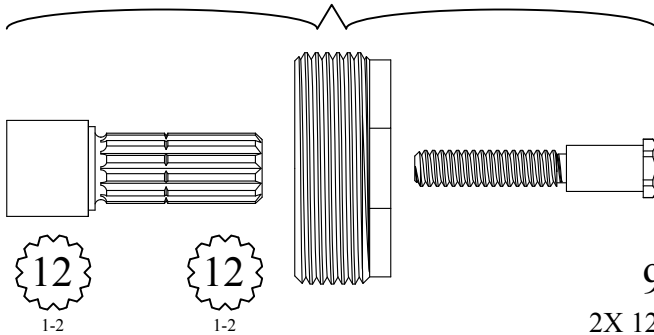

FOR PRICE PFISTER

910-005  
2X 125830 & 125970

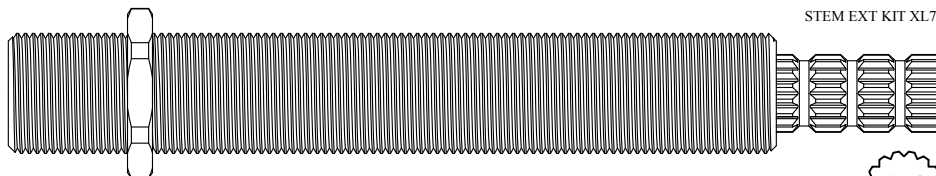

FOR REID WATSON  
STEM EXT KIT XL78



128280

*Send Your Orders To:*

BARRY E.  SR. CO.

*E-mail: [orderdesk@barrywalter.com](mailto:orderdesk@barrywalter.com)*

*Fax: 1.800.886.9831*

*Phone: 1.800.767.5552*



*Quality Replacement Parts*

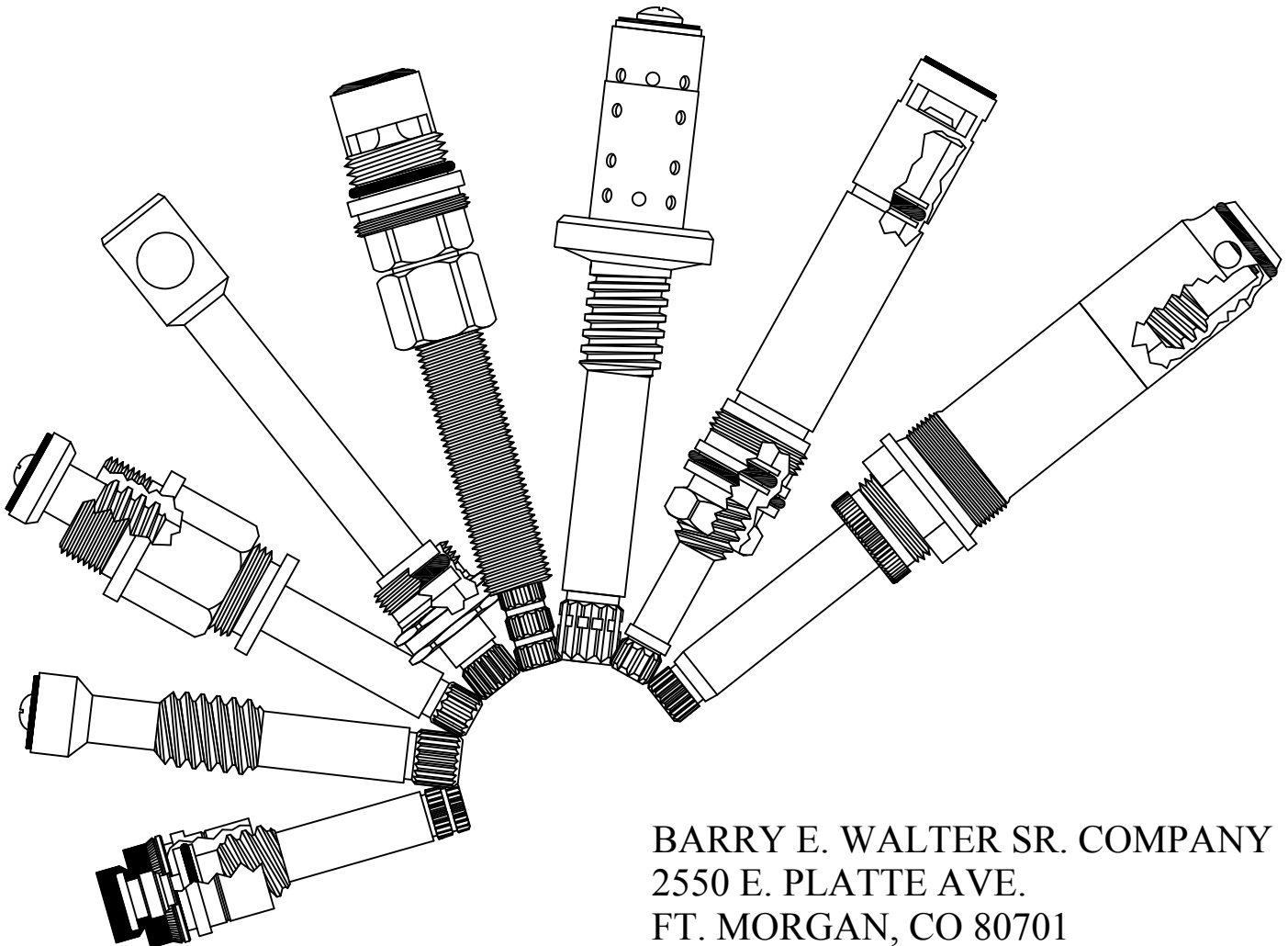

BARRY E. WALTER SR. COMPANY  
2550 E. PLATTE AVE.  
FT. MORGAN, CO 80701



# HANDLE ADAPTERS FOR FIT-ALL HANDLES

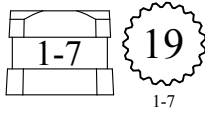

**139550**  
Fits KOHLER

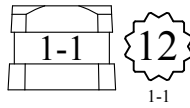

**140670**  
Fits CRANE-REPCAL

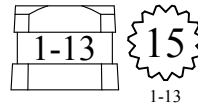

**140740**  
Fits SAVOY

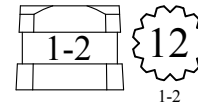

**141020**  
Fits PRICE PFISTER

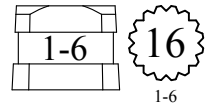

**141300**  
Fits CENTRAL

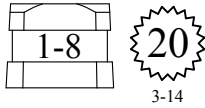

**141650**  
Fits AM STD 3/8"

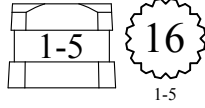

**142000**  
Fits STERLING

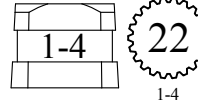

**142140**  
Fits AM STD 7/16"

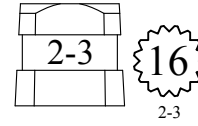

**140880**  
Fits SAYCO

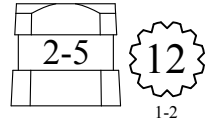

**141160**  
Fits PRICE PFISTER

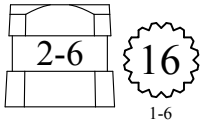

**141370**  
Fits CENTRAL

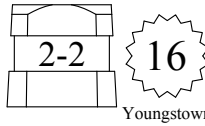

**142210**  
Fits YOUNGSTOWN

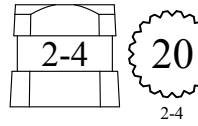

**142280**  
Fits SPEAKMAN

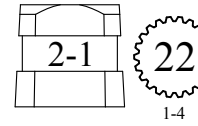

**176920**  
Fits AM STD 7/16"

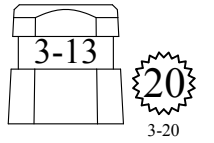

**109360**  
Fits 20pt European

Same as 116710  
w/ 4 set screws

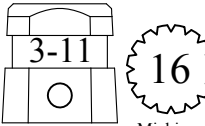

**110060**  
FIT-ALL

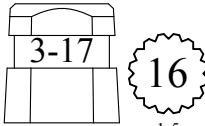

**116570**  
Fits STERLING

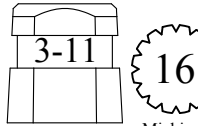

**116710**  
Fits MICHIGAN / STERLING

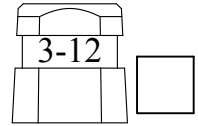

**116780**  
Fits CHICAGO

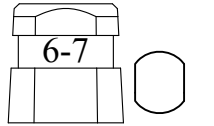

**128070**  
Fits UNIVERSAL RUNDLE

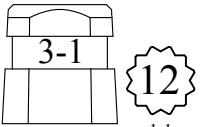

**140810**  
Fits CRANE-REPCAL

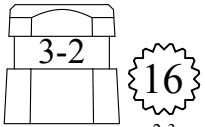

**140950**  
Fits SAYCO

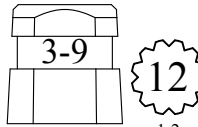

**141230**  
Fits PRICE PFISTER

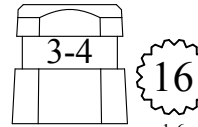

**141510**  
Fits CENTRAL

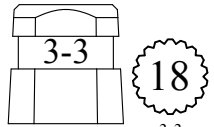

**141580**  
Fits BRIGGS

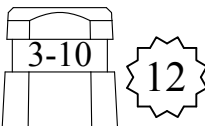

**141720**  
Fits SEARS

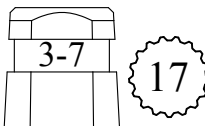

**142070**  
Fits AM BRASS / STREAMWAY

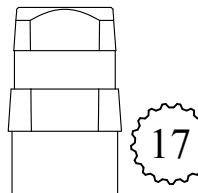

**135610**  
Fits AM BRASS / STREAMWAY

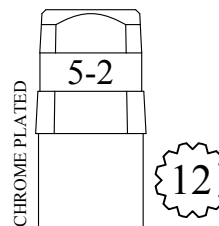

**116500**  
Fits CRANE

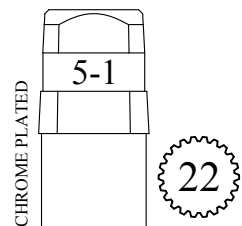

**116640**  
Fits AM STD

# PORCELAIN HANDLE ADAPTERS

These solid brass inserts convert the OEM or Walter Equivalent Porcelain handles to the stem listed below the part number

For Price Pfister style replacement handles  
See pg.148

These adapters are also listed on pg.148

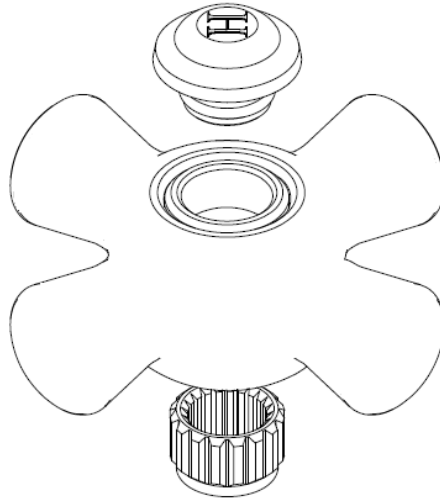

External  
18

Internal

122420  
Fits DELTA

External  
18

Internal  
22  
1-4

129680  
Fits AM STD

External  
18

Internal  
15  
1-13

135120  
Fits SAVOY

External  
18

Internal  
18  
3-3

137990  
Fits BRIGGS

External  
18

Internal  
16  
1-6

138060  
Fits CENTRAL

External  
18

Internal  
19  
1-7

138130  
Fits KOHLER

External  
18

Internal  
15  
3-27

138270  
Fits WOLVERINE

External  
18

Internal  
20  
2-4

139320  
Fits SPEAKMAN

External  
18

Internal  
20  
3-20

139390  
Fits 20pt European

External  
18

Internal  
16  
2-3

141000  
Fits SAYCO

External  
18

Internal  
12  
1-1

141070  
Fits CRANE DIALEZE

External  
18

Internal  
16  
1-5

141140  
Fits STERLING

External  
18

Internal  
12  
3-10

141280  
Fits CRANE / UR

# PORCELAIN HANDLE ADAPTERS

These inserts adapt to the OEM stem listed below the part number, and attaches with a set screw

For Price Pfister style replacement handles  
See pg.148

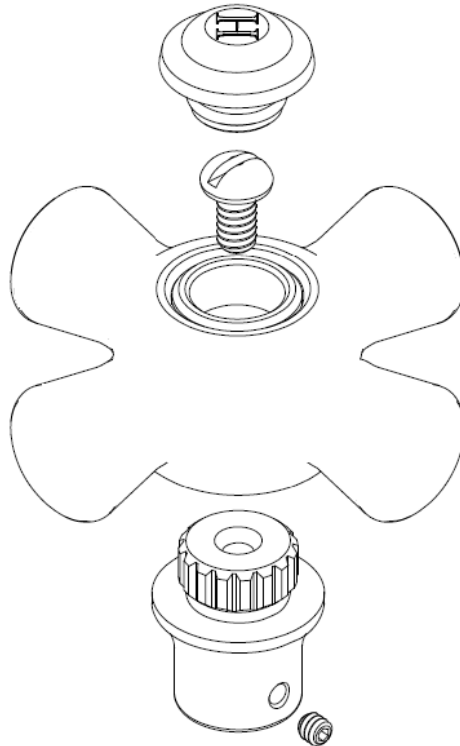

These adapters are also listed on pg.149

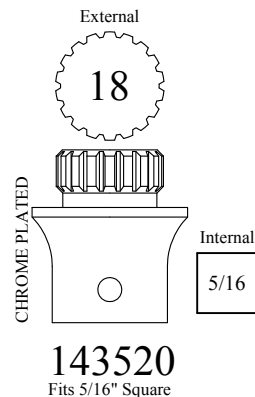
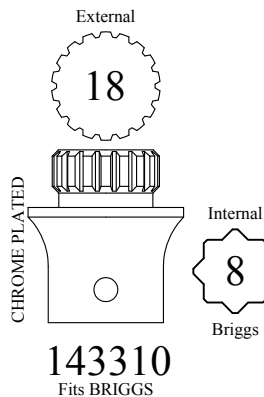
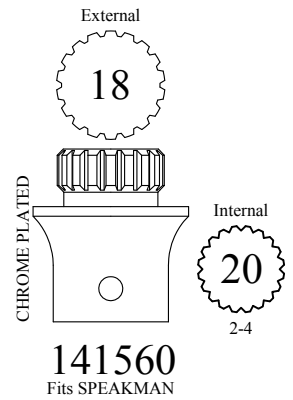
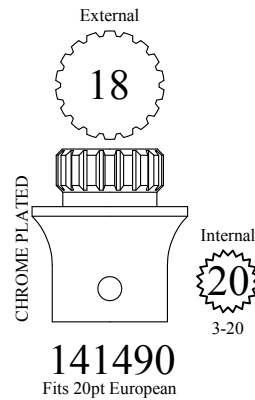
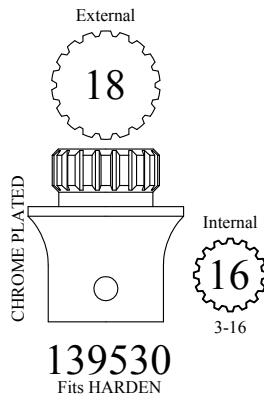
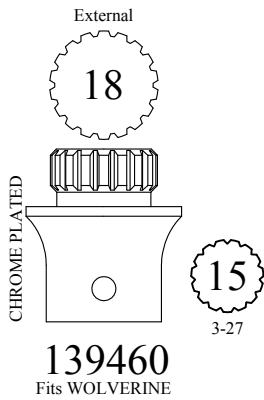

# PORCELAIN HANDLE ADAPTERS

These inserts adapt to the OEM stem listed below the part number.

Does not use a set screw. Comes with appropriate long screw.

For Price Pfister style replacement handles  
**See pg.148**

These adapters are also displayed on pg.149

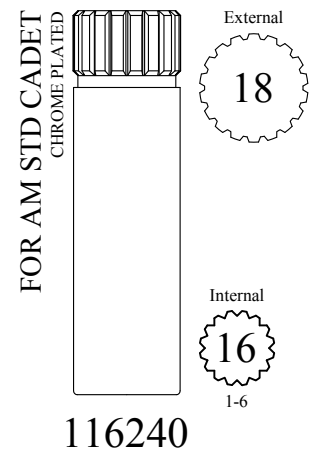
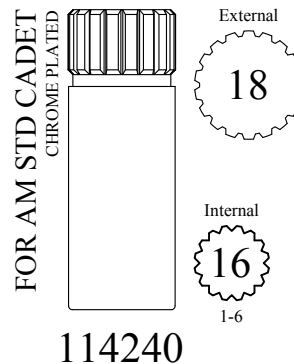
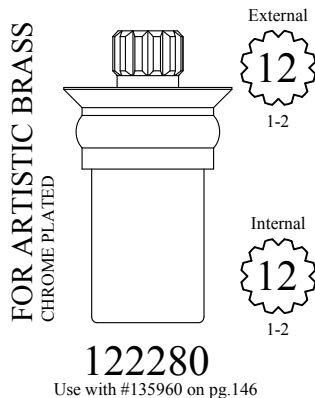
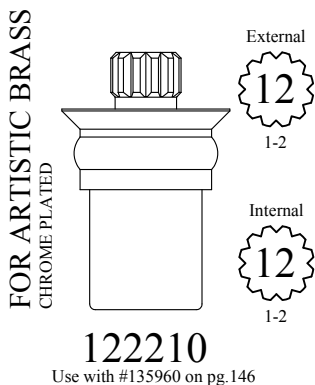
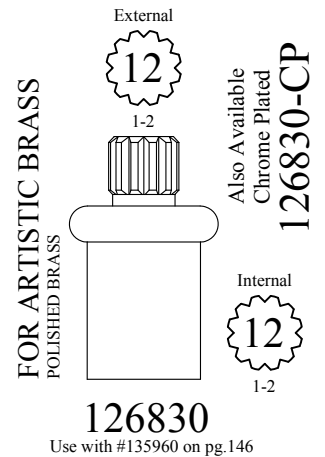
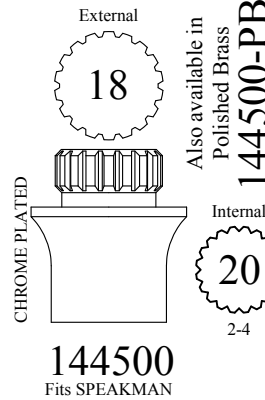
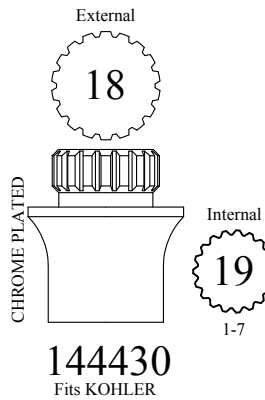
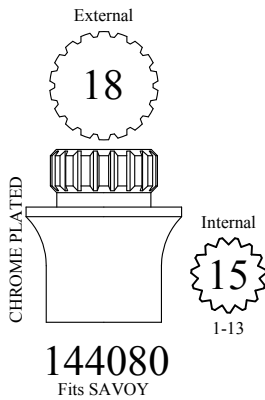
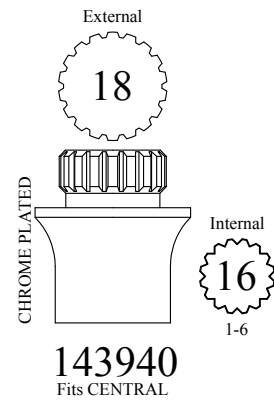
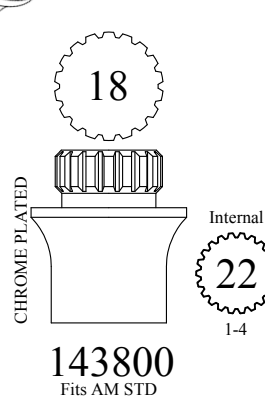
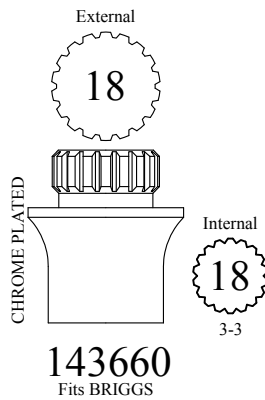
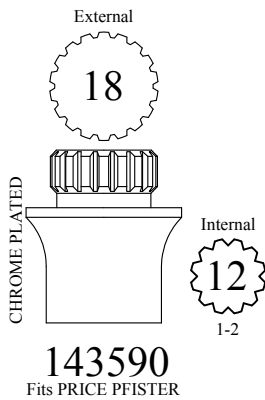
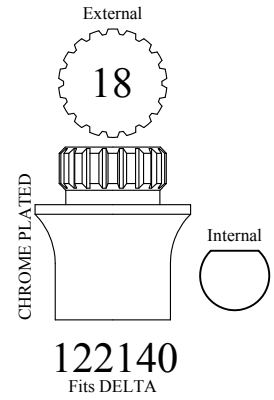
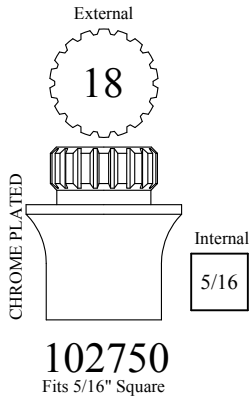
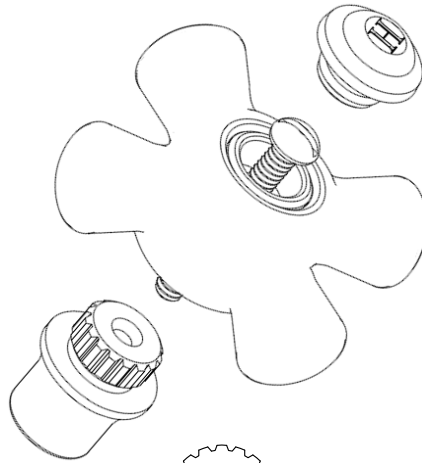

BARRY E.  WALTER SR. CO.

# HANDLES



# HOT & COLD INDEXED PORCELAIN HANDLES



Indexed Handle shown to the left attaches with a set screw

HOT	COLD	DIVERTER	FITS
101210	101280	126410	American Standard 7/16 22pt
101350	101420	125710	5/16 Square
102450	102590	104600	European 20pt
147090	147230	125780	Crane Pre-War 12pt
147440	147510	125850	Briggs Republic 8pt
147580	147790	125920	Briggs 18pt
148280	148350	125990	Central / Harden 16pt
105020	105160	105300	Price Pfister 12pt

**\*For polished brass, add -PB to the end of the part number. i.e. 101210-PB**

2 DIFFERENT STYLES OF INDEXED HANDLES.  
CHOOSE WHAT WILL WORK WITH YOUR STEM.



Indexed Handles shown above attach with a handle nut

HOT	COLD	DIVERTER	FITS
101910	101980	126060	Speakman / Broadway 20pt
102050	102120	126130	Briggs 8pt
102190	102260	126200	Central / Harden 16pt
102330	102400	126270	Wolverine 15pt
102470	102540	126340	Savoy 15pt
110310	110380	104670	American Standard 22pt
110450	110520	104880	5/16 Square
128120	128190	128260	Kohler 19pt
148080	146130	146150	Price Pfister 12pt

**\*For polished brass, add -PB to the end of the part number. i.e. 101910-PB**

# PORCELAIN CROSS HANDLES

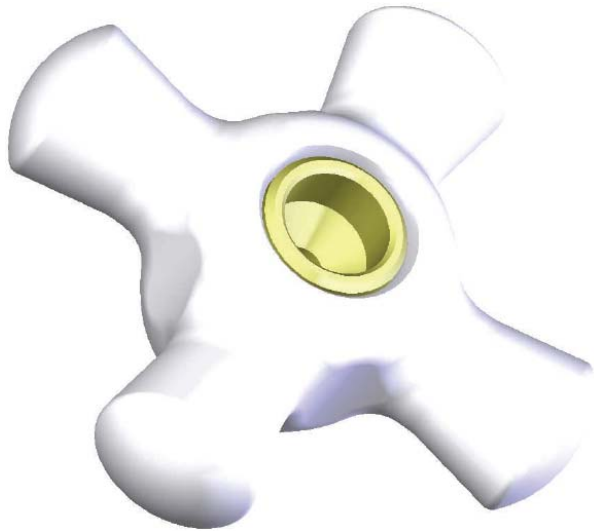

**Replacements for Price Pfister  
#940-985 / 986 and #940-980 / 981**

Large - # 138620  
Small - # 138550

Also Available:  
Large w/ 3/8 12pt Broach - # 138480  
Small w/ 3/8 12pt Broach - # 135960

**Replacement Porcelain  
buttons for Price Pfister  
#941-475, #941-476 and #941-477**

	<b>Chrome Plated</b>	<b>Polished Brass</b>
<b>Cold</b>	139670	139670-PB
<b>Hot</b>	139740	139740-PB
<b>Arrow</b>	139810	139810-PB



**Solid brass inserts convert the OEM or Walter  
Equivalent Porcelain handles for any of these stems:**

- # 122420 - Adapts to Delta 'D' broach
- # 129680 - Adapts to American Standard 7/16 22pt
- # 135120 - Adapts to Savoy 15pt
- # 137990 - Adapts to Briggs 18pt
- # 138060 - Adapts to Central / Harden 16pt
- # 138130 - Adapts to Kohler 19pt
- # 138270 - Adapts to Wolverine 15pt
- # 139320 - Adapts to Speakman 20pt
- # 139390 - Adapts to European 20pt
- # 141000 - Adapts to Sayco / Gerber 16pt
- # 141070 - Adapts to Crane Dial-Eze 12pt
- # 141140 - Adapts to Sterling 16pt
- # 141280 - Adapts to Crane / Universal Rundle 12pt

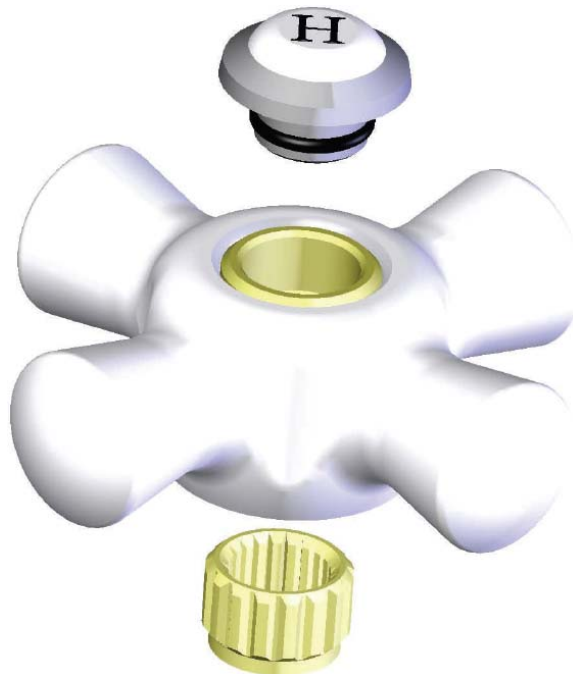

**These adapters are also  
pictured on pg.142**

**Use the basic Solid Brass insert to adapt to any of the  
listed broaches OR turn those handles into a classic  
look with the Old Style Chrome Plated inserts listed on  
the next page.**



# Old Style Chrome Plated Solid Brass Inserts for Porcelain Cross Handles

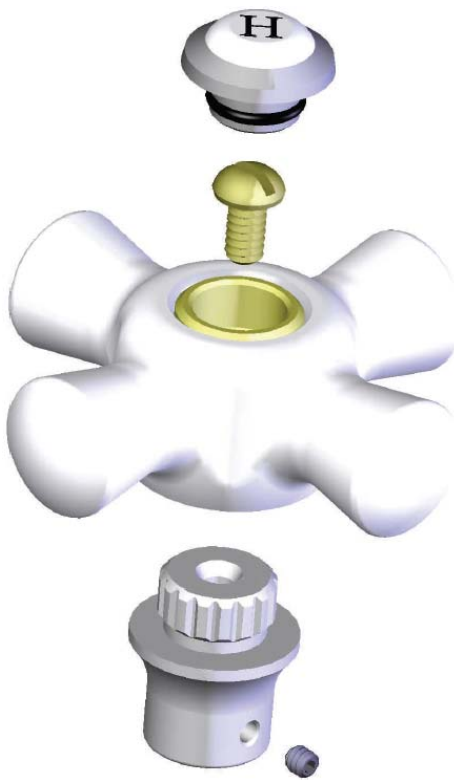

This insert adapts to OEM listed below and attaches with a set screw.

- # 139460 - Adapts to Wolverine 15pt
- # 139530 - Adapts to Harden 16pt
- # 141490 - Adapts to European 20pt
- # 141560 - Adapts to Speakman 20pt
- # 143310 - Adapts to Briggs Republic 8pt
- # 143520 - Adapts to 5/16 Square

**These adapters are also pictured on pg.143**

Exploded view with Old Style Insert, supplied with set screw to attach to the stem. A screw is supplied to attach the handle to the insert.

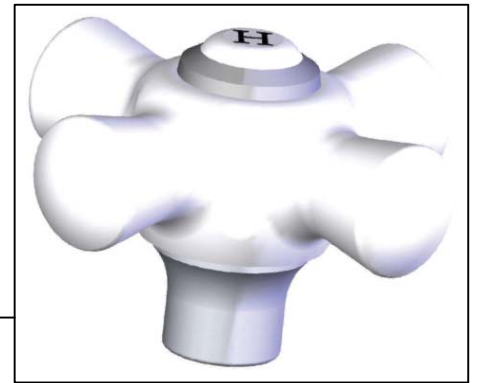

This insert adapts to OEM listed below without set screw. Long screw included.

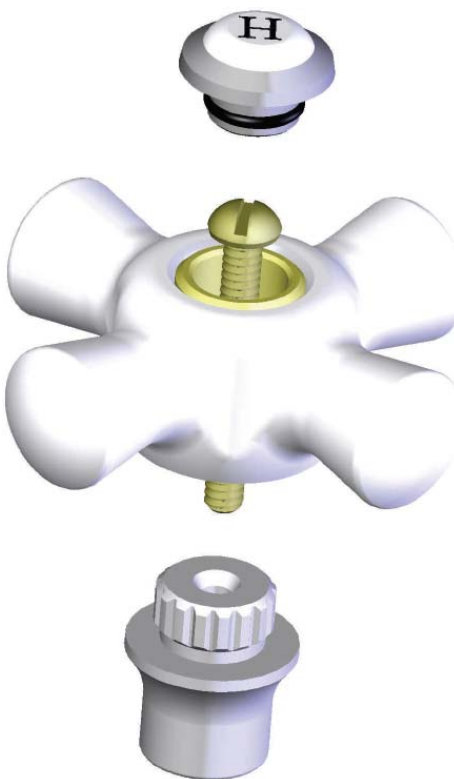

- # 102750 - Adapts to Chicago Square
- # 122140 - Adapts to Delta 'D' broach
- # 143590 - Adapts to Price Pfister 12pt
- # 143660 - Adapts to Briggs 18pt
- # 143800 - Adapts to American Standard 7/16 22pt
- # 143940 - Adapts to Central 16pt
- # 144080 - Adapts to Savoy 15pt
- # 144430 - Adapts to Kohler 19pt
- # 144500 - Adapts to Speakman 20pt
- # 114240 - Adapts to American Standard Cadet 1-9/16" long
- # 116240 - Adapts to American Standard Cadet 2" long

Use Handles with 12pt PP broach. #138480 or #135960 on pg.146

- # 126830 - Adapts to Artistic Brass
- # 122210 - Adapts to Artistic Brass
- # 122280 - Adapts to Artistic Brass

**These adapters are also pictured on pg.144**

Exploded view with Old Style Insert, supplied with long screw to attach handle, insert and stem together.



# BROADWAY TRIM

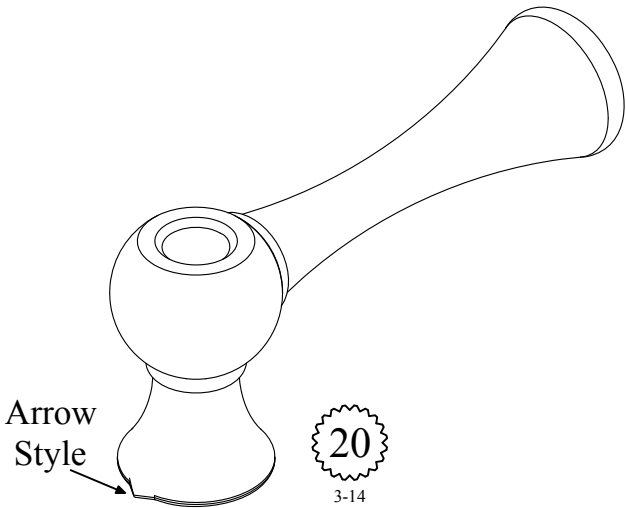

108210-PB	Polished Brass
108210-CP	Chrome Plated

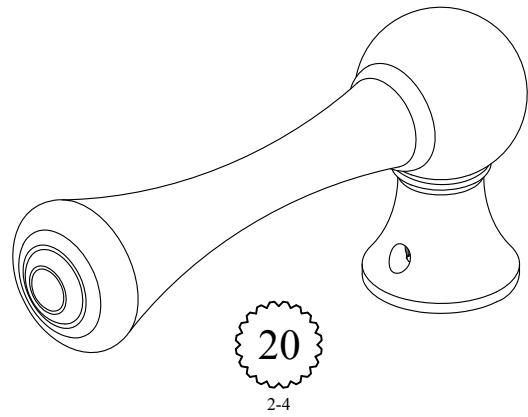

109610-PB	Polished Brass
109610-CP	Chrome Plated

Clip & Handle Nut Included with Handle  
109680-PB & 109680-CP

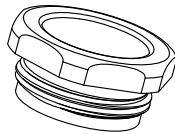
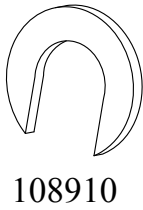

116540-PB	Polished Brass
116540-CP	Chrome Plated

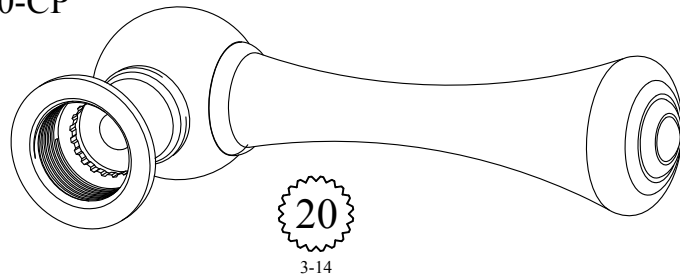

109680-PB	Polished Brass
109680-CP	Chrome Plated

Flange Ring

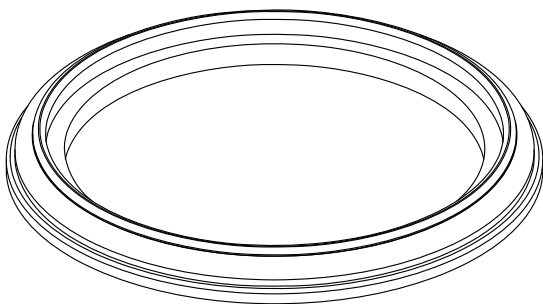

110730-PB	Polished Brass
110730-CP	Chrome Plated

Flange

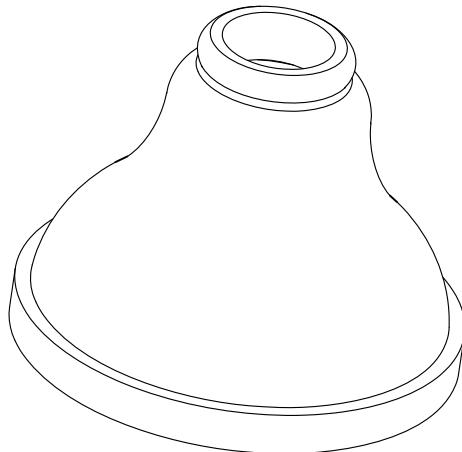

110660-PB	Polished Brass
110660-CP	Chrome Plated

# MISC. HANDLES

FOR SPHINX  
HANDLE KNOB

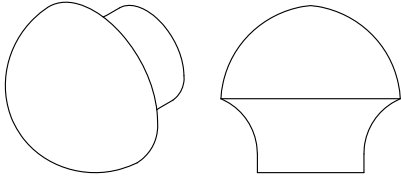

178320 Chrome Plated

FOR MUELLER  
DIVERter KNOB

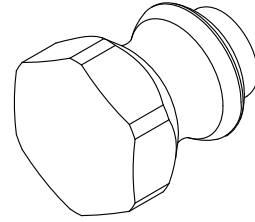

138200 Chrome Plated

FOR AM STD  
INDEXED HANDLE SCREW

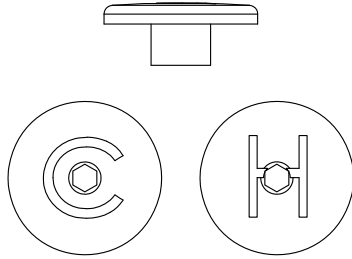

148720 Cold  
149280 Hot  
Chrome Plated

FOR KOHLER  
PUSH-PULL  
DIVERter KNOB

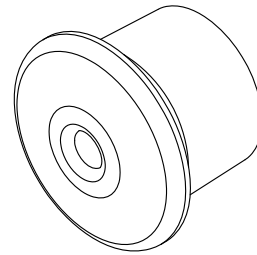

116850 Chrome Plated

FOR KOHLER  
PUSH-PULL  
DIVERter KNOB

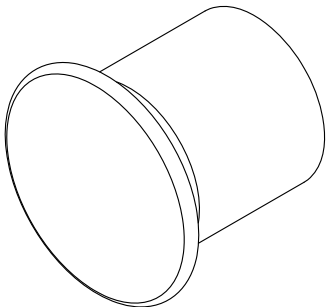

117550 Chrome Plated

FOR CONCINNITY  
DIVERter HANDLE  
WITH STOP

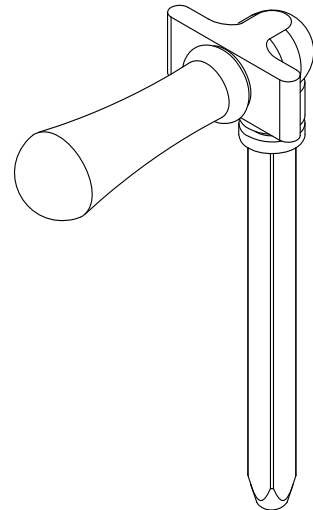

119650-CP Chrome Plated

# MISC. HANDLES

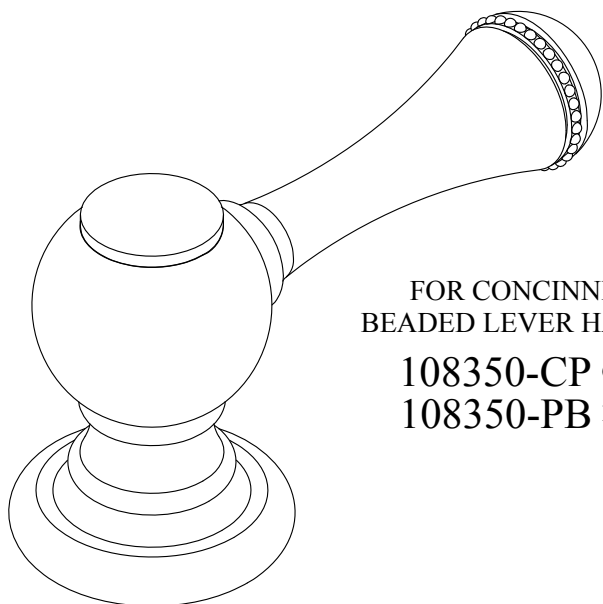

FOR CONCINNITY  
BEADED LEVER HANDLE

**108350-CP** Chrome Plated

**108350-PB** Polished Brass

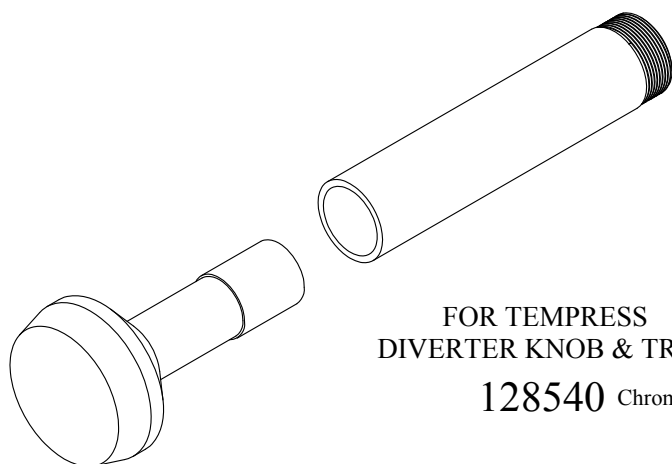

FOR TEMPRESS  
DIVERTER KNOB & TRIM

**128540** Chrome Plated

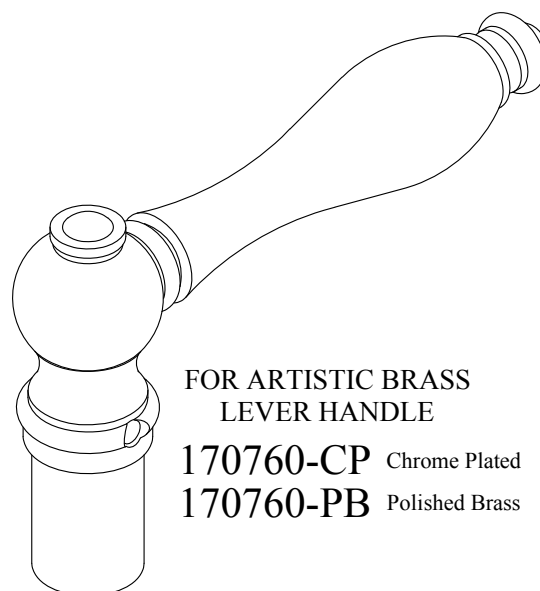

FOR ARTISTIC BRASS  
LEVER HANDLE

**170760-CP** Chrome Plated

**170760-PB** Polished Brass

BARRY E.  SR. CO.

NIPPLES

THREADED EXTENSIONS

ESCUTCHEON ADAPTERS

ESCUTCHEON EXTENSIONS

ESCUTCHEON HOLDERS

ESCUTCHEON TUBES

ESCUTCHEONS

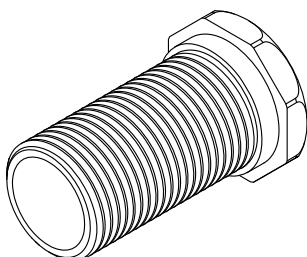
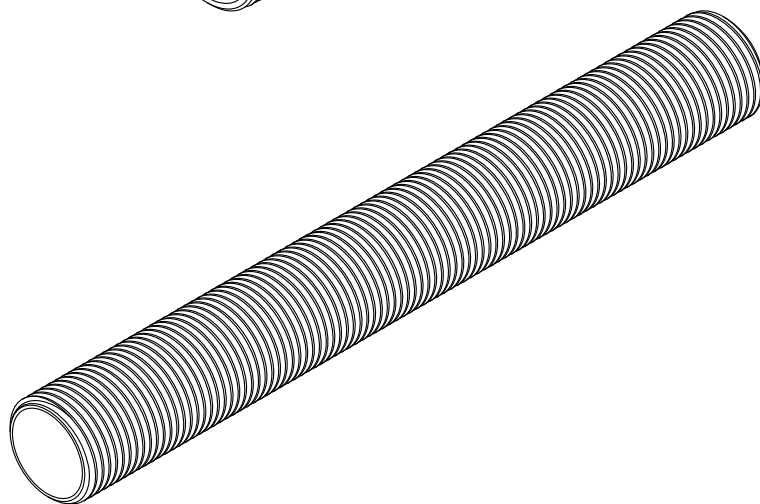
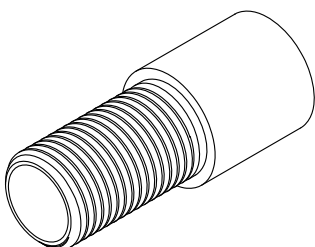
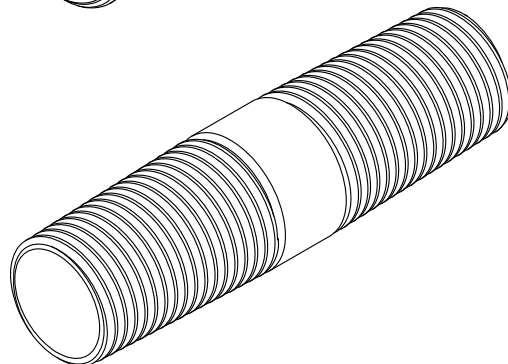
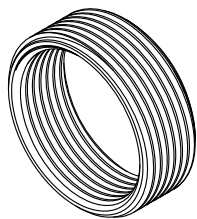
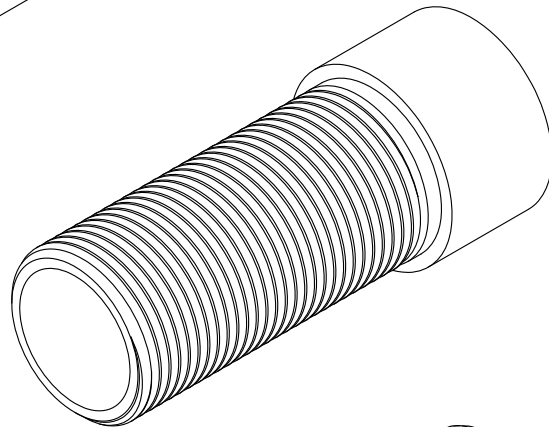
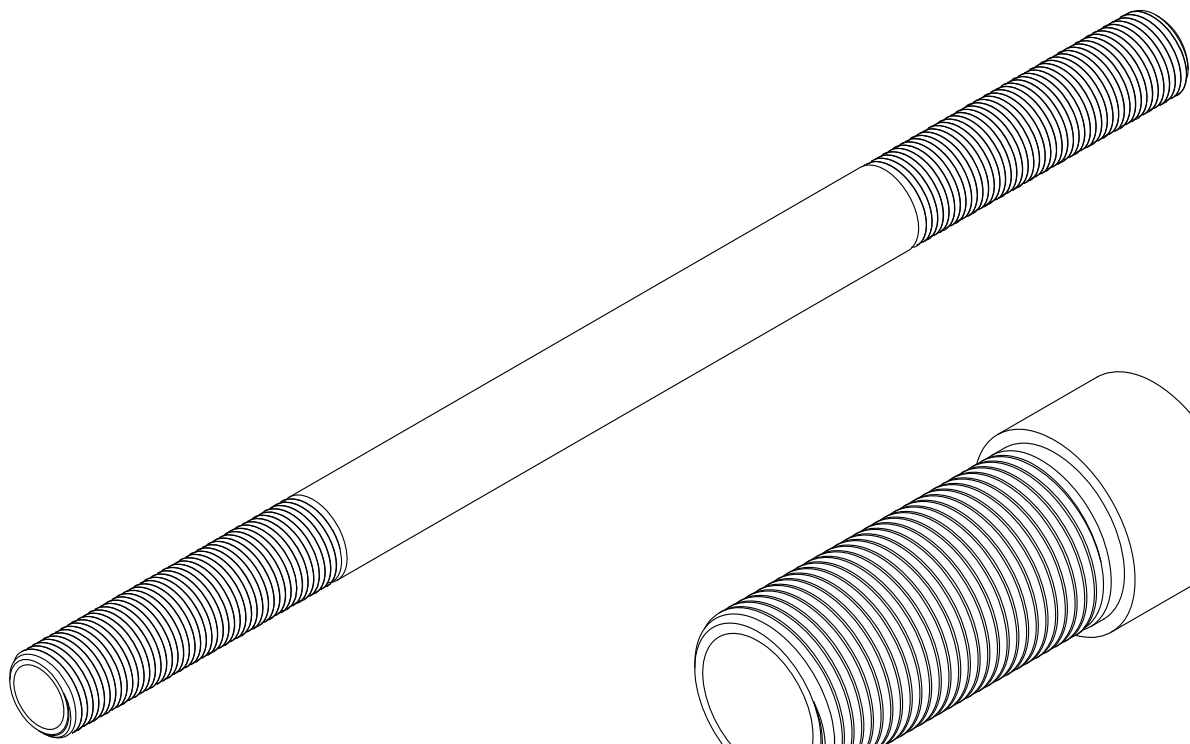

# NIPPLES & THREADED EXTENSIONS

## ESCUTCHEONS NIPPLES

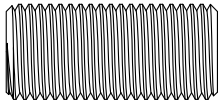

1/2-19

150750	1.10"
--------	-------

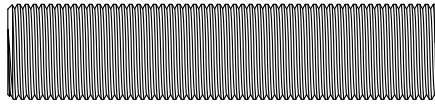

1/2-24

101240	0.50"	160960	2.25"
140090	0.75"	170340	2.50"

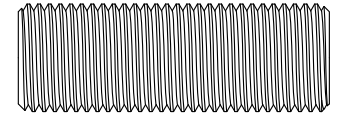

9/16-18

159150	1.62"
161030	2.25"

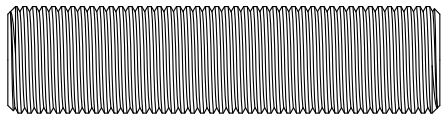

9/16-20

107980	0.56"	108260	2.00"
198460	0.625"	159920	2.25"
198250	0.75"	198040	2.56"
107700	0.875"	153050	3.00"
116820	1.00"	132500	3.687"
158660	1.25"	144030	3.80"
166500	1.50"	132950	4.00"
159290	1.75"	161810	6.00"
113250	1.875"	158800	12.00"

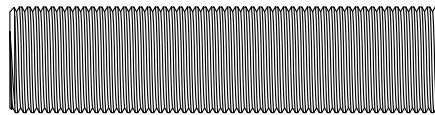

9/16-24

982610	1.62"
161100	2.25"
159220	2.625"
158870	12.00"

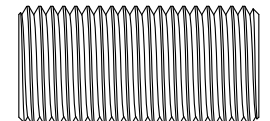

5/8-16

117150	0.875"
171530	1.25"
159080	2.00"
158940	12.00"

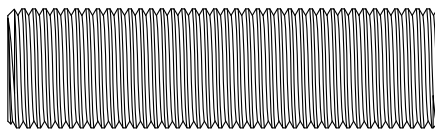

5/8-18

w/ .515 hole thru

159500	1.25"
164050	1.75"
159360	2.25"
160890	3.50"
134280	5.00"

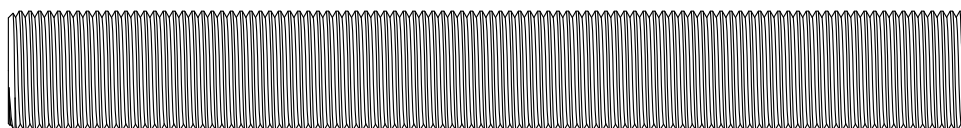

5/8-20

134350	5.00"
--------	-------

# NIPPLES & THREADED EXTENSIONS

## ESCUTCHEONS NIPPLES

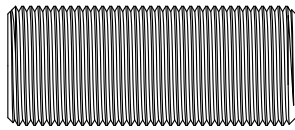

5/8-24

167900	1.187"	197970	2.375"
143050	1.375"	176990	2.687"
192580	1.50"	192510	3.00"
196850	2.00"	131310	6.00"
159430	2.25"	148790	12.00"

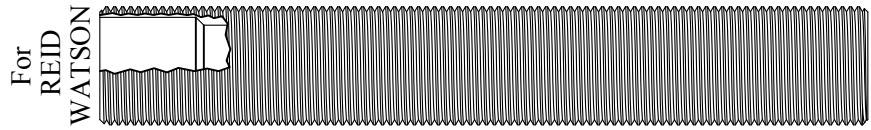

5/8-24

128210	4.00"
--------	-------

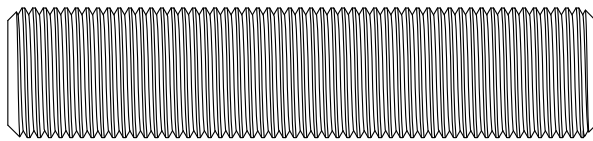

11/16-18

148230	3.062"
--------	--------

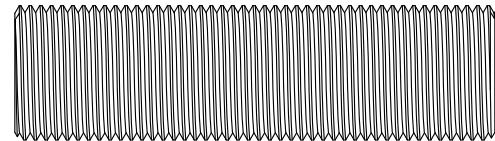

.700-18

133230	2.50"
--------	-------

## STEP NIPPLES

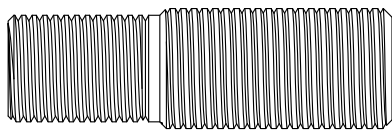

9/16-18 x 21/32-18

982140	2.00"
--------	-------

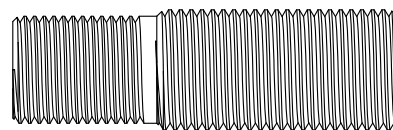

9/16-20 x 21/32-18

982120	2.00"
--------	-------

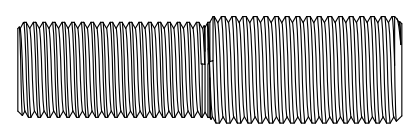

1/2-24 x 9/16-20

108050	2.00"
--------	-------

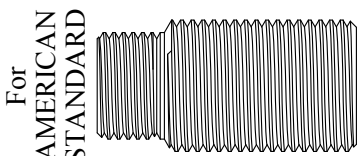

9/16-20 x .700-18

189940*	1.35"
147810	1.85"
*OEM# 1166-05	

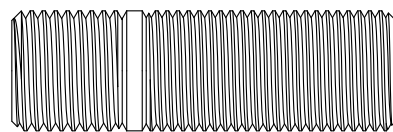

5/8-16 x 21/32-18

982150	2.00"
--------	-------

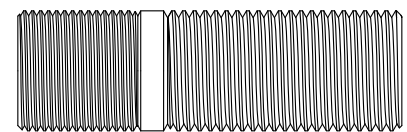

5/8-24 x 21/32-18

982130	2.00"
105860	4.35"

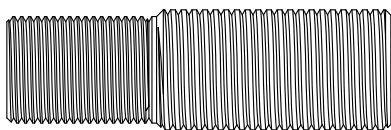

9/16-24 x 21/32-18

982110	2.00"
--------	-------

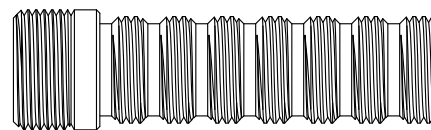

5/8-24 x 9/16-20

150190	1.65"
105860	2.20"



# NIPPLES & THREADED EXTENSIONS

## FIT-ALL NIPPLES

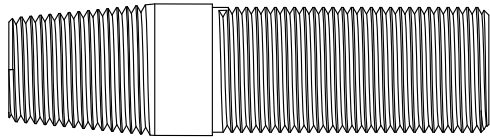

3/8-18 NPS x 18 TPI  
TAPERED

140650	2.50"
--------	-------

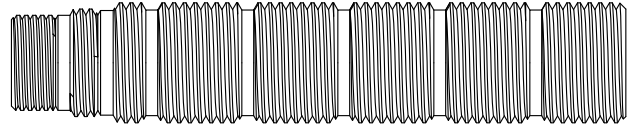

5/8-18 x 9/16-20 x 1/2-24  
SOLID BRASS

113420	3.20"
--------	-------

## ADAPTER NIPPLES

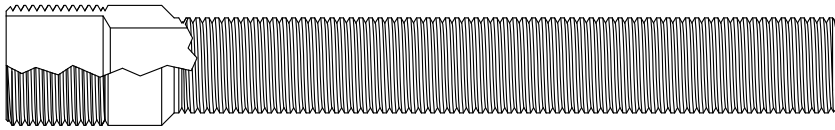

All 4.32" in length

Slips over stem extensions found on p.132-133

105720	5/8-24 x 1/2-24
105790	5/8-24 x 9/16-20
105860	5/8-24 x 5/8-18
105930	5/8-24 x 11/16-24
106280	5/8-24 x 5/8-24

## NIPPLE EXTENSION ADAPTER

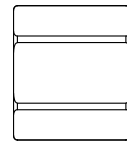

9/16-20 x 9/16-20

611270	0.60"
--------	-------

## NIPPLE EXTENSIONS

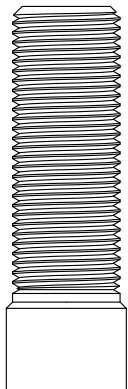

9/16-20

118320	0.875"
135260	2.00"
106000	3.00"

FOR BROADWAY / SPEAKMAN

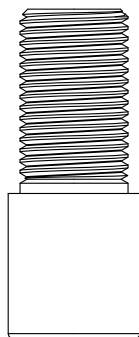

9/16-18

641300	1.715"
641310	2.215"

FOR KOHLER

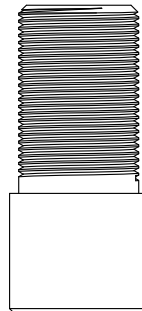

5/8-27

641340	1.60"
--------	-------

FOR PRICE PFISTER

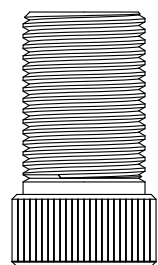

21/32-18

641330	1.325"
PP OEM# 973-090	

Nickel Plated

# NIPPLES & THREADED EXTENSIONS

## DRINKING FOUNTAIN NIPPLES

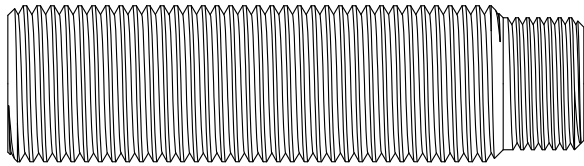

1/2-14 NPS x 3/8-18 NPT

LF641260	3.00"
LF641270	4.00"

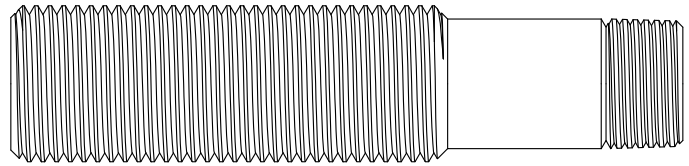

1/2-14 NPS x 3/8-18 NPT

128840	3.50"	Stainless Steel
LF641280	3.50"	
LF641290	4.50"	

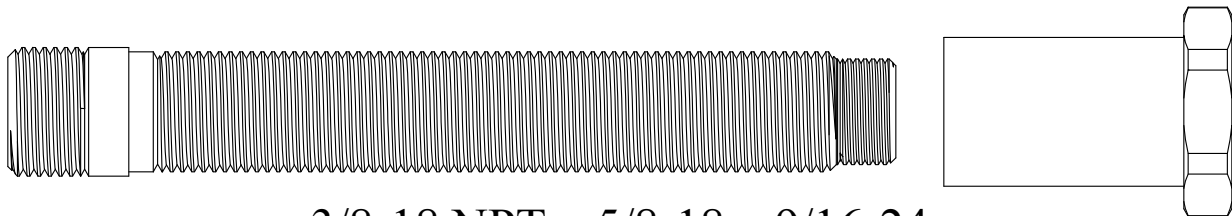

3/8-18 NPT x 5/8-18 x 9/16-24

LF184420	4.625"
----------	--------

DRINKING FOUNTAIN NIPPLE WITH NUT KIT

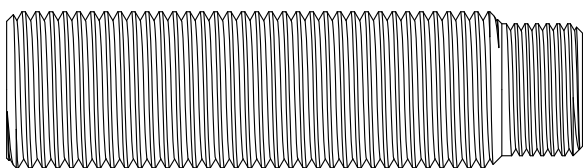

1/2-14 NPS x 3/8-18 NPT

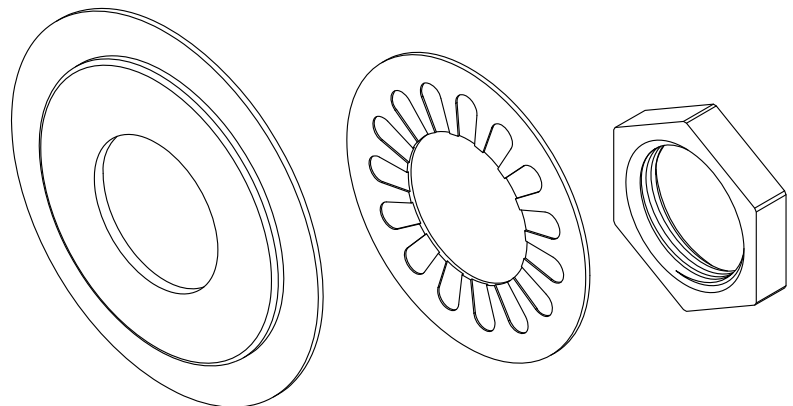

LF116430
----------

DRINKING FOUNTAIN FLANGE & SHANK KIT

# NIPPLES & THREADED EXTENSIONS

## PIPE NIPPLES

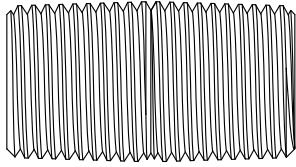

1/2-14 NPT x 1/2-14 NPT

LF111880	1.50"
----------	-------

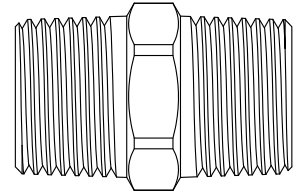

1/2-14 NPT x 1/2-14 NPT

LF134040	1.44"
----------	-------

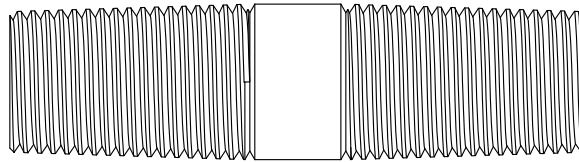

1/2-14 NPT x 1/2-14 NPT

LF119790	3.00"
----------	-------

## SPOUT NIPPLES

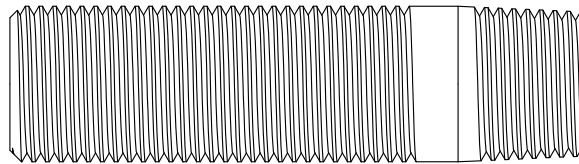

1/2-14 NPS x 1/2-14 NPT

LF138640	3.00"
LF105620	4.00"

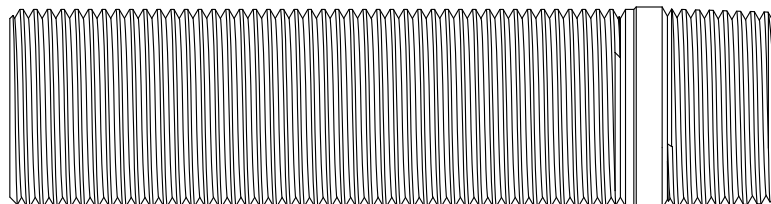

3/4-14 NPS x 3/4-14 NPT

102820	4.00"
--------	-------

# NIPPLES & THREADED EXTENSIONS

## SPOUT TUBES

FOR P.E. GUERIN



1/2-18 x 1/2-24

LF156350 5.365"

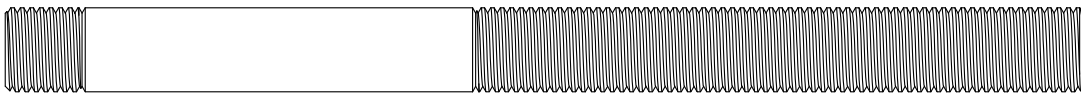

7/16-20 x 7/16-20

LF118970 5.625"

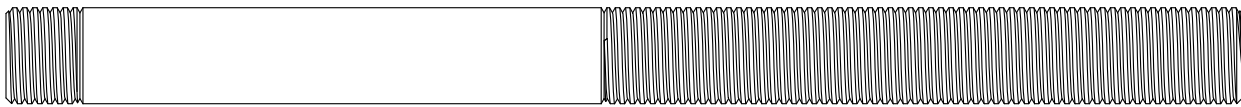

33/64-19 x 33/64-19

LF132410 6.44"

FOR AUBURN



7/16-20 x 1/8-27 NPT

LF198810 6.53"

FOR ARTISTIC BRASS



7/16-20 x 7/16-20

LF117080 6.80"

# NIPPLES & THREADED EXTENSIONS

## SPOUT TUBES

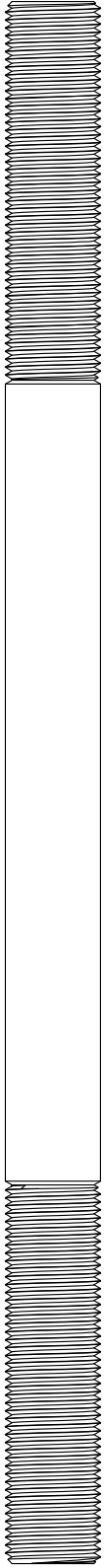

1/2-24 x 1/2-24

LF131570 | 8.25"



25/64-27 x 25/64-27

LF132460 | 8.625"

FOR CONCINITY

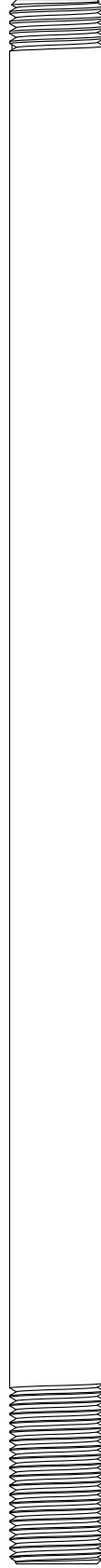

1/4-18 NPT X 17/32-20

LF142090 | 8.75"

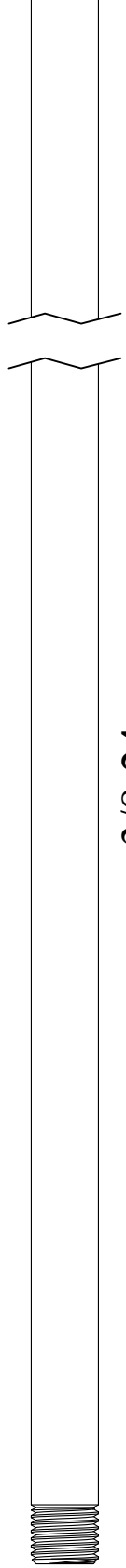

3/8-24

LF132480 | 9.625"

# NIPPLES & THREADED EXTENSIONS

## SHANK EXTENDERS

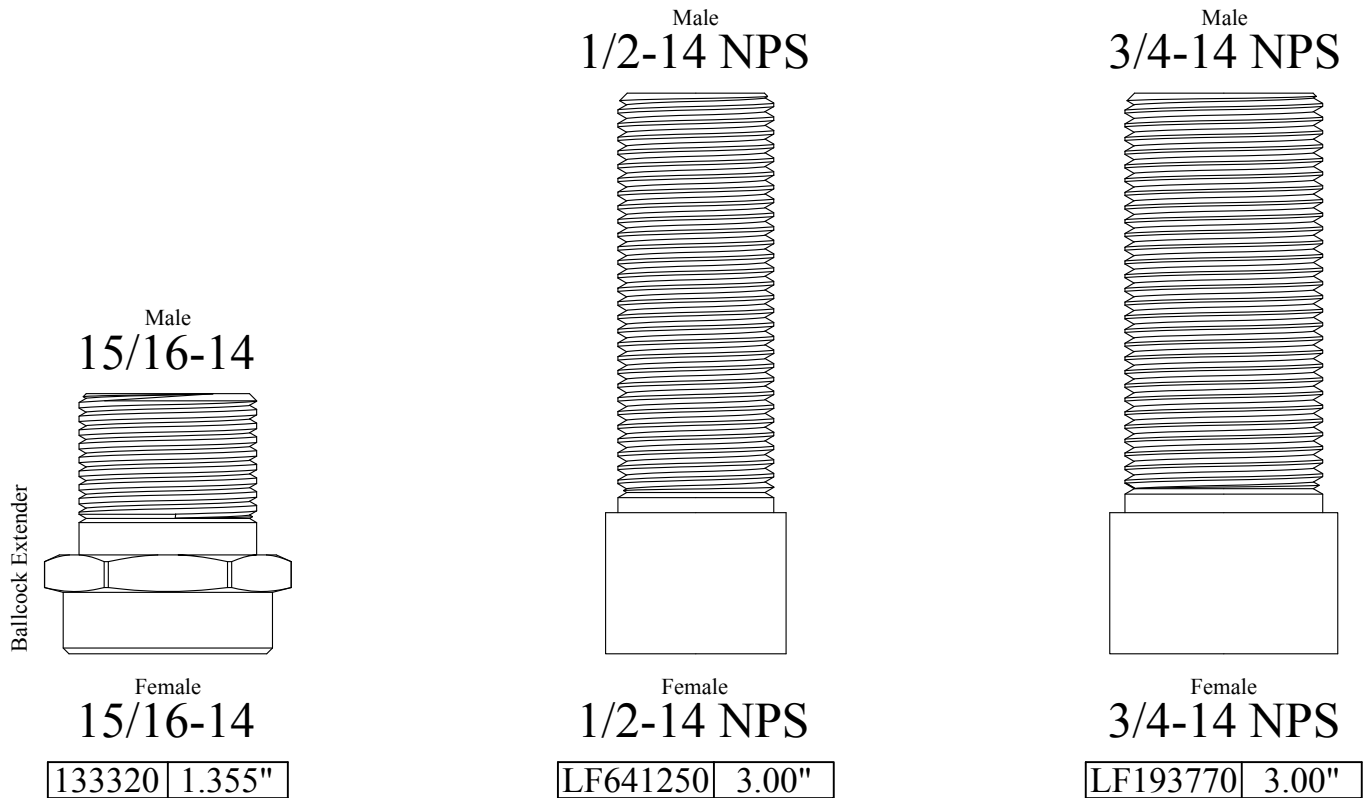

*Send Your Orders To:*

BARRY E.  SR. CO.

*E-mail: [orderdesk@barrywalter.com](mailto:orderdesk@barrywalter.com)*

*Fax: 1.800.886.9831*

*Phone: 1.800.767.5552*

# ESCUTCHEON ADAPTERS

FOR STERLING

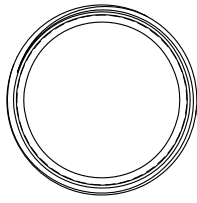

FOR 402411 & 430181



INTERNAL THREAD: 7/8 - 14 TPI  
EXTERNAL THREAD: 1" - 20 TPI

124410

FOR PRICE PFISTER

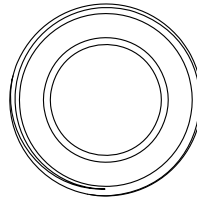

INTERNAL THREAD: 21/32 - 18 TPI  
EXTERNAL THREAD: 1" - 18 TPI

641020

FOR SAYCO

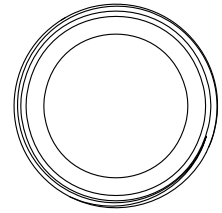

EXTERNAL THREAD: 1-1/16 - 20 TPI

907200

Also available with gasket 895100  
149070

FOR STERLING

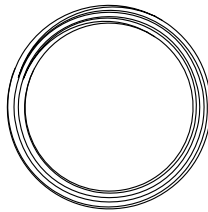

FOR 401111 & 401112

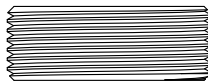

INTERNAL THREAD: 15/16 - 20 TPI  
EXTERNAL THREAD: 1-1/16 - 20 TPI

183720

FOR HARCRAFT

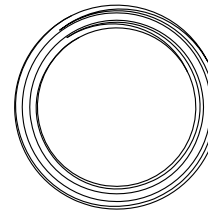

INTERNAL THREAD: 7/8 - 20 TPI  
EXTERNAL THREAD: 1-1/16 - 20 TPI

113720

FOR MILWAUKEE

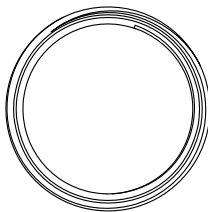

INTERNAL THREAD: 15/16 - 18 TPI  
EXTERNAL THREAD: 1-1/16 - 20 TPI

113860

FOR SAYCO

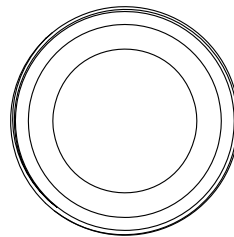

EXTERNAL THREAD: 1-3/16 - 26 TPI

909600

Also available with 1" Top Gasket  
147670

FOR KOHLER

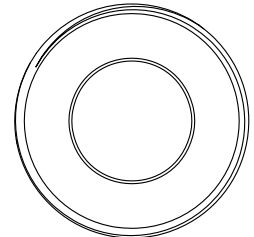

INTERNAL THREAD: 5/8 - 16 TPI  
EXTERNAL THREAD: 1-7/32 - 18 TPI

115470

FOR KOHLER SHOREMAN  
TO PRICE PFISTER

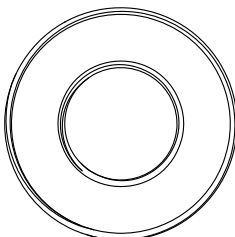

INTERNAL THREAD: 5/8 - 27 TPI  
EXTERNAL THREAD: 1-7/32 - 18 TPI

178740

FOR PRICE PFISTER

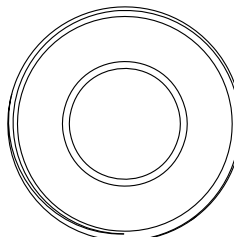

INTERNAL THREAD: 21/32 - 18 TPI  
EXTERNAL THREAD: 1-7/32 - 18 TPI

641010

FOR AM STD  
TO PRICE PFISTER

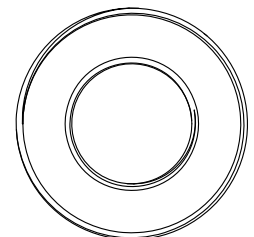

INTERNAL THREAD: 21/32 - 32 TPI  
EXTERNAL THREAD: 1-7/32 - 18 TPI

176780

# ESCUTCHEON ADAPTERS

FOR SAYCO  
TO PRICE PFISTER

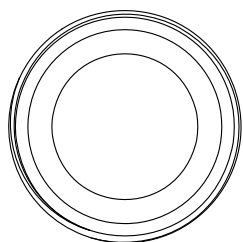

EXTERNAL THREAD: 1-7/32 - 18 TPI

171040

FOR HARCRAFT

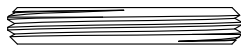
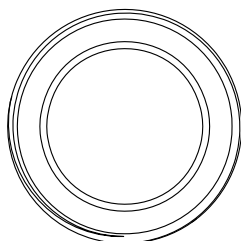

INTERNAL THREAD: 13/16 - 18 TPI  
EXTERNAL THREAD: 1-7/32 - 18 TPI

641040

FOR STERLING  
TO PRICE PFISTER

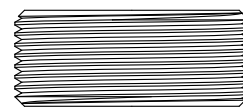
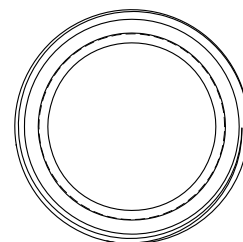

INTERNAL THREAD: 7/8 - 14 TPI  
EXTERNAL THREAD: 1-7/32 - 18 TPI

122910

FOR PRICE PFISTER

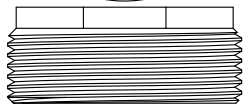
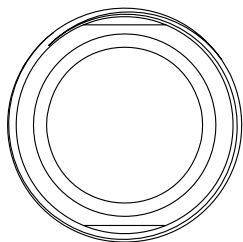

INTERNAL THREAD: 7/8 - 18 TPI  
EXTERNAL THREAD: 1-7/32 - 18 TPI

125270

FOR ELJER TO  
PRICE PFISTER

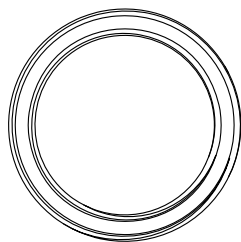

INTERNAL THREAD: 15/16 - 20 TPI  
EXTERNAL THREAD: 1-7/32 - 18 TPI

178670

FOR PRICE PFISTER

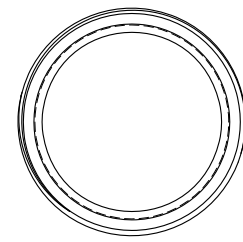

INTERNAL THREAD: 1" - 20 TPI  
EXTERNAL THREAD: 1-7/32 - 18 TPI

641030

FOR AM STD

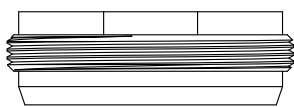
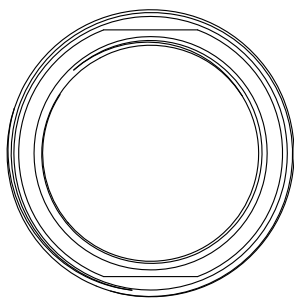

INTERNAL THREAD: 1-1/2 - 24  
EXTERNAL THREAD: 1-1/8 - 24

25173-04

Chrome Plated

FOR SIGMA

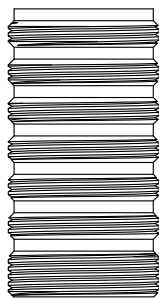

INTERNAL THREAD: M17 X 1.25  
EXTERNAL THREAD: M20 X 1.00

129030

UNKNOWN

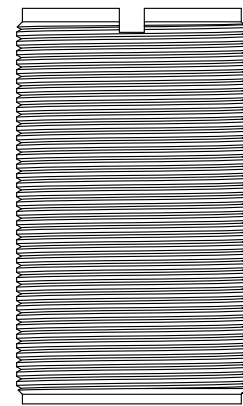

INTERNAL THREAD: M27 x 1.25  
EXTERNAL THREAD: M31 x 1.25

131150



# ESCUTCHEON ADAPTERS

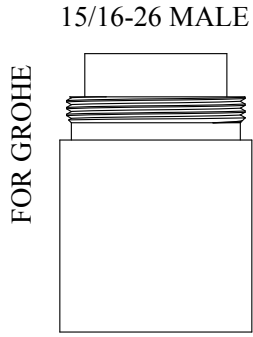

15/16-26 MALE

7/8-26 FEMALE

151310

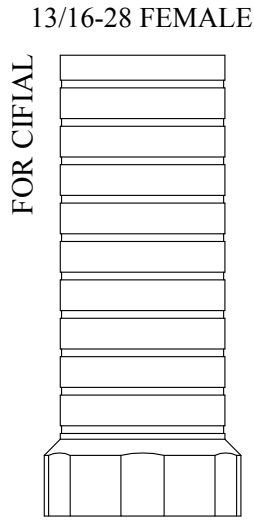

13/16-28 FEMALE

M24 x 1.00 FEMALE

156140

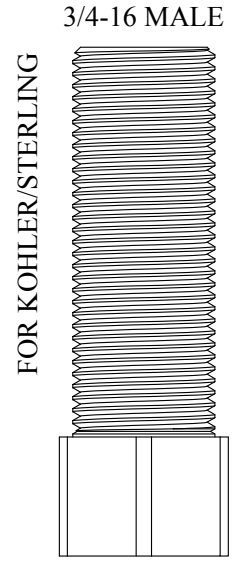

3/4-16 MALE

5/8-27 FEMALE

119040

All Plastic Part

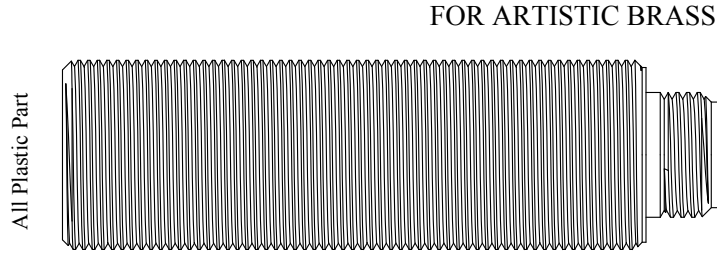

All Plastic Part

63/64-20 x 21/32-18

112460

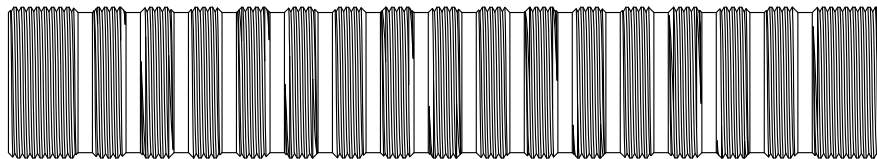

M20 X 1.00 MALE X M17 X 1.00 FEMALE

127840

# ESCUTCHEON ADAPTERS

5/8-24 FEMALE

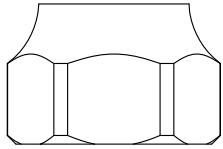

M24 X 1.00 FEMALE

105580

FOR CONCINNY

9/16-20 FEMALE

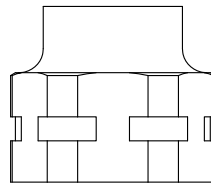

M24 X 1.00 FEMALE

103170

FOR HARCRAFT

3/8-18 FEMALE

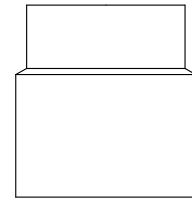

7/8-20 FEMALE

152630

FIT-ALL

21/32-18 FEMALE

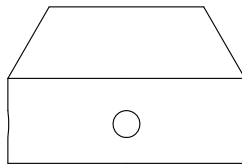

141700

FOR MILWAUKEE

M12-1.00 FEMALE

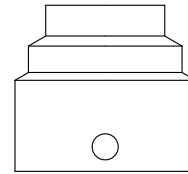

124940

FOR SAYCO TO  
TO PRICE PFISTER

1"-20 MALE

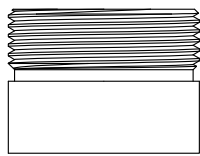

7/16-20 FEMALE

101170

FOR REID WATSON

9/16-20 FEMALE

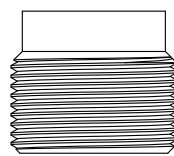

7/8-20 MALE

602660

FOR PRICE PFISTER

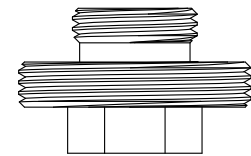

1-7/32-18 x 3/8-18 NPS

125340

# ESCUTCHEON EXTENSIONS

FOR SAVOY

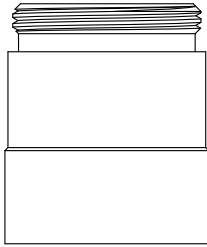

INTERNAL THREAD: 1" - 20  
EXTERNAL THREAD: 1" - 20

119830

FOR GROHE

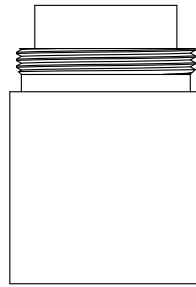

INTERNAL THREAD: M24 X 1.00  
EXTERNAL THREAD: M24 X 1.00

151310

FOR AM STD AZIMUTH

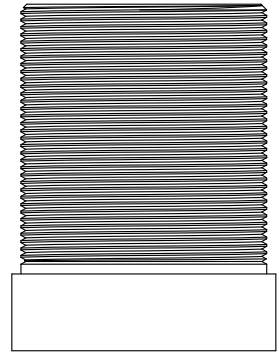

INTERNAL THREAD: 1-9/32 - 26  
EXTERNAL THREAD: 1-9/32 - 26

174120

FOR AM STD CADET

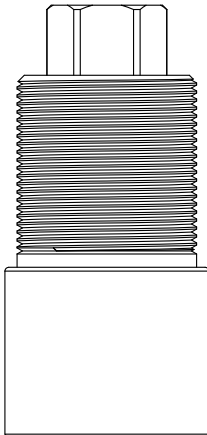

INTERNAL THREAD: 15/16 - 24  
EXTERNAL THREAD: 15/16 - 24

129540

FOR KOHLER

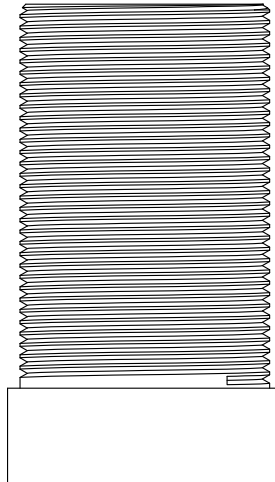

INTERNAL THREAD: M33 X 1.50  
EXTERNAL THREAD: M33 X 1.50

151440

WATERWORKS

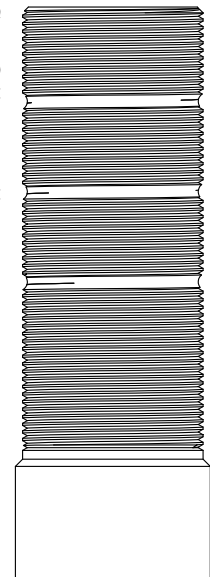

INTERNAL THREAD: M24 X 1.00  
EXTERNAL THREAD: M24 X 1.00

127350

FOR DORNBRACHT

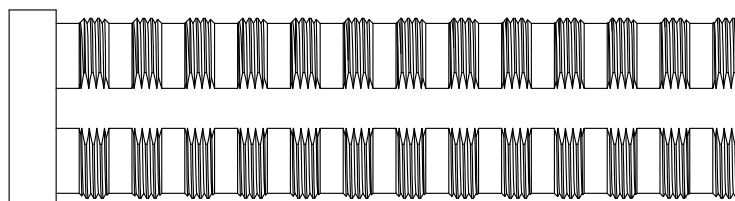

INTERNAL THREAD: M24 X 1.00  
EXTERNAL THREAD: M24 X 1.00

125080

# ESCUTCHEON HOLDERS

FOR GERBER

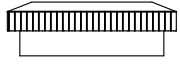

Chrome Plated

5/8 - 24  
941120

FOR SAYCO



Chrome Plated

11/16 - 24  
941160

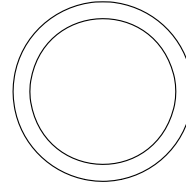

Nickel Plated

INTERNAL DIA.:  
3/4"  
136120

FOR AM STD

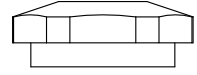

Chrome Plated

9/16 - 20  
941130

FOR REPCAL



Chrome Plated

5/8 - 18  
941190

FOR REPCAL

For Integral Stop  
No hole through



Chrome Plated

5/8 - 20  
941200

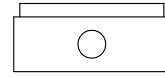
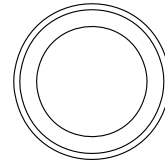

Nickel Plated

INTERNAL DIA.:  
9/16"  
103360

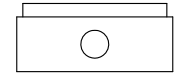
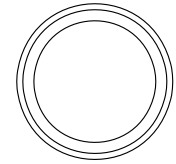

Nickel Plated

INTERNAL DIA.:  
5/8"  
111060

FOR CENTRAL

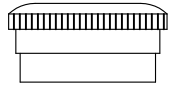

Chrome Plated

9/16 - 20  
941210

FOR SPEAKMAN

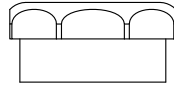

9/16 - 18  
110010

FOR LOGAN

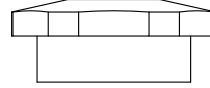

Chrome Plated

9/16 - 20  
941180

FOR PRICE PFISTER



Chrome Plated

21/32 - 18  
941100

FOR BRIGGS

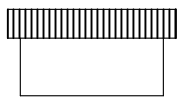

Chrome Plated

5/8 - 24  
941110

FOR ELJER



Chrome Plated

9/16 - 24  
941140

FOR SPEAKMAN  
& CRANE

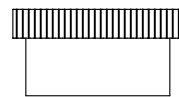

Chrome Plated

9/16 - 18  
941170

FOR PRICE PFISTER

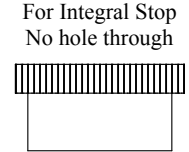

Chrome Plated

For Integral Stop  
No hole through  
21/32 - 18  
941220

# ESCUTCHEON HOLDERS

FOR CHICAGO

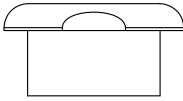

Chrome Plated

5/8 - 20  
941290

FOR GLAUBER

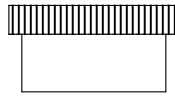

Chrome Plated

5/8 - 20  
941230

FIT-ALL

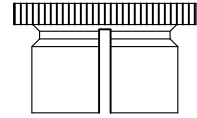

Chrome Plated

1/2 - 18 X 9/16 - 18  
116290

FOR KOHLER

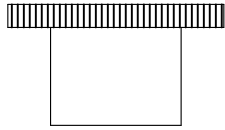

Chrome Plated

5/8 - 16  
941150

FOR AUBURN

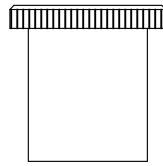

Chrome Plated

1/2 - 24  
189730

FOR SPEAKMAN

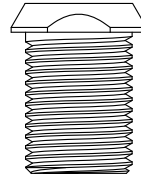

Chrome Plated

9/16 - 18  
143380

FOR CRANE  
PRE-WAR

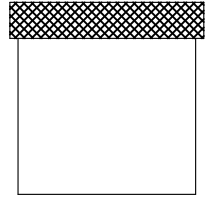

Chrome Plated

7/8 - 16  
941250

FOR SPEAKMAN

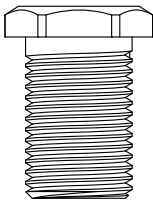

Chrome Plated

EXTERNAL THREAD:  
9/16 - 18 TPI  
941260

FOR SPEAKMAN

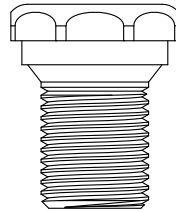

Chrome Plated

EXTERNAL THREAD:  
9/16 - 18 TPI  
941280

FOR SPEAKMAN

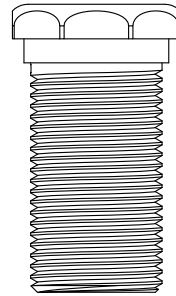

Chrome Plated

EXTERNAL THREAD:  
11/16 - 18 TPI  
941240

FOR SPEAKMAN/  
BROADWAY

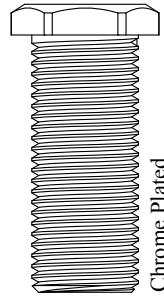

Chrome Plated

EXTERNAL THREAD:  
9/16 - 18 TPI  
941270

Also available in polished brass  
**941270-PB**

FOR SPEAKMAN/  
BROADWAY

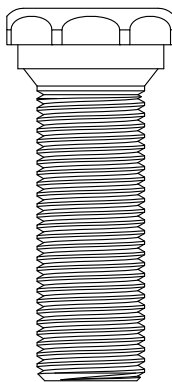

Also available with in polished brass

**108120-PB**

9/16 - 18  
108120

# ESCUTCHEON TUBES

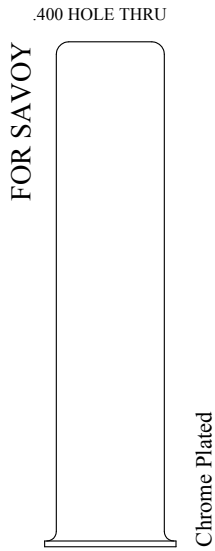

912800

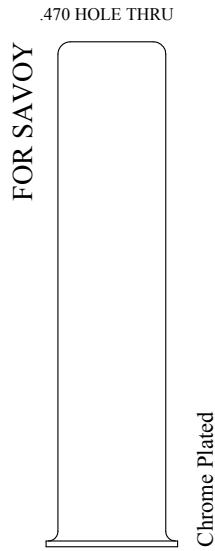

922710

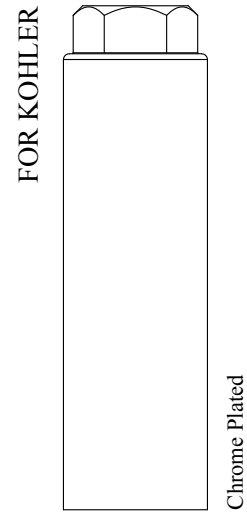

5/8 - 27 FEMALE

111460

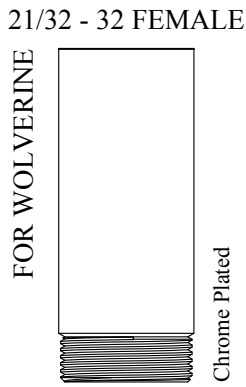

11/16 - 27 MALE

907900

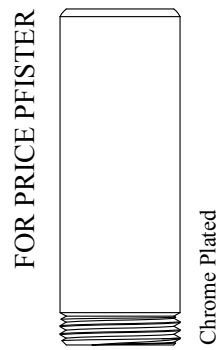

3/8 - 18 NPS MALE

912900

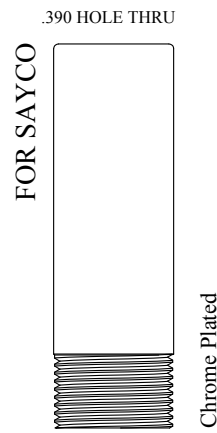

5/8 - 24 MALE

909800

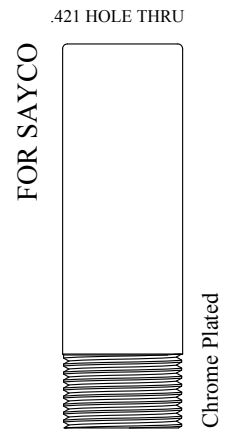

5/8 - 24 MALE

924410

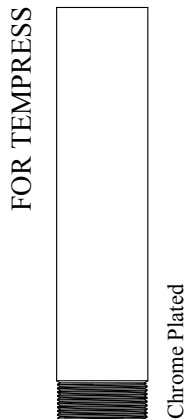

M12 x 0.5 MALE

128610

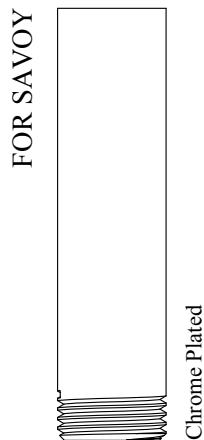

9/16 - 20 MALE

108630

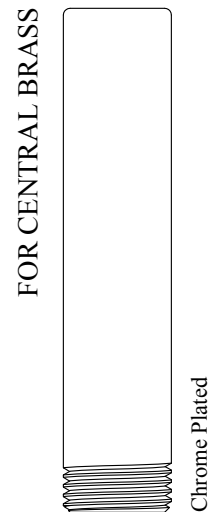

9/16 - 20 MALE

167340

# ESCUTCHEON TUBES

FOR ELJER

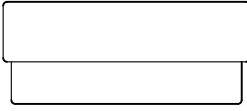

Chrome Plated

1-1/8 - 20 FEMALE

119390

FOR CRANE



Chrome Plated

1-5/16 - 16 FEMALE

143070

FOR CRANE

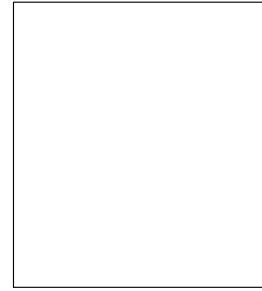

Chrome Plated

NO INTERNAL THREAD

142860

FOR ELJER

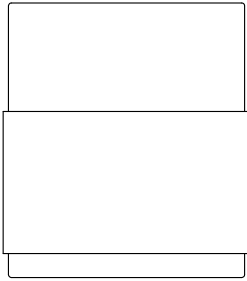

Chrome Plated

1-1/8 - 20 FEMALE

116360

FOR AM STD

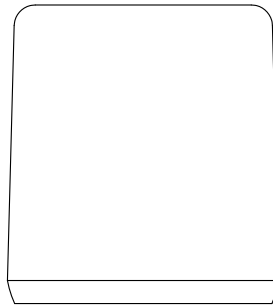

Chrome Plated

1-11/64 - 24 FEMALE

901550

FOR CRANE

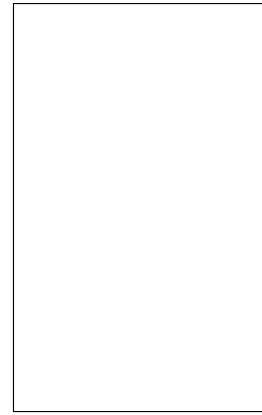

NO INTERNAL THREAD

142020

FOR SPEAKMAN

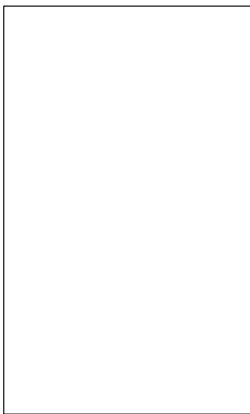

Chrome Plated

1-1/8 - 18 FEMALE

122730

FOR MILWAUKEE



Chrome Plated

15/16 - 27 FEMALE

194120

FOR ELJER

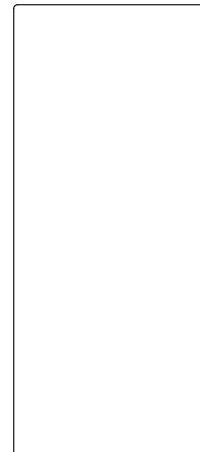

Chrome Plated

1" - 20 FEMALE

904220

# ESCUTCHEON TUBES

Chrome Plated

FOR ELJER



1" - 20 FEMALE

907800

Chrome Plated

FOR ELJER / STERLING



15/16 - 20 FEMALE

1" - 24 MALE

199300

Chrome Plated

FOR CENTRAL



1-13/64 - 20 FEMALE

915810

Chrome Plated

FOR CRANE

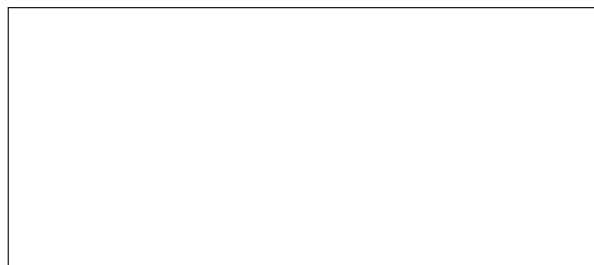

1-21/64 - 28 FEMALE

106350



# ESCUTCHEONS

- 110660-BN Nickel Plated
- 110660-CP Chrome Plated
- 110660-PB Polished Brass

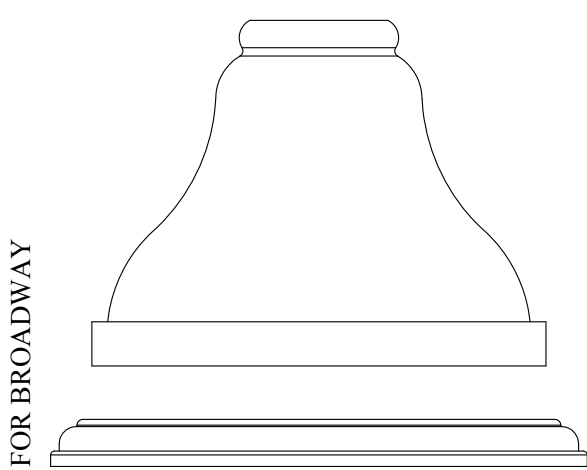

- 110730-BN Nickel Plated
- 110730-CP Chrome Plated
- 110730-PB Polished Brass

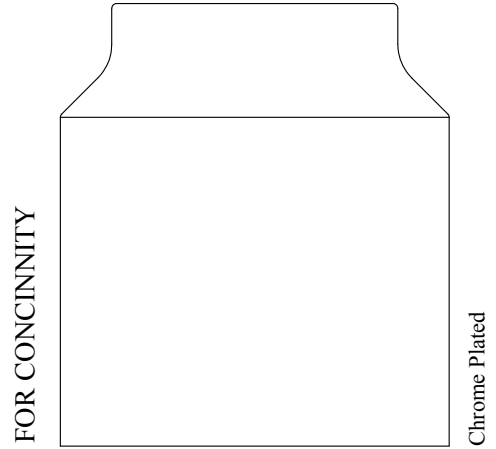

3/4" - 20 FEMALE  
133970

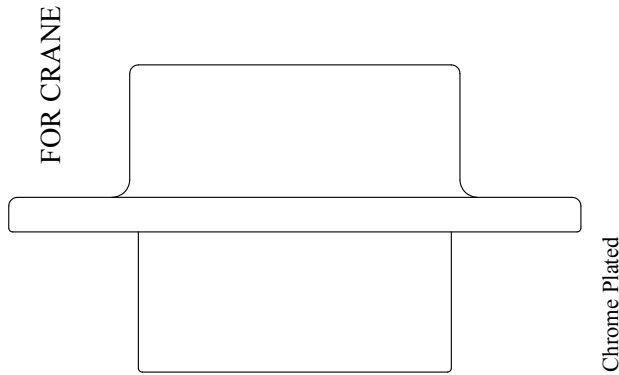

1-9/16 - 16 FEMALE  
130290

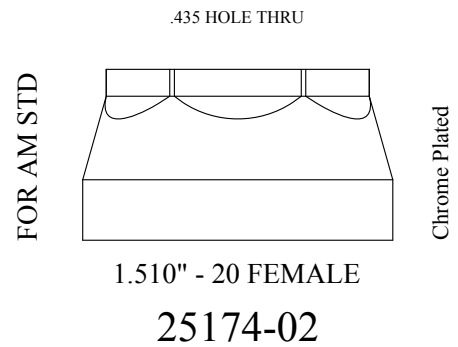
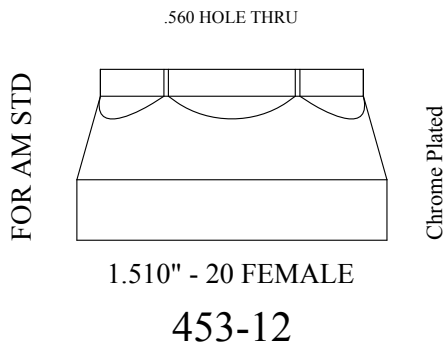

# ESCUTCHEONS

FOR CONCINITY

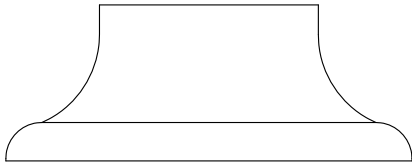

Chrome Plated

1-1/64 - 20 FEMALE

**113460**

FOR CRANE

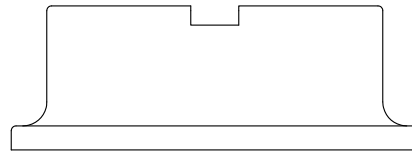

Chrome Plated

1-5/16 - 16 FEMALE

**134650**

OEM#: F13243  
OEM#: F11743

FOR CRANE

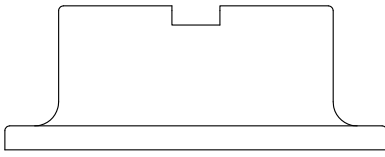

Chrome Plated

1-5/16 - 16 FEMALE

**143000**

OEM#: F11743

FOR VALLEY

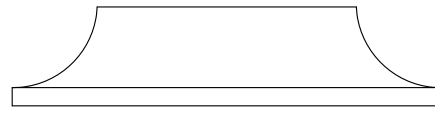

Chrome Plated

1-1/4 - 20 FEMALE

**155930**

FOR CRANE

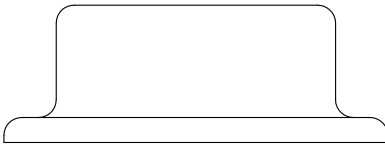

Chrome Plated

1-5/16 - 16 FEMALE

**142510**

OEM#: F11945, F14920, 300550

FOR CRANE

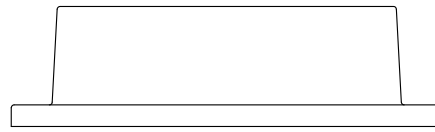

Chrome Plated

1-1/2 - 16 FEMALE

**107750**

OEM#: F12126

FOR CRANE

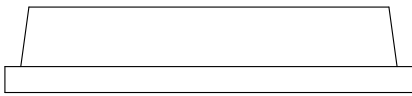

Chrome Plated

1-13/16 - 16 FEMALE

**139600**

OEM#: F10701

FOR ELJER

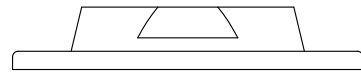

Chrome Plated

1" - 20 FEMALE

**111690**



1" - 20 FEMALE

**175240**



1-3/32 - 18 FEMALE

**176710**

*We are always adding  
new parts. Check our  
website for updates.*

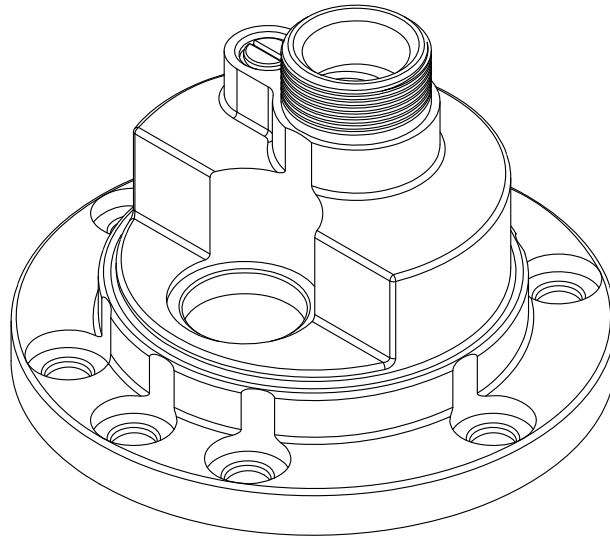

BARRY E.  ALTER  SR. CO.

*Send Your Orders To:*

BARRY E.  SR. CO.

*E-mail: [orderdesk@barrywalter.com](mailto:orderdesk@barrywalter.com)*

*Fax: 1.800.886.9831*

*Phone: 1.800.767.5552*

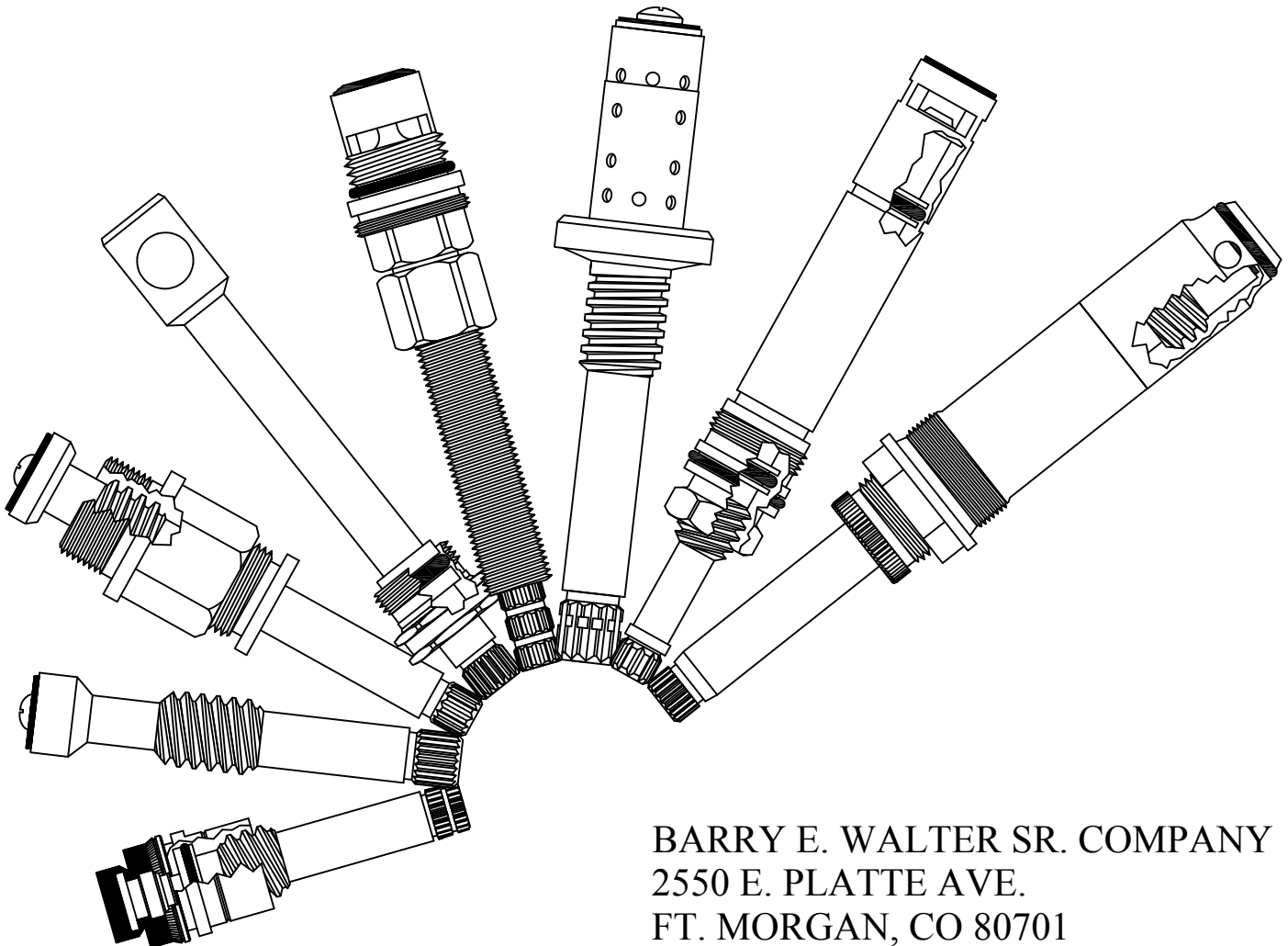

BARRY E. WALTER SR. COMPANY  
2550 E. PLATTE AVE.  
FT. MORGAN, CO 80701

BARRY E.  WALTER SR. CO.

# SHOWER HEADS & COMPONENTS

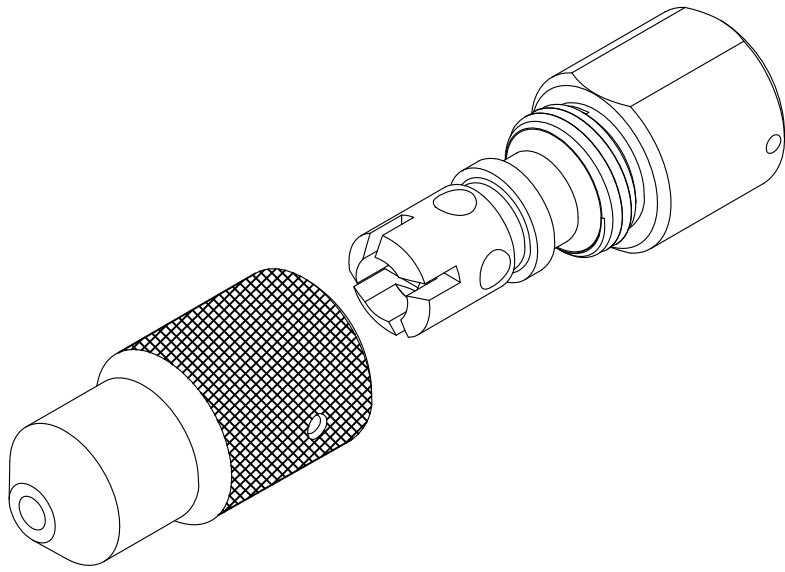

# SHOWER HEADS

FOR ACORN  
Female

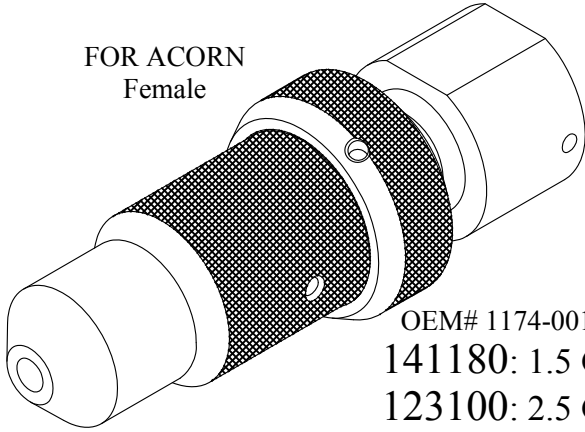

OEM# 1174-001-001  
141180: 1.5 GPM  
123100: 2.5 GPM

FOR ACORN  
Female Rigid

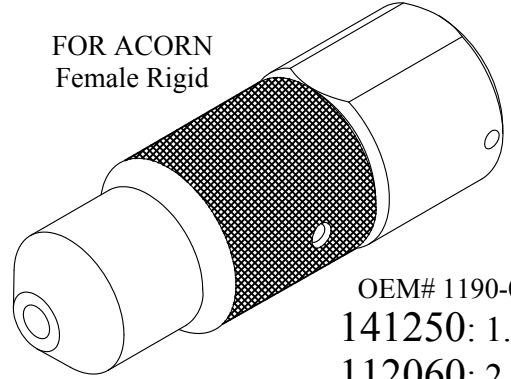

OEM# 1190-010-001  
141250: 1.5 GPM  
112060: 2.5 GPM

FOR ACORN  
Male

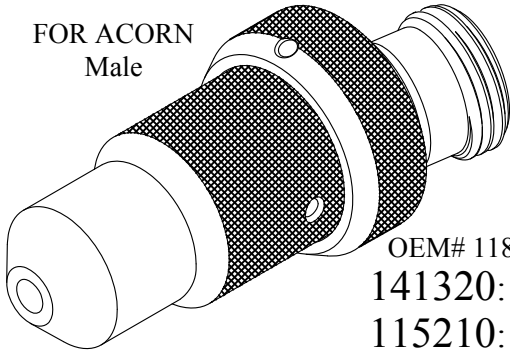

OEM# 1180-001-001  
141320: 1.5 GPM  
115210: 2.5 GPM

FOR ACORN  
Male Rigid

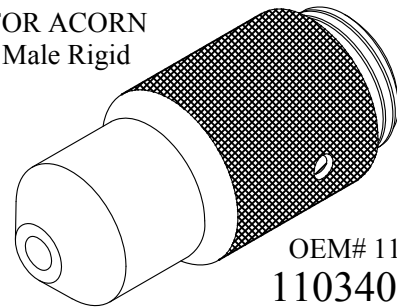

OEM# 1192-010-001  
110340: 1.5 GPM  
115350: 2.5 GPM

FOR ACORN  
Female

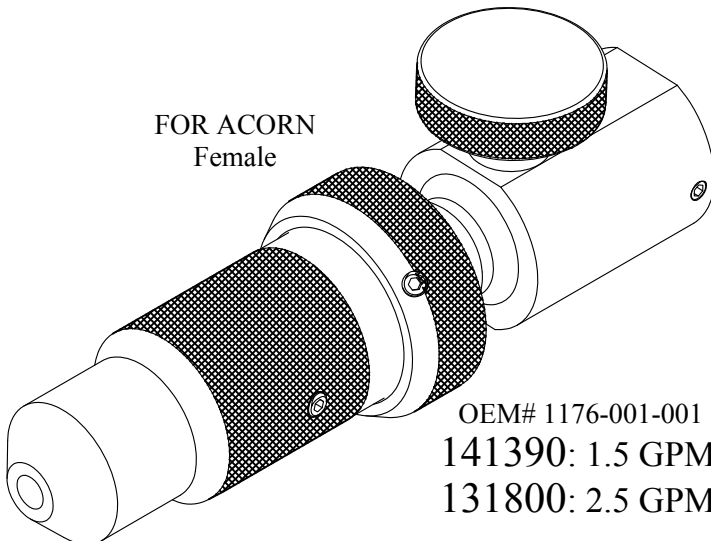

OEM# 1176-001-001  
141390: 1.5 GPM  
131800: 2.5 GPM

FOR ACORN  
Male Rigid

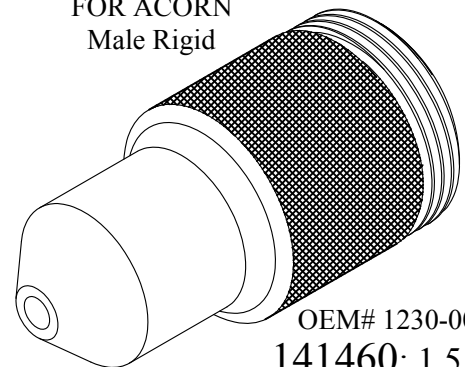

OEM# 1230-000-001  
141460: 1.5 GPM  
123750: 2.5 GPM

# SHOWER HEADS

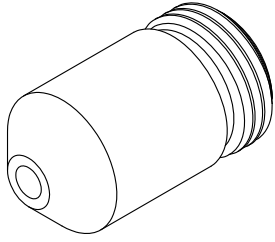

For  
Acorn Male  
OEM# 1241-001-001  
120320: 1.5 GPM  
120390: 2.5 GPM

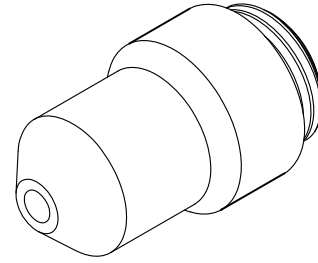

For  
Acorn Male  
OEM# 1187-000-001  
141670: 1.5 GPM  
103220: 2.5 GPM

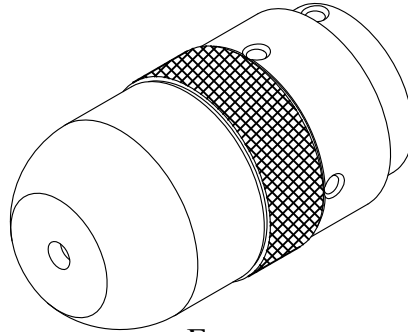

For  
Bradley Female  
3/8-18 NPT  
OEM# S24-008  
141600: 1.5 GPM  
130870: 2.5 GPM

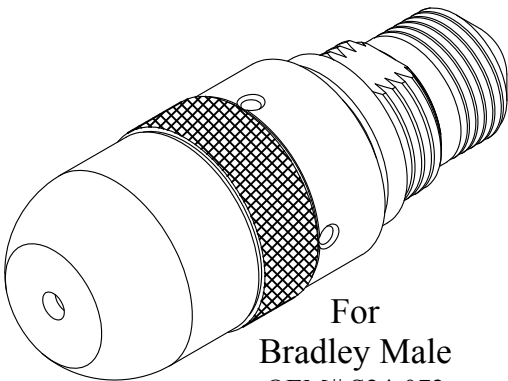

For  
Bradley Male  
OEM# S24-072  
112450: 1.5 GPM  
112130: 2.5 GPM  
122380: 3.0 GPM

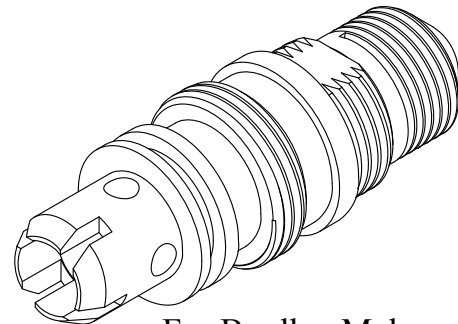

For Bradley Male  
Chrome Plated Solid Brass  
(Not Plastic)  
OEM# S88-067 / 111810: 1.5 GPM  
OEM# S88-001 / 122310: 2.5 GPM  
OEM# S88-003 / 122520: 3.0 GPM



# SHOWER HEADS

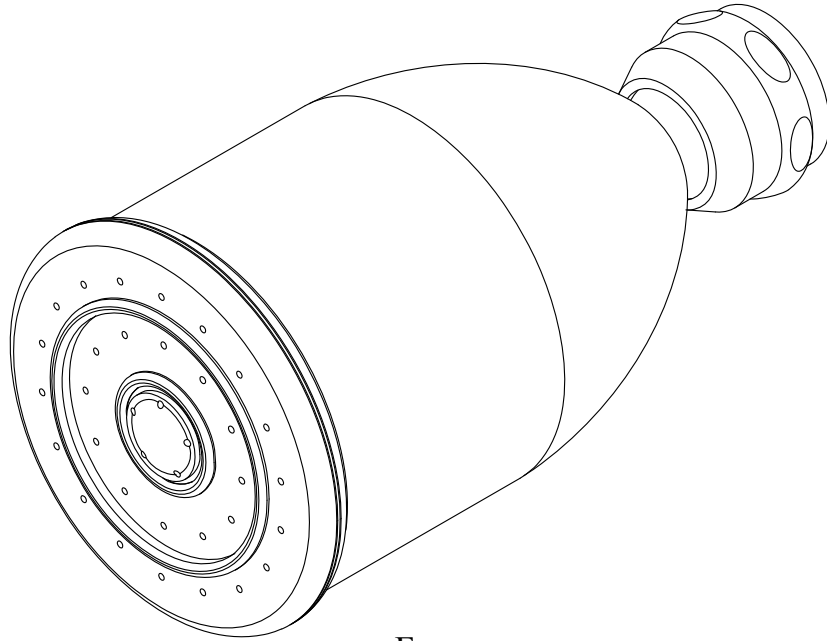

For  
Concinnity  
132620

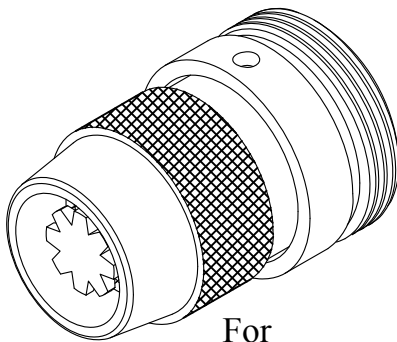

For  
Symmons "Free-Flo"  
OEM# FF-1A1.5  
110270: 1.5 GPM  
OEM# FF-1A  
131190: 2.5 GPM

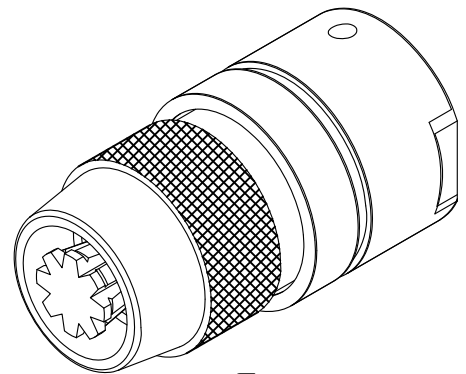

For  
Symmons "Free-Flo" Rigid  
OEM# 4-285F  
112620: 2.5 GPM  
141740: 1.5 GPM

# SHOWER HEAD COMPONENTS

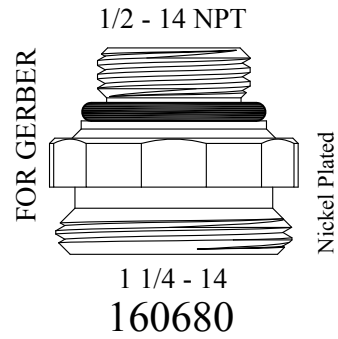
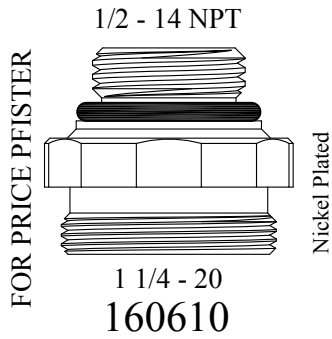
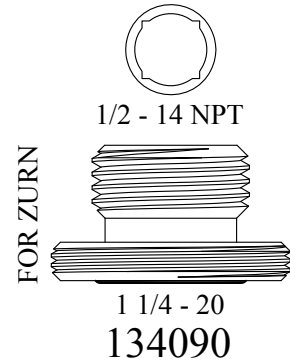
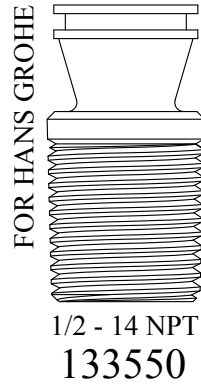
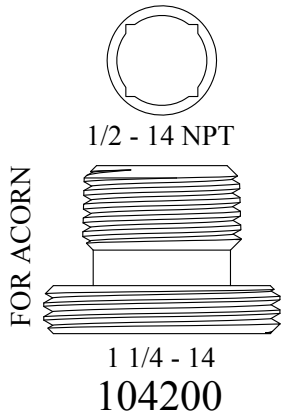

PIVOT BALL  
FOR WATERPICK

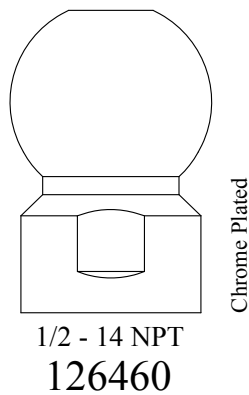

SHOWER MIXER  
FOR POWERS

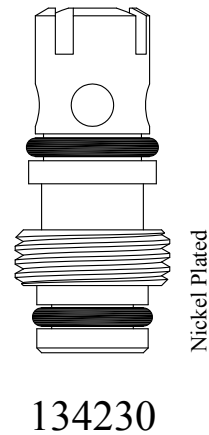

BARRY E.  WALTER  SR. CO.

# REPAIR KITS



# REPAIR KITS

## FOR ACORN B5 LF103870

PACKING NUT

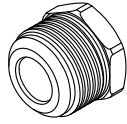

SPRING

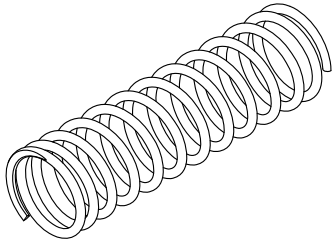

.437 x .250 x .094  
O-RING



.437 x .250  
BACK-UP RING



1.030 x .875 x .062  
GASKET

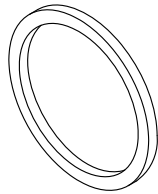

CAP NUT

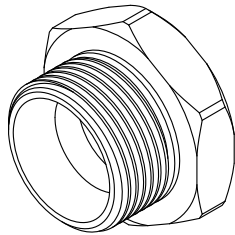

STEM ASSEMBLY

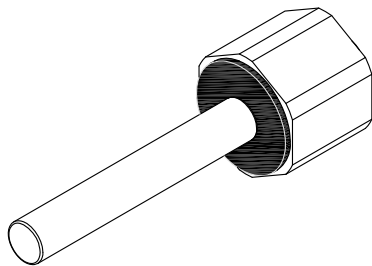

1/2-27 SEAT

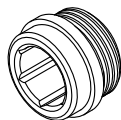

## FOR AMERICAN STANDARD COLONY DIVERTER 115540

.745 x .375 x .047  
PHENOLIC WASHER



PACKING



PACKING SEAL



DIVERTER WASHER

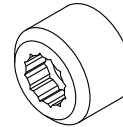

.750 x .625 x .062  
O-RING



.750 x .390 x .040  
BRASS WASHER



WAVE WASHER



8-32 x 3/8  
BIBB SCREW



1/2-20 SEAT

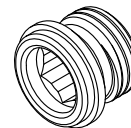

# REPAIR KITS

FOR AMERICAN STANDARD COLONY  
SHOWER VALVE REPAIR KIT  
115330

FOR BRADLEY REPAIR KIT S45-048A  
130170

.745 x .375 x .047  
PHENOLIC WASHER

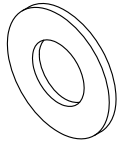

RETAINER CUP

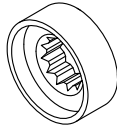

PACKING



PACKING SEAL



.750 x .390 x .040  
BRASS WASHER

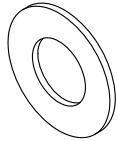

WAVE WASHER



BIBB WASHER



8-32 x 3/8  
BIBB SCREW



1/2-20 SEAT

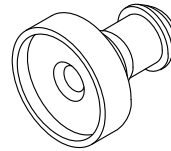
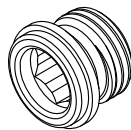

RETAINER &  
SCREW WASHER



.812 x .625 x .094  
O-RING

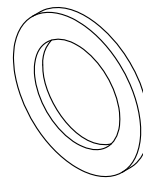

.937 x .630 x .062  
FIBRE WASHER

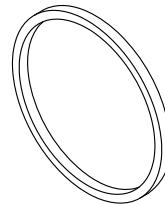

1.100 x 1.000 x .062  
GASKET

# REPAIR KITS

FOR BROADWAY DIVERTER  
REPAIR KIT 26.50792 000  
136190

DIVERTER WASHER



.590 x .468 x .032  
BRASS WASHER

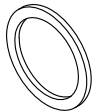

.625 x .437 x .187  
STEM PACKING



3/8L BIBB WASEHR

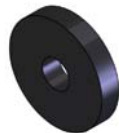

10-24 X 3/8  
BIBB SCREW



FOR BROADWAY 478891  
REPAIR KIT 26.50196 000  
135680

.875 x .750 x .062  
O-RING



.625 x .437 x .187  
STEM PACKING



.625 x .450 x .050  
BRASS WASHER



3/8 BIBB WASHER



10-24 X 3/8  
BIBB SCREW



9/16 -27 SEAT

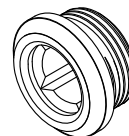

# REPAIR KITS

FOR ELJER PRISON VALVE REPAIR KIT

LF132080

SECURITY SEAT WASHER

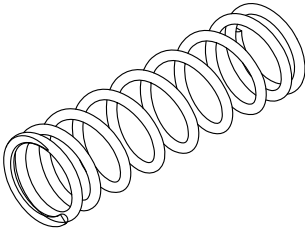

SPRING

SECURITY COLLAR

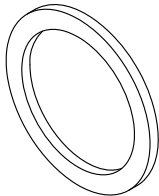

GASKET

SECURITY COLLAR

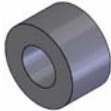

PACKING

PACKING NUT

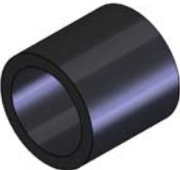
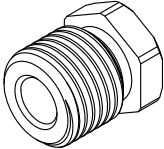

RUBBER GASKET

CAP

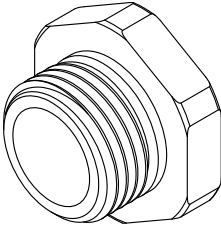

GASKET

VALVE HEAD

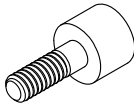
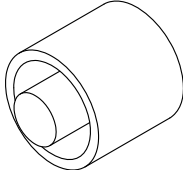

VALVE STEM



# REPAIR KITS

## FOR CHICAGO REPAIR KIT 124870



## FOR KOHLER PRISON VALVE REPAIR KIT LF115100

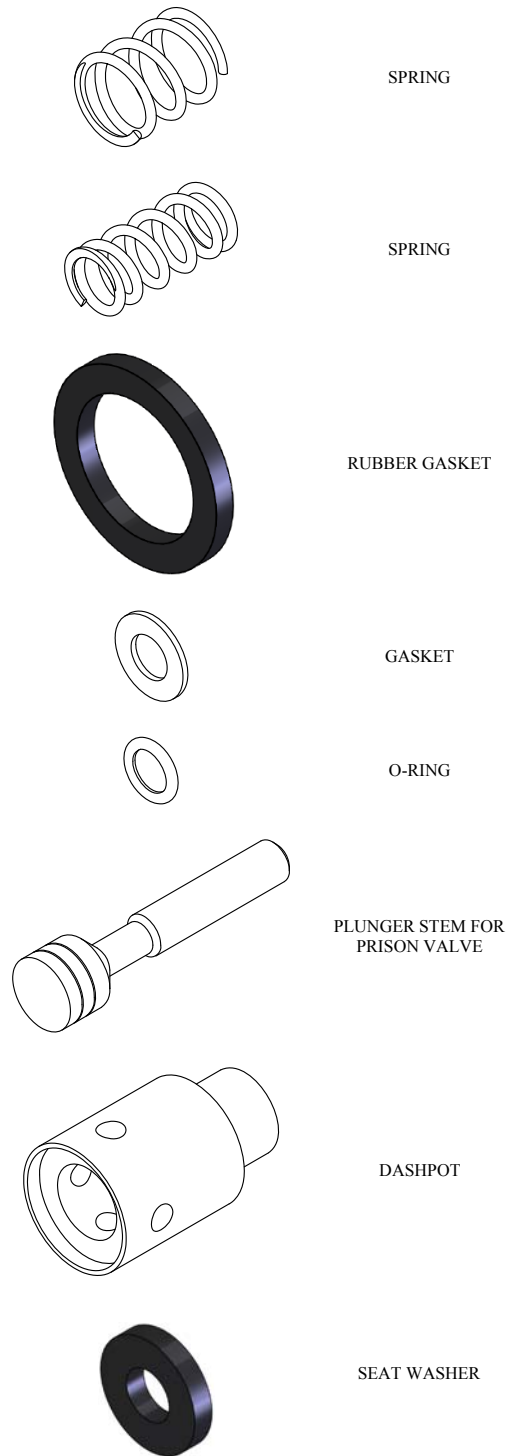

REPAIR KIT #134180 ALSO AVAILABLE  
LESS LEAD FREE DASHPOT

# REPAIR KITS

FOR PRICE PFISTER 452801/2 REPAIR KIT  
135140



CLIP



STOP RING



CERAMIC DISC  
1/4 TURN



CERAMIC DISC  
1/4 TURN



SMALL SEAL

# REPAIR KITS

FOR SAVOY DIVERTER 438901  
RETAINER KIT  
148090

RETAINER

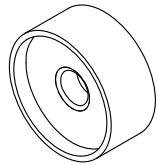

BIBB WASHER x 2



1/4-20 BRASS NUT



FOR SYMMONS C-5 KIT-B  
102310

1/4"-20 x 1/2"  
SET SCREW  
STAINLESS STEEL



2.25 x 2.00 x .062  
GASKET

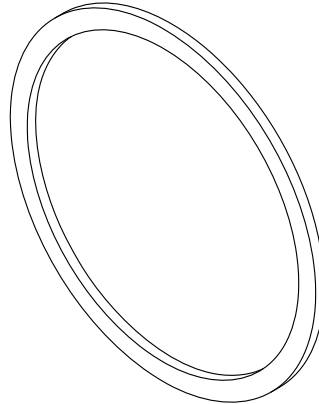

.812 x .500 x .562  
STEM PACKING

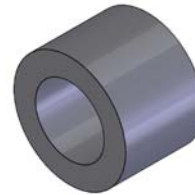

HOT WASHER  
T-6



COLD WASHER  
T-8



10-32 x 5/16"  
BIBB SCREW



RETAINER RING  
T-7

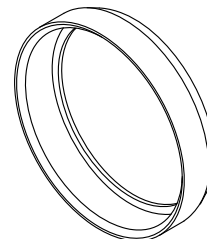

# REPAIR KITS

FOR SYMMONS TA-10 KIT TA-9  
108470

1.562 x 1.375 x .062  
GASKET

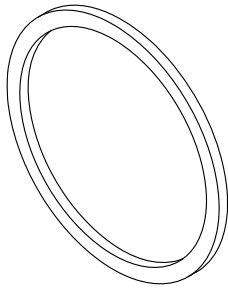

HOT WASHER  
T-6



COLD WASHER  
T-8

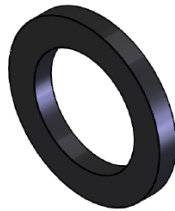

10-32 x 5/16"  
BIBB SCREW



RETAINER RING  
T-7

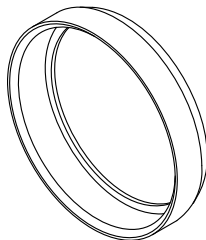

FOR SYMMONS MONO-MIXER  
REPAIR KIT  
113810

LARGE SEAT WASHER



SMALL SEAT WASHER



1.030 x .875 x .062  
GASKET

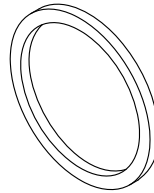

1.218 x 1.062 x .062  
GASKET

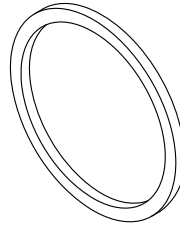

1.562 x 1.375 x .062  
GASKET

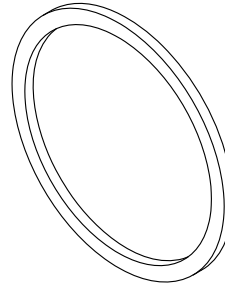

.750 x .500 x .313  
STEM PACKING



8-32 x 1 1/4  
BIBB SCREW

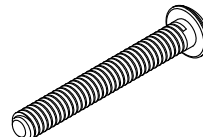

# REPAIR KITS

FOR SYMMONS SHOWER-OFF  
REBUID KIT NS-13R

134110

SEAT  
NS-7

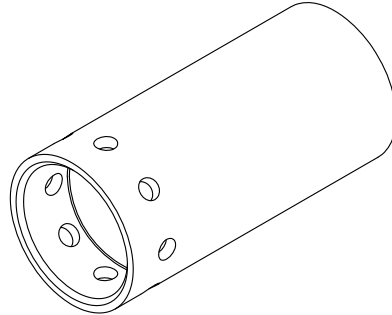
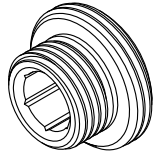

CAGE CYLINDER  
NS-6

BUSHING GUIDE  
NUT WASHER  
NS-14



.375 x .250 x .062  
O-RING

SCREW NS-9

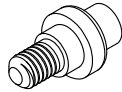

.750 x .562 x .094  
O-RING

STAINLESS ROD  
NS-16

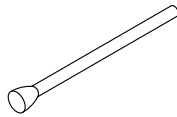

1.312 x 1.125 x .094  
O-RING

SPRING  
NS-13

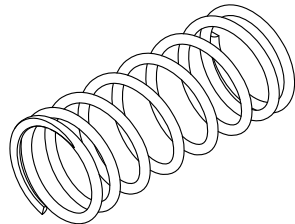

1.25 x 1.00 x .125  
O-RING

RETAINER PISTON  
NS-8

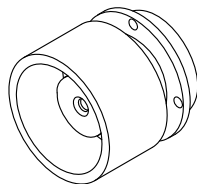

.687 x .562 x .032  
GASKET



BIBB WASHER  
NS-11

# REPAIR KITS

FOR SYMMONS TA-16 REPAIR KIT  
123850

.625 x .437 x .094  
O-RING



.687 x .437 x .312  
STEM PACKING



.625 x .450 x .050  
BRASS WASHER

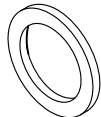

.687 x .453 x .032  
BRASS WASHER

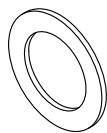

FOR T & S 238A REPAIR KIT  
120350

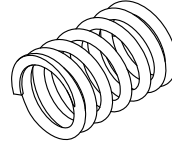

SPRING



BIBB WASHER  
.343 HOLE



.250 x .125 x .062  
O-RING



.375 x .250 x .062  
O-RING



.437 x .312 x .062  
O-RING



.687 x .500 x .094  
O-RING

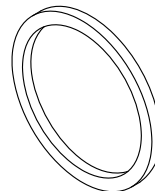

1.030 x .875 x .062  
GASKET

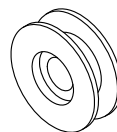

U-CUP HOLDER

# REPAIR KITS

VALVE PLUG STEM KIT  
FOR PLUGGING VALVE BODY  
WHILE STEM IS REMOVED  
103130

SPRING

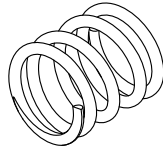

.860 x .468 x .050  
BRASS WASHER

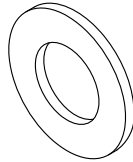

VALVE PLUG STEM

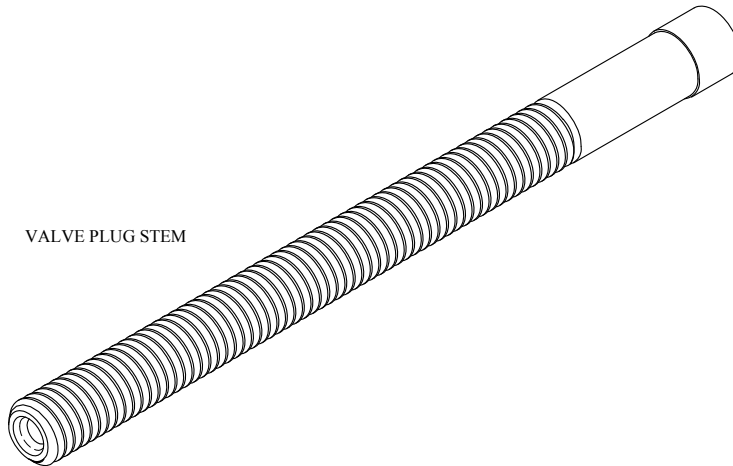

KNURLED NUT

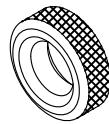

3/8M RETAINER

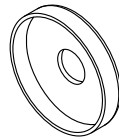

3/8M BIBB WASHER



10-24 X 3/8  
BIBB SCREW



*Send Your Orders To:*

BARRY E.  WALTER SR. CO.

*E-mail: [orderdesk@barrywalter.com](mailto:orderdesk@barrywalter.com)*

*Fax: 1.800.886.9831*

*Phone: 1.800.767.5552*



**BRASS**  
AMERICA  
*Quality Replacement Parts*

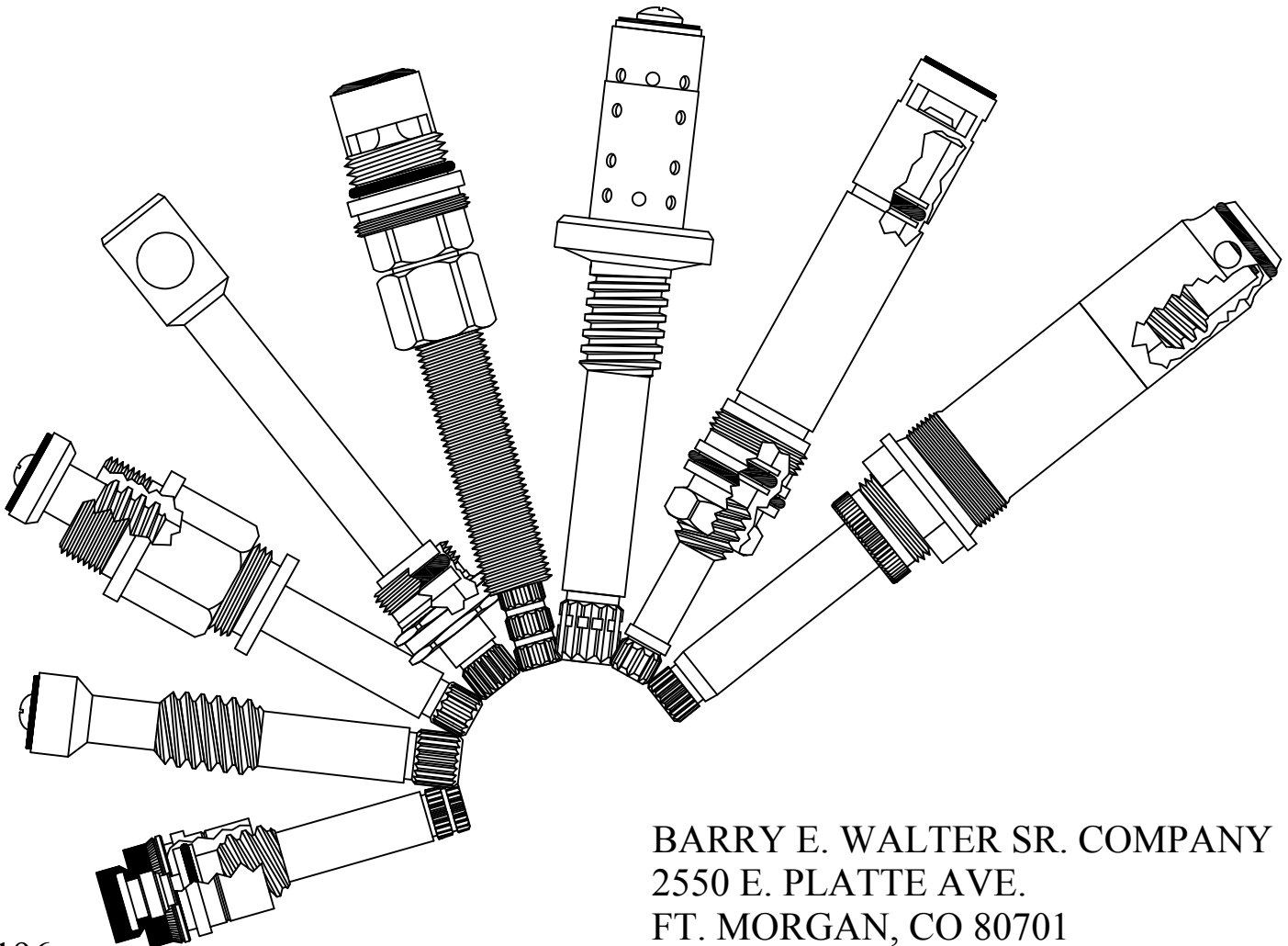

BARRY E. WALTER SR. COMPANY  
2550 E. PLATTE AVE.  
FT. MORGAN, CO 80701



BARRY E.  WALTER SR. CO.

# MISC. PARTS

FLUSHOMETER

FRICTION WASHERS

BALANCING SPOOLS

TOP GASKETS

REPLACEMENT  
BONNETS FOR KOHLER

PACKINGS

SPOUT POSTS & NUTS

DIVERTER WASHERS

DRAIN COMPONENTS

BIBB WASHERS

STEM & HANDLE ID  
GAUGES

SPECIAL WASHERS

O-RINGS

CERAMIC SEALS & DISC  
SETS

CAP GASKETS

SCREWS

SEAT WRENCHES & TOOLS



# FLUSHOMETER PARTS

FOR COYNE DELANEY

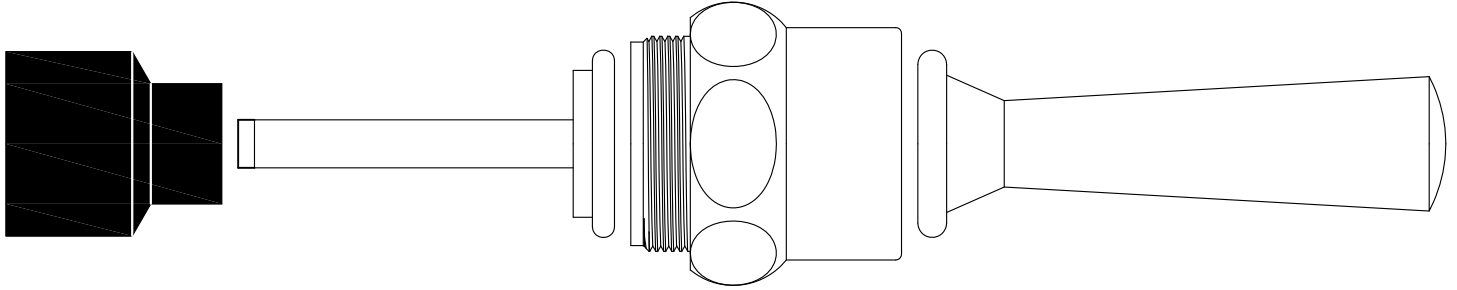

**119900**  
Replaces OEM# F333A  
Includes:  
118080    137920  
137850    161650

**119970**  
Replaces OEM# F333A-C  
Includes:  
118080    137920  
137850    134420

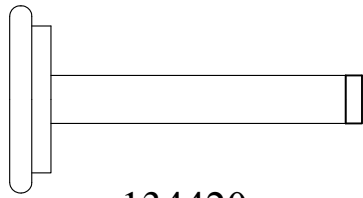

**134420**  
Replaces:  
OEM# F186

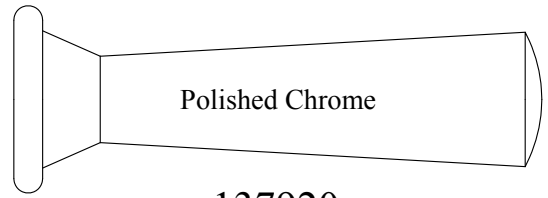

Polished Chrome

**137920**  
Replaces:  
OEM# F-36



**161650**  
Replaces:  
OEM# F223-2

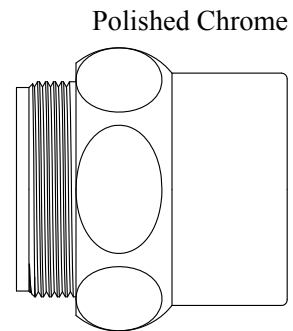

Polished Chrome

**137850**  
Replaces:  
OEM# F-224

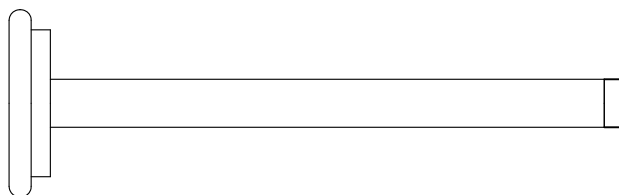

**117450**  
Replaces:  
OEM# F368  
For Push Button Style

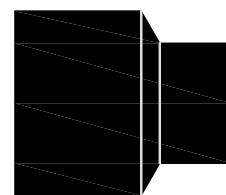

**118080**  
Replaces:  
OEM# F222-3

# FLUSHOMETER PARTS

FOR COYNE DELANEY

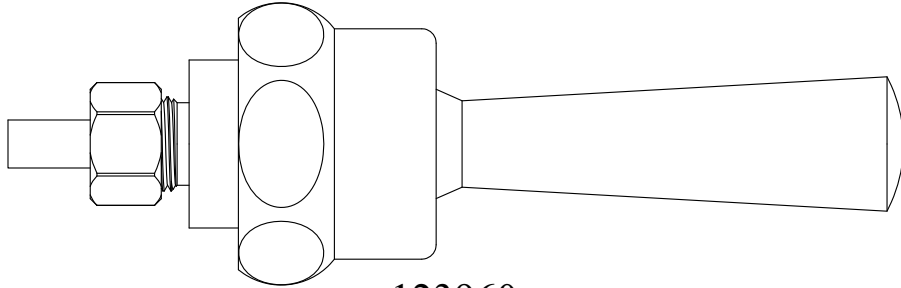

**123960**  
Replaces:  
OEM# F35A

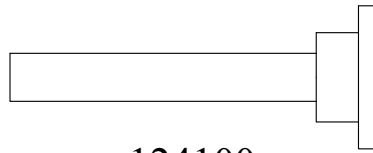

**124100**  
Replaces:  
OEM# F33

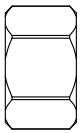

**124240**  
Replaces:  
OEM# F28L

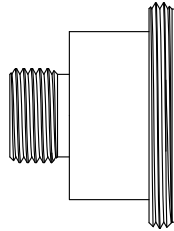

**124170**  
Replaces:  
OEM# F29

Polished Chrome

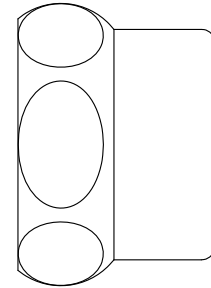

**124030**  
Replaces:  
OEM# F34

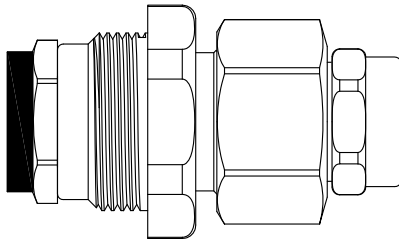

**460302**  
Replaces:  
OEM# F89A-J

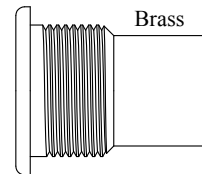

**138340**  
Replaces:  
OEM# R-16, F-16, P-16

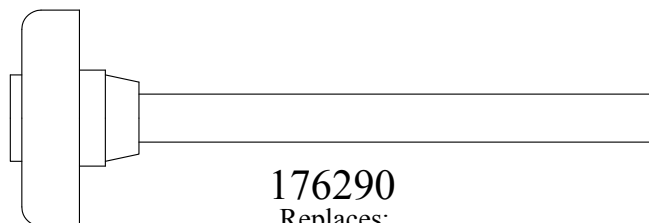

**176290**  
Replaces:  
OEM# F20

# FLUSHOMETER PARTS



**LFF11445**  
FOR CRANE  
Bushing

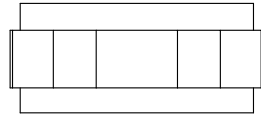

**118830**  
FOR CRANE  
Handle Ring for Flush Valve  
Replaces OEM# F3438

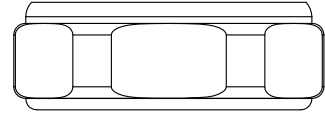

**F11447**  
FOR CRANE  
Handle Eccentric Ring  
for Flush Valve

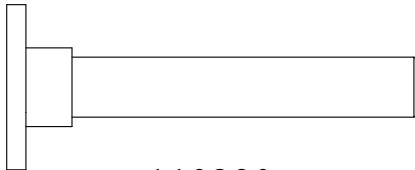

**110290**  
FOR CRANE  
Plunger Assembly

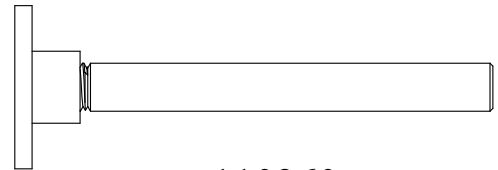

**110360**  
FOR CRANE  
2-1/2" Plunger Assembly

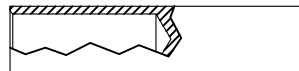

**125320**  
FOR LAWLER  
Push Rod

Chrome Plated Sleeve & Push Button

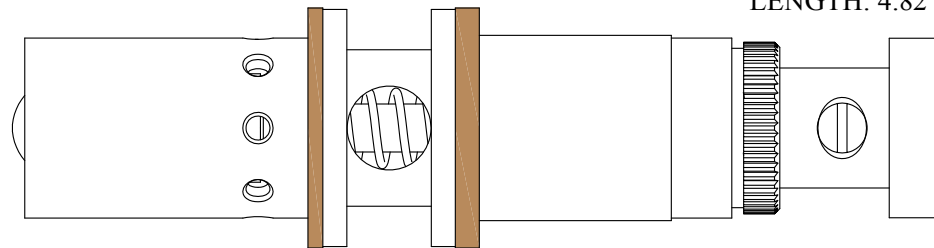

LENGTH: 4.82"

**475700**  
GASKET: 894650 INCLUDED  
FOR PILOT  
Flush Valve

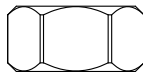

**B-13**  
FOR SLOAN  
Packing Nut  
Replaces: OEM# B-13

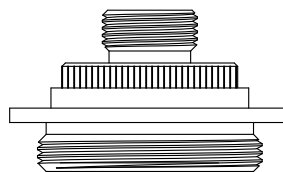

**B-5**  
FOR SLOAN  
Handle Bushing  
Replaces: OEM# B-5

Brass

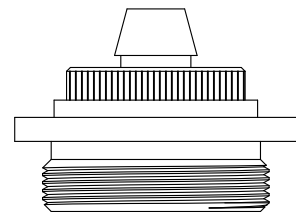

**152290**  
FOR SLOAN  
Bushing  
Replaces: OEM# B-41

Brass

# FLUSHOMETER PARTS

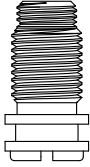

**186240**  
FOR SPEAKMAN  
Spindle  
OEM# 03-0295

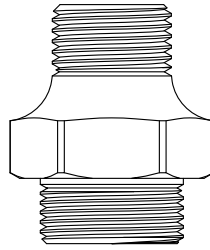

**06-0064**  
FOR SPEAKMAN  
Gland for Urinal Stop

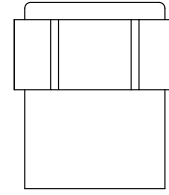

**01-0422**  
FOR SPEAKMAN  
Packing Nut for Urinal Stop

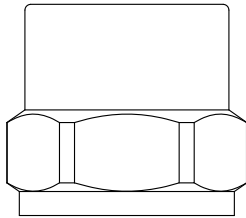

Polished Chrome

**125290**  
FOR SPEAKMAN  
Flush Valve Handle Nut  
OEM# 01-0569

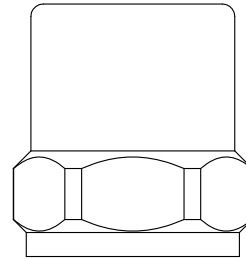

Polished Chrome

**01-0420**  
FOR SPEAKMAN  
Flush Valve Handle Nut

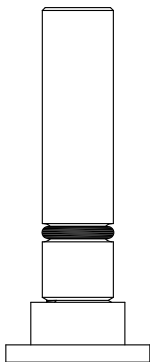

**G05-0394**  
FOR SPEAKMAN  
Plunger



**G05-0397**  
FOR SPEAKMAN  
Plunger Assembly

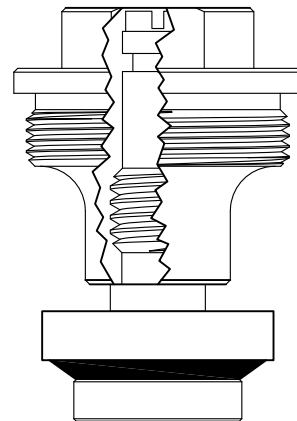

**460401**  
FOR SPEAKMAN  
Stop Unit Assembly

# BALANCING SPOOLS

FOR MOEN

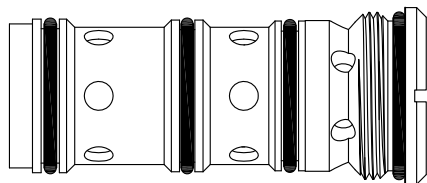

PART# 152920

Stainless Steel Piston & Body  
Solid Brass Slotted Hub  
Replacement for Moen 1423  
Balancing Spool

FOR AMERICAN  
STANDARD  
& DELTA

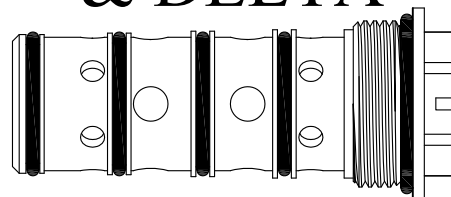

PART# 153340

Stainless Steel Piston & Body  
Solid Brass Slotted Hub  
Replacement for Am. Std.  
10532-07 Balancing Spool  
Replacement for Delta 574  
Balancing Spool

FOR SPEAKMAN

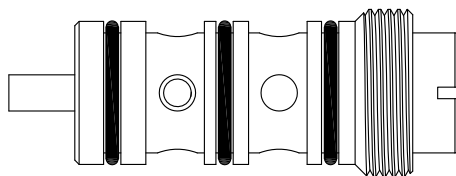

PART# 140970

Brass Sleeve & Plunger

# REPLACEMENT BONNETS for KOHLER

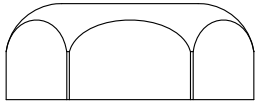

Chrome Plated

759040

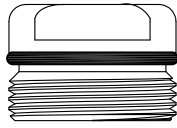

LF760050  
LF760050-P  
Nickel Plated

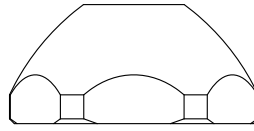

Chrome Plated

763150

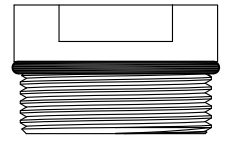

Nickel Plated

LF172580

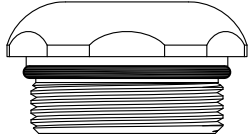

Chrome Plated

LF759100

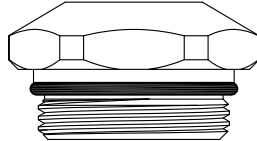

Chrome Plated

LF132900

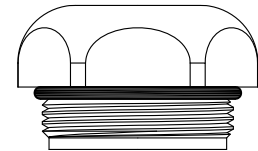

Chrome Plated

LF758040

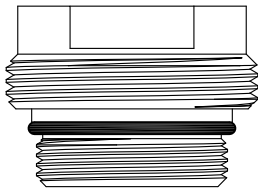

Nickel Plated

120580

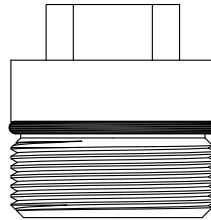

Nickel Plated

116100

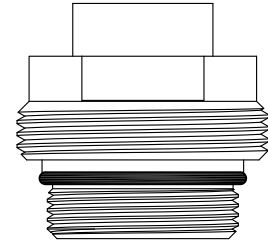

178960

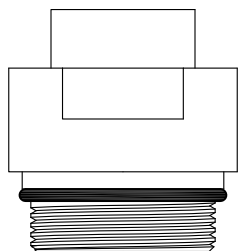

LF113320

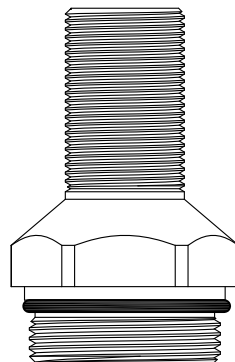

LF770720

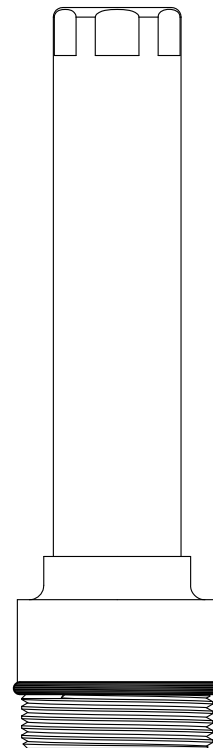

Chrome Plated

707000



# SPOUT POSTS & NUTS

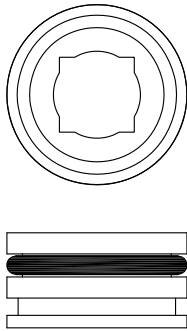

SPOUT POST  
FOR GERBER  
OEM #: 98-230

**LF147390**

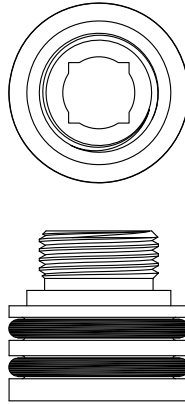

SPOUT POST  
FOR GERBER  
OEM #: 98-210

**LF185890**

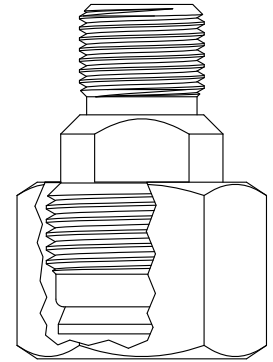

GOOSE NECK  
SPOUT ADAPTER

**LF114650**

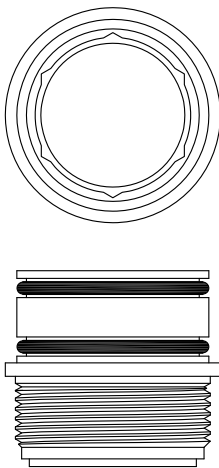

SPOUT POST  
FOR GERBER  
OEM #: 92-642

**LF190220**

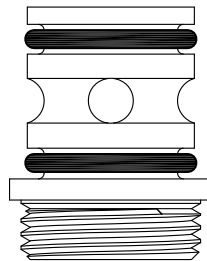

SPOUT POST  
FOR KOHLER  
OEM #: 34311

**LF183510**

Nickel Plated

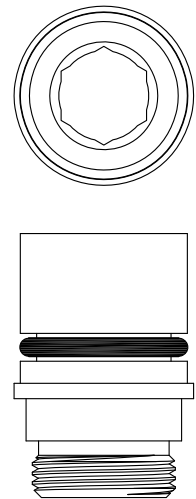

SPOUT POST  
FOR PRICE PFISTER  
OEM #: 970-180-12

**LF189180**

# SPOUT COMPONENTS

FOR CRANE



SPOUT NUT  
107560

FOR P E GUERIN

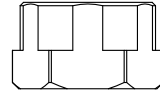

SPOUT TUBE NUT  
125410

FOR CONCINITY

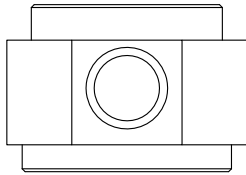

TEE  
117760

FOR BRIGGS

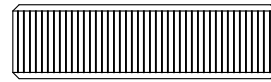

SPOUT NUT  
125410

*Send Your Orders To:*

BARRY E.  WALTER  SR. CO.

*E-mail: [orderdesk@barrywalter.com](mailto:orderdesk@barrywalter.com)*

*Fax: 1.800.886.9831*

*Phone: 1.800.767.5552*

# DRAIN COMPONENTS

## COMPLETE POP-UP DRAIN ASSEMBLY FOR CONCINNITY

CHROME PLATED  
30334CH

SATIN NICKEL  
30334SN

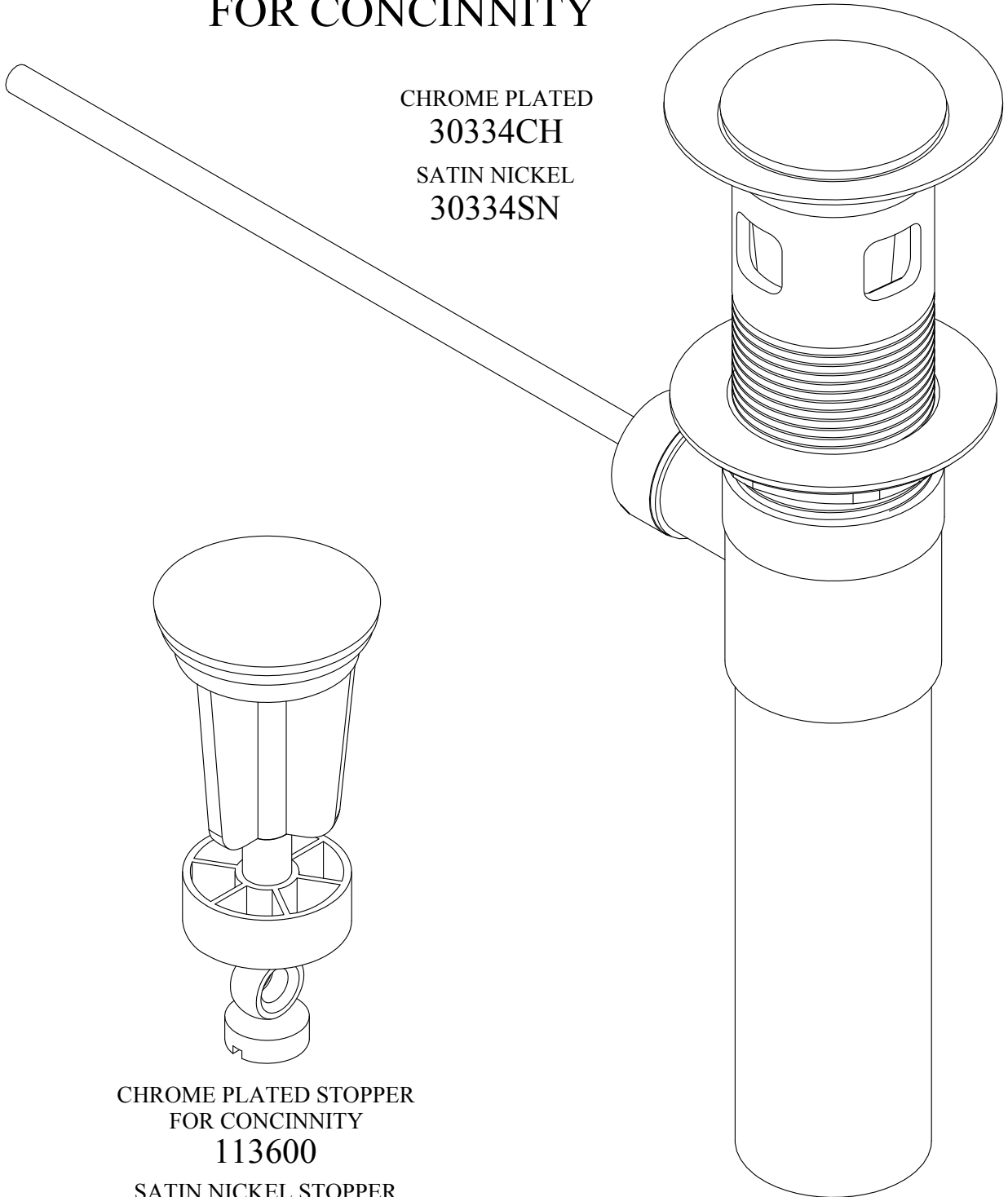

CHROME PLATED STOPPER  
FOR CONCINNITY  
113600

SATIN NICKEL STOPPER  
FOR CONCINNITY  
109820

# DRAIN COMPONENTS

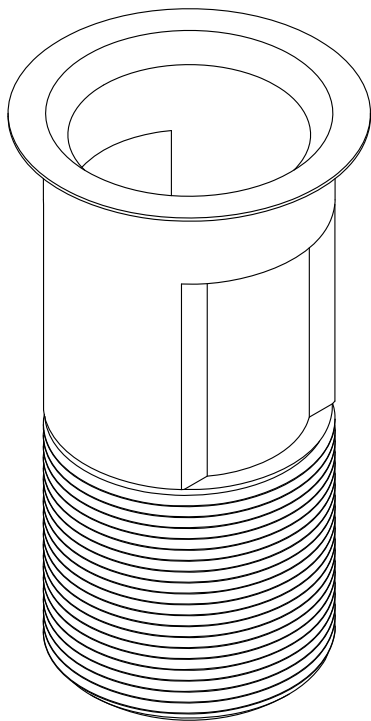

1-7/8" - 11.5 TPI

POLISHED CHROME DRAIN  
FOR CRANE  
140160-CP

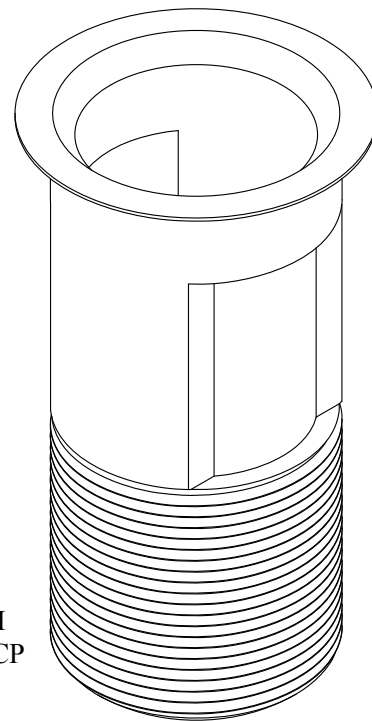

1-13/16" - 14 TPI  
Fits with 122630-CP  
(Original nut)

POLISHED CHROME DRAIN  
FOR CRANE  
142930-CP

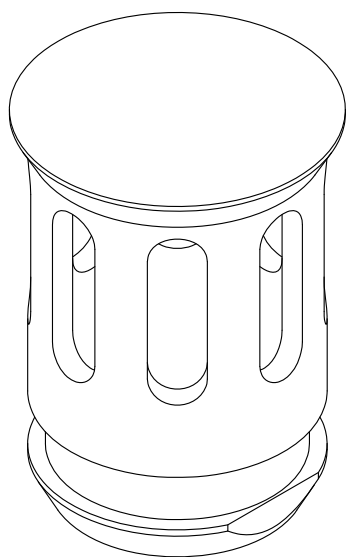

POLISHED CHROME STOPPER  
FOR CRANE  
140230-CP

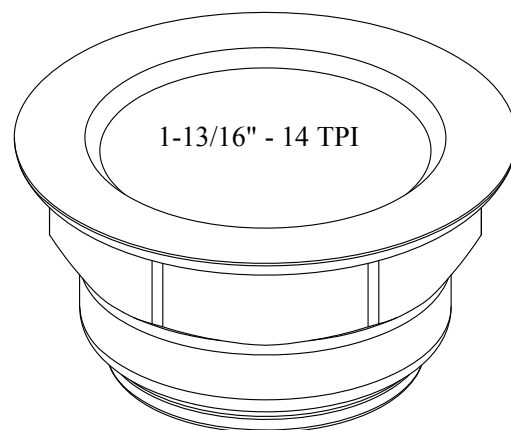

1-13/16" - 14 TPI

POLISHED CHROME DRAIN NUT  
FOR CRANE  
122630-CP

# DRAIN COMPONENTS

## POP-UP RODS

Chrome Plated Rod & Plastic Ball

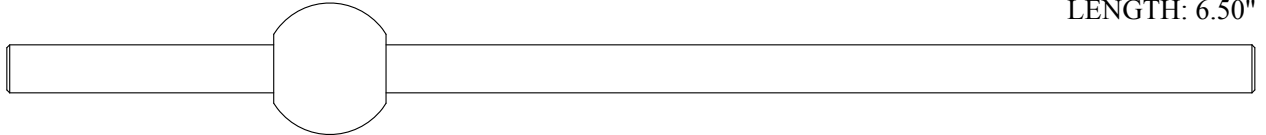

HORIZONTAL POP-UP ROD FOR HARDEN  
133390

LENGTH: 6.85"

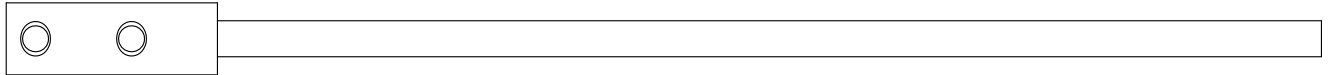

POP-UP LIFT ROD EXTENSION KIT  
127670

Polished Brass



POP-UP ROD FOR PRICE PFISTER  
119440

# DRAIN COMPONENTS

## PIVOT NUTS

FOR UNION BRASS

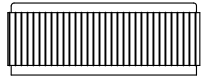

7/8 - 20 FEMALE

161880

FOR SPEAKMAN

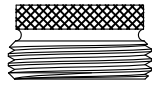

13/16 - 20 MALE

163630

FOR AM STD

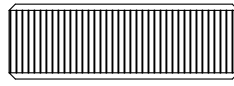

1-1/16 - 20 FEMALE

162160

Nickel Plated

FOR MOEN

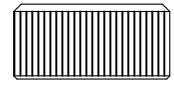

3/4 - 27 FEMALE

162230

FOR KOHLER

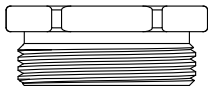

Nickel Plated

15/16 - 20 MALE

164190

FOR SAYCO

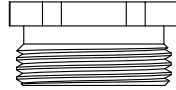

13/16 - 20 MALE

162020

FOR GERBER

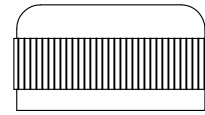

7/8 - 20 FEMALE

167060

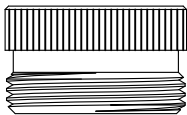

15/16 - 20 MALE

118410

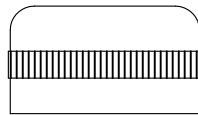

7/8 - 16 FEMALE

117920

FOR MILWAUKEE

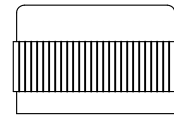

Nickel Plated

3/4 - 24 FEMALE

194540

# STEM & HANDLE ID GAUGES



## Male & Female

All of our ID gauges are  
nickel plated brass!!!

Purchase individually  
or by the set

Short Set - 122170

Long Set - 122100



S  
E  
T

Stamp	Part #	
	Short	Long

Crane - Repeal	1-1	145690	145760
Price Pfister / Harcraft	1-2	145200	143730
American Standard 7/16"	1-4	145410	142400
Sterling	1-5	145340	142470
Central / Kohler (Trend)	1-6	141840	143870
Kohler	1-7	144920	142540
American Standard 3/8"	1-8	141910	142610
Savoy	1-13	141980	142680
Youngstown	2-2	142050	142750
Sayco / Gerber	2-3	144990	142820
Speakman	2-4	142120	142890
Briggs	3-3	145060	142960
Am. Brass / Streamway	3-7	145130	143030
Univesal Rundle	3-10	142190	143100
Michigan (Large)	3-11	142260	143170

Other  
Avail.  
ID's

Chicago	3-12	105950	
Sterling Brass / Cleveland	3-17	142330	
Delta	5-1	160260	
Valley	5-2	160330	
Sears	5-3	106020	
Sterling (Square)	5-5	106230	
Moen	4-5	101260	

# BROACH I.D. GAUGE

2" x 1.5" area  
for custom printing  
or sticker

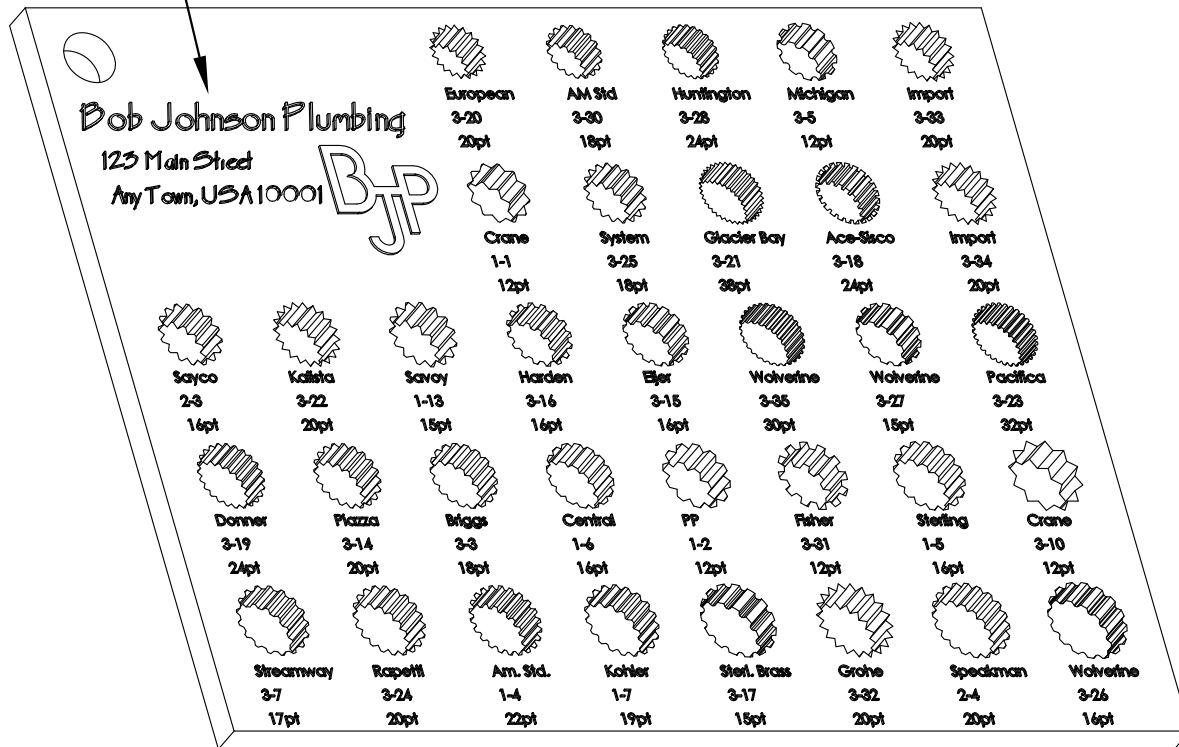

## PART # 113740

This conveniently sized gauge (5.75" x 4.25") includes the following broaches, each labeled with the information listed below:

MANUFACTURER	ID #	POINTS	MANUFACTURER	ID #	POINTS	MANUFACTURER	ID #	POINTS
European	3-20	20	Savoy	1-13	15	Fisher	3-31	12
Am. Std.	3-30	18	Harden	3-16	16	Sterling	1-5	16
Huntington	3-28	24	Eljer	3-15	16	Crane	3-10	12
Michigan	3-5	12	Wolverine	3-35	30	Streamway	3-7	17
Import: 5/16	3-33	20	Wolverine	3-27	15	Eljer Rapetti	3-24	20
Crane	1-1	12	Pacifica	3-23	32	Am. Std.	1-4	22
System	3-25	18	Donner	3-19	24	Kohler	1-7	19
Glacier Bay	3-21	38	Am. Std. Piazza	3-14	20	Sterling Brass	3-17	15
Ace - Sisco	3-18	24	Briggs	3-3	18	Grohe	3-32	20
Import: 11/32	3-34	20	Central	1-6	16	Speakman	2-4	20
Sayco / Gerber	2-3	16	Price Pfister	1-2	12	Wolverine	3-26	16
Kalista	3-22	20						



# O-RINGS

1/16" THICKNESS

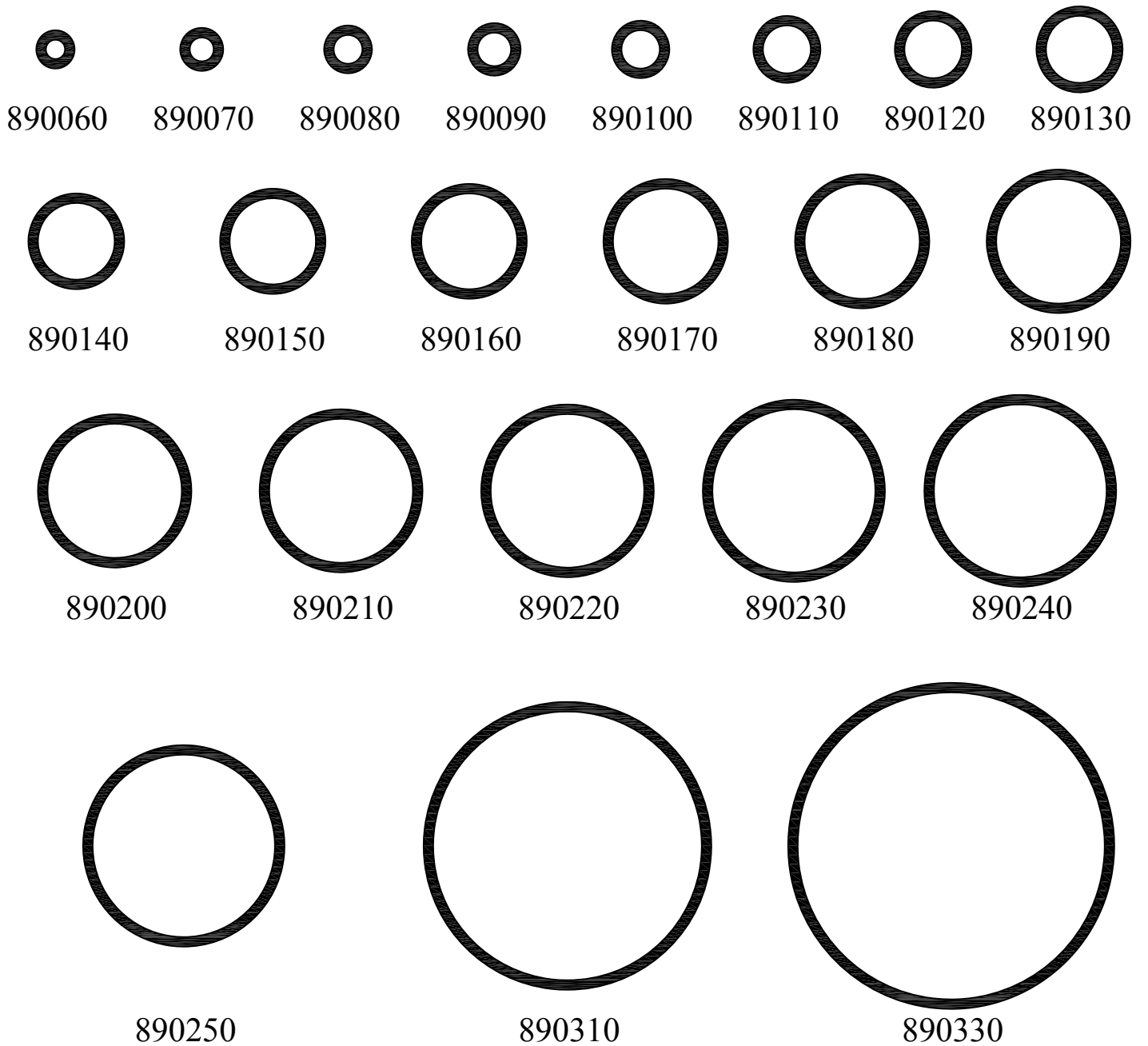

1/16" THICKNESS

PART #	O.D.	I.D.
890060	.250	.125
890070	.281	.156
890080	.312	.187
890090	.343	.218
890100	.375	.250
890110	.437	.312
890120	.500	.375
890130	.562	.437

PART #	O.D.	I.D.
890140	.625	.500
890150	.687	.562
890160	.750	.625
890170	.812	.687
890180	.875	.750
890190	.937	.812
890200	1.000	.875
890210	1.062	.937

PART #	O.D.	I.D.
890220	1.125	1.000
890230	1.187	1.062
890240	1.250	1.125
890250	1.312	1.187
890310	1.875	1.750
890330	2.125	2.000

# O-RINGS

3/32" THICKNESS



891040



891080



891090

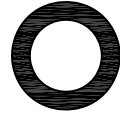

891100



891110

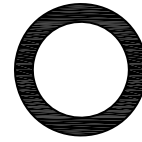

891120

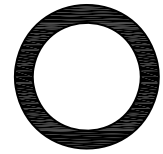

891130

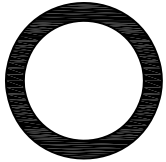

891140

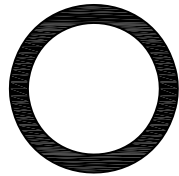

891150

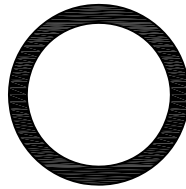

891160

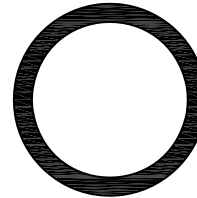

891170

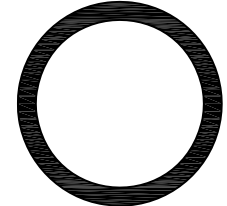

891180

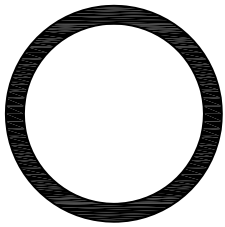

891190

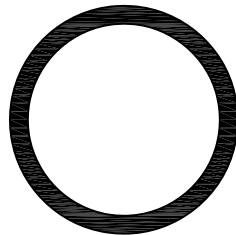

891200

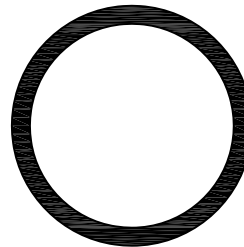

891210

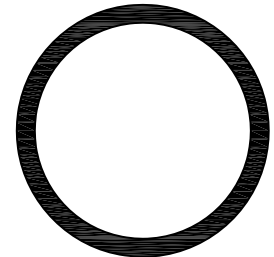

891220

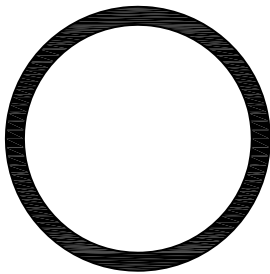

891230

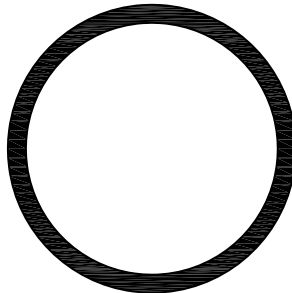

891250

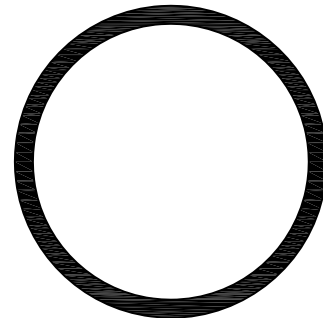

891270

3/32" THICKNESS

PART #	O.D.	I.D.
891040	.312	.125
891080	.437	.250
891090	.500	.312
891100	.562	.375
891110	.625	.437
891120	.687	.500
891130	.750	.562

PART #	O.D.	I.D.
891140	.812	.625
891150	.875	.687
891160	.937	.750
891170	1.000	.812
891180	1.062	.875
891190	1.125	.937
891200	1.187	1.000

PART #	O.D.	I.D.
891230	1.375	1.187
891250	1.500	1.312
891270	1.625	1.437
891210	1.250	1.062
891220	1.312	1.125

# O-RINGS

1/8" THICKNESS



892030



892040



892050

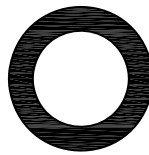

892060

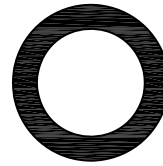

892070

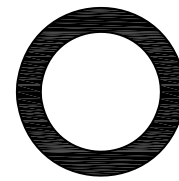

892080

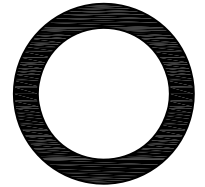

892090

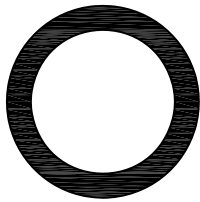

892100

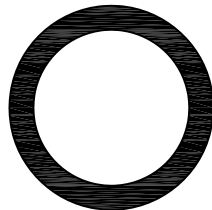

892110

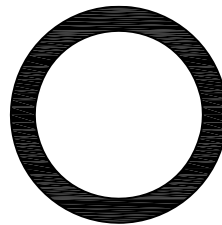

892120

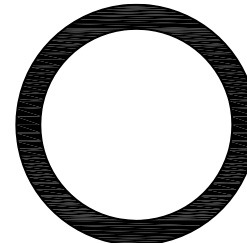

892140

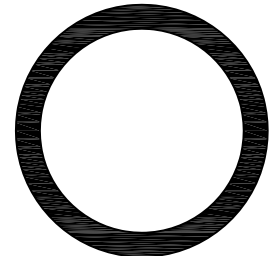

892150

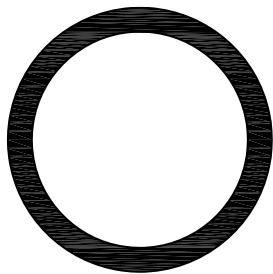

892160

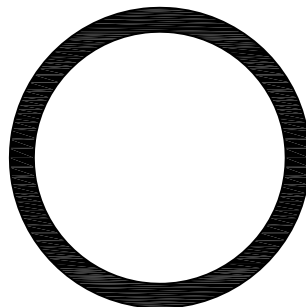

892190

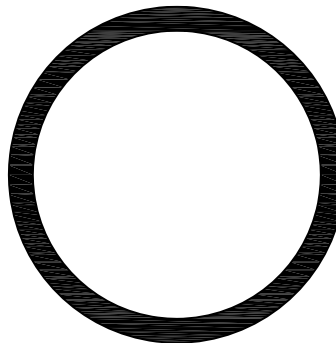

892220



893260

METRIC

SPECIAL



894030



894020



894040



894050



894010



894060

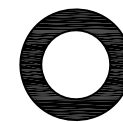

197690  
.109 thickness



116170  
.055 thickness

1/8" THICKNESS

3/16" THICKNESS

METRIC in mm

PART #	O.D.	I.D.
892030	.562	.312
892040	.625	.375
892050	.687	.437
892060	.750	.500
892070	.812	.562
892080	.875	.625
892090	.937	.687
892100	1.000	.750

PART #	O.D.	I.D.
892110	1.062	.812
892120	1.125	.875
892140	1.250	1.000
892150	1.312	1.062
892160	1.375	1.125
892190	1.562	1.312
892220	1.750	1.500

PART #	O.D.	I.D.
893260	2.000	1.625

SPECIAL

PART #	O.D.	I.D.
197690	.578	.359
116170	.599	.489

PART #	O.D.	I.D.
894010	10.0	12.0
894020	5.5	7.1
894030	5.0	7.0
894040	8.0	10.0
894050	8.5	11.0
894060	12.5	15.5

# CAP GASKETS

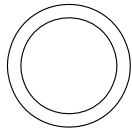

.500 x .640 x .062  
895010

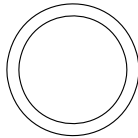

.562 x .687 x .032  
895040



.625 x .695 x .032  
199930

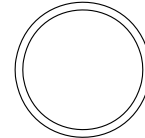

.625 x .705 x .062  
895050

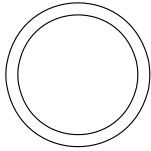

.625 x .750 x .032  
895060

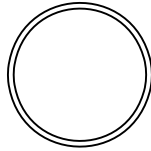

.690 x .750 x .032  
894670

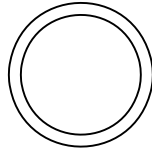

.625 x .750 x .062  
895230

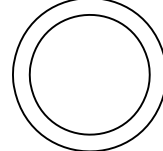

.625 x .800 x .062  
895240

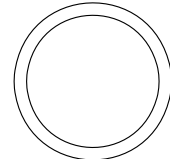

.690 x .820 x .032  
895110

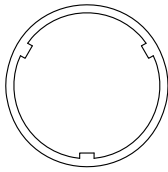

.760 x .845 x .065  
895190

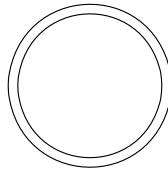

.750 x .850 x .062  
895100

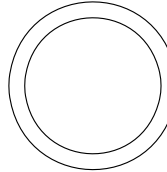

.710 x .875 x .062  
895120

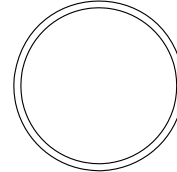

.812 x .885 x .062  
895140

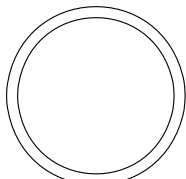

.815 x .930 x .062  
895150

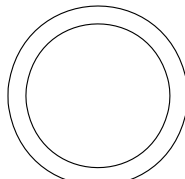

.750 x .937 x .032  
895270

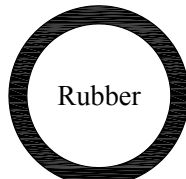

.750 x .937 x .125  
895260

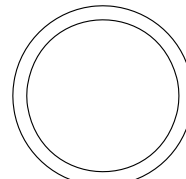

.793 x .937 x .040  
895170

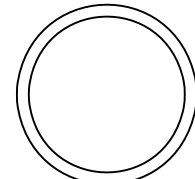

.813 x .937 x .032  
895280

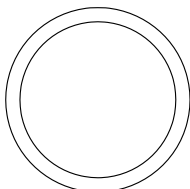

.812 x .960 x .062  
895160

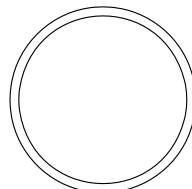

.875 x .968 x .062  
895180

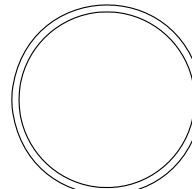

.915 x .990 x .125  
861020

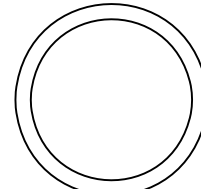

.840 x 1.000 x .062  
895380

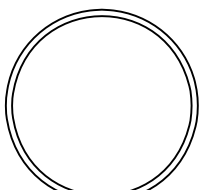

.935 x 1.000 x .032  
895300

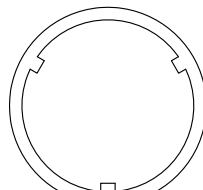

.895 x 1.025 x .065  
895390

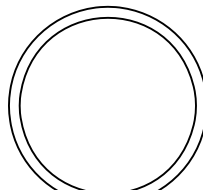

.918 x 1.030 x .030  
895290

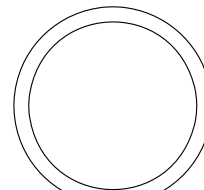

.875 x 1.030 x .062  
895400

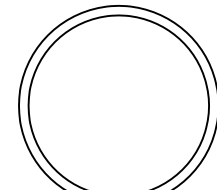

.940 x 1.040 x .062  
895310

Dimensions listed as I.D. x O.D. x Thickness, with the part number listed below.

# CAP GASKETS

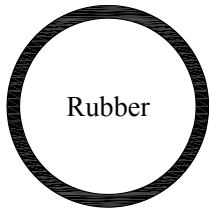

.920 x 1.050 x 1.000  
818010

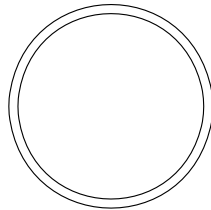

.968 x 1.062 x .062  
895330

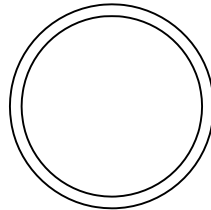

.940 x 1.062 x .062  
895320

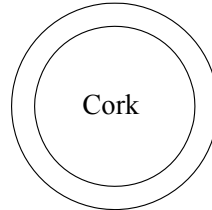

.835 x 1.075 x .094  
895200

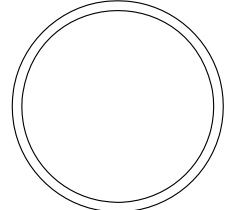

1.000 x 1.100 x .062  
895340

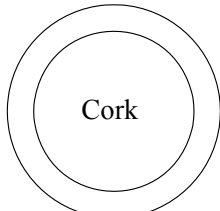

.835 x 1.110 x .135  
895250

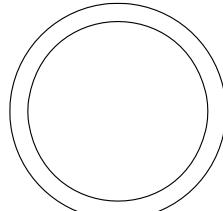

.937 x 1.125 x .062  
895370

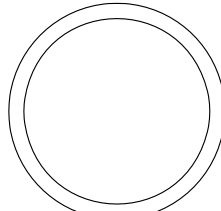

.968 x 1.125 x .062  
895350

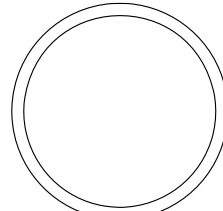

1.000 x 1.125 x .062  
895550

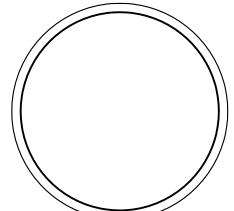

1.032 x 1.125 x .062  
895540

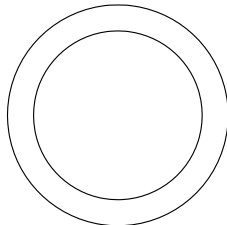

.879 x 1.150 x .062  
895410

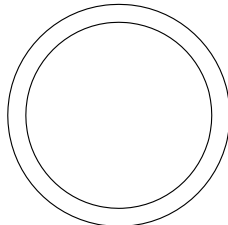

.968 x 1.156 x .062  
199510

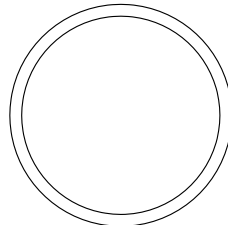

1.032 x 1.156 x .062  
895560

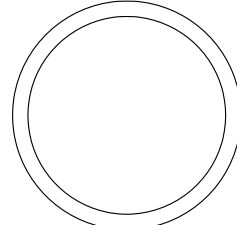

1.030 x 1.190 x .062  
895570

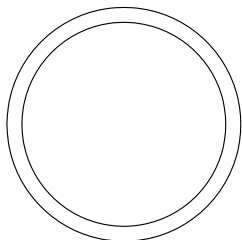

1.062 x 1.218 x .062  
895440

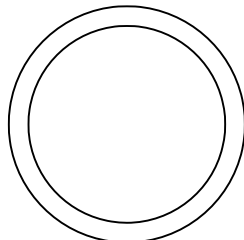

1.025 x 1.230 x .062  
895420

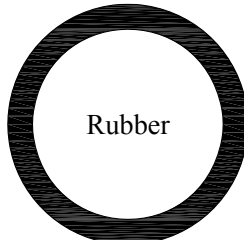

.993 x 1.250 x .125  
818000

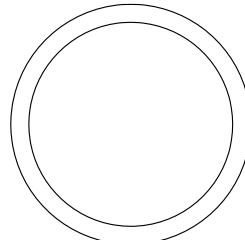

1.062 x 1.250 x .062  
895430

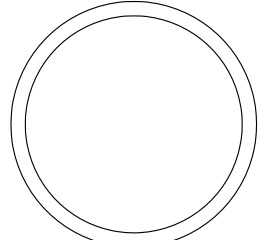

1.130 x 1.280 x .062  
895450

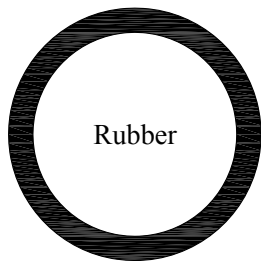

1.062 x 1.315 x .135  
824600

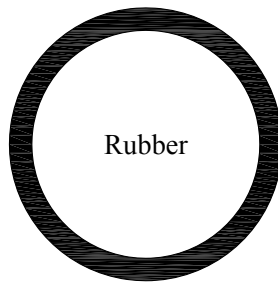

1.187 x 1.421 x .062  
895460

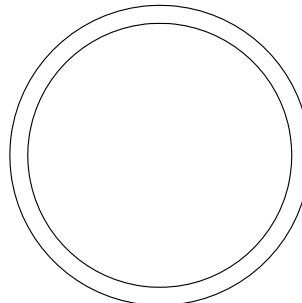

1.375 x 1.562 x .062  
895500

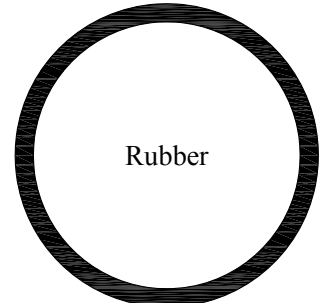

1.390 x 1.580 x .093  
895480

Dimensions listed as I.D. x O.D. x Thickness, with the part number listed below.  
Material may vary unless otherwise noted.

# CAP GASKETS

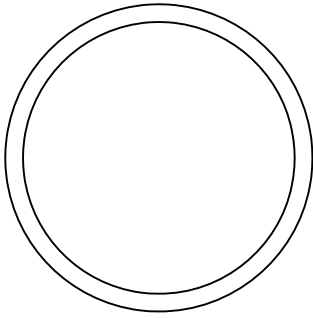

1.415 x 1.600 x .062  
895520

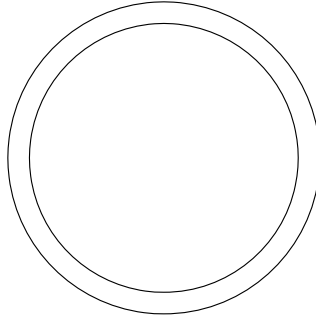

1.400 x 1.625 x .062  
895510

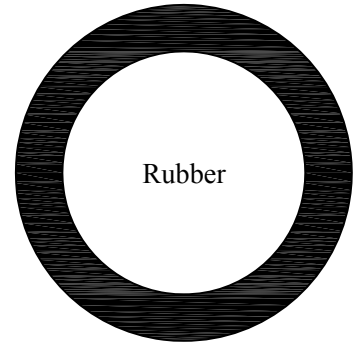

1.750 x 1.265 x .125  
894680

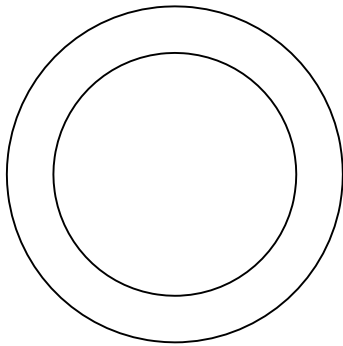

1.750 x 1.265 x .093  
895530

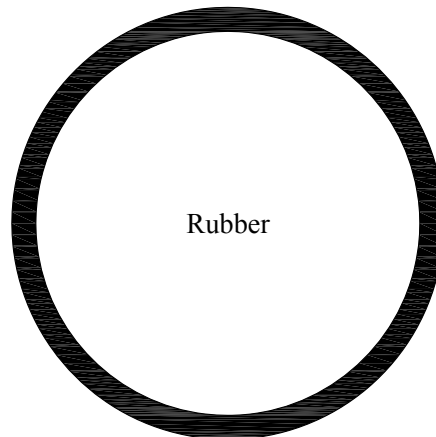

2.000 x 2.250 x .062  
895490

***Send Your Orders To:***

BARRY E.  SR. CO.

***E-mail: [orderdesk@barrywalter.com](mailto:orderdesk@barrywalter.com)***

***Fax: 1.800.886.9831***

***Phone: 1.800.767.5552***

Dimensions listed as I.D. x O.D. x Thickness, with the part number listed below.

# FRICTION WASHERS



895860



895910



895850



895950



895590



895600

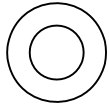

895790

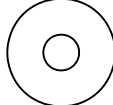

895880

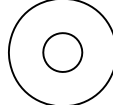

895800

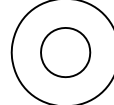

895810

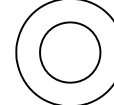

895940

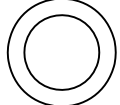

895820

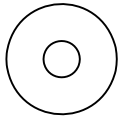

895840

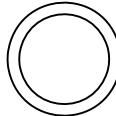

895580

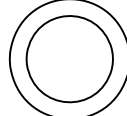

897000

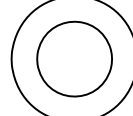

895610

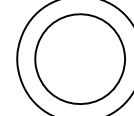

897020

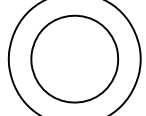

897010

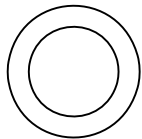

895630

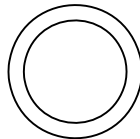

895620

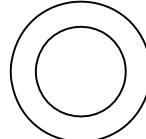

895660

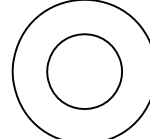

895650

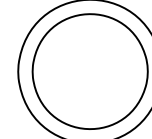

895640

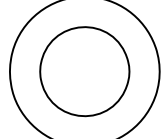

895670

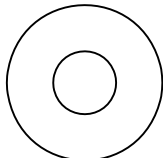

895730

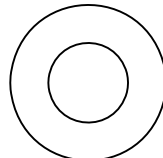

895700

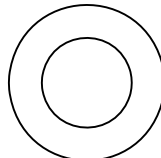

895680

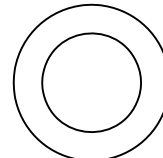

895690

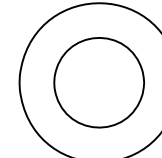

895710

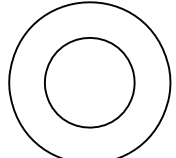

895830

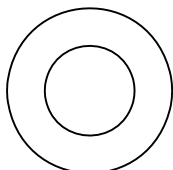

895720

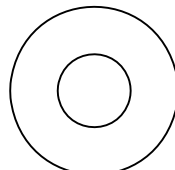

895890

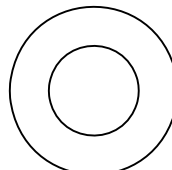

895870

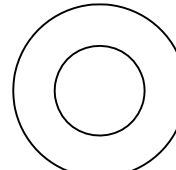

895740

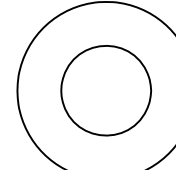

895750

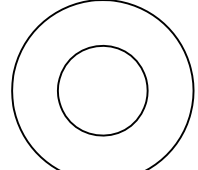

895760

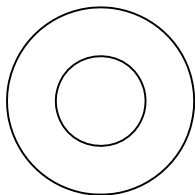

895770

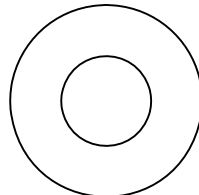

895780

Part #	O.D.	I.D.	Height
895860	.312	.203	.035
895910	.340	.160	.036
895850	.375	.290	.032
895950	.375	.125	.020
895590	.468	.390	.032
895600	.500	.375	.030
895790	.515	.281	.040
895880	.562	.187	.032

Part #	O.D.	I.D.	Height
895800	.562	.203	.062
895810	.562	.257	.062
895940	.562	.315	.090
895820	.562	.390	.025
895840	.575	.189	.050
895580	.590	.468	.032
897000	.625	.450	.050
895610	.656	.390	.040
897020	.656	.468	.030
897010	.687	.453	.032
895630	.687	.468	.030
895620	.695	.535	.032
895660	.730	.468	.050
895650	.750	.390	.040
895640	.750	.600	.050

Part #	O.D.	I.D.	Height
895670	.780	.468	.050
895730	.810	.328	.050
895700	.812	.415	.030
895680	.812	.468	.030
895690	.812	.515	.050
895710	.830	.468	.050
895830	.840	.468	.050
895720	.860	.468	.050
895890	.875	.380	.075
895870	.875	.468	.062
895740	.900	.468	.050
895750	.925	.468	.050
895760	.945	.468	.050
895770	.975	.468	.050
895780	1.000	.468	.050

# TOP GASKETS

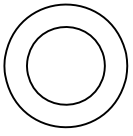

.640 x .406 x .052  
894830

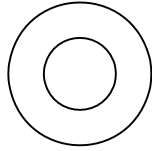

.745 x .375 x .047  
124220

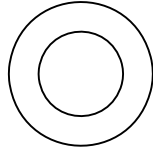

.750 x .442 x .062  
894850

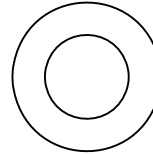

.775 x .437 x .087  
894840

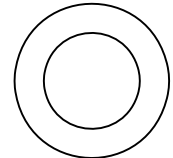

.805 x .500 x .062  
894660

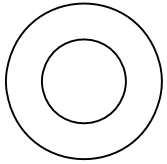

.812 x .437 x .031  
894870

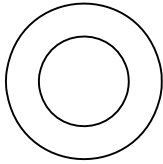

.812 x .468 x .062  
894880

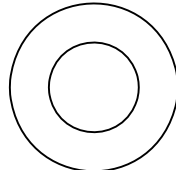

.875 x .468 x .062  
894890

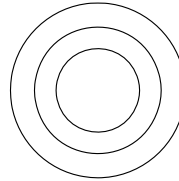
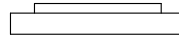

.910 x .435 x .160  
894700  
Delrin

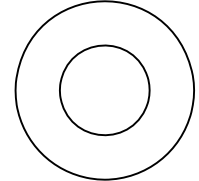

.930 x .468 x .062  
894910

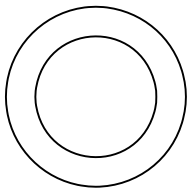

.937 x .630 x .062  
894900

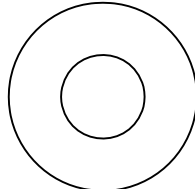

.980 x .435 x .087  
894920

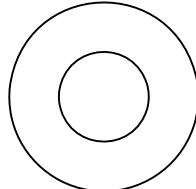

.985 x .468 x .062  
894930

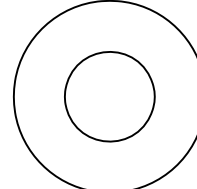

1.000 x .468 x .062  
894940

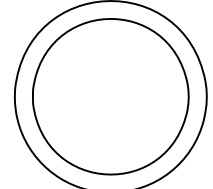

1.000 x .815 x .062  
161390

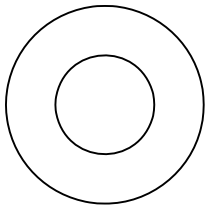

1.030 x .515 x .062  
894860

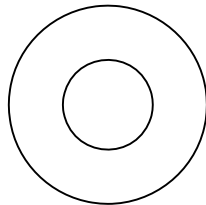

1.032 x .468 x .062  
894950

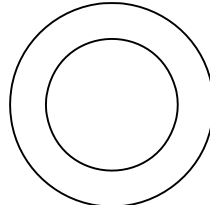

1.060 x .687 x .062  
894820

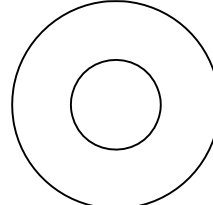

1.080 x .468 x .062  
894960

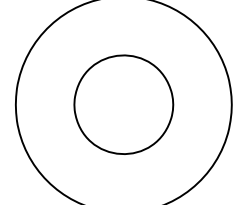

1.125 x .515 x .062  
155290

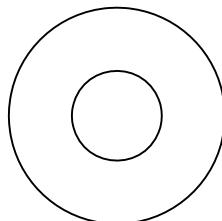

1.125 x .468 x .062  
894970



# PACKINGS

<p>31/64 O.D.</p> <p>3/8"</p> <p>1/4"</p> <p>896010</p>	<p>11/32"</p> <p>9/16 O.D.</p> <p>17/64"</p> <p>896130</p>	<p>3/8"</p> <p>3/16"</p> <p>896410</p>	<p>3/8"</p> <p>1/4"</p> <p>896050</p>	<p>3/8"</p> <p>3/8"</p> <p>896060</p>
<p>7/32"</p> <p>9/32"</p> <p>FOR T&amp;S PRE-RINSE 896430</p>	<p>5/16"</p> <p>19/32 O.D.</p> <p>3/16"</p> <p>896420</p>	<p>3/8"</p> <p>5/8 O.D.</p> <p>7/32"</p> <p>896240</p>	<p>7/16"</p> <p>7/32"</p> <p>896020</p>	<p>5/16"</p> <p>1/4"</p> <p>896350</p>
<p>3/8"</p> <p>5/16"</p> <p>896030</p>	<p>3/8"</p> <p>15/32"</p> <p>896150</p>	<p>13/32"</p> <p>3/16"</p> <p>FOR CHICAGO 896600</p>	<p>13/32"</p> <p>21/32 O.D.</p> <p>1/4"</p> <p>896080</p>	<p>27/64"</p> <p>1/4"</p> <p>896110</p>
<p>11/16 O.D.</p> <p>13/32"</p> <p>1/4"</p> <p>896120</p>	<p>13/32"</p> <p>5/16"</p> <p>896140</p>	<p>3/8"</p> <p>5/16"</p> <p>896070</p>	<p>27/64"</p> <p>17/64"</p> <p>896310</p>	<p>7/16"</p> <p>5/16"</p> <p>896040</p>
<p>29/64"</p> <p>1/8"</p> <p>896190</p>	<p>3/8"</p> <p>23/32 O.D.</p> <p>7/32"</p> <p>FOR AM STD COLONY 896750</p>	<p>3/8"</p> <p>47/64 O.D.</p> <p>23/64"</p> <p>FOR SCHAIBLE 896760</p>	<p>13/32"</p> <p>3/4 O.D.</p> <p>5/16"</p> <p>896100</p>	<p>3/8"</p> <p>5/16"</p> <p>896090</p>
<p>7/16"</p> <p>5/16"</p> <p>896180</p>	<p>13/32"</p> <p>19/64"</p> <p>FOR STERLING 896440</p>	<p>15/32"</p> <p>3/8"</p> <p>896170</p>	<p>1/2"</p> <p>3/16"</p> <p>896250</p>	<p>1/2"</p> <p>5/16"</p> <p>896160</p>
<p>37/64"</p> <p>9/32"</p> <p>896550</p>	<p>19/32"</p> <p>25/32 O.D.</p> <p>11/32"</p> <p>896200</p>	<p>13/32"</p> <p>13/16 O.D.</p> <p>1/4"</p> <p>896220</p>	<p>7/16"</p> <p>5/16"</p> <p>896280</p>	<p>1/2"</p> <p>9/16"</p> <p>896230</p>
<p>27/32 O.D.</p> <p>3/8"</p> <p>5/32"</p> <p>896300</p>	<p>3/8"</p> <p>55/64 O.D.</p> <p>5/16"</p> <p>FOR SCHAIBLE 896770</p>	<p>3/8"</p> <p>7/8 O.D.</p> <p>3/8"</p> <p>896270</p>	<p>5/8"</p> <p>13/64"</p> <p>896500</p>	<p>3/8"</p> <p>9/32"</p> <p>FOR 455121 896610</p>
<p>57/64 O.D.</p> <p>1/2"</p> <p>3/8"</p> <p>896260</p>	<p>7/16"</p> <p>29/32 O.D.</p> <p>5/16"</p> <p>896290</p>	<p>27/64"</p> <p>31/32 O.D.</p> <p>21/64"</p> <p>FOR SCHAIBLE 896780</p>		

# DIVERTER WASHERS

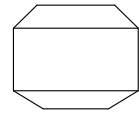
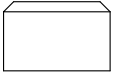
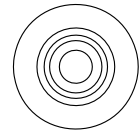
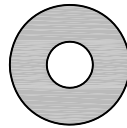
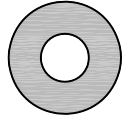

FOR AM STD  
72840-07

FOR SEARS  
157250

FOR SAYCO  
137940

FOR KOHLER  
101310  
OEM# 22942

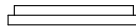
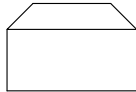
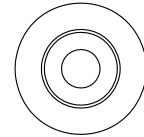
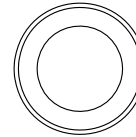
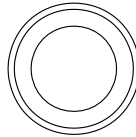
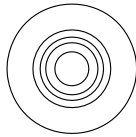
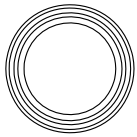

FOR AM STD  
830440

FOR HELVEX  
109050

FOR ELJER  
831000

FOR KOHLER  
833180

FOR PRICE PFISTER  
151580  
OEM# 949-260

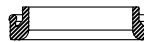
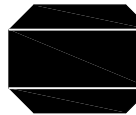
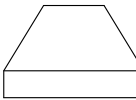
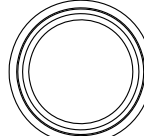
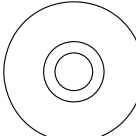
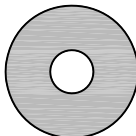
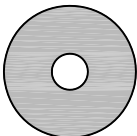

FOR SPEAKMAN  
833000

FOR SAVOY  
144640

FOR SYMMONS  
830720

FOR MUELLER  
838200

FOR AM STD  
830660

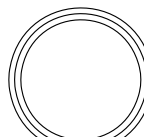
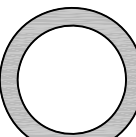
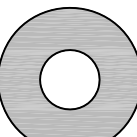

FOR SAVOY  
839120

FOR DICK BROTHERS  
830610

FOR KOHLER  
103340

FOR WOLVERINE  
831070

FOR ELJER  
830190

# DIVERTER WASHERS

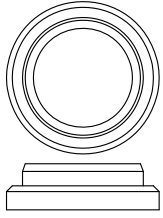

FOR HARDEN  
839720

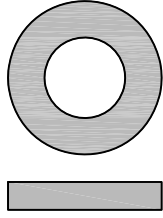

FOR AM. BRASS  
838700

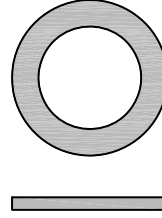

FOR CENTRAL BRASS  
830400

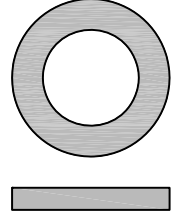

FOR SYMMONS  
833280

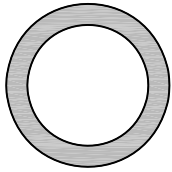

FOR DICK BROTHERS  
835300

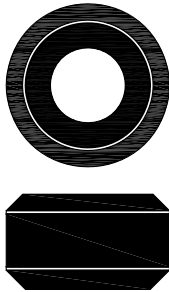

FOR AM STD  
134370

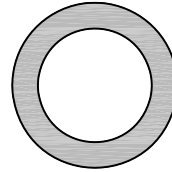

FOR BRIGGS  
831500

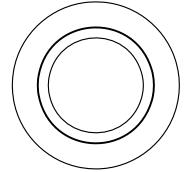

FOR KOHLER  
101380  
OEM# 22927

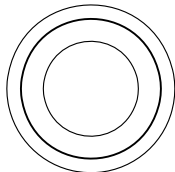

FOR STERLING  
830800

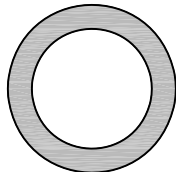

FOR REPCAL  
831900

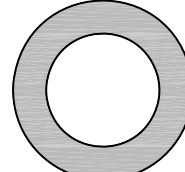

FOR SPEAKMAN  
833200

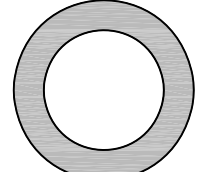

FOR PRICE PFISTER  
830300

BARRY E.  SR. CO.

# BIBB WASHERS

## STANDARD



1/8  
898000



000  
898130



00  
898010  
SOFT: 898170



0  
898020  
SOFT: 898200



1/4  
898030  
SOFT: 898230



1/4L  
898040



3/8  
898050  
HARD: 898250



3/8M  
898060



3/8L  
898070  
HARD: 898270  
SOFT: 898190



1/2  
898080  
HARD: 898280



1/2L  
898090



5/8  
898100

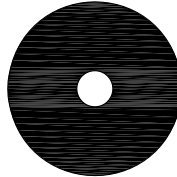

5/8L  
898110

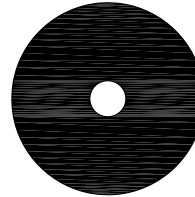

3/4  
898120

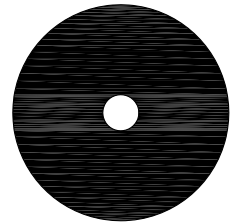

1 1/8  
898140

## BEVELED



00  
898310



0  
898320



1/4  
898330



3/8M  
898360



1/2  
898380

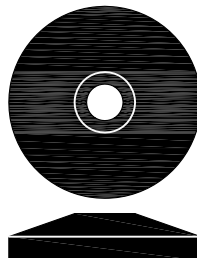

3/4  
898420

# SPECIAL WASHERS



FOR AM. STD.  
156200



FOR CHICAGO  
865040



FOR PRICE PFISTER  
857200  
OEM# 949-360



FOR SYMMONS-HOT  
898150

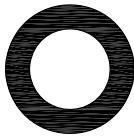

FOR PRICE PFISTER  
858070



FOR AM. STD.  
103270

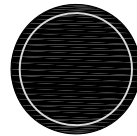

FOR AM. STD.  
853020

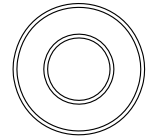

FOR T&S  
862400

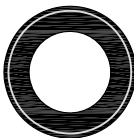

FOR BRIGGS  
853030

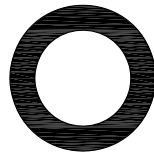

FOR CENTRAL  
862050

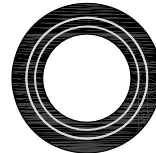

FOR CRANE  
862010  
HARD: 865120  
SOFT: 865150

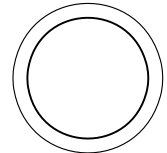

FOR CRANE  
858700

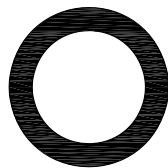

FOR T&S  
138570

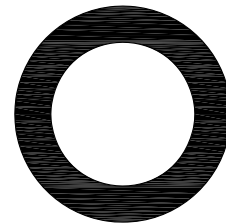

FOR SYMMONS-COLD  
898160

# CERAMIC SEALS

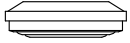
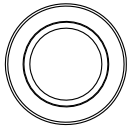

898500

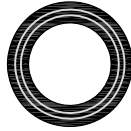

898540 for PP  
OEM# 950-985

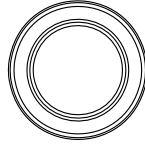

898600

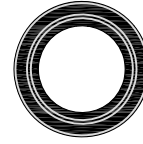

898510

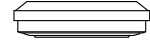
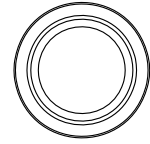

898510-W

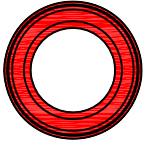

898570-R

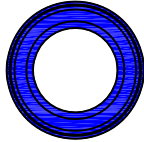

898570-B

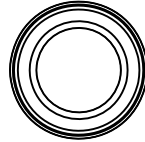

898570-W

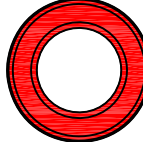

898580-R

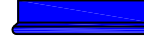
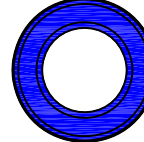

898580-B

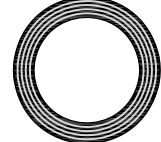

898550 for PP  
OEM# 950-980

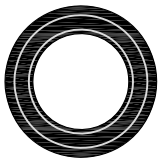

898590

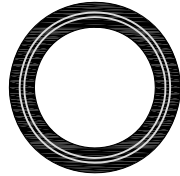

898530

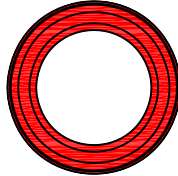

898610-R

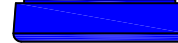
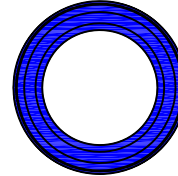

898610-B

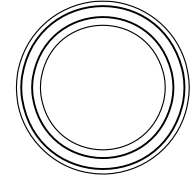

898520

# CERAMIC DISC SETS

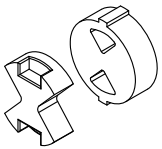

125390-PKG

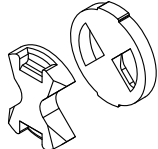

112530-PKG

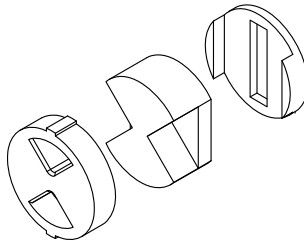

115520-PKG

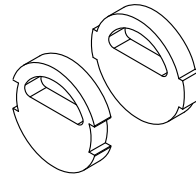

124290-PKG

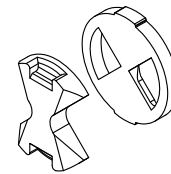

151380-PKG

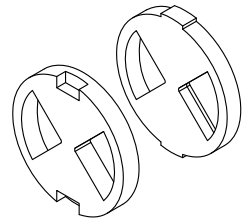

109850-PKG

# CERAMIC DISC & SEAL KITS

132810

KIT INCLUDES:

- (1) 109850-PKG
- (1) 895050 GASKET
- (1) 898520 SEAL

143700

KIT INCLUDES:

- (1) 124290-PKG
- (1) 895180 GASKET
- (1) 898570-R SEAL

143750

KIT INCLUDES:

- (1) 151380-PKG
- (1) 898510-W SEAL

143820

KIT INCLUDES:

- (1) 124290-PKG
- (1) 898550 SEAL

# SCREWS

## Chrome Plated Brass Handle Screws

8-32 x 1/4" Oval	899390
8-32 x 1/2" Oval	899540
8-32 x 1/2" Round	899660
8-32 x 3/4" Oval	899550
8-32 x 3/4" Round	899670
8-32 x 1" Oval	899560
8-32 x 1" Round	899680
10-24 x 1/2" Oval	899570
10-24 x 1/2" Round	899690
10-24 x 3/4" Oval	899580
10-24 x 3/4" Round	899700
10-24 x 1" Oval	899590
10-24 x 1" Round	899710
10-28 x 1/2" Oval	899600
10-28 x 1/2" Round	899720
10-28 x 3/4" Oval	899610
10-28 x 3/4" Round	899730
10-28 x 1" Oval	899620
10-28 x 1" Round	899740
10-32 x 1/2" Oval	899630
10-32 x 1/2" Round	899750
10-32 x 3/4" Oval	899640
10-32 x 3/4" Round	899760
10-32 x 1" Oval	899650
10-32 x 1" Round	899770

Oval Head



Round Head

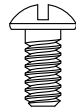

## Brass Bibb Screws - Phillips Head

8-32 x 1/4" Bibb	899130
8-32 x 3/8" Bibb	899010
8-32 x 1/2" Bibb	899410
10-24 x 3/8" Bibb	899020
10-24 x 1/2" Bibb	899420
10-28 x 3/8" Bibb	899040
10-28 x 1/2" Bibb	899440
10-32 x 3/8" Bibb	899030
10-32 x 1/2" Bibb	899430

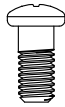

## Brass Screws

8-32 x 1-1/4" Bibb	899080
10-24 x 1-1/2" Bibb	899090
10-32 x 1-1/2" Bibb	899100

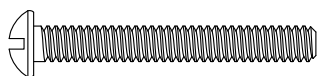

Round Head

10/32 x 1/2"  
Stainless Steel  
Phillister Head

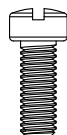

899210

## Stainless Steel Handle Screws

10-24 x 1/2"	192090
10-24 x 3/4"	899380
10-24 x 1-3/4"	199580

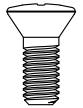

Oval Head

## Stainless Steel Screws

6-32 x 1/4"	899270
8-32 x 1/2"	173560
8-32 x 1-1/2"	899460
10/24 x 1-1/4"	899530
10/32 x 1/2"	155720

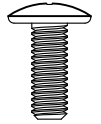

Truss Head

## Stainless Steel Screws

6-32 x 3/16"	899350
10/24 x 1/2"	899140
10/24 x 5/8"	159990
10/32 x 5/16"	899150
10/32 x 1-1/4"	169920
1/4-20 x 1"	899360



Pan Head

## Stainless Steel Screws

8-32 x 1-3/8"	899450
10/24 x 1"	899300
10/24 x 1-1/2"	899310
10/24 x 4"	133250

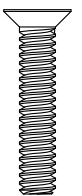

Flat Head

## Stainless Steel Bibb Screws

6-32 x 1/4"	899110
6-32 x 3/8"	156410

## Stainless Steel Screws

8-32 x 2-3/8"	121820
8-32 x 3"	899120
10/24 x 5/8"	899400
10/24 x 3/4"	899480
10/24 x 1-3/4"	104040
10/24 x 2-1/4"	102430
10/32 x 1-1/2"	899330

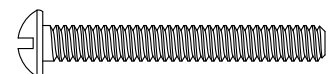

Round Head

# SEAT WRENCHES

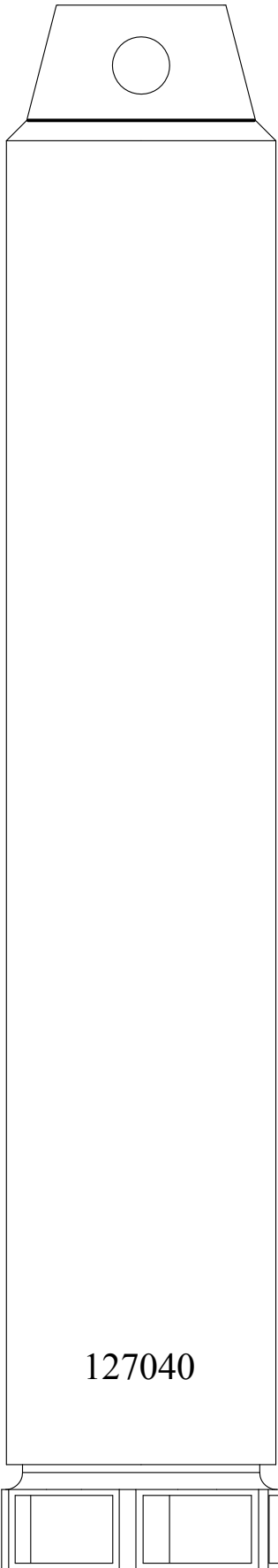

Packaging Tube

127040

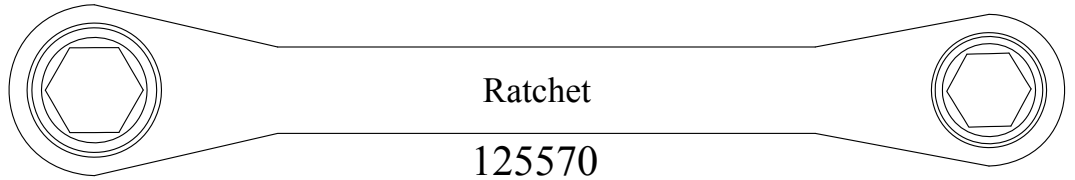

Ratchet

125570

THESE TOOLS ARE ALL HARDENED & COATED WITH BLACK OXIDE WITH THE EXCEPTION OF THE RATCHET

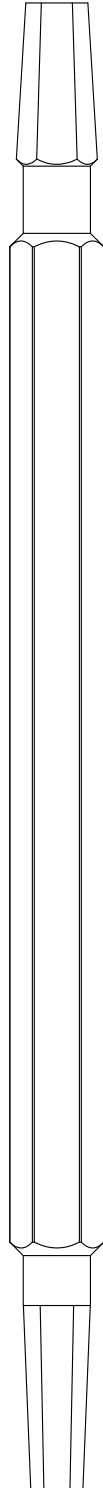

Hex Wrench

121580

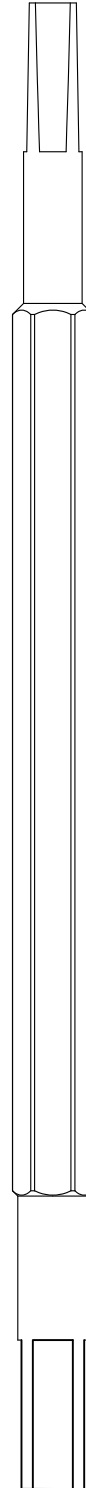

Small Square Wrench

121510

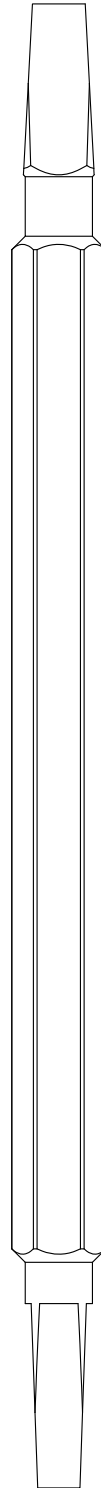

Large Square Wrench

121440



# SEAT WRENCHES

THESE TOOLS ARE ALL HARDENED  
& COATED WITH BLACK OXIDE

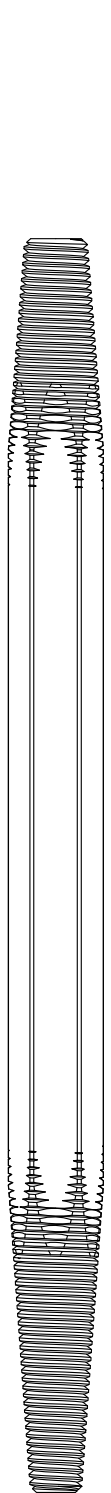

Easy-Out Wrench

134790

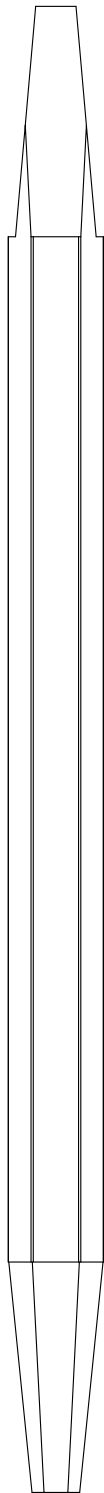

Squex Wrench

121650



Mobile Home Wrench

192790

## Available Wrench Kits

125500 - Kit Includes:  
Packaging Tube with  
Hex Wrench  
Small Square Wrench  
Large Square Wrench  
and Ratchet Wrench

132850 - Kit Includes:  
All items from 125500  
+ Easy-Out Wrench

132920 - Kit Includes:  
All items from 125500  
+ Squex Wrench

132990 - Kit Includes:  
All items from 125500  
+ Easy-Out Wrench  
and Squex Wrench

# SEAT WRENCHES

THESE TOOLS ARE ALL HARDENED & COATED WITH BLACK OXIDE

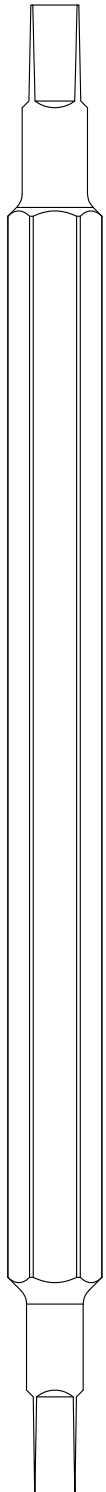

Small Square Wrench

116450

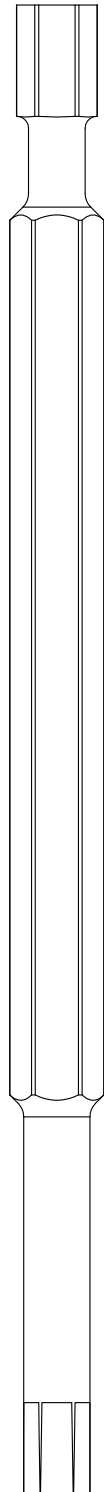

Small Hex Wrench

116730

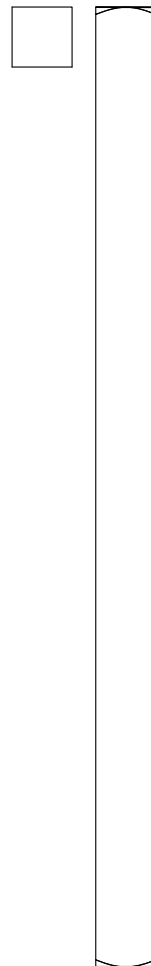

Symmons Hot Seat Wrench

123220

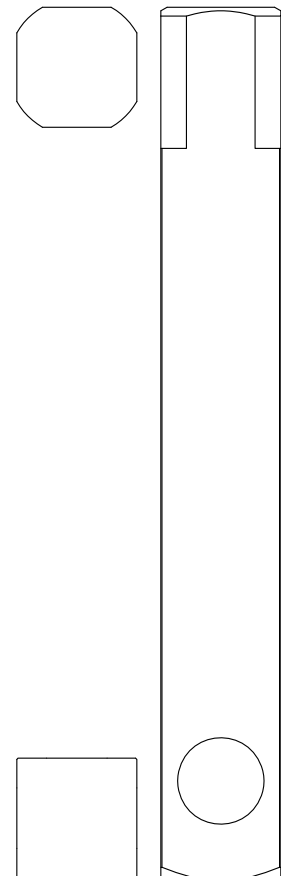

Symmons Hot Cold Wrench

123240

## Available Wrench Kits

123150 - Kit Includes:  
Symmons Hot Seat Wrench  
Symmons Cold Seat Wrench

# SEAT WRENCHES

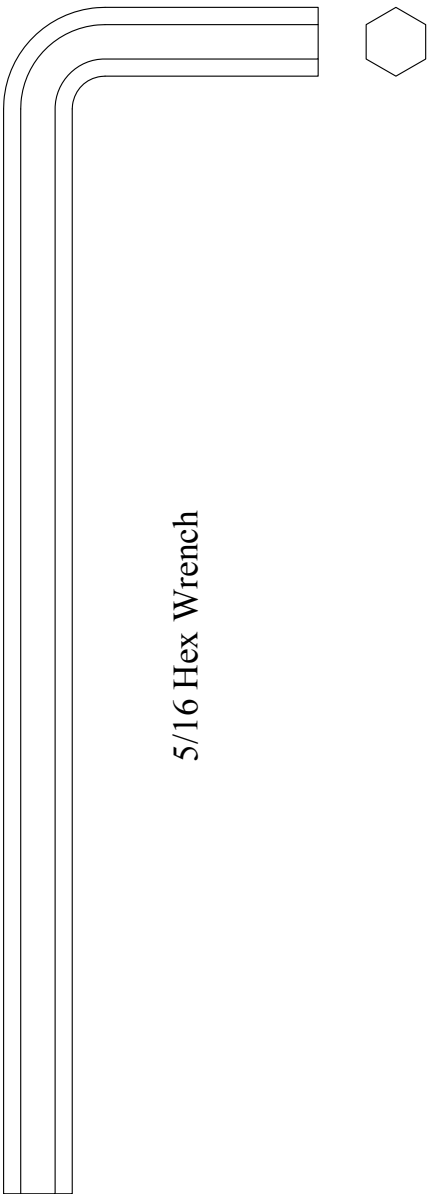

5/16 Hex Wrench

127720

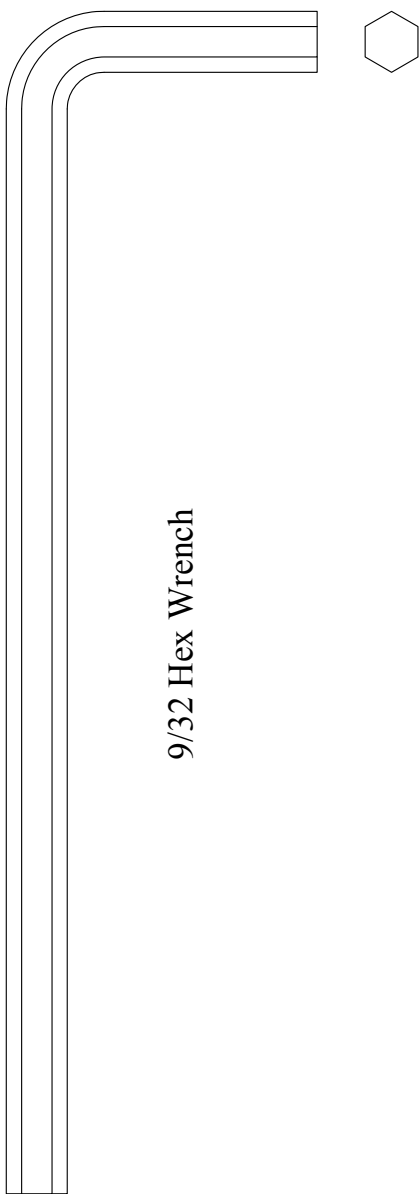

9/32 Hex Wrench

127790

*Send Your Orders To:*

BARRY E.  ALTER SR. CO.

*E-mail: [orderdesk@barrywalter.com](mailto:orderdesk@barrywalter.com)*

*Fax: 1.800.886.9831*

*Phone: 1.800.767.5552*

# ONA PULLER

**FOR EXTRACTING MOEN VALVE CARTRIDGES**

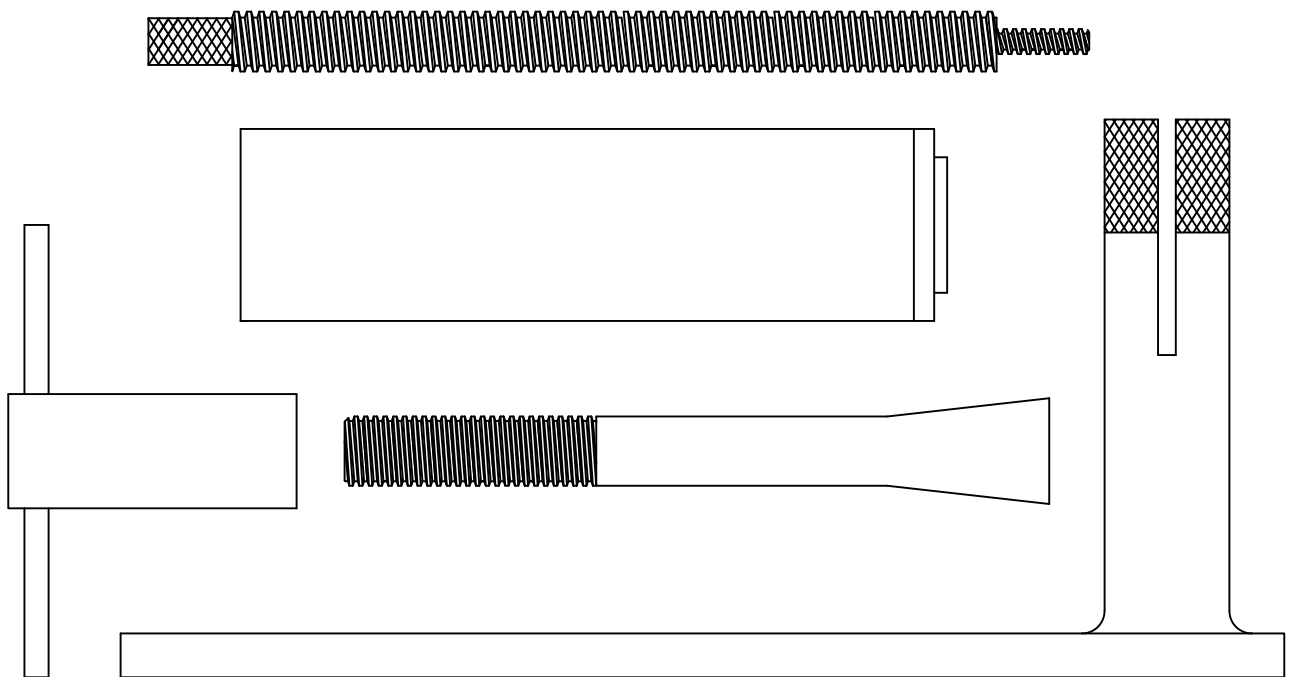
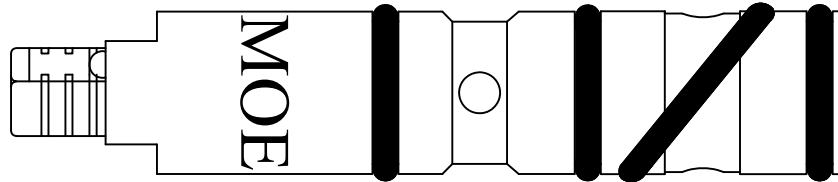

**PART# 999150**

ALL TOOLS ARE DRAWN TO SCALE  
ALL TOOLS ARE HARDENED & COATED WITH BLACK OXIDE

# WASTE SHOE REMOVAL TOOL

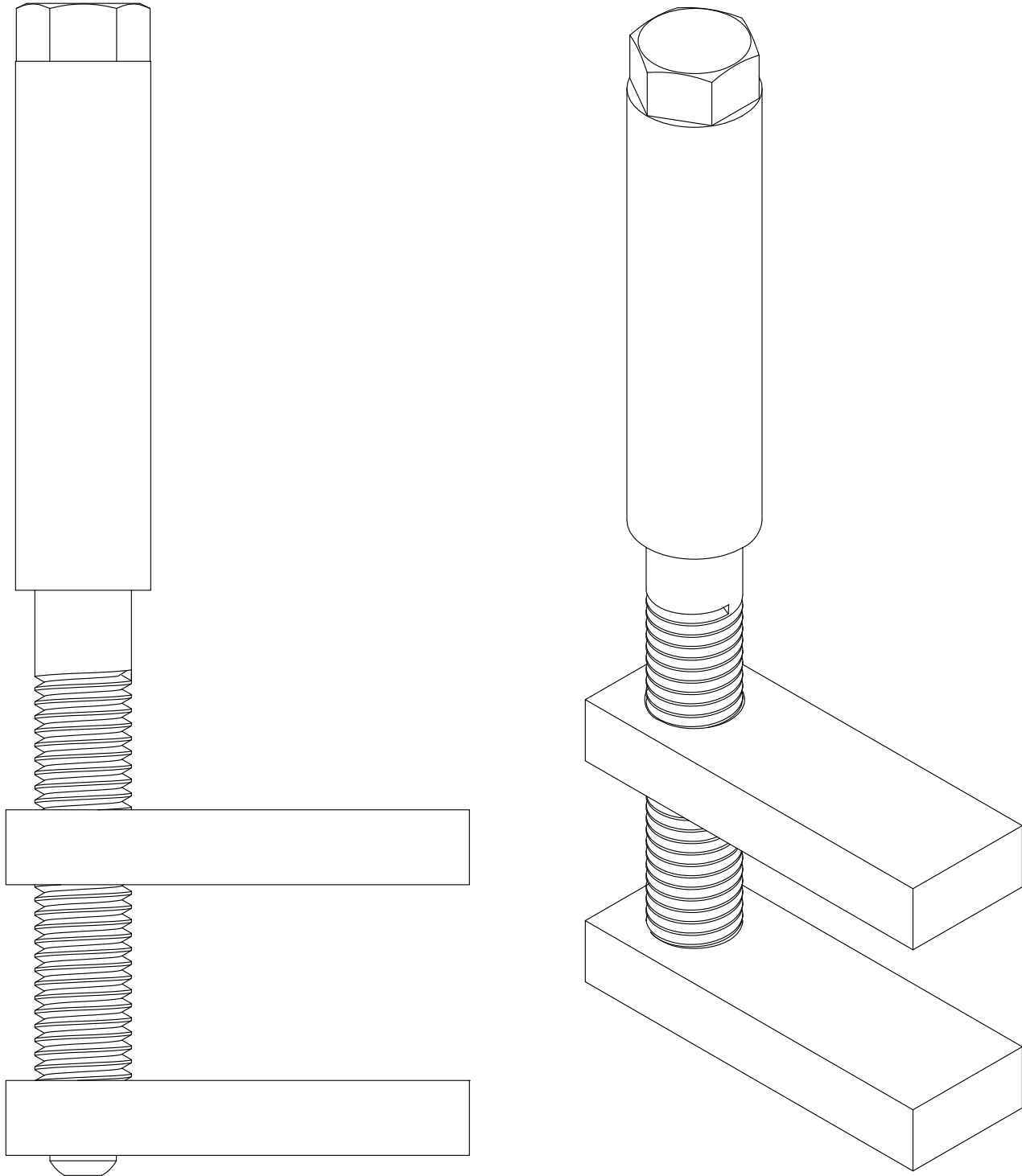

**PART# 120670**

THIS TOOL IS HARDENED & COATED WITH BLACK OXIDE

# T-HANDLE FOR STOP STEMS

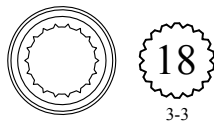
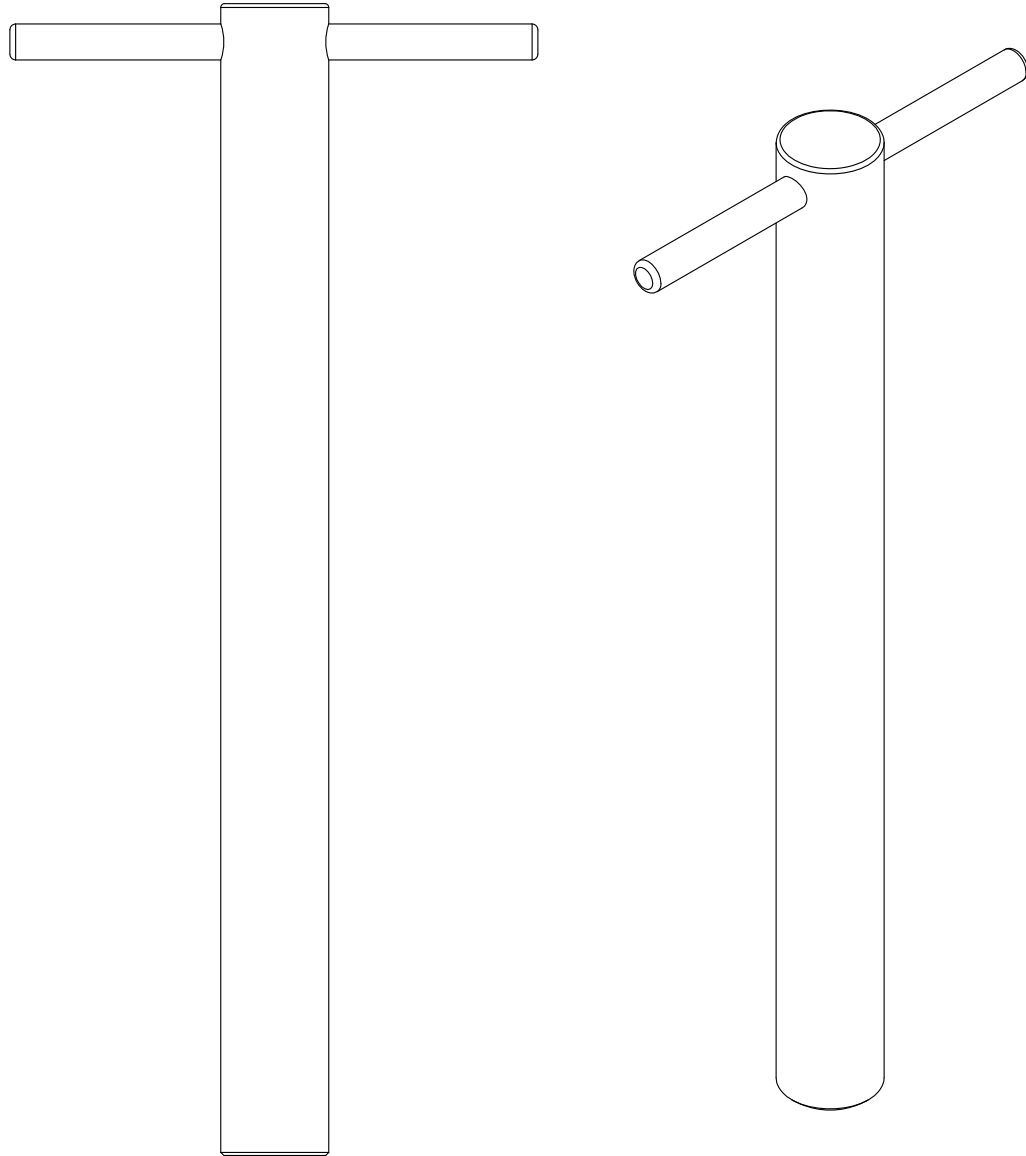

PART# 999010

# SLOAN NIPPLE WRENCH

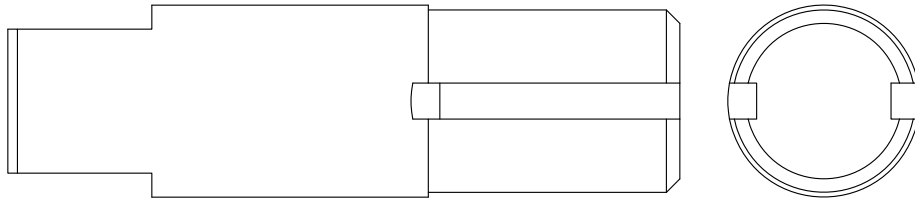
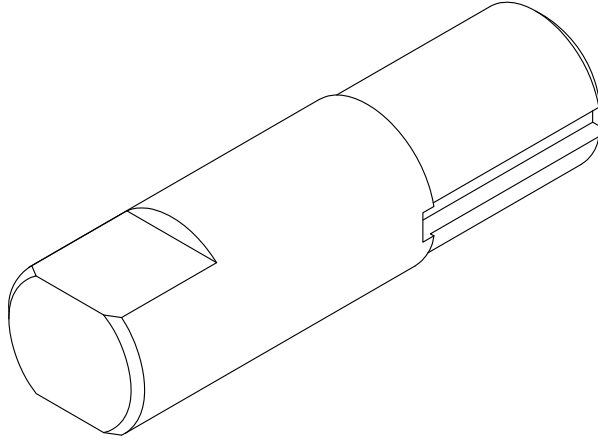

**PART# 141810**  
Stainless Steel

*Send Your Orders To:*

BARRY E.  **WALTER**  SR. CO.

*E-mail: [orderdesk@barrywalter.com](mailto:orderdesk@barrywalter.com)*

*Fax: 1.800.886.9831*

*Phone: 1.800.767.5552*



BARRY E.  WALTER SR. CO.

# ADAPTERS



# ADAPTERS

## Compression Hose Adapters

3/8 Compression Male

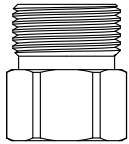

1/4 Compression Female  
LF126900

3/8 Compression Male

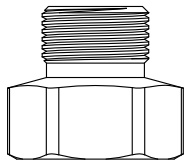

16mm x 1.25 Female  
LF102920

3/8 Compression Male

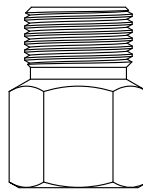

3/8 Flare Female  
LF134980

Nickel Plated Part

1/4 Compression Male

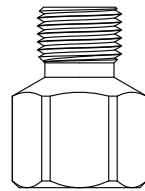

3/8 Flare Female  
LF135050

Nickel Plated Part

3/8 Compression Male

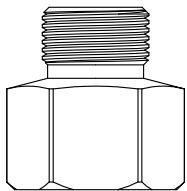

1/2 Flare Female  
LF122840

Nickel Plated Part

3/8 - 18 NPT Male

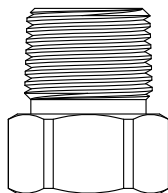

3/8 Compression Female  
LF171110

Nickel Plated Part

3/8 Compression Male

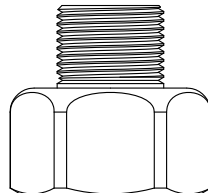

1/2 - 14 NPS Female  
LF149200

Nickel Plated Part

3/8 Compression Male

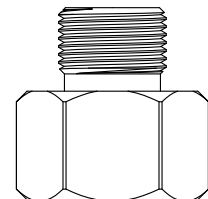

1/2 Compression Female  
LF105060

Also Available  
Chrome Plated  
LF105060-CP

1/2 Compression Male

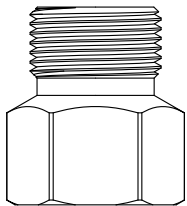

1/2 Flare Female  
LF133340

1/2 - 14 NPS Male

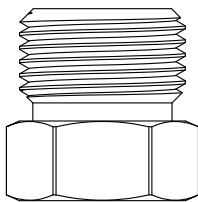

3/8 Compression Female  
LF104920

1/2 - 14 NPS Male

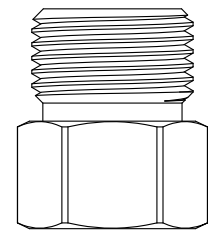

1/2 Compression Female  
LF104990

Also Available  
Chrome Plated  
LF104990-CP

3/8 Compression Male

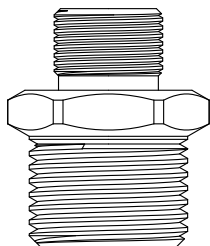

1/2 - 14 NPT Male  
LF115940

Nickel Plated Part

5/16 Compression Male

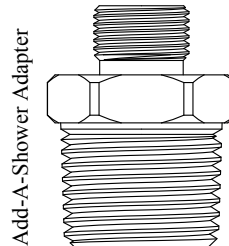

Add-A-Shower Adapter  
1/2 - 14 NPT Male  
171180

# ADAPTERS

## Supply Hose Adapters

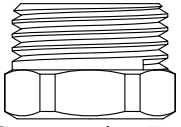
1/2 - 14 NPS Male  
  
 Nickel Plated  
 1/4 Compression Female  
**LF180080**

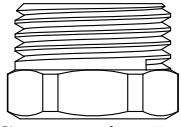
1/2 - 14 NPS Male  
  
 Nickel Plated  
 3/8 Compression Female  
**LF180150**

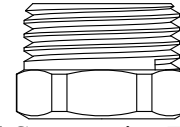
1/2 - 14 NPS Male  
  
 Nickel Plated  
 7/16 Compression Female  
**LF180220**

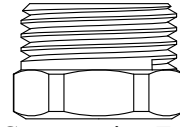
1/2 - 14 NPS Male  
  
 Nickel Plated  
 1/2 Compression Female  
**LF180290**

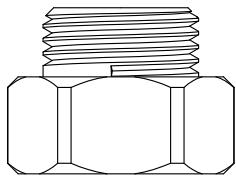
1/2 - 14 NPS Male  
  
 Nickel Plated Part  
 15/16-24 Female  
 Fits Ballcock Shank  
**180360**

## Pull-Out Hose Adapters

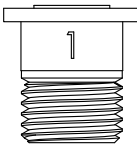
FOR KWC  
  
 Nickel Plated  
 1/4 - 18 NPS Male  
**LF182810**

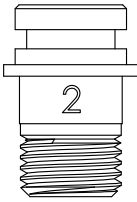
FOR GROHE  
  
 Nickel Plated  
 1/4 - 18 NPS Male  
**LF182880**

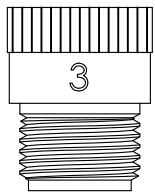
5/8 - 18 Female  
  
 Nickel Plated  
 M16 x 1.25 Male  
**LF182950**

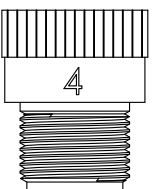
5/8 - 18 Female  
  
 Nickel Plated  
 FOR GROHE  
 M14 x 1.00 Male  
**LF183020**

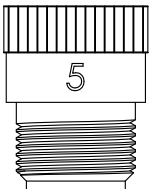
5/8 - 18 Female  
  
 Nickel Plated  
 FOR DELTA  
 5/8 - 24 Male  
**LF186520**

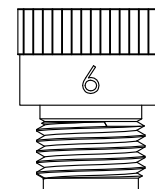
5/8 - 18 Female  
  
 Nickel Plated  
 FOR PRICE PFISTER  
 9/16 - 18 Male  
**LF186590**

# ADAPTERS

## 3/4" Hose Adapters

FOR CLAYTON MARK  
YARD HYDRANT

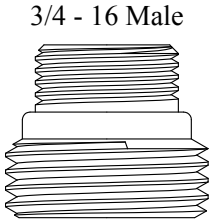

3/4 - 16 Male

3/4 Hose Male

109500

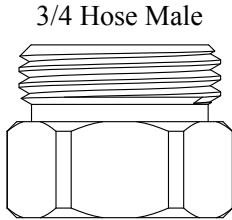

3/4 Hose Male

15-16 - 14 Female  
Fits Ballcock Shank

115420

FOR NIBCO

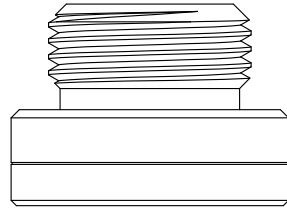

3/4" Hose Male

1-5/16 - 18 Female

134000

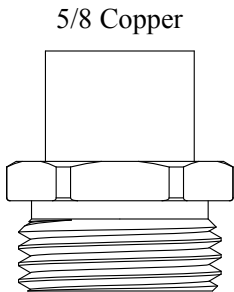

5/8 Copper

3/4 Hose Male

123940

FOR NIBCO

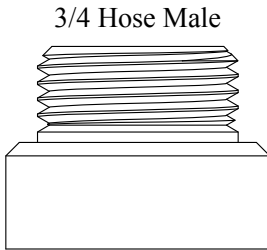

3/4 Hose Male

1-1/4 - 18 Female

133930

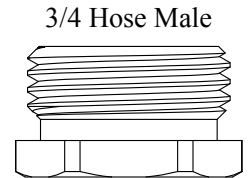

3/4 Hose Male

1/2 - 14 NPT Female

176640

FOR ARROWHEAD BRASS

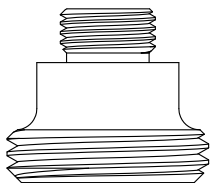

1/2 - 20 Male

3/4 Hose Male

189320

FOR U.S. BRASS

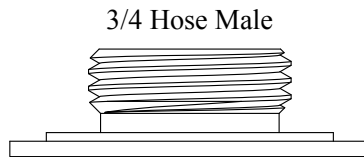

3/4 Hose Male

1-1/2 SLIP JOINT NUT

176010

# ADAPTERS

## Hose Adapters

FOR ALSON

3/8 - 18 NPS Male

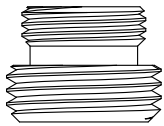

13/16 - 18 Male

131620

Chrome Plated

BEAUTY PARLOR  
HOSE ADAPTER

1/4 - 18 NPT Female

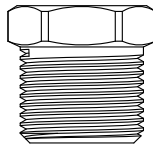

16MM X 1.25 Male

131830

PIPE ADAPTER

1 1/16 - 18 Female

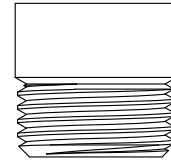

1/2 - 14 NPT Male

LF120180

1/4 - 18 NPT Male

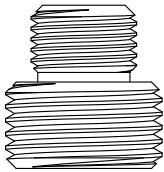

1/2 - 14 NPT Male

LF151090

9/16 - 18 Male

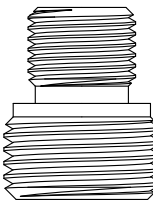

1/2 - 14 NPS Male

104340

Chrome Plated

FOR T & S BEDPAN HOSE

3/4 - 14 Male

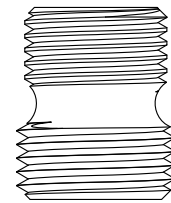

1/2 - 14 NPT Male

130030

Chrome Plated

1/2 - 14 NPT Male

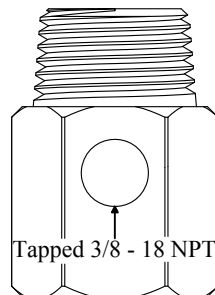

Tapped 3/8 - 18 NPT

1/2 - 14 NPS Female

LF142490

Chrome Plated

# ADAPTERS

## Spout Adapters

FOR T & S SPOUT

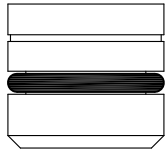

5/8 - 27 Female  
LF113020

SPOUT ADAPTER FOR  
UNIVERSAL RUNDLE

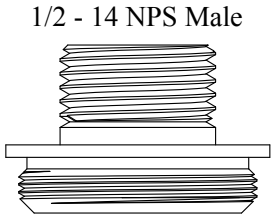

1/2 - 14 NPS Male  
1 1/4 - 24 Male  
131130

Chrome Plated

SPOUT ADAPTER  
FOR PERLICK

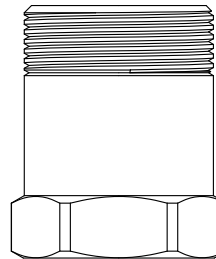

1" - 20 Male  
13/16 - 18 Female  
LF133950

Chrome Plated

FOR CRANE TUB SPOUT

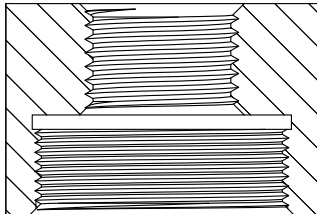

1/2 - 14 NPT Female  
1 5/16 - 20 Female  
102360

FOR CRANE TUB SPOUT

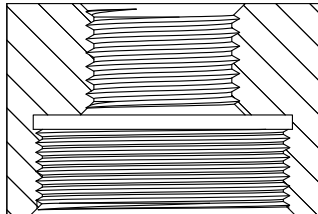

1/2 - 14 NPT Female  
1 1/4 - 16 Female  
116470

SPOUT ADAPTER FOR  
UNIVERSAL RUNDLE

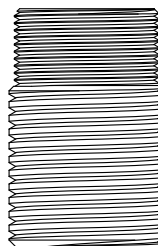

3/4 - 27 Male  
1/2-14 NPS Male  
LF106580

FOR CRANE SPOUT

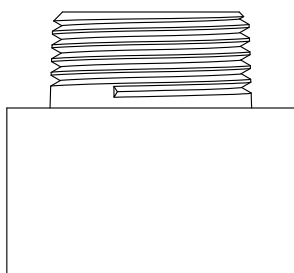

3/4 - 14 NPT Male  
1 1/4 - 16 Female  
124200

GOOSE NECK SPOUT ADAPTER

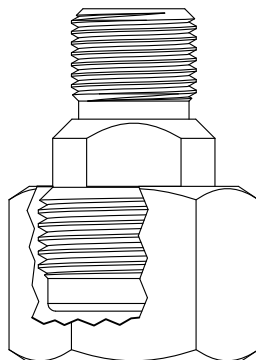

3/8 - 18 NPS Male  
LF114650

Chrome Plated

# ADAPTERS

## Shower Head Adapters

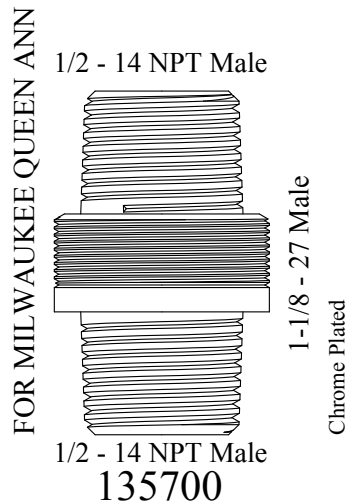
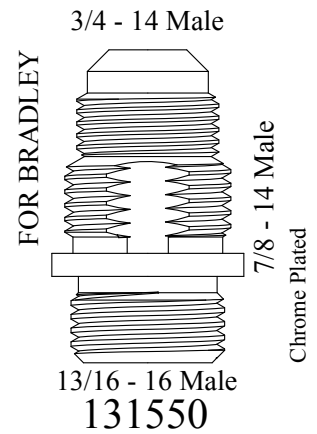
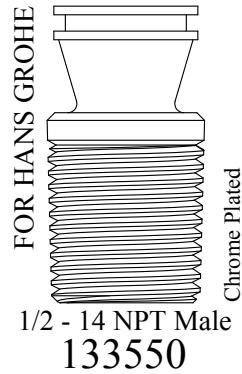
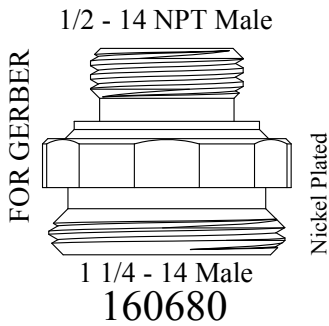
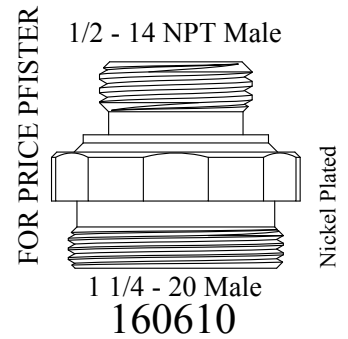
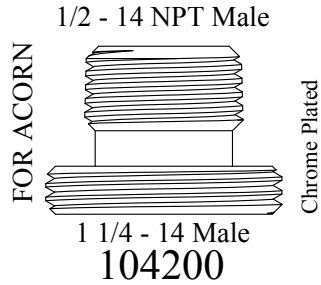
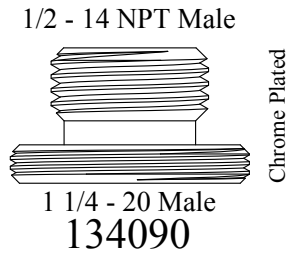



# ADAPTERS

## Pipe to Flare Adapters

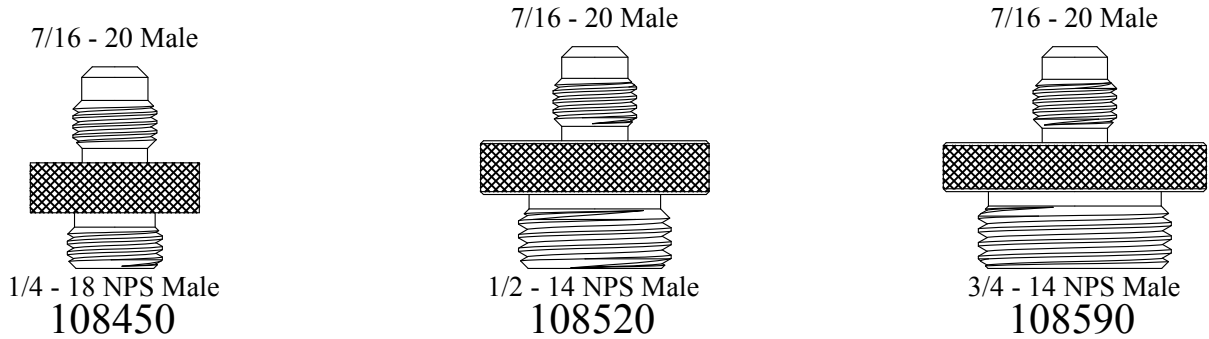

## Pipe to Pipe Adapters

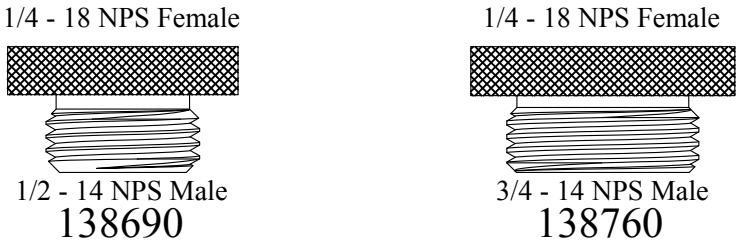

# ADAPTERS

## Miscellaneous Adapters

FACE BUSHING

Chrome Plated  
3/8 - 18 NPS Female  
  
1/2 - 14 NPS Male  
**122560**

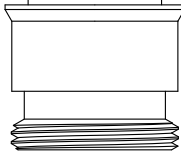
1/2 - 20 Female  
FOR ELKAY  
BUBBLER  
  
7/8 - 20 Male  
Chrome Plated  
**LF107000**

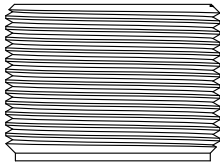
1 1/8 - 18 Male  
BRADLEY TO  
ACORN ADAPTER  
  
**195730**

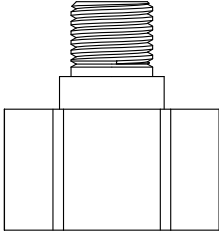
7/16 - 20 Male  
FOR ACORN  
AIR VALVE  
  
3/4 - 18 Female  
**LF116220**

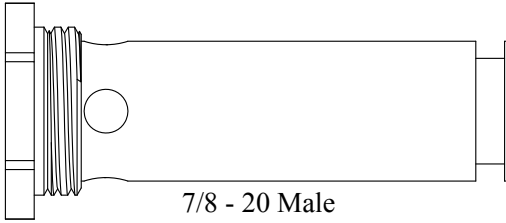
FOR ARROWHEAD  
BRASS  
  
7/8 - 20 Male  
11/16 - 20 Female  
**132670**

## Waste Shoe Bushings

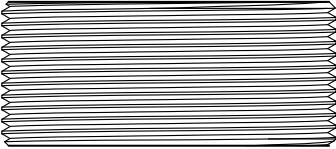
1-5/8 - 16 Female  
  
1-3/4 - 16 Male  
**182250**

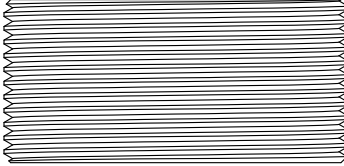
1-5/8 - 16 Female  
  
1-13/16 - 14 Male  
**120930**

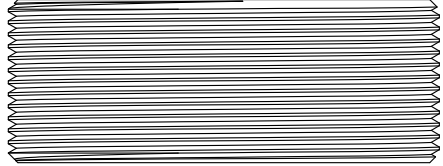
1-5/8 - 16 Female  
  
2-1/4 - 16 Male  
**106510**

## Miscellaneous Bushings

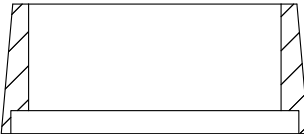
OVERFLOW BUSHING  
  
**169710**

# ADAPTERS

## Aerator Adapters

13/16 - 20 Male

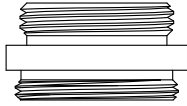

55/64 - 27 Male

LF105320

55/64 - 27 Male

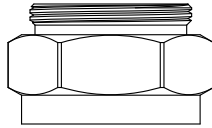

1/2 - 14 IPS Female

LF126320

15/16 - 27 Male

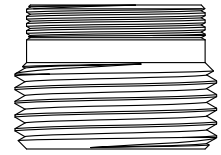

15/16 - 11.5 Male

Hose Thread

LF133460

13/16 - 27 Male

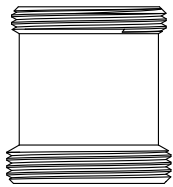

7/8 - 27 Male

LF116330

1/4 - 18 IPT Female

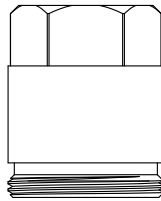

13/16 - 27 Male

LF110900

Snap Hose

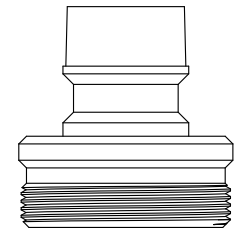

28mm X 1.00 Male

LF135980

*Send Your Orders To:*

BARRY E.  WALTER SR. CO.

*E-mail: [orderdesk@barrywalter.com](mailto:orderdesk@barrywalter.com)*

*Fax: 1.800.886.9831*

*Phone: 1.800.767.5552*

*Send Your Orders To:*

BARRY E.  SR. CO.

*E-mail: [orderdesk@barrywalter.com](mailto:orderdesk@barrywalter.com)*

*Fax: 1.800.886.9831*

*Phone: 1.800.767.5552*



**BRASS**  
AMERICA  
*Quality Replacement Parts*

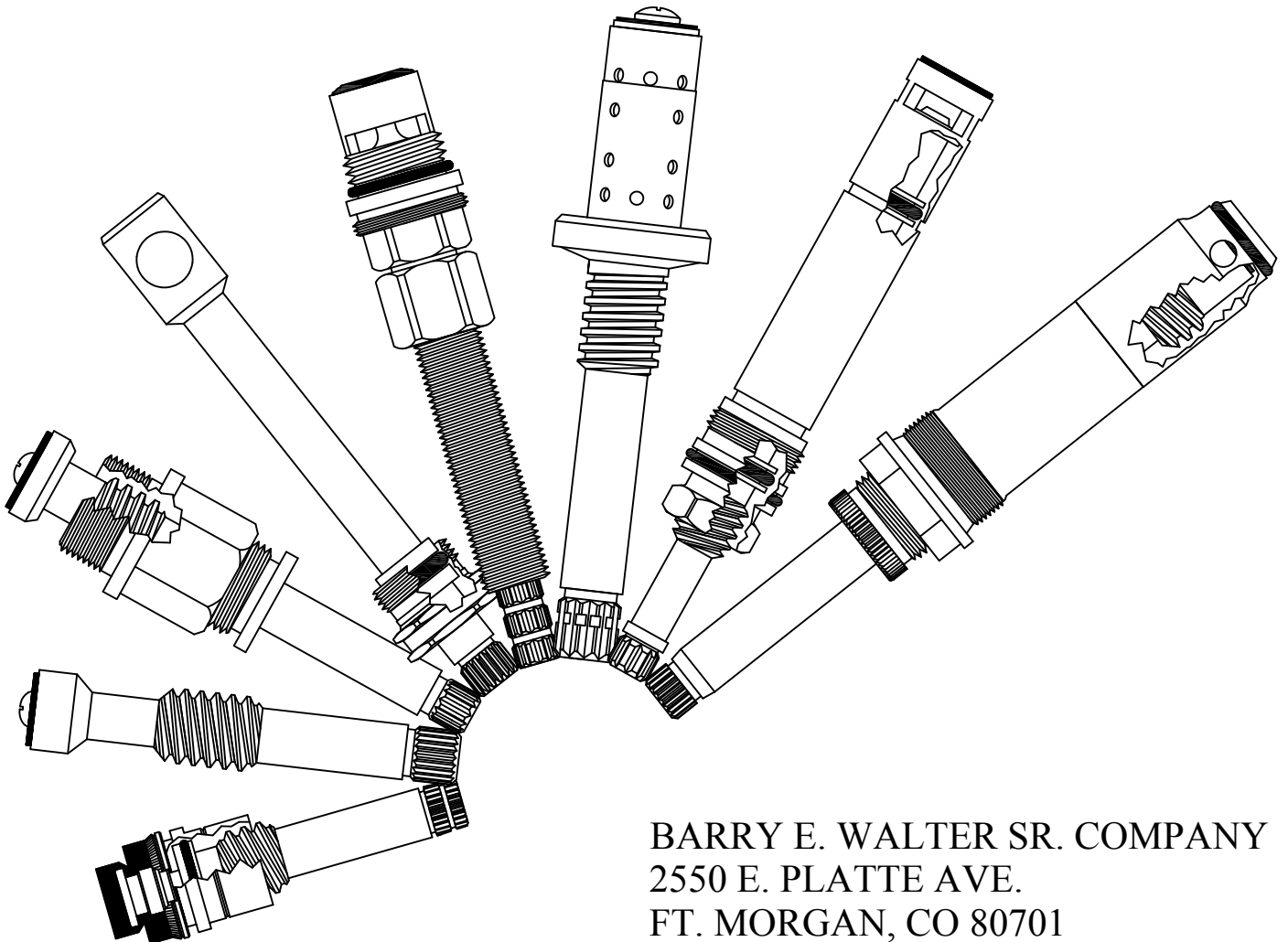

BARRY E. WALTER SR. COMPANY  
2550 E. PLATTE AVE.  
FT. MORGAN, CO 80701

BARRY E.  ALTER SR. CO.

# BALLCOCK PLUNGERS & COMPONENTS



# BALLCOCK PLUNGERS

REPLACEMENT FOR  
AMERICAN STANDARD

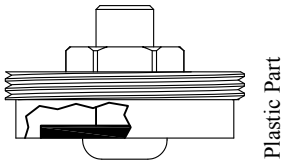

70422-07

REPLACEMENT FOR  
AMERICAN STANDARD

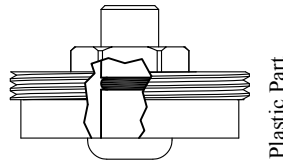

73071-07

REPLACEMENT FOR  
AMERICAN STANDARD

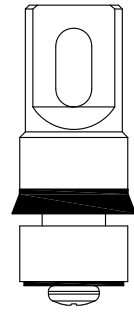

640010  
OEM# 8339-07  
SEAT: 649370

REPLACEMENT FOR CASE

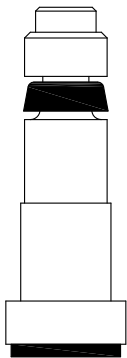

640050  
OEM# 5025  
SEAT: 647240

REPLACEMENT FOR CASE

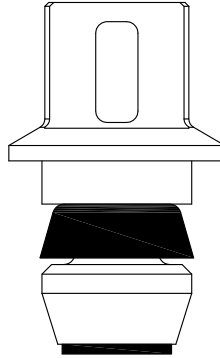

640320  
OEM# 50  
SEAT: 647980

REPLACEMENT FOR CASE

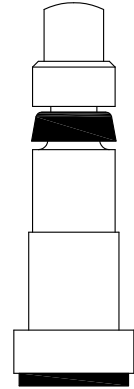

640250  
OEM# 5034  
SEAT: 647240

REPLACEMENT FOR CASE

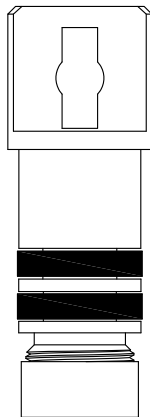

640300  
OEM# 41 5/8"

REPLACEMENT FOR CASE

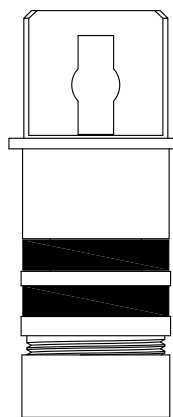

640310  
OEM# 41 3/4"  
SEAT: 647240

# BALLCOCK PLUNGERS

REPLACEMENT FOR  
BRIGGS & INDIANA

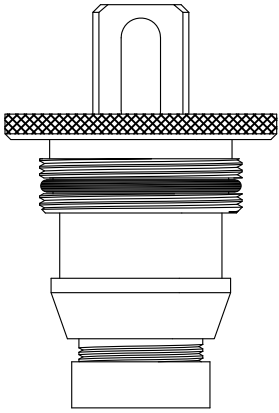

**640020**

Briggs OEM# SA76-E4A  
Indiana OEM# 4197  
SEAT: 647860

REPLACEMENT FOR ELJER

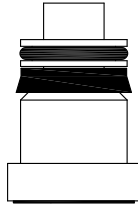

**640420**

OEM# 480-0604-00  
SEAT: 647860

REPLACEMENT FOR KOHLER

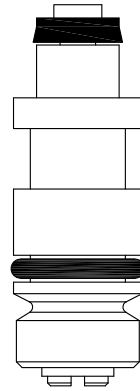

**640220**

OEM# 51226  
SEAT: 647160

REPLACEMENT FOR MANSFIELD

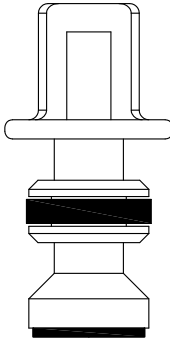

**640240**  
OEM# 333

REPLACEMENT FOR SCOVILL

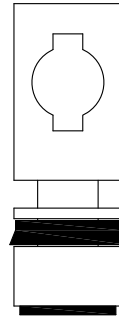

**640350**  
OEM# 8729

SEAT: 649970

REPLACEMENT FOR UNIVERSAL RUNDLE

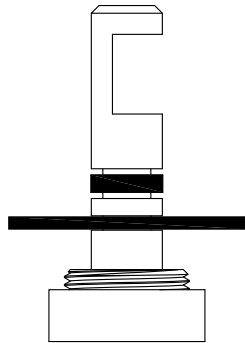

**640400**

OEM# A369  
SEAT: 647830

REPLACEMENT FOR UNIVERSAL RUNDLE

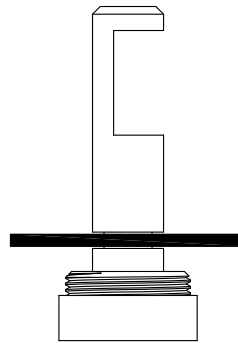

**640410**

OEM# A317  
SEAT: 647830



# BALLCOCK COMPONENTS



CUP FOR CASE 62-12A  
BALLCOCK

141770



CUP FOR CASE 50  
BALLCOCK

840320-2



5/8" BALLCOCK  
SEAT WASHER  
FOR CASE

840300

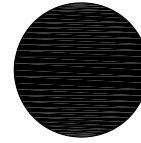

BALLCOCK  
SEAT WASHER  
FOR CASE

840310



5/8" BALLCOCK  
LEATHER PACKING  
FOR CASE

840300-2



3/4" BALLCOCK  
LEATHER PACKING  
FOR CASE

840310-2

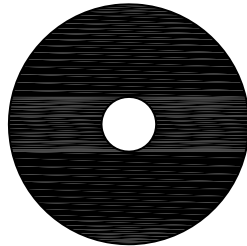

DIAPHRAGM WASHER  
FOR SEAR-U/R

840400-1



BALLCOCK  
LEATHER PACKING  
FOR SEARS-U/R

840400-2



BIBB WASHER  
FOR SEARS-U/R

840220



TANK LEVER  
NUT

160410

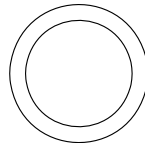

BALLCOCK CAP  
FOR BRIGGS

940020

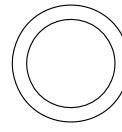

5/8" BALLCOCK CAP  
FOR CASE

940300

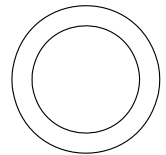

BALLCOCK  
RETAINER CUP

940310

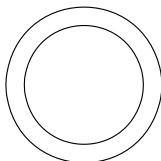

BALLCOCK CAP  
FOR SEARS-U/R

940400

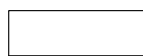
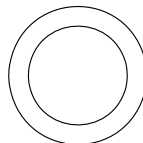

BALLCOCK CAP  
FOR SEARS-U/R

940410

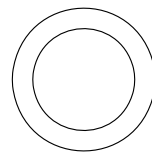

BALLCOCK CAP  
FOR SCOVILL

012-8227



BARRY E.  WALTER  SR. CO.

# INSTITUTIONAL & SECURITY REPAIR PARTS



# INSTITUTIONAL & SECURITY REPAIR PARTS

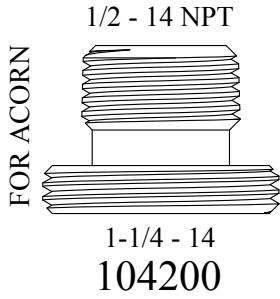

1-1/4 - 14  
104200

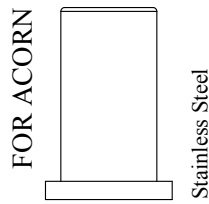
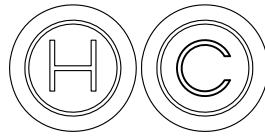

127530 Hot  
OEM# 4010-001-199  
127600 Cold  
OEM# 4010-002-199

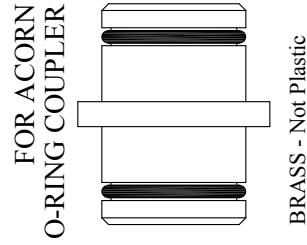

LF107510  
OEM# 2570-028-001

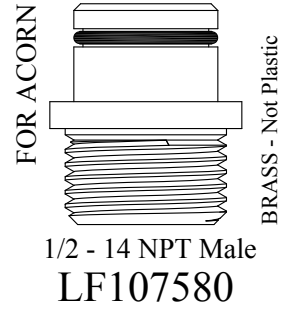

1/2 - 14 NPT Male  
LF107580

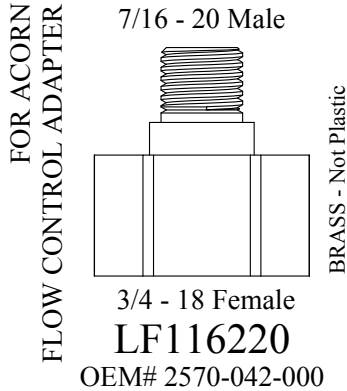

3/4 - 18 Female  
LF116220  
OEM# 2570-042-000

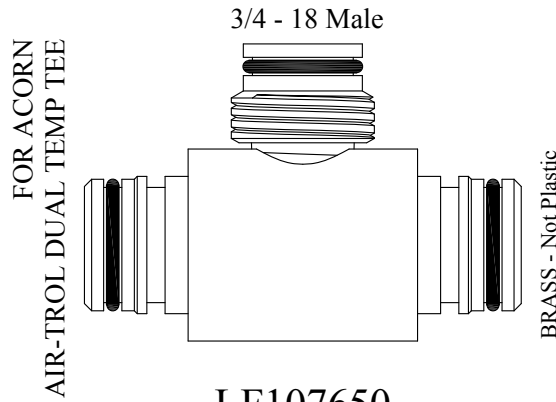

LF107650  
OEM# 2570-041-000

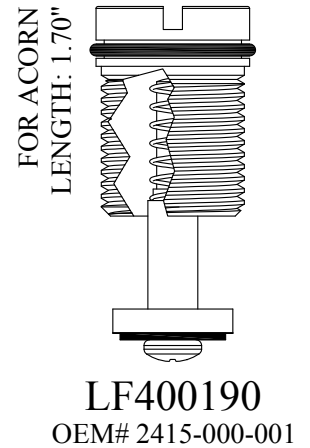

LF400190  
OEM# 2415-000-001

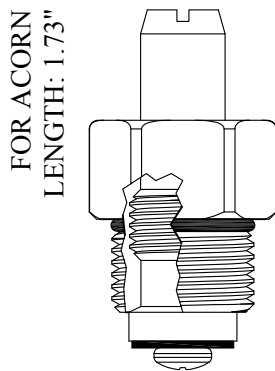

GASKET: 890160 O-RING INCLUDED

LF454071  
OEM# 2755-000-002  
LF254071 Stem Only

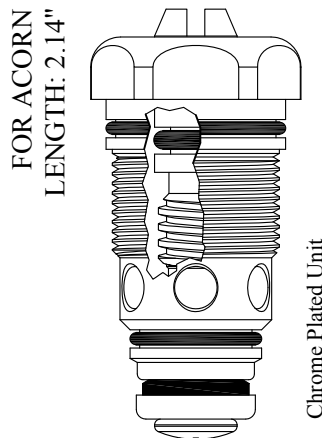

461922  
OEM# 0528-000-002

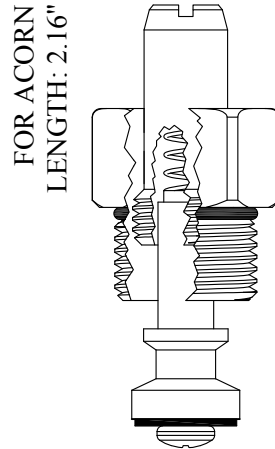

GASKET: 890160 O-RING INCLUDED

LF400571  
OEM# 2755-005-002  
LF200571 Stem Only

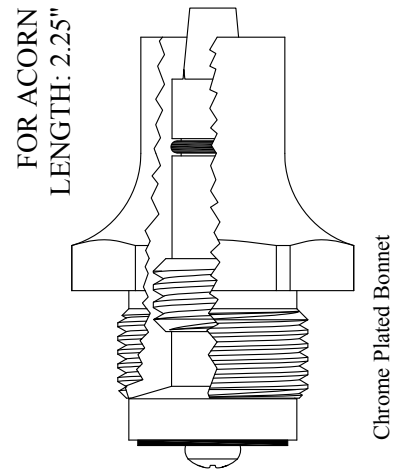

GASKET: 895570

483121  
OEM# 0485-000-002

# INSTITUTIONAL & SECURITY REPAIR PARTS

Also available less bonnet  
**LF463260**  
 OEM# 2304-001-001

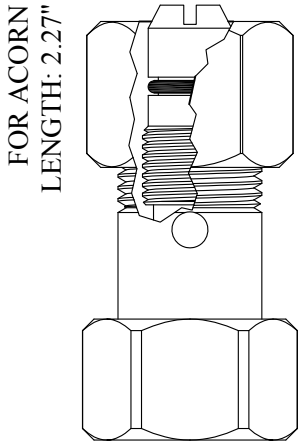

FOR ACORN  
 LENGTH: 2.27"

**LF138921**  
 OEM# 2366-031-001  
**LF136401** Stem Only

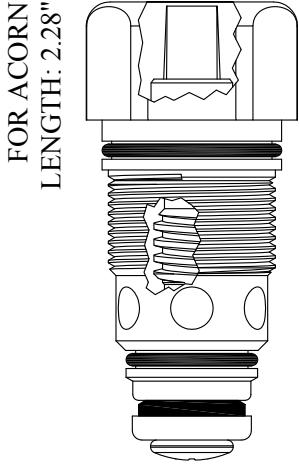

FOR ACORN  
 LENGTH: 2.28"

**462702**  
 OEM# 0525-000-002

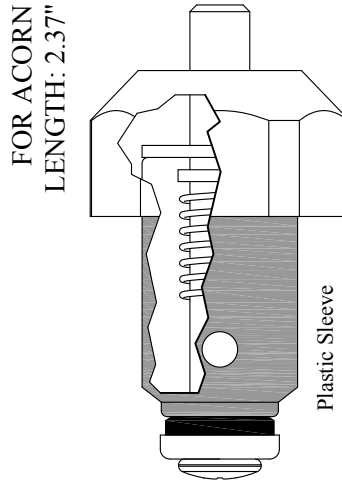

FOR ACORN  
 LENGTH: 2.37"

**LF463270**  
 OEM# 2304-000-001

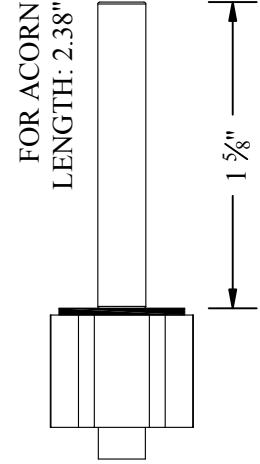

FOR ACORN  
 LENGTH: 2.38"

**LF158310**  
 OEM# 2358-003-001

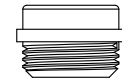

SEAT USED: LF647560

Also available less bonnet  
**464542**  
 OEM# 2260-001-002

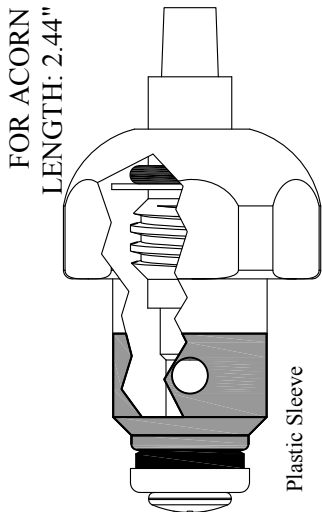

FOR ACORN  
 LENGTH: 2.44"

**464552**  
 OEM# 2366-031-001

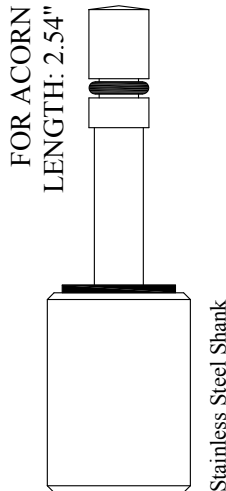

FOR ACORN  
 LENGTH: 2.54"

**LF138990**  
 OEM# 2366-011-002

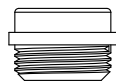

SEAT USED: LF647560

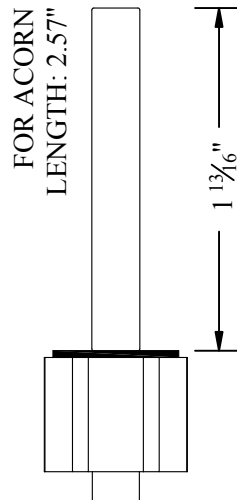

FOR ACORN  
 LENGTH: 2.57"

**LF130680**

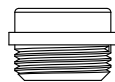

SEAT USED: LF647560

Also available less bonnet  
**LF117621**

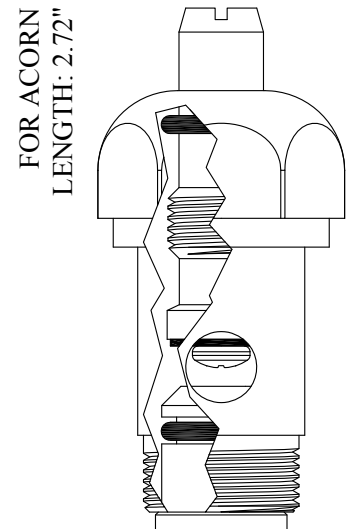

FOR ACORN  
 LENGTH: 2.72"

GASKET: 895400  
 SEAT INCLUDED: LF601780

**LF401781**  
 OEM# 2767-010-002  
**LF254071** Stem Only

# INSTITUTIONAL & SECURITY REPAIR PARTS

Also available less bonnet  
**LF466490**

FOR ACORN  
 LENGTH: 3.13"

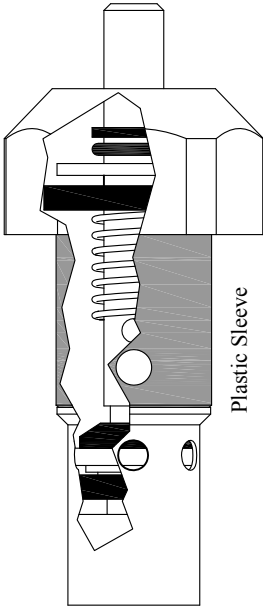

Plastic Sleeve

**LF466500**  
 OEM# 2305-050-003

FOR ACORN  
 LENGTH: 3.24"

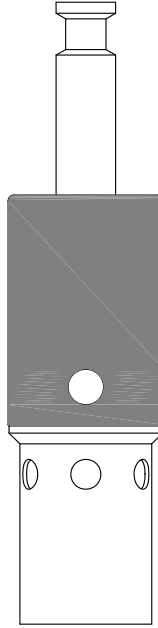

Plastic Sleeve

**468490**  
 OEM# 2305-001-001

FOR ACORN  
 LENGTH: 3.50"

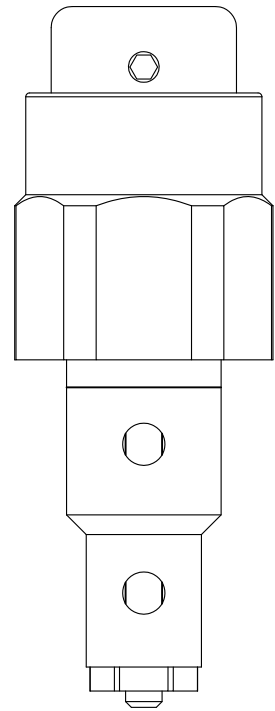

**LF402880**

FOR ACORN  
 LENGTH: 4.00"

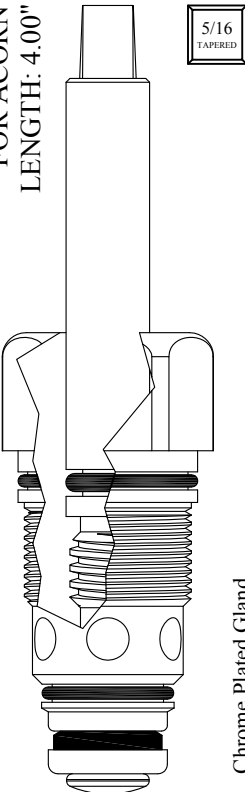

Chrome Plated Gland

**469702**  
 OEM# 0526-000-001

5/16  
 TAPERED

FOR ACORN  
 LENGTH: 4.00"

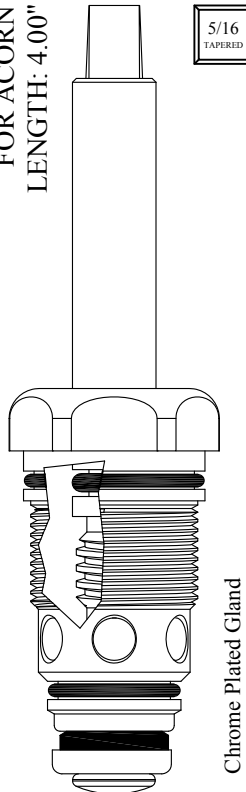

Chrome Plated Gland

**469712**

5/16  
 TAPERED

FOR ACORN  
 LENGTH: 4.49"

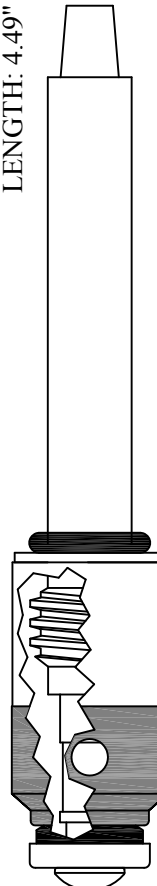

Plastic Sleeve

**470052**  
**270052** Stem Only

5/16  
 TAPERED

FOR ACORN

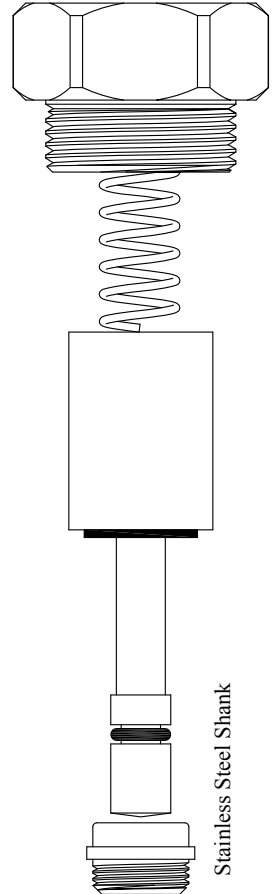

Stainless Steel Shank

GASKET INCLUDED: 895550  
 SEAT INCLUDED: LF647560  
**LF138220**  
 OEM# 2366-021-001

# INSTITUTIONAL & SECURITY REPAIR PARTS

FOR ACORN  
Male

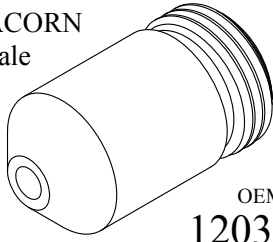

OEM# 1241-001-001  
120320: 1.5 GPM  
120390: 2.5 GPM

FOR ACORN  
Male

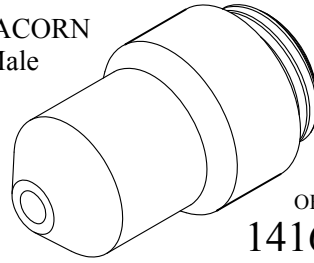

OEM# 1187-000-001  
141670: 1.5 GPM  
103220: 2.5 GPM

FOR ACORN  
Female

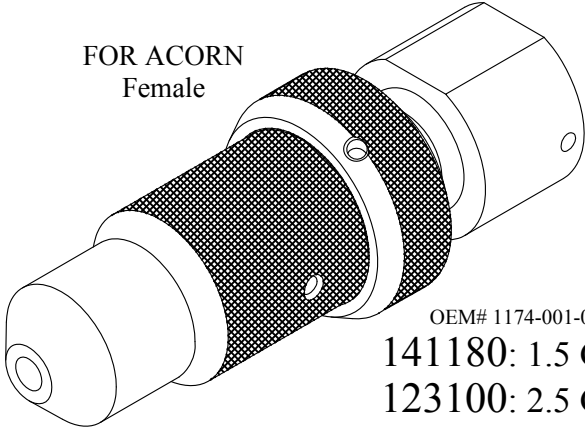

OEM# 1174-001-001  
141180: 1.5 GPM  
123100: 2.5 GPM

FOR ACORN  
Female Rigid

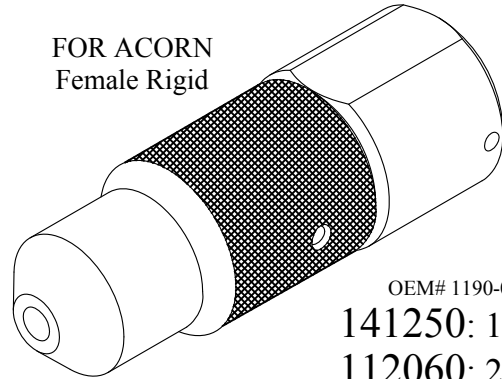

OEM# 1190-010-001  
141250: 1.5 GPM  
112060: 2.5 GPM

FOR ACORN  
Male

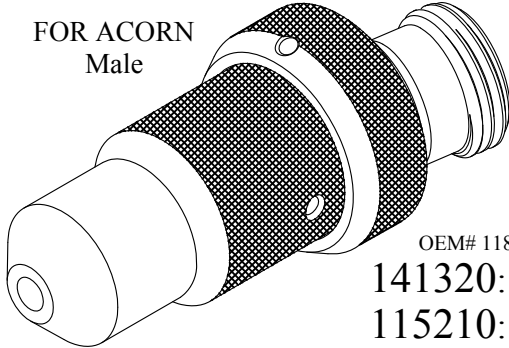

OEM# 1180-001-001  
141320: 1.5 GPM  
115210: 2.5 GPM

FOR ACORN  
Male Rigid

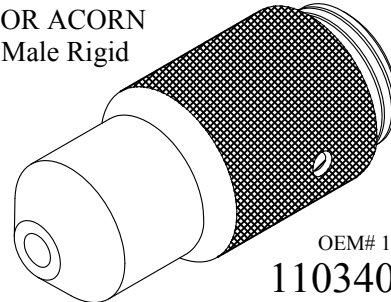

OEM# 1192-010-001  
110340: 1.5 GPM  
115350: 2.5 GPM

FOR ACORN  
Female

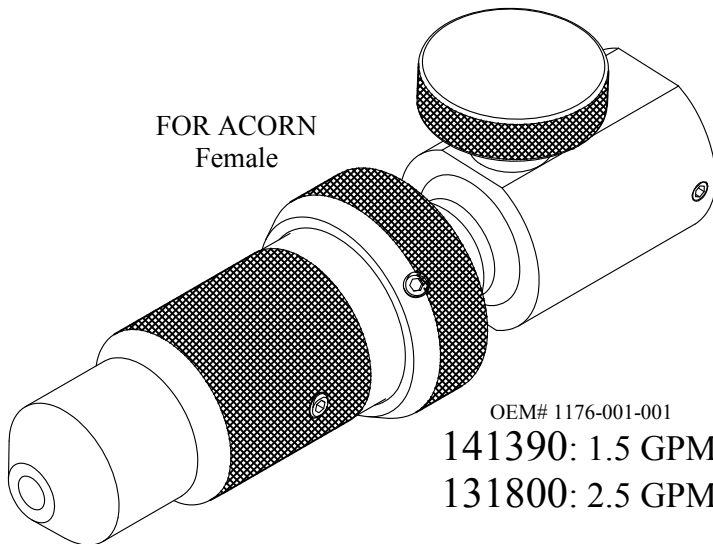

OEM# 1176-001-001  
141390: 1.5 GPM  
131800: 2.5 GPM

FOR ACORN  
Male Rigid

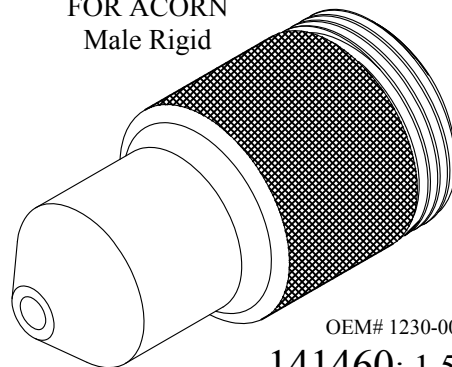

OEM# 1230-000-001  
141460: 1.5 GPM  
123750: 2.5 GPM



# INSTITUTIONAL & SECURITY REPAIR PARTS

FOR ACORN B5

LF103870

158100

PACKING NUT

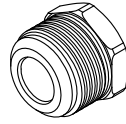

SPRING

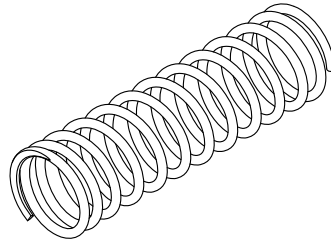

.437 x .250 x .094  
O-RING



.437 x .250  
BACK-UP RING



1.030 x .875 x .062  
GASKET

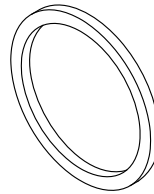

LF158240

CAP NUT

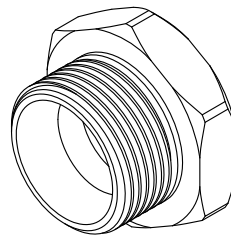

LF158310

STEM ASSEMBLY

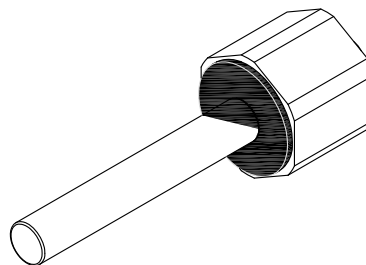

LF647560

1/2-27 SEAT

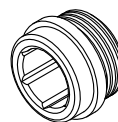

# INSTITUTIONAL & SECURITY REPAIR PARTS

## SUPPLY TUBE FOR AMERICAN STANDARD PRISON

## STEM ASSEMBLY FOR AMERICAN STANDARD PRISON

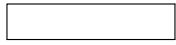

COLLAR  
39628



BUSHING  
139780

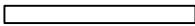

WASHER  
140270



NUT  
129520

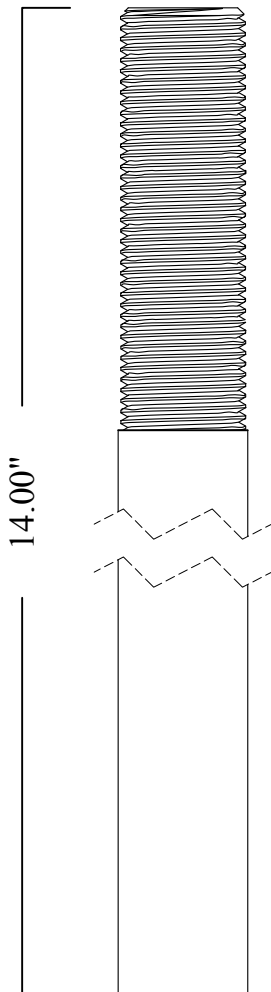

TUBE  
140830

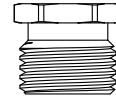

PACKING NUT  
25009-07



PACKING  
124590

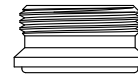

SEAT  
LF649870

STEM LENGTH: 2.36"

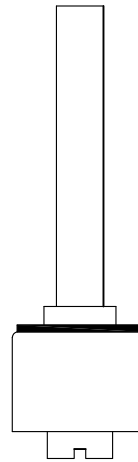

STEM  
LF152150



SPRING  
124520

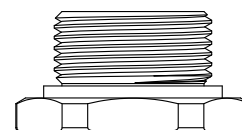

CAP  
LF60053-07  
895150 Gasket Included

LF124660 Repair Kit

# INSTITUTIONAL & SECURITY REPAIR PARTS

## FOR AMERICAN STANDARD PRISON

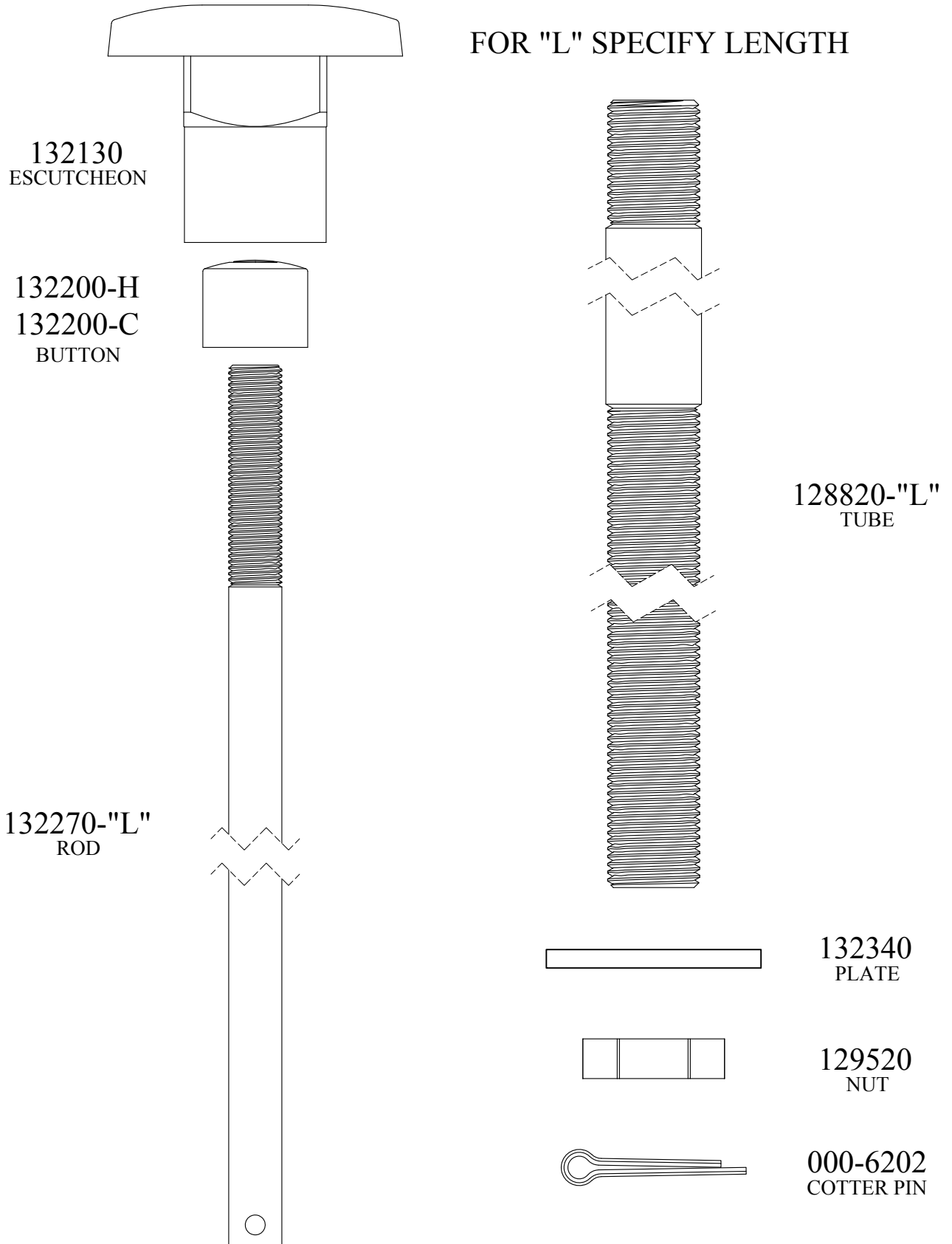

# INSTITUTIONAL & SECURITY REPAIR PARTS

FOR BRADLEY  
Male

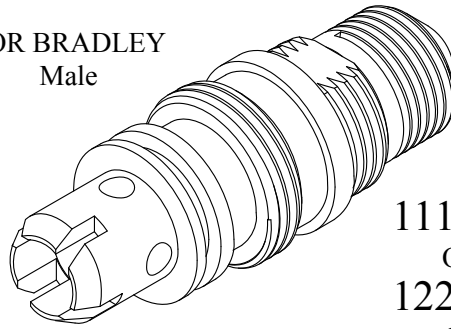

CHROME PLATED SOLID  
BRASS (NOT PLASTIC)

111810: 1.5 GPM  
OEM# S88-067  
122310: 2.5 GPM  
OEM# S88-001  
122520: 3.0 GPM  
OEM# S88-003

FOR BRADLEY  
Male

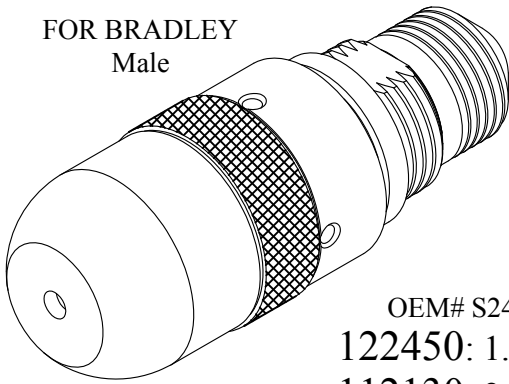

OEM# S24-072  
122450: 1.5 GPM  
112130: 2.5 GPM  
122380: 3.0 GPM

FOR BRADLEY  
3/8 - 18 NPT Female

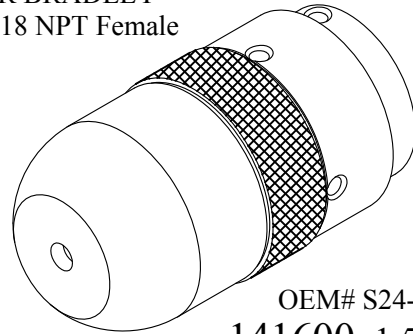

OEM# S24-008  
141600: 1.5 GPM  
130870: 2.5 GPM

FOR BRADLEY  
LENGTH: 1.50"

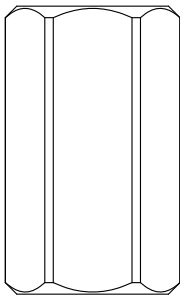

CONNECTION BODY WITH  
FLOW CONTROL (0.5 GPM)

126580  
OEM# S88-028

FOR BRADLEY  
LENGTH: 2.44"

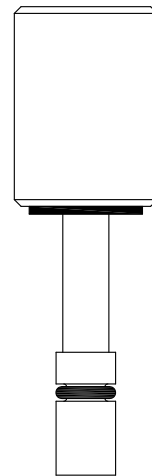

LF173770  
OEM# S21-046

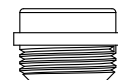

SEAT USED: LF647560

# INSTITUTIONAL & SECURITY REPAIR PARTS

FOR BRADLEY  
LENGTH: 2.19"

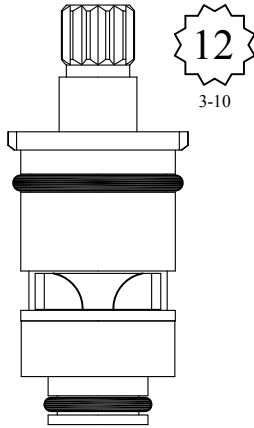

DISC SET: 151380-PKG

LF461071  
LF461072

FOR BRADLEY  
LENGTH: 2.46"  
STEM LENGTH: 1.22"

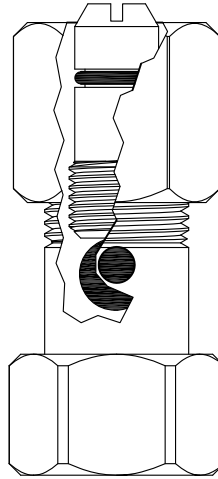

GASKET: 895100 INCLUDED

LF126480  
LF126551 Stem Only  
OEM# S21-047

FOR BRADLEY  
LENGTH: 2.98"

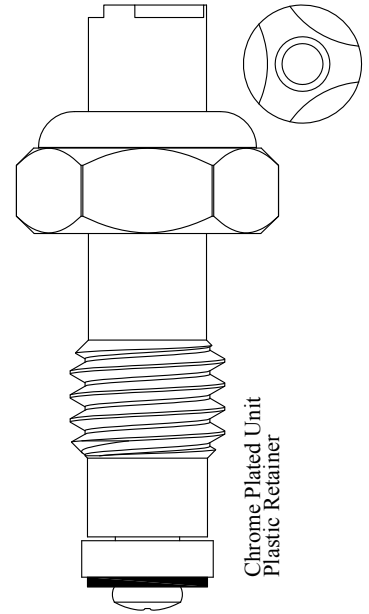

Chrome Plated Unit  
Plastic Retainer

401731  
201731 Stem Only  
OEM# S21-020

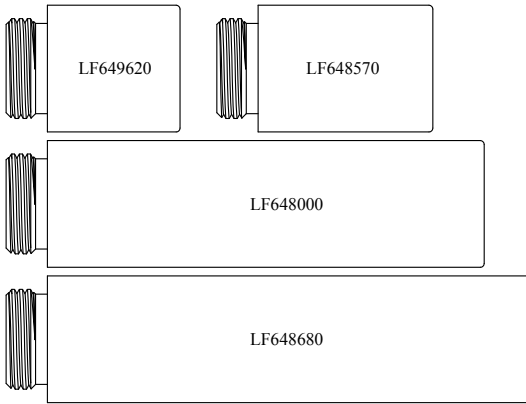

SEATS USED: LF648000, LF648570, LF648680 & LF649620

LOCKNUT  
F10583

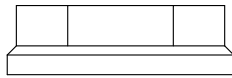

FOR CRANE  
PRISON VALVE  
LENGTH: 1.81"  
STEM LENGTH: 1.00"

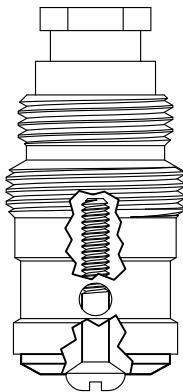

GASKET: 895250

LF458700  
OEM# 355174  
LF258700 Stem Only

Shorter version stem available

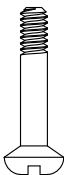

LF103990  
STEM LENGTH: 0.87"

FOR CRANE  
VALVE BODY

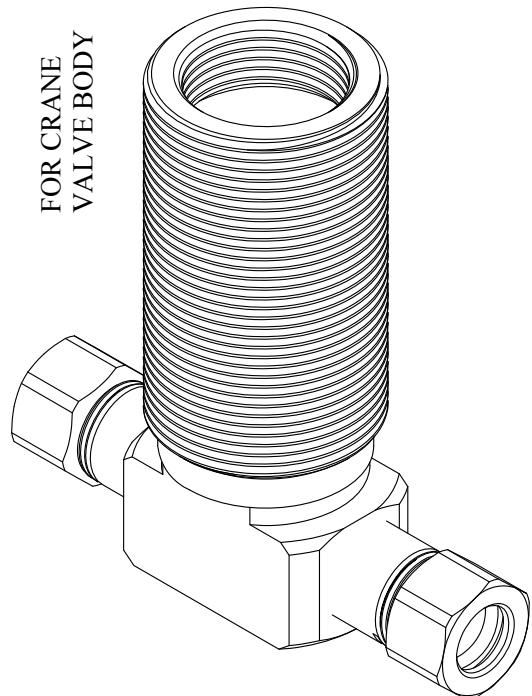

LF142650

# INSTITUTIONAL & SECURITY REPAIR PARTS FOR CRANE PRISON

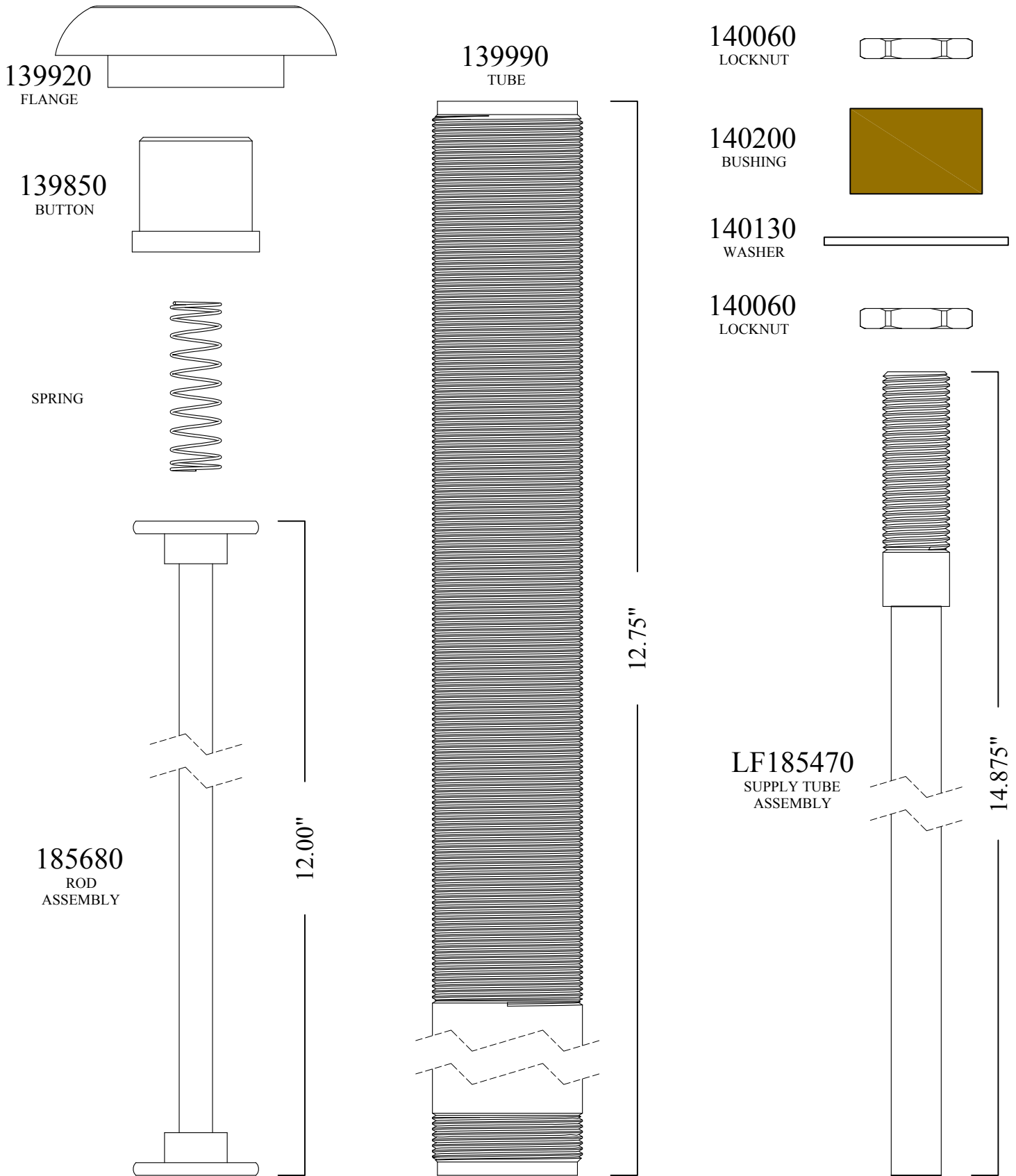

# INSTITUTIONAL & SECURITY REPAIR PARTS FOR ELJER PRISON VALVE

REPAIR KIT  
LF132080

SECURITY  
SEAT WASHER



SPRING

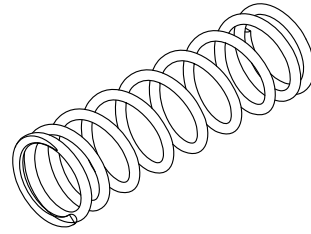

SECURITY  
COLLAR



GASKET

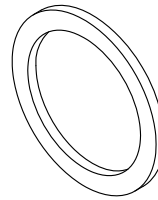

SECURITY  
COLLAR



PACKING

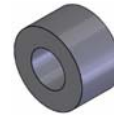

PACKING NUT

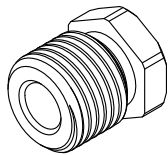

RUBBER GASKET

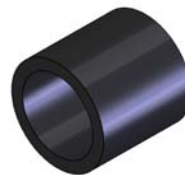

CAP

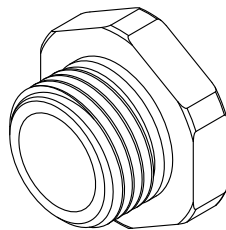

GASKET



VALVE HEAD

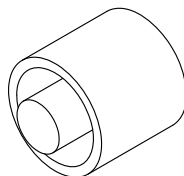

VALVE STEM

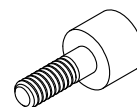

# INSTITUTIONAL & SECURITY REPAIR PARTS

## FOR KOHLER PRISON

129310  
ESCUTCHEON

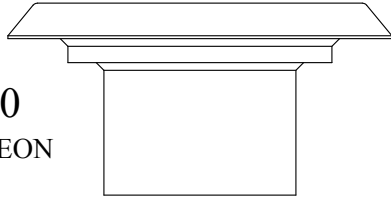

131710-H  
131710-C  
BUTTON

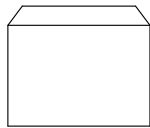

132060  
3 1/2" LONG

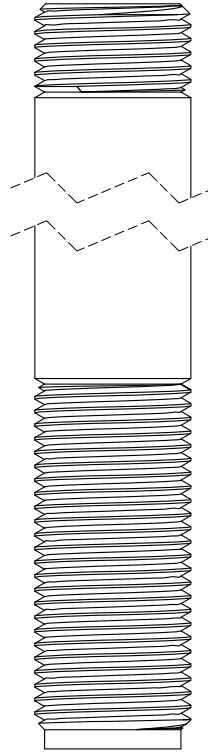

139500  
8 1/2" LONG  
TUBE

131780 - 4 1/2" LONG  
131850 - 9 1/2" LONG  
ROD



131900  
WASHER

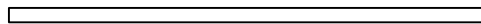

131920  
NUT



131990  
COLLAR

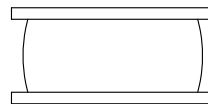

000-6202  
COTTER PIN





# INSTITUTIONAL & SECURITY REPAIR PARTS

## SUPPLY TUBE FOR KOHLER PRISON

## FOR KOHLER PRISON VALVE REPAIR KIT

LF115100

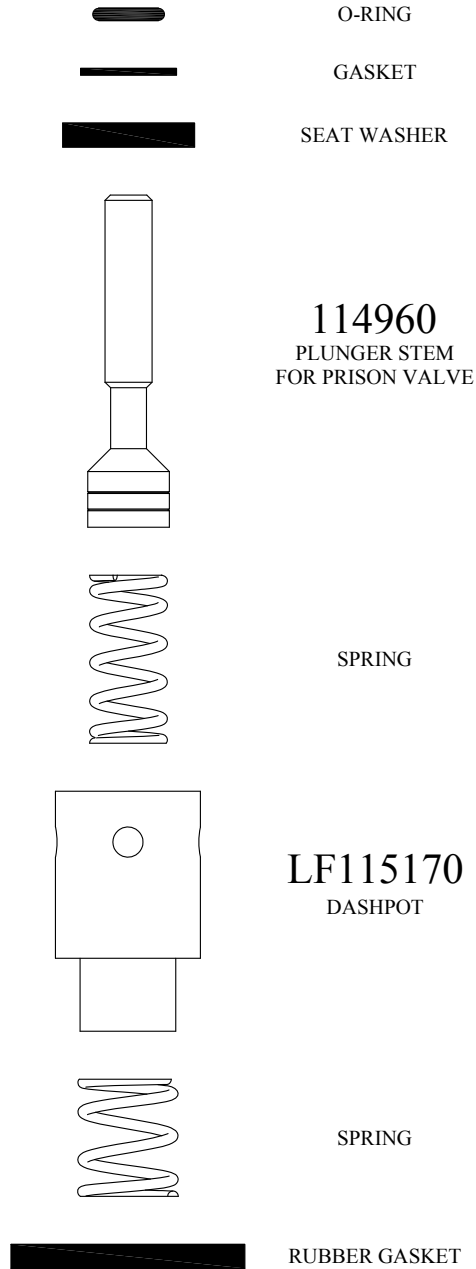
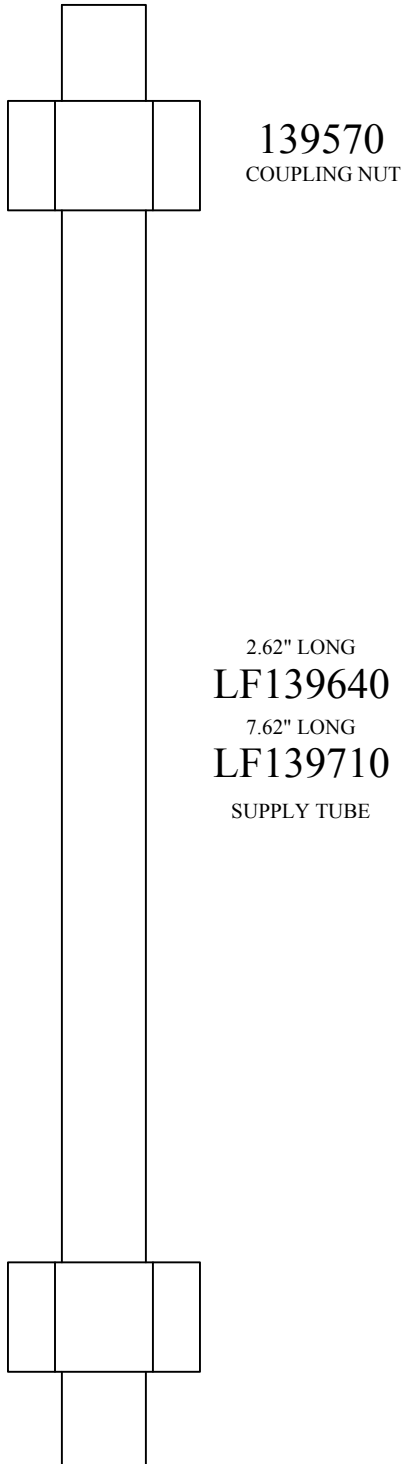

REPAIR KIT #134180 ALSO AVAILABLE  
LESS LEAD FREE DASHPOT

# INSTITUTIONAL & SECURITY REPAIR PARTS

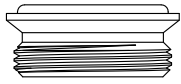

SEAT FOR LEONARD  
53/64 - 24 X 3/8" HIGH

**647840**

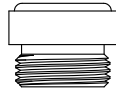

SEAT FOR LEONARD  
1/2 - 27 X 7/16" HIGH

**LF648860**

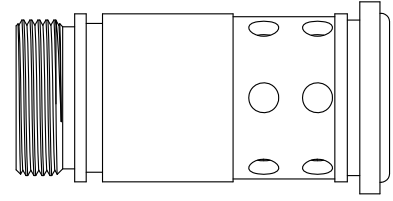

STAINLESS STEEL  
SEAT FOR LEONARD

**646860**

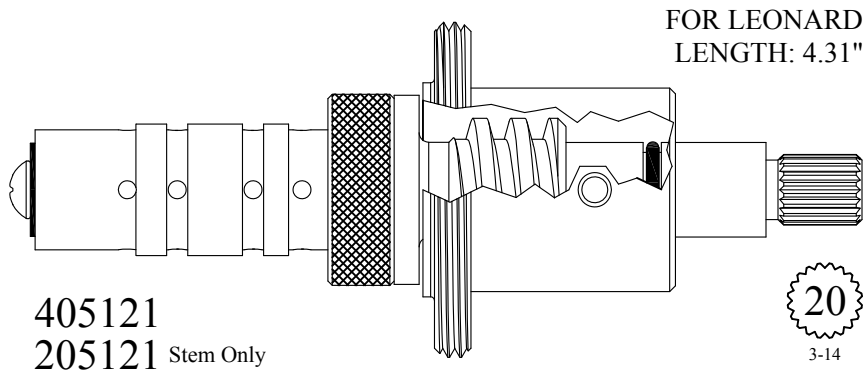

**405121**

**205121** Stem Only

**20**  
3-14

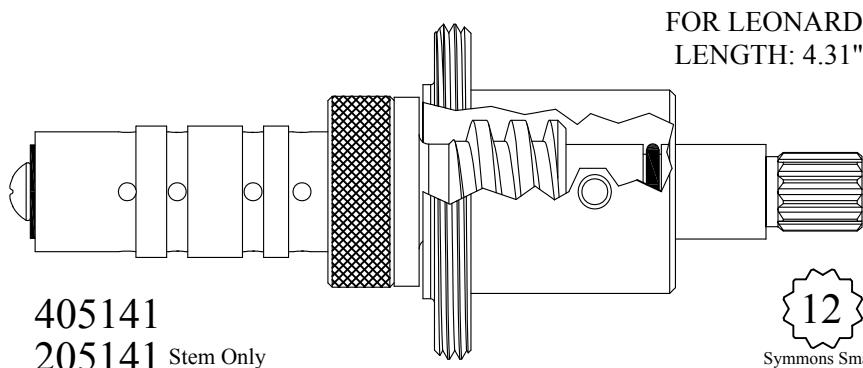

**405141**

**205141** Stem Only

**12**  
Symmons Small

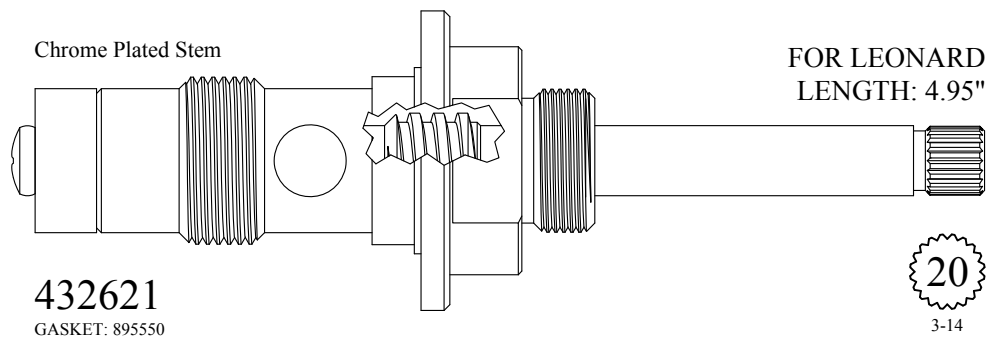

**432621**

GASKET: 895550

**20**  
3-14

# INSTITUTIONAL & SECURITY REPAIR PARTS

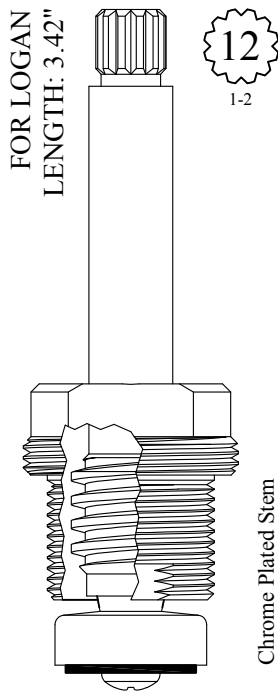

GASKET: 895400

402811  
202811 Stem Only

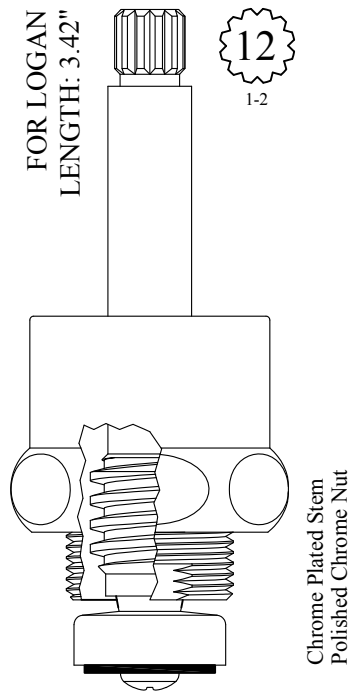
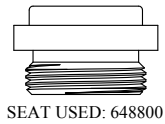

GASKET: 895400 INCLUDED

402811-N  
202811 Stem Only

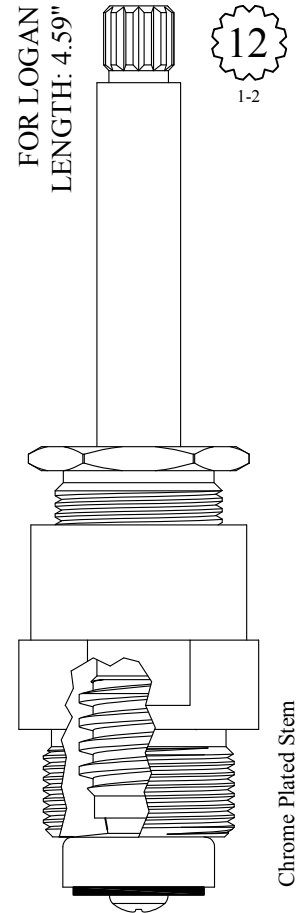
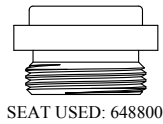

GASKET: 895430

410011  
210011 Stem Only

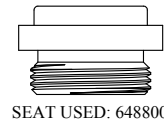

# INSTITUTIONAL & SECURITY REPAIR PARTS

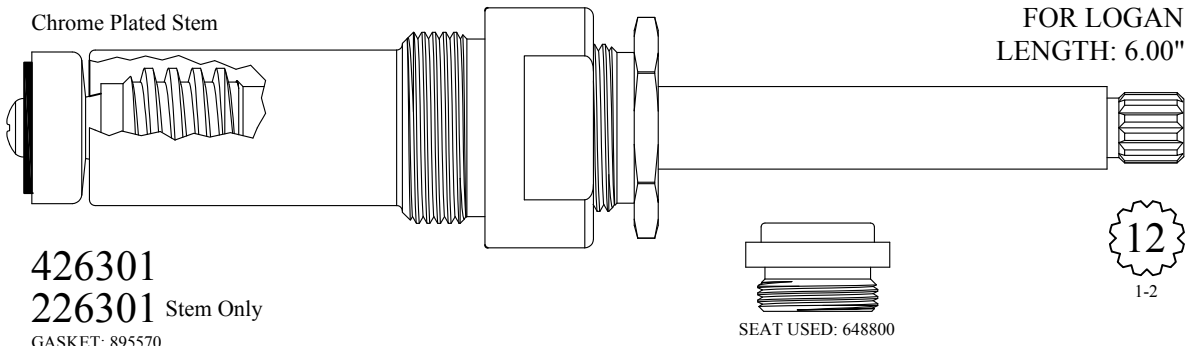

426301  
226301 Stem Only  
GASKET: 895570

Also available in the following lengths:

THESE STEMS ARE ALL CHROME PLATED

UNIT	STEM ONLY	LENGTH
427201	227201	6.50"
427501	227501	7.00"
428301	228301	8.00"
428401	228401	9.50"
429301	229301	12.00"
429501	229501	14.00"
429601	229601	16.00"
429701	229701	18.00"

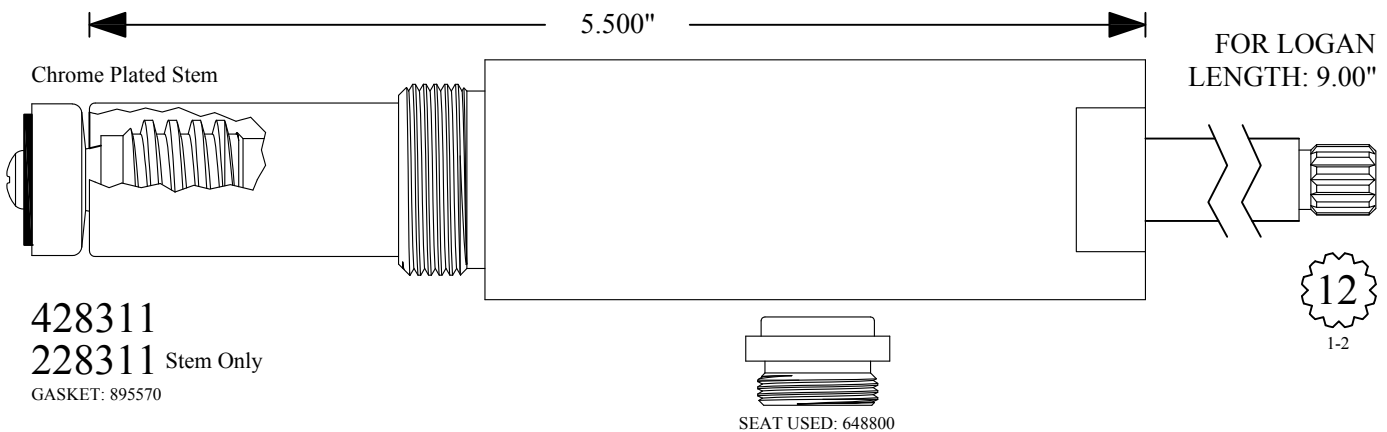

428311  
228311 Stem Only  
GASKET: 895570

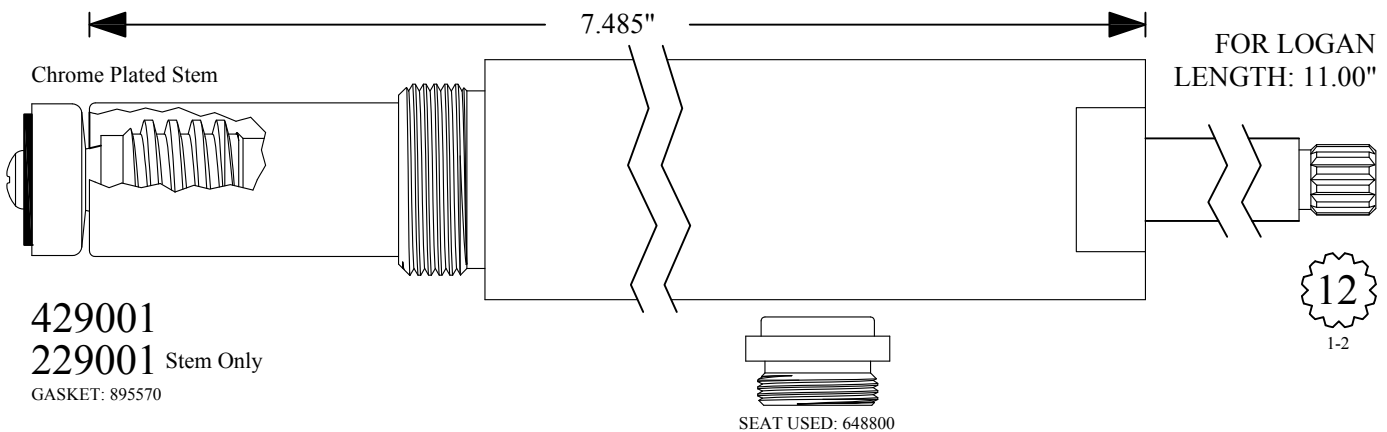

429001  
229001 Stem Only  
GASKET: 895570

# INSTITUTIONAL & SECURITY REPAIR PARTS

FOR METCRAFT  
LENGTH: 2.05"

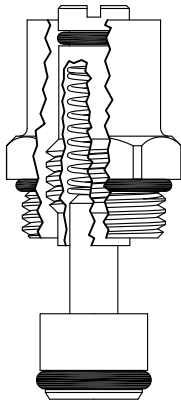

GASKET: 890170 O-RING INCLUDED

**LF400751**

FOR METCRAFT  
LENGTH: 2.10"

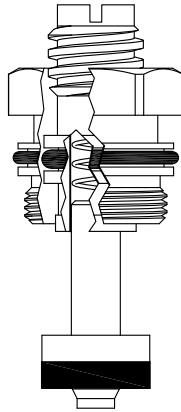

**LF400441**

FOR METCRAFT  
LENGTH: 2.10"

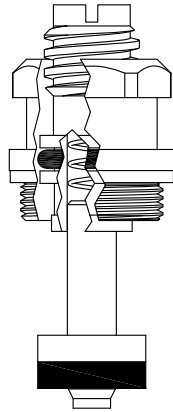

GASKET: 895100 INCLUDED

**LF400461**

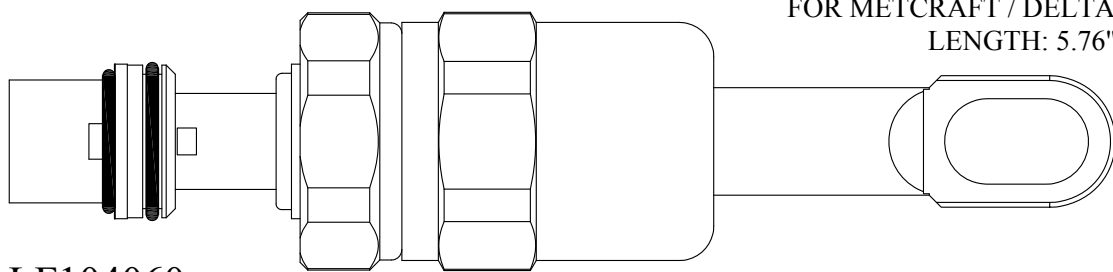

FOR METCRAFT / DELTA  
LENGTH: 5.76"

**LF104060**

**106160** Bonnet Only

**104550** Lever Handle Only

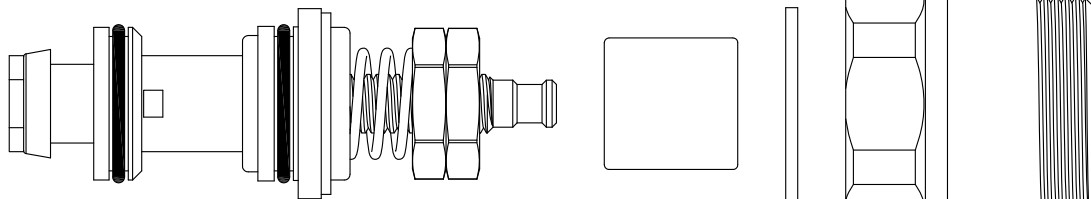

FOR METCRAFT / DELTA  
LENGTH: 2.85"

**LF128000**

**LF130850** Cartridge Only

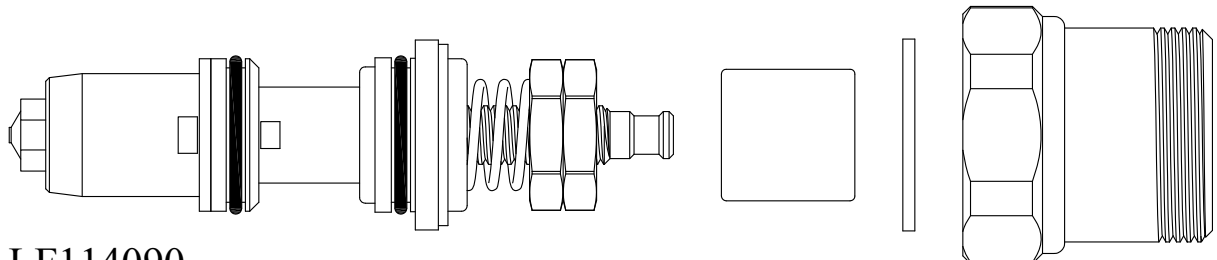

FOR METCRAFT / DELTA  
LENGTH: 3.46"

**LF114090**

**LF114020** Cartridge Only

# INSTITUTIONAL & SECURITY REPAIR PARTS

FOR POWERS  
LENGTH: 1.63"

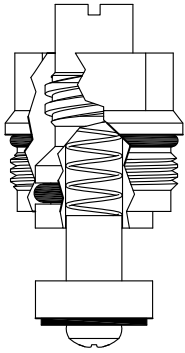

GASKET: 890180 O-RING INCLUDED

400261

FOR POWERS  
LENGTH: 1.73"

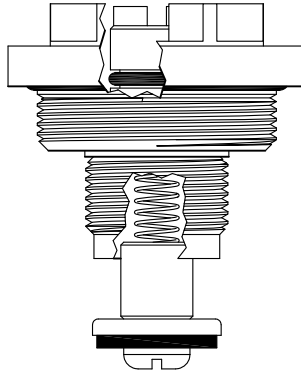

GASKET: 891230 O-RING INCLUDED

400471

200471 Stem Only

500470-KIT Retainer & Spring Only

Also available as chrome plated unit  
400471-CP  
200471-CP Stem Only

SHOWER MIXER FOR POWERS

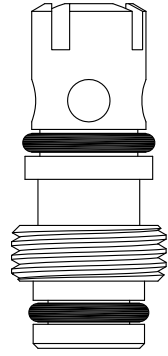

Nickel Plated

134230

FOR POWERS  
LENGTH: 2.28"

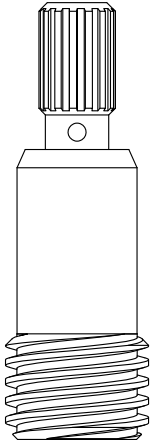

201181  
OEM# 227-234

FOR POWERS  
LENGTH: 2.28"

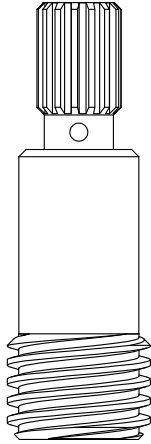

201201  
OEM# 420-122

FOR POWERS  
LENGTH: 2.60"

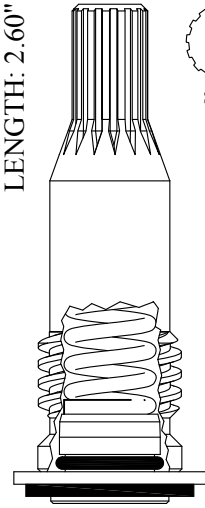

201531  
OEM# 420-139

Brass Plate  
Chrome Plated Stem

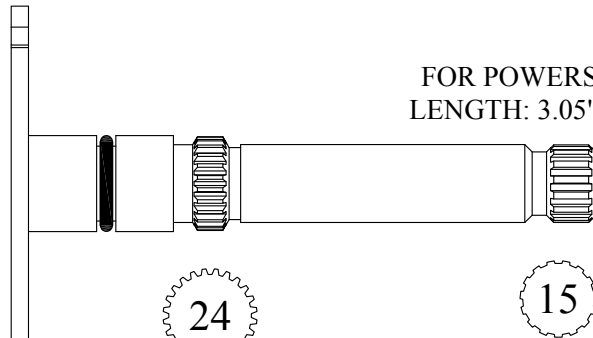
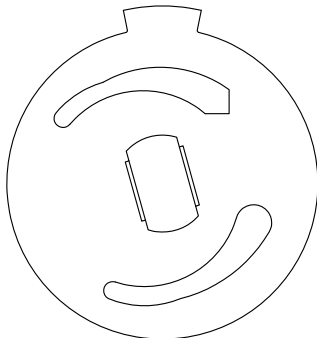

FOR POWERS  
LENGTH: 3.05"



201870

# INSTITUTIONAL & SECURITY REPAIR PARTS

For Symmons  
"Free-Flo"

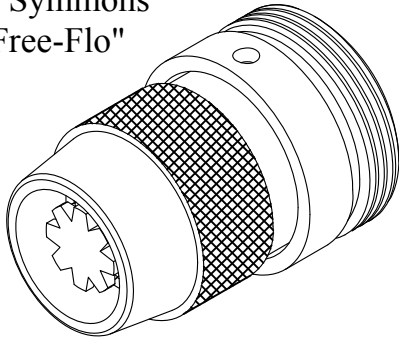

110270: 1.5 GPM  
OEM# FF-1A1.5  
131190: 2.5 GPM  
OEM# FF-1A

For Symmons  
"Free-Flo" Rigid

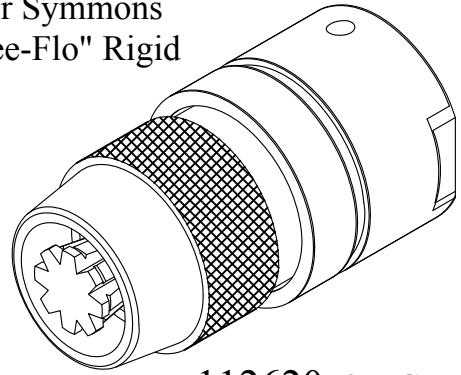

112620: 2.5 GPM  
OEM# 4-285F

FOR SYMMONS  
LENGTH: 1.75"



400661  
OEM# T-52  
200661 Stem Only

Chrome Plated Gland & Push Button

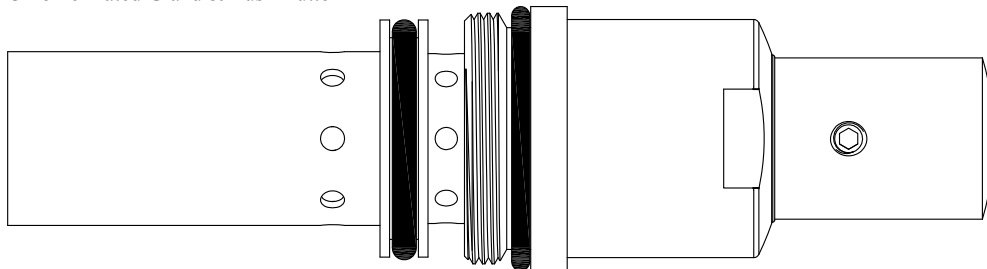

FOR SYMMONS  
LENGTH: 5.12"

415410  
OEM# NS-1

# INSTITUTIONAL & SECURITY REPAIR PARTS

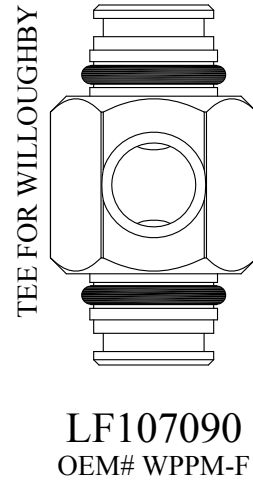
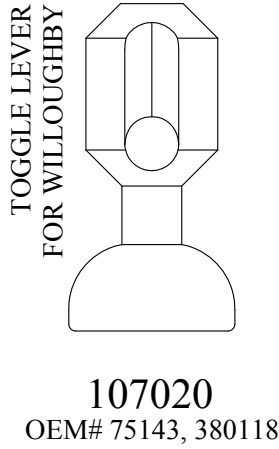
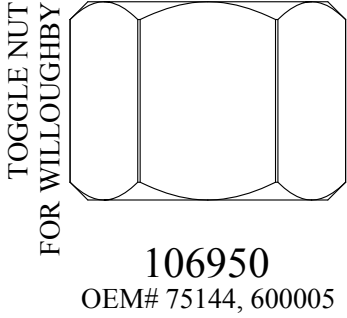

REPAIR KIT AVAILABLE  
**145450**  
KIT INCLUDES:  
BEVELED BIBB WASHER  
15.5MM x 3MM O-RING  
.312 x .187 x .062 O-RING  
.84 x .625 x .105 WASHER  
6-32 x 1/4" BIBB SCREW

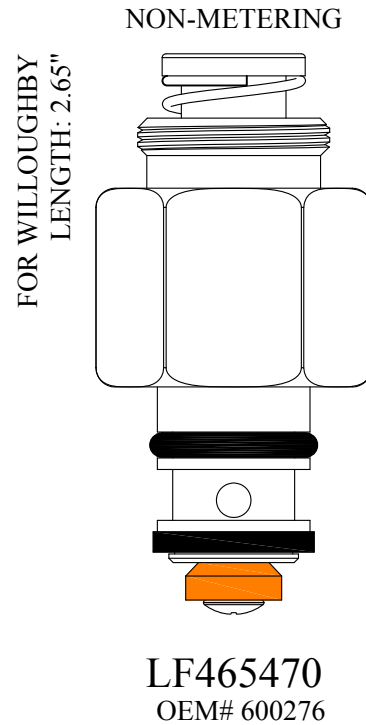
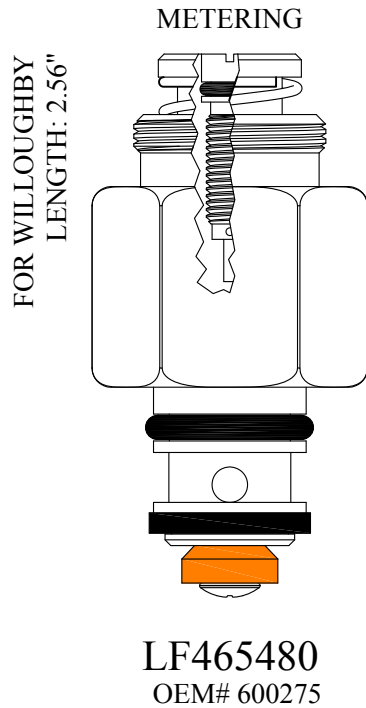
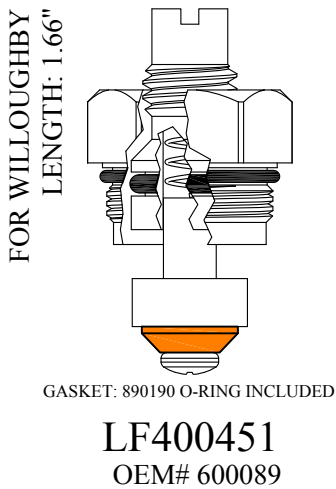



BARRY E.  WALTER SR. CO.

# VALVE BODIES, BODY EXTENSIONS & COMPONENTS



# VALVE BODIES

DRINKING FOUNTAIN  
RETRO KIT

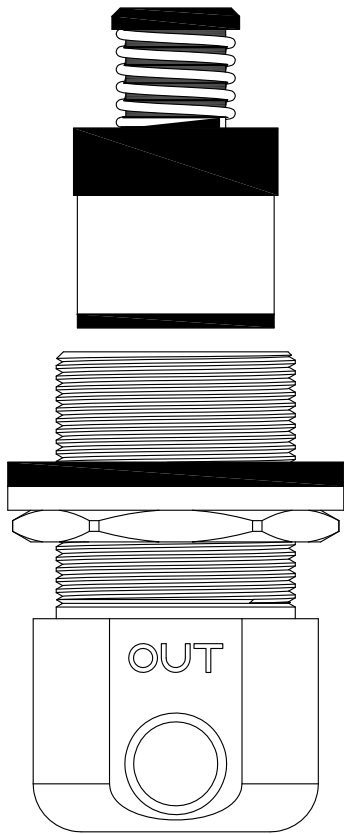

Includes Locknut  
LF124640  
LF124620

With Cartridge  
W/O Cartridge

FOR CRANE PRE-WAR

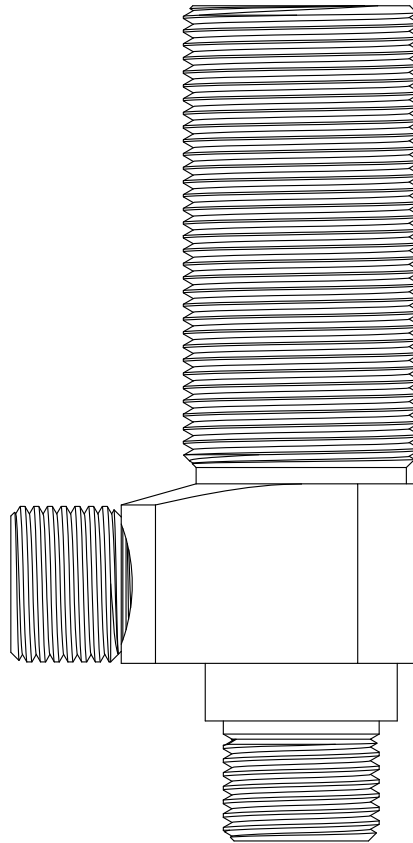

LF132640

FOR CRANE DIAL-EZE

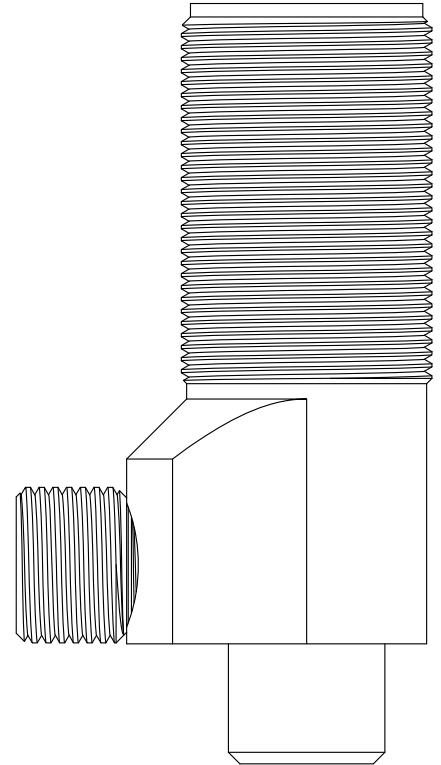

LF122490

FOR CONCINNITY  
WIDE SPREAD LAV

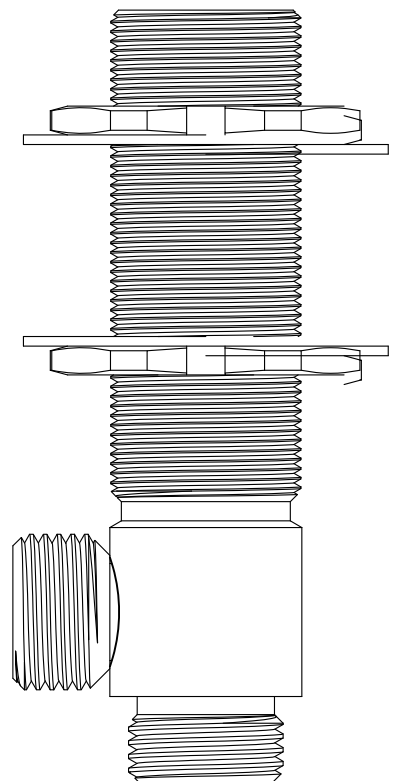

LF189460

279

FOR CRANE DIAL-EZE

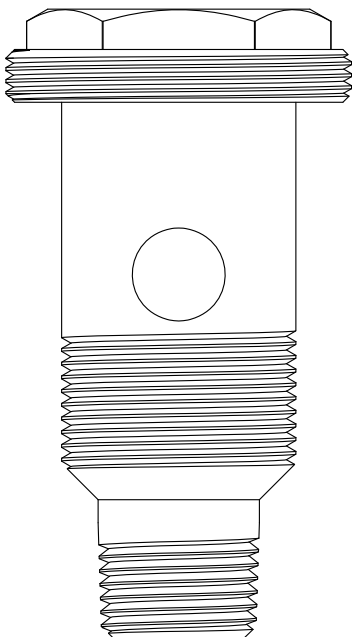

LFF10697

FOR CRANE

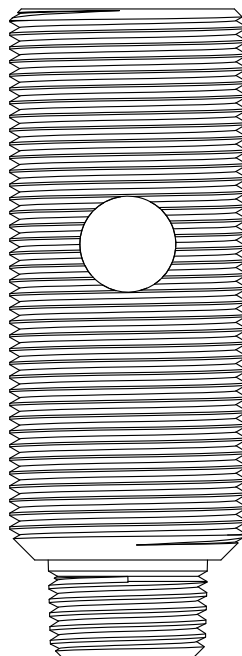

LF115610

# VALVE BODIES

FOR TUB ONLY

LF139220 FOR LEVER HANDLES  
LF139290 FOR CROSS HANDLES

11" ON CENTER

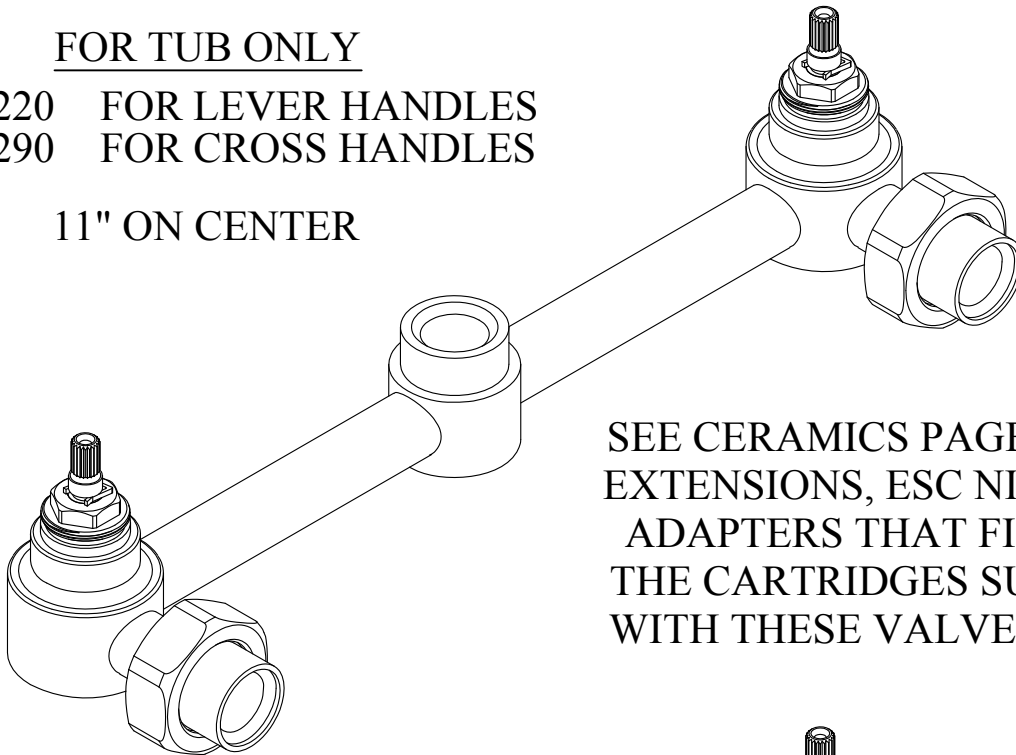

SEE CERAMICS PAGE 62 FOR  
EXTENSIONS, ESC NIPPLES &  
ADAPTERS THAT FIT WITH  
THE CARTRIDGES SUPPLIED  
WITH THESE VALVE BODIES

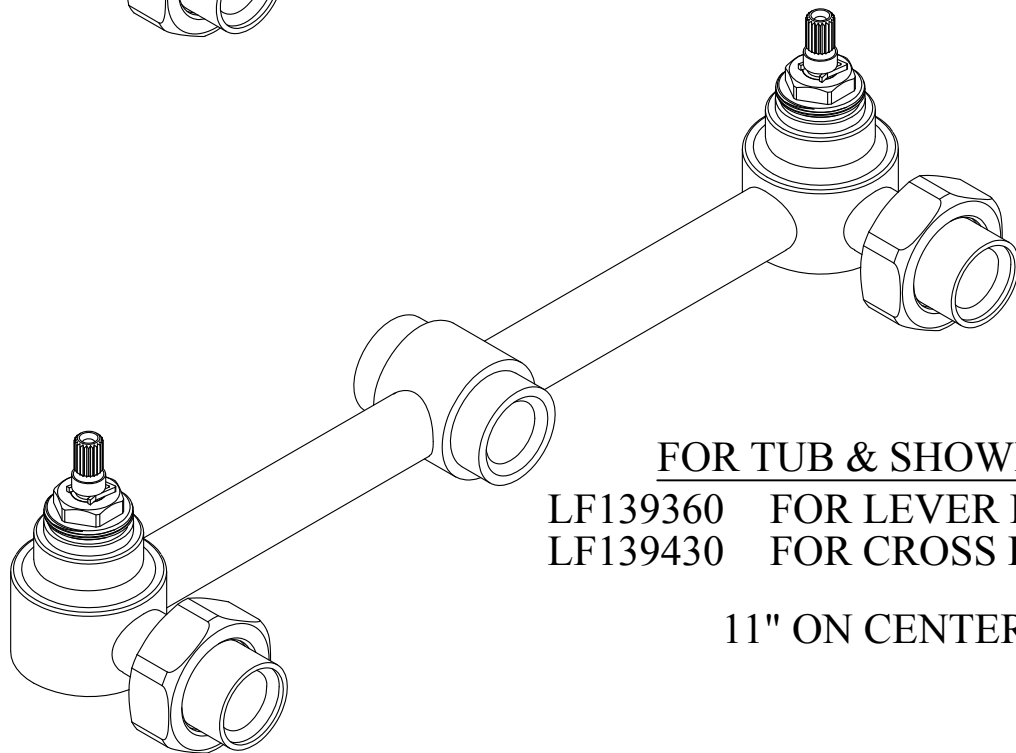

FOR TUB & SHOWER

LF139360 FOR LEVER HANDLES  
LF139430 FOR CROSS HANDLES

11" ON CENTER

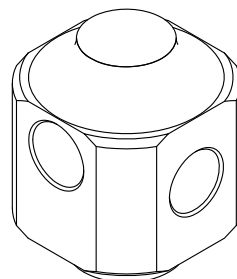

113390

FOR I.W. DIVERTER BODY

# VALVE BODY COMPONENTS

FOR CONCINITY  
OEM#: VB-1251

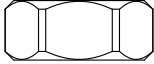

17/32 - 20 Female  
117900

FOR CONCINITY

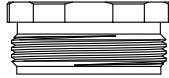

13/16 - 27 Male  
127320

FOR CONCINITY

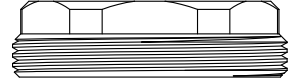

1-7/16 - 20 Male  
127180

FOR CONCINITY OEM#: 6840-6

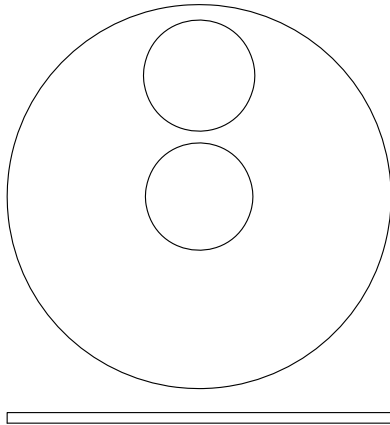

125040

FOR CRANE  
OEM#: F11671

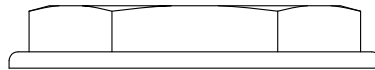

1-7/32 - 14 Female  
134300

FOR KOHLER / CONCINITY  
OEM#: 78090-RP / 30334-11



1-19/64 - 14 Female  
119860

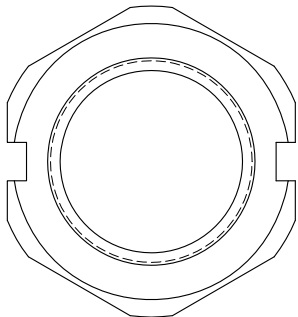

1" - 20 Female  
127490



1/2 - 14 NPT Female  
118880

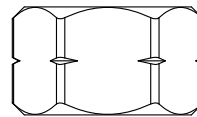

1/2 - 14 NPS Female  
104130

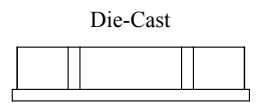

Die-Cast  
1/2 - 14 NPS Female  
102780

# BODY EXTENSIONS

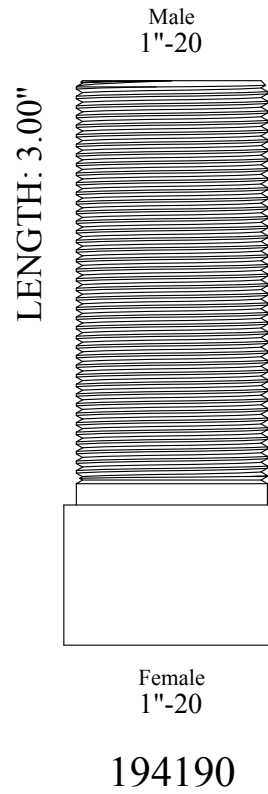
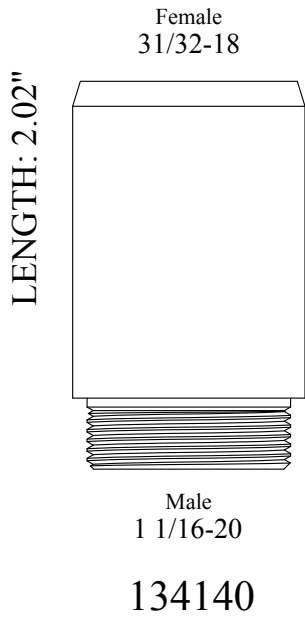

## AM STD RELIANT S/L CARTRIDGE EXTENSION KIT

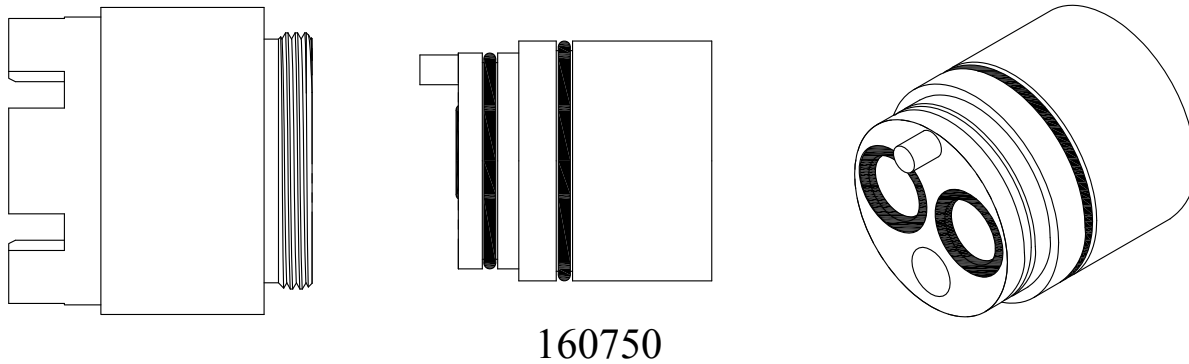

## FOR KOHLER VALVETTE

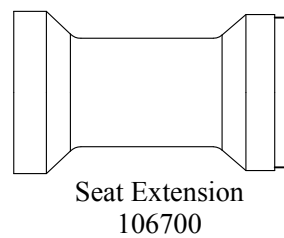
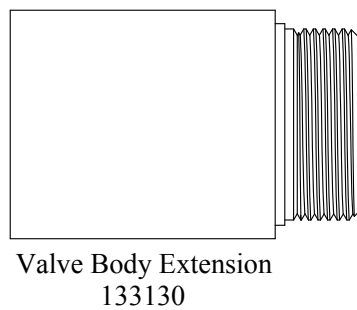

Extension Kit  
133060

BARRY E.  WALTER SR. CO.

# OEM PARTS





# MISC. REPAIR PARTS BY MFG.

## FOR AMERICAN STANDARD

Large Hole

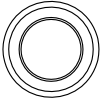

PACKING ADAPTER  
FOR SHOWER VALVE  
**29103-07**

Large Hole

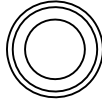

PACKING  
FOR SHOWER VALVE  
**29104-07**

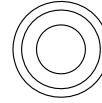

V PACKING  
FOR LAV FAUCET  
**29312-07**

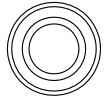

PACKING ADAPTER  
FOR LAV FAUCET  
**LF29313-07**

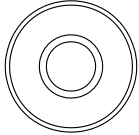

LOCKNUT  
FOR LAV FAUCET  
**20900-07**

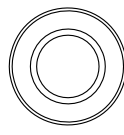

GLAND  
FOR EXPOSED SHOWER  
**LF33897-07**

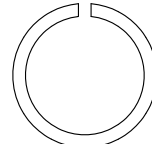

WAVE WASHER  
AM STD COLONY  
**897110**  
OEM# 72852-0700



**108730**  
OEM# 66353-07

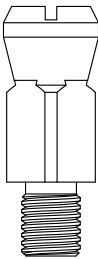

COLD WATER CHOKE  
FOR 1/2" MIXING VALVE  
**1383-27**

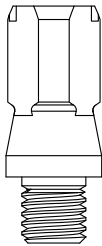

HOT WATER CHOKE  
FOR 1/2" MIXING VALVE  
**1397-27**

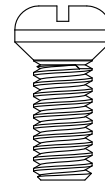

CAP SCREW  
FOR 1/2" MIXING VALVE  
**21779-07**

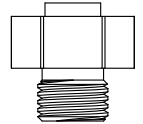

REGULATING SCREW CAP  
FOR 1/2" MIXING VALVE  
**106980**  
OEM# 851-17

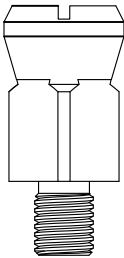

COLD WATER CHOKE  
FOR 3/4" MIXING VALVE  
**27341-07**

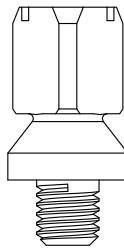

HOT WATER CHOKE  
FOR 3/4" MIXING VALVE  
**27342-07**

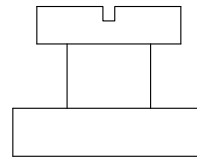

SEAT WASHER HOLDER  
FOR 3/4" MIXING VALVE  
**27343-07** COLD  
**27344-07** HOT

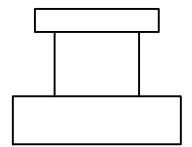

SEAT WASHER HOLDER  
FOR 1/2" MIXING VALVE  
**1399-27** COLD  
**1400-27** HOT

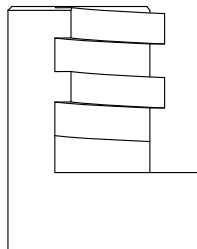

PLUNGER  
FOR MIXING VALVE  
**11306-07** HOT  
**27208-07** COLD

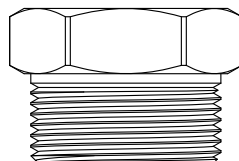

PACKING NUT  
FOR MIXING VALVE  
**24476-07**

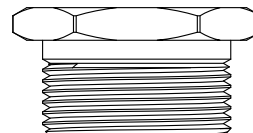

PACKING NUT  
FOR MIXING VALVE  
**305930**  
OEM# 65497-070

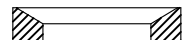

PACKING GLAND  
FOR MIXING VALVE  
**33894-07**

# MISC. REPAIR PARTS BY MFG.

## FOR AMERICAN STANDARD

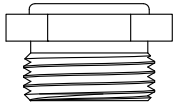

PEDAL VALVE SEAT

**LF649710**  
 OEM# 65626-0040A  
**LF649710-N**  
 NICKEL PLATED

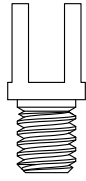

PEDAL VALVE STEM GUIDE

**20836-07**

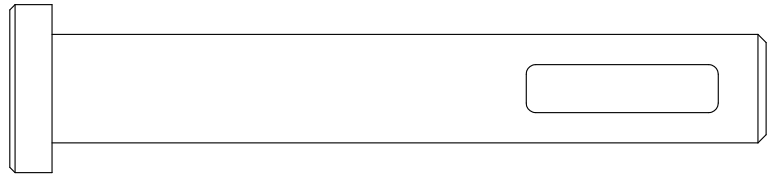

PEDAL VALVE STEM

**65183-07**

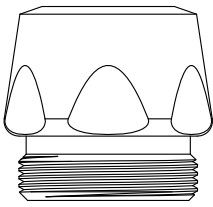

HANDLE BONNET  
 FOR WALL MOUNT SINK

**139880**  
 OEM# 28343-02

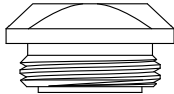

VALVE PLUG  
 FOR PUSH-PULL SHOWER VALVE

**29109-07**



LOCK RING  
 FOR DRINKING FOUNTAIN

**187-27**

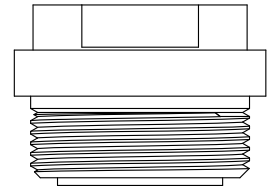

SPRING HOUSING  
 FOR DRINKING FOUNTAIN

**LF519-22**



PACKING NUT  
 FOR PRISON VALVE

**25009-07**

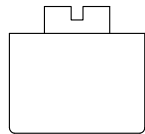

SEAT WASHER HOLDER  
 FOR PRISON VALVE

**LF60055-07**

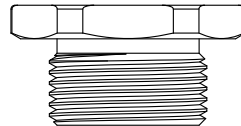

CAP NUT  
 FOR PRISON VALVE

**LF60053-07**

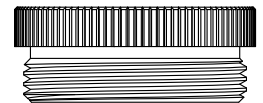

PACKING NUT  
 FOR BEDPAN CLEANER

**119160**

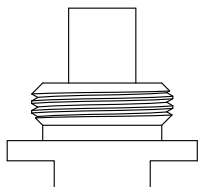

GUIDE PLUG  
 FOR BEDPAN CLEANER

**132390**

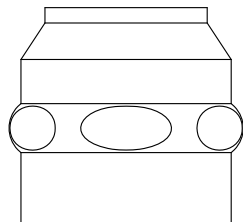

HOSE CONNECTION  
 FOR BEDPAN CLEANER

**106650**  
 OEM# 655-12

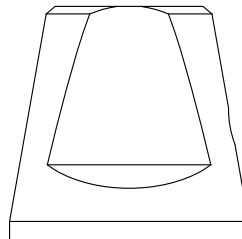

CAP NUT  
 FOR BEDPAN CLEANER

**33704-02**

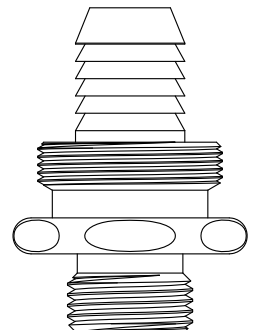

MALE HOSE CONNECTION  
 FOR BEDPAN CLEANER

**105440**  
 OEM# 654-12

# MISC. REPAIR PARTS BY MFG.

## FOR AMERICAN STANDARD

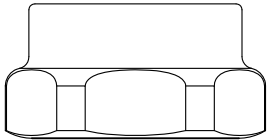
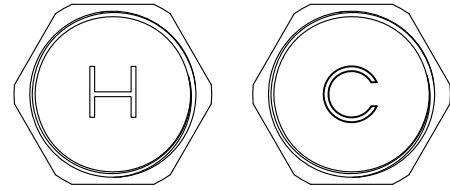
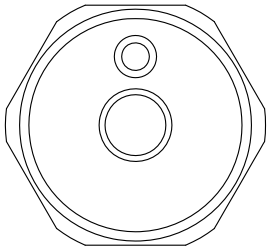

Polished Chrome

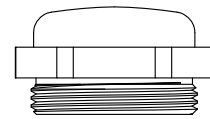

Polished Chrome

111410  
OEM# 364-12

143140 Hot OEM# 23329-0230  
111550 Cold OEM# 23329-0210  
111670 Blank OEM# 23329-Blank

## FOR BRADLEY

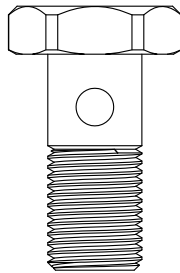

BUBBLER CONNECTION PLUG  
FOR PRISON VALVE

LF118180  
OEM# 153-183

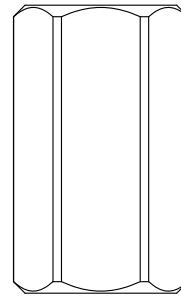

CONNECTION BODY WITH  
FLOW CONTROL (0.5 GPM)  
FOR PRISON VALVE

126580  
OEM# S88-028

## FOR CENTRAL

## FOR CHICAGO

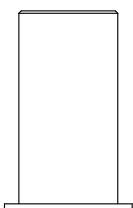

DASHPOT  
SLOW-CLOSE FAUCET

LF170-E



RETAINER  
FOR SLOW-CLOSE FAUCET

LF170-D



VACUUM BREAKER SEAT GUIDE

LF118620

Brass Part

# MISC. REPAIR PARTS BY MFG. FOR CONCINNITY

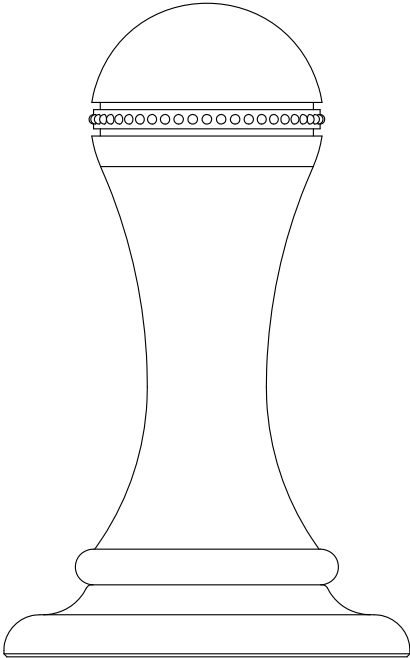

ROBE HOOK  
121680

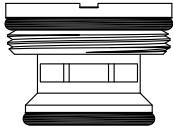

SPRAY DIVERTER  
LF103380  
OEM# 30820-42

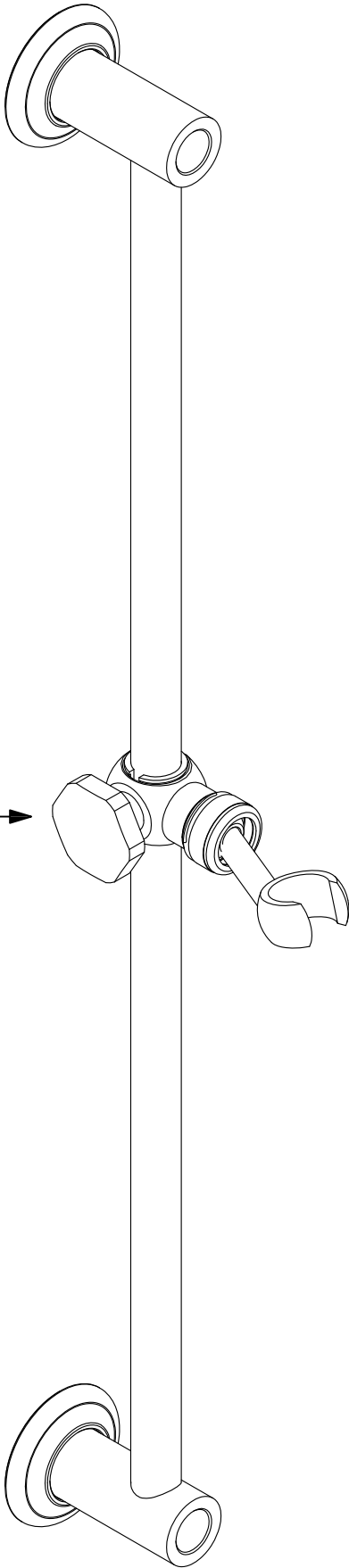

103940 →  
OEM# 30791-HCL  
CLUTCH  
ASSEMBLY  
ONLY

117660  
OEM# 2916

# MISC. REPAIR PARTS BY MFG. FOR CRANE

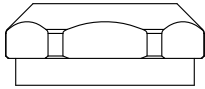

CAP NUT  
FOR MAGIC CLOSE  
**F11993**

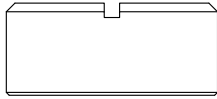

RETAINER NUT  
**108960**

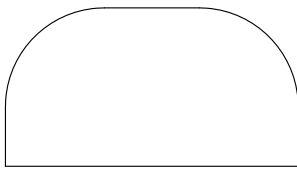

CHROME PLATED COVER  
FOR POP-UP  
**F11619**

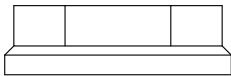

LOCKNUT  
FOR DIAL-ESE  
**F10583** Brass  
**F10584** Chrome

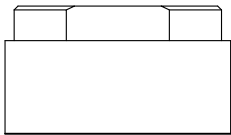

LOCKNUT  
FOR DIAL-ESE  
**F10715** Brass  
**F10716** Chrome

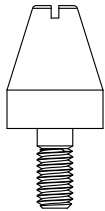

HOT WATER PLUNGER  
FOR MIXING VALVE  
**FB1756**

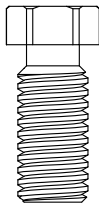

LOCKING RING SCREW  
FOR WASTE FITTING  
**F13521**

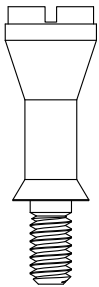

COLD WATER PLUNGER  
FOR MIXING VALVE  
**FB1759**

# MISC. REPAIR PARTS BY MFG.

## FOR DELTA

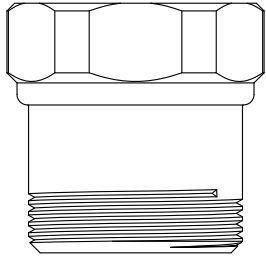

BONNET NUT  
FOR METERING VALVE

130240

Also available chrome plated  
130240-CP

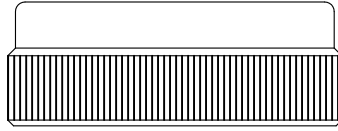

BONNET

140760

REPLACES: OEM# RP6079

Chrome Plated

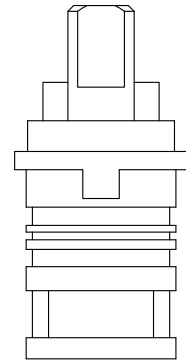

SEAT WASHER HOLDER

DL1740

All Plastic Unit

## FOR ELJER

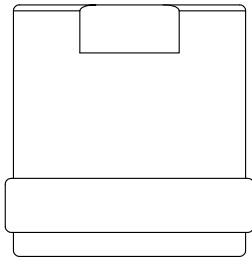

SLEEVE

180640

REPLACES: OEM# 490-8142-01

Chrome Plated

## FOR ELKAY/ HALSEY TAYLOR

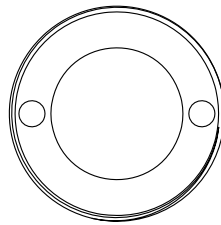

LOCK RING  
FOR DRINKING FOUNTAIN

130820

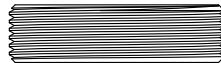

## FOR HALSEY TAYLOR

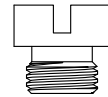

BUSHING  
FOR DRINKING FOUNTAIN

LF151450

OEM# 1189

## FOR HAWS

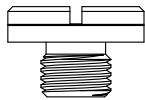

SEAT WASHER HOLDER  
FOR DRINKING FOUNTAIN

LF171320

OEM# 1153

## FOR KOHLER



PACKING NUT  
FOR NIEDECKEN

21974

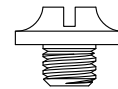

SCREW  
FOR MIXING VALVE

21960

## FOR MIXET

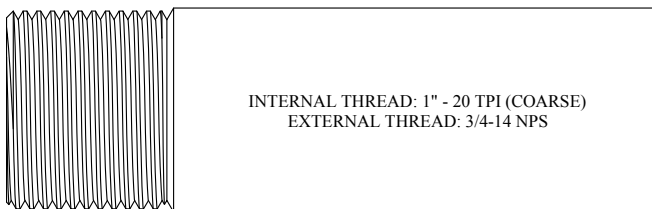

INTERNAL THREAD: 1" - 20 TPI (COARSE)  
EXTERNAL THREAD: 3/4-14 NPS

SLEEVE

115450

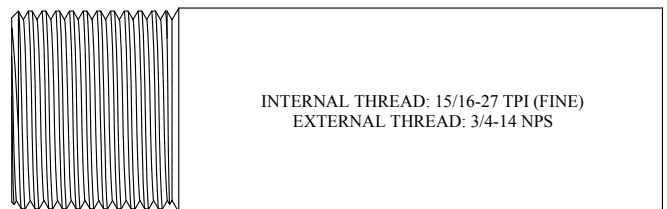

INTERNAL THREAD: 15/16-27 TPI (FINE)  
EXTERNAL THREAD: 3/4-14 NPS

SLEEVE

155510

# MISC. REPAIR PARTS BY MFG. FOR PARAMOUNT

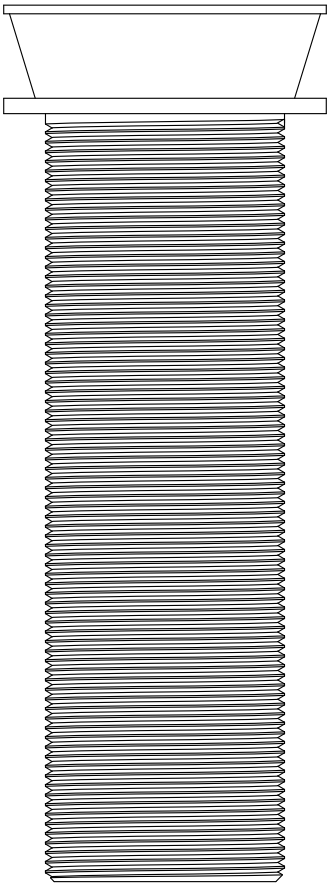

DECK SPOUT HOUSING  
**105900**  
OEM# 12702-1

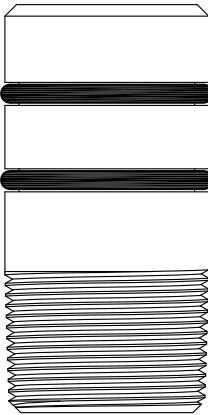

DECK SPOUT SHANK  
**105970**  
OEM# 12702-2

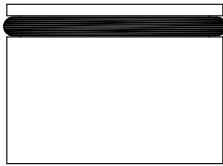

WALL SPOUT FITTING  
**105830**  
OEM# 30282

## FOR PRICE PFISTER

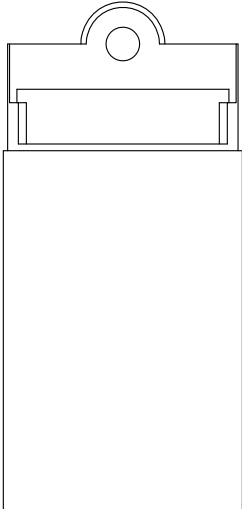

WASTE & OVERFLOW PLUNGER  
**150530**

# MISC. REPAIR PARTS BY MFG.

## FOR ROYAL BRASS

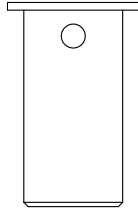

DASHPOT  
FOR SELF-CLOSING VALVE  
**LF18-119**



METERING SCREW  
FOR SELF-CLOSING VALVE  
**LF02-110**

## FOR SPEAKMAN



CHAMBER NUT  
FOR METERING VALVE  
**LF01-0713**

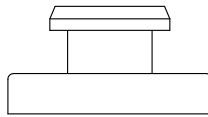

WASHER HOLDER  
FOR MIXOMETER VALVE  
**05-0427** COLD  
**05-0426** HOT

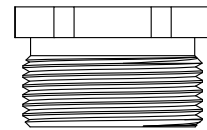

PACKING NUT  
FOR MIXOMETER VALVE  
**01-0352**

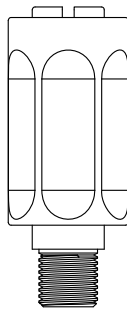

COLD PLUNGER  
FOR MIXOMETER VALVE  
**05-0244**

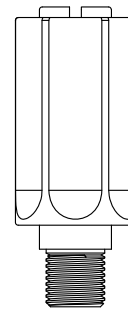

HOT PLUNGER  
FOR MIXOMETER VALVE  
**05-0243**



# MISC. REPAIR PARTS BY MFG. FOR SPEAKMAN

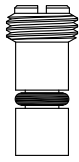

TEMPERATURE LIMIT SCREW  
FOR SENTINEL VALVE

03-0305



PLUNGER RETAINER PIN  
FOR SENTINAL VALVE

51-0029

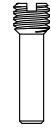

PLUNGER VALVE PIN  
FOR SENTINAL VALVE

51-0053

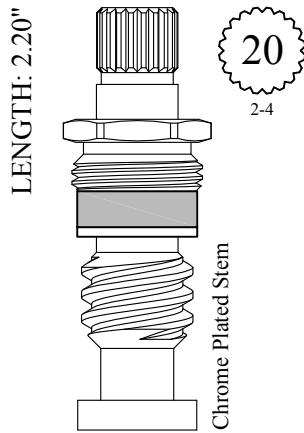

STEM UNIT  
FOR SENTINEL VALVE

401131

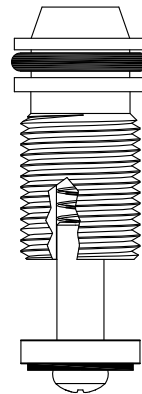

STOP UNIT  
FOR SENTINEL VALVE

400390

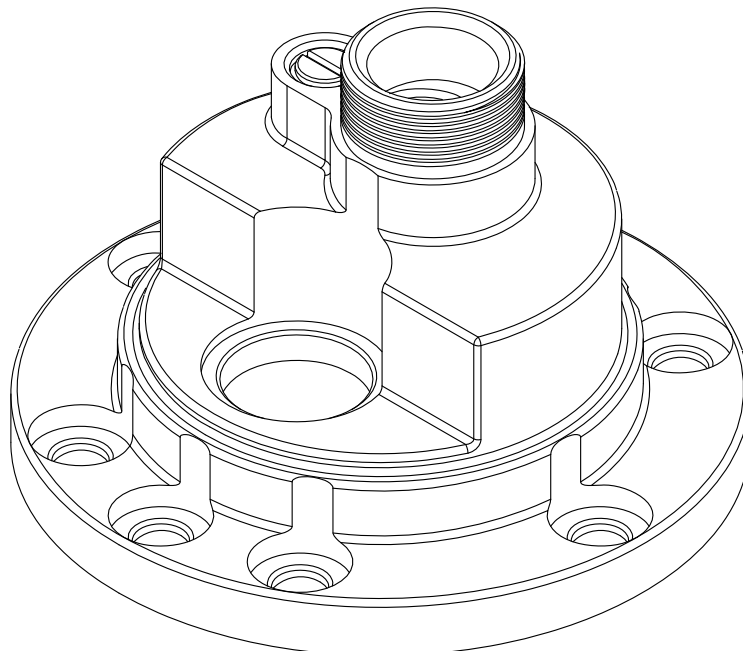

SENTINEL HUB  
G06-0021-MO

# MISC. REPAIR PARTS BY MFG.

UNKNOWN

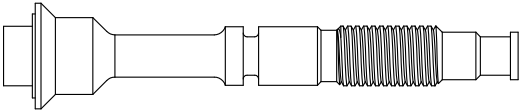

METERING VALVE STEM  
STM8906M

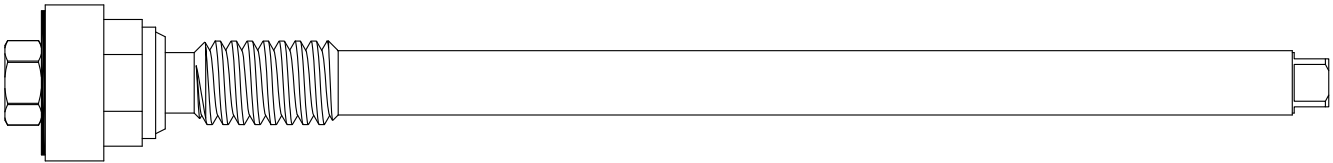

HYDRANT STEM  
187361

## FOR VALLEY

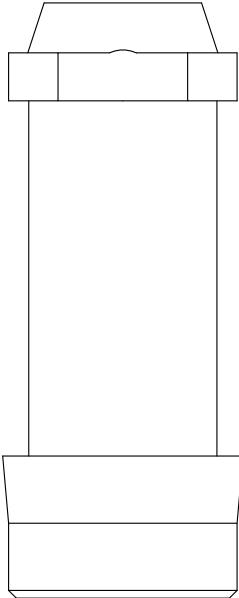

Chrome Plated

SLEEVE  
182320  
OEM# VA4715