

SUUNTO EON CORE

USER GUIDE 3.0

| | |
|--|----|
| 1. Intended use..... | 5 |
| 2. Safety..... | 6 |
| 3. Getting started..... | 10 |
| 3.1. Device setup..... | 10 |
| 3.2. Display - modes, views, and states..... | 10 |
| 3.3. Icons..... | 11 |
| 3.4. Product compatibility..... | 12 |
| 4. Features..... | 13 |
| 4.1. Alarms, warnings, and notifications..... | 13 |
| 4.2. Algorithm lock..... | 14 |
| 4.3. Altitude diving..... | 15 |
| 4.4. Ascent rate..... | 16 |
| 4.5. Battery..... | 16 |
| 4.6. Bookmark..... | 17 |
| 4.7. Clock..... | 17 |
| 4.8. Compass..... | 17 |
| 4.8.1. Calibrating compass..... | 17 |
| 4.8.2. Setting declination..... | 18 |
| 4.8.3. Locking the bearing..... | 18 |
| 4.9. Customizing dive modes with Suunto app..... | 19 |
| 4.10. Decompression algorithm..... | 19 |
| 4.10.1. Diver safety..... | 20 |
| 4.10.2. Oxygen exposure..... | 20 |
| 4.11. Decompression dives..... | 21 |
| 4.11.1. Last stop depth..... | 23 |
| 4.12. Deco profile..... | 24 |
| 4.13. Device info..... | 25 |
| 4.14. Display..... | 25 |
| 4.15. Dive history..... | 25 |
| 4.16. Dive modes..... | 26 |
| 4.16.1. Air/Nitrox mode..... | 26 |
| 4.16.2. Gauge mode..... | 27 |
| 4.17. Dive planner..... | 28 |
| 4.18. Flip display..... | 28 |
| 4.19. Gas consumption..... | 28 |
| 4.20. Gas mixtures..... | 29 |
| 4.21. Gas time..... | 30 |
| 4.22. Language and unit system..... | 30 |
| 4.23. Logbook..... | 30 |
| 4.24. Multi-gas diving..... | 31 |

| | |
|---|----|
| 4.24.1. Modifying gases during a dive..... | 32 |
| 4.24.2. Isobaric counterdiffusion (ICD)..... | 32 |
| 4.25. Oxygen calculations..... | 33 |
| 4.26. Personal setting..... | 33 |
| 4.27. Rebreather diving..... | 35 |
| 4.27.1. Closed-circuit gases..... | 35 |
| 4.27.2. Open-circuit gases..... | 35 |
| 4.27.3. Setpoints..... | 35 |
| 4.27.4. Bailouts..... | 36 |
| 4.28. Safety stops and deepstops..... | 37 |
| 4.29. Sample rate..... | 38 |
| 4.30. Standby and deep sleep..... | 39 |
| 4.31. Surface and no-fly time..... | 39 |
| 4.32. Suunto app..... | 40 |
| 4.32.1. Synchronizing logs and settings..... | 40 |
| 4.33. SuuntoLink..... | 41 |
| 4.34. Tank pressure | 41 |
| 4.35. Timer..... | 41 |
| 4.36. Water contacts..... | 42 |
| 5. Use..... | 43 |
| 5.1. How to access device info..... | 43 |
| 5.2. How to change display brightness..... | 43 |
| 5.3. How to set language and unit..... | 43 |
| 5.4. How to set time and date..... | 43 |
| 5.5. How to install and pair a Suunto Tank POD..... | 44 |
| 5.6. How to plan a dive using the Dive planner..... | 47 |
| 5.7. How to customize dive modes with Suunto app..... | 48 |
| 5.8. How to enable gas consumption metering..... | 50 |
| 5.9. How to add bookmarks..... | 50 |
| 6. Care and support..... | 51 |
| 6.1. Handling guidelines..... | 51 |
| 6.2. Installing scratch guard..... | 51 |
| 6.3. Changing strap to bungee..... | 52 |
| 6.4. Charging battery..... | 52 |
| 6.5. Getting support..... | 53 |
| 6.6. Disposal and recycling..... | 53 |
| 7. Reference..... | 54 |
| 7.1. Technical specifications..... | 54 |
| 7.2. Compliance..... | 56 |
| 7.3. Trademark..... | 56 |

| | |
|--|----|
| 7.4. Patent notice..... | 57 |
| 7.5. International Limited Warranty..... | 57 |
| 7.6. Copyright..... | 58 |
| 7.7. Dive terms..... | 58 |

1. Intended use

The Suunto EON Core dive computer is designed for use as an optional diving equipment for recreational diving. Suunto EON Core is intended for use in various types of scuba diving, for example, for example, air, nitrox, trimix and CCR diving. In scuba diving use Suunto EON Core dive computer displays important information before, during and after the dive to enable safe decision making. The most important pieces of information are dive depth, dive time and decompression information. In addition, Suunto EON Core can show the user other dive related values, such as ascent speed, water temperature, and compass direction. It also helps the diver to plan the dive and to follow through the dive plan.

Suunto EON Core can be used as a standalone product or in combination with the Suunto Tank POD, which measures the tank pressure and transmits the pressure reading information to the Suunto EON Core dive computer. The combination of the Suunto EON Core and the Tank POD is a Personal Protective Equipment under the EU Regulation 2016/425 and protects against risks listed under PPE Risk Category III (a): substances and mixtures which are hazardous to health. Backup instruments, for example, depth gauge, submersible pressure gauge, timer, or watch must be used. The diver must have access to decompression tables whenever diving with a dive computer.

2. Safety

Types of safety precautions

 **WARNING:** - is used in connection with a procedure or situation that may result in serious injury or death.

 **CAUTION:** - is used in connection with a procedure or situation that will result in damage to the product.

 **NOTE:** - is used to emphasize important information.

 **TIP:** - is used for extra tips on how to utilize the features and functions of the device.

 **WARNING:** All computers experience failures. It is possible that this device may suddenly fail to provide accurate information during your dive. Always use a backup dive device and only dive with a buddy. Only divers trained in proper use of scuba diving equipment should use this dive device! **YOU MUST READ** all the printed information included with the product and the online user guide before diving. Failure to do so may lead to improper use, serious injury or death.

 **NOTE:** Make sure your Suunto dive computer always has the latest software with updates and improvements. Check before every dive trip from www.suunto.com/support, if Suunto has released a new software update for your device. When a new software update is available, you must install it before diving. Updates are made available to improve your user experience and are part of Suunto's philosophy of continuous product development and improvement.

Before you dive

Make sure that you fully understand the use, displays and limitations of your dive instruments. If you have any questions about this manual or dive instrument, contact your Suunto dealer before diving. Always remember that **YOU ARE RESPONSIBLE FOR YOUR OWN SAFETY!**

Before leaving on a dive trip, inspect your dive computer thoroughly to make sure everything is functioning properly.

At the dive site, perform your manual pre-checks on each device before entering the water.

Dive computer pre-dive safety check

Ensure that:

1. Suunto EON Core is in the correct dive mode and the display is working as expected.
2. Altitude setting is correct.
3. Personal setting is correct.
4. Deepstops are set correctly.
5. Unit system is correct.

6. Compass is calibrated. Start the calibration manually in the menu under **General » Compass » Calibrate** to also confirm that the dive computer audible sounds are working. After successful calibration, you should hear a sound.
7. The battery is fully charged.
8. All primary and backup gauges for time, pressure and depth, both digital and mechanical, are showing correct, consistent readings.
9. If Suunto Tank PODs are in use, check that the Tank PODs are properly installed and the tank valve is open. Please see the Suunto Tank POD User Guide for detailed information and proper use.
10. If Suunto Tank PODs are in use, check that connections are working and gas selections are correct.



NOTE: For Suunto Tank POD related information, please see the instructions provided with the product.

Safety precautions

⚠ WARNING: ONLY TRAINED DIVERS SHOULD USE A DIVE COMPUTER! Insufficient training for any kind of diving, including freediving, may cause a diver to commit errors, such as incorrect use of gas mixtures or improper decompression, that may lead to serious injury or death.

⚠ WARNING: THERE IS ALWAYS A RISK OF DECOMPRESSION SICKNESS (DCS) FOR ANY DIVE PROFILE EVEN IF YOU FOLLOW THE DIVE PLAN PRESCRIBED BY DIVE TABLES OR A DIVE COMPUTER. NO PROCEDURE, DIVE COMPUTER OR DIVE TABLE WILL PREVENT THE POSSIBILITY OF DCS OR OXYGEN TOXICITY! An individual's physiological makeup can vary from day to day. The dive computer cannot account for these variations. You are strongly advised to remain well within the exposure limits provided by the instrument to minimize the risk of DCS. As an added measure of safety, you should consult a physician regarding your fitness before diving.

⚠ WARNING: YOU ARE ADVISED TO AVOID FLYING ANY TIME THE COMPUTER COUNTS DOWN THE NO-FLY TIME. ALWAYS ACTIVATE THE COMPUTER TO CHECK THE REMAINING NO-FLY TIME PRIOR TO FLYING! Flying or traveling to a higher altitude within the no-fly time can greatly increase the risk of DCS. Review the recommendations given by Divers Alert Network (DAN). There can never be a flying-after-diving rule that is guaranteed to completely prevent decompression sickness!

⚠ WARNING: If you have a pacemaker, we recommend you do not scuba dive. Scuba diving creates physical stresses on the body which may not be suitable for pacemakers.

⚠ WARNING: If you have a pacemaker, consult a doctor before using this device. The inductive frequency used by the device may interfere with pacemakers.

⚠ WARNING: Allergic reactions or skin irritations may occur when product is in contact with skin, even though our products comply with industry standards. In such event, stop use immediately and consult a doctor.

⚠ WARNING: *Not for professional use! Suunto dive computers are intended for recreational use only. The demands of commercial or professional diving may expose the diver to depths and conditions that tend to increase the risk of decompression sickness (DCS). Therefore, Suunto strongly recommends that the device not be used for any commercial or professional diving activities.*

⚠ WARNING: *USE BACKUP INSTRUMENTS! Ensure that you use backup instrumentation, including a depth gauge, submersible pressure gauge, timer or watch, and have access to decompression tables whenever diving with a dive computer.*

⚠ WARNING: *For safety reasons, you should never dive alone. Dive with a designated buddy. You should also stay with others for an extended time after a dive as the onset of possible DCS may be delayed or triggered by surface activities.*

⚠ WARNING: *Perform pre-dive safety checks before each dive! Always check that your dive computer is functioning properly and has the correct settings before diving. Check that the display is working, the battery level is OK, tank pressure is correct, and so forth.*

⚠ WARNING: *Check your dive computer regularly during a dive. If you believe or conclude that there is any problem with any computer function, abort the dive immediately and safely return to the surface. Call Suunto Customer Support and return your computer to an authorized Suunto Service Center for inspection.*

⚠ WARNING: *THE DIVE COMPUTER SHOULD NEVER BE TRADED OR SHARED BETWEEN USERS WHILE IT IS IN OPERATION! Its information will not apply to someone who has not been wearing it throughout a dive, or sequence of repetitive dives. Its dive profiles must match that of the user. If it is left on the surface during any dive, the dive computer will give inaccurate information for subsequent dives. No dive computer can take into account dives made without the computer. Thus, any diving activity up to four days prior to initial use of the computer may cause misleading information and must be avoided.*

⚠ WARNING: *DO NOT EXPOSE ANY PART OF YOUR DIVE COMPUTER TO ANY GAS MIX CONTAINING MORE THAN 40% OXYGEN! Enriched air with greater oxygen content presents a risk of fire or explosion and serious injury or death.*

⚠ WARNING: *DO NOT DIVE WITH A GAS IF YOU HAVE NOT PERSONALLY VERIFIED ITS CONTENT AND ENTERED THE ANALYZED VALUE INTO YOUR DIVE COMPUTER! Failure to verify tank contents and enter the appropriate gas values where applicable into your dive computer will result in incorrect dive planning information.*

⚠ WARNING: *Using a dive planner software is not a substitute for proper dive training. Diving with mixed gases has dangers that are not familiar to divers diving with air. To dive with Trimix, Heliox and Nitrox or all of them, divers must have specialized training for the type of diving they are doing.*

⚠ WARNING: *Do not use Suunto USB Cable in areas where flammable gases are present. Doing so may cause an explosion.*

 **WARNING:** Do not disassemble or remodel Suunto USB Cable in any way. Doing so may cause an electric shock or fire.

 **WARNING:** Do not use Suunto USB cable if cable or parts are damaged.

 **WARNING:** You must only charge your device using USB adapters that comply with the IEC 62368-1 standard and have a maximum output of 5 V. Non-compliant adapters are a fire hazard and a risk to personal injury and might damage your Suunto device.

 **CAUTION:** DO NOT allow the connector pins of the USB cable to touch any conductive surface. This may short circuit the cable, making it unusable.

Emergency ascents

In the unlikely event that the dive computer malfunctions during a dive, follow the emergency procedures provided by your certified dive training agency to immediately and safely ascend.

3. Getting started

3.1. Device setup

To get the most out of your Suunto EON Core, use some time to customize features and displays. Make absolutely sure that you know your computer and have it set up as you want before getting into the water.

To get started:

1. Wake up the device by connecting the USB cable to a PC/Mac.

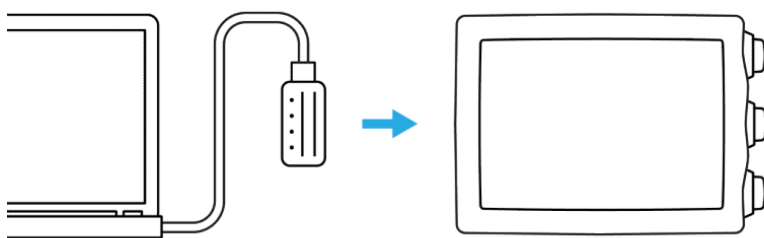

2. Follow the startup wizard to set up the device. When ready, the device goes to surface state.

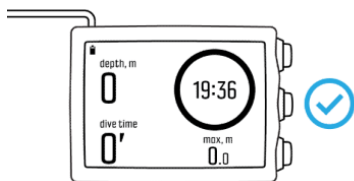

3. Fully charge before first dive.

The startup wizard guides you through:

- Language
- Units
- Time format (12h/24h)
- Date format (dd.mm / mm/dd)
- Connecting to Suunto app (recommended)

3.2. Display - modes, views, and states

Your Suunto EON Core has three buttons that have different functions in different views. Short pressing or long pressing them gets you to different functionalities.



By default, Suunto EON Core has two main dive **modes**: **Air/Nitrox** and **Gauge**.

Press and hold the middle button to enter **Main menu** and select the appropriate mode for your dive under **Dive settings » Mode**.

Suunto EON Core automatically restarts to change mode.

Suunto EON Core has two main **views**: time/no deco and compass. Change the main view by pressing the middle button. More views are available through customization in Suunto app.

For more detailed information on the views available in the different modes, see 4.16. *Dive modes*.

Suunto EON Core automatically switches between surface and dive **state**. If you are more than 1.2 m (4 ft) below the water level and the water contact is on, the dive state is activated.

When tank pressure screen is in use, you see the following information:









- Present depth is 19.0 m
- Dive time is 22 minutes
- Tank pressure left is 125 bar
- No decompression time is 50 minutes
- Safety stop is ahead at 3.0 meters
- 16 hours of diving time left before need to recharge
- Temperature is 21 °C

The switch window in the bottom right corner can contain different types of information that can be changed by short pressing the lower button.

3.3. Icons

Suunto EON Core uses the following icons:

| | |
|---|---|
|  | No-fly time |
|  | Surface (interval) time |
|  | Battery status (for device: charging, ok, low; for Tank POD: ok, low) |

| | |
|---|--|
|  | Battery level - number indicates remaining diving time before need to recharge |
|  | Tank / gas pressure information |
|  | Bluetooth |

3.4. Product compatibility

Suunto EON Core can be used together with Suunto Tank POD for wireless transmission of tank pressure to the dive computer. One or more Tank PODs can be paired with the dive computer for multi-gas diving.

You can pair your dive computer with the Suunto app over Bluetooth. You can transfer your dive logs to Suunto app from the dive computer and analyze them on your mobile phone. It is also possible to customize dive modes and change dive computer settings via Suunto app.

You may also connect this dive computer to a PC or Mac with the supplied USB cable to update the dive computer software with SuuntoLink.

With the optional bungee adapter kit for Suunto EON Core, you can replace the default strap with a bungee cord if desired.

Do not use this dive computer with any unauthorized accessories or attempt to connect wirelessly with mobile apps or equipment not authorized or officially supported by Suunto.



4. Features

4.1. Alarms, warnings, and notifications

Suunto EON Core has color-coded alarms, warnings and notifications. They are shown prominently on the display with an audible alarm (if tones are on). Alarms are always red. Warnings may be red or yellow. Notifications are always yellow.

When an alarm, warning, or notification occurs, a message is displayed as a pop-up. Pop-up messages can be acknowledged by pressing any button. The information needing attention remains on screen or as a scrollable element in the bottom field until the situation is back to normal.

Alarms are critical events that always require immediate action. When an alarm situation comes back to normal, the alarm will stop automatically.

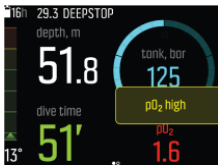
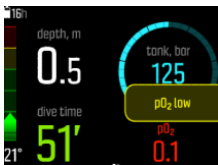
| Alarm | Explanation |
|---|---|
|  | Ascent speed exceeds safe speed of 10 m (33 ft) per minute for five seconds or more. |
|  | Decompression ceiling broken by more than 0.6 m (2 ft) on a decompression dive. Immediately descend back below ceiling depth and continue to ascend normally. |
|  | Partial pressure of oxygen exceeds safe level (>1.6). Immediately ascend or change to a gas with lower oxygen percentage. |
|  | Partial pressure of oxygen below safe level (<0.18). Immediately descend or change to a gas with higher oxygen percentage. |

Warnings alert you to events that can impact your health and safety if you do not take action. Acknowledge the warning by pressing any button.

| Warning | Explanation |
|-----------------|--|
| CNS 100% | Central Nervous System (CNS) Oxygen Toxicity level at 100% limit |
| OTU 300 | Recommended daily limit for Oxygen Tolerance Unit/Oxygen Toxicity Unit (OTU) reached |
| Depth | Depth exceeds your depth alarm limit |

| Warning | Explanation |
|---|--|
| Dive time | Dive time exceeds your dive time alarm limit |
| Diluent high pO₂ | Diluent partial pressure of oxygen exceeds safe level (>1.6); no immediate danger unless diluent is used, e.g. diluent flush |
| Diluent low pO₂ | Diluent partial pressure of oxygen below safe level (<0.18); no immediate danger unless diluent is used, e.g. diluent flush |
| Gas time | Gas time exceeds your gas time alarm limit, or tank pressure is below 35 bar (~510psi), in which case gas time is zero. |
| Safety stop broken | Safety stop ceiling broken by more than 0.6 m (2 ft) |
| Tank pressure  | Tank pressure is below your tank pressure alarm limit. There is a built in 50-bar alarm that cannot be changed. In addition to it there is a configurable tank pressure alarm, you can set to any value and your dive computer also shows an alarm when that value and 50 bar pressures are reached. The tank pressure number is forced onto the display and turns yellow after the value you set and red after 50 bars. |

Notifications indicate events that require preventive actions. Acknowledge the notification by pressing any button.

| Notification | Explanation |
|--------------------------|--|
| CNS 80% | Central Nervous System (CNS) Oxygen Toxicity level at 80% limit |
| OTU 250 | Approximately 80% of recommended daily limit for Oxygen Tolerance Unit/Oxygen Toxicity Unit (OTU) reached |
| Change gas | On multi-gas dive when ascending, it is safe to switch to next available gas for optimum decompression profile |
| Battery low | Approximately three hours of dive time left |
| Recharge needed | Approximately two hours of battery time left; re-charging required before next dive |
| Setpoint switched | Setpoint switched automatically on rebreather dive. See 4.27.3. <i>Setpoints.</i> |

4.2. Algorithm lock

Breaking the decompression ceiling

When you ascend above the ceiling by more than 0.6 m (2 ft), the ceiling parameter turns red, a red arrow pointing down appears, and an audio alarm is generated.



In such event, you should descend below the ceiling level to continue the decompression. If you fail to do so within three (3) minutes, Suunto EON Core locks the algorithm calculation and displays **Locked** instead, as shown below. Note that the ceiling value is no longer present.

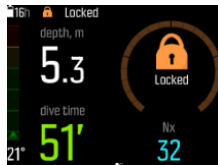

Algorithm locked

Suunto Fused™ RGBM 2 algorithm is locked for 48 hours if you omit decompression stops for longer than three (3) minutes. When the algorithm is locked, no algorithm information is available and **Locked** is shown instead. Locking the algorithm is a safety feature, highlighting that the algorithm information is no longer valid.

In this state, you significantly increase your risk of decompression sickness (DCS). Decompression information is not available for the next 48 hours after surfacing.

It is possible to dive with the device when the algorithm is locked, but instead of the decompression information, **Locked** is shown. Diving while the algorithm is locked resets the algorithm lock time back to 48 hours when you surface.

4.3. Altitude diving

The Altitude setting automatically adjusts the decompression calculation according to the given altitude range. You can find the setting under **Dive settings » Parameters » Altitude** and select from three ranges:

- 0 – 300 m (0 – 980 ft) (default)
- 300 – 1500 m (980 – 4900 ft)
- 1500 – 3000 m (4900 – 9800 ft)

As a result, the allowed no decompression stop limits are considerably reduced.

The atmospheric pressure is lower at high altitudes than at sea level. After traveling to a higher altitude, you will have additional nitrogen in your body, compared to the equilibrium situation at the original altitude. This 'additional' nitrogen is released gradually over time and equilibrium is restored. Suunto recommends that you acclimatize to a new altitude by waiting at least three hours before making a dive.

Before high-altitude diving, you need to adjust the altitude settings of your dive computer so that the calculations take into account the high altitude. The maximum partial pressures of nitrogen allowed by the mathematical model of the dive computer are reduced according to the lower ambient pressure.

⚠ WARNING: *Traveling to a higher elevation can temporarily cause a change in the equilibrium of dissolved nitrogen in the body. Suunto recommends that you acclimatize to the new altitude before diving. It is also important that you do not travel to a significantly high altitude directly after diving to minimize the risk of DCS.*

⚠ WARNING: *SET THE CORRECT ALTITUDE SETTING! When diving at altitudes greater than 300 m (980 ft), the altitude setting must be correctly selected in order for the computer to calculate the decompression status. The dive computer is not intended for use at altitudes greater than 3000 m (9800 ft). Failure to select the correct altitude setting or diving above the maximum altitude limit will result in erroneous dive and planning data.*

📝 NOTE: *If you are doing repetitive dives at an altitude other than the previous dive altitude, change altitude setting to correspond to the next dive after the previous dive ended. This ensures more accurate tissue calculations.*

4.4. Ascent rate

During a dive, the bar on the left indicates ascent rate. One bar step corresponds to 2 m (6.6 ft) per minute.

The bar is also color coded:

- **Green** indicates ascent rate is ok, less than 8 m (26 ft) per minute
- **Yellow** indicates ascent rate is moderately high, 8-10 m (26-33 ft) per minute
- **Red** indicates ascent rate is too high, over 10 m (33 ft) per minute

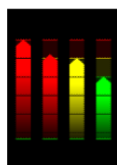

When maximum allowed ascent rate is exceeded for five seconds, an alarm is generated. Ascent rate violations result in longer safety stop times and mandatory safety stops.



⚠ WARNING: *DO NOT EXCEED THE MAXIMUM ASCENT RATE! Rapid ascents increase the risk of injury. You should always make the mandatory and recommended safety stops after you have exceeded the maximum recommended ascent rate. If this mandatory safety stop is not completed the decompression model will penalize your next dive(s).*

4.5. Battery

Suunto EON Core has a rechargeable lithium-ion battery. Charge the battery by connecting Suunto EON Core to a power source with the included USB cable. As a power source use your computer USB port.

The battery icon in the upper-left corner of the display shows the battery status. To the right of the battery icon is the estimated remaining dive time in hours.

| Icon | Explanation |
|---|--|
|  | Estimated remaining dive time is 16 hours; no immediate need to recharge |

| Icon | Explanation |
|---|--|
|  | Estimated remaining dive time is three (3) hours or less; recharge needed |
|  | Estimated remaining dive time is less than one (1) hour; recharge immediately. When the charge level drops below two (2) hours, you cannot start a dive with Suunto EON Core. |
|  | Battery is charging, showing current charge level as remaining dive time |

A pop-up message indicates when recharge is needed.

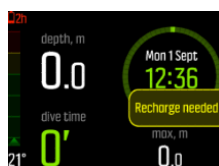

4.6. Bookmark

Adding a bookmark (timestamp) to an active log is really easy in Suunto EON Core. See 5.9. *How to add bookmarks* for the procedure.

4.7. Clock

Suunto EON Core's time and date settings are found under **Device settings**.

Time and date formats are found under **Units & formats**. For setting, see 5.4. *How to set time and date*.

4.8. Compass

Suunto EON Core includes a tilt-compensated digital compass, available as a main view.



4.8.1. Calibrating compass

When you first start using Suunto EON Core, and after each charging, the compass needs to be calibrated and it is required to do so to activate it. Suunto EON Core displays the calibration icon when you enter the compass view.

During the calibration process, the compass adjusts itself to the surrounding magnetic field.

Because of changes in the surrounding magnetic field, it is recommended to re-calibrate the compass before each dive.

To manually start calibration:

1. Take off your Suunto EON Core.
2. Keep the middle button pressed to enter the menu.

3. Browse to **General** » **Compass**.
4. Press the middle button to enter **Compass**.
5. Scroll up or down to select **Calibrate**.
6. Start calibrating the device by trying to move it around the xyz axes of the coordinate system (like you were drawing a small circle) so that the magnetic field is as stable as possible during the calibration. To achieve this, try to keep Suunto EON Core in the same location and do not move it around using large movements.
7. Repeat the rotation until the compass calibration is successful.

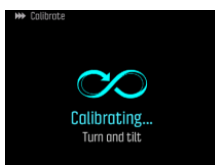

8. A sound indicates when the calibration succeeded, and the screen goes back to **Compass** menu.

 **NOTE:** If the calibration fails several times in a row, you may be in an area with strong sources of magnetism, such as large metal objects. Move to another location and try to calibrate the compass again.

4.8.2. Setting declination

You should always adjust your compass declination for the area where you are diving to get accurate heading readings. Check the local declination from a trusted source and set the value in Suunto EON Core.

To set declination:

1. Keep the middle button pressed to enter the menu.
2. Browse to **General** » **Compass**.
3. Press the middle button to enter **Compass**.
4. Press the middle button again to enter **Declination**.
5. Scroll up/down to set the angle of declination: Starting from 0.0° scroll up towards East or down towards West declination. To turn declination off, set declination angle to 0.0°.
6. Press middle button to save changes and go back to the **Compass** menu.
7. Keep the middle button pressed to exit.

4.8.3. Locking the bearing

A bearing is the angle between north and your target. In simple terms, it is the direction you want to travel. Your heading, on the other hand, is your actual direction of travel.

You can set a bearing lock to help you orientate yourself underwater and ensure you maintain your direction of travel. For example, you can set a bearing lock for the direction to the reef before leaving the boat.

You can reset the bearing lock at any time, but you can only clear a bearing lock while at the surface.

To set a bearing lock:

1. Press the middle button to change to the compass view.

2. Hold your Suunto EON Core in level in front of you, with the top pointing in the direction to your target.
3. Keep the lower button pressed until you see the **Bearing locked** notification.

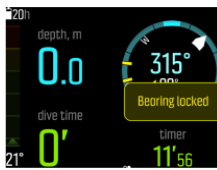

Once you have a bearing locked, the lock position is indicated on the compass rose, as shown below.



Below your heading (large number in center of compass), you also see the relative difference between your bearing and your heading. So, for instance, when you want to travel in the exact direction of your bearing, the lower number should be 0°.

If you want to set a new bearing lock, just repeat the same procedure above. Each bearing lock is recorded in your dive log with a time stamp.

To clear the bearing lock from your compass view, you need to return to the surface.

To clear a bearing lock:

1. While in surface state, keep the middle button pressed to enter the main menu.
2. Scroll to **General** with the upper or lower buttons and press the middle button.
3. Press the middle button to enter **Compass**.
4. Select **Clear bearing** with the middle button.
5. Keep the middle button pressed to step back to dive screen.

4.9. Customizing dive modes with Suunto app

You can easily customize device and dive settings, such as dive modes and views with Suunto app. Create up to 10 different dive modes with up to four custom views each. You can customize the following:

- Dive mode name
- Settings (e.g., personal setting, views, gases)

See 5.7. *How to customize dive modes with Suunto app* for more information.

4.10. Decompression algorithm

Suunto's decompression model development originates from the 1980s when Suunto implemented Bühlmann's model based on M-values in Suunto SME. Since then research and development has been ongoing with the help of both external and internal experts.

In the late 1990s, Suunto implemented Dr. Bruce Wienke's RGBM (Reduced Gradient Bubble Model) to work with the earlier M-value based model. The first commercial products with the feature were the iconic Suunto Vyper and Suunto Stinger. With these products the

improvement of diver safety was significant as they addressed a number of diving circumstances outside the range of dissolved-gas-only models by:

- Monitoring continuous multiday diving
- Computing closely spaced repetitive diving
- Reacting to a dive deeper than the previous dive
- Adapting to rapid ascents which produce high microbubble (silent-bubble) build-up
- Incorporating consistency with real physical laws for gas kinetics

The Suunto Fused™ RGBM 2 combines and improves widely respected Suunto RGBM and Suunto Fused™ RGBM decompression models developed by Suunto together with Dr. Bruce Wienke. (Suunto dive algorithms are a culmination of expertise and knowledge accumulated over decades of development, testing and thousands upon thousands of dives.)

In Suunto Fused™ RGBM 2 the tissue half-times are derived from Wienke's FullRGBM where human body is modeled by fifteen different tissue groups. FullRGBM can utilize these additional tissues and model the on-gassing and off-gassing more accurately. The amounts of nitrogen and helium on-gassing and off-gassing in the tissues are calculated independently from each other.

The Fused™ RGBM 2 supports open-circuit and closed-circuit diving up to a depth of 150 meters. Compared to previous algorithms, Fused™ RGBM 2 is less conservative on deep air dives, allowing shorter ascent times. In addition, the algorithm no longer requires tissues to be completely free of residual gases when calculating no-fly times, thereby reducing the required time between your last dive and flying.

The advantage of Suunto Fused™ RGBM 2 is additional safety through its ability to adapt to a wide variety of situations. For recreational divers it may offer slightly longer no-deco times, depending on the chosen personal setting. For open-circuit technical divers it allows use of gas mixes with helium - on deeper and longer dives helium based gas mixes provide shorter ascent times. And finally, for rebreather divers the Suunto Fused™ RGBM 2 algorithm gives the perfect tool to be used as a non-monitoring, set point dive computer.



NOTE: *Suunto EON Core software version earlier than 2.0 has Suunto Fused RGBM algorithm. When you update the device, the software will update the dive algorithm to latest version.*

4.10.1. Diver safety

Because any decompression model is purely theoretical and does not monitor the actual body of a diver, no decompression model can guarantee the absence of DCS.

CAUTION: *Always use the same personal and altitude adjustment settings for the actual dive and for the planning. Increasing the personal adjustment setting from the planned setting as well as increasing the altitude adjustment setting can lead to longer decompression times deeper and thus to larger required gas volume. You can run out of breathing gas underwater if the personal adjustment setting has been changed after dive planning.*

4.10.2. Oxygen exposure

The oxygen exposure calculations are based on currently accepted exposure time limit tables and principles. In addition to this, the dive computer uses several methods to conservatively estimate the oxygen exposure. For example:

- The displayed oxygen exposure calculations are raised to the next higher percentage value.
- The CNS% limits up to 1.6 bar (23.2 psi) are based on 1991 NOAA Diving Manual limits.
- The OTU monitoring is based on the long-term daily tolerance level and the recovery rate is reduced.

Oxygen related information displayed by the dive computer is also designed to ensure that all warnings and displays occur at the appropriate phases of a dive. For example, the following information is provided before and during a dive when the computer is set to Air/Nitrox or Trimix (if helium is activated in use):

- The selected O₂% (and possible helium %)
- CNS% and OTU (visible only after your customization in Suunto app)
- Audible notification when CNS% reaches 80%, then warning when 100% limit is exceeded
- Notification when OTU reaches 250 and then warning when 300 limit is exceeded
- Audible alarm when pO₂ value exceeds the preset limit (pO₂ high alarm)
- Audible alarm when pO₂ value is < 0.18 (pO₂ low alarm)

⚠ WARNING: WHEN THE OXYGEN LIMIT FRACTION INDICATES THAT THE MAXIMUM LIMIT IS REACHED, YOU MUST IMMEDIATELY TAKE ACTION TO REDUCE OXYGEN EXPOSURE. Failure to take action to reduce oxygen exposure after a CNS%/OTU warning is given can rapidly increase the risk of oxygen toxicity, injury, or death.

4.11. Decompression dives

When on a decompression (deco) dive you exceed the no decompression limit, Suunto EON Core provides the decompression information required for ascent. Ascent information is always presented with two values:

- **ceiling:** depth that you should not go above
- **asc. time:** optimum ascent time in minutes to surface with given gases

⚠ WARNING: NEVER ASCEND ABOVE THE CEILING! You must not ascend above the ceiling during your decompression. In order to avoid doing so by accident, you should stay somewhat below the ceiling.

On a decompression dive, there can be three kinds of stops:

- **Safety stop:** this is a recommended three-minute stop for every dive over 10 meters (33 ft).
- **Deepstop:** this is a recommended stop when you dive deeper than 20 m (66 ft).
- **Decompression stop:** this is a compulsory stop on your decompression dive that is for your safety, preventing decompression sickness.

In **Dive settings » Parameters**, you can

- turn deepstop on or off (it is on by default)
- adjust the safety stop time to be 3, 4 or 5 minutes (default is 3 minutes)
- set last stop depth to 3.0 m or 6.0 m (default is 3.0 m)

The following illustration shows a decompression dive where the ceiling is at 17.7 m (58 ft):

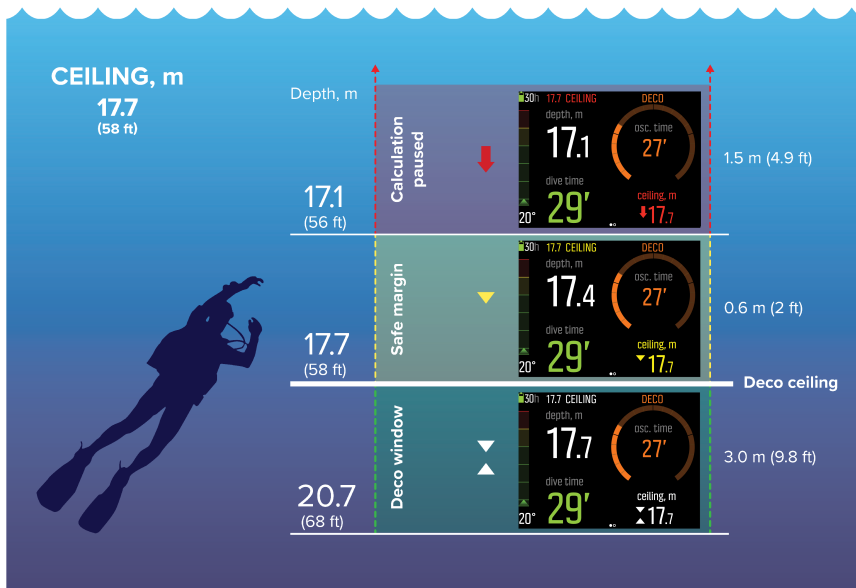

From bottom to top you see the following in the above image:

1. There is a decompression window (*Deco window*) that is the distance between the decompression ceiling (*Deco ceiling*) plus 3.0 m (9.8 ft) and the decompression ceiling. So the deco window in this example is between 20.7 m (68 ft) and 17.7 m (58 ft). This is the area where decompression takes place. The closer to the ceiling you stay, the more optimal the decompression time is.

When you ascend close to the ceiling depth and enter the deco window area, two arrows appear in front of the ceiling depth value. The downward and upward pointing white arrows indicate that you are within the deco window.

2. If you ascend above the ceiling depth, there is still a safe margin area, equaling to ceiling depth minus 0.6 m (2 ft). So in this example, it is between 17.7 m (58 ft) and 17.1 m (56 ft). In this safe margin area, decompression calculation still continues, but you are advised to go down below the ceiling depth. This is indicated by the ceiling depth number turning yellow with a downward pointing yellow arrow in front of it.
3. If you go above the safe margin area, the decompression calculation is paused until you go back down below this limit. An audible alarm and a downward pointing red arrow in front of the ceiling depth value indicate unsafe decompression.

If you ignore the alarm and stay above the safe margin for three minutes, Suunto EON Core locks the algorithm calculation, and decompression information will not be available anymore on the dive. See 4.2. *Algorithm lock*.

Decompression display examples

Suunto EON Core shows the ceiling value always from the deepest of these stops.

Below is a typical decompression dive view showing ascent time and the first recommended deepstop at 20.3 meters:



Below is an example of what Suunto EON Core displays during an optional deepstop:



Below is an example of what Suunto EON Core displays during a compulsory stop:



 **NOTE:** *If the ceiling is broken for more than 3 minutes, the decompression algorithm gets locked.*

With decompression stops, in the continuous ascent mode the ceiling is constantly decreasing while you are near the ceiling depth, providing continuous decompression with optimum ascent time. While in the stepped ascent mode, the ceiling is the same for a specific time and then moves upwards 3 m (9.8 ft) at a time.

 **NOTE:** *It is always recommended to keep close to the decompression ceiling when ascending.*

Ascent time is always the minimum time needed to reach the surface. It includes:

- Time required for deepstops
- Ascent time from depth at 10 m (33 ft) per minute
- Time needed for decompression

 **WARNING:** *When diving with multiple gases, remember that the ascent time is always calculated with the assumption that you use all the gases found in the Gases menu. Always check that you have only the gases for your current planned dive defined before you dive. Remove the gases that are not available for the dive.*

 **WARNING:** *YOUR ACTUAL ASCENT TIME MAY BE LONGER THAN DISPLAYED BY THE DIVE COMPUTER! The ascent time will increase if you: (1) remain at depth, (2) ascend slower than 10 m/min (33 ft/min), (3) make your decompression stop deeper than at the ceiling, and/or (4) forget to change the used gas mixture. These factors might also increase the amount of breathing gas required to reach the surface.*

4.11.1. Last stop depth

You can adjust the last stop depth for decompression dives under **Dive settings » Parameters » Last stop depth**. There are two options: 3 m and 6 m (9.8 ft and 19.6 ft).

By default, the last stop depth is 3 m (9.8 ft). This is the recommended last stop depth.

 **NOTE:** This setting does not affect the ceiling depth on a decompression dive. The last ceiling depth is always 3 m (9.8 ft).

 **TIP:** Consider setting the last stop depth to 6 m (19.6 ft) when you dive in rough sea conditions and stopping at 3 m (9.8 ft) is challenging.

4.12. Deco profile

Deco profile can be selected in **Dive settings » Parameters » Deco profile**.

Continuous decompression profile

Traditionally, since Haldane's 1908 tables, decompression stops have always been deployed in fixed steps such as 15 m, 12 m, 9 m, 6 m and 3 m. This practical method was introduced before the advent of dive computers. However, when ascending, a diver actually decompresses in a series of more gradual ministeps, effectively creating a smooth decompression curve.

The advent of microprocessors has allowed Suunto to more accurately model the actual decompression behavior. A continuous decompression curve is included in the Suunto Fused™ RGBM 2's working assumption.

During any ascent involving decompression stops, Suunto dive computers calculate the point at which the control compartment crosses the ambient pressure line (that is the point at which the tissue's pressure is greater than the ambient pressure), and off-gassing starts. This is referred to as the decompression floor. Above this floor depth and below the ceiling depth is the decompression window. The range of the decompression window is dependent on the dive profile.

Off-gassing in the leading fast tissues will be slow at or near the floor because the outward gradient is small. Slower tissues may be still on-gassing and given enough time, the decompression obligation may increase, in which case the ceiling may move down and the floor may move up.

Suunto RGBMs optimize these two contradictory issues through a combination of a slow ascent rate and continuous decompression curve. It all comes down to proper control of the expanding gas during an ascent. This is why all Suunto RGBMs use a maximum ascent rate at 10 m/minute, which has proven over the years to be an effective protective measure.

The decompression floor represents the point at which the Suunto RGBM is seeking to maximize bubble compression, while the decompression ceiling is maximizing off-gassing.

The added advantage of having a decompression ceiling and floor is that it recognizes that in rough water, it might be difficult to maintain the exact depth to optimize decompression. By maintaining a depth below the ceiling but above the floor, the diver is still decompressing, although slower than optimal, and provides an additional buffer to minimize the risk that waves will lift the diver above the ceiling. Also, the continuous decompression curve used by Suunto provides a much smoother and a more natural decompression profile than the traditional "step" decompression.

Suunto EON Core has a feature of displaying the decompression ceiling. The optimal decompression occurs in the decompression window, which is displayed by both upward and downward arrows. If the ceiling depth is violated, a downward pointing arrow and an audible alarm will prompt the diver to descend back to the decompression window.

Stepped decompression profile

In this decompression profile the ascent has divided into traditional 3 m (10 ft) steps or stages. In this model diver will decompress at traditional fixed depths.

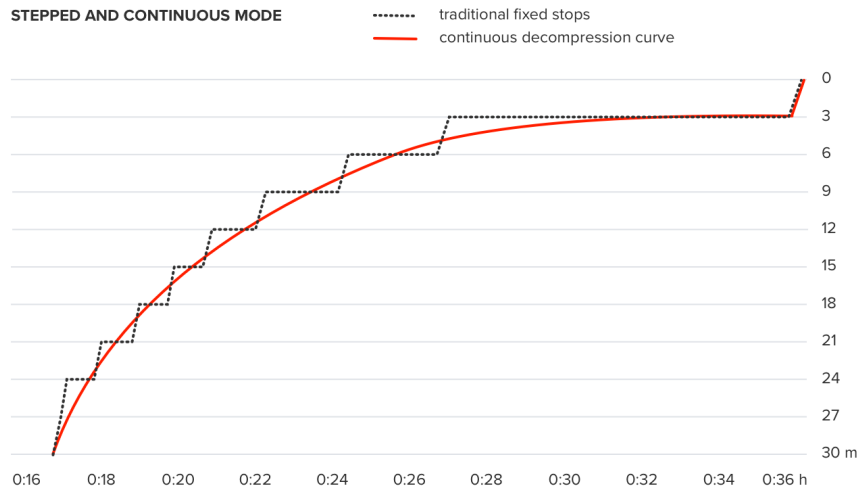

*The graph is an example of a typical decompression dive profile. Several variables affect decompression calculations.

 **NOTE:** Decompression profile selection is available starting from firmware version 2.0.

4.13. Device info

Information about your Suunto EON Core can be found in your device. This information includes device name, serial number, software and hardware versions and radio compliance information. See 5.1. *How to access device info.*

4.14. Display

Display LED backlight is always on when the device is active. It cannot be turned off, but you can turn the display brightness down to extend battery life significantly.

For display brightness adjustment, see 5.2. *How to change display brightness.*

4.15. Dive history

Dive history is a summary of all the dives done with your Suunto EON Core. The history is divided according to the dive type used for the dive. Each dive type summary includes the number of dives, cumulative dive hours and maximum depth. Enter History under **General** »

About EON:





 **NOTE:** If there is more history information available than can be shown in a single screen, you can scroll through the additional information with the upper and lower buttons.

4.16. Dive modes

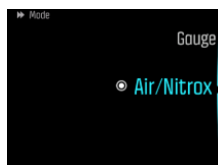
By default, Suunto EON Core has two dive modes: Air/Nitrox and Gauge (bottom timer). Select the appropriate mode for your dive under **Dive settings » Mode**.



 **NOTE:** Suunto EON Core shows all dive mode names in English. You can change dive mode names via Suunto app.

 **NOTE:** The default dive modes use prominent style. You can change the style and other settings, as well as create additional dive modes using the Suunto app.

In Suunto app you can create new or edit existing dive modes, modify screen layouts, change helium and multi-gas settings, and change dive type (OC/CC). You can activate CCR (closed circuit rebreather) dive support in Suunto app.

The decompression algorithm used in Suunto EON Core is Suunto Fused™ RGBM 2. For more information about the algorithm, see 4.10. *Decompression algorithm*.

4.16.1. Air/Nitrox mode

By default, Air/Nitrox mode is for diving with regular air and diving with oxygen enriched gas mixtures.

Diving with nitrox gas mixture allows you to increase bottom times or reduce the risk of decompression illness. Suunto EON Core provides you with information to adjust your dive and stay within safe limits.

When diving with nitrox gas mixture, both the percentage of oxygen in your tank and the oxygen partial pressure limit must be entered into Suunto EON Core. This ensures correct nitrogen and oxygen calculations and the correct maximum operating depth (MOD), which is based on your entered values. The default oxygen percentage (O₂%) setting is 21% (air) and oxygen partial pressure (pO₂) setting is 1.6 bar (23 psi).

 **NOTE:** When diving with a nitrox gas mixture, Suunto recommends changing the partial pressure to 1.4 bar (20 psi).

Air/Nitrox mode has two views by default:

- No deco



- Compass



After customizing in Suunto app, two other views are available:

- Tank Pressure - For more information on what is shown on the display, see 4.34. *Tank pressure* .



- Timer



 **NOTE:** Air/Nitrox dive mode has one active gas by default. You can edit this gas in the device menu where O₂ percentage and pO₂ value can be changed. To enable diving with more than one gas, you need to activate multigas diving under **Dive settings » Parameters » Multiple gases**. After this step you are able to add further gases in the **Gases** menu. Gas settings can also be customized in Suunto app.

4.16.2. Gauge mode

Use Suunto EON Core as a bottom timer with **Gauge** mode.

The timer in the top right of the display shows dive time in minutes and seconds and can be activated and stopped by short pressing the upper button. Keep the upper button pressed to reset the timer.

Gauge mode is a bottom timer only. It does not use any decompression algorithm, thus it does not include decompression information or calculations.

Gauge mode has two views by default:

- Timer



- Compass



A third view is visible after customizing in Suunto app:

- Tank Pressure - For more information on what is shown on the display, see 4.34. *Tank pressure* .



 **NOTE:** After diving in Gauge mode, decompression calculation is locked for 48 hours. If during this time you dive again in Air/Nitrox mode, the dive algorithm and the decompression calculation will not be available and **Locked** will be shown on the screen

 **NOTE:** Locked time is set back to 48 hours if you start a new dive while your device is locked.

4.17. Dive planner

The dive planner in Suunto EON Core helps you to quickly plan your next dive. The planner displays available no decompression time and gas times for your dive based on depth, tank size and gas consumption set.

The dive planner can also help you plan dives in series, taking into account the residual nitrogen from your previous dive(s) based on the planned surface time you enter.

 **NOTE:** It is important to adjust tank size, tank pressure and personal gas consumption to get the gas calculations right.

See 5.6. *How to plan a dive using the Dive planner* for details on planning your dives.

4.18. Flip display

You can flip the display of Suunto EON Core to have the buttons on either the left or right side of the dive computer, making it easier to wear on either arm.

Change the button orientation under **General » Device settings » Flip display**.

Select **Buttons right** to have the buttons on the right-hand side or **Buttons left** to have them on the left-hand side.

4.19. Gas consumption

Gas consumption refers to your real-time consumption rate of gas during a dive. In other words, it is the amount of gas a diver would use in one minute on the surface. This is commonly known as your surface air consumption or SAC rate.

Gas consumption rate is measured in liters per minute (cubic feet per minute). This is an optional field and needs to be added to your custom dive mode views in Suunto app. In the classic view below, gas consumption rate is in the bottom right corner.

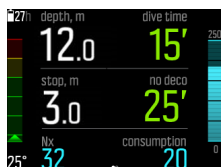

For enabling gas consumption metering, see 5.8. *How to enable gas consumption metering.*

4.20. Gas mixtures

By default, Suunto EON Core has only one gas (air). You can modify O₂ percentage and pO₂ settings in **Gases** menu.

If you need more than one gas, activate multi-gas option on the device menu under **Dive settings** » **Parameters**.

If you want to use trimix gas (with helium activated), you need to turn helium on under **Dive settings** » **Parameters**. When this is done, you can change helium percentage (He%) for selected gas in the **Gases** menu.

You can activate multi-gas diving and helium, configure dive modes and change gas settings using Suunto app, too.

 **NOTE:** *When you have analyzed your gas, you should round the result down when entering it for Suunto EON Core. For example, if the analyzed gas is 31.8% oxygen, then define the gas as 31%. This makes the decompression calculations more conservative. If you need to adjust the computer to provide more conservative calculations, use the personal adjustment feature to affect decompression calculations or reduce the pO₂ setting to affect oxygen exposure according to the entered O₂% and pO₂ values.*

 **WARNING:** *THE DIVE COMPUTER WILL NOT ACCEPT FRACTIONAL PERCENTAGE VALUES OF OXYGEN CONCENTRATION. DO NOT ROUND UP FRACTIONAL PERCENTAGES! Rounding up will cause nitrogen percentages to be understated and will affect decompression calculations.*

 **NOTE:** *You can customize what you see in the **Gases** menu using the Suunto app.*

It is important to understand how the **Gases** menu works when multiple gases and helium are activated. For example, you may have the following gases when diving to 55 m (180.5 ft):

- tx18/45, MOD 62.2 m (pO₂ 1.3)
- tx50/10, MOD 22 m (pO₂ 1.6)
- oxygen, MOD 6 m

In the screenshot below, the menu has three gases and tx18/45 is selected as the active gas. Even though only one gas is active, the decompression algorithm calculates ascent time (during dive) using all these three gases.

To select another active gas:

1. While in the **Gases** menu, press the middle button to see gas options.
2. Scroll with the upper or lower buttons to highlight Select.
3. Press the middle button again to confirm.

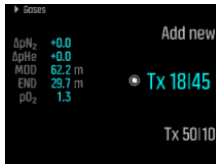

If you are diving with only one gas, ensure you have only that one gas in the **Gases** menu. Otherwise, Suunto EON Core expects you to use all gases in the list and notifies you to change gases during the dive.

4.21. Gas time

Gas time refers to remaining air (gas) left with current gas mixture, measured in minutes. The time is based on the tank pressure value and your current breathing rate.

Gas time is also highly dependent on your current depth. For example, all other factors being the same, including breathing rate, tank pressure and tank size, depth affects gas time as follows:

- At 10 m (33 ft, surrounding pressure 2 bar), gas time is 40 minutes.
- At 30 m (99 ft, surrounding pressure 4 bar), gas time is 20 minutes.
- At 70 m (230 ft, surrounding pressure 8 bar), gas time is 10 minutes.

Gas time information is not visible by default. After customization in Suunto app, the information will be visible in the bottom right corner of the screen. If you have not paired a Suunto Tank POD, the gas time field shows n/a. If you have paired a POD but there is no data being received, the field shows --. This may be because the POD is not in range, the tank is closed, or the POD battery is low.



 **NOTE:** It is important to adjust tank size, tank pressure and personal gas consumption to get the gas calculations right. Find these options under **Dive planner** in the device menu.

4.22. Language and unit system

You can change the device language and unit system any time when you are not diving. Suunto EON Core refreshes immediately to reflect the changes.

To set these values, see 5.3. *How to set language and unit.*

4.23. Logbook

Dive logs can be found under **Logs**. They are listed by date and time, and each entry listing shows the max. depth and dive time of the log.



Dive log details and profile can be browsed by scrolling through the logs with the upper or the lower button and selecting a log with the middle button.

Each dive log contains data samples with fixed 10-second intervals. The dive profile includes a cursor for browsing the logged data, scrollable with upper and lower buttons. A blue line indicates depth, and a white line shows temperature. If you dive with Tank POD, tank pressure and gas consumption graphs become also visible.

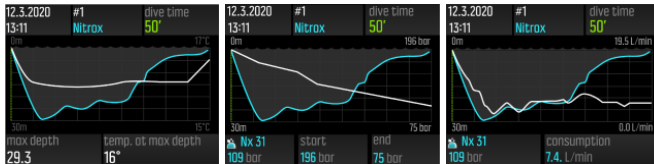

The last page of the logbook contains further data. Press the middle button to find average depth, CNS percentage, and OTU value.



For more detailed log analyses, upload the dive(s) to the Suunto app.

When the logbook memory gets full, the oldest dives are deleted to make space for new ones.



NOTE: If you surface and then dive again within five minutes, Suunto EON Core counts it as one dive.

4.24. Multi-gas diving

Suunto EON Core allows gas changes during a dive between the gases defined in the **Gases** menu. When ascending, you are always notified to change gases when a better gas is available.

For example, you may have the following gases when diving to 55 m (180.5 ft):

- tx18/45, MOD 62.2 m (pO₂ 1.3)
- tx50/10, MOD 22 m (pO₂ 1.6)
- oxygen, MOD 6 m

While ascending, you are notified to change gas at 22 m (72 ft) and 6 m (20 ft) according to the maximum operating depth (MOD) of the gas.

A pop-up notifies you when to change gases, as shown below:

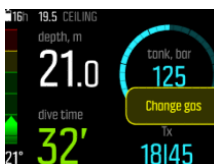

WARNING: When diving with multiple gases, remember that the ascent time is always calculated with the assumption that you use all the gases found in the **Gases** menu. Always check that you have only the gases for your current planned dive defined before you dive. Remove the gases that are not available for the dive.

4.24.1. Modifying gases during a dive

Modifying gases is for emergency cases only. For example, due to unforeseen events, you might lose a gas mixture, in which case you could adjust to the situation by deleting that gas mixture from the gas list of Suunto EON Core. This allows you to continue diving and get correct decompression information calculated by the dive computer.

In another case, if for some reason you run out of gas and need to use a gas mixture from a dive buddy, it is possible to adapt Suunto EON Core to the situation by adding the new gas mixture to the list. Suunto EON Core re-calculates decompression and shows the correct information.



NOTE: *This feature is not enabled by default, it must be activated and creates an additional step to the gas menu during the dive. It is only available if multiple gases are selected for the dive mode.*

To enable modifying gases, turn the feature on in the settings menu under **Dive settings » Parameters » Modify gases**.

When enabled, during a multi-gas dive, you can add a new gas as well as select an existing gas from the gas list to remove it.



NOTE: *You cannot modify or remove the gas currently in use (active gas).*

When **Modify gases** is turned on, you can remove gases which are not in use from the gas list, add new gases to the list, and modify parameters (O_2 , He, pO_2) of nonactive gases.

4.24.2. Isobaric counterdiffusion (ICD)

Isobaric counterdiffusion (ICD) occurs when different inert gases (such as nitrogen and helium) diffuse in different directions during a dive. In other words, one gas is being absorbed by the body while the other is being released. ICD is a risk when diving with trimix mixtures.

This may happen during a dive, for example, when trimix gas is switched to nitrox or light trimix. When the switch is made, helium and nitrogen rapidly diffuse in opposite directions. This produces a transient increase in total inert gas pressure which can lead to decompression sickness (DCS).

Currently there are no algorithms that can address ICD. Therefore, you need to take it into account when planning trimix dives.

You can use Suunto EON Core to plan your trimix usage safely. Under the **Gases** menu, you can adjust oxygen (O_2) and helium (He) percentages to see the change in partial pressure of nitrogen (ppN₂) and the partial pressure of helium (ppHe) values.

An increase in partial pressure is indicated by a positive number, and a decrease by a negative number. The changes in ppN₂ and ppHe are displayed next to each gas mixture that you want to switch to. Maximum operating depth (MOD) of a breathing gas is the depth at which the partial pressure of oxygen (pO_2) of the gas mix exceeds a safe limit. You can define pO_2 limit for the gas.

An ICD warning is generated when:

1. Gas switch depth is greater than 10 m (33 ft).
2. Geometric mean of the partial pressure change of N₂ and partial pressure change of He is bigger than 0.35 bar.

If these limits are exceeded with a gas switch, Suunto EON Core indicates the risk of ICD as shown below:



In this example, the available gas mixtures for a deep trimix dive are:

- Trimix 15/55, MOD 76.7 m (pO_2 1.3)
- Trimix 35/15, MOD 27.1 m (pO_2 1.3)
- Trimix 50/10, MOD 22 m (pO_2 1.6)
- Oxygen, MOD 6 m

Suunto EON Core highlights the dangerous ICD condition when the gas mixture switches from 15/55 to 35/15 at a depth of 27.1 m.

If this gas switch is made, the change in ppN_2 and $ppHe$ are far beyond the safe limits.

One way to avoid the ICD risk is to increase helium content in the first decompression gas mixture (trimix 35/15) to get a 35/32 trimix mixture. Due to this change, the second decompression gas (trimix 50/10) needs more helium to avoid ICD risk. The second decompression gas mixture should be trimix 50/12. These modifications would keep the changes in partial pressure at a safe level and remove the danger of sudden ICD.

4.25. Oxygen calculations

During a dive, Suunto EON Core calculates partial pressure of oxygen (pO_2), central nervous system toxicity (CNS%) and pulmonary oxygen toxicity, tracked by oxygen toxicity units (OTU). The oxygen calculations are based on currently accepted exposure time limit tables and principles.

By default in Air/Nitrox dive mode, CNS% and OTU values are not displayed until they reach 80% of their recommended limits. When either value reaches 80%, Suunto EON Core notifies you and the value stays in the view.



NOTE: You can customize views to always show CNS% and OTU.

4.26. Personal setting

Suunto Fused™ RGBM 2 algorithm provides 5 personal setting options (+2, +1, 0, -1, -2). These options refer to decompression models. +2 and +1 can be considered conservative, while -2 and -1 can be considered aggressive. 0 is the default setting and is neutral, for ideal conditions. Generally speaking, conservative means safer. In practice it means that a dive at a given depth is shorter due to the decompression obligation (the no decompression time is short).

Conservative also means that the time the diver needs to spend on decompression is longer. For recreational divers, a conservative model means less time in the water in order to avoid decompression requirements. For technical divers, however, conservative means more time in the water because of the longer decompression requirements imposed during ascent.

Aggressive models, on the other hand, increase the potential health risks of a dive. For recreational divers, an aggressive model allows more time at depth, but may significantly increase the risk of decompression sickness (DCS).

The default setting for the Suunto Fused™ RGBM and Fused™ RGBM 2 is to use a compromise (0 setting) between conservative and aggressive. With the personal setting, you can select gradually more conservative or more aggressive calculations.

There are several risk factors that can affect your susceptibility to DCS like your personal health and behavior. Such risk factors vary between divers, as well as from one day to another.

The personal risk factors which tend to increase the possibility of DCS include:

- exposure to low temperature – water temperature less than 20 °C (68 °F)
- below average physical fitness level
- age, particularly over the age of 50
- fatigue (from over exercising, lack of sleep, exhausting travel)
- dehydration (affects circulation and may slow down off-gassing)
- stress
- tight fitting equipment (may slow down off-gassing)
- obesity (BMI that is considered obese)
- patent foramen ovale (PFO)
- exercise before or after dive
- strenuous activity during a dive (increases bloodflow and brings additional gas to tissues)

⚠ WARNING: SET THE CORRECT PERSONAL SETTING! *Whenever it is believed that risk factors that tend to increase the possibility of DCS exist, it is recommended that you use this option to make the calculations more conservative. Failure to select the correct personal setting will result in erroneous dive and planning data.*

The five-step personal setting can be used to adjust the algorithm conservatism to fit your DCS susceptibility. You can find the setting under **Dive settings » Parameters » Personal**.

| Personal level | Explanation |
|------------------------|---|
| More aggressive (-2) | Ideal conditions, excellent physical fitness, highly experienced with a lot of dives in the near past |
| Aggressive (-1) | Ideal conditions, good physical fitness, well experienced with dives in the near past |
| Default (0) | Ideal conditions (default value) |
| Conservative (+1) | Some risk factors or conditions exist |
| More conservative (+2) | Several risk factors or conditions exist |

⚠ WARNING: *Personal adjustment setting 0, -1 or -2 causes a high risk of DCS, or other personal injury, and death.*

4.27. Rebreather diving

You can use Suunto EON Core for rebreather diving by customizing your device in Suunto app. Suunto recommends using classic or graphical style with rebreather diving. However, you can use prominent view and customize fields if desired.

Fixed setpoint calculation enables Suunto EON Core to be used as a backup dive computer on rebreather dives. It does not control or monitor the rebreather unit in any way.

When you select your custom multi-gas mode for CCR (closed-circuit rebreather) diving in the dive mode setting, your device will have two different gas menus: **CC gases** (closed-circuit gases) and **OC gases** (open-circuit gases).

 **NOTE:** For rebreather dives, Suunto EON Core should be used as a backup device only. The primary control and monitoring of your gases should be done through the rebreather itself.

4.27.1. Closed-circuit gases

On a rebreather dive, you need at minimum two closed-circuit gases: one is your pure oxygen tank, and the other is a diluent. You can define additional diluents as needed.

You can add only diluent(s) to the gas list. By default, Suunto EON Core assumes that oxygen is used, so it is not shown in the gas list.

The correct oxygen and helium percentages of the diluent gases in your diluent cylinder(s) must always be entered into the dive computer (or through Suunto app) to ensure correct tissue and oxygen calculation. Diluent gases used on a rebreather dive are found under **CC gases** in the main menu.

4.27.2. Open-circuit gases

As with diluents, you must always define the correct oxygen and helium percentages of bailout gases for all your cylinders (and additional gases) to ensure correct tissue and oxygen calculation. Bailout gases for a rebreather dive are defined under **OC gases** in the main menu.

4.27.3. Setpoints

Your custom rebreather dive mode has two setpoint values, low and high. Both are configurable:

- Low setpoint: 0.4 – 0.9 (default: 0.7)
- High setpoint: 1.0 – 1.5 (default: 1.3)

Typically, you do not need to modify the default setpoint values. However, you can change them as needed either in Suunto app or under the main menu.

To change setpoint values in Suunto EON Core:

1. While in surface state, keep middle button pressed to enter main menu.
2. Scroll to **Setpoint** with the upper button and select with the middle button.
3. Scroll to **Low setpoint** or **High setpoint** and select with the middle button.
4. Adjust the setpoint value with the lower or upper button and accept with the middle button.
5. Keep the middle button pressed to exit menu.

Setpoint switching

Setpoints can be switched automatically according to depth. By default, the low setpoint switch depth is 4.5 m (15 ft), and the high setpoint switch depth is 21 m (70 ft).

The auto setpoint switching is off by default for the low setpoint and on for the high setpoint.

To change auto setpoint switching in Suunto EON Core:

1. While in surface state, keep middle button pressed to enter main menu.
2. Scroll to **Setpoint** with the upper button and select with the middle button.
3. Scroll to **Switch low** or **Switch high** and select with the middle button.
4. Adjust the depth value for the setpoint switch with the lower or upper button and accept with the middle button.
5. Keep the middle button pressed to exit menu.

Popup notifications indicate when the setpoint is switched.

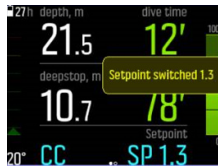

During a rebreather dive, you can also switch to a custom setpoint at any time.

To change to a custom setpoint:

1. While diving in a rebreather mode, keep the middle button pressed to enter main menu.
2. Scroll to **Custom setpoint** and select with the middle button.
3. Adjust the setpoint value as needed with the lower or upper button and accept with the middle button.

A popup notification confirms the custom setpoint switch.



 **NOTE:** When you change to a custom setpoint, the automatic setpoint switching is turned off for the remainder of the dive.

4.27.4. Bailouts

If at any point during a rebreather dive you suspect a malfunction of any sort, you should switch to a bailout gas and abort the dive.

To change to a bailout gas:

1. Keep the middle button pressed to enter the main menu.
2. Scroll to **OC gases** and select with the middle button.
3. Scroll to the desired bailout gas and select with the middle button.

After a bailout gas is selected, the setpoint field is replaced with the pO₂ value of the selected open-circuit gas.

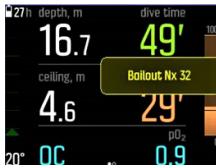

If the malfunction is rectified or the dive situation otherwise normalizes, you can switch back to a diluent using the same procedure as described above, but selecting from **CC gases**.

4.28. Safety stops and deepstops

Safety stop and deepstop ceilings are always at constant depth when you are at the stop. Safety stop and deepstop times are counted down in minutes and seconds.

Safety stop

There are two types of safety stops: voluntary and mandatory. Safety stop is mandatory if ascent speed violation happened during the dive. Mandatory safety stop is shown in red, while voluntary safety stop is indicated with yellow.

A three (3) minute safety stop is always recommended for every dive over 10 meters (33 ft).

The time for a safety stop is calculated when you are between 2.4 and 6 m (7.9 and 19.6 ft). This is presented with up/down arrows on the left side of the stop depth value. The safety stop time is shown in minutes and seconds. The time may exceed three (3) minutes if you ascend too fast during dive. If violations happened several times, the additional stop time is longer. Safety stops can be set to three (3), four (4), or five (5) minutes.

Voluntary safety stop is shown in yellow:

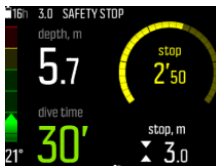

Mandatory safety stop is shown in red:



Deepstop

Deepstops activate only when you dive deeper than 20 m (66 ft). During ascend, deepstops activate when you are halfway up from your maximum depth. Deepstops are presented like safety stops. You are in the deepstop area when the deepstop depth has up/down arrows in front of it and deepstop time is running. The deepstop window is +/- 1.5 m (4.9 ft). Calculation starts at deepstop target depth plus 0.5 m (1.6 ft). Calculation ends - 3 m (- 9.8 ft) away from deepstop depth.

There can be more than one deepstop during ascend. For example, if you dive to 42 m (137.8 ft), the first deepstop is prompted at 21 m (68.9 ft) and the second is at 10.5 m (34.4 ft) The second deepstop is 2 minutes long.

In the following example the diver dives down to maximum 30.4 m (99.7 ft) and has a deepstop at 15.2 m (49.8 ft):

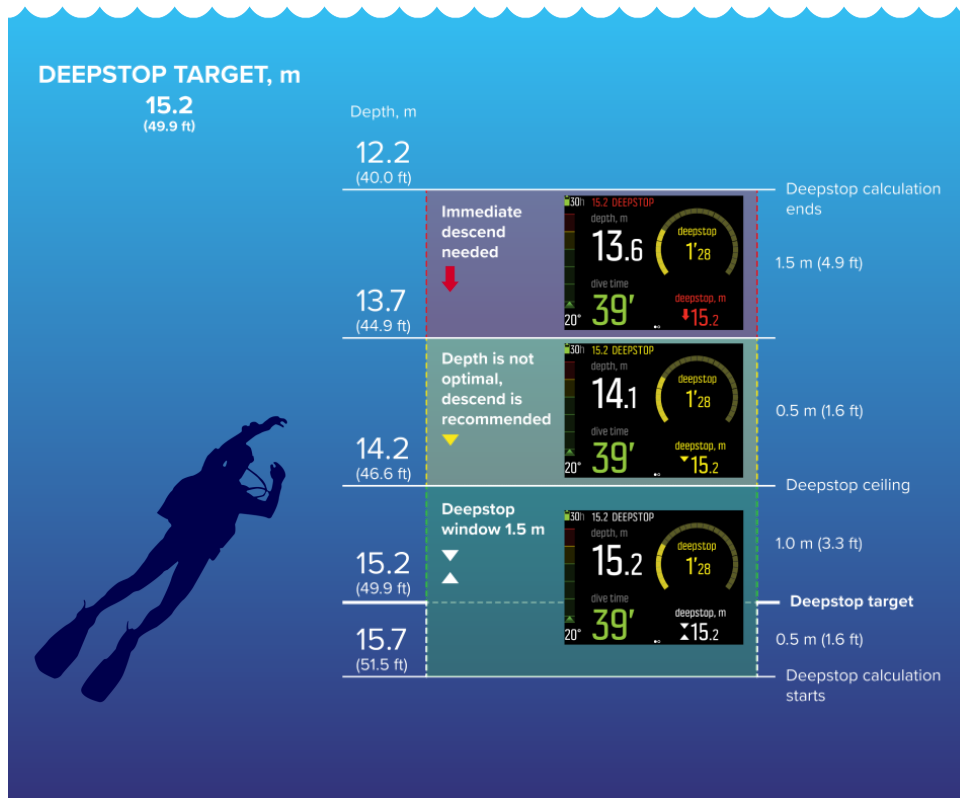

Below 20.0 m (66 ft), deepstop gets activated. In this case, as the diver ascends, the deepstop is necessary at halfway of the maximum depth, so at 15.2 m (49.8 ft).

If the deepstop depth is 15.2 m (49.8 ft), the calculation starts at 15.7 m (51.5 ft) and stops at 12.2 m (40.0 ft). The deepstop window is +/- 1.5 m (4.9 ft) and when the diver is within the deepstop window, it is indicated with two white arrows pointing at each other on the display.

When the diver ascends above the deepstop window ceiling - in this case above 14.2 m (46.5 ft) - a downward pointing yellow arrow signals that the depth is not optimal, it is recommended to descend. The deepstop target depth number also turns yellow.

If the diver keeps ascending, after 0.5 m (1.6 ft), a downward pointing red arrow and an alarm notify the diver to descend immediately. The deepstop calculation keeps running for another 1.5 m (4.9 ft) up but stops after that. In the above example it stops at 12.2 m (40.0 ft).

NOTE: For safety reasons, you cannot switch off deepstops if helium (trimix gas mixtures) is enabled for the dive mode in use. When helium is not in use, deepstops can be turned on and off. However, it is recommended that you turn deepstops on for all dives. If deepstops are turned on but omitted during a dive, it will affect your next dive which will be more conservative.

4.29. Sample rate

Suunto EON Core uses a fixed sample rate of 10 seconds for all log recordings.

4.30. Standby and deep sleep

Standby and deep sleep are two functions that are designed to prolong battery life. Standby is an adjustable setting that turns off the screen after a set amount of time to save battery if Suunto EON Core is not used.

To adjust the standby time:

1. Keep the middle button pressed to enter the menu.
2. Browse to **General** » **Device settings** » **Standby**.
3. Press the middle button to enter Standby.
4. Scroll up/down to select the desired standby time in minutes.
5. Press the middle button to save changes and return to the Device settings menu.
6. Keep the middle button pressed to exit.

Deep sleep

Deep sleep is a function that prolongs battery life when Suunto EON Core has not been used for some time. Deep sleep is activated when two days have passed since:

- No buttons have been pressed
- Dive calculation has ended

Suunto EON Core wakes up when it is connected to a PC/charger, when a button is pressed, or when the water contact gets wet.

4.31. Surface and no-fly time

After a dive, Suunto EON Core displays surface time since the previous dive and a countdown time for the recommended no-fly time. During the no-fly time you should avoid flying or traveling to higher altitude.



No-fly time is the minimum surface time after a dive which is recommended to wait before flying with an airplane. It is always at least 12 hours. For desaturation times shorter than 75 minutes, no-fly time is not displayed. Maximum no-fly time is 72 hours.

If decompression is omitted during a dive and the dive algorithm is locked for 48 hours (see 4.2. *Algorithm lock*), the no-fly time is always 48 hours. Similarly, if dive is done in gauge mode (bottom timer), the no-fly time is 48 hours.

With Suunto Fused™ RGBM 2, selected personal setting parameter (-2, -1, 0, +1, +2) is affecting no-fly time. The more conservative personal setting you have, the longer no-fly time values you will see. More aggressive personal setting will result in shorter no-fly time values.

Once the no-fly time calculated by your Suunto EON Core with Suunto Fused™ RGBM 2 has ended, you can enter and fly with a normal airplane which is pressurized up to 3000 m.

 **WARNING:** YOU ARE ADVISED TO AVOID FLYING ANY TIME THE COMPUTER COUNTS DOWN THE NO-FLY TIME. ALWAYS ACTIVATE THE COMPUTER TO CHECK THE REMAINING NO-FLY TIME PRIOR TO FLYING! Flying or traveling to a higher altitude within the no-fly time can greatly increase the risk of DCS. Review the recommendations given by Divers Alert Network (DAN). There can never be a flying-after-diving rule that is guaranteed to completely prevent decompression sickness!

4.32. Suunto app

With the Suunto app, you can easily customize device and dive settings. See 4.9. *Customizing dive modes with Suunto app* and 5.7. *How to customize dive modes with Suunto app*.

You can also transfer your dive logs wirelessly to the app where you can follow and share your diving adventures.

To pair with Suunto app on iOS:

1. Download and install Suunto app on your compatible Apple device from the App Store. The app description includes the latest compatibility information.
2. Start Suunto app and turn on Bluetooth if it is not on already. Leave the app running in the foreground.
3. If you have not yet set up your Suunto EON Core, do so now (see 3.1. *Getting started*).
4. Tap the watch icon in the upper left corner of the screen and tap on the '+' icon to add a new device.
5. Select your dive computer from the list of found devices, tap [PAIR] .
6. Enter the passkey shown on your dive computer display into the pairing request field on your mobile device.
7. Tap [PAIR] at the bottom of the request field.

To pair with Suunto app on Android:

1. Download and install Suunto app on your compatible Android device from Google Play. The app description includes the latest compatibility information.
2. Start Suunto app and turn on Bluetooth if it is not on already. Leave the app running in the foreground.
3. If you have not yet set up your Suunto EON Core, do so now (see 3.1. *Getting started*).
4. Tap the watch icon in the upper right corner of the screen.
5. Select your dive computer from the list of found devices and tap [PAIR] .
6. Enter the passkey shown on your dive computer display into the pairing request field on your mobile device.
7. Tap [PAIR] at the bottom of the request field.

 **NOTE:** You cannot pair any device if airplane mode is on. Turn off airplane mode before pairing.

4.32.1. Synchronizing logs and settings

To be able to synchronize logs and settings, first you need to install Suunto app.

To download logs from your Suunto EON Core and sync settings:

1. Connect Suunto EON Core to your mobile device via Bluetooth.
2. Start Suunto app.

3. Wait for the syncing to complete.

New dive logs appear in your activity history, sorted by date and time.

4.33. SuuntoLink

Use SuuntoLink to update the software of your Suunto EON Core. Download and install SuuntoLink on your PC or Mac.

We strongly recommend updating your device when a new software release is available. If an update is available, you are notified via SuuntoLink and in the Suunto app.

Visit www.suunto.com/SuuntoLink for further information.

To update your dive computer software:

1. Plug your Suunto EON Core into the computer with the supplied USB cable.
2. Start SuuntoLink if it is not already running.
3. Click the update button in SuuntoLink.

 **TIP:** To sync your dives, connect the device to Suunto app before the software update.

4.34. Tank pressure

Your Suunto EON Core can be used with the total number of twenty (20) gases, each of which may have Suunto Tank POD for wireless tank pressure transmission.

To install and pair a Suunto Tank POD, see 5.5. *How to install and pair a Suunto Tank POD.*

In tank pressure view you can see the below screens.

The following example has the tank pressure alarm set to 100 bars. The tank pressure is 75 bars as indicated in the switch window in the bottom right corner.

In the switch window, the actual tank pressure is shown in blue by default. Tank pressure is shown in yellow when it is over 50 bars and below the tank pressure alarm value set by the user:

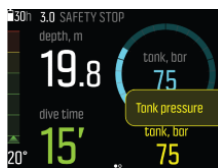

When the tank pressure drops below 50 bars, the actual tank pressure value is indicated in red in the switch window and a mandatory alarm is triggered:



4.35. Timer

Suunto EON Core has a timer that can be used for timing specific actions during surface or dive. The timer is shown in the bottom right corner as a scrollable item.

 **NOTE:** In timer view, the timer is displayed as an analog watch.

To use the timer:

1. Press the upper button to start the timer.
2. Press the upper button again to pause the timer.
3. Keep the upper button pressed to reset the timer.

Timer start and stop actions are saved in the dive log.

4.36. Water contacts

Suunto EON Core switches to dive state when water is detected. Dive starts

- when the water contact is on, at 1.2 m (4 ft), or
- when the water contact is not on, at 3.0 m (10 ft)

and ends

- when the water contact is on and your depth is less than 1.2 m (4 ft), or
- when the water contact is not on and your depth is at 3.0 m (10 ft).

When water contact is active, the color of the depth reading digits turns white.

5. Use

5.1. How to access device info

To access Suunto EON Core information:

1. Keep the middle button pressed to enter the main menu.
2. Scroll to **General** with the upper or lower buttons and press the middle button.
3. Press the middle button to enter **About EON**.
4. Scroll to **EON info**, press the middle button to enter. You can check device software version, serial number, etc. there.
5. Scroll with the lower button to see all information.
6. Keep the middle button pressed to go back and exit from the menu.

5.2. How to change display brightness

To change brightness level:

1. Go to **General » Device settings » Brightness**.
2. Select from default, high, or low.
3. Turn the display brightness down to save battery life significantly.



5.3. How to set language and unit

To change the device language and unit system:

1. Go to **Main menu » General » Device settings » Language** and select your language.
2. Go to **Main menu » General » Device settings » Units & formats**.

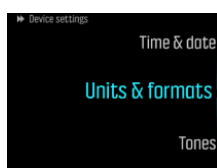

3. Select **Date format, Units, or Time format**.
4. Use the upper or lower button to select from the available formats.

 **NOTE:** Under unit settings, you have the option of selecting metric or imperial as a global setting; it will affect all measurements.

5. To set the unit system for specific measurements, select **Advanced**. For example, you can use metric for depth, and imperial for tank pressure.

5.4. How to set time and date

To change time and date

1. Keep the middle button pressed to enter menu.
2. Browse to **General** » **Device settings** » **Time & date**.
3. Scroll to **Set time** or **Set date** with the upper or lower button.
4. Press the middle button to enter the setting.
5. Adjust the setting with the upper or lower button.
6. Press the middle button to move to the next setting.
7. Press again the middle button when last value is set to save and go back to **Time & date** menu.
8. Keep middle button pressed to exit when done.

To change time and date formats

1. Keep the middle button pressed to enter menu.
2. Browse to **General** » **Device settings** » **Units & formats**.
3. Scroll to **Time format** or **Date format** with the upper or lower button.
4. Follow steps 5-8 as above to change and save formats.

5.5. How to install and pair a Suunto Tank POD

To install and pair a Suunto Tank POD:

1. Install the Tank POD as described in the *Tank POD quick guide* or in the *Tank POD user guide*.
2. After installing the Tank POD and opening the valve, wait for the green LED on the Tank POD to flash.
3. If your Suunto EON Core has a blank screen, press any key to activate it.
4. Use proximity pairing: Hold your Suunto EON Core close to the Tank POD. Make sure you follow the instructions in Tank POD alignment section of the *Tank POD user guide*.
5. After a few seconds, a menu pops up on the screen showing the Tank POD serial number, battery status and the tank pressure. Select the correct gas from the list to pair with your device and press the middle button to confirm pairing.

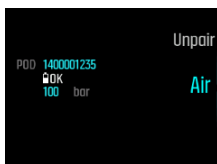

 **NOTE:** The battery level indication shown when pairing the Tank POD is an approximation only.

6. Repeat the procedure above for additional Tank PODs and select different gases for each POD.

Alternatively, you can pair the Suunto Tank POD(s) from the menu:

1. In the **Gases** menu, select the gas you want your Tank POD to pair with.



2. Press the middle button to open the gas settings and select **Tank POD**.

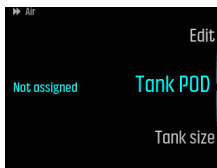

3. From the list of Tank PODs, select the one which matches the serial number of your Tank POD.

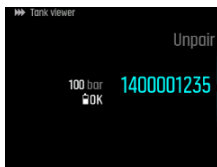

4. Make sure the Tank POD has been activated by ensuring the tank pressure reading shows on screen and POD green led is blinking.



In the dive main views, only one tank pressure is shown and corresponds to the active gas. When you change gas, the displayed tank pressure changes accordingly.

⚠ WARNING: *If there are several divers using Tank PODs, always check before you dive that the POD number of your selected gas corresponds to the serial number on your POD.*

📖 NOTE: *You can find the serial number on the metal base and also on the cover of the Tank POD.*

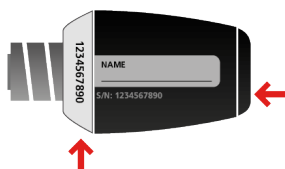

🗨 TIP: *Remove pressure from the Tank POD when not diving to save battery life. Close the tank valve and release the pressure from the regulator.*

To unpair and remove your Tank POD from a specific gas using proximity:

1. Hold your Tank POD close to your dive computer in tank pressure view:



2. **Gases** menu opens. Select the gas you want to unpair your Tank POD from:

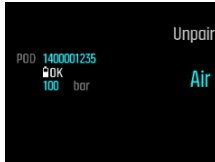

3. Select **Unpair**:

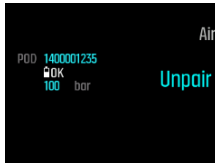

4. Your Tank POD is removed from the selected gas list:

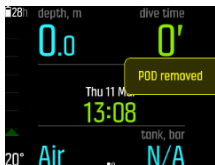
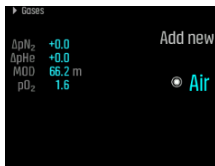

To unpair and remove your Tank POD from a specific gas through the menu:

1. Select the gas you want to unpair the Tank POD from in the **Gases** menu:

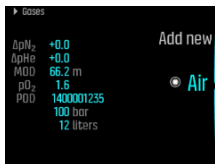

2. Press the middle button to enter the gas settings and select **Tank POD**.

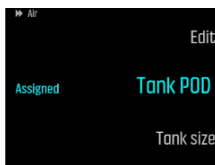

3. Select the Tank POD you want to unpair (check the serial number):



4. Select **Unpair**:

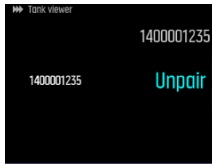

5. Your Tank POD is removed from the selected gas list:

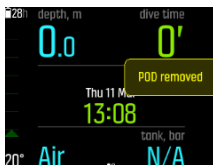
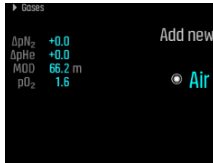

5.6. How to plan a dive using the Dive planner

Before planning your first dive, go through the planner settings and configure them according to your personal preference. Access the planner and adjust settings under **Main menu » Dive planner**.

1. First set the values for:

- personal gas consumption (default value: 25 L/min / 0.90 ft³)
- tank pressure (default value: 200 bar / 3000 psi)
- tank size (default value: 12 liters / 80 ft³, 3000 psi)

 **NOTE:** It is important to adjust these values first to get the gas calculations right.

2. Use the lower or upper buttons to decrease or increase the values. If you are not sure what your personal gas consumption is, we recommend using the default value of 25 L/min (0.90 ft³/min).

 **NOTE:** Estimated gas time is calculated based on tank pressure at start minus 35 bar (510 psi).

You can adjust dive depth, dive gas O₂ percentage and surface time interval in **View planner**.

Based on these parameters, **Dive planner** shows no decompression dive time for your planning purposes. If tank size, tank pressure and gas consumption are filled, planner shows gas time calculation too.

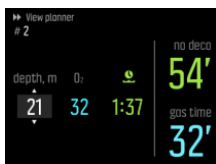

The calculated no decompression time is based on dive depth and gas mixture. Any residual nitrogen from previous dives, as well as surface time, is taken into consideration. **Gas time** is dependent on the dive depth, gas mixture, personal consumption, tank size and tank pressure.

Planning the first dive in a series

1. Edit depth and mixture in **View planner**.
2. As an example, enter 18 meters, use compressed air as a gas mixture, and you will see the following:

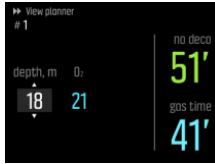

In this example, the calculated values are:

- a. Dive number in the dive series: 1
- b. Available no decompression time: 51 minutes
- c. Remaining gas time: 41 minutes

Planning additional dives

The dive planner allows you to adjust surface time in 10-minute increments. 48:00 hours is the maximum value to be set.

In the example below, the surface time before the second dive is 1 hour 37 minutes. Adjust surface time to see how it impacts no decompression time.

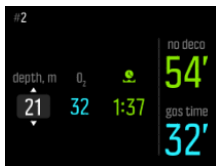

5.7. How to customize dive modes with Suunto app

To customize Suunto EON Core:

1. Download and install Suunto app from the app store of your iOS/Android mobile device.
2. Turn on Bluetooth on your phone and let the app find the available Suunto devices.
3. Pair your Suunto EON Core with the app.
4. Select **Dive mode customization**. You can create new dive modes and modify existing ones.



NOTE: When creating or modifying dive modes, you need to synchronize the changes with your Suunto EON Core to save the settings to your device. Synchronization is done automatically when changes are detected and you can also start it manually.

Dive mode customization includes the following steps:

Customizing **dive mode** name

- Add your custom dive mode name. The maximum length of the name is 15 characters.
- Use something short and simple that helps you identify the features and information that you have customized in this mode.

Selecting **dive type**

- Select Gauge, CCR or OC type.
- For more information, see the detailed dive mode descriptions under *4.16. Dive modes*.

Selecting **settings**

- Set the settings which you need for your dive (e.g., stops, alarms).
- Note that setting options are available depending on the selected dive type.
- See the respective sections of the user guide for more information on each setting.

Customizing **views**

- Create up to four custom views for each dive mode.
- Select a new view from the list of stored views. No deco (Default), Compass, Tank pressure and Timer views are available for you.
- Customize the style of the view. Select prominent, graphical or classic style:
 - Prominent style presents key information with large numbers:

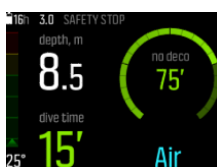

- Graphical style presents information with additional visual elements:



- With classic, information is presented in the traditional manner using numbers:



- Modify, delete or add new customizable fields within each view.
- For more information about the views in different dive modes, see the respective sections under *4.16. Dive modes*.

Adding and editing **gases**

- Configure what you see under the **Gases** menu in your Suunto EON Core device.
- Turn **Multiple gases** on or off.
- When **Multiple gases** is on, add new gases.

 **NOTE:** For detailed support material regarding dive mode customization in Suunto app, visit <https://www.suunto.com/Support/dive-computers-and-instruments-support/suunto-eon-core/>.

5.8. How to enable gas consumption metering

When you customize your Suunto EON Core in Suunto app to include the gas consumption info field in the switch window, this information will always be available and visible during a dive where you use the gas to which the Tank POD is attached.

 **TIP:** Make sure the tank size is correct.

To enable gas consumption metering:

1. Add the gas consumption field to your custom dive mode in Suunto app.
2. Install and pair a Suunto Tank POD.
3. When you have selected the correct gas and returned to the main time view, keep the middle button pressed to enter the menu.
4. Scroll to **Gases** with the lower button and select with the middle button.
5. Scroll to the gas you just selected from your Tank POD and select with the middle button.
6. Scroll to **Tank size** and select with the middle button.
7. Check the tank size and change the size with the upper or lower button as needed. Confirm the change with the middle button.
8. Keep the middle button pressed to exit the menu.

 **NOTE:** For accurate gas consumption, you must define the tank size. Not defining the tank size leads to incorrect gas consumption readings.

5.9. How to add bookmarks

While diving, keep the lower button pressed to add a bookmark (timestamp) to the active log for later reference.

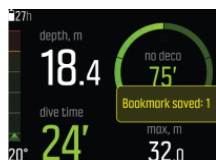

Bookmarks save the following information: time stamp, depth, temperature, and pressure if tank pod is used. Data can be seen in Suunto app after the dive.

 **NOTE:** In compass view, long pressing the lower button locks the bearing.

6. Care and support

6.1. Handling guidelines

Handle Suunto EON Core with care. The sensitive internal electronic components may be damaged if the device is dropped or otherwise mishandled.

When travelling with the dive computer, ensure that it is packed securely in check-in or carry-on luggage. It should be placed in a bag or other container where it cannot move around, be bumped or easily hit.

When flying, turn your dive computer to airplane mode under **General » Connectivity**.

Do not try to open or repair Suunto EON Core by yourself. If you are experiencing problems with the device, contact your nearest authorized Suunto Service Center.

 **WARNING:** ENSURE THE WATER RESISTANCE OF THE DEVICE! Moisture inside the device may seriously damage the unit. Only an authorized Suunto Service Center should do service activities.

Wash and dry the dive computer after use. Rinse very carefully after any salt-water dive.

Pay special attention to the pressure sensor area, water contacts, buttons, and USB cable port. If you use the USB cable before washing the dive computer, the cable (device end) should be rinsed as well.

After use, rinse it with fresh water, mild soap, and carefully clean the housing with a moist soft cloth or chamois.

 **NOTE:** Do not leave your Suunto EON Core in a bucket of water (for rinsing). The display stays on under water and consumes battery life.

Use only original Suunto accessories - damage caused by non-original accessories is not covered by warranty.

 **WARNING:** Do not use compressed air or high pressure water hoses to clean your dive computer. These can permanently damage the pressure sensor in your dive computer.

 **TIP:** Remember to register your Suunto EON Core at www.suunto.com/register to get personalized support.

6.2. Installing scratch guard

Use the provided scratch guard to help protect your Suunto EON Core from scratches.

To install the scratch guard:

1. Ensure the display glass is clean and dry.
2. Peel back the protective layer from one end of the scratch guard.
3. Place exposed adhesive side down squarely on one end of the display.
4. Pull back the protective layer from the scratch guard.
5. Press out any air bubbles with a soft, straight edge tool.

Watch the video on *YouTube*.

6.3. Changing strap to bungee

You can change between the wrist strap and bungee as needed. The bungee is provided as an option.

To install the bungee:

1. Remove both strap ends and take the springbars out of the strap ends.
2. Insert the springbars into the bungee adapters and attach the bungee adapters.
3. Thread the cord through both adapters.
4. Securely tie the ends of the bungee cord and cut off excess cord.

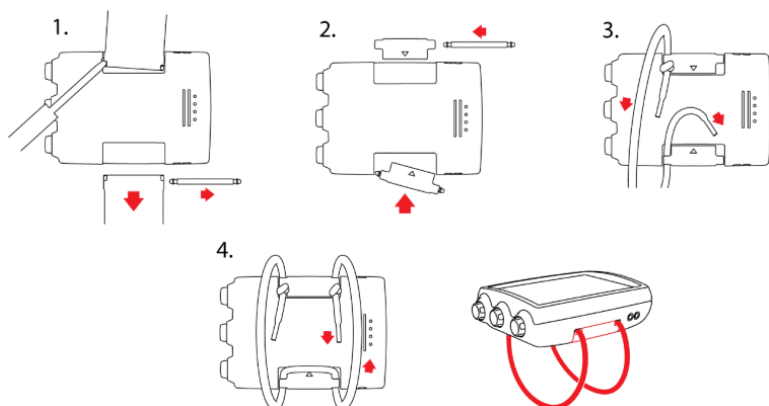

6.4. Charging battery

Charge Suunto EON Core with the supplied USB cable. For charging, use a USB port of 5 Vdc, with minimum 0.5 A as a power source. If the battery is very low, the display is off while charging until the battery reaches an adequate charge level. When battery is so low that device cannot be turned on, a red led is blinking next to the display. Blinking stops when battery has enough power to start the device. If the red led stops blinking while the display is still off, the charging stops. Remove the charging cable and reconnect it to continue charging.

When device is on and battery is charging, battery symbol in the upper left corner of the display turns green.

⚠ WARNING: You must only charge your device using USB adapters that comply with the IEC 62368-1 standard and have a maximum output of 5 V. Non-compliant adapters are a fire hazard and a risk to personal injury and might damage your Suunto device.

⚠ CAUTION: DO NOT use the USB cable when Suunto EON Core is wet. This may cause an electrical failure. Ensure the cable connector and connector pin area on the device are both dry.

⚠ CAUTION: DO NOT allow the connector pins of the USB cable to touch any conductive surface. This may short circuit the cable, making it unusable.

Rechargeable batteries have a limited number of charge cycles and may eventually need to be replaced. The battery should be replaced only by authorized Suunto Service Centers.

6.5. Getting support

To get additional support, visit www.suunto.com/support/dive-computers-and-instruments-support/suunto-eon-core/.

Our online support provides a comprehensive range of support materials, including the user guide, frequently asked questions, how-to videos, service and repair options, our dive service center locator, warranty terms and conditions as well as contact details for our customer support.

If you could not find answers to your questions on our online support, please contact our customer support. We are happy to assist you.

6.6. Disposal and recycling

Please dispose of the device in accordance with local laws and regulations for electronic waste and batteries. Do not throw the device away with normal household garbage. If you wish, you may return the device to your nearest Suunto dealer.

The symbol below indicates that within the European Union, this device must be disposed of according to the directive for Waste Electrical & Electronic Equipment (WEEE). Please follow the local practices of member states for the collection of electronic waste.



The proper collection and recycling of batteries and electronic devices helps conserve resources and minimizes their impact on the environment.

7. Reference

7.1. Technical specifications

Dimensions and weight:

- Length: 80 mm / 3.15 in
- Width: 55 mm / 2.17 in
- Height: 21 mm / 0.83 in
- Weight: 154 g / 5.43 oz

Operating conditions

- Altitude range: 0 to 3000 m / 9800 ft above sea level
- Operating temperature (diving): 0 °C to +40 °C / 32 °F to +104 °F
- Storage temperature: -20 °C to +50 °C / -4 °F to +122 °F
- Recommended charging temperature: 0 °C to +35 °C / +32 °F to +95 °F
- Maintenance cycle: 500 hours of diving or two years, whichever comes first



NOTE: *Diving in freezing conditions may damage the dive computer. Make sure the device does not freeze when wet.*



NOTE: *Do not leave the dive computer in direct sunlight!*



WARNING: *Do not expose the device to temperatures above or below the given limits, otherwise it might get damaged or you might be exposed to safety risk.*

Depth gauge

- Temperature compensated pressure sensor
- Accurate to 80 m / 262 ft complying with EN 13319 and ISO 6425
- Depth display range: 0 to 300 m / 0 to 984 ft
- Resolution: 0.1 m from 0 to 100 m / 1 ft from 0 to 328 ft

Temperature display

- Resolution: 1 °C / 1.5 °F
- Display range: -20 to +50 °C / -4 to +122 °F
- Accuracy: ± 2 °C / ± 3.6 °F within 20 minutes of temperature change in temperature range of 0 °C to 40 °C / 32 °F to 104 °F

Displays in mixed gas dive mode

- Helium %: 0–95
- Oxygen %: 5–99
- Oxygen partial pressure display: 0.0–3.0 bar
- CNS%: 0–500% with 1% resolution

- OTU: 0-1000

Other displays

- Dive time: 0 to 999 min
- Surface time: 0 to 99 h 59 min
- Dive counter: 0 to 99 for repetitive dives
- No decompression time: 0 to 99 min (>99 above 99)
- Ascent time: 0 to 999 min (>999 after 999)
- Ceiling depths: 3.0 to 300 m / 10 to 984 ft

Calendar clock

- Accuracy: ± 25 s/month (at 20 °C/68 °F)
- 12/24 h display

Compass

- Accuracy: $\pm 15^\circ$
- Resolution: 1°
- Max. tilt: 45 degrees
- Balance: global

Timer

- Accuracy: 1 second
- Display range: 0'00 – 99'59
- Resolution: 1 second

Logbook

- Sample rate: 10 seconds
- Memory capacity: approximately 200 hours of diving or 400 dive logs, whichever comes first

Tissue calculation model

- Suunto Fused™ RGBM 2 algorithm (developed by Suunto and Bruce R. Wienke, BSc, MSc, PhD)
- 15 tissue compartments
- Tissue compartment halftimes for nitrogen: 1, 2, 5, 10, 20, 40, 80, 120, 160, 240, 320, 400, 480, 560 and 720 min. The on-gassing and off-gassing halftimes are the same.
- Tissue compartment halftimes are divided by a constant factor to obtain helium halftimes.
- Reduced gradient (variable) M-values based on diving habit and dive violations. The M-values are tracked up to 100 hours after a dive
- The exposure calculations (CNS% and OTU) are based on recommendations by R.W. Hamilton, PhD and currently accepted exposure time limit tables and principles.

Battery

- Type: rechargeable lithium-ion
- Battery life: fully charged, 10-20 h dive time

The following conditions have an effect on the expected battery lifetime:

- The conditions in which the unit is operated and stored (for example, temperature/cold conditions). Below 10 °C/50 °F the expected battery lifetime is about 50- 75% of that at 20 °C/68 °F.
- The quality of the battery. Some lithium batteries may exhaust unexpectedly, which cannot be tested in advance.



NOTE: Rechargeable batteries have a limited number of charge cycles and may eventually need to be replaced. The battery should be replaced only by authorized Suunto Service Centers.



NOTE: Low temperature may activate the battery warning even though the battery has enough capacity for diving in water with higher temperatures (40 °C or less).

Radio transreceiver

- Bluetooth® Smart compatible
- Frequency band: 2402-2480 MHz
- Maximum output power: <4 dBm
- Range: ~3 m / 9.8 ft

Underwater radio receiver

- Frequency band: single channel 123 kHz
- Range: 1.5 m / 4.9 ft

Manufacturer

Suunto Oy

Tammiston kauppatie 7 A

FI-01510 Vantaa FINLAND

7.2. Compliance

For compliance related information, see “Product Safety and Regulatory Information” delivered together with your Suunto EON Core or available at www.suunto.com/SuuntoEonCoreSafety.

7.3. Trademark

Suunto EON Core, its logos, and other Suunto brand trademarks and made names are registered or unregistered trademarks of Suunto Oy. All rights are reserved.

7.4. Patent notice

This product is protected by pending patent applications and their corresponding national rights: US 13/803,795, US 13/832,081, US 13/833,054, US 14/040,808, US 7,349,805, and US 86608266.

Additional patent applications may be filed.

7.5. International Limited Warranty

Suunto warrants that during the Warranty Period Suunto or a Suunto Authorized Service Center (hereinafter Service Center) will, at its sole discretion, remedy defects in materials or workmanship free of charge either by a) repairing, or b) replacing, or c) refunding, subject to the terms and conditions of this International Limited Warranty. This International Limited Warranty is valid and enforceable regardless of the country of purchase. The International Limited Warranty does not affect your legal rights, granted under mandatory national law applicable to the sale of consumer goods.

Warranty Period

The International Limited Warranty Period starts at the date of original retail purchase.

The Warranty Period is two (2) years for Watches, Smart Watches, Dive Computers, Heart Rate Transmitters, Dive Transmitters, Dive Mechanical Instruments, and Mechanical Precision Instruments unless otherwise specified.

The Warranty Period is one (1) year for accessories including but not limited to Suunto chest straps, watch straps, chargers, cables, rechargeable batteries, bracelets and hoses.

The Warranty Period is five (5) years for failures attributable to the depth measurement (pressure) sensor on Suunto Dive Computers.

Exclusions and Limitations

This International Limited Warranty does not cover:

1. a. normal wear and tear such as scratches, abrasions, or alteration of the color and/or material of non-metallic straps, b) defects caused by rough handling, or c) defects or damage resulting from use contrary to intended or recommended use, improper care, negligence, and accidents such as dropping or crushing;
2. printed materials and packaging;
3. defects or alleged defects caused by use with any product, accessory, software and/or service not manufactured or supplied by Suunto;
4. non-rechargeable batteries.

Suunto does not warrant that the operation of the Product or accessory will be uninterrupted or error free, or that the Product or accessory will work with any hardware or software provided by a third party.

This International Limited Warranty is not enforceable if the Product or accessory:

1. has been opened beyond intended use;
2. has been repaired using unauthorized spare parts; modified or repaired by unauthorized Service Center;

3. serial number has been removed, altered or made illegible in any way, as determined at the sole discretion of Suunto; or
4. has been exposed to chemicals including but not limited to sunscreen and mosquito repellents.

Access to Suunto warranty service

You must provide proof of purchase to access Suunto warranty service. You must also register your product online at www.suunto.com/register to receive international warranty services globally. For instructions how to obtain warranty service, visit www.suunto.com/warranty, contact your local authorized Suunto retailer, or call Suunto Contact Center.

Limitation of Liability

To the maximum extent permitted by applicable mandatory laws, this International Limited Warranty is your sole and exclusive remedy and is in lieu of all other warranties, expressed or implied. Suunto shall not be liable for special, incidental, punitive or consequential damages, including but not limited to loss of anticipated benefits, loss of data, loss of use, cost of capital, cost of any substitute equipment or facilities, claims of third parties, damage to property resulting from the purchase or use of the item or arising from breach of the warranty, breach of contract, negligence, strict tort, or any legal or equitable theory, even if Suunto knew of the likelihood of such damages. Suunto shall not be liable for delay in rendering warranty service.

7.6. Copyright

Copyright © Suunto Oy. All rights reserved. Suunto, Suunto product names, their logos and other Suunto brand trademarks and names are registered or unregistered trademarks of Suunto Oy. This document and its contents are proprietary to Suunto Oy and are intended solely for the use of clients to obtain knowledge and information regarding the operation of Suunto products. Its contents shall not be used or distributed for any other purpose and/or otherwise communicated, disclosed or reproduced without the prior written consent of Suunto Oy. While we have taken great care to ensure that information contained in this documentation is both comprehensive and accurate, no warranty of accuracy is expressed or implied. This document content is subject to change at any time without notice. The latest version of this documentation can be downloaded at www.suunto.com.

7.7. Dive terms

| Term | Explanation |
|---------------|---|
| Altitude dive | A dive made at an elevation greater than 300 m (1000 ft) above sea level. |
| Ascent rate | The speed at which the diver ascends toward the surface. |
| Ascent time | The minimum amount of time needed to reach the surface on a decompression dive. |

| Term | Explanation |
|----------------------|---|
| CCR | Closed-Circuit Rebreather. Scuba that recycles all exhaled gas. |
| Ceiling | On a decompression dive, the shallowest depth to which a diver may ascend based on computed inert gas load. |
| CNS | Central nervous system toxicity. Toxicity is caused by oxygen. Can cause a variety of neurological symptoms. The most important of which is an epileptic-like convulsion which can cause a diver to drown. |
| CNS% | Central nervous system toxicity limit fraction. |
| Compartment | See Tissue group |
| DCS | Decompression sickness/illness. Any of a variety of maladies resulting either directly or indirectly from the formation of nitrogen or helium bubbles in tissues or body fluids, as a result of inadequately controlled decompression. |
| Decompression | Time spent at a decompression stop, or range, before surfacing, to allow absorbed nitrogen to escape naturally from tissues. |
| Decompression window | On a decompression dive, the depth range between the floor and the ceiling within which a diver must stop for some time during ascent. |
| Dive series | A group of repetitive dives between which the dive computer indicates some nitrogen loading is present. When nitrogen loading reaches zero the dive computer deactivates. |
| Dive time | Elapsed time between leaving the surface to descend, and returning to the surface at the end of a dive. |
| END | Equivalent Narcotic Depth is used as a way of estimating the narcotic effect of a breathing gas typically with trimix gas mixtures. For a given breathing gas mixture and depth the END indicates the depth which would produce the same narcotic effect when breathing compressed air. |
| Floor | The deepest depth during a decompression dive where it is recommended to stop for an effective decompression. |

| Term | Explanation |
|-----------------------|--|
| He% | Helium percentage or helium fraction in the breathing gas. |
| MOD | Maximum operating depth of a breathing gas is the depth at which the partial pressure of oxygen (pO ₂) of the gas mix exceeds a safe limit. |
| Multi level dive | A single or repetitive dive that includes time spent at various depths and therefore has no decompression limits that are not determined solely by the maximum depth reached. |
| Nitrox (Nx) | In sports diving, refers to any mix with a higher fraction of oxygen than standard air. |
| No deco | No decompression stop time. The maximum amount of time a diver may remain at a particular depth without having to make decompression stops during the subsequent ascent. |
| No decompression dive | Any dive which permits a direct, uninterrupted ascent to the surface at any time. |
| No dec time | Abbreviation for no decompression time limit. |
| OC | Open-circuit. Scuba that exhausts all exhaled gas. |
| OTU | Oxygen tolerance unit. Used to measure the whole-body-toxicity, caused by prolonged exposure to high oxygen partial pressures. The most common symptoms are irritation in the lungs, a burning sensation in the chest, coughing and reduction of the vital capacity. |
| O ₂ % | Oxygen percentage or oxygen fraction in the breathing gas. Standard air has 21% oxygen. |
| pO ₂ | Partial pressure of oxygen. Limits the maximum depth to which the gas mixture can be safely used. The contingency partial pressure limit is 1.6 bar. Dives beyond this limit risk immediate oxygen toxicity. |
| Repetitive dive | Any dive whose decompression time limits are affected by residual nitrogen absorbed during previous dives. |
| Residual nitrogen | The amount of excess nitrogen remaining in a diver after one or more dives. |
| RGBM | Reduced gradient bubble model. Modern algorithm for tracking both dissolved and free gas in divers. |

| Term | Explanation |
|--------------|--|
| Scuba | Self-contained underwater breathing apparatus. |
| Surface time | Elapsed time between surfacing from a dive and beginning a descent for the subsequent dive. |
| Tissue group | Theoretical concept used to model bodily tissues for the construction of decompression tables or calculations. |
| Trimix | A breathing gas mix of helium, oxygen and nitrogen. |



SUUNTO CUSTOMER SUPPORT

www.suunto.com/support

www.suunto.com/register

Manufacturer:

Suunto Oy
Tammiston kauppatie 7 A,
FI-01510 Vantaa FINLAND



© Suunto Oy 03/2022

Suunto is a registered trademark of Suunto Oy. All Rights reserved.