



Copeland Scroll® ZRK5 Compressor Cross Reference Guide

Copeland® Single Phase Compressor Models

TONNAGE	ZRK5	ZRK1	ZRK2	ZRKA	ZRKC	ZRK3	ZRK4
1.5T	ZR16K5-PFV			ZR16KA-PFV	ZR16KC-PFV		ZR16K4-PFV
	ZR18K5-PFV	ZR18K1-PFV			ZR18KC-PFV	ZR18K3-PFV	ZR18K4-PFV
2T	ZR21K5-PFV	ZR23K1-PFV		ZR21KA-PFV	ZR22KC-PFV	ZR22K3-PFV	ZR22K4-PFV
	ZR21K5-PFJ					ZR22K3-PFJ	ZR22K4-PFJ
	ZR25K5-PFV	ZR26K1-PFV		ZR26KA-PFV	ZR24KC-PFV	ZR24K3-PFV	ZR24K4-PFV
					ZR26KC-PFV	ZR26K3-PFV	
	ZR25K5-PFJ	ZR23K1-PFJ				ZR24K3-PFJ	ZR24K4-PFJ
						ZR26K3-PFJ	
	ZR28K5-PFV	ZR28K1-PFV		ZR28KA-PFV	ZR28KC-PFV	ZR28K3-PFV	
ZR28K5-PFJ	ZR28K1-PFJ			ZR29KC-PFV			
3T		ZR34K1-PFV		ZR32KA-PFV	ZR30KC-PFV	ZR30K3-PFV	
	ZR32K5-PFV			ZR34KA-PFV	ZR32KC-PFV	ZR32K3-PFV	
					ZR34KC-PFV	ZR34K3-PFV	
	ZR32K5-PFJ	ZR34K1-PFJ				ZR30K3-PFJ	
						ZR32K3-PFJ	
	ZR38K5-PFV			ZR38KA-PFV	ZR36KC-PFV	ZR36K3-PFV	
ZR38K5-PFJ					ZR36K3-PFJ		
3.5T	ZR42K5-PFV	ZR40K1-PFV		ZR42KA-PFV	ZR40KC-PFV	ZR40K3-PFV	
				ZR44KA-PFV	ZR42KC-PFV	ZR42K3-PFV	
	ZR42K5-PFJ					ZR40K3-PFJ	
						ZR42K3-PFJ	
4T			ZR46K2-PFV		ZR45KC-PFV	ZR45K3-PFV	
			ZR49K2-PFV		ZR47KC-PFV	ZR46K3-PFV	
	ZR48K5-PFV				ZR48KC-PFV	ZR47K3-PFV	
					ZR49KC-PFV	ZR48K3-PFV	
						ZR49K3-PFV	
	ZR48K5-PFJ					ZR45K3-PFJ	
						ZR47K3-PFJ	
					ZR48K3-PFJ		
4.5T	ZR54K5-PFV			ZR54KA-PFV	ZR54KC-PFV	ZR52K3-PFV	
						ZR54K3-PFV	

Legend	Voltage Code
	60-1-208/230
	60-1-265
	60-3-200/230
	60-3-460
	60-3-575

Copeland Scroll® ZRK5 Compressor Cross Reference Guide



Copeland® Three Phase Compressor Models

TONNAGE	ZRK5	ZRK1	ZRK2	ZRKA	ZRKC	ZRK3	ZRK4
2T	ZR21K5-TF5					ZR22K3-TF5	
	ZR21K5-TFD					ZR22K3-TFD	
	ZR25K5-TF5			ZR26KA-TF5		ZR24K3-TF5	
	ZR25K5-TFD					ZR26K3-TF5	
	ZR28K5-TF5					ZR24K3-TFD	
	ZR28K5-TFD					ZR26K3-TFD	
					ZR28K3-TF5		
					ZR28KC-TFD	ZR28K3-TFD	
3T	ZR32K5-TF5			ZR32KA-TF5		ZR30K3-TF5	
				ZR34KA-TF5		ZR32K3-TF5	
						ZR34K3-TF5	
	ZR32K5-TFD			ZR32KA-TFD	ZR34KC-TFD	ZR30K3-TFD	
				ZR34KA-TFD		ZR32K3-TFD	
						ZR34K3-TFD	
	ZR32K5-TFE			ZR32KA-TFE		ZR30K3-TFE	
				ZR34KA-TFE		ZR32K3-TFE	
						ZR34K3-TFE	
				ZR38KA-TF5		ZR36K3-TF5	
ZR38K5-TF5							
ZR38K5-TFD				ZR38KA-TFD	ZR36KC-TFD	ZR36K3-TFD	
ZR38K5-TFE				ZR38KA-TFE		ZR36K3-TFE	
3.5T	ZR42K5-TF5			ZR42KA-TF5		ZR40K3-TF5	
				ZR44KA-TF5		ZR42K3-TF5	
	ZR42K5-TFD			ZR42KA-TFD	ZR40KC-TFD	ZR40K3-TFD	
				ZR44KA-TFD	ZR42KC-TFD	ZR42K3-TFD	
	ZR42K5-TFE			ZR42KA-TFE		ZR40K3-TFE	
				ZR44KA-TFE		ZR42K3-TFE	
4T	ZR48K5-TF5		ZR46K2-TF5		ZR45KC-TF5	ZR45K3-TF5	
			ZR49K2-TF5		ZR46KC-TF5	ZR46K3-TF5	
					ZR47KC-TF5	ZR47K3-TF5	
					ZR48KC-TF5	ZR48K3-TF5	
					ZR49KC-TF5	ZR49K3-TF5	
	ZR48K5-TFD		ZR46K2-TFD		ZR45KC-TFD	ZR45K3-TFD	
			ZR49K2-TFD		ZR46KC-TFD	ZR46K3-TFD	
					ZR47KC-TFD	ZR47K3-TFD	
					ZR48KC-TFD	ZR48K3-TFD	
					ZR49KC-TFD	ZR49K3-TFD	
	ZR48K5-TFE		ZR46K2-TFE		ZR45KC-TFE	ZR46K3-TFE	
			ZR49K2-TFE		ZR47KC-TFE	ZR47K3-TFE	
					ZR48KC-TFE	ZR48K3-TFE	
					ZR49KC-TFE	ZR49K3-TFE	
4.5T	ZR54K5-TF5			ZR54KA-TF5	ZR54KC-TF5	ZR52K3-TF5	
						ZR54K3-TF5	
	ZR54K5-TFD			ZR54KA-TFD	ZR54KC-TFD	ZR52K3-TFD	
						ZR54K3-TFD	
	ZR54K5-TFE			ZR54KA-TFE	ZR54KC-TFE	ZR52K3-TFE	
						ZR54K3-TFE	





Legend	Voltage Code
	60-1-208/230
	60-1-265
	60-3-200/230
	60-3-460
	60-3-575

Copeland Scroll® ZRK5 Compressor Cross Reference Guide



Single Phase

TONNAGE	ZRK5	Copeland®	Bristol	Tecumseh	Carlyle	LG	Danfoss
1.5T	ZR16K5-PFV	ZR16K4-PFV	H2EB153ABC	AWJ5517EXN			
	ZR18K5-PFV	ZR18K4-PFV	H20J193ABC	AW5519E			
		H21J173ABC	AW5519F				
		H21J17BABC	AW5519G				
		H21J193ABC	AWA5519EXD				
		H21J19BABC	AWB5519EXD				
			AWC5519EXD				

Legend	Voltage Code
	60-1-208/230
	60-1-265
	60-3-200/230
	60-3-460
	60-3-575

Single Phase

TONNAGE	ZRK5	Copeland®	Bristol	Tecumseh	Carlyle	LG	Danfoss	
2T	ZR21K5-PFV	ZR22K4-PFV	H20C233ABC	AW5522E		SQ022K		
			H20J223ABC	AW5522F		SQA022K		
			H21J223ABC	AW5522G				
				AWA5522EXD				
				AWB5522EXD				
				AWC5522EXD				
				AWF5522EXN				
		ZR21K5-PFJ	ZR22K4-PFJ	H20B223ABH				
	ZR25K5-PFV	ZR24K4-PFV	H20J253ABC	AW5524E	SCD230AC	SQA024K		
			H21C263ABC	AW5524F				
			H21J243ABC	AW5524G				
			H21J24BABC	AWA5524EXD				
			H21J253ABC	AWB5524EXD				
			H21J25BABC	AWC5524EXD				
			ZR26K3-PFV		AWF5526EXN	SCD260HC	SQ024K	
						SQ026K		
						SQA026K		
	ZR28K5-PFV	ZR28K3-PFV	H20C303ABC	AW5528E	SCD290HC	SQ028K		
			H20J293ABC	AW5528F		SQA028K		
			H21C293ABC	AW5528G				
			H21J273ABC	AWA5528EXD				
		H21J27BABC	AWB5528EXD					
		H21J303ABC	AWC5528EXD					
		H21J30BABC	AWF5528EXN					

Legend	Voltage Code
Yellow	60-1-208/230
Orange	60-1-265
Light Blue	60-3-200/230
Light Green	60-3-460
Pink	60-3-575

Three Phase

TONNAGE	ZRK5	Copeland®	Bristol	Tecumseh	Carlyle	LG	Danfoss
2T	ZR25K5-TF5	ZR26K3-TF5	H21J273DBL				
	ZR28K5-TF5	ZR28K3-TF5	H21J323DBL	AW5528F			
					AWB5528EXT		
					AWG5530EXT		
ZR28K5-TFD	ZR28K3-TFD				SQ028U		

Copeland Scroll® ZRK5 Compressor Cross Reference Guide



Single Phase

TONNAGE	ZRK5	Copeland®	Bristol	Tecumseh	Carlyle	LG	Danfoss
3T	ZR32K5-PFV	ZR30K3-PFV	H20J313ABC	AW5530E	SCD300AC	SQ030K	
			H20J323ABC	AW5530F		SQA030K	
			H21J323ABC	AW5530G			
			H21J32BABC	AWA5530EXD			
			H29A323CBC	AWB5530EXD			
				AWC5530EXD			
				AWF5530EXN			
		ZR32K3-PFV	H21J343ABC	AV5532H		SQ032K	HRM032U1
			H23C323ABC	AVC5532EXN		SQA032K	
			H23C343ABC	AW5532E			
				AW5532F			
				AW5532G			
				AWA5532EXD			
				AWB5532EXD			
			AWC5532EXD				
			AWF5532EXN				
	ZR34K3-PFV	H20C343ABC	AV5533F		SCD340AC	SQ034K	HRM034U1
		H20J353ABC	AV5533G		SCD340HC	SQA034K	
		H21C343ABC	AVB5533EXN		XCD340HA		
		H21J34BABC	AVD5533EXN				
	ZR32K5-PFJ	ZR30K3-PFJ	H23A303ABH				
	ZR38K5-PFV	ZR36K3-PFV	H20C373ABC	AV5538G	SCD370AC	SQ036K	HRM038U1
			H20J383ABC	AVB5538EXN	XCD380HA	SQA036K	
			H21C383ABC	AVC5535EXN			
			H21J363ABC				
			H21J36BABC				
			H21J383ABC				
			H21J38BABC				
		H23C383ABC					
	H29A403CBC						
ZR38K5-PFJ	ZR36K3-PFJ	H23A353ABH	AH8543E				
		H23B33SABH	AV5535E				
		H29B35UABH	AVA5535EXV				

Legend	Voltage Code
	60-1-208/230
	60-1-265
	60-3-200/230
	60-3-460
	60-3-575

Three Phase

TONNAGE	ZRK5	Copeland®	Bristol	Tecumseh	Carlyle	LG	Danfoss	
3T	ZR32K5-TF5	ZR32K3-TF5					HRM032U2	
		ZR34K3-TF5	H20C343DBL*	AV5533G	SCY342AC		HRM034U2	
			H21C343DBY	AVB5533EXT	SCY342HC			
				PJG301	XCY342HA			
	ZR32K5-TFD	ZR32K3-TFD						HRM032U4
		ZR34K3-TFD	H20C343DBE			SCH342AC		HRM034U4
			H21C343DBE			SCH342HC		
					XCH342HA			
	ZR32K5-TFE	ZR34K3-TFE			AVB5533EXH			
					TVB5535EXH			
	ZR38K5-TF5	ZR36K3-TF5	H20C343DBY			SCY372AC		HRM038U2
			H20C373DBL*			XCY382HA		
			H20C373DBY					
	ZR38K5-TFD	ZR36K3-TFD	H20C373DBE			SCH372AC	SQ036U	HRM038U4
					XCH382HA			
ZR38K5-TFE	ZR36K3-TFE	H20C373DBF			XCJ382HA		HRM038U7	

Legend	Voltage Code
	60-1-208/230
	60-1-265
	60-3-200/230
	60-3-460
	60-3-575

Single Phase

TONNAGE	ZRK5	Copeland®	Bristol	Tecumseh	Carlyle	LG	Danfoss	
3.5T	ZR42K5-PFV	ZR40K3-PFV	H20C403ABC	AV5538E	SCD380HC	SQ038K	HRM040U1	
			H20J403ABC	AV5538F	SCD400AC	SQ042K		
			H21C403ABC	AV5538H	SCD400GC	SQA038K		
			H21J40BABC	AV5540F	SCD400HC	SRA040K		
			H23C403ABC	AVA5538EXN	XCD400HA			
			H23C423ABC	AVC5538EXN				
				AVD5538EXN				
				AVD5540EXN				
			ZR42K3-PFV	H20C423ABC	AV5542E	SCD420AC	SRA042K	HRM042U1
				H20C453*	AV5542F	SCD420HC		
				H20J423ABC	AV5542G	XCD420HA		
				H20J433ABC	AV5542H			
				H21C423ABC	AV5543F			
			H21J433ABC	AVA5542EXN				
			H21J43BABC	AVB5542EXN				
				AVC5542EXN				
				AVD5542EXN				
				AVD5543EXN				
		ZR42K5-PFJ	ZR40K3-PFJ		AV5538E			
					AVA5538EXV			
			ZR42K3-PFJ		AH8548E			
					AV5542E			
					AVA5542EXV			

Legend	Voltage Code
	60-1-208/230
	60-1-265
	60-3-200/230
	60-3-460
	60-3-575

Three Phase

TONNAGE	ZRK5	Copeland®	Bristol	Tecumseh	Carlyle	LG	Danfoss	
3.5T	ZR42K5-TF5	ZR40K3-TF5	H20C403DBL*	AV5540F	SCY382HC		HRM040U2	
			H20C403DBY	AVD5540EXT	SCY402AC			
			H20C423DBL*		XCY402HA			
			H20J403DBL					
			H20J423DBD					
			H23C383DBD					
			H23C403DBD					
			H29A423DBL					
		ZR42K3-TF5	H20C423DBY		SCY422AC			HRM042U2
			H21C423DBY		SCY422HC			
				XCY422HA				
	ZR42K5-TFD	ZR40K3-TFD	H20C403DBE	AV5540F	SCH382HC		HRM040U4	
			H23C383DBE	AVD5540EXG	SCH402AC			
					XCH402HA			
		ZR42K3-TFD	H20C423DBX	AV5542F	SCH422AC		SQ042U	HRM042U4
			H21C423DBE	AVD5542EXG	SCH422HC			
			H23C403DBE		XCH422HA			
		H23C423DBE						
	ZR42K5-TFE	ZR40K3-TFE	H23A383DBF	AVD5540EXH	XCJ402HA		HRM040U7	
			H23C383DBF	TVA5540EXH				
			H23C403DBF					
		H24A383DBF						
ZR42K3-TFE		H20C423DBF	AVD5542EXH	XCJ422HA			HRM042U7	
		H21C423DBF						
	H23C423DBF							

Legend	Voltage Code
	60-1-208/230
	60-1-265
	60-3-200/230
	60-3-460
	60-3-575

Single Phase

TONNAGE	ZRK5	Copeland®	Bristol	Tecumseh	Carlyle	LG	Danfoss	
4T	ZR48K5-PFV	ZR45K3-PFV	H20R453ABC	AV5545F	SRD450AC	SRA045K	HRM045U1	
			H21C463*	AVD5545EXN	SRD450HC		SRA047K	
			H23C453ABC		XCD450HA			
			H29A473CBC					
			H2EC483*					
		ZR46K3-PFV	H20R483ABC					
			H21R453ABC					
			H21R483CBC					
		ZR47K3-PFV	H21R483ABC	AV5548F	SRD480AC		HRM047U1	
			H23C473ABC	AVD5548EXN	SRD480HC			
		H23R483ABC		XCD470HA				
				XRD480HA				
				XRD480HE				
				XRD480HU				
		ZR48K3-PFV					HRM048U1	
	ZR49K3-PFV	H20R513ABC*	AV5549G		SRA049K			
		H29A503CBC	AVB5549EXN					
	ZR48K5-PFJ	ZR47K3-PFJ		AV5546E				
				AVA5546EXV				

Legend	Voltage Code
	60-1-208/230
	60-1-265
	60-3-200/230
	60-3-460
	60-3-575

Three Phase

TONNAGE	ZRK5	Copeland®	Bristol	Tecumseh	Carlyle	LG	Danfoss	
4T	ZR48K5-TF5	ZR45K3-TF5	H20R453DBL*	AV5545F	SRY452AC		HRM045U2	
			H20R453DBY	AVD5545EXT	SRY452HC			
			H21J443DBD	CL5544E				
			H21R453DBY	CL5544G				
			H23C423DBD	SAA5545EXT				
		ZR45KC-TF5	H21R453DBL*		XCY452HA			
			H29A473DBL					
		ZR47K3-TF5	H20R483DBL*	AV5548F				HRM047U2
			H20R483DBY	AVD5548EXT				
			H21R483DBL*					
			H21R483DBY					
			H21R513DBY					
			H23C453DBD					
			H23C473DBD					
			ZR47KC-TF5				XCY472HA	
	ZR48K3-TF5	H28A503DBL		SRY482AC				
				SRY482HC				
	ZR49K3-TF5	H21R513DBL						
		H29A503DBL						

Copeland Scroll® ZRK5 Compressor Cross Reference Guide







Three Phase (cont.)

TONNAGE	ZRK5	Copeland®	Bristol	Tecumseh	Carlyle	LG	Danfoss
4T	ZR48K5-TFD	ZR45K3-TFD	H21R453DBE	AV5545F	SRH452AC		HRM045U4
			H23C453DBE	AVD5545EXG	SRH452HC		
				CL36ZC14			
				CL5544E			
				CL5544G			
		ZR45KC-TFD	H29A473DBV		XCH452HA		
					XCJ452HA		
		ZR46K3-TFD	H20R453DBE				
		ZR47K3-TFD	H20R483DBE				
			H21R483DBE				
		ZR47KC-TFD			XCH472HA		
		ZR48K3-TFD	H28A473DBV		SRH482AC		
					SRH482HC		
		ZR48KC-TFD	H23C473DBE		XRH482HA		
					XRH482HE		
					XRH482HU		
					XRJ482HA		
					XRJ482HE		
				XRJ482HU			
				XRY482HA			
				XRY482HE			
				XRY482HU			
		ZR49K3-TFD	H21R513DBE*				
			H29A503DBV				
		ZR49KC-TFD	H28A503DBV				
		ZR45KC-TFE	H23A423DBF	AVD5545EXH			
			H25A46QDBF	TVA5545EXH			
			H27A46QDBF				
		ZR46K3-TFE	H23C453DBF				
		ZR47K3-TFE		AVD5548EXH			
	ZR47KC-TFE	H29A473DBF		XCJ472HA			
	ZR48KC-TFE	H23C473DBF					
		H25A50QDBF					
		H26A46QDBF					
		H27A50QDBF					
	ZR49K3-TFE	H23A463DBF					
		H28A503DBF					
		H29A503DBF					

Legend	Voltage Code
	60-1-208/230
	60-1-265
	60-3-200/230
	60-3-460
	60-3-575

Single Phase

TONNAGE	ZRK5	Copeland®	Bristol	Tecumseh	Carlyle	LG	Danfoss
4.5T	ZR54K5-PFV	ZR52K3-PFV	H20C523*		XRD510HA		HRM051U1
			H21C533*		XRD510HE		
			H23R513ABC		XRD510HU		
			H26A54QCBC				
		ZR54K3-PFV	H21R543ABC	AV5555E	XRD540HA	SRA054K	HRM054U1
			H22C563*	AVA5555EXN	XRD540HE		
			H22R583ABC	SF*5554E	XRD540HU		
			H23R543ABC	SF5554E			
			H23R583ABC	SF5554EXD			
			H25A56QCBC	SFA5554EXN			
			H26A56QCBC				
			H29A543CBC				
			H29A563CBC				

Legend	Voltage Code
	60-1-208/230
	60-1-265
	60-3-200/230
	60-3-460
	60-3-575

Three Phase

TONNAGE	ZRK5	Copeland®	Bristol	Tecumseh	Carlyle	LG	Danfoss	
4.5T	ZR54K5-TF5	ZR52K3-TF5	H23R513DBD		XRY512HA		HRM051U2	
					XRY512HE			
					XRY512HU			
		ZR54K3-TF5	H21R543DBY	SF5554E	SRY542HC		HRM054U2	
			H23R543DBD	SF5554EXT				
			H29A543DBL	SFA5554EXT				
		ZR54KC-TF5	H28A543DBL		XRY542HA			
			H29A563DBL		XRY542HE			
					XRY542HU			
	ZR54K5-TFD	ZR52K3-TFD						HRM051T4
								HRM051U4
		ZR54K3-TFD	H28A543DBV	SF5554E	SRH552HE			HRM054U4
			H29A563DBV	SFA5554EXG				
		ZR54KC-TFD	H21R543DBE		XRH542HA			
			H23R513DBE		XRH542HE			
			H23R543DBE		XRH542HU			
			H29A543DBV					
	ZR54K5-TFE	ZR54KC-TFE	H25A54QDBF		XRJ542HA			
			H26A54QDBF		XRJ542HE			
		H27A56QDBF		XRJ542HU				
		H29A563DBF						

Legend	Voltage Code
	60-1-208/230
	60-1-265
	60-3-200/230
	60-3-460
	60-3-575

Single Phase

TONNAGE	ZRK5	Copeland®	Bristol	Tecumseh	Carlyle	LG	Danfoss
5T	ZR57K3-PFV	ZR57K3-PFV	H20R583ABC	AV5558F	SRD580AC		HRM058T1
			H21R583CBC	AV5558G	SRD580GC		HRM058U1
			H22C613*	AVB5558EXN	SRD580HC		
			H22R603ABC	AVD5558EXN	XRD580HA		
			H23R603ABC	SF*5558E	XRD580HE		
				SF5558E	XRD580HU		
				SF5558EXD			
				SFA5558EXN			
	ZR61K3-PFV	ZR61K3-PFV	H20R603ABC	SF*5560E	SRD600AC		HRM060T1
			H21C613*	SF5560E	SRD600HC		HRM060U1
			H21C683*	SF5560EXD	XRD600HA		
			H21R583ABC	SFA5560EXN	XRD600HE		
			H21R603ABC		XRD600HU		
			H21R603CBC				
			H26A62QCBC				
			H29A623CBC				

Legend	Voltage Code
	60-1-208/230
	60-1-265
	60-3-200/230
	60-3-460
	60-3-575

Three Phase

TONNAGE	ZRK5	Copeland®	Bristol	Tecumseh	Carlyle	LG	Danfoss
5T	ZR57K3-TF5	ZR57K3-TF5	H20R583DBL*	AV5558F	SRY582AC		HRM058U2
			H20R583DBY	AVD5558EXT	SRY582AE		
			H20R603DBY	SF5558E	SRY582HC		
			H21R583DBL*	SF5558EXT	XRY582HA		
			H21R583DBY	SFA5558EXT	XRY582HE		
			H23R583DBD		XRY582HU		
			H23R603DBD				
			H29A583DBL				
		ZR57KC-TF5		AV5558G			
				AVB5558EXT			

Three Phase (cont.)

TONNAGE	ZRK5	Copeland®	Bristol	Tecumseh	Carlyle	LG	Danfoss
5T	ZR61K3-TF5	ZR61K3-TF5	H20R603DBL	CL5562E	SRY602AC		HRM060U2
			H21R603DBL	CL5562G	SRY602HC		
				SF5560E	SRY612HE		
				SF5560EXT			
				SFA5560EXT			
	ZR57K3-TFD	ZR57K3-TFD	H20R583DBE	AV5558F	SRH582AC		HRM058U4
			H23R583DBE	AV5558G	SRH582HC		
			H23R603DBE	AVB5558EXG	XRH582HA		
			H23R603DBE	AVD5558EXG	XRH582HE		
				SAA5558EXG	XRH582HU		
				SF5558E			
				SFA5558EXG			
	ZR57KC-TFD	H21R583DBE	TVA5558EXG				
	ZR61K3-TFD	ZR61K3-TFD	H20R603DBE	SF5560E	SRH602AC		HRM060T4
			H21R603DBE	SFA5560EXG	SRH602HC		HRM060U4
					SRH612HC		
					XRH602HA		
					XRH602HE		
	ZR57K3-TFE	ZR57K3-TFE	H23R543DBF	TVA5558EXH	XRJ582HA		HRM058U7
			H23R583DBF		XRJ582HE		
			H23R603DBF		XRJ582HU		
		ZR57KC-TFE	H20R583DBF	AVD5558EXH			
			H25A56QDBF	AVG5558EXH			
	ZR61K3-TFE	ZR61K3-TFE	H21R583DBF		XRJ602HA		HRM060U7
			H25A62QDBF		XRJ602HE		
			H26A62QDBF		XRJ602HU		
			H27A62QDBF		XRY602HA		
					XRY602HE		
				XRY602HU			
ZR61KC-TFE	H20R603DBF						

Legend	Voltage Code
	60-1-208/230
	60-1-265
	60-3-200/230
	60-3-460
	60-3-575

Copeland Scroll® ZRK5 Compressor Specification Chart

Model	ARI Capacity Btu/hr	RLA Amps TF5/TFD	Run Cap. MFD/Volts	Diameter Inches (A)	Suction Height Inches (B)	Discharge Height Inches (C)	Height Inches (D)	Weight Lbs.	Suction Diameter Inches
ZR16K5-PFV	15,500	9.3	30/370	5.5	10.1	14.2	15.3	47	3/4
ZR18K5-PFV	18,000	10.7	30/370	5.5	10.1	14.2	15.3	47	3/4
ZR21K5-PFV	21,000	12.0	35/370	5.5	10.1	14.2	15.3	47	3/4
ZR21K5-TF5/D	21,000	8.6/Pending	N/A	5.5	10.1	14.2	15.3	45	3/4
ZR25K5-PFV	25,300	15.0	40/370	5.5	10.1	14.2	15.3	50	3/4
ZR25K5-TF5/D	25,300	8.9/Pending	N/A	5.5	10.1	14.2	15.3	48	3/4
ZR28K5-PFV	28,400	15.7	45/370	5.5	10.1	14.2	15.3	50	3/4
ZR28K5-TF5/D	28,400	11.1/Pending	N/A	5.5	10.1	14.2	15.3	48	3/4
ZR32K5-PFV	32,600	17.1	50/370	5.5	10.1	14.2	15.3	50	3/4
ZR32K5-TF5/D	32,600	12/6.4	N/A	5.5	10.1	14.2	15.3	49	3/4
ZR38K5-PFV	38,000	21.4	55/370	6.5	11.1	15.4	16.4	64	7/8
ZR38K5-TF5/D	38,000	13.6/6.4	N/A	6.5	11.1	15.4	16.4	60	7/8
ZR42K5-PFV	42,200	22.1	55/370	6.5	11.1	15.4	16.4	68	7/8
ZR42K5-TF5/D	42,200	14.3/6.4	N/A	6.5	11.1	15.4	16.4	61	7/8
ZR48K5-PFV	48,200	24.3	60/440	6.5	11.1	15.4	16.4	72	7/8
ZR48K5-TF5/D	48,200	Pending	N/A	6.5	11.1	15.4	16.4	68	7/8
ZR54K5-PFV	53,500	28.2	80/370	6.5	11.1	15.4	16.4	73	7/8
ZR54K5-TF5/D	53,500	17.1/7.9	N/A	6.5	11.1	15.4	16.4	69	7/8

Mounting pattern 7.5"x7.5" (same as previous Copeland Scroll models)

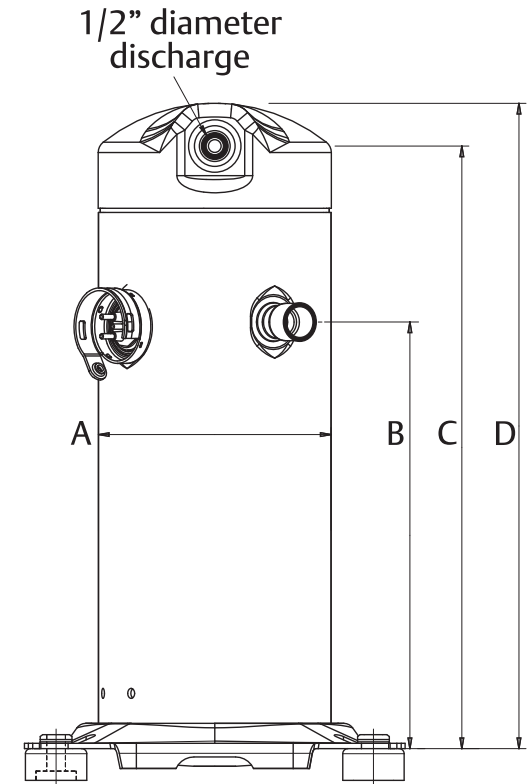

Rotalock™ Kit Part Numbers			
		Adapter	Seal
Suction	3/4" to 1-1/4"-12	998-0034-01	020-0028-02
Suction	7/8" to 1-1/4"-12	998-0034-02	020-0028-02
Discharge	1/2" to 1"-14	998-0034-15	020-0028-00

Additional information

Copeland Scroll ZRK5 compressors are offered in an -800 bill-of-material option, such as ZR25K5-PFV-800, that includes the compressor with a 42 inch molded plug wiring harness, mounting parts and installation instructions.

Other available information includes:
A/C Compressor Product Guide (2008ECT-113)
ZRK5 Product Brochure (2009ECT-98)

For complete product details and additional information, visit EmersonClimate.com and select Online Product Information (OPI) or CopelandScroll.com.

EmersonClimate.com

2009ECT-94 (12/09) Emerson and Copeland Scroll are trademarks of Emerson Electric Co. or one of its affiliated companies
©2009 Emerson Climate Technologies, Inc. All rights reserved. Printed in the USA.

