

CC1310 SimpleLink™ Ultra-Low-Power Sub-1 GHz Wireless MCU

1 Device Overview

1.1 Features

- Microcontroller
 - Powerful ARM® Cortex®-M3 Processor
 - EEMBC CoreMark® Score: 142
 - EEMBC ULPBench™ Score: 158
 - Clock Speed up to 48-MHz
 - 32KB, 64KB, and 128KB of In-System Programmable Flash
 - 8KB of SRAM for Cache (or as General-Purpose RAM)
 - 20KB of Ultra-Low-Leakage SRAM
 - 2-Pin cJTAG and JTAG Debugging
 - Supports Over-the-Air (OTA) Update
- Ultra-Low-Power Sensor Controller
 - Can Run Autonomously From the Rest of the System
 - 16-Bit Architecture
 - 2KB of Ultra-Low-Leakage SRAM for Code and Data
- Efficient Code-Size Architecture, Placing Parts of TI-RTOS, Drivers, and Bootloader in ROM
- RoHS-Compliant Package
 - 7-mm x 7-mm RGZ VQFN48 (30 GPIOs)
 - 5-mm x 5-mm RHB VQFN32 (15 GPIOs)
 - 4-mm x 4-mm RSM VQFN32 (10 GPIOs)
- Peripherals
 - All Digital Peripheral Pins Can Be Routed to Any GPIO
 - Four General-Purpose Timer Modules (Eight 16-Bit or Four 32-Bit Timers, PWM Each)
 - 12-Bit ADC, 200 ksamples/s, 8-Channel Analog MUX
 - Continuous Time Comparator
 - Ultra-Low-Power Clocked Comparator
 - Programmable Current Source
 - UART
 - 2x SSI (SPI, MICROWIRE, TI)
 - I²C, I²S
 - Real-Time Clock (RTC)
 - AES-128 Security Module
 - True Random Number Generator (TRNG)
 - Support for Eight Capacitive Sensing Buttons
 - Integrated Temperature Sensor
- External System
 - On-Chip Internal DC-DC Converter
 - Seamless Integration With the SimpleLink™ CC1190 Range Extenders
- Low Power
 - Wide Supply Voltage Range: 1.8 to 3.8 V
 - RX: 5.4 mA
 - TX at +10 dBm: 13.4 mA
 - Active-Mode MCU 48 MHz Running Coremark: 2.5 mA (51 µA/MHz)
 - Active-Mode MCU: 48.5 CoreMark/mA
 - Active-Mode Sensor Controller at 24 MHz: 0.4 mA + 8.2 µA/MHz
 - Sensor Controller, One Wakeup Every Second Performing One 12-Bit ADC Sampling: 0.95 µA
 - Standby: 0.7 µA (RTC Running and RAM and CPU Retention)
 - Shutdown: 185 nA (Wakeup on External Events)
- RF Section
 - Excellent Receiver Sensitivity –124 dBm Using Long-Range Mode, –110 dBm at 50 kbps (Sub-1 GHz)
 - Excellent Selectivity (±100 kHz): 56 dB
 - Excellent Blocking Performance (±10 MHz): 90 dB
 - Programmable Output Power up to +15 dBm
 - Single-Ended or Differential RF Interface
 - Suitable for Systems Targeting Compliance With Worldwide Radio Frequency Regulations
 - ETSI EN 300 220, EN 303 204 (Europe)
 - FCC CFR47 Part 15 (US)
 - ARIB STD-T108 (Japan)
 - Wireless M-Bus and Selected IEEE® 802.15.4g PHY
- Tools and Development Environment
 - Full-Feature and Low-Cost Development Kits
 - Multiple Reference Designs for Different RF Configurations
 - Packet Sniffer PC Software
 - Sensor Controller Studio
 - SmartRF™ Studio
 - SmartRF Flash Programmer 2
 - IAR Embedded Workbench® for ARM
 - Code Composer Studio™



1.2 Applications

- 315-, 433-, 470-, 500-, 779-, 868-, 915-, 920-MHz ISM and SRD Systems
- Low-Power Wireless Systems With 50-kHz to 5-MHz Channel Spacing
- Home and Building Automation
- Wireless Alarm and Security Systems
- Industrial Monitoring and Control
- Smart Grid and Automatic Meter Reading
- Wireless Healthcare Applications
- Wireless Sensor Networks
- Active RFID
- IEEE 802.15.4g, IP-Enabled Smart Objects (6LoWPAN), Wireless M-Bus, KNX Systems, Wi-SUN™, and Proprietary Systems
- Energy-Harvesting Applications
- Electronic Shelf Label (ESL)
- Long-Range Sensor Applications
- Heat-Cost Allocators

1.3 Description

The CC1310 is a member of the CC26xx and CC13xx family of cost-effective, ultra-low-power, 2.4-GHz and Sub-1 GHz RF devices. Very low active RF and microcontroller (MCU) current consumption, in addition to flexible low-power modes, provide excellent battery lifetime and allow long-range operation on small coin-cell batteries and in energy-harvesting applications.

The CC1310 device is the first device in a Sub-1 GHz family of cost-effective, ultra-low-power wireless MCUs. The CC1310 device combines a flexible, very low power RF transceiver with a powerful 48-MHz Cortex®-M3 microcontroller in a platform supporting multiple physical layers and RF standards. A dedicated Radio Controller (Cortex®-M0) handles low-level RF protocol commands that are stored in ROM or RAM, thus ensuring ultra-low power and flexibility. The low-power consumption of the CC1310 device does not come at the expense of RF performance; the CC1310 device has excellent sensitivity and robustness (selectivity and blocking) performance.

The CC1310 device is a highly integrated, true single-chip solution incorporating a complete RF system and an on-chip DC-DC converter.

Sensors can be handled in a very low-power manner by a dedicated autonomous ultra-low-power MCU that can be configured to handle analog and digital sensors; thus the main MCU (Cortex-M3) can maximize sleep time.

The CC1310 power and clock management and radio systems require specific configuration and handling by software to operate correctly, which has been implemented in the TI-RTOS. TI recommends using this software framework for all application development on the device. The complete [TI-RTOS](#) and device drivers are offered in source code free of charge.

Device Information⁽¹⁾

PART NUMBER	PACKAGE	BODY SIZE (NOM)
CC1310F128RGZ	VQFN (48)	7.00 mm × 7.00 mm
CC1310F128RHB	VQFN (32)	5.00 mm × 5.00 mm
CC1310F128RSM	VQFN (32)	4.00 mm × 4.00 mm
CC1310F64RGZ	VQFN (48)	7.00 mm × 7.00 mm
CC1310F64RHB	VQFN (32)	5.00 mm × 5.00 mm
CC1310F64RSM	VQFN (32)	4.00 mm × 4.00 mm
CC1310F32RGZ	VQFN (48)	7.00 mm × 7.00 mm
CC1310F32RHB	VQFN (32)	5.00 mm × 5.00 mm
CC1310F32RSM	VQFN (32)	4.00 mm × 4.00 mm

(1) For more information, see [Section 9](#).

1.4 Functional Block Diagram

Figure 1-1 shows a block diagram for the CC1310 device.

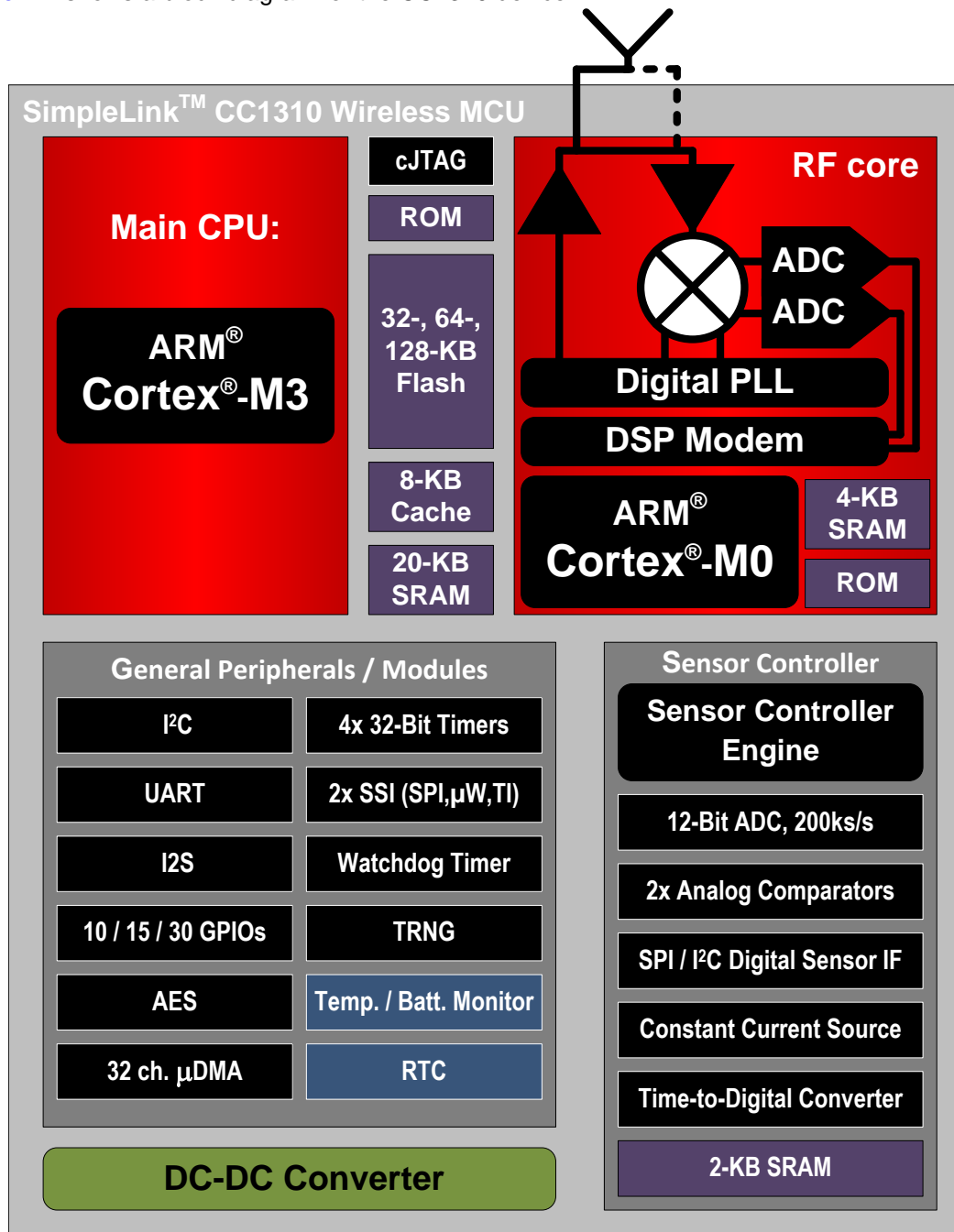

Copyright © 2016, Texas Instruments Incorporated

Figure 1-1. CC1310 Block Diagram

Table of Contents

1	Device Overview	1	5.17	DC Characteristics	23
1.1	Features	1	5.18	Thermal Characteristics	24
1.2	Applications	2	5.19	Timing and Switching Characteristics	24
1.3	Description	2	5.20	Typical Characteristics	28
1.4	Functional Block Diagram	3	6	Detailed Description	32
2	Revision History	5	6.1	Overview	32
3	Device Comparison	6	6.2	Main CPU	32
3.1	Related Products	6	6.3	RF Core	33
4	Terminal Configuration and Functions	7	6.4	Sensor Controller	34
4.1	Pin Diagram – RSM Package	7	6.5	Memory	35
4.2	Signal Descriptions – RSM Package	8	6.6	Debug	35
4.3	Pin Diagram – RHB Package	9	6.7	Power Management	36
4.4	Signal Descriptions – RHB Package	10	6.8	Clock Systems	37
4.5	Pin Diagram – RGZ Package	11	6.9	General Peripherals and Modules	37
4.6	Signal Descriptions – RGZ Package	12	6.10	Voltage Supply Domains	38
5	Specifications	14	6.11	System Architecture	38
5.1	Absolute Maximum Ratings	14	7	Application, Implementation, and Layout	39
5.2	ESD Ratings	14	7.1	TI Design	40
5.3	Recommended Operating Conditions	14	8	Device and Documentation Support	41
5.4	Power Consumption Summary	15	8.1	Device Nomenclature	41
5.5	RF Characteristics	15	8.2	Tools and Software	42
5.6	Receive (RX) Parameters, 861 MHz to 1054 MHz	16	8.3	Documentation Support	43
5.7	Receive (RX) Parameters, 431 MHz to 527 MHz	17	8.4	Texas Instruments Low-Power RF Website	43
5.8	Transmit (TX) Parameters, 861 MHz to 1054 MHz	18	8.5	Low-Power RF eNewsletter	43
5.9	Transmit (TX) Parameters, 431 MHz to 527 MHz	19	8.6	Additional Information	43
5.10	PLL Parameters	20	8.7	Community Resources	44
5.11	ADC Characteristics	20	8.8	Trademarks	44
5.12	Temperature Sensor	21	8.9	Electrostatic Discharge Caution	44
5.13	Battery Monitor	21	8.10	Export Control Notice	44
5.14	Continuous Time Comparator	21	8.11	Glossary	45
5.15	Low-Power Clocked Comparator	22	9	Mechanical, Packaging, and Orderable Information	45
5.16	Programmable Current Source	22	9.1	Packaging Information	45

2 Revision History

NOTE: Page numbers for previous revisions may differ from page numbers in the current version.

Changes from October 28, 2015 to October 27, 2016	Page
• Added 32KB and 64KB to the <i>Features</i> bullet for in-system programmable flash	1
• Changed to the correct pin count in the <i>Features</i> bullet <i>RoHS-Compliant Package</i>	1
• Changed CC1310 Block Diagram	3
• Changed Figure 4-2 , corrected typo in pin name.....	9
• Changed the table note in Absolute Maximum Ratings from: VDDS to: ground.....	14
• Changed ESD ratings for all pins in ESD Ratings	14
• Added OOK modulation power consumption to Section 5.4	15
• Added OOK modulation sensitivity to Section 5.6	16
• Added receive parameters for 431-MHz to 527-MHz band in Receive (RX) Parameters, 431 MHz to 527 MHz	17
• Added transmit parameters for 431-MHz to 527-MHz band in Transmit (TX) Parameters, 431 MHz to 527 MHz	19
• Changed ADC reference voltage to correct value in ADC Characteristics	21
• Added thermal characteristics for RHB and RSM packages	24
• Changed Figure 5-5 by extending the temperature.....	28
• Changed BOD restriction footnote in Table 6-2 —restriction does not apply to die revision B and later.....	36
• Added Voltage Supply Domains	38
• Changed <i>Device Nomenclature</i> image	41

Changes from September 30, 2015 to October 28, 2015	Page
• Added the RSM and RHB packages	7

Changes from August 31, 2015 to September 30, 2015	Page
• Changed device status from: Product Preview to: Production Data	1
• Removed the RSM and RHB packages	7

3 Device Comparison

Table 3-1 lists the device family overview.

Table 3-1. Device Family Overview

DEVICE	PHY SUPPORT	FLASH (KB)	RAM (KB)	GPIOs	PACKAGE SIZE
CC1310F128RGZ	Proprietary, Wireless M-Bus, IEEE 802.15.4g	128	20	30	7 mm x 7 mm
CC1310F64RGZ	Proprietary, Wireless M-Bus, IEEE 802.15.4g	64	16	30	
CC1310F32RGZ	Proprietary, Wireless M-Bus, IEEE 802.15.4g	32	16	30	
CC1310F128RHB	Proprietary, Wireless M-Bus, IEEE 802.15.4g	128	20	15	5 mm x 5 mm
CC1310F64RHB	Proprietary, Wireless M-Bus, IEEE 802.15.4g	64	16	15	
CC1310F32RHB	Proprietary, Wireless M-Bus, IEEE 802.15.4g	32	16	15	
CC1310F128RSM	Proprietary, Wireless M-Bus, IEEE 802.15.4g	128	20	10	4 mm x 4 mm
CC1310F64RSM	Proprietary, Wireless M-Bus, IEEE 802.15.4g	64	16	10	
CC1310F32RSM	Proprietary, Wireless M-Bus, IEEE 802.15.4g	32	16	10	

3.1 Related Products

Wireless Connectivity The wireless connectivity portfolio offers a wide selection of low-power RF solutions suitable for a broad range of application. The offerings range from fully customized solutions to turnkey offerings with precertified hardware and software (protocol).

Sub-1 GHz Long-range, low power wireless connectivity solutions are offered in a wide range of Sub-1 GHz ISM bands.

Companion Products Review products that are frequently purchased or used with this product.

Reference Designs for CC1310 The TI Designs Reference Design Library is a robust reference design library spanning analog, embedded processor, and connectivity. Created by TI experts to help you jump-start your system design, all TI Designs include schematic or block diagrams, BOMs and design files to speed your time to market. Search and download designs at ti.com/tidesigns.

4 Terminal Configuration and Functions

4.1 Pin Diagram – RSM Package

Figure 4-1 shows the RSM pinout diagram.

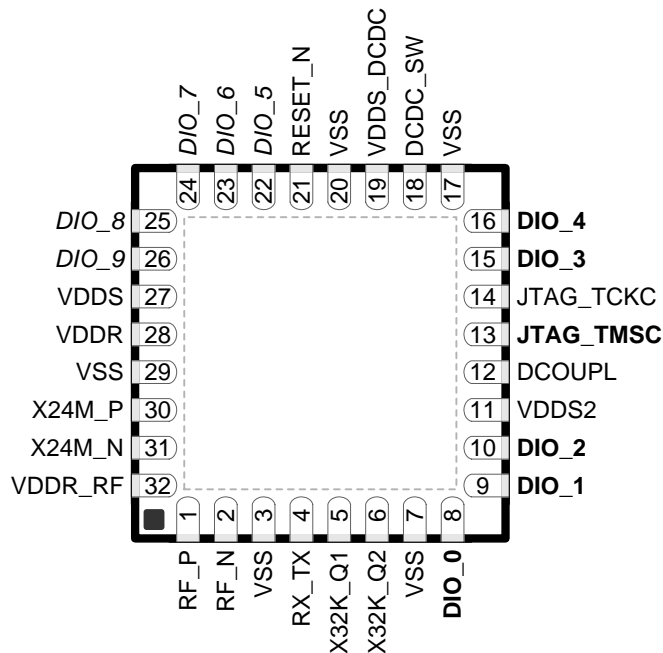

Figure 4-1. RSM (4-mm x 4-mm) Pinout, 0.4-mm Pitch

I/O pins marked in Figure 4-1 in **bold** have high-drive capabilities; they are as follows:

- Pin 8, DIO_0
- Pin 9, DIO_1
- Pin 10, DIO_2
- Pin 13, JTAG_TMSC
- Pin 15, DIO_3
- Pin 16, DIO_4

I/O pins marked in Figure 4-1 in *italics* have analog capabilities; they are as follows:

- Pin 22, DIO_5
- Pin 23, DIO_6
- Pin 24, DIO_7
- Pin 25, DIO_8
- Pin 26, DIO_9

4.2 Signal Descriptions – RSM Package

Table 4-1. Signal Descriptions – RSM Package

PIN		TYPE	DESCRIPTION
NAME	NO.		
DCDC_SW	18	Power	Output from internal DC-DC ⁽¹⁾
DCOUP_L	12	Power	1.27-V regulated digital-supply decoupling capacitor ⁽²⁾
DIO_0	8	Digital I/O	GPIO, Sensor Controller, high-drive capability
DIO_1	9	Digital I/O	GPIO, Sensor Controller, high-drive capability
DIO_2	10	Digital I/O	GPIO, Sensor Controller, high-drive capability
DIO_3	15	Digital I/O	GPIO, high-drive capability, JTAG_TDO
DIO_4	16	Digital I/O	GPIO, high-drive capability, JTAG_TDI
DIO_5	22	Digital or analog I/O	GPIO, Sensor Controller, analog
DIO_6	23	Digital or analog I/O	GPIO, Sensor Controller, analog
DIO_7	24	Digital or analog I/O	GPIO, Sensor Controller, analog
DIO_8	25	Digital or analog I/O	GPIO, Sensor Controller, analog
DIO_9	26	Digital or analog I/O	GPIO, Sensor Controller, analog
EGP	–	Power	Ground; exposed ground pad
JTAG_TM_S_C	13	Digital I/O	JTAG TMS_C
JTAG_TCK_C	14	Digital I/O	JTAG TCK_C
RESET_N	21	Digital input	Reset, active low. No internal pullup.
RF_N	2	RF I/O	Negative RF input signal to LNA during RX Negative RF output signal from PA during TX
RF_P	1	RF I/O	Positive RF input signal to LNA during RX Positive RF output signal from PA during TX
RX_TX	4	RF I/O	Optional bias pin for the RF LNA
VDDS	27	Power	1.8-V to 3.8-V main chip supply ⁽¹⁾
VDDS2	11	Power	1.8-V to 3.8-V GPIO supply ⁽¹⁾
VDDS_DCDC	19	Power	1.8-V to 3.8-V DC-DC supply
VDDR	28	Power	1.7-V to 1.95-V supply, connect to output of internal DC-DC ⁽²⁾⁽³⁾
VDDR_RF	32	Power	1.7-V to 1.95-V supply, connect to output of internal DC-DC ⁽²⁾⁽⁴⁾
VSS	3, 7, 17, 20, 29	Power	Ground
X32K_Q1	5	Analog I/O	32-kHz crystal oscillator pin 1
X32K_Q2	6	Analog I/O	32-kHz crystal oscillator pin 2
X24M_N	30	Analog I/O	24-MHz crystal oscillator pin 1
X24M_P	31	Analog I/O	24-MHz crystal oscillator pin 2

(1) See the technical reference manual listed in [Documentation Support](#) for more details.

(2) Do not supply external circuitry from this pin.

(3) If internal DC-DC is not used, this pin is supplied internally from the main LDO.

(4) If internal DC-DC is not used, this pin must be connected to VDDR for supply from the main LDO.

4.3 Pin Diagram – RHB Package

Figure 4-2 shows the RHB pinout diagram.

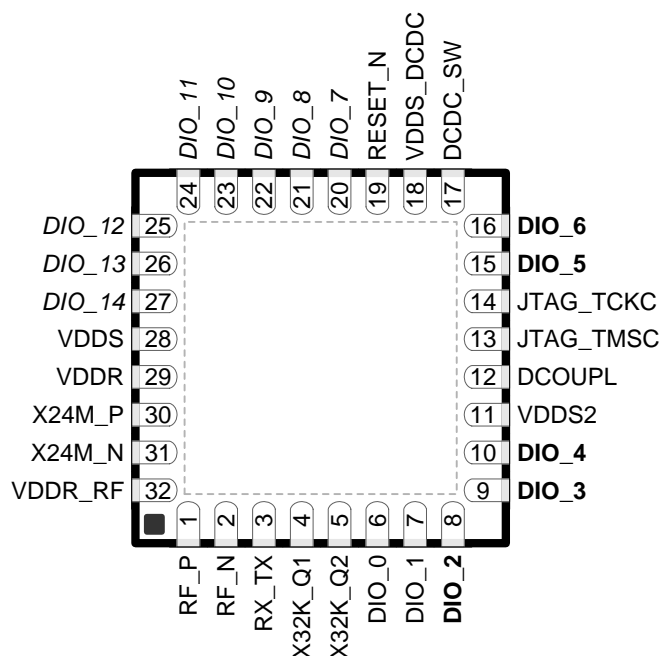

Figure 4-2. RHB (5-mm x 5-mm) Pinout, 0.5-mm Pitch

I/O pins marked in Figure 4-2 in **bold** have high-drive capabilities; they are as follows:

- Pin 8, **DIO_2**
- Pin 9, **DIO_3**
- Pin 10, **DIO_4**
- Pin 15, **DIO_5**
- Pin 16, **DIO_6**

I/O pins marked in Figure 4-2 in *italics* have analog capabilities; they are as follows:

- Pin 20, *DIO_7*
- Pin 21, *DIO_8*
- Pin 22, *DIO_9*
- Pin 23, *DIO_10*
- Pin 24, *DIO_11*
- Pin 25, *DIO_12*
- Pin 26, *DIO_13*
- Pin 27, *DIO_14*

4.4 Signal Descriptions – RHB Package

Table 4-2. Signal Descriptions – RHB Package

PIN		TYPE	DESCRIPTION
NAME	NO.		
DCDC_SW	17	Power	Output from internal DC-DC ⁽¹⁾
DCOUP	12	Power	1.27-V regulated digital-supply decoupling ⁽²⁾
DIO_0	6	Digital I/O	GPIO, Sensor Controller
DIO_1	7	Digital I/O	GPIO, Sensor Controller
DIO_2	8	Digital I/O	GPIO, Sensor Controller, high-drive capability
DIO_3	9	Digital I/O	GPIO, Sensor Controller, high-drive capability
DIO_4	10	Digital I/O	GPIO, Sensor Controller, high-drive capability
DIO_5	15	Digital I/O	GPIO, high-drive capability, JTAG_TDO
DIO_6	16	Digital I/O	GPIO, high-drive capability, JTAG_TDI
DIO_7	20	Digital or analog I/O	GPIO, Sensor Controller, analog
DIO_8	21	Digital or analog I/O	GPIO, Sensor Controller, analog
DIO_9	22	Digital or analog I/O	GPIO, Sensor Controller, analog
DIO_10	23	Digital or analog I/O	GPIO, Sensor Controller, Analog
DIO_11	24	Digital or analog I/O	GPIO, Sensor Controller, analog
DIO_12	25	Digital or analog I/O	GPIO, Sensor Controller, analog
DIO_13	26	Digital or analog I/O	GPIO, Sensor Controller, analog
DIO_14	27	Digital or analog I/O	GPIO, Sensor Controller, analog
EGP	–	Power	Ground; exposed ground pad
JTAG_TMSC	13	Digital I/O	JTAG TMSC, high-drive capability
JTAG_TCKC	14	Digital I/O	JTAG TCKC
RESET_N	19	Digital input	Reset, active low. No internal pullup.
RF_N	2	RF I/O	Negative RF input signal to LNA during RX Negative RF output signal from PA during TX
RF_P	1	RF I/O	Positive RF input signal to LNA during RX Positive RF output signal from PA during TX
RX_TX	3	RF I/O	Optional bias pin for the RF LNA
VDDR	29	Power	1.7-V to 1.95-V supply, connect to output of internal DC-DC ⁽²⁾⁽³⁾
VDDR_RF	32	Power	1.7-V to 1.95-V supply, connect to output of internal DC-DC ⁽²⁾⁽⁴⁾
VDDS	28	Power	1.8-V to 3.8-V main chip supply ⁽¹⁾
VDDS2	11	Power	1.8-V to 3.8-V GPIO supply ⁽¹⁾
VDDS_DCDC	18	Power	1.8-V to 3.8-V DC-DC supply
X24M_N	30	Analog I/O	24-MHz crystal oscillator pin 1
X24M_P	31	Analog I/O	24-MHz crystal oscillator pin 2
X32K_Q1	4	Analog I/O	32-kHz crystal oscillator pin 1
X32K_Q2	5	Analog I/O	32-kHz crystal oscillator pin 2

(1) See the technical reference manual listed in [Documentation Support](#) for more details.

(2) Do not supply external circuitry from this pin.

(3) If internal DC-DC is not used, this pin is supplied internally from the main LDO.

(4) If internal DC-DC is not used, this pin must be connected to VDDR for supply from the main LDO.

4.5 Pin Diagram – RGZ Package

Figure 4-3 shows the RGZ pinout diagram.

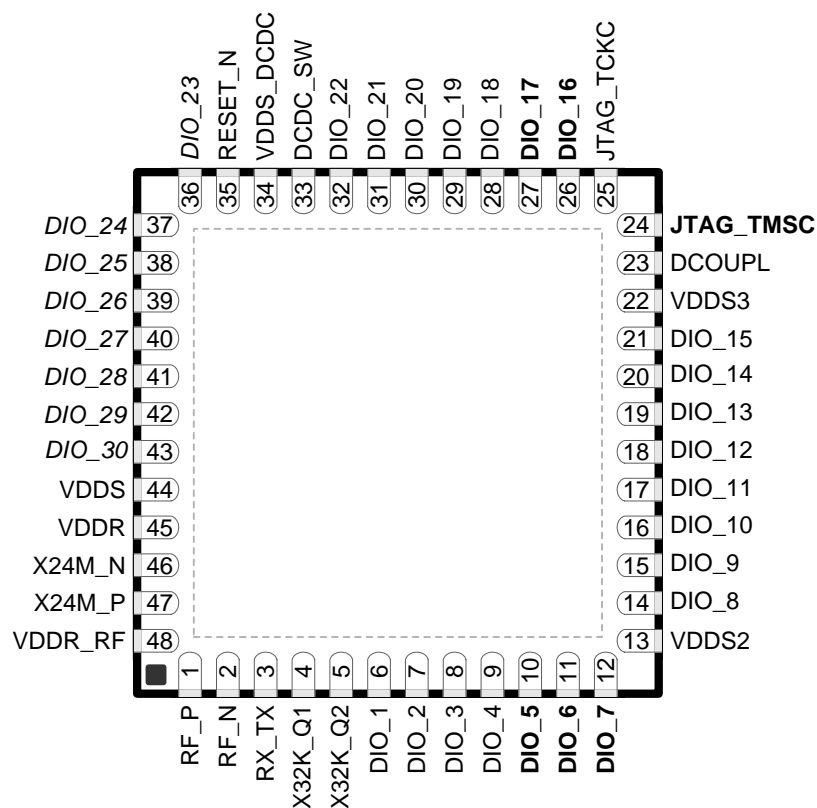

Figure 4-3. RGZ (7-mm x 7-mm) Pinout, 0.5-mm Pitch

I/O pins marked in Figure 4-3 in **bold** have high-drive capabilities; they are as follows:

- Pin 10, DIO_5
- Pin 11, DIO_6
- Pin 12, DIO_7
- Pin 24, JTAG_TMSC
- Pin 26, DIO_16
- Pin 27, DIO_17

I/O pins marked in Figure 4-3 in *italics* have analog capabilities; they are as follows:

- Pin 36, DIO_23
- Pin 37, DIO_24
- Pin 38, DIO_25
- Pin 39, DIO_26
- Pin 40, DIO_27
- Pin 41, DIO_28
- Pin 42, DIO_29
- Pin 43, DIO_30

4.6 Signal Descriptions – RGZ Package

Table 4-3. Signal Descriptions – RGZ Package

PIN		TYPE	DESCRIPTION
NAME	NO.		
DCDC_SW	33	Power	Output from internal DC-DC ⁽¹⁾⁽²⁾
DCOUP_L	23	Power	1.27-V regulated digital-supply (decoupling capacitor) ⁽²⁾
DIO_1	6	Digital I/O	GPIO, Sensor Controller
DIO_2	7	Digital I/O	GPIO, Sensor Controller
DIO_3	8	Digital I/O	GPIO, Sensor Controller
DIO_4	9	Digital I/O	GPIO, Sensor Controller
DIO_5	10	Digital I/O	GPIO, Sensor Controller, high-drive capability
DIO_6	11	Digital I/O	GPIO, Sensor Controller, high-drive capability
DIO_7	12	Digital I/O	GPIO, Sensor Controller, high-drive capability
DIO_8	14	Digital I/O	GPIO
DIO_9	15	Digital I/O	GPIO
DIO_10	16	Digital I/O	GPIO
DIO_11	17	Digital I/O	GPIO
DIO_12	18	Digital I/O	GPIO
DIO_13	19	Digital I/O	GPIO
DIO_14	20	Digital I/O	GPIO
DIO_15	21	Digital I/O	GPIO
DIO_16	26	Digital I/O	GPIO, JTAG_TDO, high-drive capability
DIO_17	27	Digital I/O	GPIO, JTAG_TDI, high-drive capability
DIO_18	28	Digital I/O	GPIO
DIO_19	29	Digital I/O	GPIO
DIO_20	30	Digital I/O	GPIO
DIO_21	31	Digital I/O	GPIO
DIO_22	32	Digital I/O	GPIO
DIO_23	36	Digital or analog I/O	GPIO, Sensor Controller, analog
DIO_24	37	Digital or analog I/O	GPIO, Sensor Controller, analog
DIO_25	38	Digital or analog I/O	GPIO, Sensor Controller, analog
DIO_26	39	Digital or analog I/O	GPIO, Sensor Controller, analog
DIO_27	40	Digital or analog I/O	GPIO, Sensor Controller, analog
DIO_28	41	Digital or analog I/O	GPIO, Sensor Controller, analog
DIO_29	42	Digital or analog I/O	GPIO, Sensor Controller, analog
DIO_30	43	Digital or analog I/O	GPIO, Sensor Controller, analog
EGP	–	Power	Ground; exposed ground pad
JTAG_TM_S_C	24	Digital I/O	JTAG TM_S_C, high-drive capability
JTAG_TCK_C	25	Digital I/O	JTAG TCK_C ⁽³⁾
RESET_N	35	Digital input	Reset, active-low. No internal pullup.
RF_N	2	RF I/O	Negative RF input signal to LNA during RX Negative RF output signal from PA during TX
RF_P	1	RF I/O	Positive RF input signal to LNA during RX Positive RF output signal from PA during TX
VDDR	45	Power	1.7-V to 1.95-V supply, connect to output of internal DC-DC ⁽²⁾⁽⁴⁾

(1) See technical reference manual listed in [Documentation Support](#) for more details.

(2) Do not supply external circuitry from this pin.

(3) For design consideration regarding noise immunity for this pin, see the *JTAG Interface* chapter in the [CC13xx, CC26xx SimpleLink™ Wireless MCU Technical Reference Manual](#).

(4) If internal DC-DC is not used, this pin is supplied internally from the main LDO.

Table 4-3. Signal Descriptions – RGZ Package (continued)

PIN		TYPE	DESCRIPTION
NAME	NO.		
VDDR_RF	48	Power	1.7-V to 1.95-V supply, connect to output of internal DC-DC ⁽²⁾⁽⁵⁾
VDDS	44	Power	1.8-V to 3.8-V main chip supply ⁽¹⁾
VDDS2	13	Power	1.8-V to 3.8-V DIO supply ⁽¹⁾
VDDS3	22	Power	1.8-V to 3.8-V DIO supply ⁽¹⁾
VDDS_DCDC	34	Power	1.8-V to 3.8-V DC-DC supply
X24M_N	46	Analog I/O	24-MHz crystal oscillator pin 1
X24M_P	47	Analog I/O	24-MHz crystal oscillator pin 2
RX_TX	3	RF I/O	Optional bias pin for the RF LNA
X32K_Q1	4	Analog I/O	32-kHz crystal oscillator pin 1
X32K_Q2	5	Analog I/O	32-kHz crystal oscillator pin 2

(5) If internal DC-DC is not used, this pin must be connected to VDDR for supply from the main LDO.

5 Specifications

5.1 Absolute Maximum Ratings

over operating free-air temperature range (unless otherwise noted)⁽¹⁾⁽²⁾

		MIN	MAX	UNIT
V _{DD} ⁽³⁾	Supply voltage	-0.3	4.1	V
	Voltage on any digital pin ⁽⁴⁾	-0.3	V _{DD} + 0.3, max 4.1	V
	Voltage on crystal oscillator pins X32K_Q1, X32K_Q2, X24M_N, and X24M_P	-0.3	V _{DD} R + 0.3, max 2.25	V
V _{in}	Voltage on ADC input	Voltage scaling enabled	V _{DD} S	V
		Voltage scaling disabled, internal reference	1.49	
		Voltage scaling disabled, V _{DD} S as reference	V _{DD} S / 2.9	
Input RF level		10		dBm
T _{stg}	Storage temperature	-40	150	°C

- (1) Stresses beyond those listed under *Absolute Maximum Ratings* may cause permanent damage to the device. These are stress ratings only, and functional operation of the device at these or any other conditions beyond those indicated under *Recommended Operating Conditions* is not implied. Exposure to absolute-maximum-rated conditions for extended periods may affect device reliability.
- (2) All voltage values are with respect to ground, unless otherwise noted.
- (3) V_{DD}S2 and V_{DD}S3 must be at the same potential as V_{DD}S.
- (4) Including analog-capable DIO

5.2 ESD Ratings

			VALUE	UNIT
V _{ESD}	Electrostatic discharge	Human body model (HBM), per ANSI/ESDA/JEDEC JS001 ⁽¹⁾	All pins	±3000
		Charged device model (CDM), per JESD22-C101 ⁽²⁾	All pins	±500

- (1) JEDEC document JEP155 states that 500-V HBM allows safe manufacturing with a standard ESD control process.
- (2) JEDEC document JEP157 states that 250-V CDM allows safe manufacturing with a standard ESD control process.

5.3 Recommended Operating Conditions

over operating free-air temperature range (unless otherwise noted)

		MIN	MAX	UNIT
Ambient temperature		-40	85	°C
Operating supply voltage (V _{DD} S)	For operation in battery-powered and 3.3-V systems (internal DC-DC can be used to minimize power consumption)	1.8	3.8	V
Rising supply voltage slew rate		0	100	mV/μs
Falling supply voltage slew rate		0	20	mV/μs
Falling supply voltage slew rate, with low-power flash setting ⁽¹⁾		3		mV/μs
Positive temperature gradient in standby ⁽²⁾	No limitation for negative temperature gradient, or outside standby mode	5		°C/s

- (1) For small coin-cell batteries, with high worst-case end-of-life equivalent source resistance, a 22-μF V_{DD}S input capacitor must be used to ensure compliance with this slew rate.
- (2) Applications using RCOSC_LF as sleep timer must also consider the drift in frequency caused by a change in temperature (see [32-kHz RC Oscillator \(RCOSC_LF\)](#)).

5.4 Power Consumption Summary

Measured on the Texas Instruments CC1310EM-7XD-7793 reference design unless otherwise noted. $T_c = 25^\circ\text{C}$, $V_{\text{DD5}} = 3.6\text{ V}$ with DC-DC enabled, unless otherwise noted. Using boost mode (increasing VDDR to 1.95 V), will increase currents in this table by 15% (does not apply to TX 14-dBm setting where this current is already included).

PARAMETER		TEST CONDITIONS	TYP	UNIT
I_{core}	Core current consumption	Reset. RESET_N pin asserted or VDDS below power-on-reset threshold	100	nA
		Shutdown. No clocks running, no retention	185	
		Standby. With RTC, CPU, RAM, and (partial) register retention. RCOSC_LF	0.7	μA
		Standby. With RTC, CPU, RAM, and (partial) register retention. XOSC_LF	0.8	
		Idle. Supply Systems and RAM powered.	570	
		Active. MCU running CoreMark at 48 MHz	1.2 mA + 25.5 $\mu\text{A}/\text{MHz}$	
		Active. MCU running CoreMark at 48 MHz	2.5	mA
		Active. MCU running CoreMark at 24 MHz	1.9	
		Radio RX	5.5	mA
		Radio TX, 10-dBm output power, (G)FSK, 868 MHz	13.4	
		Radio TX, OOK modulation, 10-dBm output power, AVG	11.2	mA
		Radio TX, boost mode (VDDR = 1.95 V), 14-dBm output power, (G)FSK, 868 MHz	23.5	
Radio TX, OOK modulation, boost mode (VDDR = 1.95 V), 14-dBm, AVG	14.8	mA		
PERIPHERAL CURRENT CONSUMPTION⁽¹⁾⁽²⁾⁽³⁾				
I_{peri}	Peripheral power domain	Delta current with domain enabled	20	μA
	Serial power domain	Delta current with domain enabled	13	
	RF core	Delta current with power domain enabled, clock enabled, RF core idle	237	
	μDMA	Delta current with clock enabled, module idle	130	
	Timers	Delta current with clock enabled, module idle	113	
	I ² C	Delta current with clock enabled, module idle	12	
	I2S	Delta current with clock enabled, module idle	36	
	SSI	Delta current with clock enabled, module idle	93	
UART	Delta current with clock enabled, module idle	164		

(1) Adds to core current I_{core} for each peripheral unit activated

(2) I_{peri} is not supported in standby or shutdown modes.

(3) Measured at 3.0 V

5.5 RF Characteristics

over operating free-air temperature range (unless otherwise noted)

PARAMETER	MIN	TYP	MAX	UNIT
Frequency bands ⁽¹⁾	(287)		(351)	MHz
	(359)		(439)	
	431		527	
	(718)		(878)	
	861		1054	

(1) For more information, see the [CC1310 SimpleLink Wireless MCU Silicon Errata](#).

5.6 Receive (RX) Parameters, 861 MHz to 1054 MHz

Measured on the Texas Instruments CC1310EM-7XD-7793 reference design with $T_c = 25^\circ\text{C}$, $V_{\text{DDS}} = 3.0\text{ V}$, DC-DC enabled, $f_{\text{RF}} = 868\text{ MHz}$, unless otherwise noted. All measurements are performed at the antenna input with a combined RX and TX path.

PARAMETER	TEST CONDITIONS	MIN	TYP	MAX	UNIT
Data rate			50		kbps
Data rate offset tolerance, IEEE 802.15.4g PHY	50 kbps, GFSK, 25-kHz deviation, 100-kHz RX bandwidth (same modulation format as IEEE 802.15.4g mandatory mode), BER = 10^{-3}		1600		ppm
Data rate step size			1.5		bps
Digital channel filter programmable bandwidth	Using VCO divide by 5 setting	40		4000	kHz
Receiver sensitivity, 50 kbps	50 kbps, GFSK, 25-kHz deviation, 100-kHz RX bandwidth (same modulation format as IEEE 802.15.4g mandatory mode), BER = 10^{-2} 868 MHz and 915 MHz. Measured on CC1310EM-7XD-7793.		-110		dBm
Receiver saturation	50 kbps, GFSK, 25-kHz deviation, 100-kHz RX bandwidth (same modulation format as IEEE 802.15.4g mandatory mode), BER = 10^{-2}		10		dBm
Selectivity, $\pm 200\text{ kHz}$, 50 kbps	Wanted signal 3 dB above sensitivity limit. 50 kbps, GFSK, 25-kHz deviation, 100-kHz RX bandwidth (same modulation format as IEEE 802.15.4g mandatory mode), BER = 10^{-2}		43, 45		dB
Selectivity, $\pm 400\text{ kHz}$, 50 kbps	Wanted signal 3 dB above sensitivity limit. 50 kbps, GFSK, 25-kHz deviation, 100-kHz RX bandwidth (same modulation format as IEEE 802.15.4g mandatory mode), BER = 10^{-2}		48, 53		dB
Blocking $\pm 1\text{ MHz}$, 50 kbps	Wanted signal 3 dB above sensitivity limit. 50 kbps, GFSK, 25-kHz deviation, 100-kHz RX bandwidth (same modulation format as IEEE 802.15.4g mandatory mode), BER = 10^{-2}		59, 62		dB
Blocking $\pm 2\text{ MHz}$, 50 kbps	Wanted signal 3 dB above sensitivity limit. 50 kbps, GFSK, 25-kHz deviation, 100-kHz RX bandwidth (same modulation format as IEEE 802.15.4g mandatory mode), BER = 10^{-2}		64, 65		dB
Blocking $\pm 5\text{ MHz}$, 50 kbps	Wanted signal 3 dB above sensitivity limit. 50 kbps, GFSK, 25-kHz deviation, 100-kHz RX bandwidth (same modulation format as IEEE 802.15.4g mandatory mode), BER = 10^{-2}		67, 68		dB
Blocking $\pm 10\text{ MHz}$, 50 kbps	Wanted signal 3 dB above sensitivity limit. 50 kbps, GFSK, 25-kHz deviation, 100-kHz RX bandwidth (same modulation format as IEEE 802.15.4g mandatory mode), BER = 10^{-2}		76, 76		dB
Spurious emissions 1 GHz to 13 GHz (VCO leakage at 3.5 GHz) and 30 MHz to 1 GHz	Radiated emissions measured according to ETSI EN 300 220		-70		dBm
Image rejection (image compensation enabled, the image compensation is calibrated in production)	Wanted signal 3 dB above sensitivity limit. 50 kbps, GFSK, 25-kHz deviation, 100-kHz RX bandwidth (same modulation format as IEEE 802.15.4g mandatory mode), BER = 10^{-2}		44		dB
RSSI dynamic range	50 kbps, GFSK, 25-kHz deviation, 100-kHz RX bandwidth (same modulation format as IEEE 802.15.4g mandatory mode). Starting from the sensitivity limit. This range will give an accuracy of $\pm 2\text{ dB}$.		95		dB
RSSI accuracy	50 kbps, GFSK, 25-kHz deviation, 100-kHz RX bandwidth (same modulation format as IEEE 802.15.4g mandatory mode). Starting from the sensitivity limit across the given dynamic range.		± 2		dB
Receiver sensitivity, long-range mode 625 bps	10 ksym/s, GFSK, 5-kHz deviation, FEC (half rate), DSSS = 8, 40-kHz RX bandwidth, BER = 10^{-2} . 868 MHz and 915 MHz.		-124		dBm

Receive (RX) Parameters, 861 MHz to 1054 MHz (continued)

Measured on the Texas Instruments CC1310EM-7XD-7793 reference design with $T_c = 25^\circ\text{C}$, $V_{\text{DDS}} = 3.0\text{ V}$, DC-DC enabled, $f_{\text{RF}} = 868\text{ MHz}$, unless otherwise noted. All measurements are performed at the antenna input with a combined RX and TX path.

PARAMETER	TEST CONDITIONS	MIN	TYP	MAX	UNIT
Selectivity, $\pm 100\text{ kHz}$, long-range mode 625 bps	Wanted signal 3 dB above sensitivity limit. 10 ksym/s, GFSK, 5-kHz deviation, FEC (half rate), DSSS = 8, 40-kHz RX bandwidth, BER = 10^{-2}		52, 52		dB
Selectivity, $\pm 200\text{ kHz}$, long-range mode 625 bps	Wanted signal 3 dB above sensitivity limit. 10 ksym/s, GFSK, 5-kHz deviation, FEC (half rate), DSSS = 8, 40-kHz RX bandwidth, BER = 10^{-2}		61, 61		dB
Blocking $\pm 1\text{ MHz}$, long-range mode 625 bps	Wanted signal 3 dB above sensitivity limit. 10 ksym/s, GFSK, 5-kHz deviation, FEC (half rate), DSSS = 8, 40-kHz RX bandwidth, BER = 10^{-2}		73, 77		dB
Blocking $\pm 2\text{ MHz}$, long-range mode 625 bps	Wanted signal 3 dB above sensitivity limit. 10 ksym/s, GFSK, 5-kHz deviation, FEC (half rate), DSSS = 8, 40-kHz RX bandwidth, BER = 10^{-2}		79, 79		dB
Blocking $\pm 10\text{ MHz}$, long-range mode 625 bps	Wanted signal 3 dB above sensitivity limit. 10 ksym/s, GFSK, 5-kHz deviation, FEC (half rate), DSSS = 8, 40-kHz RX bandwidth, BER = 10^{-2}		91, 91		dB
Receiver sensitivity, OOK 4.8 kbps	4.8 kbps, OOK, 40-kHz RX bandwidth, BER = 10^{-2} 868 MHz and 915 MHz		-115		dBm

5.7 Receive (RX) Parameters, 431 MHz to 527 MHz

Measured on the Texas Instruments CC1310EM-7XD-4251 reference design with $T_c = 25^\circ\text{C}$, $V_{\text{DDS}} = 3.0\text{ V}$, DC-DC enabled, $f_{\text{RF}} = 433.92\text{ MHz}$, unless otherwise noted. All measurements are performed at the antenna input with a combined RX and TX path. This frequency band is supported on die Revision B and later.

PARAMETER	TEST CONDITIONS	MIN	TYP	MAX	UNIT
Receiver sensitivity, 50 kbps	50 kbps, GFSK, 25-kHz deviation, 100-kHz RX bandwidth (same modulation format as IEEE 802.15.4g mandatory mode), BER = 10^{-2}		-110		dBm
Receiver saturation	50 kbps, GFSK, 25-kHz deviation, 100-kHz RX bandwidth (same modulation format as IEEE 802.15.4g mandatory mode), BER = 10^{-2}		10		dBm
Selectivity, $\pm 200\text{ kHz}$, 50 kbps	Wanted signal 3 dB above sensitivity limit. 50 kbps, GFSK, 25-kHz deviation, 100-kHz RX bandwidth (same modulation format as IEEE 802.15.4g mandatory mode), BER = 10^{-2}		40, 42		dB
Selectivity, $\pm 400\text{ kHz}$, 50 kbps	Wanted signal 3 dB above sensitivity limit. 50 kbps, GFSK, 25-kHz deviation, 100-kHz RX bandwidth (same modulation format as IEEE 802.15.4g mandatory mode), BER = 10^{-2}		42, 50		dB
Blocking $\pm 1\text{ MHz}$, 50 kbps	Wanted signal 3 dB above sensitivity limit. 50 kbps, GFSK, 25-kHz deviation, 100-kHz RX bandwidth (same modulation format as IEEE 802.15.4g mandatory mode), BER = 10^{-2}		53, 58		dB
Blocking $\pm 2\text{ MHz}$, 50 kbps	Wanted signal 3 dB above sensitivity limit. 50 kbps, GFSK, 25-kHz deviation, 100-kHz RX bandwidth (same modulation format as IEEE 802.15.4g mandatory mode), BER = 10^{-2}		59, 60		dB
Blocking $\pm 10\text{ MHz}$, 50 kbps	Wanted signal 3 dB above sensitivity limit. 50 kbps, GFSK, 25-kHz deviation, 100-kHz RX bandwidth (same modulation format as IEEE 802.15.4g mandatory mode), BER = 10^{-2}		74, 74		dB
Spurious emissions 1 GHz to 13 GHz (VCO leakage at 3.5 GHz) and 30 MHz to 1 GHz	Radiated emissions measured according to ETSI EN 300 220		-74		dBm
Image rejection (image compensation enabled, the image compensation is calibrated in production)	Wanted signal 3 dB above sensitivity limit. 50 kbps, GFSK, 25-kHz deviation, 100-kHz RX bandwidth (same modulation format as IEEE 802.15.4g mandatory mode), BER = 10^{-2}		43		dB

Receive (RX) Parameters, 431 MHz to 527 MHz (continued)

Measured on the Texas Instruments CC1310EM-7XD-4251 reference design with $T_c = 25^\circ\text{C}$, $V_{\text{DDS}} = 3.0\text{ V}$, DC-DC enabled, $f_{\text{RF}} = 433.92\text{ MHz}$, unless otherwise noted. All measurements are performed at the antenna input with a combined RX and TX path. This frequency band is supported on die Revision B and later.

PARAMETER	TEST CONDITIONS	MIN	TYP	MAX	UNIT
Receiver sensitivity, long-range mode 625 bps	10 ksym/s, GFSK, 5-kHz deviation, FEC (half rate), DSSS = 8, 40-kHz RX bandwidth, BER = 10^{-2} . 868 MHz and 915 MHz.		-124		dBm
Selectivity, $\pm 100\text{ kHz}$, long-range mode 625 bps	Wanted signal 3 dB above sensitivity limit. 10 ksym/s, GFSK, 5-kHz deviation, FEC (half rate), DSSS = 8, 40-kHz RX bandwidth, BER = 10^{-2}		57, 58		dB
Selectivity, $\pm 200\text{ kHz}$, long-range mode 625 bps	Wanted signal 3 dB above sensitivity limit. 10 ksym/s, GFSK, 5-kHz deviation, FEC (half rate), DSSS = 8, 40-kHz RX bandwidth, BER = 10^{-2}		56, 60		dB
Blocking $\pm 1\text{ MHz}$, long-range mode 625 bps	Wanted signal 3 dB above sensitivity limit. 10 ksym/s, GFSK, 5-kHz deviation, FEC (half rate), DSSS = 8, 40-kHz RX bandwidth, BER = 10^{-2}		68, 73		dB
Blocking $\pm 2\text{ MHz}$, long-range mode 625 bps	Wanted signal 3 dB above sensitivity limit. 10 ksym/s, GFSK, 5-kHz deviation, FEC (half rate), DSSS = 8, 40-kHz RX bandwidth, BER = 10^{-2}		74, 74		dB
Blocking $\pm 10\text{ MHz}$, long-range mode 625 bps	Wanted signal 3 dB above sensitivity limit. 10 ksym/s, GFSK, 5-kHz deviation, FEC (half rate), DSSS = 8, 40-kHz RX bandwidth, BER = 10^{-2}		88, 89		dB
Image rejection (image compensation enabled, the image compensation is calibrated in production), long-range mode 625 bps	Wanted signal 3 dB above sensitivity limit. 10 ksym/s, GFSK, 5-kHz deviation, FEC (half rate), DSSS = 8, 40-kHz RX bandwidth, BER = 10^{-2}		55		dB

5.8 Transmit (TX) Parameters, 861 MHz to 1054 MHz

Measured on the Texas Instruments CC1310EM-7XD-7793 reference design with $T_c = 25^\circ\text{C}$, $V_{\text{DDS}} = 3.0\text{ V}$, DC-DC enabled, $f_{\text{RF}} = 868\text{ MHz}$, unless otherwise noted. All measurements are performed at the antenna input with a combined RX and TX path.

PARAMETER	TEST CONDITIONS	MIN	TYP	MAX	UNIT
Maximum output power, boost mode	VDDR = 1.95 V Minimum VDDS for boost mode is 2.1 V 868 MHz and 915 MHz		14		dBm
Maximum output power	868 MHz and 915 MHz		12		dBm
Output power programmable range			24		dB
Output power variation	Tested at +10-dBm setting		± 0.9		dB
Output power variation, boost mode	+14 dBm		± 0.5		dB
Spurious emissions (excluding harmonics) ⁽¹⁾	30 MHz to 1 GHz	Transmitting +14 dBm ETSI restricted bands		<-59	dBm
		Transmitting +14 dBm outside ETSI restricted bands		<-51	
	1 GHz to 12.75 GHz	Transmitting +14 dBm measured in 1-MHz bandwidth (ETSI)		<-37	
Harmonics	Second harmonic	Transmitting +14 dBm, conducted 868 MHz, 915 MHz		-52, -55	dBm
	Third harmonic	Transmitting +14 dBm, conducted 868 MHz, 915 MHz		-58, -55	
	Fourth harmonic	Transmitting +14 dBm, conducted 868 MHz, 915 MHz		-56, -56	

(1) Suitable for systems targeting compliance with EN 300 220, EN 54-25, EN 303 204, FCC CFR47 Part 15, ARIB STD-T108.

Transmit (TX) Parameters, 861 MHz to 1054 MHz (continued)

Measured on the Texas Instruments CC1310EM-7XD-7793 reference design with $T_c = 25^\circ\text{C}$, $V_{\text{DDS}} = 3.0\text{ V}$, DC-DC enabled, $f_{\text{RF}} = 868\text{ MHz}$, unless otherwise noted. All measurements are performed at the antenna input with a combined RX and TX path.

PARAMETER		TEST CONDITIONS	MIN	TYP	MAX	UNIT
Spurious emissions out-of-band, 915 MHz ⁽¹⁾	30 MHz to 88 MHz (within FCC restricted bands)	Transmitting +14 dBm, conducted		<-66		dBm
	88 MHz to 216 MHz (within FCC restricted bands)	Transmitting +14 dBm, conducted		<-65		
	216 MHz to 960 MHz (within FCC restricted bands)	Transmitting +14 dBm, conducted		<-65		
	960 MHz to 2390 MHz and above 2483.5 MHz (within FCC restricted band)	Transmitting +14 dBm, conducted		<-52		
	1 GHz to 12.75 GHz (outside FCC restricted bands)	Transmitting +14 dBm, conducted		<-43		
Spurious emissions out-of-band, 920.6 MHz ⁽¹⁾	Below 710 MHz (ARIB T-108)	Transmitting +14 dBm, conducted		<-50		dBm
	710 MHz to 900 MHz (ARIB T-108)	Transmitting +14 dBm, conducted		<-60		
	900 MHz to 915 MHz (ARIB T-108)	Transmitting +14 dBm, conducted		<-57		
	930 MHz to 1000 MHz (ARIB T-108)	Transmitting +14 dBm, conducted		<-57		
	1000 MHz to 1215 MHz (ARIB T-108)	Transmitting +14 dBm, conducted		<-59		
	Above 1215 MHz (ARIB T-108)	Transmitting +14 dBm, conducted		<-45		

5.9 Transmit (TX) Parameters, 431 MHz to 527 MHz

Measured on the Texas Instruments CC1310EM-7XD-4251 reference design with $T_c = 25^\circ\text{C}$, $V_{\text{DDS}} = 3.0\text{ V}$, DC-DC enabled, $f_{\text{RF}} = 433.92\text{ MHz}$, unless otherwise noted. All measurements are performed at the antenna input with a combined RX and TX path. This frequency band is supported on die Revision B and later.

PARAMETER		TEST CONDITIONS	MIN	TYP	MAX	UNIT
Maximum output power, boost mode		VDDR = 1.95 V Minimum VDDS for boost mode is 2.1 V		15		dBm
Spurious emissions (excluding harmonics) ⁽¹⁾	30 MHz to 1 GHz	Transmitting +10 dBm, 433 MHz Inside ETSI restricted bands		<-63		dBm
		Transmitting +10 dBm, 433 MHz Outside ETSI restricted bands		<-39		
	1 GHz to 12.75 GHz	Transmitting +10 dBm, 433 MHz Outside ETSI restricted bands, measured in 1-MHz bandwidth (ETSI)		<-52		
		Transmitting +10 dBm, 433 MHz Inside ETSI restricted bands, measured in 1-MHz bandwidth (ETSI)		<-58		

(1) Suitable for systems targeting compliance with EN 300 220, EN 54-25, EN 303 204, FCC CFR47 Part 15, ARIB STD-T108.

5.10 PLL Parameters

Measured on the Texas Instruments CC1310EM-7XD-7793 reference design with $T_c = 25^\circ\text{C}$, $V_{\text{DDS}} = 3.0\text{ V}$

PARAMETER	TEST CONDITIONS	MIN	TYP	MAX	UNIT
Phase noise in the 868-MHz band	±100-kHz offset		-101		dBc/Hz
	±200-kHz offset		-108		
	±400-kHz offset		-115		
	±1000-kHz offset		-124		
	±2000-kHz offset		-131		
	±10000-kHz offset		-140		
Phase noise in the 915-MHz band	±100-kHz offset		-98		dBc/Hz
	±200-kHz offset		-106		
	±400-kHz offset		-114		
	±1000-kHz offset		-122		
	±2000-kHz offset		-130		
	±10000-kHz offset		-140		

5.11 ADC Characteristics

$T_c = 25^\circ\text{C}$, $V_{\text{DDS}} = 3.0\text{ V}$, DC-DC disabled. Input voltage scaling enabled, unless otherwise noted.⁽¹⁾

PARAMETER	TEST CONDITIONS	MIN	TYP	MAX	UNIT
Input voltage range		0		V_{DDS}	V
Resolution			12		Bits
Sample rate				200	ksamples/s
Offset	Internal 4.3-V equivalent reference ⁽²⁾		2.1		LSB
Gain error	Internal 4.3-V equivalent reference ⁽²⁾		-0.14		LSB
DNL ⁽³⁾	Differential nonlinearity		>-1		LSB
INL ⁽⁴⁾	Integral nonlinearity		±2		LSB
ENOB	Effective number of bits	Internal 4.3-V equivalent reference ⁽²⁾ , 200 ksamples/s, 9.6-kHz input tone	10.0		Bits
		V_{DDS} as reference, 200 ksamples/s, 9.6-kHz input tone	10.2		
		Internal 1.44-V reference, voltage scaling disabled, 32 samples average, 200 ksamples/s, 300-Hz input tone	11.1		
THD	Total harmonic distortion	Internal 4.3-V equivalent reference ⁽²⁾ , 200 ksamples/s, 9.6-kHz input tone	-65		dB
		V_{DDS} as reference, 200 ksamples/s, 9.6-kHz input tone	-72		
		Internal 1.44-V reference, voltage scaling disabled, 32 samples average, 200 ksamples/s, 300-Hz input tone	-75		
SINAD and SNDR	Signal-to-noise and distortion ratio	Internal 4.3-V equivalent reference ⁽²⁾ , 200 ksamples/s, 9.6-kHz input tone	62		dB
		V_{DDS} as reference, 200 ksamples/s, 9.6-kHz input tone	63		
		Internal 1.44-V reference, voltage scaling disabled, 32 samples average, 200 ksamples/s, 300-Hz input tone	69		
SFDR	Spurious-free dynamic range	Internal 4.3-V equivalent reference ⁽²⁾ , 200 ksamples/s, 9.6-kHz input tone	74		dB
		V_{DDS} as reference, 200 ksamples/s, 9.6-kHz input tone	75		
		Internal 1.44-V reference, voltage scaling disabled, 32 samples average, 200 ksamples/s, 300-Hz input tone	75		
Conversion time	Including sampling time		5		μs
Current consumption	Internal 4.3-V equivalent reference ⁽²⁾		0.66		mA
Current consumption	V_{DDS} as reference		0.75		mA

(1) Using IEEE Std 1241™ 2010 for terminology and test methods.

(2) Input signal scaled down internally before conversion, as if voltage range was 0 to 4.3 V. Applied voltage must be within the absolute maximum ratings (see Section 5.1) at all times.

(3) No missing codes. Positive DNL typically varies from 0.3 to 1.7, depending on the device (see Figure 5-7).

(4) For a typical example, see Figure 5-6.

ADC Characteristics (continued)

$T_c = 25^\circ\text{C}$, $V_{\text{DDS}} = 3.0\text{ V}$, DC-DC disabled. Input voltage scaling enabled, unless otherwise noted.⁽¹⁾

PARAMETER	TEST CONDITIONS	MIN	TYP	MAX	UNIT
Reference voltage	Equivalent fixed internal reference (voltage scaling enabled) ⁽²⁾ For best accuracy, the ADC conversion should be initiated through the TI-RTOS API in order to include the gain/offset compensation factors stored in FCFG1.		4.3		V
Reference voltage	Fixed internal reference (input voltage scaling disabled). ⁽²⁾ For best accuracy, the ADC conversion should be initiated through the TI-RTOS API in order to include the gain/offset compensation factors stored in FCFG1. This value is derived from the scaled value (4.3 V) as follows: $V_{\text{ref}} = 4.3\text{ V} \times 1408 / 4095$		1.48		V
Reference voltage	VDDS as reference (Also known as RELATIVE) (input voltage scaling enabled)		VDDS		V
Reference voltage	VDDS as reference (Also known as RELATIVE) (input voltage scaling disabled)		VDDS / 2.82		V
Input Impedance	200 ksamples/s, voltage scaling enabled. Capacitive input, input impedance depends on sampling frequency and sampling time		>1		M Ω

5.12 Temperature Sensor

Measured on the Texas Instruments CC1310EM-7XD-7793 reference design with $T_c = 25^\circ\text{C}$, $V_{\text{DDS}} = 3.0\text{ V}$, unless otherwise noted.

PARAMETER	TEST CONDITIONS	MIN	TYP	MAX	UNIT
Resolution			4		$^\circ\text{C}$
Range		-40		85	$^\circ\text{C}$
Accuracy			± 5		$^\circ\text{C}$
Supply voltage coefficient ⁽¹⁾			3.2		$^\circ\text{C/V}$

(1) Automatically compensated when using supplied driver libraries.

5.13 Battery Monitor

Measured on the Texas Instruments CC1310EM-7XD-7793 reference design with $T_c = 25^\circ\text{C}$, $V_{\text{DDS}} = 3.0\text{ V}$, unless otherwise noted.

PARAMETER	TEST CONDITIONS	MIN	TYP	MAX	UNIT
Resolution			50		mV
Range		1.8		3.8	V
Accuracy			13		mV

5.14 Continuous Time Comparator

$T_c = 25^\circ\text{C}$, $V_{\text{DDS}} = 3.0\text{ V}$, unless otherwise noted.

PARAMETER	TEST CONDITIONS	MIN	TYP	MAX	UNIT
Input voltage range		0		V_{DDS}	V
External reference voltage		0		V_{DDS}	V
Internal reference voltage	DCOUPPL as reference		1.27		V
Offset			3		mV
Hysteresis			<2		mV
Decision time	Step from -10 mV to 10 mV		0.72		μs
Current consumption when enabled ⁽¹⁾			8.6		μA

(1) Additionally, the bias module must be enabled when running in standby mode.

5.15 Low-Power Clocked Comparator

$T_c = 25^\circ\text{C}$, $V_{\text{DDS}} = 3.0\text{ V}$, unless otherwise noted.

PARAMETER	TEST CONDITIONS	MIN	TYP	MAX	UNIT
Input voltage range		0		V_{DDS}	V
Clock frequency			32.8		kHz
Internal reference voltage, $V_{\text{DDS}} / 2$			1.49 to 1.51		V
Internal reference voltage, $V_{\text{DDS}} / 3$			1.01 to 1.03		V
Internal reference voltage, $V_{\text{DDS}} / 4$			0.78 to 0.79		V
Internal reference voltage, $\text{DCOUP} / 1$			1.25 to 1.28		V
Internal reference voltage, $\text{DCOUP} / 2$			0.63 to 0.65		V
Internal reference voltage, $\text{DCOUP} / 3$			0.42 to 0.44		V
Internal reference voltage, $\text{DCOUP} / 4$			0.33 to 0.34		V
Offset			<2		mV
Hysteresis			<5		mV
Decision time	Step from -50 mV to 50 mV		1		clock-cycle
Current consumption when enabled			362		nA

5.16 Programmable Current Source

$T_c = 25^\circ\text{C}$, $V_{\text{DDS}} = 3.0\text{ V}$, unless otherwise noted.

PARAMETER	TEST CONDITIONS	MIN	TYP	MAX	UNIT
Current source programmable output range			0.25 to 20		μA
Resolution			0.25		μA
Current consumption ⁽¹⁾	Including current source at maximum programmable output		23		μA

(1) Additionally, the bias module must be enabled when running in standby mode.

5.17 DC Characteristics

PARAMETER	TEST CONDITIONS	MIN	TYP	MAX	UNIT
$T_A = 25^\circ\text{C}$, $V_{\text{DDS}} = 1.8\text{ V}$					
GPIO VOH at 8-mA load	IOCURR = 2, high-drive GPIOs only	1.32	1.54		V
GPIO VOL at 8-mA load	IOCURR = 2, high-drive GPIOs only		0.26	0.32	V
GPIO VOH at 4-mA load	IOCURR = 1	1.32	1.58		V
GPIO VOL at 4-mA load	IOCURR = 1		0.21	0.32	V
GPIO pullup current	Input mode, pullup enabled, $V_{\text{pad}} = 0\text{ V}$		71.7		μA
GPIO pulldown current	Input mode, pulldown enabled, $V_{\text{pad}} = V_{\text{DDS}}$		21.1		μA
GPIO high/low input transition, no hysteresis	IH = 0, transition between reading 0 and reading 1		0.88		V
GPIO low-to-high input transition, with hysteresis	IH = 1, transition voltage for input read as 0 \rightarrow 1		1.07		V
GPIO high-to-low input transition, with hysteresis	IH = 1, transition voltage for input read as 1 \rightarrow 0		0.74		V
GPIO input hysteresis	IH = 1, difference between 0 \rightarrow 1 and 1 \rightarrow 0 voltage transition points		0.33		V
$T_A = 25^\circ\text{C}$, $V_{\text{DDS}} = 3.0\text{ V}$					
GPIO VOH at 8-mA load	IOCURR = 2, high-drive GPIOs only		2.68		V
GPIO VOL at 8-mA load	IOCURR = 2, high-drive GPIOs only		0.33		V
GPIO VOH at 4-mA load	IOCURR = 1		2.72		V
GPIO VOL at 4-mA load	IOCURR = 1		0.28		V

DC Characteristics (continued)

PARAMETER	TEST CONDITIONS	MIN	TYP	MAX	UNIT
T_A = 25°C, V_{DDs} = 3.8 V					
GPIO pullup current	Input mode, pullup enabled, V _{pad} = 0 V		277		μA
GPIO pulldown current	Input mode, pulldown enabled, V _{pad} = V _{DDs}		113		μA
GPIO high/low input transition, no hysteresis	IH = 0, transition between reading 0 and reading 1		1.67		V
GPIO low-to-high input transition, with hysteresis	IH = 1, transition voltage for input read as 0 → 1		1.94		V
GPIO high-to-low input transition, with hysteresis	IH = 1, transition voltage for input read as 1 → 0		1.54		V
GPIO input hysteresis	IH = 1, difference between 0 → 1 and 1 → 0 voltage transition points		0.4		V
VIH	Lowest GPIO input voltage reliably interpreted as a <i>High</i>			0.8	V _{DDs} ⁽¹⁾
VIL	Highest GPIO input voltage reliably interpreted as a <i>Low</i>	0.2			V _{DDs} ⁽¹⁾

(1) Each GPIO is referenced to a specific V_{DDs} pin. See the technical reference manual listed in [Section 8.3](#) for more details.

5.18 Thermal Characteristics

THERMAL METRIC ⁽¹⁾	CC1310			UNIT ⁽²⁾
	RSM (VQFN)	RHB (VQFN)	RGZ (VQFN)	
	32 PINS	32 PINS	48 PINS	
R _{θJA} Junction-to-ambient thermal resistance	36.9	32.8	29.6	°C/W
R _{θJC(top)} Junction-to-case (top) thermal resistance	30.3	24.0	15.7	°C/W
R _{θJB} Junction-to-board thermal resistance	7.6	6.8	6.2	°C/W
Ψ _{JT} Junction-to-top characterization parameter	0.4	0.3	0.3	°C/W
Ψ _{JB} Junction-to-board characterization parameter	7.4	6.8	6.2	°C/W
R _{θJC(bot)} Junction-to-case (bottom) thermal resistance	2.1	1.9	1.9	°C/W

(1) For more information about traditional and new thermal metrics, see [Semiconductor and IC Package Thermal Metrics](#).

(2) °C/W = degrees Celsius per watt.

5.19 Timing and Switching Characteristics

5.19.1 Reset Timing

	MIN	TYP	MAX	UNIT
RESET_N low duration	1			μs

5.19.2 Switching Characteristics: Wakeup and Timing

Measured on the Texas Instruments CC1310EM-7XD-7793 reference design with T_c = 25°C, V_{DDs} = 3.0 V, unless otherwise noted. The times listed here do not include RTOS overhead.

PARAMETER	TEST CONDITIONS	MIN	TYP	MAX	UNIT
MCU, Idle → Active			14		μs
MCU, Standby → Active			174		μs
MCU, Shutdown → Active			1097		μs

5.19.3 Clock Specifications

5.19.3.1 24-MHz Crystal Oscillator (XOSC_HF)

Measured on the Texas Instruments CC1310EM-7XD-7793 reference design with $T_c = 25^\circ\text{C}$, $V_{\text{DDS}} = 3.0\text{ V}$, unless otherwise noted.⁽¹⁾

	MIN	TYP	MAX	UNIT
Crystal frequency		24		MHz
ESR equivalent series resistance		20	60	Ω
L_M motional inductance, relates to the load capacitance that is used for the crystal (C_L in Farads)		$< 1.6 \times 10^{-24} / C_L^2$		H
C_L crystal load capacitance	5		9	pF
Start-up time ⁽²⁾		150		μs

(1) Probing or otherwise stopping the crystal while the DC-DC converter is enabled may cause permanent damage to the device.

(2) The crystal start-up time is low because it is *kick-started* by using the RCOSC_HF oscillator (temperature and aging compensated) that is running at the same frequency.

5.19.3.2 32.768-kHz Crystal Oscillator (XOSC_LF)

Measured on the Texas Instruments CC1310EM-7XD-7793 reference design with $T_c = 25^\circ\text{C}$, $V_{\text{DDS}} = 3.0\text{ V}$, unless otherwise noted.⁽¹⁾

	MIN	TYP	MAX	UNIT
Crystal frequency		32.768		kHz
ESR equivalent series resistance		30	100	k Ω
Crystal load capacitance (C_L)	6		12	pF

(1) Probing or otherwise stopping the crystal while the DC-DC converter is enabled may cause permanent damage to the device.

5.19.3.3 48-MHz RC Oscillator (RCOSC_HF)

Measured on the Texas Instruments CC1310EM-7XD-7793 reference design with $T_c = 25^\circ\text{C}$, $V_{\text{DDS}} = 3.0\text{ V}$, unless otherwise noted.

	MIN	TYP	MAX	UNIT
Frequency		48		MHz
Uncalibrated frequency accuracy		$\pm 1\%$		
Calibrated frequency accuracy ⁽¹⁾		$\pm 0.25\%$		
Startup time		5		μs

(1) Accuracy relative to the calibration source (XOSC_HF)

5.19.3.4 32-kHz RC Oscillator (RCOSC_LF)

Measured on the Texas Instruments CC1310EM-7XD-7793 reference design with $T_c = 25^\circ\text{C}$, $V_{\text{DDS}} = 3.0\text{ V}$, unless otherwise noted.

	MIN	TYP	MAX	UNIT
Calibrated frequency ⁽¹⁾		32.768		kHz
Temperature coefficient		50		ppm/ $^\circ\text{C}$

(1) The frequency accuracy of the Real Time Clock (RTC) is not directly dependent on the frequency accuracy of the 32-kHz RC Oscillator. The RTC can be calibrated to an accuracy within ± 500 ppm of 32.768 kHz by measuring the frequency error of RCOSC_LF relative to XOSC_HF and compensating the RTC tick speed.

5.19.4 Flash Memory Characteristics

$T_c = 25^\circ\text{C}$, $V_{\text{DD5}} = 3.0\text{ V}$, unless otherwise noted.

PARAMETER	TEST CONDITIONS	MIN	TYP	MAX	UNIT
Supported flash erase cycles before failure		100			k Cycles
Flash page or sector erase current	Average delta current		12.6		mA
Flash page or sector erase time ⁽¹⁾			8		ms
Flash page or sector size			4		KB
Flash write current	Average delta current, 4 bytes at a time		8.15		mA
Flash write time ⁽¹⁾	4 bytes at a time		8		μs

(1) This number is dependent on flash aging and increases over time and erase cycles.

5.19.5 Synchronous Serial Interface (SSI) Characteristics

$T_c = 25^\circ\text{C}$, $V_{\text{DD5}} = 3.0\text{ V}$, unless otherwise noted.

PARAMETER NO.	PARAMETER	MIN	TYP	MAX	UNIT
S1	$t_{\text{clk_per}}$ SSIClk cycle time	12		65024	system clocks
S2 ⁽¹⁾	$t_{\text{clk_high}}$ SSIClk high time		$0.5 \times t_{\text{clk_per}}$		
S3 ⁽¹⁾	$t_{\text{clk_low}}$ SSIClk low time		$0.5 \times t_{\text{clk_per}}$		

(1) See the SSI timing diagrams, [Figure 5-1](#), [Figure 5-2](#), and [Figure 5-3](#).

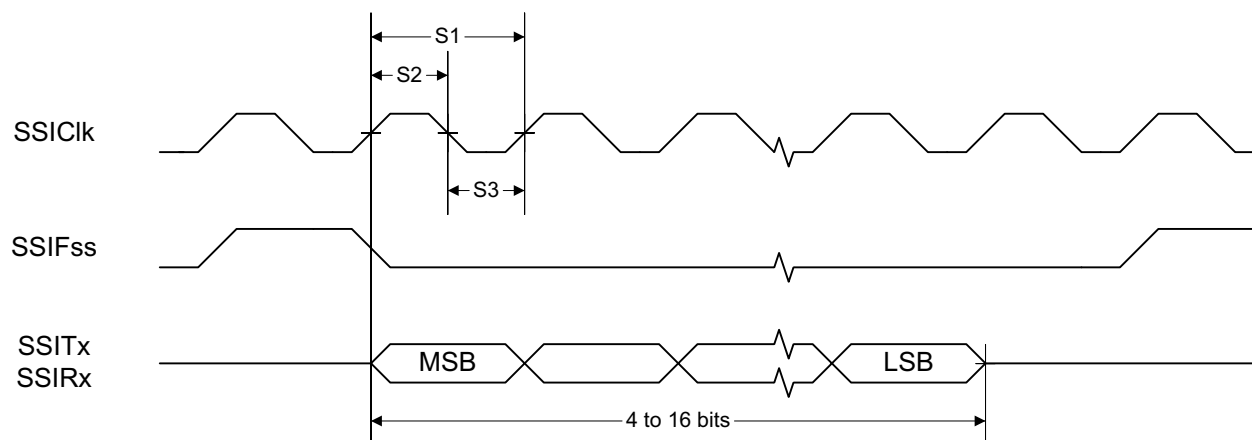

Figure 5-1. SSI Timing for TI Frame Format (FRF = 01), Single Transfer Timing Measurement

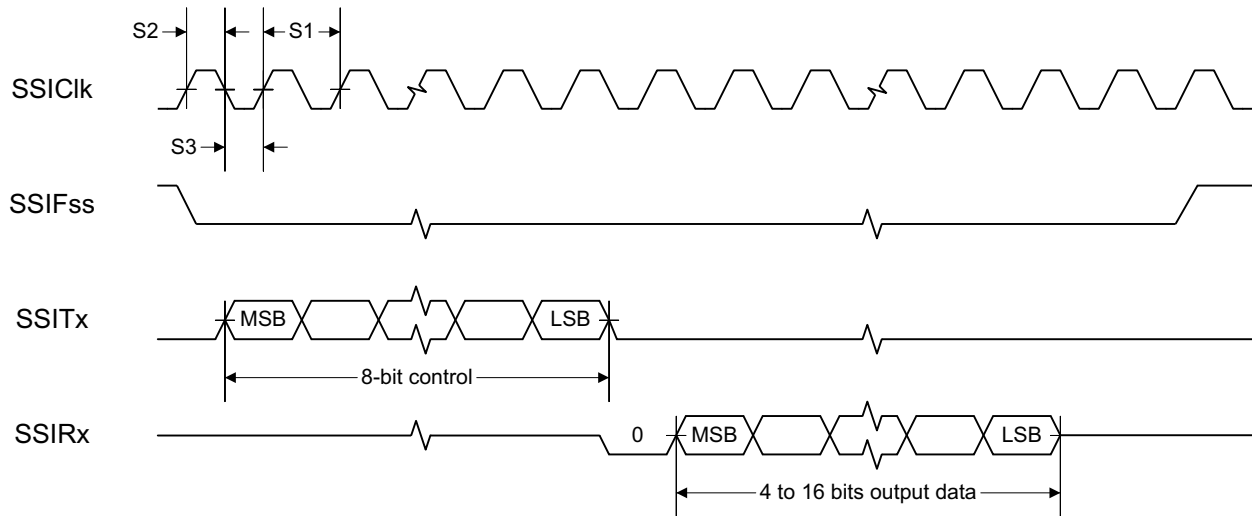

Figure 5-2. SSI Timing for MICROWIRE Frame Format (FRF = 10), Single Transfer

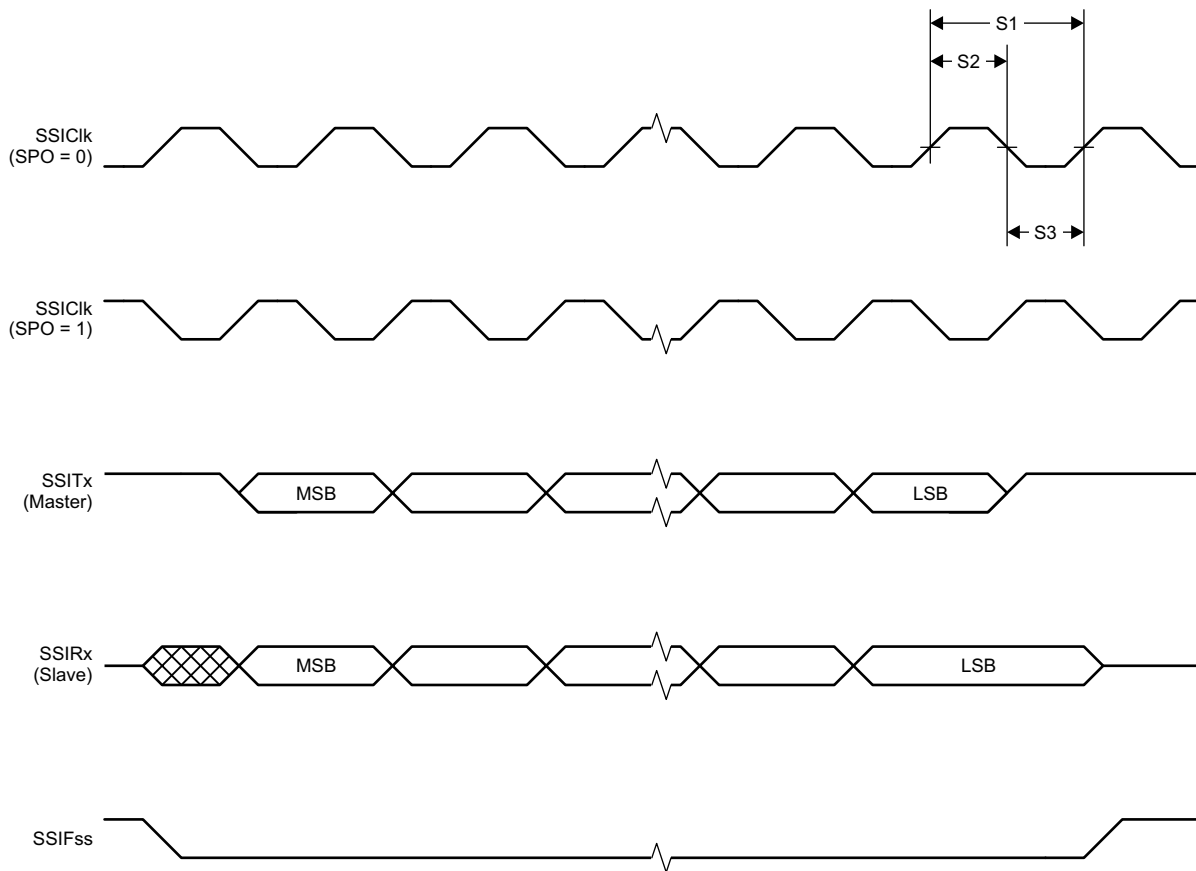

Figure 5-3. SSI Timing for SPI Frame Format (FRF = 00), With SPH = 1

5.20 Typical Characteristics

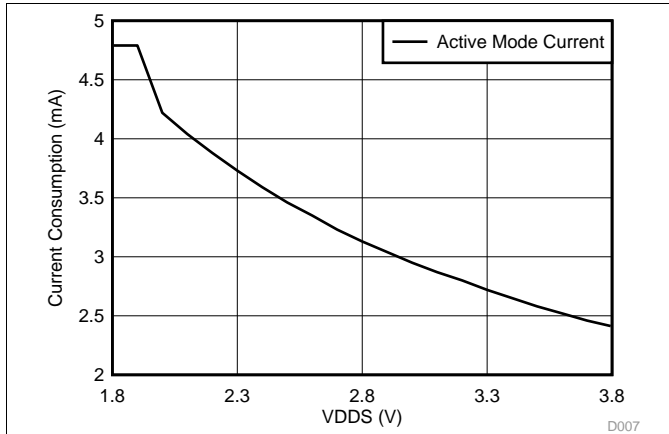

Figure 5-4. Active Mode (MCU) Current Consumption vs Supply Voltage (VDD5)

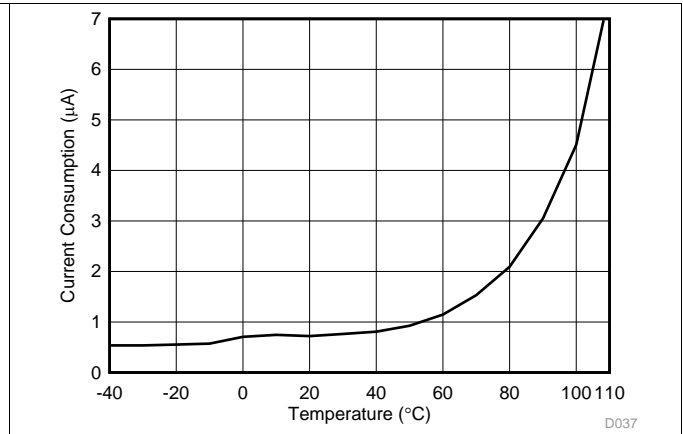

Figure 5-5. Standby MCU Current Consumption, 32-kHz Clock, RAM and MCU Retention

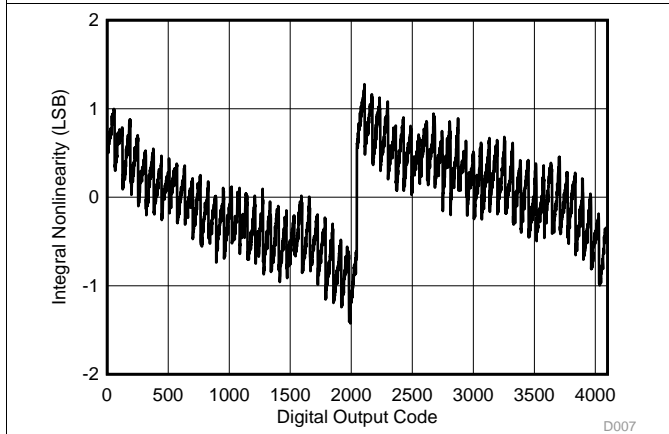

Figure 5-6. SoC ADC, Integral Nonlinearity vs Digital Output Code

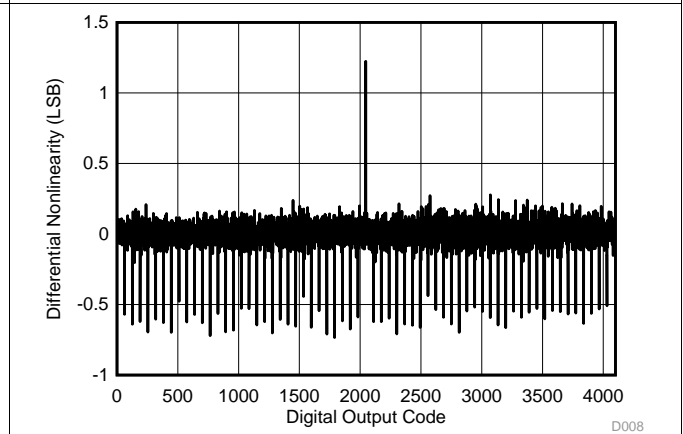

Figure 5-7. SoC ADC, Differential Nonlinearity vs Digital Output Code

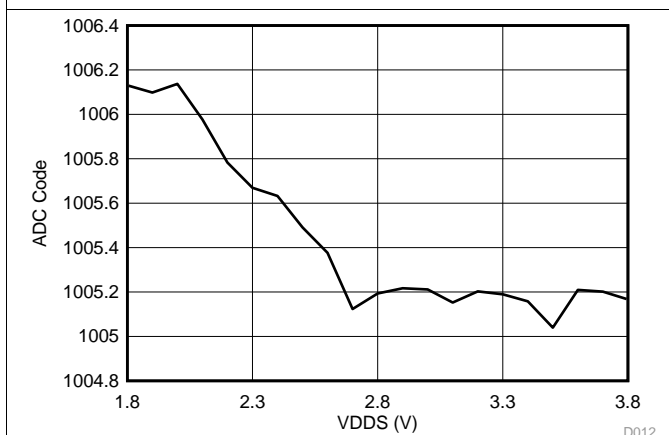

Figure 5-8. SoC ADC Output vs Supply Voltage (Fixed Input, Internal Reference, No Scaling)

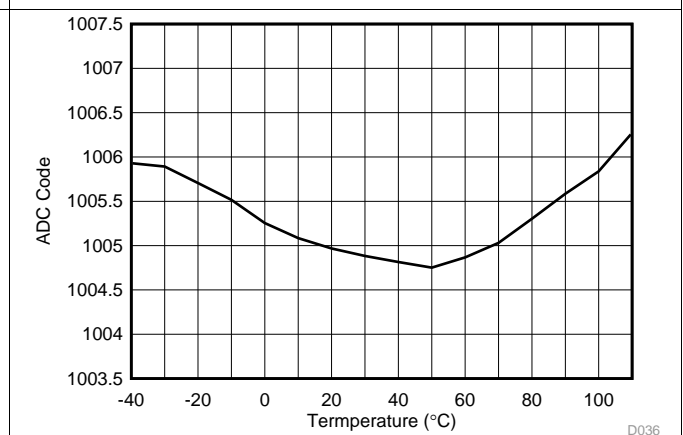

Figure 5-9. SoC ADC Output vs Temperature (Fixed Input, Internal Reference, No Scaling)

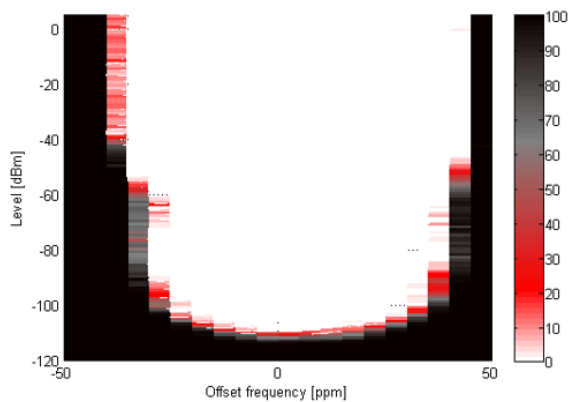

Figure 5-10. RX (50-kbps) Packet Error Rate (PER) vs Input RF Level vs Frequency Offset, 868 MHz

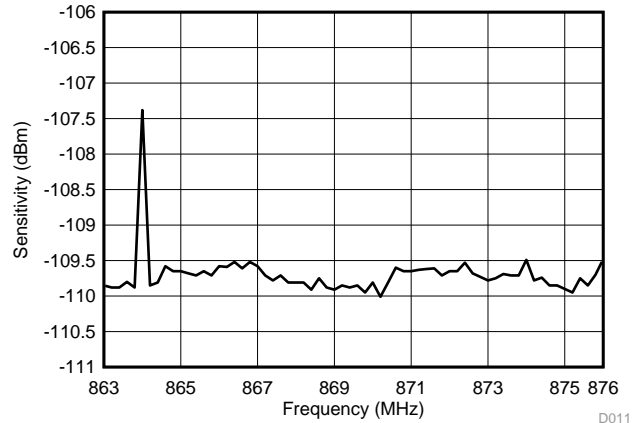

Figure 5-11. RX (50-kbps) Sensitivity vs Frequency

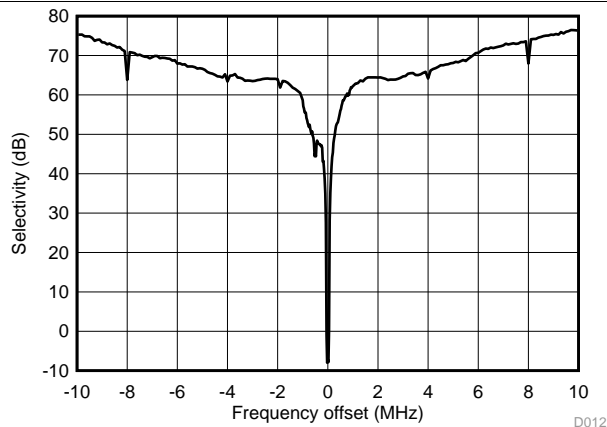

Figure 5-12. RX (50-kbps) Selectivity 868 MHz

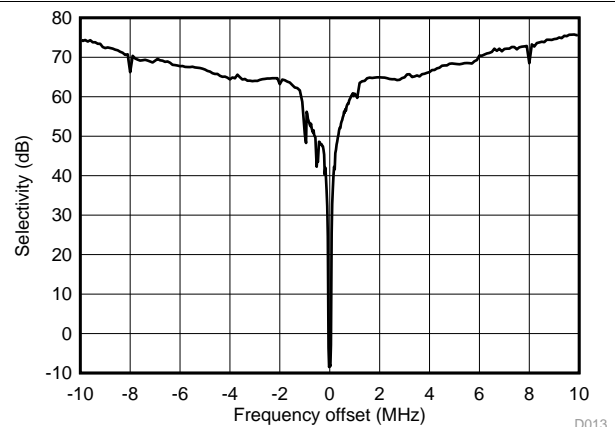

Figure 5-13. RX (50-kbps) Selectivity 915 MHz

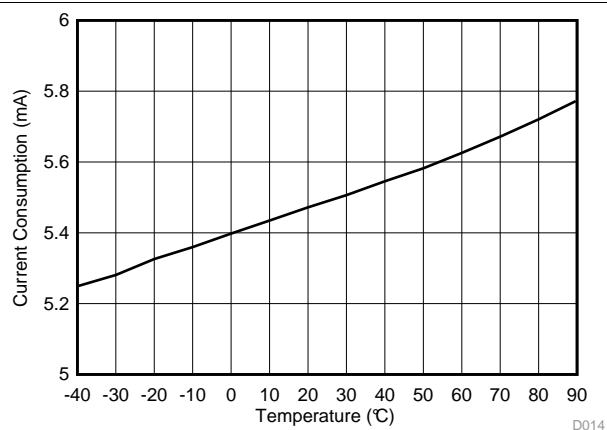

Figure 5-14. RX (50-kbps) Current Consumption vs Temperature 868 MHz

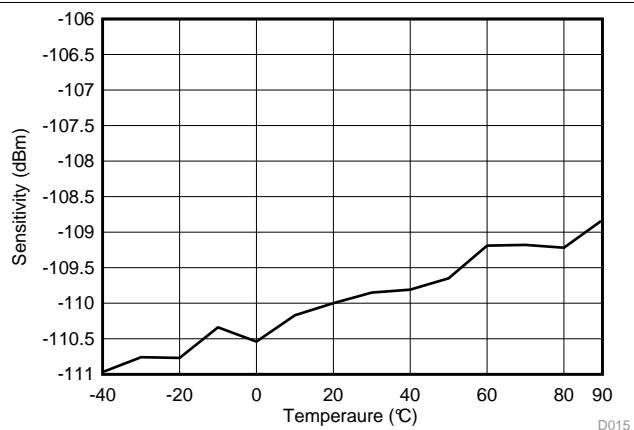

Figure 5-15. RX (50-kbps) Sensitivity vs Temperature 868 MHz

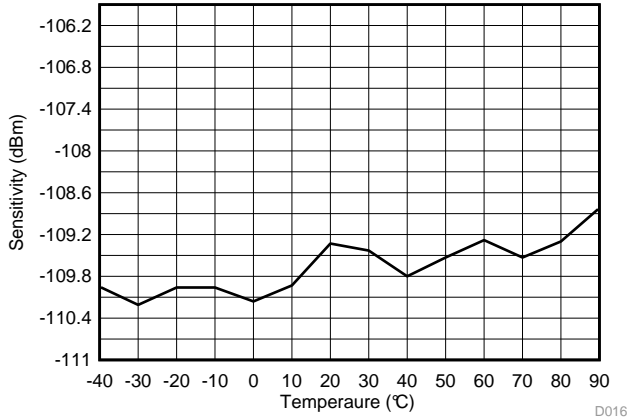

Figure 5-16. RX (50-kbps) Sensitivity vs Temperature 915 MHz

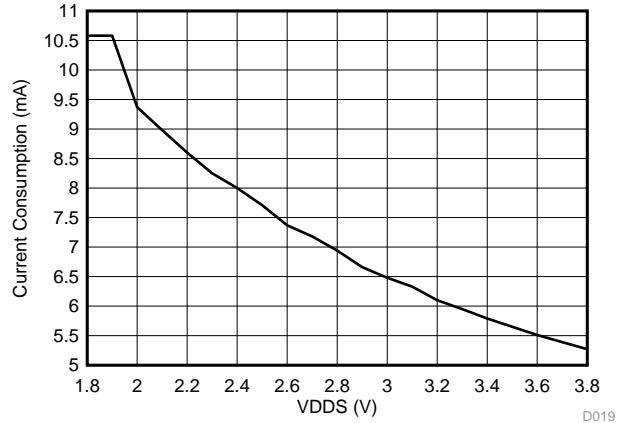

Figure 5-17. RX (50-kbps) Current Consumption vs Supply Voltage 915 MHz

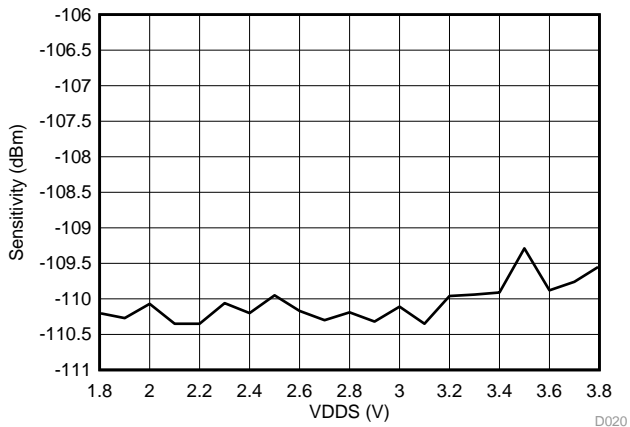

Figure 5-18. RX (50-kbps) Sensitivity vs Supply Voltage 868 MHz

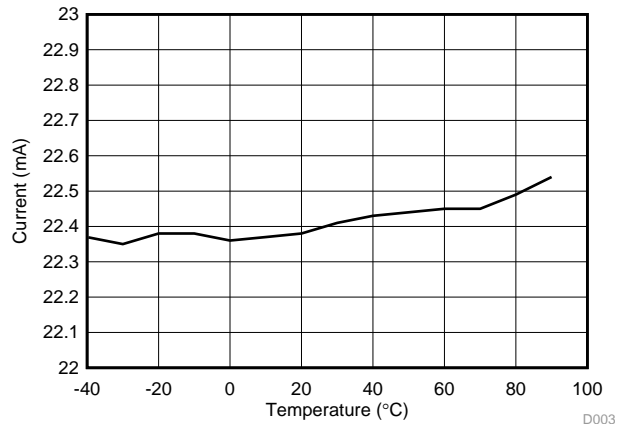

Figure 5-19. TX Current Consumption With Maximum Output Power vs Temperature 868 MHz

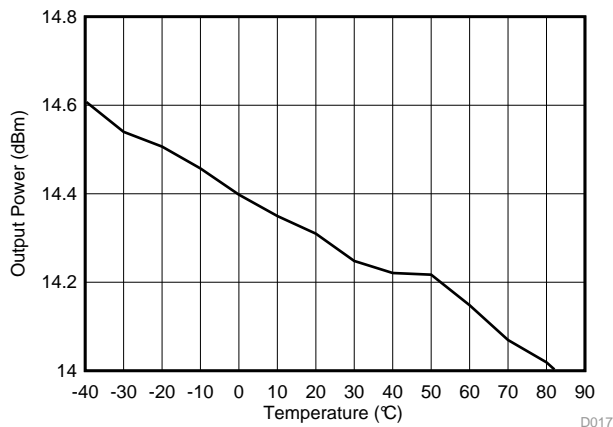

Figure 5-20. TX Maximum Output vs Temperature 868 MHz

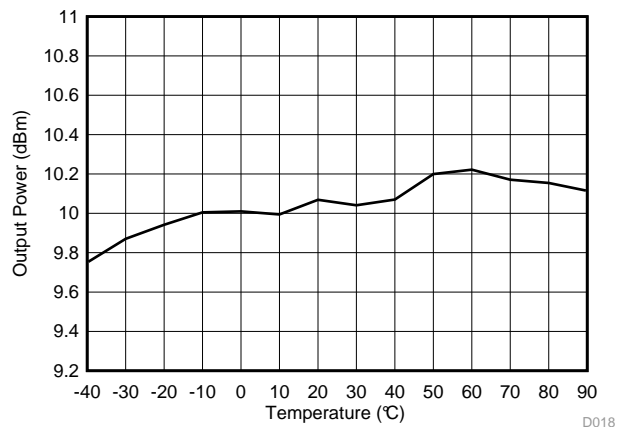

Figure 5-21. TX 10-dBm Output Power vs Temperature 868 MHz

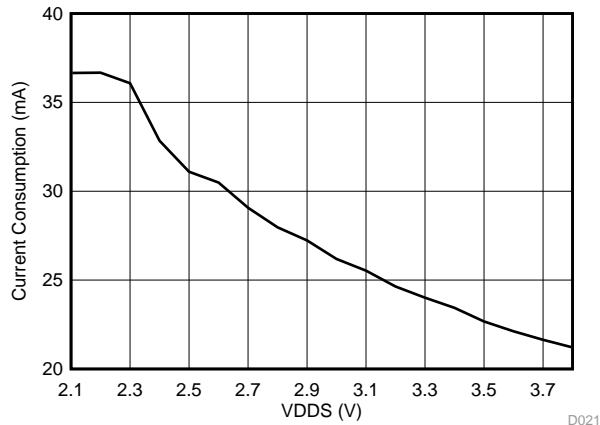

Figure 5-22. TX Current Consumption Maximum Output Power vs Supply Voltage 868 MHz

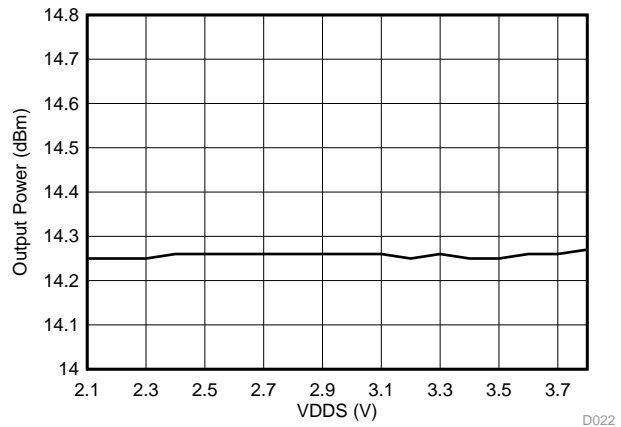

Figure 5-23. TX Maximum Output Power vs Supply Voltage 915 MHz

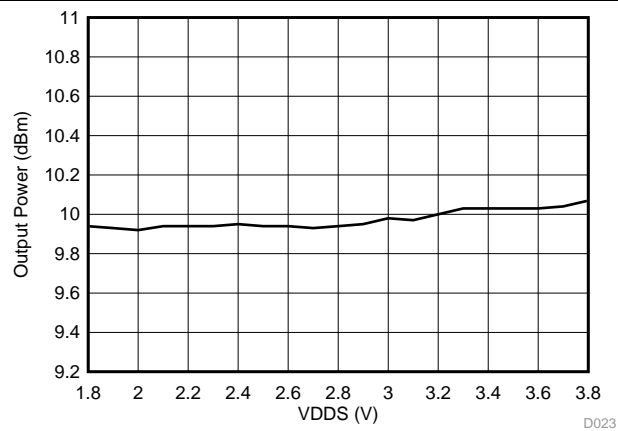

Figure 5-24. TX 10-dBm Output Power vs Supply Voltage 868 MHz

6 Detailed Description

6.1 Overview

Figure 1-1 shows a block diagram of the core modules of the CC13xx product family.

6.2 Main CPU

The CC1310 SimpleLink Wireless MCU contains an ARM Cortex-M3 (CM3) 32-bit CPU, which runs the application and the higher layers of the protocol stack.

The CM3 processor provides a high-performance, low-cost platform that meets the system requirements of minimal memory implementation and low-power consumption, while delivering outstanding computational performance and exceptional system response to interrupts.

The CM3 features include the following:

- 32-bit ARM Cortex-M3 architecture optimized for small-footprint embedded applications
- Outstanding processing performance combined with fast interrupt handling
- ARM Thumb[®]-2 mixed 16- and 32-bit instruction set delivers the high performance expected of a 32-bit ARM core in a compact memory size usually associated with 8- and 16-bit devices, typically in the range of a few kilobytes of memory for microcontroller-class applications:
 - Single-cycle multiply instruction and hardware divide
 - Atomic bit manipulation (bit-banding), delivering maximum memory use and streamlined peripheral control
 - Unaligned data access, enabling data to be efficiently packed into memory
- Fast code execution permits slower processor clock or increases sleep mode time
- Harvard architecture characterized by separate buses for instruction and data
- Efficient processor core, system, and memories
- Hardware division and fast digital-signal-processing oriented multiply accumulate
- Saturating arithmetic for signal processing
- Deterministic, high-performance interrupt handling for time-critical applications
- Enhanced system debug with extensive breakpoint and trace capabilities
- Serial wire trace reduces the number of pins required for debugging and tracing
- Migration from the ARM7[™] processor family for better performance and power efficiency
- Optimized for single-cycle flash memory use
- Ultra-low power consumption with integrated sleep modes
- 1.25 DMIPS per MHz

6.3 RF Core

The RF core is a highly flexible and capable radio system that interfaces the analog RF and baseband circuits, handles data to and from the system side, and assembles the information bits in a given packet structure.

The RF core can autonomously handle the time-critical aspects of the radio protocols, thus offloading the main CPU and leaving more resources for the user application. The RF core offers a high-level, command-based API to the main CPU.

The RF core supports a wide range of modulation formats, frequency bands, and accelerator features, which include the following (not all of the features have been characterized yet, see the [CC1310 SimpleLink Wireless MCU Silicon Errata](#) for more information):

- Wide range of data rates:
 - From 625 bps (offering long range and high robustness) to as high as 4 Mbps
- Wide range of modulation formats:
 - Multilevel (G) FSK and MSK
 - On-Off Keying (OOK) with optimized shaping to minimize adjacent channel leakage
 - Coding-gain support for long range
- Dedicated packet handling accelerators:
 - Forward error correction
 - Data whitening
 - 802.15.4g mode-switch support
 - Automatic CRC
- Automatic listen-before-talk (LBT) and clear channel assist (CCA)
- Digital RSSI
- Highly configurable channel filtering, supporting channel spacing schemes from 40 kHz to 4 MHz
- High degree of flexibility, offering a future-proof solution

The RF core interfaces a highly flexible radio, with a high-performance synthesizer that can support a wide range of frequency bands.

6.4 Sensor Controller

The Sensor Controller contains circuitry that can be selectively enabled in standby mode. The peripherals in this domain may be controlled by the Sensor Controller Engine, which is a proprietary power-optimized CPU. This CPU can read and monitor sensors or perform other tasks autonomously; thereby significantly reducing power consumption and offloading the main CM3 CPU.

A PC-based development tool called [Sensor Controller Studio](#) is used to write, test, and debug code for the Sensor Controller. The tool produces C driver source code, which the System CPU application uses to control and exchange data with the Sensor Controller. Typical use cases may be (but are not limited to) the following:

- Analog sensors using integrated ADC
- Digital sensors using GPIOs with bit-banged I²C or SPI
- Capacitive sensing
- Waveform generation
- Pulse counting
- Key scan
- Quadrature decoder for polling rotational sensors

The peripherals in the Sensor Controller include the following:

- The low-power clocked comparator can be used to wake the device from any state in which the comparator is active. A configurable internal reference can be used with the comparator. The output of the comparator can also be used to trigger an interrupt or the ADC.
- Capacitive sensing functionality is implemented through the use of a constant current source, a time-to-digital converter, and a comparator. The continuous time comparator in this block can also be used as a higher-accuracy alternative to the low-power clocked comparator. The Sensor Controller takes care of baseline tracking, hysteresis, filtering, and other related functions.
- The ADC is a 12-bit, 200-ksamples/s ADC with 8 inputs and a built-in voltage reference. The ADC can be triggered by many different sources, including timers, I/O pins, software, the analog comparator, and the RTC.
- The analog modules can be connected to up to eight different GPIOs (see [Table 6-1](#)).

The peripherals in the Sensor Controller can also be controlled from the main application processor.

Table 6-1. GPIOs Connected to the Sensor Controller⁽¹⁾

ANALOG CAPABLE	CC13x0		
	7 × 7 RGZ DIO NUMBER	5 × 5 RHB DIO NUMBER	4 × 4 RSM DIO NUMBER
Y	30	14	
Y	29	13	
Y	28	12	
Y	27	11	9
Y	26	9	8
Y	25	10	7
Y	24	8	6
Y	23	7	5
N	7	4	2
N	6	3	1
N	5	2	0
N	4	1	
N	3	0	
N	2		
N	1		
N	0		

(1) Depending on the package size, up to 15 pins can be connected to the Sensor Controller. Up to eight of these pins can be connected to analog modules.

6.5 Memory

The flash memory provides nonvolatile storage for code and data. The flash memory is in-system programmable.

The SRAM (static RAM) is split into two 4-KB blocks and two 6-KB blocks and can be used to store data and execute code. Retention of the RAM contents in standby mode can be enabled or disabled individually for each block to minimize power consumption. In addition, if flash cache is disabled, the 8-KB cache can be used as general-purpose RAM.

The ROM provides preprogrammed, embedded TI-RTOS kernel and Driverlib. The ROM also contains a bootloader that can be used to reprogram the device using SPI or UART.

6.6 Debug

The on-chip debug support is done through a dedicated cJTAG (IEEE 1149.7) or JTAG (IEEE 1149.1) interface.

6.7 Power Management

To minimize power consumption, the CC1310 device supports a number of power modes and power-management features (see [Table 6-2](#)).

Table 6-2. Power Modes

MODE	SOFTWARE-CONFIGURABLE POWER MODES				RESET PIN HELD
	ACTIVE	IDLE	STANDBY	SHUTDOWN	
CPU	Active	Off	Off	Off	Off
Flash	On	Available	Off	Off	Off
SRAM	On	On	On	Off	Off
Radio	Available	Available	Off	Off	Off
Supply System	On	On	Duty Cycled	Off	Off
Current	1.2 mA + 25.5 μ A/MHz	570 μ A	0.6 μ A	185 nA	0.1 μ A
Wake-up Time to CPU Active ⁽¹⁾	–	14 μ s	174 μ s	1015 μ s	1015 μ s
Register Retention	Full	Full	Partial	No	No
SRAM Retention	Full	Full	Full	No	No
High-Speed Clock	XOSC_HF or RCOSC_HF	XOSC_HF or RCOSC_HF	Off	Off	Off
Low-Speed Clock	XOSC_LF or RCOSC_LF	XOSC_LF or RCOSC_LF	XOSC_LF or RCOSC_LF	Off	Off
Peripherals	Available	Available	Off	Off	Off
Sensor Controller	Available	Available	Available	Off	Off
Wake-up on RTC	Available	Available	Available	Off	Off
Wake-up on Pin Edge	Available	Available	Available	Available	Off
Wake-up on Reset Pin	Available	Available	Available	Available	Available
Brown Out Detector (BOD)	Active	Active	Duty Cycled ⁽²⁾	Off	N/A
Power On Reset (POR)	Active	Active	Active	Active	N/A

(1) Not including RTOS overhead

(2) The Brown Out Detector is disabled between recharge periods in STANDBY. Lowering the supply voltage below the BOD threshold between two recharge periods while in STANDBY may cause the BOD to lock the device upon wakeup until a Reset/POR releases it. To avoid this, it is recommended that STANDBY mode is avoided if there is a risk that the supply voltage (VDD5) may drop below the specified operating voltage range. For the same reason, it is also good practice to ensure that a power cycling operation, such as a battery replacement, triggers a Power-on-reset by ensuring that the VDD5 decoupling network is fully depleted before applying supply voltage again (for example, inserting new batteries). This restriction does not apply to CC1310 die rev B or later.

In active mode, the application CM3 CPU is actively executing code. Active mode provides normal operation of the processor and all of the peripherals that are currently enabled. The system clock can be any available clock source (see [Table 6-2](#)).

In idle mode, all active peripherals can be clocked, but the Application CPU core and memory are not clocked and no code is executed. Any interrupt event returns the processor to active mode.

In standby mode, only the always-on (AON) domain is active. An external wake-up event, RTC event, or Sensor Controller event is required to return the device to active mode. MCU peripherals with retention do not need to be reconfigured when waking up again, and the CPU continues execution from where it went into standby mode. All GPIOs are latched in standby mode.

In shutdown mode, the device is entirely turned off (including the AON domain and Sensor Controller), and the I/Os are latched with the value they had before entering shutdown mode. A change of state on any I/O pin defined as a *wake from shutdown pin* wakes up the device and functions as a reset trigger. The CPU can differentiate between reset in this way and reset-by-reset pin or POR by reading the reset status register. The only state retained in this mode is the latched I/O state and the flash memory contents.

The Sensor Controller is an autonomous processor that can control the peripherals in the Sensor Controller independent of the main CPU. This means that the main CPU does not have to wake up, for example to execute an ADC sample or poll a digital sensor over SPI, thus saving both current and wake-up time that would otherwise be wasted. The Sensor Controller Studio lets the user configure the Sensor Controller and choose which peripherals are controlled and which conditions wake up the main CPU.

6.8 Clock Systems

The CC1310 device supports two external and two internal clock sources.

A 24-MHz external crystal is required as the frequency reference for the radio. This signal is doubled internally to create a 48-MHz clock.

The 32.768-kHz crystal is optional. The low-speed crystal oscillator is designed for use with a 32.768-kHz watch-type crystal.

The internal high-speed RC oscillator (48-MHz) can be used as a clock source for the CPU subsystem.

The internal low-speed RC oscillator (32-kHz) can be used as a reference if the low-power crystal oscillator is not used.

The 32-kHz clock source can be used as external clocking reference through GPIO.

6.9 General Peripherals and Modules

The I/O controller controls the digital I/O pins and contains multiplexer circuitry to assign a set of peripherals to I/O pins in a flexible manner. All digital I/Os are interrupt and wake-up capable, have a programmable pullup and pulldown function, and can generate an interrupt on a negative or positive edge (configurable). When configured as an output, pins can function as either push-pull or open-drain. Five GPIOs have high-drive capabilities, which are marked in **bold** in the [Pin Diagram](#) section.

The SSIs are synchronous serial interfaces that are compatible with SPI, MICROWIRE, and TI's synchronous serial interfaces. The SSIs support both SPI master and slave up to 4 MHz.

The UART implements a universal asynchronous receiver and transmitter function. The UART supports flexible baud-rate generation up to a maximum of 3 Mbps.

Timer 0 is a general-purpose timer module (GPTM) that provides two 16-bit timers. The GPTM can be configured to operate as a single 32-bit timer, dual 16-bit timers, or as a PWM module.

Timer 1, Timer 2, and Timer 3 are also GPTMs; each timer is functionally equivalent to Timer 0.

In addition to these four timers, a separate timer in the RF core handles timing for RF protocols; the RF timer can be synchronized to the RTC.

The I2S interface is used to handle digital audio (for more information, see the [CC13xx, CC26xx SimpleLink™ Wireless MCU Technical Reference Manual](#)).

The I²C interface is used to communicate with devices compatible with the I²C standard. The I²C interface can handle 100 kHz and 400 kHz operation, and can serve as both I²C master and I²C slave.

The TRNG module provides a true, nondeterministic noise source for the purpose of generating keys, initialization vectors (IVs), and other random number requirements. The TRNG is built on 24 ring oscillators that create unpredictable output to feed a complex nonlinear-combinatorial circuit.

The watchdog timer is used to regain control if the system fails due to a software error after an external device fails to respond as expected. The watchdog timer can generate an interrupt or a reset when a predefined time-out value is reached.

The device includes a direct memory access (μ DMA) controller. The μ DMA controller provides a way to offload data-transfer tasks from the CM3 CPU, thus allowing for more efficient use of the processor and the available bus bandwidth. The μ DMA controller can perform transfer between memory and peripherals. The μ DMA controller has dedicated channels for each supported on-chip module and can be programmed to automatically perform transfers between peripherals and memory when the peripheral is ready to transfer more data.

Some features of the μ DMA controller follow (this is not an exhaustive list):

- Highly flexible and configurable channel operation of up to 32 channels
- Transfer modes: memory-to-memory, memory-to-peripheral, peripheral-to-memory, and peripheral-to-peripheral
- Data sizes of 8, 16, and 32 bits

The AON domain contains circuitry that is always enabled, except when in shutdown mode (where the digital supply is off). This circuitry includes the following:

- The RTC can be used to wake the device from any state where it is active. The RTC contains three compare registers and one capture register. With software support, the RTC can be used for clock and calendar operation. The RTC is clocked from the 32-kHz RC oscillator or crystal. The RTC can also be compensated to tick at the correct frequency even when the internal 32-kHz RC oscillator is used instead of a crystal.
- The battery monitor and temperature sensor are accessible by software and provide a battery status indication as well as a coarse temperature measure.

6.10 Voltage Supply Domains

The CC1310 device can interface to two or three different voltage domains depending on the package type. On-chip level converters ensure correct operation as long as the signal voltage on each input/output pin is set with respect to the corresponding supply pin (VDDS, VDDS2 or VDDS3). [Table 6-3](#) lists the pin-to-VDDS mapping.

Table 6-3. Pin Function to VDDS Mapping Table

	Package		
	VQFN 7 × 7 (RGZ)	VQFN 5 × 5 (RHB)	VQFN 4 × 4 (RSM)
VDDS ⁽¹⁾	DIO 23–30 Reset_N	DIO 7–14 Reset_N	DIO 5–9 Reset_N
VDDS2	DIO 1–11	DIO 0–6 JTAG_TCKC JTAG_TMISC	DIO 0–4 JTAG_TCKC JTAG_TMISC
VDDS3	DIO 12–22 JTAG_TCKC JTAG_TMISC	NA	NA

(1) The VDDS_DCDC pin must always be connected to the same voltage as the VDDS pin.

6.11 System Architecture

Depending on the product configuration, the CC1310 device can function as a wireless network processor (WNP – a device running the wireless protocol stack, with the application running on a separate host MCU), or as a system-on-chip (SoC) with the application and protocol stack running on the ARM CM3 core inside the device.

In the first case, the external host MCU communicates with the device using SPI or UART. In the second case, the application must be written according to the application framework supplied with the wireless protocol stack.

7 Application, Implementation, and Layout

NOTE

Information in the following Applications section is not part of the TI component specification, and TI does not warrant its accuracy or completeness. TI's customers are responsible for determining suitability of components for their purposes. Customers should validate and test their design implementation to confirm system functionality.

Few external components are required for the operation of the CC1310 device. [Figure 7-1](#) shows a typical application circuit.

The board layout greatly influences the RF performance of the CC1310 device.

On the Texas Instruments CC1310EM-7XD-7793 reference design, the optimal differential impedance seen from the RF pins into the balun and filter and antenna is $44 + j15$.

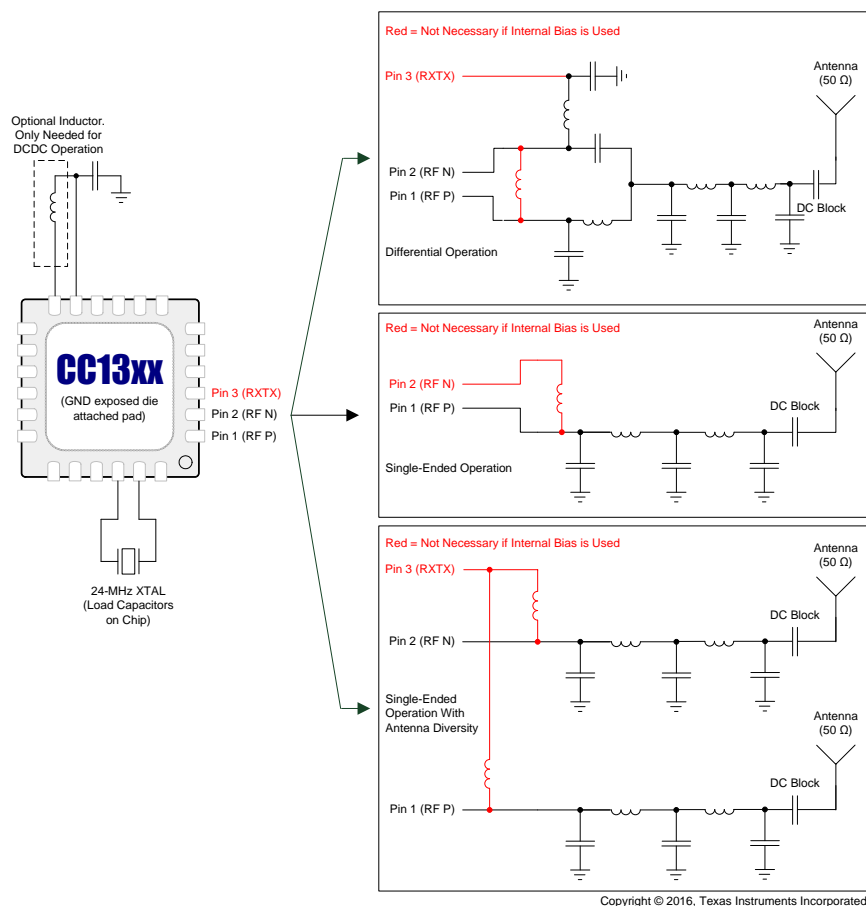

[Figure 7-1](#) does not show decoupling capacitors for power pins. For a complete reference design, see the product folder on www.ti.com.

Figure 7-1. Differential Reference Design

7.1 TI Design

[Humidity and Temp Sensor Node for Sub-1 GHz Star Networks Enabling 10+ Year Coin Cell Battery Life](#)

This TI Design uses TI's nano-power system timer, boost converter, SimpleLink ultra-low-power Sub-1 GHz wireless MCU platform, and humidity-sensing technologies to demonstrate an ultra-low-power method to duty-cycle sensor end nodes leading to extremely long battery life. The TI Design includes techniques for system design, detailed test results, and information to get the design operating running quickly.

8 Device and Documentation Support

TI offers an extensive line of development tools. Tools and software to evaluate the performance of the device, generate code, and develop solutions are listed in the following.

8.1 Device Nomenclature

To designate the stages in the product development cycle, TI assigns prefixes to all part numbers and/or date-code. Each device has one of three prefixes/identifications: X, P, or null (no prefix) (for example, CC1310 is in production; therefore, no prefix/identification is assigned).

Device development evolutionary flow:

- X** Experimental device that is not necessarily representative of the final device's electrical specifications and may not use production assembly flow.
- P** Prototype device that is not necessarily the final silicon die and may not necessarily meet final electrical specifications.
- null** Production version of the silicon die that is fully qualified.

Production devices have been characterized fully, and the quality and reliability of the device have been demonstrated fully. TI's standard warranty applies.

Predictions show that prototype devices (X or P) have a greater failure rate than the standard production devices. Texas Instruments recommends that these devices not be used in any production system because their expected end-use failure rate still is undefined. Only qualified production devices are to be used.

TI device nomenclature also includes a suffix with the device family name. This suffix indicates the package type (for example, RGZ).

For orderable part numbers of CC1310 devices in the RSM (4-mm x 4-mm), RHB (5-mm x 5-mm) or RGZ (7-mm x 7-mm) package types, see the *Package Option Addendum* of this document, the TI website (www.ti.com), or contact your TI sales representative.

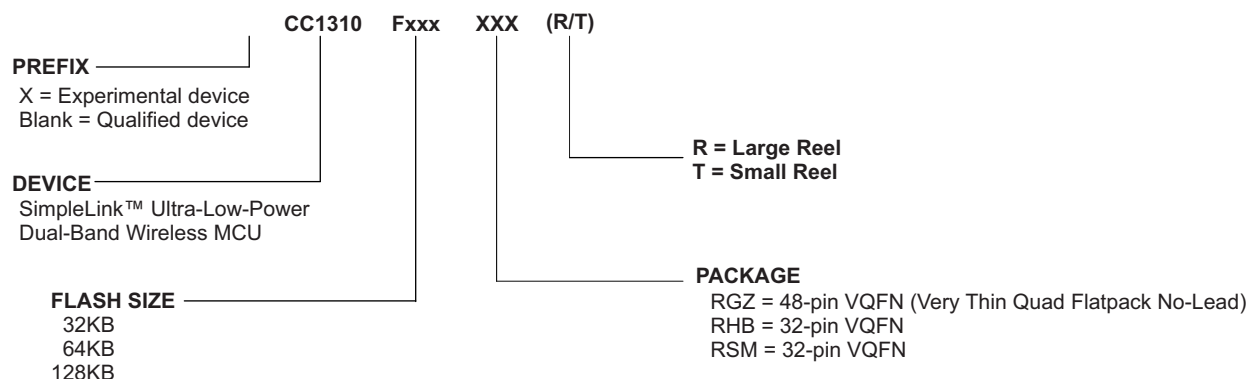

Figure 8-1. Device Nomenclature

8.2 Tools and Software

Development Kit:

SimpleLink™ CC1310 Sub-1 GHz Wireless Microcontroller (MCU) LaunchPad™ Development Kit

The SimpleLink™ Sub-1 GHz CC1310 wireless microcontroller (MCU) LaunchPad™ development kit is the first LaunchPad kit with a Sub-1 GHz radio, which offers long-range connectivity, combined with a 32-bit ARM® Cortex®-M3 processor on a single chip.

The CC1310 device is a wireless MCU targeting low-power, long-range wireless applications. The CC1310 wireless MCU contains a 32-bit ARM Cortex-M3 processor that runs at 48 MHz as the main processor and a rich peripheral feature set that includes a unique ultra-low power sensor controller. This sensor controller is ideal for interfacing external sensors and for collecting analog and digital data autonomously while the rest of the system is in sleep mode.

Software Tools:

SmartRF™ Studio 7

SmartRF Studio is a PC application that helps designers of radio systems to easily evaluate the RF-IC at an early stage in the design process.

- Test functions for transmitting and receiving radio packets, continuous wave transmit and receive
- Evaluate RF performance on custom boards by wiring it to a supported evaluation board or debugger
- Can also be used without any hardware, but then only to generate, edit and export radio configuration settings
- Can be used in combination with several development kits for Texas Instruments' CC1310 RF-ICs

Sensor Controller Studio

Sensor Controller Studio provides a development environment for the CC1310 Sensor Controller. The Sensor Controller is a proprietary, power-optimized CPU inside the CC1310, which can perform simple background tasks autonomously and independent of the System CPU state.

- Allows for Sensor Controller task algorithms to be implemented using a C-like programming language
- Outputs a Sensor Controller Interface driver, which incorporates the generated Sensor Controller machine code and associated definitions
- Allows for rapid development by using the integrated Sensor Controller task testing and debugging functionality. This allows for live visualization of sensor data and algorithm verification.

IDEs and Compilers:

Code Composer Studio™

- An integrated development environment with project management tools and editor
- Code Composer Studio (CCS) 6.1 and later has built-in support for the CC1310 device family
- Best support for XDS debuggers; XDS100v3, XDS110 and XDS200
- High integration with TI-RTOS with support for TI-RTOS Object View

IAR Embedded Workbench® for ARM

- Integrated development environment with project management tools and editor
- IAR EWARM 7.30.3 and later has built-in support for the CC1310 device family
- Broad debugger support, supporting XDS100v3, XDS200, IAR I-Jet and Segger J-Link
- Integrated development environment with project management tools and editor
- RTOS plugin available for [TI-RTOS](#)

For a complete listing of development-support tools for the CC1310 platform, visit the Texas Instruments website at www.ti.com. For information on pricing and availability, contact the nearest TI field sales office or authorized distributor.

8.3 Documentation Support

To receive notification of documentation updates, navigate to the device product folder on ti.com (CC1310). In the upper right corner, click on Alert me to register and receive a weekly digest of any product information that has changed. For change details, review the revision history included in any revised document.

The current documentation that describes the CC1310, related peripherals, and other technical collateral is listed in the following.

Technical Reference Manual

[CC13xx, CC26xx SimpleLink™ Wireless MCU Technical Reference Manual](#)

Reference Guide

[CC26xx/CC13xx Power Management Software Developer's Reference Guide](#)

Application Reports

[Using GCC/GDB With SimpleLink™ CC26xx/CC13xx](#)

[CC-Antenna-DK2 and Antenna Measurements Summary](#)

8.4 Texas Instruments Low-Power RF Website

TI's Low-Power RF website has all the latest products, application and design notes, FAQ section, news and events updates. Go to www.ti.com/longrange.

8.5 Low-Power RF eNewsletter

The Low-Power RF eNewsletter is up-to-date on new products, news releases, developers' news, and other news and events associated with low-power RF products from TI. The Low-Power RF eNewsletter articles include links to get more online information.

Sign up at: www.ti.com/lprfnewsletter

8.6 Additional Information

Texas Instruments offers a wide selection of cost-effective, low-power RF solutions for proprietary and standard-based wireless applications for use in industrial and consumer applications. The selection includes RF transceivers, RF transmitters, RF front ends, and Systems-on-Chips as well as various software solutions for the Sub-1 GHz and 2.4-GHz frequency bands.

In addition, Texas Instruments provides a large selection of support collateral such as development tools, technical documentation, reference designs, application expertise, customer support, third-party and university programs.

Other than providing technical support forums, videos, and blogs, the Low-Power RF E2E Online Community also presents the opportunity to interact with engineers from all over the world.

With a broad selection of product solutions, end-application possibilities, and a range of technical support, Texas Instruments offers the broadest low-power RF portfolio.

8.7 Community Resources

The following links connect to TI community resources. Linked contents are provided "AS IS" by the respective contributors. They do not constitute TI specifications and do not necessarily reflect TI's views; see TI's [Terms of Use](#).

TI E2E™ Online Community The TI engineer-to-engineer (E2E) community was created to foster collaboration among engineers. At e2e.ti.com, you can ask questions, share knowledge, explore ideas and help solve problems with fellow engineers.

TI Embedded Processors Wiki *Texas Instruments Embedded Processors Wiki*. Established to help developers get started with Embedded Processors from Texas Instruments and to foster innovation and growth of general knowledge about the hardware and software surrounding these devices.

Low-Power RF Online Community Wireless Connectivity Section of the TI E2E Support Community

- Forums, videos, and blogs
- RF design help
- E2E interaction

Join [here](#).

Low-Power RF Developer Network Texas Instruments has launched an extensive network of low-power RF development partners to help customers speed up their application development. The network consists of recommended companies, RF consultants, and independent design houses that provide a series of hardware module products and design services, including:

- RF circuit, low-power RF, and ZigBee® design services
- Low-power RF and ZigBee module solutions and development tools
- RF certification services and RF circuit manufacturing

For help with modules, engineering services or development tools:

Search the [Low-Power RF Developer Network](#) to find a suitable partner.
www.ti.com/lprfnetwork

8.8 Trademarks

SimpleLink, SmartRF, Code Composer Studio, E2E are trademarks of Texas Instruments.

ARM7 is a trademark of ARM Limited (or its subsidiaries).

ARM, Cortex, Thumb are registered trademarks of ARM Limited (or its subsidiaries).

ULPBench is a trademark of Embedded Microprocessor Benchmark Consortium.

CoreMark is a registered trademark of Embedded Microprocessor Benchmark Consortium.

IAR Embedded Workbench is a registered trademark of IAR Systems AB.

IEEE is a registered trademark of IEEE.

IEEE Std 1241 is a trademark of Institute of Electrical and Electronics Engineers, Incorporated.

Wi-SUN is a trademark of Wi-SUN Alliance, Inc.

ZigBee is a registered trademark of Zigbee Alliance.

All other trademarks are the property of their respective owners.

8.9 Electrostatic Discharge Caution



This integrated circuit can be damaged by ESD. Texas Instruments recommends that all integrated circuits be handled with appropriate precautions. Failure to observe proper handling and installation procedures can cause damage.

ESD damage can range from subtle performance degradation to complete device failure. Precision integrated circuits may be more susceptible to damage because very small parametric changes could cause the device not to meet its published specifications.

8.10 Export Control Notice

Recipient agrees to not knowingly export or re-export, directly or indirectly, any product or technical data (as defined by the U.S., EU, and other Export Administration Regulations) including software, or any controlled product restricted by other applicable national regulations, received from disclosing party under nondisclosure obligations (if any), or any direct product of such technology, to any destination to which such export or re-export is restricted or prohibited by U.S. or other applicable laws, without obtaining prior authorization from U.S. Department of Commerce and other competent Government authorities to the extent required by those laws.

8.11 Glossary

[TI Glossary](#) This glossary lists and explains terms, acronyms, and definitions.

9 Mechanical, Packaging, and Orderable Information

9.1 Packaging Information

The following pages include mechanical packaging and orderable information. This information is the most current data available for the designated devices. This data is subject to change without notice and revision of this document. For browser-based versions of this data sheet, refer to the left-hand navigation.

PACKAGING INFORMATION

Orderable Device	Status (1)	Package Type	Package Drawing	Pins	Package Qty	Eco Plan (2)	Lead/Ball Finish (6)	MSL Peak Temp (3)	Op Temp (°C)	Device Marking (4/5)	Samples
CC1310F128RGZR	ACTIVE	VQFN	RGZ	48	2500	Green (RoHS & no Sb/Br)	CU NIPDAU	Level-3-260C-168 HR	-40 to 85	CC1310 F128	Samples
CC1310F128RGZT	ACTIVE	VQFN	RGZ	48	250	Green (RoHS & no Sb/Br)	CU NIPDAU	Level-3-260C-168 HR	-40 to 85	CC1310 F128	Samples
CC1310F128RHBR	ACTIVE	VQFN	RHB	32	3000	Green (RoHS & no Sb/Br)	CU NIPDAU	Level-3-260C-168 HR	-40 to 85	CC1310 F128	Samples
CC1310F128RHBT	ACTIVE	VQFN	RHB	32	250	Green (RoHS & no Sb/Br)	CU NIPDAU CU NIPDAUAG	Level-3-260C-168 HR	-40 to 85	CC1310 F128	Samples
CC1310F128RSMR	ACTIVE	VQFN	RSM	32	3000	Green (RoHS & no Sb/Br)	CU NIPDAU	Level-3-260C-168 HR	-40 to 85	CC1310 F128	Samples
CC1310F128RSMT	ACTIVE	VQFN	RSM	32	250	Green (RoHS & no Sb/Br)	CU NIPDAU CU NIPDAUAG	Level-3-260C-168 HR	-40 to 85	CC1310 F128	Samples
CC1310F32RGZR	ACTIVE	VQFN	RGZ	48	2500	Green (RoHS & no Sb/Br)	CU NIPDAU CU NIPDAUAG	Level-3-260C-168 HR	-40 to 85	CC1310 F32	Samples
CC1310F32RGZT	ACTIVE	VQFN	RGZ	48	250	Green (RoHS & no Sb/Br)	CU NIPDAU CU NIPDAUAG	Level-3-260C-168 HR	-40 to 85	CC1310 F32	Samples
CC1310F32RHBR	ACTIVE	VQFN	RHB	32	3000	Green (RoHS & no Sb/Br)	CU NIPDAU CU NIPDAUAG	Level-3-260C-168 HR	-40 to 85	CC1310 F32	Samples
CC1310F32RHBT	ACTIVE	VQFN	RHB	32	250	Green (RoHS & no Sb/Br)	CU NIPDAU CU NIPDAUAG	Level-3-260C-168 HR	-40 to 85	CC1310 F32	Samples
CC1310F32RSMR	ACTIVE	VQFN	RSM	32	3000	Green (RoHS & no Sb/Br)	CU NIPDAU CU NIPDAUAG	Level-3-260C-168 HR	-40 to 85	CC1310 F32	Samples
CC1310F32RSMT	ACTIVE	VQFN	RSM	32	250	Green (RoHS & no Sb/Br)	CU NIPDAU CU NIPDAUAG	Level-3-260C-168 HR	-40 to 85	CC1310 F32	Samples
CC1310F64RGZR	ACTIVE	VQFN	RGZ	48	2500	Green (RoHS & no Sb/Br)	CU NIPDAU CU NIPDAUAG	Level-3-260C-168 HR	-40 to 85	CC1310 F64	Samples
CC1310F64RGZT	ACTIVE	VQFN	RGZ	48	250	Green (RoHS & no Sb/Br)	CU NIPDAU CU NIPDAUAG	Level-3-260C-168 HR	-40 to 85	CC1310 F64	Samples
CC1310F64RHBR	ACTIVE	VQFN	RHB	32	3000	Green (RoHS & no Sb/Br)	CU NIPDAU CU NIPDAUAG	Level-3-260C-168 HR	-40 to 85	CC1310 F64	Samples
CC1310F64RHBT	ACTIVE	VQFN	RHB	32	250	Green (RoHS & no Sb/Br)	CU NIPDAU CU NIPDAUAG	Level-3-260C-168 HR	-40 to 85	CC1310 F64	Samples
CC1310F64RSMR	ACTIVE	VQFN	RSM	32	3000	Green (RoHS & no Sb/Br)	CU NIPDAU	Level-3-260C-168 HR	-40 to 85	CC1310 F64	Samples

Orderable Device	Status (1)	Package Type	Package Drawing	Pins	Package Qty	Eco Plan (2)	Lead/Ball Finish (6)	MSL Peak Temp (3)	Op Temp (°C)	Device Marking (4/5)	Samples
CC1310F64RSMT	ACTIVE	VQFN	RSM	32	250	Green (RoHS & no Sb/Br)	CU NIPDAU CU NIPDAUAG	Level-3-260C-168 HR	-40 to 85	CC1310 F64	Samples

(1) The marketing status values are defined as follows:

ACTIVE: Product device recommended for new designs.

LIFEBUY: TI has announced that the device will be discontinued, and a lifetime-buy period is in effect.

NRND: Not recommended for new designs. Device is in production to support existing customers, but TI does not recommend using this part in a new design.

PREVIEW: Device has been announced but is not in production. Samples may or may not be available.

OBSOLETE: TI has discontinued the production of the device.

(2) **RoHS:** TI defines "RoHS" to mean semiconductor products that are compliant with the current EU RoHS requirements for all 10 RoHS substances, including the requirement that RoHS substance do not exceed 0.1% by weight in homogeneous materials. Where designed to be soldered at high temperatures, "RoHS" products are suitable for use in specified lead-free processes. TI may reference these types of products as "Pb-Free".

RoHS Exempt: TI defines "RoHS Exempt" to mean products that contain lead but are compliant with EU RoHS pursuant to a specific EU RoHS exemption.

Green: TI defines "Green" to mean the content of Chlorine (Cl) and Bromine (Br) based flame retardants meet JS709B low halogen requirements of <=1000ppm threshold. Antimony trioxide based flame retardants must also meet the <=1000ppm threshold requirement.

(3) MSL, Peak Temp. - The Moisture Sensitivity Level rating according to the JEDEC industry standard classifications, and peak solder temperature.

(4) There may be additional marking, which relates to the logo, the lot trace code information, or the environmental category on the device.

(5) Multiple Device Markings will be inside parentheses. Only one Device Marking contained in parentheses and separated by a "~" will appear on a device. If a line is indented then it is a continuation of the previous line and the two combined represent the entire Device Marking for that device.

(6) Lead/Ball Finish - Orderable Devices may have multiple material finish options. Finish options are separated by a vertical ruled line. Lead/Ball Finish values may wrap to two lines if the finish value exceeds the maximum column width.

Important Information and Disclaimer:The information provided on this page represents TI's knowledge and belief as of the date that it is provided. TI bases its knowledge and belief on information provided by third parties, and makes no representation or warranty as to the accuracy of such information. Efforts are underway to better integrate information from third parties. TI has taken and continues to take reasonable steps to provide representative and accurate information but may not have conducted destructive testing or chemical analysis on incoming materials and chemicals. TI and TI suppliers consider certain information to be proprietary, and thus CAS numbers and other limited information may not be available for release.

In no event shall TI's liability arising out of such information exceed the total purchase price of the TI part(s) at issue in this document sold by TI to Customer on an annual basis.

TAPE AND REEL INFORMATION



QUADRANT ASSIGNMENTS FOR PIN 1 ORIENTATION IN TAPE



*All dimensions are nominal

Device	Package Type	Package Drawing	Pins	SPQ	Reel Diameter (mm)	Reel Width W1 (mm)	A0 (mm)	B0 (mm)	K0 (mm)	P1 (mm)	W (mm)	Pin1 Quadrant
CC1310F128RGZR	VQFN	RGZ	48	2500	330.0	16.4	7.3	7.3	1.1	12.0	16.0	Q2
CC1310F128RGZT	VQFN	RGZ	48	250	180.0	16.4	7.3	7.3	1.1	12.0	16.0	Q2
CC1310F128RHBR	VQFN	RHB	32	3000	330.0	12.4	5.3	5.3	1.1	8.0	12.0	Q2
CC1310F128RHBT	VQFN	RHB	32	250	180.0	12.4	5.3	5.3	1.1	8.0	12.0	Q2
CC1310F128RSMR	VQFN	RSM	32	3000	330.0	12.4	4.25	4.25	1.15	8.0	12.0	Q2
CC1310F128RSMT	VQFN	RSM	32	250	180.0	12.4	4.25	4.25	1.15	8.0	12.0	Q2
CC1310F32RGZR	VQFN	RGZ	48	2500	330.0	16.4	7.3	7.3	1.1	12.0	16.0	Q2
CC1310F32RGZT	VQFN	RGZ	48	250	180.0	16.4	7.3	7.3	1.1	12.0	16.0	Q2
CC1310F32RHBR	VQFN	RHB	32	3000	330.0	12.4	5.3	5.3	1.1	8.0	12.0	Q2
CC1310F32RHBT	VQFN	RHB	32	250	180.0	12.4	5.3	5.3	1.1	8.0	12.0	Q2
CC1310F32RSMT	VQFN	RSM	32	250	180.0	12.4	4.25	4.25	1.15	8.0	12.0	Q2
CC1310F64RGZR	VQFN	RGZ	48	2500	330.0	16.4	7.3	7.3	1.1	12.0	16.0	Q2
CC1310F64RGZT	VQFN	RGZ	48	250	180.0	16.4	7.3	7.3	1.1	12.0	16.0	Q2
CC1310F64RHBR	VQFN	RHB	32	3000	330.0	12.4	5.3	5.3	1.1	8.0	12.0	Q2
CC1310F64RHBT	VQFN	RHB	32	250	180.0	12.4	5.3	5.3	1.1	8.0	12.0	Q2
CC1310F64RSMR	VQFN	RSM	32	3000	330.0	12.4	4.25	4.25	1.15	8.0	12.0	Q2
CC1310F64RSMT	VQFN	RSM	32	250	180.0	12.4	4.25	4.25	1.15	8.0	12.0	Q2

TAPE AND REEL BOX DIMENSIONS



*All dimensions are nominal

Device	Package Type	Package Drawing	Pins	SPQ	Length (mm)	Width (mm)	Height (mm)
CC1310F128RGZR	VQFN	RGZ	48	2500	367.0	367.0	38.0
CC1310F128RGZT	VQFN	RGZ	48	250	210.0	185.0	35.0
CC1310F128RHBR	VQFN	RHB	32	3000	367.0	367.0	35.0
CC1310F128RHBT	VQFN	RHB	32	250	210.0	185.0	35.0
CC1310F128RSMR	VQFN	RSM	32	3000	367.0	367.0	35.0
CC1310F128RSMT	VQFN	RSM	32	250	210.0	185.0	35.0
CC1310F32RGZR	VQFN	RGZ	48	2500	367.0	367.0	38.0
CC1310F32RGZT	VQFN	RGZ	48	250	210.0	185.0	35.0
CC1310F32RHBR	VQFN	RHB	32	3000	367.0	367.0	35.0
CC1310F32RHBT	VQFN	RHB	32	250	210.0	185.0	35.0
CC1310F32RSMT	VQFN	RSM	32	250	210.0	185.0	35.0
CC1310F64RGZR	VQFN	RGZ	48	2500	367.0	367.0	38.0
CC1310F64RGZT	VQFN	RGZ	48	250	210.0	185.0	35.0
CC1310F64RHBR	VQFN	RHB	32	3000	367.0	367.0	35.0
CC1310F64RHBT	VQFN	RHB	32	250	210.0	185.0	35.0
CC1310F64RSMR	VQFN	RSM	32	3000	367.0	367.0	35.0
CC1310F64RSMT	VQFN	RSM	32	250	210.0	185.0	35.0

MECHANICAL DATA

RHB (S-PVQFN-N32)

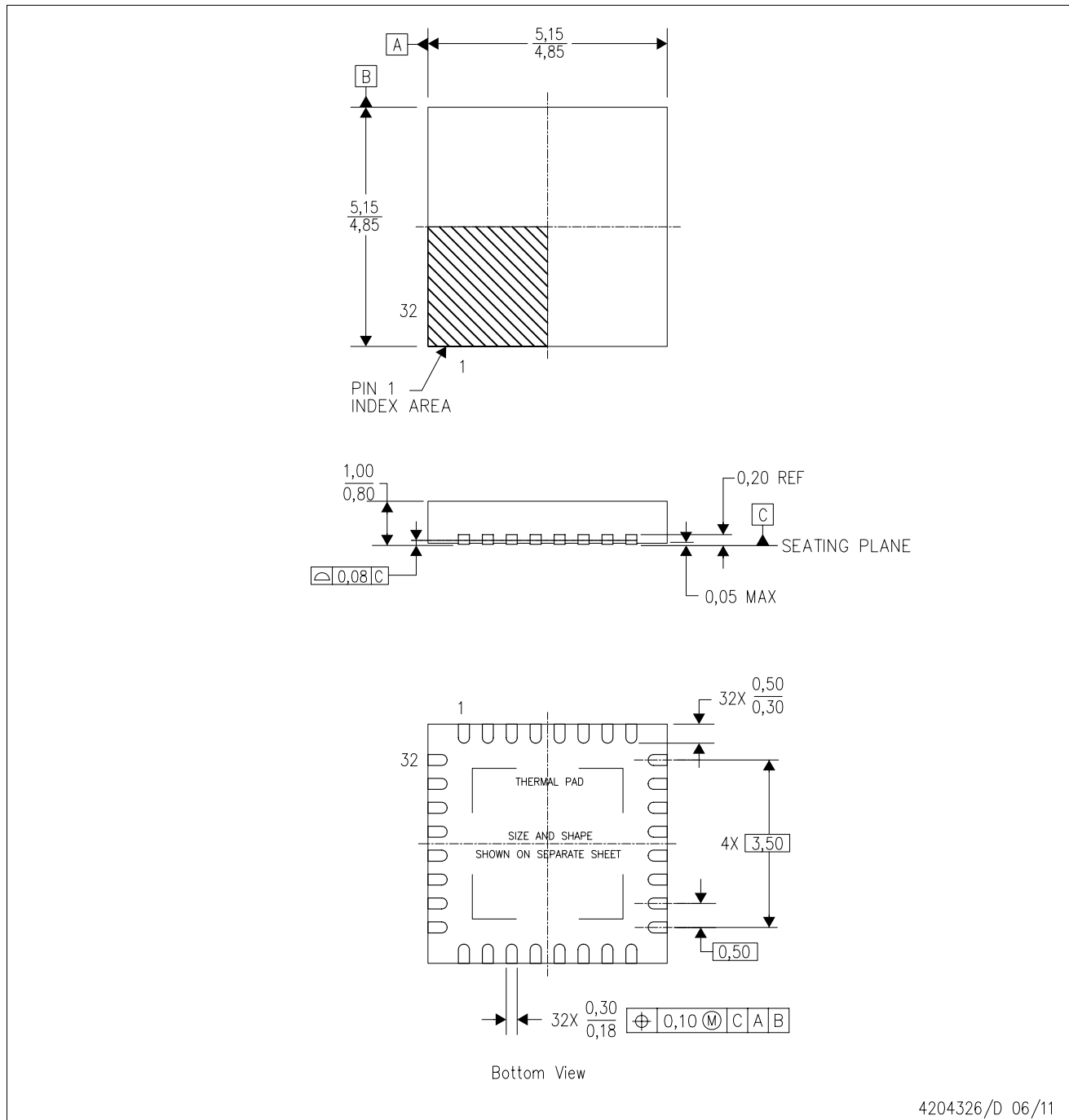
PLASTIC QUAD FLATPACK NO-LEAD



- NOTES:
- All linear dimensions are in millimeters. Dimensioning and tolerancing per ASME Y14.5M-1994.
 - This drawing is subject to change without notice.
 - QFN (Quad Flatpack No-Lead) Package configuration.
 - The package thermal pad must be soldered to the board for thermal and mechanical performance.
 - See the additional figure in the Product Data Sheet for details regarding the exposed thermal pad features and dimensions.
 - Falls within JEDEC MO-220.

THERMAL INFORMATION

This package incorporates an exposed thermal pad that is designed to be attached directly to an external heatsink. The thermal pad must be soldered directly to the printed circuit board (PCB). After soldering, the PCB can be used as a heatsink. In addition, through the use of thermal vias, the thermal pad can be attached directly to the appropriate copper plane shown in the electrical schematic for the device, or alternatively, can be attached to a special heatsink structure designed into the PCB. This design optimizes the heat transfer from the integrated circuit (IC).

For information on the Quad Flatpack No-Lead (QFN) package and its advantages, refer to Application Report, QFN/SON PCB Attachment, Texas Instruments Literature No. SLUA271. This document is available at www.ti.com.

The exposed thermal pad dimensions for this package are shown in the following illustration.

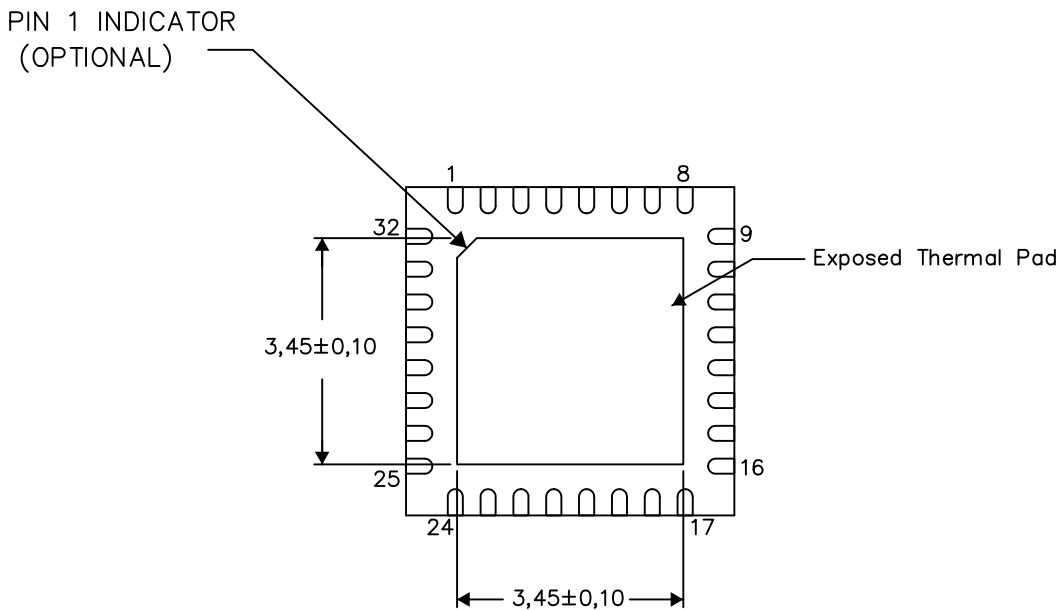

Bottom View

Exposed Thermal Pad Dimensions

4206356-2/AC 05/15

NOTE: A. All linear dimensions are in millimeters

RHB (S-PVQFN-N32)

PLASTIC QUAD FLATPACK NO-LEAD



- NOTES:
- All linear dimensions are in millimeters.
 - This drawing is subject to change without notice.
 - This package is designed to be soldered to a thermal pad on the board. Refer to Application Note, Quad Flat-Pack Packages, Texas Instruments Literature No. SLUA271, and also the Product Data Sheets for specific thermal information, via requirements, and recommended board layout. These documents are available at www.ti.com <<http://www.ti.com>>.
 - Laser cutting apertures with trapezoidal walls and also rounding corners will offer better paste release. Customers should contact their board assembly site for stencil design recommendations. Refer to IPC 7525 for stencil design considerations.
 - Customers should contact their board fabrication site for recommended solder mask tolerances and via tenting recommendations for any larger diameter vias placed in the thermal pad.

RGZ (S-PVQFN-N48)

PLASTIC QUAD FLATPACK NO-LEAD



- NOTES:
- A. All linear dimensions are in millimeters. Dimensioning and tolerancing per ASME Y14.5M-1994.
 - B. This drawing is subject to change without notice.
 - C. Quad Flatpack, No-leads (QFN) package configuration.
 - D. The package thermal pad must be soldered to the board for thermal and mechanical performance.
 - E. See the additional figure in the Product Data Sheet for details regarding the exposed thermal pad features and dimensions.
 - F. Falls within JEDEC MO-220.

THERMAL INFORMATION

This package incorporates an exposed thermal pad that is designed to be attached directly to an external heatsink. The thermal pad must be soldered directly to the printed circuit board (PCB). After soldering, the PCB can be used as a heatsink. In addition, through the use of thermal vias, the thermal pad can be attached directly to the appropriate copper plane shown in the electrical schematic for the device, or alternatively, can be attached to a special heatsink structure designed into the PCB. This design optimizes the heat transfer from the integrated circuit (IC).

For information on the Quad Flatpack No-Lead (QFN) package and its advantages, refer to Application Report, QFN/SON PCB Attachment, Texas Instruments Literature No. SLUA271. This document is available at www.ti.com.

The exposed thermal pad dimensions for this package are shown in the following illustration.

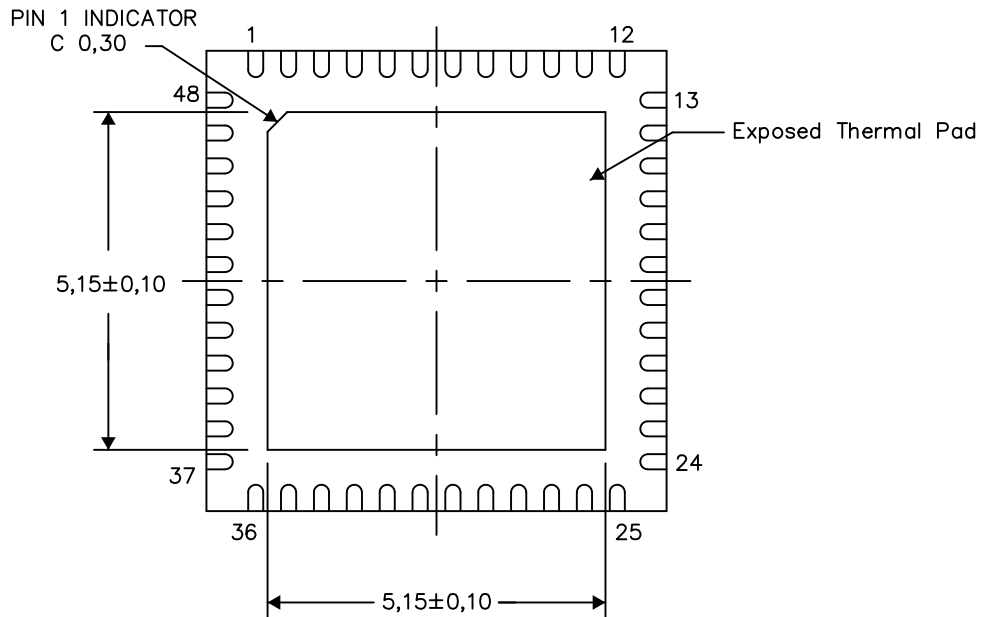

Bottom View

Exposed Thermal Pad Dimensions

4206354-2/Z 03/15

NOTE: All linear dimensions are in millimeters

RGZ (S-PVQFN-N48)

PLASTIC QUAD FLATPACK NO-LEAD

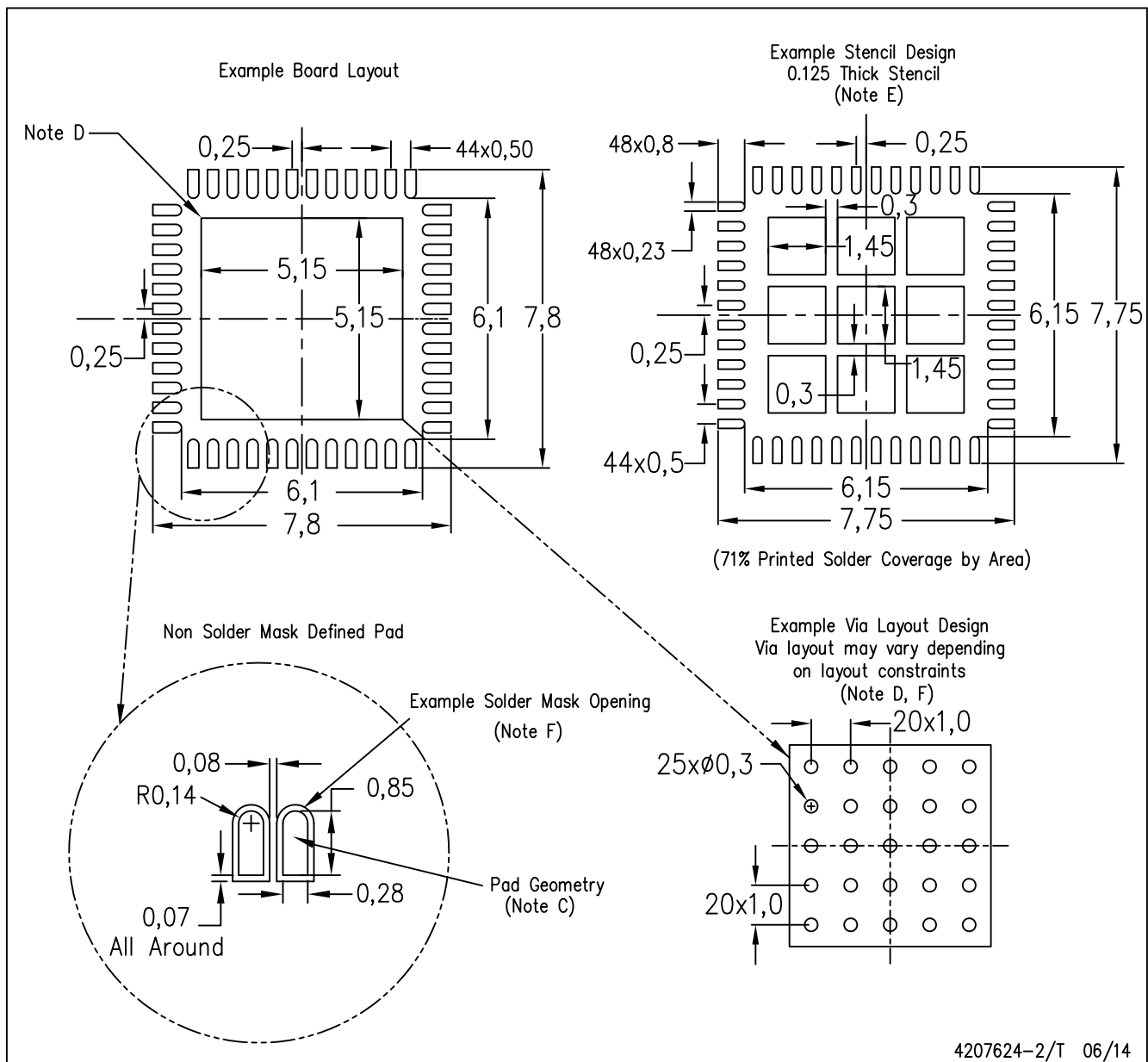

4207624-2/T 06/14

- NOTES:
- All linear dimensions are in millimeters.
 - This drawing is subject to change without notice.
 - Publication IPC-7351 is recommended for alternate designs.
 - This package is designed to be soldered to a thermal pad on the board. Refer to Application Note, Quad Flat-Pack Packages, Texas Instruments Literature No. SLUA271, and also the Product Data Sheets for specific thermal information, via requirements, and recommended board layout. These documents are available at www.ti.com <<http://www.ti.com>>.
 - Laser cutting apertures with trapezoidal walls and also rounding corners will offer better paste release. Customers should contact their board assembly site for stencil design recommendations. Refer to IPC 7525 for stencil design considerations.
 - Customers should contact their board fabrication site for recommended solder mask tolerances and via tenting recommendations for vias placed in the thermal pad.

RSM (S-PVQFN-N32)

PLASTIC QUAD FLATPACK NO-LEAD

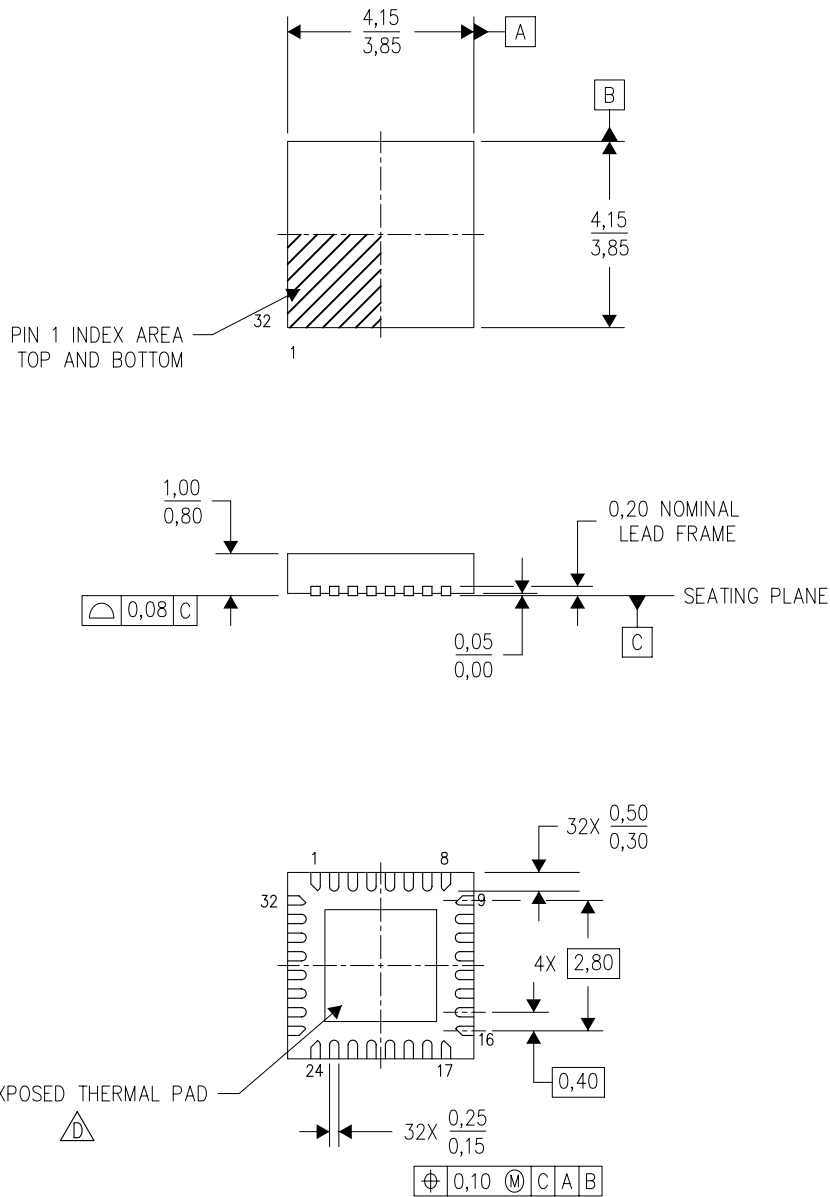

4207560/B 03/10

- NOTES:
- A. All linear dimensions are in millimeters. Dimensioning and tolerancing per ASME Y14.5M-1994.
 - B. This drawing is subject to change without notice.
 - C. QFN (Quad Flatpack No-Lead) Package configuration.
 -  The package thermal pad must be soldered to the board for thermal and mechanical performance. See the Product Data Sheet for details regarding the exposed thermal pad dimensions.

RSM (S-PVQFN-N32)

PLASTIC QUAD FLATPACK NO-LEAD

THERMAL INFORMATION

This package incorporates an exposed thermal pad that is designed to be attached directly to an external heatsink. The thermal pad must be soldered directly to the printed circuit board (PCB). After soldering, the PCB can be used as a heatsink. In addition, through the use of thermal vias, the thermal pad can be attached directly to the appropriate copper plane shown in the electrical schematic for the device, or alternatively, can be attached to a special heatsink structure designed into the PCB. This design optimizes the heat transfer from the integrated circuit (IC).

For information on the Quad Flatpack No-Lead (QFN) package and its advantages, refer to Application Report, QFN/SON PCB Attachment, Texas Instruments Literature No. SLUA271. This document is available at www.ti.com.

The exposed thermal pad dimensions for this package are shown in the following illustration.

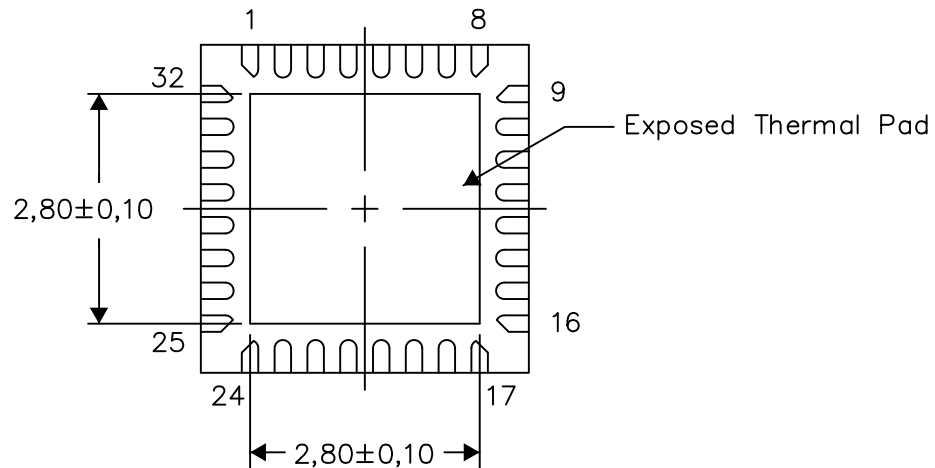

Bottom View

Exposed Thermal Pad Dimensions

4207868-2/1 07/14

NOTE: All linear dimensions are in millimeters

RSM (S-PVQFN-N32)

PLASTIC QUAD FLATPACK NO-LEAD

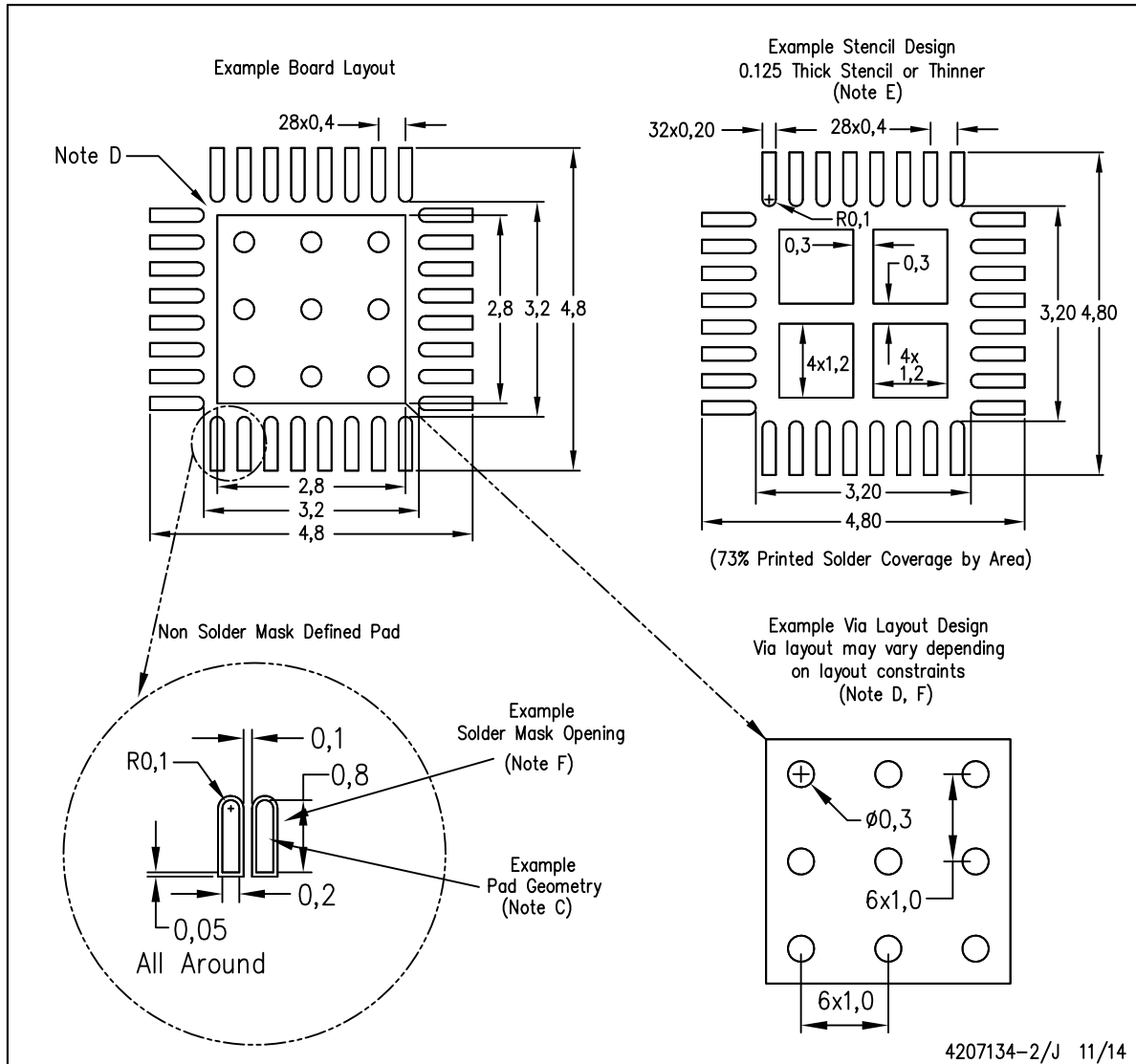

- NOTES:
- A. All linear dimensions are in millimeters.
 - B. This drawing is subject to change without notice.
 - C. Publication IPC-7351 is recommended for alternate designs.
 - D. This package is designed to be soldered to a thermal pad on the board. Refer to Application Note, Quad Flat-Pack Packages, Texas Instruments Literature No. SLUA271, and also the Product Data Sheets for specific thermal information, via requirements, and recommended board layout. These documents are available at www.ti.com <<http://www.ti.com>>.
 - E. Laser cutting apertures with trapezoidal walls and also rounding corners will offer better paste release. Customers should contact their board assembly site for stencil design recommendations. Refer to IPC 7525 for stencil design considerations.
 - F. Customers should contact their board fabrication site for recommended solder mask tolerances and via tenting recommendations for vias placed in the thermal pad.

IMPORTANT NOTICE

Texas Instruments Incorporated (TI) reserves the right to make corrections, enhancements, improvements and other changes to its semiconductor products and services per JESD46, latest issue, and to discontinue any product or service per JESD48, latest issue. Buyers should obtain the latest relevant information before placing orders and should verify that such information is current and complete.

TI's published terms of sale for semiconductor products (<http://www.ti.com/sc/docs/stdterms.htm>) apply to the sale of packaged integrated circuit products that TI has qualified and released to market. Additional terms may apply to the use or sale of other types of TI products and services.

Reproduction of significant portions of TI information in TI data sheets is permissible only if reproduction is without alteration and is accompanied by all associated warranties, conditions, limitations, and notices. TI is not responsible or liable for such reproduced documentation. Information of third parties may be subject to additional restrictions. Resale of TI products or services with statements different from or beyond the parameters stated by TI for that product or service voids all express and any implied warranties for the associated TI product or service and is an unfair and deceptive business practice. TI is not responsible or liable for any such statements.

Buyers and others who are developing systems that incorporate TI products (collectively, "Designers") understand and agree that Designers remain responsible for using their independent analysis, evaluation and judgment in designing their applications and that Designers have full and exclusive responsibility to assure the safety of Designers' applications and compliance of their applications (and of all TI products used in or for Designers' applications) with all applicable regulations, laws and other applicable requirements. Designer represents that, with respect to their applications, Designer has all the necessary expertise to create and implement safeguards that (1) anticipate dangerous consequences of failures, (2) monitor failures and their consequences, and (3) lessen the likelihood of failures that might cause harm and take appropriate actions. Designer agrees that prior to using or distributing any applications that include TI products, Designer will thoroughly test such applications and the functionality of such TI products as used in such applications.

TI's provision of technical, application or other design advice, quality characterization, reliability data or other services or information, including, but not limited to, reference designs and materials relating to evaluation modules, (collectively, "TI Resources") are intended to assist designers who are developing applications that incorporate TI products; by downloading, accessing or using TI Resources in any way, Designer (individually or, if Designer is acting on behalf of a company, Designer's company) agrees to use any particular TI Resource solely for this purpose and subject to the terms of this Notice.

TI's provision of TI Resources does not expand or otherwise alter TI's applicable published warranties or warranty disclaimers for TI products, and no additional obligations or liabilities arise from TI providing such TI Resources. TI reserves the right to make corrections, enhancements, improvements and other changes to its TI Resources. TI has not conducted any testing other than that specifically described in the published documentation for a particular TI Resource.

Designer is authorized to use, copy and modify any individual TI Resource only in connection with the development of applications that include the TI product(s) identified in such TI Resource. NO OTHER LICENSE, EXPRESS OR IMPLIED, BY ESTOPPEL OR OTHERWISE TO ANY OTHER TI INTELLECTUAL PROPERTY RIGHT, AND NO LICENSE TO ANY TECHNOLOGY OR INTELLECTUAL PROPERTY RIGHT OF TI OR ANY THIRD PARTY IS GRANTED HEREIN, including but not limited to any patent right, copyright, mask work right, or other intellectual property right relating to any combination, machine, or process in which TI products or services are used. Information regarding or referencing third-party products or services does not constitute a license to use such products or services, or a warranty or endorsement thereof. Use of TI Resources may require a license from a third party under the patents or other intellectual property of the third party, or a license from TI under the patents or other intellectual property of TI.

TI RESOURCES ARE PROVIDED "AS IS" AND WITH ALL FAULTS. TI DISCLAIMS ALL OTHER WARRANTIES OR REPRESENTATIONS, EXPRESS OR IMPLIED, REGARDING RESOURCES OR USE THEREOF, INCLUDING BUT NOT LIMITED TO ACCURACY OR COMPLETENESS, TITLE, ANY EPIDEMIC FAILURE WARRANTY AND ANY IMPLIED WARRANTIES OF MERCHANTABILITY, FITNESS FOR A PARTICULAR PURPOSE, AND NON-INFRINGEMENT OF ANY THIRD PARTY INTELLECTUAL PROPERTY RIGHTS. TI SHALL NOT BE LIABLE FOR AND SHALL NOT DEFEND OR INDEMNIFY DESIGNER AGAINST ANY CLAIM, INCLUDING BUT NOT LIMITED TO ANY INFRINGEMENT CLAIM THAT RELATES TO OR IS BASED ON ANY COMBINATION OF PRODUCTS EVEN IF DESCRIBED IN TI RESOURCES OR OTHERWISE. IN NO EVENT SHALL TI BE LIABLE FOR ANY ACTUAL, DIRECT, SPECIAL, COLLATERAL, INDIRECT, PUNITIVE, INCIDENTAL, CONSEQUENTIAL OR EXEMPLARY DAMAGES IN CONNECTION WITH OR ARISING OUT OF TI RESOURCES OR USE THEREOF, AND REGARDLESS OF WHETHER TI HAS BEEN ADVISED OF THE POSSIBILITY OF SUCH DAMAGES.

Unless TI has explicitly designated an individual product as meeting the requirements of a particular industry standard (e.g., ISO/TS 16949 and ISO 26262), TI is not responsible for any failure to meet such industry standard requirements.

Where TI specifically promotes products as facilitating functional safety or as compliant with industry functional safety standards, such products are intended to help enable customers to design and create their own applications that meet applicable functional safety standards and requirements. Using products in an application does not by itself establish any safety features in the application. Designers must ensure compliance with safety-related requirements and standards applicable to their applications. Designer may not use any TI products in life-critical medical equipment unless authorized officers of the parties have executed a special contract specifically governing such use. Life-critical medical equipment is medical equipment where failure of such equipment would cause serious bodily injury or death (e.g., life support, pacemakers, defibrillators, heart pumps, neurostimulators, and implantables). Such equipment includes, without limitation, all medical devices identified by the U.S. Food and Drug Administration as Class III devices and equivalent classifications outside the U.S.

TI may expressly designate certain products as completing a particular qualification (e.g., Q100, Military Grade, or Enhanced Product). Designers agree that it has the necessary expertise to select the product with the appropriate qualification designation for their applications and that proper product selection is at Designers' own risk. Designers are solely responsible for compliance with all legal and regulatory requirements in connection with such selection.

Designer will fully indemnify TI and its representatives against any damages, costs, losses, and/or liabilities arising out of Designer's non-compliance with the terms and provisions of this Notice.