

# SYLLABUS

## Optical Fiber Communication

Subject Code	: 10EC72	IA Marks	: 25
No. of Lecture Hrs/Week	: 04	Exam Hours	: 03
Total no. of Lecture Hrs.	: 52	Exam Marks	: 100

### PART - A

#### UNIT - 1

**OVERVIEW OF OPTICAL FIBER COMMUNICATION:** Introduction, Historical development, general system, advantages, disadvantages, and applications of optical fiber communication, optical fiber waveguides, Ray theory, cylindrical fiber (no derivations in article 2.4.4), single mode fiber, cutoff wave length, mode field diameter. Optical Fibers: fiber materials, photonic crystal, fiber optic cables specialty fibers.

**8 Hours**

#### UNIT - 2

**TRANSMISSION CHARACTERISTICS OF OPTICAL FIBERS:** Introduction, Attenuation, absorption, scattering losses, bending loss, dispersion, Intra modal dispersion, Inter modal dispersion.

**5 Hours**

#### UNIT - 3

**OPTICAL SOURCES AND DETECTORS:** Introduction, LED's, LASER diodes, Photo detectors, Photo detector noise, Response time, double hetero junction structure, Photo diodes, comparison of photo detectors.

**7 Hours**

#### UNIT - 4

**FIBER COUPLERS AND CONNECTORS:** Introduction, fiber alignment and joint loss, single mode fiber joints, fiber splices, fiber connectors and fiber couplers.

**6 Hours**

**PART - B****UNIT - 5**

**OPTICAL RECEIVER:** Introduction, Optical Receiver Operation, receiver sensitivity, quantum limit, eye diagrams, coherent detection, burst mode receiver operation, Analog receivers.

**6 Hours****UNIT - 6**

**ANALOG AND DIGITAL LINKS:** Analog links – Introduction, overview of analog links, CNR, multichannel transmission techniques, RF over fiber, key link parameters, Radio over fiber links, microwave photonics.

Digital links – Introduction, point-to-point links, System considerations, link power budget, resistive budget, short wave length band, transmission distance for single mode fibers, Power penalties, nodal noise and chirping.

**8 Hours****UNIT - 7**

**WDM CONCEPTS AND COMPONENTS:** WDM concepts, overview of WDM operation principles, WDM standards, Mach-Zehnder interferometer, multiplexer, Isolators and circulators, direct thin film filters, active optical components, MEMS technology, variable optical attenuators, tunable optical fibers, dynamic gain equalizers, optical drop multiplexers, polarization controllers, chromatic dispersion compensators, tunable light sources.

**6 Hours****UNIT - 8**

**OPTICAL AMPLIFIERS AND NETWORKS:** optical amplifiers, basic applications and types, semiconductor optical amplifiers, EDFA. Optical Networks: Introduction, SONET / SDH, Optical Interfaces, SONET/SDH rings, High – speed light – waveguides.

**6 Hours****TEXT BOOKS:**

1. **Optical Fiber Communication** – Gerd Keiser, 4<sup>th</sup> Ed., MGH, 2008.
2. **Optical Fiber Communications** – John M. Senior, Pearson Education. 3<sup>rd</sup> Impression, 2007.

**REFERENCE BOOK:**

1. **Fiber optic communication** – Joseph C Palais: 4<sup>th</sup> Edition, Pearson Education.

## INDEX SHEET

SLNO.	Unit & Topic of Discussion	PAGE NO.
1.	<b>UNIT 1 : OVERVIEW OF OPTICAL FIBER COMMUNICATION</b>	6-63
2.	Historical development	7
3.	General system	8
4.	Advantages, disadvantages	11,12
5.	Applications of optical fiber communication	13
6.	Optical fiber waveguides	14
7.	Ray theory, cylindrical fiber	15
8.	Single mode fiber, cutoff wave length	22
9.	Mode field diameter	50
10.	Optical Fibers: fiber materials	51
11.	Photonic crystal	52
12.	Fiber optic cables specialty fibers	60
13.	<b>UNIT 2 : TRANSMISSION CHARACTERISTICS OF OPTICAL FIBERS</b>	64-97
14.	Introduction, Attenuation	65
15.	Absorption, scattering losses	65
16.	Bending loss, dispersion	66
17.	Intra modal dispersion	80
18.	Inter modal dispersion	80
19.	<b>UNIT – 3 : OPTICAL SOURCES AND DETECTORS</b>	98-133
20.	Introduction, LED's	99

21.	LASER diodes	100
22.	Photo detectors	121
23.	Photo detector noise, Response time	123
24.	Double hetero junction structure	125
25.	Photo diodes	127
26.	Comparison of photo detectors	131
27.	<b>UNIT – 4 : FIBER COUPLERS AND CONNECTORS</b>	134-154
28.	Introduction, fiber alignment	135
29.	Joint loss	138
30.	Single mode fiber joints	140
31.	Fiber splices	143
32.	Fiber connectors	148
33.	Fiber couplers	151
34.	<b>UNIT – 5 OPTICAL RECEIVER</b>	155-175
35.	Introduction, Optical Receiver Operation	156
36.	Receiver sensitivity	158
37.	Quantum limit, eye diagrams	159
38.	Coherent detection	160
39.	Burst mode receiver operation	164
40.	Analog receivers	170
41.	<b>UNIT – 6 : Analog and Digital Links</b>	176-203
42.	Analog links – Introduction, overview of analog links	177
43.	CNR, multichannel transmission techniques	179

44.	RF over fiber, key link parameters	182
45.	Radio over fiber links, microwave photonics	185
46.	Digital links – Introduction, point-to-point links, System considerations	190
47.	Link power budget, resistive budget, short wave length band	193
48.	Transmission distance for single mode fibers	194
49.	Power penalties, nodal noise and chirping	199
50.	<b>UNIT – 7 : WDM CONCEPTS AND COMPONENTS</b>	204-224
51.	WDM concepts, overview of WDM operation principles, WDM standards,	205
52.	Mach-Zehender interferometer, multiplexer, Isolators and circulators	207
53.	Direct thin film filters, active optical components	208
54.	MEMS technology, variable optical attenuators, tunable optical fibers	210
55.	Dynamic gain equalizers, optical drop multiplexers, polarization controllers	212
56.	Chromatic dispersion compensators, tunable light sources	220
57.	<b>UNIT – 8 : OPTICAL AMPLIFIERS AND NETWORKS</b>	225-254
58.	Optical amplifiers, basic applications and types	226
59.	Semiconductor optical amplifiers, EDFA	228
60.	Optical Networks: Introduction, SONET / SDH	232
61.	Optical Interfaces	235
62.	SONET/SDH rings	245
63.	High – speed light – waveguides	251

## **UNIT - 1**

### **OVERVIEW OF OPTICAL FIBER COMMUNICATION**

Introduction, Historical development, general system, advantages, disadvantages, and applications of optical fiber communication, optical fiber waveguides, Ray theory, cylindrical fiber (no derivations in article 2.4.4), single mode fiber, cutoff wave length, mode field diameter. Optical Fibers: fiber materials, photonic crystal, fiber optic cables specialty fibers.

#### **RECOMMENDED READINGS:**

#### **TEXT BOOKS:**

1. **Optical Fiber Communication** – Gerd Keiser, 4<sup>th</sup> Ed., MGH, 2008.
2. **Optical Fiber Communications**– – John M. Senior, Pearson Education. 3<sup>rd</sup> Impression, 2007.

#### **REFERENCE BOOK:**

1. **Fiber optic communication** – Joseph C Palais: 4<sup>th</sup> Edition, Pearson Education.

### 1.1. Historical Development

- Fiber optics deals with study of propagation of light through transparent dielectric waveguides. The fiber optics are used for transmission of data from point to point location. Fiber optic systems currently used most extensively as the transmission line between terrestrial hardwired systems.
- The carrier frequencies used in conventional systems had the limitations in handling the volume and rate of the data transmission. The greater the carrier frequency larger the available bandwidth and information carrying capacity.

#### First generation

- The first generation of lightwave systems uses GaAs semiconductor laser and operating region was near  $0.8 \mu\text{m}$ . Other specifications of this generation are as under:
  - i) Bit rate : 45 Mb/s
  - ii) Repeater spacing : 10 km

#### Second generation

- i) Bit rate : 100 Mb/s to 1.7 Gb/s
- ii) Repeater spacing : 50 km
- iii) Operation wavelength :  $1.3 \mu\text{m}$
- iv) Semiconductor : In GaAsP

#### Third generation

- i) Bit rate : 10 Gb/s
- ii) Repeater spacing : 100 km
- iii) Operating wavelength :  $1.55 \mu\text{m}$

**Fourth generation**

Fourth generation uses WDM technique.

Bit rate	: 10 Tb/s
Repeater spacing	: > 10,000 km
Operating wavelength	: 1.45 to 1.62 $\mu\text{m}$

**Fifth generation**

Fifth generation uses Raman amplification technique and optical solitons.

Bit rate	: 40 - 160 Gb/s
Repeater spacing	: 24000 km - 35000 km
Operating wavelength	: 1.53 to 1.57 $\mu\text{m}$

**Need of fiber optic communication**

- Fiber optic communication system has emerged as most important communication system. Compared to traditional system because of following requirements :
  1. In long haul transmission system there is need of low loss transmission medium
  2. There is need of compact and least weight transmitters and receivers.
  3. There is need of increase dspan of transmission.
  4. There is need of increased bit rate-distance product.
- A fiber optic communication system fulfills these requirements, hence most widely acception.

**1.2 General Optical Fiber Communication System**

- Basic block diagram of optical fiber communication system consists of following important blocks.
  1. Transmitter
  2. Information channel
  3. Receiver.



Fig. 1.2.1 shows block diagram of OFC system.

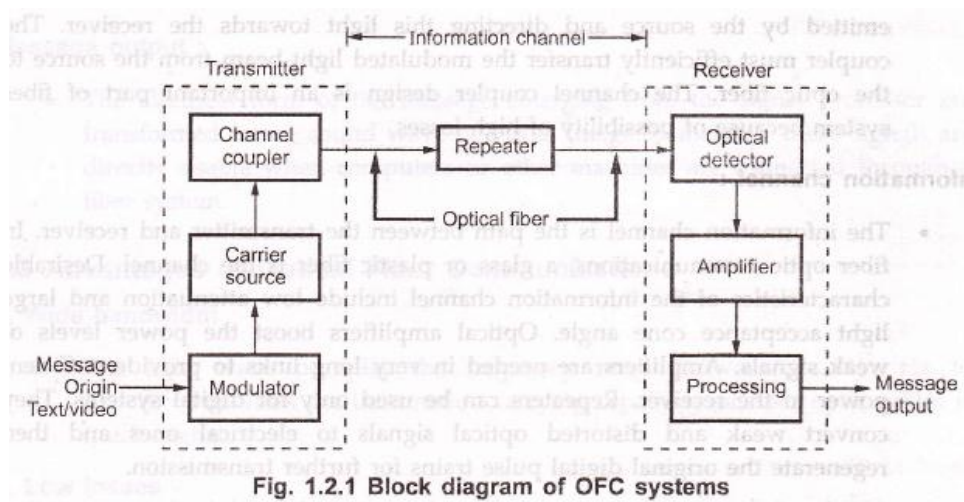

### Message origin :

- Generally message origin is from a transducer that converts a non-electrical message into an electrical signal. Common examples include microphones for converting sound waves into currents and video (TV) cameras for converting images into current. For data transfer between computers, the message is already in electrical form.

### Modulator :

- The modulator has two main functions.
  - 1) It converts the electrical message into the proper format.
  - 2) It impresses this signal onto the wave generated by the carrier source.

Two distinct categories of modulation are used i.e. analog modulation and digital modulation.

### Carrier source :

- Carrier source generates the wave on which the information is transmitted. This wave is called the carrier. For fiber optic system, a laser diode (LD) or a light emitting diode (LED) is used. They can be called as optic oscillators, they provide stable, single frequency waves with sufficient power for long distance propagation.

**Channel coupler :**

- Coupler feeds the power into the information channel. For an atmospheric optic system, the channel coupler is a lens used for collimating the light emitted by the source and directing this light towards the receiver. The coupler must efficiently transfer the modulated light beam from the source to the optic fiber. The channel coupler design is an important part of fiber system because of possibility of high losses.

**Information channel :**

- The information channel is the path between the transmitter and receiver. In fiber optic communications, a glass or plastic fiber is the channel. Desirable characteristics of the information channel include low attenuation and large light acceptance cone angle. Optical amplifiers boost the power levels of weak signals. Amplifiers are needed in very long links to provide sufficient power to the receiver. Repeaters can be used only for digital systems. They convert weak and distorted optical signals to electrical ones and then regenerate the original digital pulse trains for further transmission.
- Another important property of the information channel is the propagation time of the waves travelling along it. A signal propagating along a fiber normally contains a range of optic frequencies and divides its power along several ray paths. This results in a distortion of the propagating signal. In a digital system, this distortion appears as a spreading and deforming of the pulses. The spreading is so great that adjacent pulses begin to overlap and become unrecognizable as separate bits of information.

**Optical detector :**

- The information being transmitted is detected. In the fiber system the optic wave is converted into an electric current by a photodetector. The current developed by the detector is proportional to the power in the incident optic wave. Detector output current contains the transmitted information. This detector output is then filtered to remove the constant bias and then amplified.
- The important properties of photodetectors are small size, economy, long life, low power consumption, high sensitivity to optic signals and fast response to quick variations in the optic power.

**Signal processing :**

- Signal processing includes filtering, amplification. Proper filtering maximizes the ratio of signal to unwanted power. For a digital system decision circuit is an additional block. The bit error rate (BER) should be very small for quality communications.

**Message output :**

- The electrical form of the message emerging from the signal processor are transformed into a sound wave or visual image. Sometimes these signals are directly usable when computers or other machines are connected through a fiber system.

**1.3 Advantages of Optical Fiber Communications****1. Wide bandwidth**

- The light wave occupies the frequency range between  $2 \times 10^{12}$  Hz to  $3.7 \times 10^{12}$  Hz. Thus the information carrying capability of fiber optic cables is much higher.

**2. Low losses**

- Fiber optic cables offers very less signal attenuation over long distances. Typically it is less than 1 dB/km. This enables longer distance between repeaters.

**3. Immune to cross talk**

- Fiber optic cables has very high immunity to electrical and magnetic field. Since fiber optic cables are non-conductors of electricity hence they do not produce magnetic field. Thus fiber optic cables are immune to cross talk between cables caused by magnetic induction.

**4. Interference immune**

- Fiber optic cable is immune to conductive and radiative interferences caused by electrical noise sources such as lighting, electric motors, fluorescent lights.

**5. Light weight**

- As fiber cables are made of silica glass or plastic which is much lighter than copper or aluminium cables. Light weight fiber cables are cheaper to transport.

**6. Small size**

- The diameter of fiber is much smaller compared to other cables, therefore fiber cable is small in size, requires less storage space.

**7. More strength**

- Fiber cables are stronger and rugged hence can support more weight.

**8. Security**

- Fiber cables are more secure than other cables. It is almost impossible to tap into a fiber cable as they do not radiate signals.

No ground loops exist between optical fibers hence they are more secure.

**9. Long distance transmission**

- Because of less attenuation transmission at a longer distance is possible.

**10. Environment immune**

- Fiber cables are more immune to environmental extremes. They can operate over a large temperature variations. Also they are not affected by corrosive liquids and gases.

**11. Safe and easy installation**

- Fiber cables are safer and easier to install and maintain. They are non-conductors hence there is no shock hazards as no current or voltage is associated with them. Their small size and light weight feature makes installation easier.

**12. Less cost**

- Cost of fiber optic system is less compared to any other system.

**1.4 Disadvantages of Optical Fiber Communications****1. High initial cost**

- The initial cost of installation or setting up cost is very high compared to all other systems.

**2. Maintenance and repairing cost**

- The maintenance and repaiding of fiber optic systems is not only difficult but expensive also.

### **3. Jointing and test procedures**

- Since optical fibers are of very small size. The fiber joining process is very constly and requires skilled manpower.

### **4. Tensile stress**

- Optical fibers are more susceptible to buckling, bending and tensile stress than copper cables. This leades to restricted practice to use optical fiber technology to premises and floor backbones with a few interfaces to the copper cables.

### **5. Short links**

- Eventhough optical fiber calbes are inexpensive, it is still not cost effective to replace every small conventional connector (e.g. between computers and peripherals), as the price of optoelectronic transducers are very high.

### **6. Fiber losses**

- The amount of optical fiber available to the photodetector at the end of fiber length depends on various fiber losses such as scattering, dispersion, attenuation and reflection.

## **1.5 Applications of Optical Fiber Communicaitons**

- Applications of optical fiber communications include telecommunications, data communications, video control and protection switching, sensors and power applications.

### **1. Telephone networks**

- Optical waveguide has low attenuation, high transmission bandwidth compated to copper lines, therefore numbers of long haul co-axial trunks l;links between telephone exchanges are being replaced by optical fiber links.

### **2. Urban broadband service networks**

- Optical waveguide provides much larger bandwidth than co-axial calbe, also the number of repeaters required is reduced considerably.

- Modern suburban communications involves videotext, videoconferencing videotelephony, switched broadband communication network. All these can be supplied over a single fiber optic link. Fiber optic cables is the solution to many of today's high speed, high bandwidth data communication problems and will continue to play a large role in future telecom and data-com networks.

### 1.6 Optical Fiber Waveguides

- In free space light travels at its maximum possible speed i.e.  $3 \times 10^8$  m/s or  $186 \times 10^3$  miles/sec. When light travels through a material it exhibits certain behavior explained by laws of reflection, refraction.

#### Electromagnetic Spectrum

- The radio waves and light are electromagnetic waves. The rate at which they alternate in polarity is called their frequency (f) measured in hertz (Hz). The speed of electromagnetic wave (c) in free space is approximately  $3 \times 10^8$  m/sec. The distance travelled during each cycle is called as wavelength ( $\lambda$ )

$$\text{Wavelength } (\lambda) = \frac{\text{Speed of light}}{\text{Frequency}} = \frac{c}{f}$$

- In fiber optics, it is more convenient to use the wavelength of light instead of the frequency with light frequencies, wavelength is often stated in microns or nanometers.

$$1 \text{ micron } (\mu) = 1 \text{ Micrometre } (1 \times 10^{-6})$$

$$1 \text{ nano } (n) = 10^{-9} \text{ metre}$$

Fig. 1.6.1 shows electromagnetic frequency spectrum.

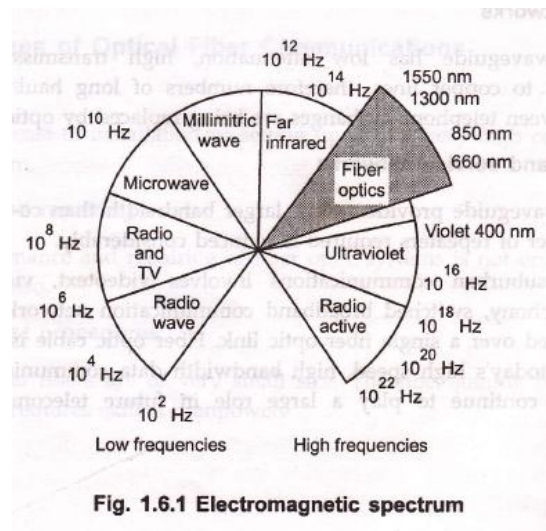

- Fiber optics uses visible and infrared light. Infrared light covers a fairly wide range of wavelengths and is generally used for all fiber optic communications. Visible light is normally used for very short range transmission using a plastic fiber.

### Ray Transmission Theory

- Before studying how the light actually propagates through the fiber, laws governing the nature of light must be studied. These were called as **laws of optics (Ray theory)**. There is a conception that light always travels at the same speed. This fact is simply not true. The speed of light depends upon the material or medium through which it is moving. In free space light travels at its maximum possible speed i.e.  $3 \times 10^8$  m/s or  $186 \times 10^3$  miles/sec. When light travels through a material it exhibits certain behavior explained by laws of reflection, refraction.

### Reflection

- The law of reflection states that, when a light ray is incident upon a reflective surface at some incident angle  $\phi_1$  from imaginary perpendicular normal, the ray will be reflected from the surface at some angle  $\phi_2$  from normal which is equal to the angle of incidence.

Fig. 1.6.2 shows law of reflection.

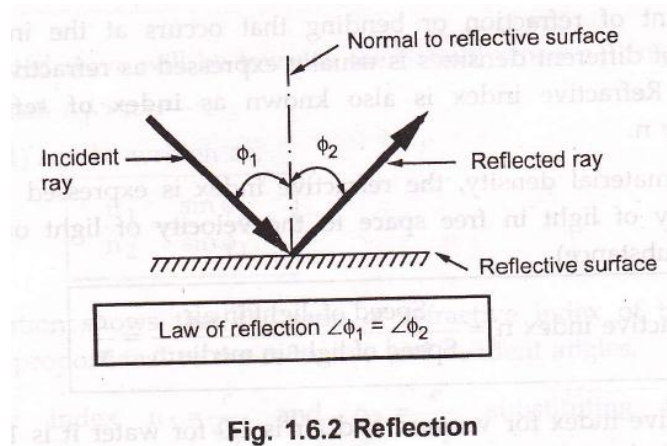

Fig. 1.6.2 Reflection

## Refraction

- Refraction occurs when light ray passes from one medium to another i.e. the light ray changes its direction at interface. Refraction occurs whenever density of medium changes. E.g. refraction occurs at air and water interface, the straw in a glass of water will appear as it is bent.

The refraction can also be observed at air and glass interface.

- When a wave passes through a less dense medium to a more dense medium, the wave is refracted (bent) towards the normal. Fig. 1.6.3 shows the refraction phenomena.
- The refraction (bending) takes place because light travels at different speeds in different mediums. The speed of light in free space is higher than in water or glass.

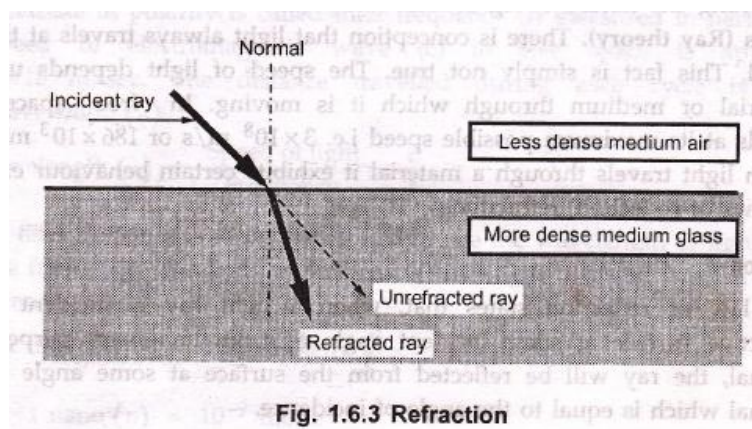



## Refractive Index

- The amount of refraction or bending that occurs at the interface of two materials of different densities is usually expressed as refractive index of two materials. Refractive index is also known as **index of refraction** and is denoted by  $n$ .
- Based on material density, the refractive index is expressed as the ratio of the velocity of light in free space to the velocity of light of the dielectric material (substance).

$$\text{Refractive index } n = \frac{\text{Speed of light in air}}{\text{Speed of light in medium}} = \frac{c}{v}$$

The refractive index for vacuum and air is 1.0 for water it is 1.3 and for glass refractive index is 1.5.

## Snell's Law

- Snell's law states how light ray reacts when it meets the interface of two media having different indexes of refraction.
- Let the two medias have refractive indexes  $n_1$  and  $n_2$  where  $n_1 > n_2$ .

$\phi_1$  and  $\phi_2$  be the angles of incidence and angle of refraction respectively. Then according to Snell's law, a relationship exists between the refractive index of both materials given by,

$$n_1 \sin \phi_1 = n_2 \sin \phi_2$$

... (1.6.1)

- A refractive index model for Snell's law is shown in Fig. 1.6.4.

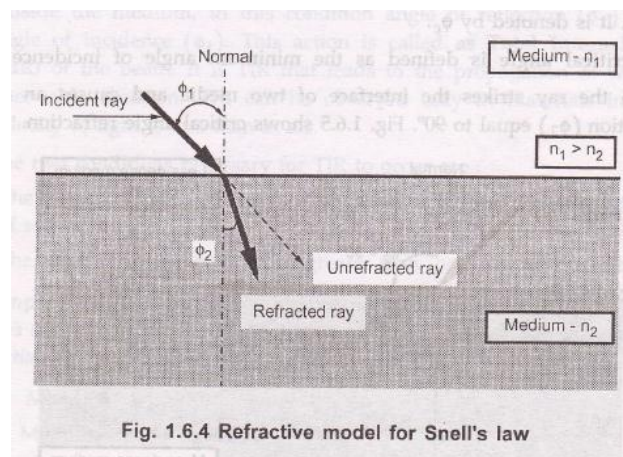

Fig. 1.6.4 Refractive model for Snell's law

- The refracted wave will be towards the normal when  $n_1 < n_2$  and will away from it when  $n_1 > n_2$ .

Equation (1.6.1) can be written as,

$$\frac{n_1}{n_2} = \frac{\sin \theta_2}{\sin \theta_1}$$

- This equation shows that the ratio of refractive index of two mediums is inversely proportional to the refractive and incident angles.

As refractive index  $n_1 = \frac{c}{v_1}$  and  $n_2 = \frac{c}{v_2}$  substituting these values in equation (1.6.2)

$$\frac{c/v_1}{c/v_2} = \frac{\sin \phi_2}{\sin \phi_1}$$

$$\frac{v_2}{v_1} = \frac{\sin \phi_2}{\sin \phi_1}$$

### Critical Angle

- When the angle of incidence ( $\phi_1$ ) is progressively increased, there will be progressive increase of refractive angle ( $\phi_2$ ). At some condition ( $\phi_1$ ) the refractive angle ( $\phi_2$ ) becomes  $90^\circ$  to the normal. When this happens the refracted light ray travels along the interface. The angle of incidence ( $\phi_1$ ) at the point at which the refractive angle ( $\phi_2$ ) becomes  $90^\circ$  is called the critical angle. It is denoted by  $\phi_c$ .
- The **critical angle** is defined as the minimum angle of incidence ( $\phi_1$ ) at which the ray strikes the interface of two media and causes an angle of refraction ( $\phi_2$ ) equal to  $90^\circ$ . Fig 1.6.5 shows critical angle refraction.

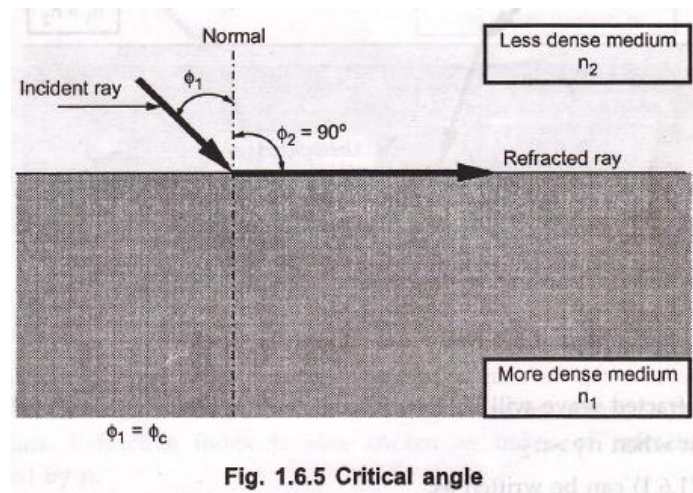

Hence at critical angle  $\phi_1 = \phi_c$  and  $\phi_2 = 90^\circ$

Using Snell's law :  $n_1 \sin \phi_1 = n_2 \sin \phi_2$

$$\sin \phi_c = \frac{n_2}{n_1} \sin 90^\circ$$

$$\therefore \sin 90^\circ = 1$$

Therefore,  $\sin \phi_c = \frac{n_2}{n_1}$

$$\text{Critical angle } \phi_c = \sin^{-1} \left( \frac{n_2}{n_1} \right)$$

... (1.6.3)

- The actual value of critical angle is dependent upon combination of materials present on each side of boundary.

### Total Internal Reflection (TIR)

- When the incident angle is increased beyond the critical angle, the light ray does not pass through the interface into the other medium. This gives the effect of a mirror existing at the interface with no possibility of light escaping outside the medium. In this condition, the angle of reflection ( $\phi_2$ ) is equal to the angle of incidence ( $\phi_1$ ). This action is called as **Total Internal Reflection (TIR)** of the beam. It is TIR that leads to the propagation of waves within a fiber-cable medium. TIR can be observed only in materials in which the velocity of light is less than in air.
- The two conditions necessary for TIR to occur are :

1. The refractive index of first medium must be greater than the refractive index of second one.
2. The angle of incidence must be greater than (or equal to) the critical angle.

**Example 1.6.1 :** A light ray is incident from medium-1 to medium-2. If the refractive indices of medium-1 and medium-2 are 1.5 and 1.36 respectively then determine the angle of refraction for an angle of incidence of  $30^\circ$ .

**Solution :** Medium-1  $n_1 = 1.5$

Medium-2  $n_2 = 1.36$

Angle of incidence  $\phi_1 = 30^\circ$ .

Angle of incident  $\phi_2 = ?$

$$\text{Snell's law : } n_1 \sin \phi_1 = n_2 \sin \phi_2$$

$$1.5 \sin 30^\circ = 1.36 \sin \phi_2$$

$$\sin \phi_2 = \frac{1.5}{1.36} \sin 30^\circ$$

$$\sin \phi_2 = 0.55147$$

$$\therefore \phi_2 = 33.46^\circ$$

Angle of refraction  $33.46^\circ$  from normal.

... Ans.

**Example 1.6.2 :** A light ray is incident from glass to air. Calculate the critical angle ( $\phi_c$ ).

**Solution :** Refractive index of glass  $n_1 = 1.50$

Refractive index of air  $n_2 = 1.00$

$$\text{Snell's law : } n_1 \sin \phi_1 = n_2 \sin \phi_2$$

$$\sin \phi_1 = \frac{n_2}{n_1} \sin \phi_2$$

From definition of critical angle,  $\phi_2 = 90^\circ$  and  $\phi_1 = \phi_c$ .

$$\therefore \sin \phi_1 = \frac{n_2}{n_1} \sin 90^\circ$$

$$\sin \phi_c = \left( \frac{1.0}{1.5} \right) \times 1 = 0.67$$

$$\therefore \phi_c = \sin^{-1} 0.67$$

$$\phi_c = 41.81^\circ$$

Critical angle  $\phi_c = 41.81^\circ$

... Ans.

**Example 1.6.3 :** Calculate the NA, acceptance angle and critical angle of the fiber having  $n_1$  (Core refractive index) = 1.50 and refractive index of cladding = 1.45.

**Solution :**  $n_1 = 1.50$ ,  $n_2 = 1.45$

$$\Delta = \frac{(n_1 - n_2)}{(n_1)} = \frac{1.50 - 1.45}{1.50} = 0.033$$

Numerical aperture,  $NA = n_1 \sqrt{2\Delta}$

$$NA = 1.50 \sqrt{2 \times 0.033}$$

$$NA = 0.387$$

Acceptance angle  $\phi_0 = \sin^{-1} NA$

$$\phi_0 = \sin^{-1} 0.387$$

$$\phi_0 = 22.78^\circ$$

Critical angle  $\phi_c = \sin^{-1} \frac{n_2}{n_1}$

$$\phi_c = \sin^{-1} \frac{1.45}{1.50}$$

$$\phi_c = 75.2^\circ$$

## Optical Fiver as Waveguide

- An optical fiber is a cylindrical dielectric waveguide capable of conveying electromagnetic waves at optical frequencies. The electromagnetic energy is in the form of the light and propagates along the axis of the fiber. The structural of the fiver determines the transmission characteristics.
- The propagation of light along the waveguide is decided by the modes of the waveguides, here mode means path. Each mode has distict pattern of electric and magnetic field distributions along the fiber length. Only few modes can satisfy the homogeneous wave equation in the fiver also the boundary condition a waveguide surfaces. When there is only one path for light to follow then it is called as single mode propagation. When there is more than one path then it is called as multimode propagation.

### Single fiber structure

- A single fiber structure is shown in Fig. 1.6.6. It consists of a solid dielectric cylinder with radius 'a'. This cylinder is called as **core** of fiber. The core is surrounded by dielectric, called **cladding**. The index of refraction of core (glass fiver) is slightly greater than the index of refraction of cladding.

If refractive index of core (glass fiver) =  $n_1$

and refractive index of cladding =  $n_2$

then  $n_1 > n_2$ .

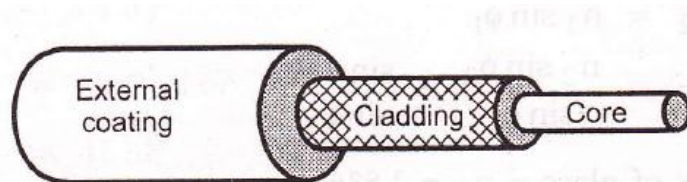

**Fig. 1.6.6 Single optical fiber structure**

## Propagation in Optical Fiber

- To understand the general nature of light wave propagation in optical fiber. We first consider the construction of optical fiber. The innermost is the glass core of very thin diameter with a slight lower refractive index  $n_2$ . The light wave can propagate along such a optical fiber. A single mode propagation is illustrated in Fig. 1.6.7 along with standard size of fiber.

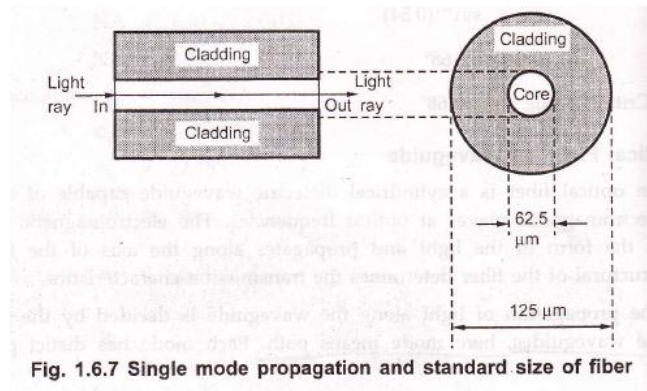

Fig. 1.6.7 Single mode propagation and standard size of fiber

- Single mode fibers are capable of carrying only one signal of a specific wavelength.
- In multimode propagation the light propagates along the fiber in zigzag fashion, provided it can undergo total internal reflection (TIR) at the core cladding boundaries.
- Total internal reflection at the fiber wall can occur only if two conditions are satisfied.

#### Condition 1:

The index of refraction of glass fiber must be slightly greater than the index of refraction of material surrounding the fiber (cladding).

If refractive index of glass fiber =  $n_1$

and refractive index of cladding =  $n_2$

then  $n_1 > n_2$ .

#### Condition 2 :

The angle of incidence ( $\phi_1$ ) of light ray must be greater than critical angle ( $\phi_c$ ).

- A light beam is focused at one end of cable. The light enters the fibers at different angles. Fig. 1.6.8 shows the conditions exist at the launching end of optic fiber. The light source is surrounded by air and the refractive index of air is  $n_0 = 1$ . Let the incident ray makes an angle  $\phi_0$  with fiber axis. The ray enters into glass fiber at point P making refracted angle  $\phi_1$  to the fiber axis, the ray is then propagated diagonally down the core and reflect from the core wall at point Q. When the light ray reflects off the inner surface, the angle of incidence is equal to the angle of reflection, which is greater than critical angle.
- In order for a ray of light to propagate down the cable, it must strike the core cladding interface at an angle that is greater than critical angle ( $\phi_c$ ).

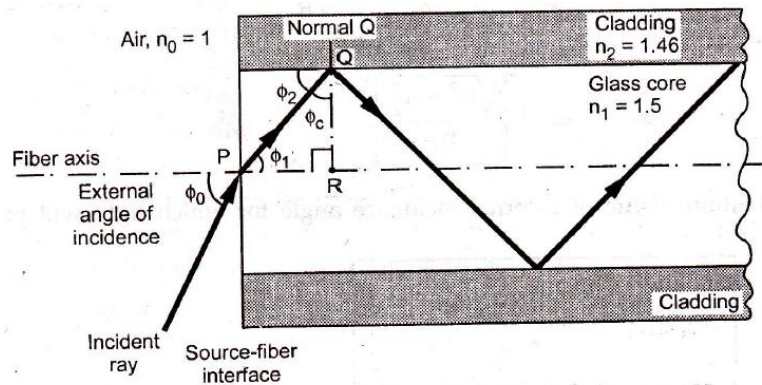

Fig. 1.6.8 Ray propagation by TIR

### Acceptance Angle

Applying Snell's law to external incidence angle.

$$n_0 \sin \phi_0 = n_1 \sin \phi_1$$

But  $\phi_1 = (90 - \phi_c)$

$$\sin \phi_1 = \sin (90 - \phi_c) = \cos \phi_c$$

Substituting  $\sin \phi_1$  in above equation.

$$n_0 \sin \phi_0 = n_1 \cos \phi_c$$

$$\sin \phi_c = \frac{n_1}{n_0} \cos \phi_c$$

Applying Pythagorean theorem to  $\Delta PQR$ .

$$\cos \phi_c = \frac{\sqrt{n_1^2 - n_2^2}}{n_1}$$

$$\sin \phi_0 = \frac{n_1}{n_0} \left[ \frac{\sqrt{n_1^2 - n_2^2}}{n_1} \right]$$

$$\sin \phi_0 = \left[ \frac{\sqrt{n_1^2 - n_2^2}}{n_0} \right]$$



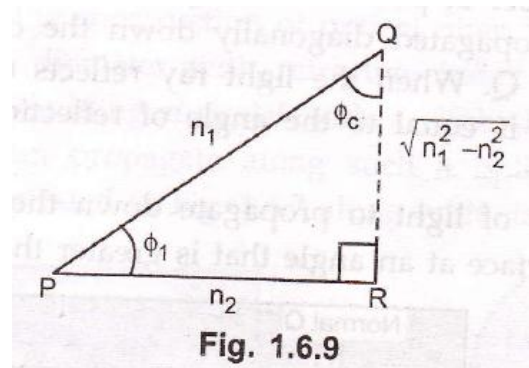

$$\phi_0 = \sin^{-1} \left[ \frac{\sqrt{n_1^2 - n_2^2}}{n_0} \right]$$

The maximum value of external incidence angle for which light will propagate in the fiber.

$$\phi_{0(\max)} = \sin^{-1} \left[ \frac{\sqrt{n_1^2 - n_2^2}}{n_0} \right]$$

When the light rays enters the fibers from an air medium  $n_0 = 1$ . Then above equation reduces to,

$$\phi_{0(\max)} = \sin^{-1} \left( \sqrt{n_1^2 - n_2^2} \right)$$

The angle  $\phi_0$  is called as **acceptance angle** and  $\phi_{0(\max)}$  defines the maximum angle in which the light ray may incident on fiber to propagate down the fiber.

### Acceptance Cone

- Rotating the acceptance angle  $\phi_{0(\max)}$  around the fiber axis, a cone shaped pattern is obtained, it is called as **acceptance cone** of the fiber input. Fig 1.6.10 shows formation of acceptance cone of a fiber cable.

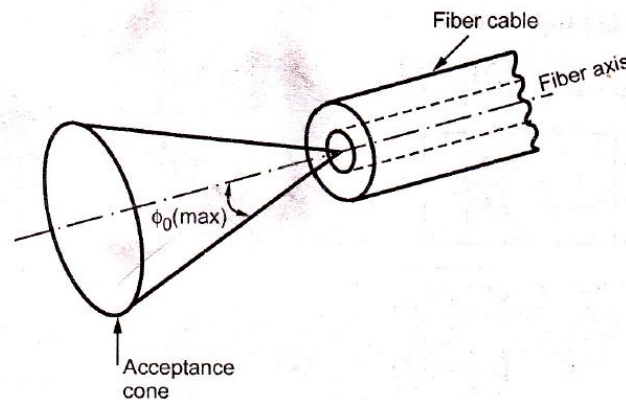

Fig. 1.6.10 Acceptance cone of a fiber cable

- The Cone of acceptance is the angle within which the light is accepted into the core and is able to travel along the fiber. The launching of light wave becomes easier for large acceptance come.
- The angle is measured from the axis of the positive cone so the total angle of convergence is actually twice the stated value.

### Numerical Aperture (NA)

- The **numerical aperture** (NA) of a fiber is a figure of merit which represents its light gathering capability. Larger the numerical aperture, the greater the amount of light accepted by fiber. The acceptance angle also determines how much light is able to be enter the fiber and hence there is relation between the numerical aperture and the cone of acceptance.

Numerical aperture (NA) =  $\sin \phi_{0(max)}$

$$NA = \frac{\sqrt{n_1^2 - n_2^2}}{n_0}$$

For air  $n_0 = 1$

$$\therefore NA = \sqrt{n_1^2 - n_2^2}$$

$$NA = \sqrt{n_{core}^2 - n_{cladding}^2}$$

... (1.6.4)

Hence acceptance angle =  $\sin^{-1} NA$

By the formula of NA note that the numerical aperture is effectively dependent only on refractive indices of core and cladding material. NA is not a function of fiber dimension.

- The index difference ( $\Delta$ ) and the numerical aperture (NA) are related to the core and cladding indices:

$$\Delta = \frac{(n_1 - n_2)}{n_1} \quad (1.6.5 \text{ (a)})$$

$$\Delta = \frac{NA^2}{2n_1^2} \quad \dots (1.6.5 \text{ (b)})$$

Also

$$NA = \sqrt{n_1^2 - n_2^2}$$

$$NA = (n_1^2 - n_2^2)^{1/2}$$

$$NA = n_1 (2\Delta)^{1/2}$$

**Example 1.6.5 :** Calculate the numerical aperture and acceptance angle for a fiber cable of which  $n_{\text{core}} = 1.5$  and  $n_{\text{cladding}} = 1.48$ . The launching takes place from air.

**Solution :**

$$NA = \sqrt{n_{\text{core}}^2 - n_{\text{cladding}}^2}$$

$$NA = \sqrt{1.5^2 - 1.48^2}$$

$$NA = \mathbf{0.244}$$

...Ans.

$$\text{Acceptance angle} - \sin^{-1} \sqrt{n_{\text{core}}^2 - n_{\text{cladding}}^2} = \sin^{-1} NA$$

$$\text{Acceptance angle} = \sin^{-1} 0.244$$

$$\phi_0 = 14.12^\circ$$

...Ans.

### Types of Rays

- If the rays are launched within core of acceptance can be successfully propagated along the fiber. But the exact path of the ray is determined by the position and angle of ray at which it strikes the core.

There exists three different types of rays.

i) Skew rays            ii) Meridional rays            iii) Axial rays.

- The skew rays** does not pass through the center, as show in Fig. 1.6.11 (a). The skew rays reflects off from the core cladding boundaries and again bounces around the outside of the core. It takes somewhat similar shape of spiral of helical path.

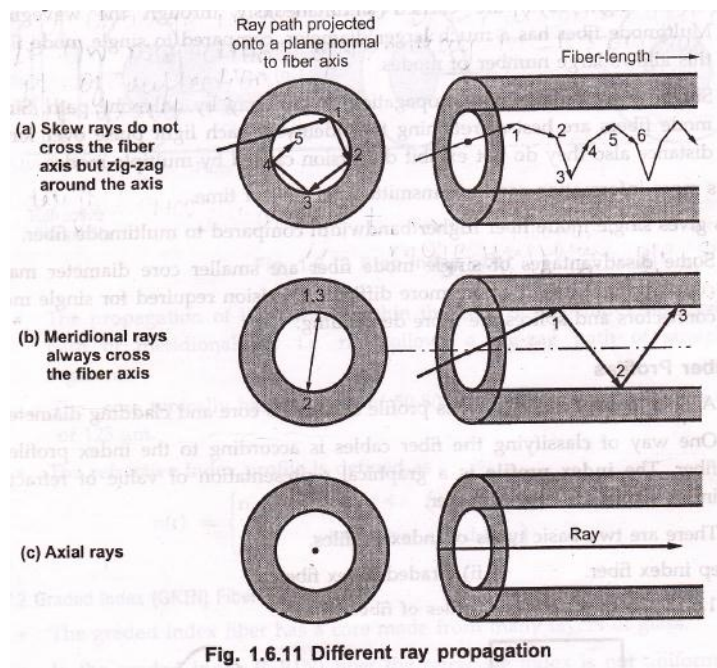

- The **meridional** ray enters the core and passes through its axis. When the core surface is parallel, it will always be reflected to pass through the center. The meridional ray is shown in fig. 1.6.11 (b).
- The **axial ray** travels along the axis of the fiber and stays at the axis all the time. It is shown in fig. 1.6.11 (c).

## Modes of Fiber

- Fiber cables can also be classified as per their mode. Light rays propagate as an electromagnetic wave along the fiber. The two components, the electric field and the magnetic field form patterns across the fiber. These patterns are called **modes** of transmission. The **mode** of a fiber refers to the number of paths for the light rays within the cable. According to modes optic fibers can be classified into two types.  
i) Single mode fiber ii) Multimode fiber.
- Multimode fiber was the first fiber type to be manufactured and commercialized. The term multimode simply refers to the fact that numerous modes (light rays) are carried simultaneously through the waveguide. Multimode fiber has a much larger diameter, compared to single mode fiber, this allows large number of modes.
- Single mode fiber allows propagation to light ray by only one path. Single mode fibers are best at retaining the fidelity of each light pulse over longer distance also they do not exhibit dispersion caused by multiple modes.

Thus more information can be transmitted per unit of time.

This gives single mode fiber higher bandwidth compared to multimode fiber.

- Some disadvantages of single mode fiber are smaller core diameter makes coupling light into the core more difficult. Precision required for single mode connectors and splices are more demanding.

## Fiber Profiles

- A fiber is characterized by its profile and by its core and cladding diameters.
- One way of classifying the fiber cables is according to the index profile at fiber. The **index profile** is a graphical representation of value of refractive index across the core diameter.
- There are two basic types of index profiles.

i) Step index fiber.                      ii) Graded index fiber.

Fig. 1.6.12 shows the index profiles of fibers.

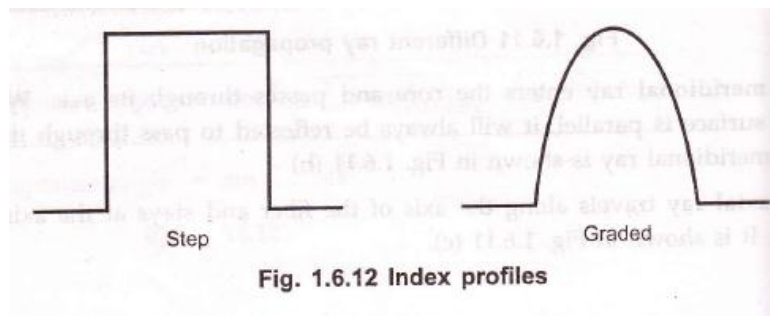

Fig. 1.6.12 Index profiles

### Step Index (SI) Fiber

- The step index (SI) fiber is a cylindrical waveguide core with central or inner core has a uniform refractive index of  $n_1$  and the core is surrounded by outer cladding with uniform refractive index of  $n_2$ . The cladding refractive index ( $n_2$ ) is less than the core refractive index ( $n_1$ ). But there is an abrupt change in the refractive index at the core cladding interface. Refractive index profile of step indexed optical fiber is shown in Fig. 1.6.13. The refractive index is plotted on horizontal axis and radial distance from the core is plotted on vertical axis.

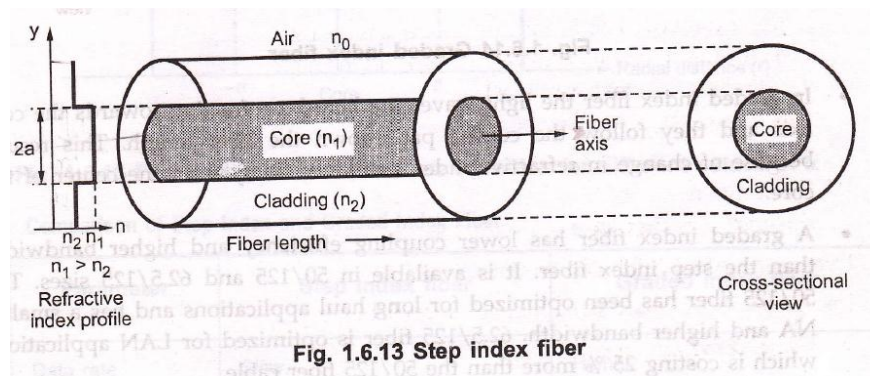

Fig. 1.6.13 Step index fiber

- The propagation of light wave within the core of step index fiber takes the path of meridional ray i.e. ray follows a zig-zag path of straight line segments. The core typically has diameter of 50-80  $\mu\text{m}$  and the cladding has a diameter of 125  $\mu\text{m}$ .
- The refractive index profile is defined as –

$$n(r) = \begin{cases} n_1 & \text{when } r < a \text{ (core)} \\ n_2 & \text{when } r \geq a \text{ (cladding)} \end{cases}$$

### Graded Index (GRIN) Fiber

- The graded index fiber has a core made from many layers of glass.
- In the **graded index (GRIN)** fiber the refractive index is not uniform within the core, it is highest at the center and decreases smoothly and continuously with distance towards the cladding. The refractive index profile across the core takes the parabolic nature. Fig. 1.6.14 shows refractive index profile of graded index fiber.

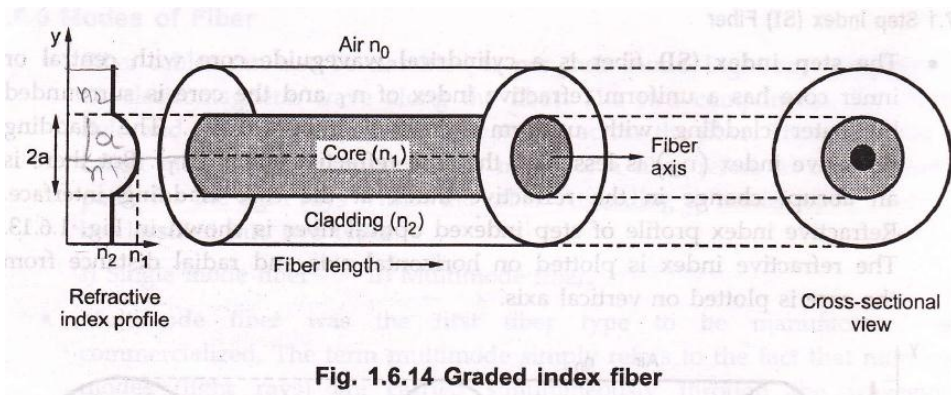

Fig. 1.6.14 Graded index fiber

- In graded index fiber the light waves are bent by refraction towards the core axis and they follow the curved path down the fiber length. This results because of change in refractive index as moved away from the center of the core.
- A graded index fiber has lower coupling efficiency and higher bandwidth than the step index fiber. It is available in 50/125 and 62.5/125 sizes. The 50/125 fiber has been optimized for long haul applications and has a smaller NA and higher bandwidth. 62.5/125 fiber is optimized for LAN applications which is costing 25% more than the 50/125 fiber cable.
- The refractive index variation in the core is given by relationship

$$n(r) = \begin{cases} n_1 \left( 1 - 2\Delta \left( \frac{r}{a} \right)^\alpha \right) & \text{when } r < a \text{ (core)} \\ n_1 (1 - 2\Delta)^{\frac{1}{2}} \approx n_2 & \text{when } r \geq a \text{ (cladding)} \end{cases}$$

where,

$r$  = Radial distance from fiber axis

$a$  = Core radius

$n_1$  = Refractive index of core

$n_2$  = Refractive index of cladding

$\alpha$  = Shape of index profile.

- Profile parameter  $\alpha$  determines the characteristic refractive index profile of fiber core. The range of refractive index as variation of  $\alpha$  is shown in Fig. 1.6.15.

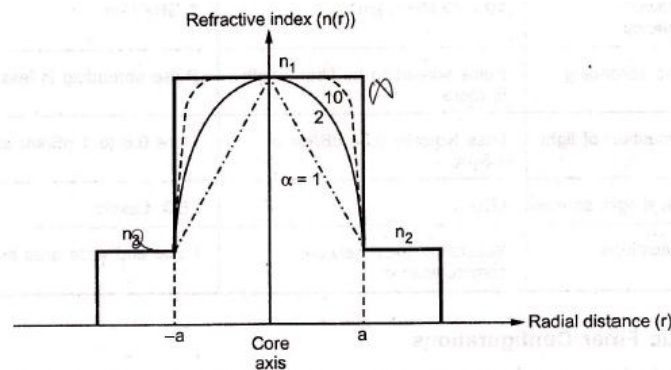

Fig. 1.6.15 Possible fiber refractive index profiles for different values of  $\alpha$

### Comparison of Step Index and Graded Index Fiber

Sr. No.	Parameter	Step index fiber	Graded index fiber
1.	Data rate	Slow.	Higher
2.	Coupling efficiency	Coupling efficiency with fiber is higher.	Lower coupling efficiency.
3.	Ray path	By total internal reflection.	Light ray travels in oscillatory fashion.
4.	Index variation	$\Delta = \frac{n_1 - n_2}{n_1}$	$\Delta = \frac{n_1^2 - n_2^2}{2n_1^2}$
5.	Numerical aperture	NA remains same.	Changes continuously with distance from fiber axis.
6.	Material used	Normally plastic or glass is preferred.	Only glass is preferred.
7.	Bandwidth efficiency	10 – 20 MHz/km	1 GHz/km
8.	Pulse spreading	Pulse spreading by fiber length is more.	Pulse spreading is less
9.	Attenuation of light	Less typically 0.34 dB/km at 1.3 $\mu\text{m}$ .	More 0.6 to 1 dB/km at 1.3 $\mu\text{m}$ .



10.	Typical light source	LED.	LED, Lasers.
11.	Applications	Subscriber local network communication.	Local and wide area networks.

### Optic Fiber Configurations

- Depending on the refractive index profile of fiber and modes of fiber there exist three types of optical fiber configurations. These optic-fiber configurations are -
  - i) Single mode step index fiber.
  - ii) Multimode step index fiber.
  - iii) Multimode graded index fiber.

### Single mode Step index Fiber

- In single mode step index fiber has a central core that is sufficiently small so that there is essentially only one path for light ray through the cable. The light ray is propagated in the fiber through reflection. Typical core sizes are 2 to 15  $\mu\text{m}$ . Single mode fiber is also known as fundamental or monomode fiber.

Fig. 1.6.16 shows single mode fiber.

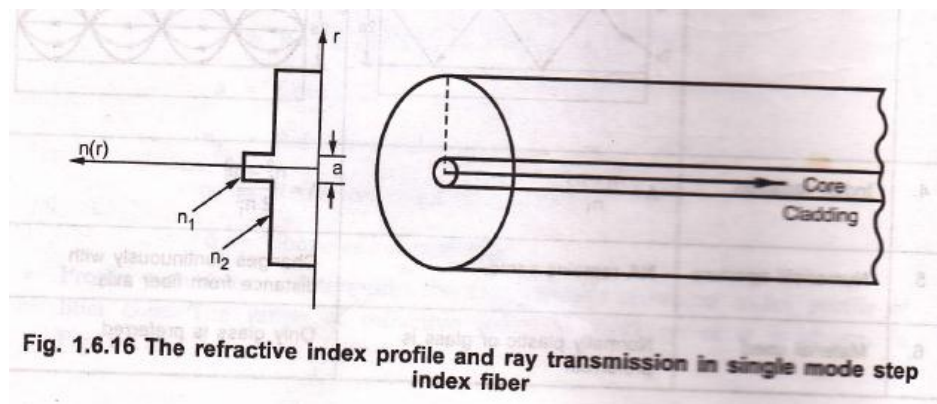

- Single mode fiber will permit only one mode to propagate and does not suffer from mode delay differences. These are primarily developed for the 1300 nm window but they can be also be used effectively with time division multiplex (TDM) and wavelength division multiplex (WDM) systems operating in 1550 nm wavelength region.
- The core fiber of a single mode fiber is very narrow compared to the wavelength of light being used. Therefore, only a single path exists through the cable core through which light can travel. Usually, 20 percent of the light in a single mode cable actually

travels down the cladding and the effective diameter of the cable is a blend of single mode core and degree to which the cladding carries light. This is referred to as the 'mode field diameter', which is larger than physical diameter of the core depending on the refractive indices of the core and cladding.

- The disadvantage of this type of cable is that because of extremely small size interconnection of cables and interfacing with source is difficult. Another disadvantage of single mode fibers is that as the refractive index of glass decreases with optical wavelength, the light velocity will also be wavelength dependent. Thus the light from an optical transmitter will have definite spectral width.

### Multimode step Index Fiber

- **Multimode step index fiber** is more widely used type. It is easy to manufacture. Its core diameter is 50 to 1000  $\mu\text{m}$  i.e. large aperture and allows more light to enter the cable. The light rays are propagated down the core in zig-zag manner. There are many many paths that a light ray may follow during the propagation.
- The light ray is propagated using the principle of total internal reflection (TIR). Since the core index of refraction is higher than the cladding index of refraction, the light enters at less than critical angle is guided along the fiber.

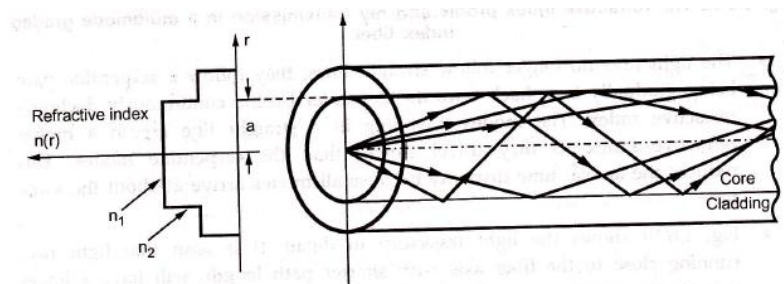

Fig. 1.6.17 TIR in multimode step index fiber

- Light rays passing through the fiber are continuously reflected off the glass cladding towards the centre of the core at different angles and lengths, limiting overall bandwidth.
- The disadvantage of multimode step index fibers is that the different optical lengths caused by various angles at which light is propagated relative to the core, causes the transmission bandwidth to be fairly small. Because of these limitations, multimode step index fiber is typically only used in applications requiring distances of less than 1 km.

### Multimode Graded Index Fiber

- The core size of **multimode graded index fiber** cable is varying from 50 to 100  $\mu\text{m}$  range. The light ray is propagated through the refraction. The light ray enters the fiber at

many different angles. As the light propagates across the core toward the center it is intersecting a less dense to more dense medium. Therefore the light rays are being constantly being refracted and ray is bending continuously. This cable is mostly used for long distance communication.

Fig 1.6.18 shows multimode graded index fiber.

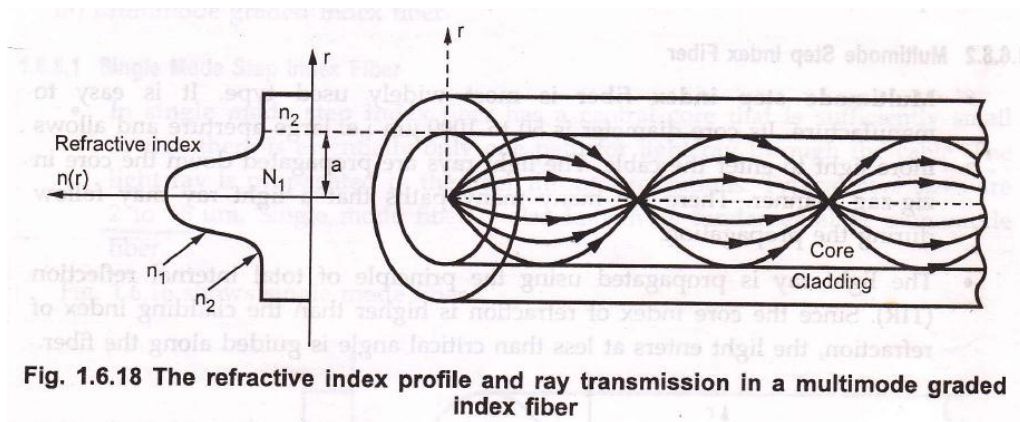

- The light rays no longer follow straight lines, they follow a serpentine path being gradually bent back towards the center by the continuously declining refractive index. The modes travelling in a straight line are in a higher refractive index so they travel slower than the serpentine modes. This reduces the arrival time disparity because all modes arrive at about the same time.
- Fig 1.6.19 shows the light trajectory in detail. It is seen that light rays running close to the fiber axis with shorter path length, will have a lower velocity because they pass through a region with a high refractive index.

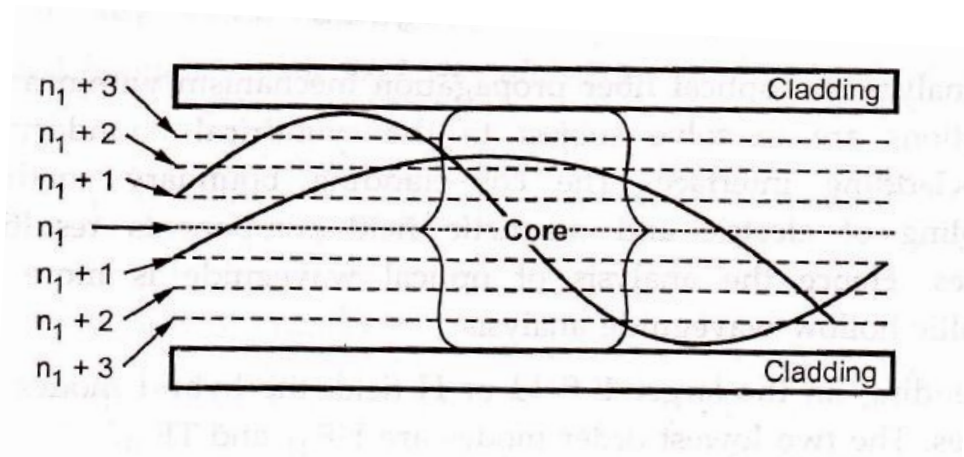

**Fig. 1.6.19 Light trajectories in a graded index fiber**

- Rays on core edges offers reduced refractive index, hence travel more faster than axial rays and cause the light components to take same amount of time to travel the length of fiber, thus minimizing dispersion losses. Each path at a different angle is termed as ‘transmission mode’ and the NA of graded index fiber is defined as the maximum value of acceptance angle at the fiber axis.
- Typical attenuation coefficients of graded index fibers at 850 nm are 2.5 to 3 dB/km, while at 1300 nm they are 1.0 to 1.5 dB/km.
- The main advantages of graded index fiber are:
  1. Reduced refractive index at the centre of core.
  2. Comparatively cheap to produce.

### Standard fibers

Sr. No.	Fiber type	Cladding diameter (μm)	Core diameter (μm)	Δ	Applications
1.	Single mode (8/125)	125	8	0.1% to 0.2%	1. Long distance 2. High data rate
2.	Multimode (50/125)	125	50	1% to 2%	1. Short distance 2. Low data rate
3.	Multimode (62.5/125)	125	62.5	1% to 2%	LAN
4.	Multimode (100/140)	140	100	1% to 2%	LAN

### 1.7 Mode Theory for Cylindrical Waveguide

- To analyze the optical fiber propagation mechanism within a fiber, Maxwell equations are to solve subject to the cylindrical boundary conditions at core-cladding interface. The core-cladding boundary conditions lead to coupling of electric and magnetic field components resulting in hybrid modes. Hence the analysis of optical waveguide is more complex than metallic hollow waveguide analysis.
- Depending on the large E-field, the hybrid modes are HE or EH modes. The two lowest order does are  $HE_{11}$  and  $TE_{01}$ .

#### Overview of Modes

- The order states the number of field zeros across the guide. The electric fields are not completely confined within the core i.e. they do not go to zero at core-cladding interface and extends into the cladding. The low order mode confines the electric field near the axis of the fiber core and there is less penetration into the cladding. While the high order mode distribute the field towards the edge of the core fiber and penetrations into the cladding. Therefore cladding modes also appear resulting in power loss.
- In leaky modes the fields are confined partially in the fiber core attenuated as they propagate along the fiber length due to radiation and tunnel effect.
- Therefore in order to mode remain guided, the propagation factor  $\beta$  must satisfy the condition

$$n_2 k < \beta < n_1 k$$

where,

$n_1$  = Refractive index of fiber core

$n_2$  = Refractive index of cladding

$k$  = Propagation constant =  $2\pi / \lambda$

- The cladding is used to prevent scattering loss that results from core material discontinuities. Cladding also improves the mechanical strength of fiber core and reduces surface contamination. Plastic cladding is commonly used. Materials used for fabrication of optical fibers are silicon dioxide ( $SiO_2$ ), boric oxide-silica.

#### Summary of Key Modal Concepts

- Normalized frequency variable,  $V$  is defined as

$$V = \frac{2\pi a (n_1^2 - n_2^2)^{1/2}}{\lambda}$$

... (1.7.1)

where,

a = Core radius

 $\lambda$  = Free space wavelength

$$V = \frac{2\pi a}{\lambda} NA$$

Since  $(n_1^2 - n_2^2)^{1/2} = NA$ 

... (1.7.2)

- The total number of modes in a multimode fiber is given by

$$M = \frac{1}{2} \left( \frac{2\pi a}{\lambda} \right)^2 (n_1^2 - n_2^2)$$

$$M = \frac{1}{2} \left[ \frac{2\pi a}{\lambda} NA \right]^2 = \frac{[V]^2}{2}$$

$$M = \frac{1}{2} \left[ \frac{\pi d}{\lambda} \cdot NA \right]^2$$

'd' is core diameter

... (17.3)

**Example 1.7.1** : Calculate the number of modes of an optical fiber having diameter of 50  $\mu\text{m}$ ,  $n_1 = 1.48$ ,  $n_2 = 1.46$  and  $\lambda = 0.82 \mu\text{m}$ .

**Solution :** d = 50  $\mu\text{m}$

$$n_1 = 1.48$$

$$n_2 = 1.46$$

$$\lambda = 0.82 \mu\text{m}$$

$$NA = (n_1^2 - n_2^2)^{1/2}$$

$$NA = (1.48^2 - 1.46^2)^{1/2}$$

$$NA = 0.243$$

Number of modes are given by,

$$M = \frac{1}{2} \left[ \frac{\pi d}{\lambda} \cdot NA \right]^2$$

$$M = \frac{1}{2} \left[ \frac{\pi (50 \times 10^{-6})}{0.82 \times 10^{-6}} \times 0.243 \right]^2$$

$$M = 1083$$

...Ans.

**Example 1.7.2 :** A fiber has normalized frequency  $V = 26.6$  and the operating wavelength is 1300nm. If the radius of the fiber core is 25  $\mu\text{m}$ . Compute the numerical aperture.

Solution :

$$V = 26.6$$

$$\lambda = 1300 \text{ nm} = 1300 \times 10^{-9} \text{ m}$$

$$a = 25 \mu\text{m} = 25 \times 10^{-6} \text{ m}$$

$$V = \frac{2\pi a}{\lambda} NA$$

$$NA = V \cdot \frac{\lambda}{2\pi a}$$

$$NA = 26.6 \frac{1300 \times 10^{-9}}{2\pi \times 25 \times 10^{-6}}$$

$$NA = 0.220$$

... Ans.

**Example 1.7.3 :** A multimode step index fiber with a core diameter of 80  $\mu\text{m}$  and a relative index difference of 1.5 % is operating at a wavelength of 0.85  $\mu\text{m}$ . If the core refractive index is 1.48, estimate the normalized frequency for the fiber and number of guided modes.

[July/Aug.-2008, 6 Marks]

**Solution : Given :** MM step index fiber,  $2a = 80 \mu\text{m}$

$$\therefore \text{Core radius } a = 40 \mu\text{m}$$

Relative index difference,  $\Delta = 1.5\% = 0.015$

Wavelength,  $\lambda = 0.85\mu\text{m}$

Core refractive index,  $n_1 = 1.48$

Normalized frequency,  $V = ?$

Number of modes,  $M = ?$

Numerical aperture 
$$\boxed{NA = n_1 (2\Delta)^{1/2}}$$

$$= 1.48 (2 \times 0.015)^{1/2}$$

$$= 0.2563$$

Normalized frequency is given by,

$$\boxed{V = \frac{2\pi a}{\lambda} NA}$$

$$V = \frac{2\pi \times 40}{0.85} \times 0.2563$$

$$V = 75.78$$

... Ans.

Number of modes is given by,

$$\boxed{M = \frac{V^2}{2}}$$

$$M = \frac{(75.78)^2}{2} = 2871.50$$

...Ans.

**Example 1.7.4 :** A step index multimode fiber with a numerical aperture of a 0.20 supports approximately 1000 modes at an 850 nm wavelength.

- i) What is the diameter of its core?
- ii) How many modes does the fiber support at 1320 nm?
- iii) How many modes does the fiber support at 1550 nm? **[Jan./Feb.-2007, 10 Marks]**

**Solution :** i) Number of modes is given by,



$$M = \frac{1}{2} \left[ \frac{\pi a}{\lambda} \cdot NA \right]^2$$

$$1000 = \frac{1}{2} \left[ \frac{\pi a}{850 \times 10^{-9}} \times 0.20 \right]^2$$

$$2000 = 5.464 \times a^2$$

$$a = 60.49 \mu\text{m}$$

... Ans.

ii)

$$M = \frac{1}{2} \left[ \frac{\pi \times 60.49 \times 10^{-6}}{1320 \times 10^{-9}} \times 0.20 \right]^2$$

$$M = (14.39)^2 = 207.07$$

... Ans.

iii)

$$M = \frac{1}{2} \left[ \frac{\pi \times 6.49 \times 10^{-6}}{1320 \times 10^{-9}} \times 0.20 \right]^2$$

... Ans.

$$M = 300.63$$

... Ans.

## Wave Propagation

### Maxwell's Equations

Maxwell's equation for non-conducting medium:

$$\nabla \times E = - \partial B /$$

$$\nabla \times H = - \partial D /$$

$$\nabla \cdot D = 0$$

$$\nabla \cdot B = 0$$

where,

E and H are electric and magnetic field vectors.

D and B are corresponding flux densities.

- The relation between flux densities and field vectors:

$$D = \epsilon_0 E + P$$

$$B = \mu_0 H + M$$

where,

$\epsilon_0$  is vacuum permittivity.

$\mu_0$  is vacuum permeability.

P is induced electric polarization.

M is induced magnetic polarization ( $M = 0$ , for non-magnetic silica glass)

- P and E are related by:

$$P(r, t) = \epsilon_0 \int_{-\infty}^{\infty} X(r, t - t') E(r, t') dt'$$

Where,

X is linear susceptibility.

- Wave equation:

$$\nabla \times \nabla \times E = \frac{-1}{c^2} \frac{\partial^2 E}{\partial t^2} - \mu_0 \frac{\partial^2 P}{\partial t^2}$$

Fourier transform of E (r, t)

$$\tilde{E}(r, \omega) = \int_{-\infty}^{\infty} E(r, t) e^{i\omega t} dt$$

$$\nabla \times \nabla \times \tilde{E} = -\epsilon(r, \omega) \frac{\omega^2}{c^2} \tilde{E}$$

where,

$$\epsilon = \left( n + \frac{i\alpha c}{2\omega} \right)^2$$

$n$  is refractive index.

$\alpha$  is absorption coefficient.

$$n = \sqrt{(1 + R_e \chi)}$$

$$\alpha = \left(\frac{\omega}{nc}\right) I_m \chi$$

- Both  $n$  and  $\alpha$  are frequency dependent. The frequency dependence of  $n$  is called as chromatic dispersion or material dispersion.
- For step index fiber,

$$\nabla \times \nabla \times \vec{E} = \nabla (\nabla \cdot \vec{E}) - \nabla^2 \cdot \vec{E} = -\nabla^2 \vec{E}$$

### Fiber Modes

**Optical mode** : An optical mode is a specific solution of the wave equation that satisfies boundary conditions. There are three types of fiber modes.

- Guided modes
  - Leaky modes
  - Radiation modes
- For fiber optic communication system guided mode is used for signal transmission. Considering a step index fiber with core radius 'a'.

The cylindrical co-ordinates  $\rho$ ,  $\phi$  and  $z$  can be used to represent boundary conditions.

$$\frac{\partial^2 E_z}{\partial \rho^2} + \frac{1}{\rho} \cdot \frac{\partial E_z}{\partial \rho} + \frac{1}{\rho^2} \cdot \frac{\partial^2 E_z}{\partial \phi^2} + \frac{\partial^2 E_z}{\partial z^2} + n^2 k_0^2 E_z = 0$$

- The refractive index 'n' has values

$$n = \begin{cases} n_1; & \rho \leq a \\ n_2; & \rho > a \end{cases}$$

- The general solutions for boundary condition of optical field under guided mode is infinite at  $\rho = 0$  and decay to zero at  $\rho = \infty$ . Using Maxwell's equation in the core region.

$$E_\rho = \frac{i}{p^2} \left( \beta \frac{\partial E_z}{\partial \rho} + \mu_0 \frac{\omega}{\rho} \cdot \frac{\partial H_z}{\partial \phi} \right)$$

$$E_{\phi} = \frac{i}{p^2} \left( \frac{\beta}{\rho} \frac{\partial E_z}{\partial \phi} - \mu_0 \omega \cdot \frac{\partial H_z}{\partial \rho} \right)$$

$$H_{\rho} = \frac{i}{p^2} \left( \beta \frac{\partial E_z}{\partial \rho} + \varepsilon_0 n^2 \omega \frac{\partial H_z}{\partial \rho} \right)$$

$$H_{\phi} = \frac{i}{p^2} \left( \frac{\beta}{\rho} \frac{\partial E_z}{\partial \phi} + \varepsilon_0 n^2 \omega \frac{\partial H_z}{\partial \rho} \right)$$

- The **cut-off condition** is defined as –

$$V = k_0 a \sqrt{(n_1^2 - n_2^2)}$$

$$V = \left( \frac{2\pi}{\lambda} \right) a n_1 \sqrt{2\Delta}$$

It is also called as **normalized frequency**.

### Graded Index Fiber Structure

- The Refractive index of graded index fiber decreases continuously towards its radius from the fiber axis and that for cladding is constant.
- The refractive index variation in the core is usually designed by using power law relationship.

$$n(r) = \begin{cases} n_1 \left[ 1 - 2\Delta \left( \frac{r}{a} \right)^{\alpha} \right]^{\frac{1}{2}}, & \text{when } 0 \leq r \leq a \\ n_1 (1 - 2\Delta)^{\frac{1}{2}} \approx n_1 (1 - \Delta) = n_2, & \text{when } r \geq a \end{cases} \quad \dots (1.7.4)$$

Where,  $r$  = Radial distance from fiber axis

$a$  = Core radius

$n_1$  = Refractive index core

$n_2$  Refractive index of cladding and

$\alpha$  = The shape of the index profile

- For graded index fiber, the index difference  $\Delta$  is given by,

$$\Delta = \frac{n_1^2 - n_2^2}{2n_1^2}$$

$$\Delta = \frac{n_1 - n_2}{n_1}$$

- In graded index fiber the incident light will propagate when local numerical aperture at distance  $r$  from axis,  $NA(r)$  is axial numerical aperture  $NA(0)$ . The local numerical aperture is given as,

$$NA(r) = \begin{cases} [n^2(r) - n_2^2]^{\frac{1}{2}} \approx NA(0) \sqrt{1 - \left(\frac{r}{a}\right)^\alpha}, & \text{for } r \leq a \\ 0, & \text{for } r > a \end{cases}$$

- The axial numerical aperture  $NA(0)$  is given as,

$$NA(0) = [n^2(0) - n_2^2]^{\frac{1}{2}}$$

$$NA(0) = [n_1^2 - n_2^2]^{\frac{1}{2}}$$

$$NA(0) = n_1 \sqrt{2\Delta} \approx n_1 (2\Delta)^{\frac{1}{2}}$$

Hence  $NA$  for graded index decreases to zero as it moves from fiber axis to core-cladding boundary.

- The variation of  $NA$  for different values of  $\alpha$  is shown in Fig. 1.7.1.

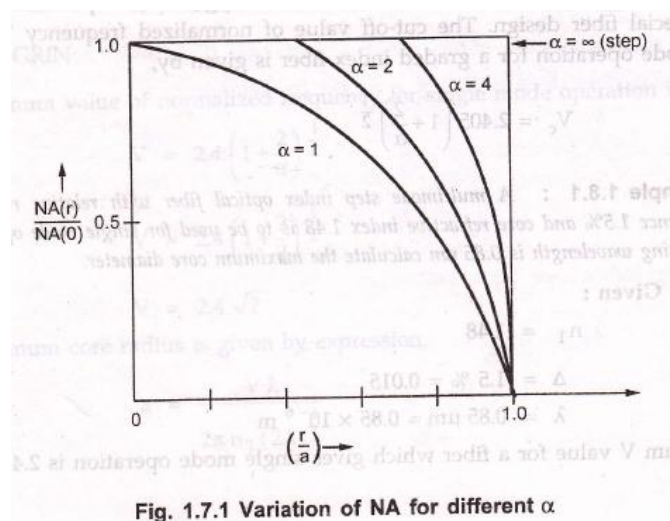

Fig. 1.7.1 Variation of  $NA$  for different  $\alpha$

- The number of modes for graded index fiber is given as,

$$M = \frac{\alpha}{\alpha + 2} a^2 k^2 n_1^2 \Delta \quad \dots (1.7.6)$$

### 1.8 Single Mode Fibers

- Propagation in single mode fiber is advantageous because signal dispersion due to delay differences amongst various modes in multimode is avoided. Multimode step index fibers cannot be used for single mode propagation due to difficulties in maintaining single mode operation. Therefore for the transmission of single mode the fiber is designed to allow propagation in one mode only, while all other modes are attenuated by leakage or absorption.
- For single mode operation, only fundamental LP<sub>01</sub> mode may exist. The single mode propagation of LP<sub>01</sub> mode in step index fibers is possible over the range.

$$0 \leq V < 2.405$$

- The normalized frequency for the fiber can be adjusted within the range by reducing core radius and refractive index difference < 1%. In order to obtain single mode operation with maximum V number (2.4), the single mode fiber must have smaller core diameter than the equivalent multimode step index fiber. But smaller core diameter has problem of launching light into the fiber, jointing fibers and reduced relative index difference.
- Graded index fibers can also be used for single mode operation with some special fiber design. The cut-off value of normalized frequency V<sub>c</sub> in single mode operation for a graded index fiber is given by,

$$V_c = 2.405 \left( 1 + \frac{2}{\alpha} \right)^{\frac{1}{2}}$$

**Example 1.8.1 :** A multimode step index optical fiber with relative refractive index difference 1.5% and core refractive index 1.48 is to be used for single mode operation. If the operating wavelength is 0.85μm calculate the maximum core diameter.

Solution : Given :

$$n_1 = 1.48$$

$$\Delta = 1.5 \% = 0.015$$

$$\lambda = 0.85 \mu\text{m} = 0.85 \times 10^{-6} \text{ m}$$

Maximum V value for a fiber which gives single mode operations is 2.4.

Normalized frequency (V number) and core diameter is related by expression,

$$V = \frac{2\pi}{\lambda} a (\text{NA})$$

$$V = \frac{2\pi}{\lambda} a n_1 (2\Delta)^{\frac{1}{2}}$$

$$a = \frac{V\lambda}{2\pi n_1 (2\Delta)^{\frac{1}{2}}}$$

$$a = \frac{2.4 \times (0.85 \times 10^{-6})}{2\pi \times (1.48) \times (0.03)^{\frac{1}{2}}}$$

$$a = 1.3 \mu\text{m}$$

... Ans.

Maximum core diameter for single mode operation is 2.6  $\mu\text{m}$ .

**Example 1.8.2 :** A GRIN fiber with parabolic refractive index profile core has a refractive index at the core axis of 1.5 and relative index difference at 1%. Calculate maximum possible core diameter that allows single mode operations at  $\lambda = 1.3 \mu\text{m}$ .

**Solution : Given :**

$$n_1 = 1.5$$

$$\Delta = 1\% = 0.01$$

$$\lambda = 1.3 \mu\text{m} = 1.3 \times 10^{-6} \text{ m}$$

for a GRIN

Maximum value of normalized frequency for single mode operation is given by,

$$V = 2.4 \left(1 + \frac{2}{\alpha}\right)^{\frac{1}{2}}$$

$$V = 2.4 \left(1 + \frac{2}{2}\right)^{\frac{1}{2}}$$

$$V = 2.4 \sqrt{2}$$

Maximum core radius is given by expression,

$$a = \frac{V\lambda}{2\pi n_1 (2\Delta)^{\frac{1}{2}}}$$

$$a = \frac{24\sqrt{2} \times 1.3 \times 10^{-6}}{2\pi \times 1.5 \times (0.02)^{\frac{1}{2}}}$$

$$a = 3.3 \mu\text{m}$$

... Ans.

∴ Maximum core diameter which allows single mode operation is 6.6 μm.

### Cut-off Wavelength

- One important transmission parameter for single mode fiber is cut-off wavelength for the first higher order mode as it distinguishes the single mode and multimode regions.
- The effective cut-off wavelength  $\lambda_c$  is defined as the largest wavelength at which higher order ( $L_{p_{11}}$ ) mode power relative to the fundamental mode ( $L_{p_{01}}$ ) power is reduced to 0.1 dB. The range of cut-off wavelength recommended to avoid modal noise and dispersion problems is : 1100 to 1280 nm (1.1 to 1.28μm) for single mode fiber at 1.3 μm.
- The cut-off wavelength  $\lambda_c$  can be computed from expression of normalized frequency.

$$V = \frac{2\pi}{\lambda} a n_1 (2\Delta)^{\frac{1}{2}} \Rightarrow \lambda = \frac{2\pi a n_1}{V} (2\Delta)^{\frac{1}{2}} \quad \dots (1.8.1)$$

$$\therefore \lambda = \frac{2\pi a n_1}{V} (2\Delta)^{\frac{1}{2}} \quad \dots (1.8.2)$$

where,

$V_c$  is cut-off normalized frequency.



- $\lambda_c$  is the wavelength above which a particular fiber becomes single moded. For same fiber dividing  $\lambda_c$  by  $\lambda$  we get the relation as:

$$\frac{\lambda_c}{\lambda} = \frac{V}{V_c}$$

$$\lambda = \frac{v\lambda}{V_c} \quad \dots (1.8.3)$$

But for step index fiber  $V_c = 2.405$  then

$$\lambda_c = \frac{v\lambda}{2.405} \quad \dots (1.8.4)$$

**Example 1.8.3 :** Estimate cut-off wavelength for step index fiber in single mode operation. The core refractive index is 1.46 and core radius is 4.5  $\mu\text{m}$ . The relative index difference is 0.25 %.

Solutions : Given :

$$n_1 = 1.46$$

$$a = 4.5 \mu\text{m}$$

$$\Delta = 0.25 \% = 0.0025$$

Cut-off wavelength is given by,

$$\lambda_c = \frac{2\pi a n_1 (2\Delta)^{\frac{1}{2}}}{V_c}$$

For cut-off wavelength,  $V_c = 2.405$

$$\lambda_c = \frac{2\pi \times 4.5 \times 1.46 (0.005)^{\frac{1}{2}}}{2.405}$$

$$\lambda_c = 1.214 \mu\text{m}$$

... Ans.

### Mode Field Diameter and Spot Size

- The mode field diameter is fundamental parameter of a single mode fiber. This parameter is determined from mode field distributions of fundamental LP<sub>01</sub> mode.
- In step index and graded single mode fibers, the field amplitude distribution is approximated by Gaussian distribution. The **mode field diameter** (MFD) is distance between opposite 1/e – 0.37 times the near field strength (amplitude) and power is 1/e<sup>2</sup> = 0.135 times.
- In single mode fiber for fundamental mode, on field amplitude distribution the mode field diameter is shown in fig. 1.8.1.

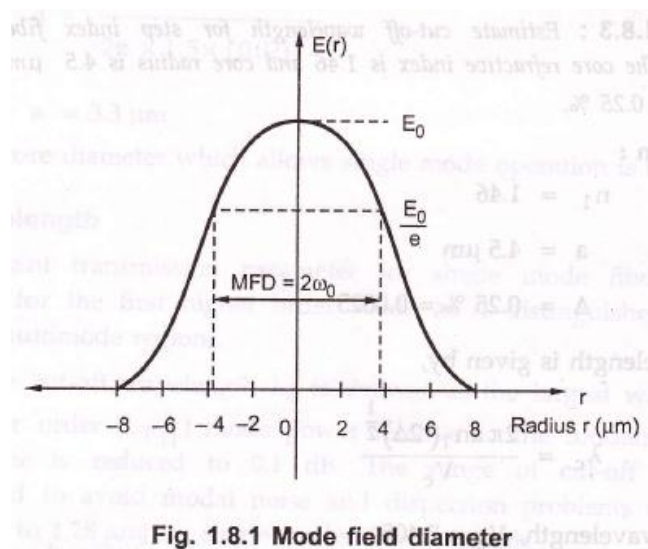

- The spot size  $\omega_0$  is gives as –

$$\omega_0 = \frac{\text{MFD}}{2}$$

$$\text{MFD} = 2 \omega_0$$

The parameter takes into account the wavelength dependent filed penetration into the cladding. Fig. 1.8.2 shows mode field diameters variation with  $\lambda$ .

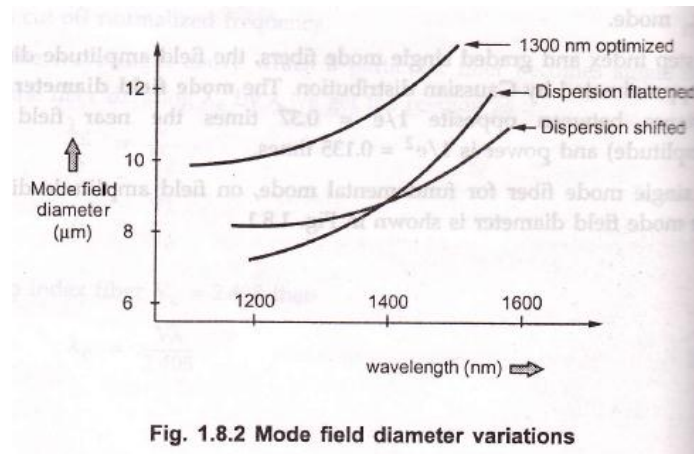

## Fiber Materials

### Requirements of Fiber Optic Material

1. The material must be transparent for efficient transmission of light.
2. It must be possible to draw long thin fibers from the material.
3. Fiber material must be compatible with the cladding material.

Glass and plastics fulfill these requirements.

- Most fiber consists of silica ( $\text{SiO}_2$ ) or silicate. Various types of high loss and low loss glass fibers are available to suit the requirements. Plastic fibers are not popular because of high attenuation they have better mechanical strength.

### Glass Fibers

- Glass is made by fusing mixtures of metal oxides having refractive index of 1.458 at 850 nm. For changing the refractive index different oxides such as  $\text{B}_2\text{O}_3$ ,  $\text{GeO}_2$  and  $\text{P}_2\text{O}_5$  are added as dopants. Fig. 1.8.3 shows variation of refractive index with doping concentration.

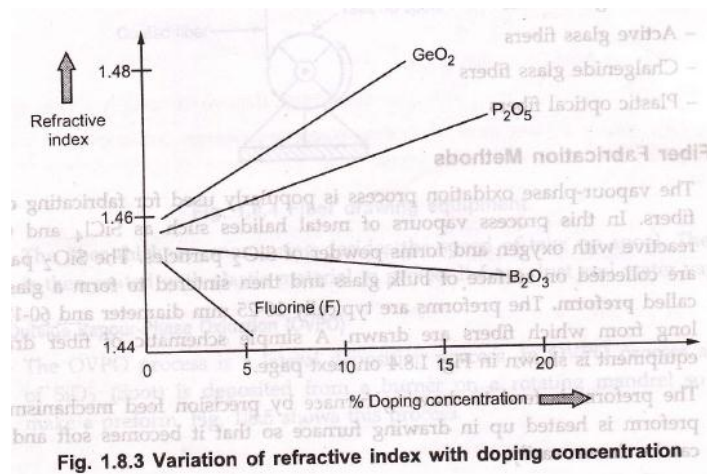

- Fig 1.8.3 shows addition of dopants GeO<sub>2</sub> and P<sub>2</sub>O<sub>5</sub> increases refractive index, while dopants Fluorine (F) and B<sub>2</sub>O<sub>3</sub> decreases refractive index. One important criteria is that the refractive index of core is greater than that of the cladding, hence some important

Composition	Core	Cladding
1	GeO <sub>2</sub> – SiO <sub>2</sub>	SiO <sub>2</sub>
2	P <sub>2</sub> O <sub>5</sub> – SiO <sub>2</sub>	SiO <sub>2</sub>
3	SiO <sub>2</sub>	B <sub>2</sub> O <sub>3</sub> – SiO <sub>2</sub>
4	GeO <sub>2</sub> – B <sub>2</sub> O <sub>3</sub> – SiO <sub>2</sub>	B <sub>2</sub> O <sub>3</sub> – SiO <sub>2</sub>

compositions are used such as

- The principal raw material for silica is sand and glass. The fiber composed of pure silica is called as silica glass. The desirable properties of silica glass are :-
  - Resistance to deformation even at high temperature.
  - Resistance to breakage from thermal shocks (low thermal expansion).
  - Good chemical durability.
  - Better transparency.
- Other types of glass fibers are :
  - Halide glass fibers
  - Active glass fibers
  - Chalcogenide glass fibers
  - Plastic optical fibers

## Fiber Fabrication Methods

- The vapor-phase oxidation process is popularly used for fabricating optical fibers. In this process vapours of metal halides such as  $\text{SiCl}_4$  and  $\text{GeCl}_4$  reactive with oxygen and forms powder of  $\text{SiO}_2$  particles. The  $\text{SiO}_2$  particles are collected on surface of bulk glass and then sintered to form a glass rod called **Preform**. The preforms are typically 10-25 mm diameter and 60-120 cm long from which fibers are drawn. A simple schematic of fiber drawing equipment is shown in Fig. 1.8.4 on next page.
- The preform is feed to drawing furnace by precision feed mechanism. The preform is heated up in drawing furnace so that it becomes soft and fiber can be drawn easily.

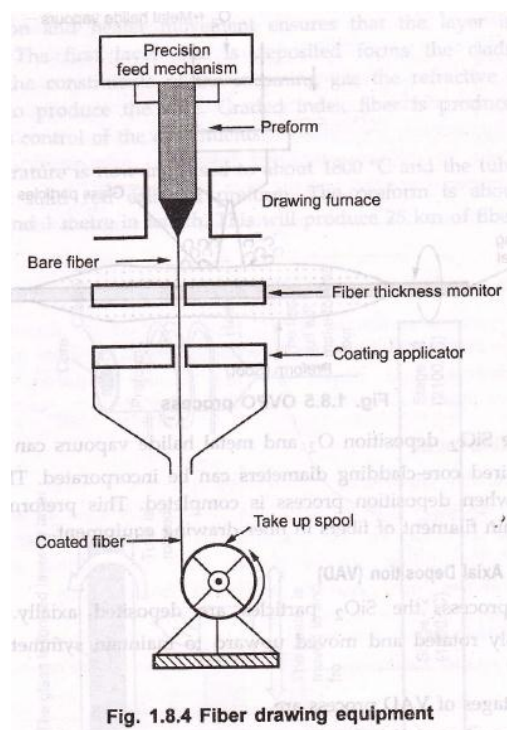

- The fiber thickness monitoring decides the speed of take up spool. The fiber is then coated with elastic material to protect it from dust and water vapour.

## Outside Vapour-Phase Oxidation (OVPO)

- The OVPO process is a lateral deposition process. In OVPO process a layer of  $\text{SiO}_2$  (Soot) is deposited from a burner on a rotating mandrel so as to make a preform. Fig. 1.8.5 shows this process.

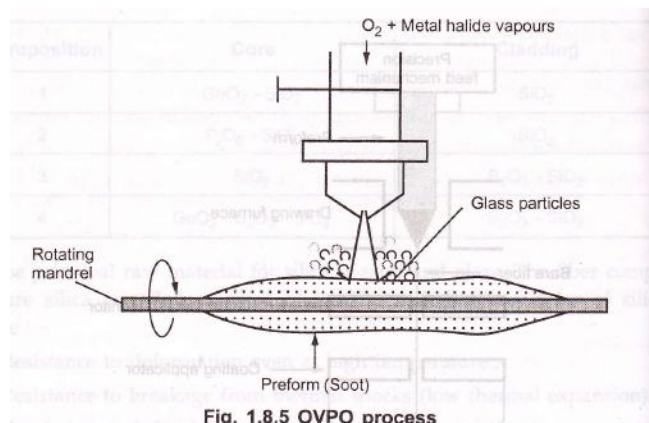

- During the  $SiO_2$  deposition  $O_2$  and metal halide vapours can be controlled so the desired core-cladding diameters can be incorporated. The mandrel is removed when deposition process is completed, This preform is used for drawing thin filament of fibers in fiber drawing equipment.

### Vapour-Phase Axial Deposition (VAD)

- In VAD process, the  $SiO_2$  particles are deposited axially. The rod is continuously rotated and moved upward to maintain symmetry of particle deposition.
- The advantages of VAD process are
  - Both step and graded index fibers are possible to fabricate in multimode and single mode.
  - The preforms does not have the central hole.
  - The performs can be fabricated in continuous length.
  - Clean environment can be maintained.

### Modified Chemical Vapour Deposition (MCVD)

- The MCVD process involves depositing ultra fine, vapourized raw materials into a pre-made silica tube. A hollow silica tube is heated to about  $1500^\circ C$  and a mixture of oxygen and metal halide gases is passed through it. A chemical reaction occurs within the gas and glass 'soot' is formed and deposited on the inner side of the tube. The soot that develops from this deposition is consolidated by heating. The tube is rotated while the heater is moved to and along the tube and the soot forms a thin layer of silica glass. The rotation and heater movement ensures that the layer is of constant thickness. The first layer that is

deposited forms the cladding and by changing the constituents of the incoming gas the refractive index can be modified to produce the core. Graded index fiber is produced by careful continuous control of the constituents.

- The temperature is now increased to about 1800 °C and the tube is collapsed to form a solid rod called a preform. The preform is about 25 mm in diameter and 1 metre in length. This will produce 25 km of fiber.

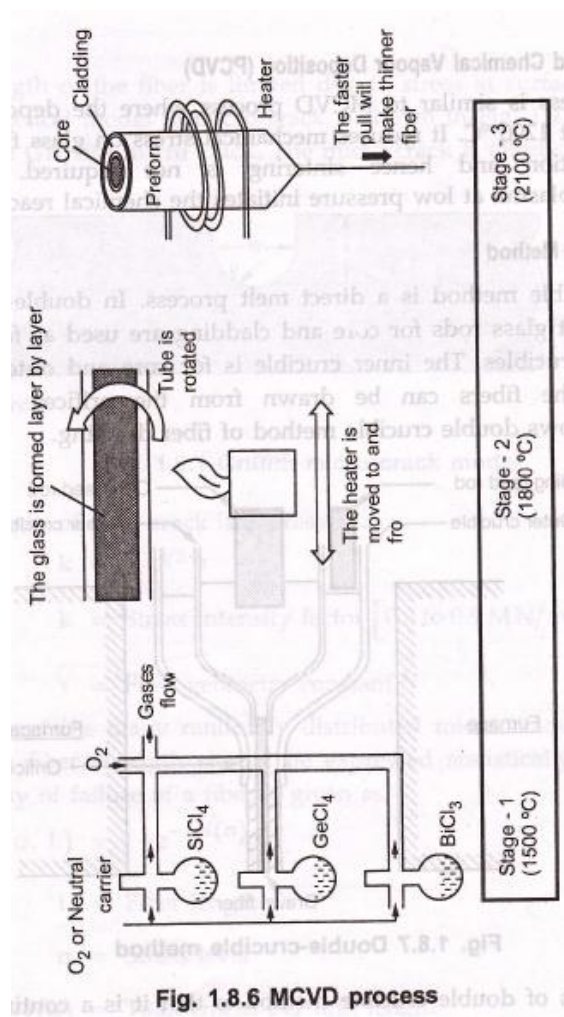

- The preform is placed at a height called a pulling tower and its temperature is increased to about 2100 °C. To prevent contamination, the atmosphere is kept dry and clean. The fiber is then pulled as a fine strand from the bottom, the core and cladding flowing towards the pulling point. Laser gauges continually monitor the thickness of the fiber and automatically adjust the pulling rate to maintain required thickness. After sufficient cooling the primary buffer is applied and the fiber is drummed.
- Fig. 1.8.6 (Refer Fig. 1.8.6 on previous page) shows the overall MCVD process.

### Plasma-Activated Chemical Vapour Deposition (PCVD)

- PCVD process is similar to MCVD process where the deposition occurs on silica tube at 1200 °C. It reduces mechanical stress on glass films. There is no soot formation and hence sintering is not required. Non-isothermal microwave plasma at low pressure initiates the chemical reaction.

### Double-Crucible Method

- Double-crucible method is a direct melt process. In double-crucible method two different glass rods for core and Cladding are used as feedstock for two concentric crucibles. The inner crucible is for core and outer crucible is for cladding. The fibers can be drawn from the orifices in the crucible. Fig. 1.8.7 shows double crucible method of fiber drawing.

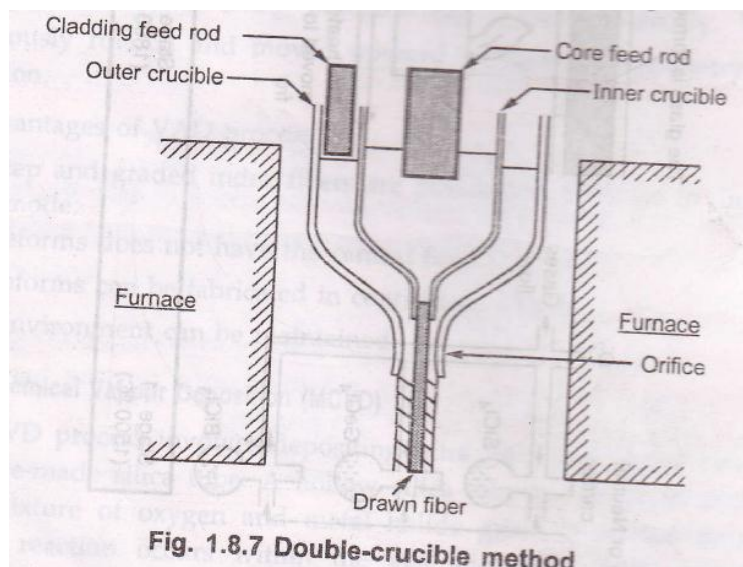

Major advantages of double crucible method is that it is a continuous production process.

### 1.9 Mechanical Properties of Fibers

- The mechanical properties of fibers are equally important as that of transmission properties. The fibers must be able to sustain stresses and strains exerted during the cabling process.

Two basic mechanical properties of glass fibers are identified.



1. Strength
2. Static fatigued

### 1. Strength

- The strength of the fiber is limited due to stress at surfaces or micro cracks. A hypothetical model of micro crack is shown in Fig. 1.9.1. This is popularly known as Griffith micro crack. The micro crack is elliptical shaped.

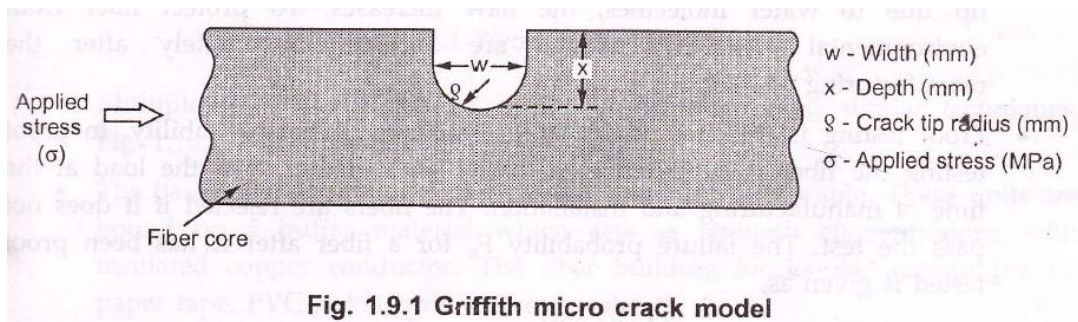

- The strength of fiber crack is expressed as,

$$k = Y \times 1/2 \sigma$$

where,

$$k = \text{Stress intensity factor [0.6 to 0.9 MN/m}^{3/2}\text{]}$$

$$Y = \text{Flaw geometry constant}$$

- A fiber contains many randomly distributed micro cracks of different sizes. Therefore fiber strength should be expressed statistically. The commutative probability of failure of a fiber is given as,

$$F(\sigma, L) = 1 - e^{-LN(\sigma)}$$

where,

$$L = \text{Fiber length}$$

$$\sigma = \text{Stress level}$$

$$N(\sigma) = \text{Total cracks per unit length}$$

- The expression for  $N(\sigma)$  is given by Weibull

$$N(\sigma) = \frac{1}{L_0} \left( \frac{\sigma}{\sigma_0} \right)^m$$

where  $L_0$ ,  $\sigma_0$  and  $m$  are constant relating to initial inert strength distribution. The Weibull expression is given by

## 2. Static fatigue

- The static fatigue is the process of slowly growing micro cracks (flaws) due to humid conditions and tensile stress. There is possibility of fiber failure due to growing micro crack. Also because of chemical erosion at the flaw tip due to water molecules, the flaw increases. To protect fiber from environmental erosion, coatings are applied immediately after the manufacturing of fiber.
- Proof testing is the method for high assurance of fiber reliability. In proof testing the fiber is subjected to a tensile load greater than the load at the time of manufacturing and installation. The fibers are rejected if it does not pass the test. The failure probability  $F_s$  for a fiber after it has been proof tested is given as,

$$F_s = 1 - e^{-L(N_s - N_p)}$$

## 1.10 Fiber Optic Cables

- The fiber optic cable are to be used under variety of situations such as underground, outdoor poles or submerged under water. The structure of cable depends on the situation where it is to be used, but the basic cable design principles remains same.
- Mechanical property of cable is one of the important factor for using any specific cable. Maximum allowable axial load on cable decides the length of the cable be reliably installed.
- Also the fiber cables must be able to absorb energy from impact loads. The outer sheath must be designed to protect glass fibers from impact loads and from corrosive environmental elements.

## Fiber Arrangements

- Several arrangements of fiber cables are done to use it for different applications. The most basic form is two fiber cable design. Fig. 1.10.1 shows basic two fiber cable design. It is also known as basic building block of fiber cable.
- For providing strength to the core several coatings of different materials are applied as shown in fig 1.10.1.

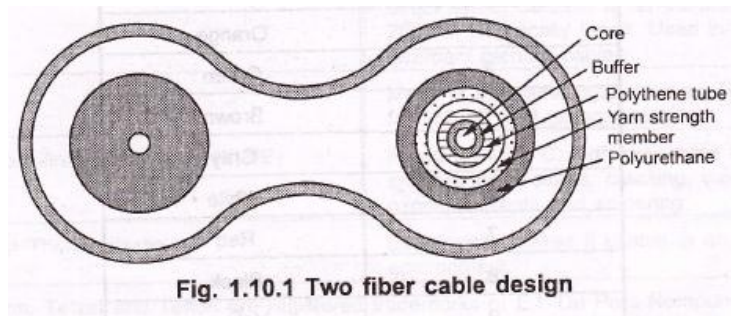

- Multiple fiber cable can be combined together using similar techniques. Fig. 1.10.2 shows commonly used six fiber cable.
- The basic fiber building blocks are used to form large cable. These units are bound on a buffer material which acts as strength element along with insulated copper conductor. The fiber building blocks are surrounded by paper tape, PVC jacket, yarn and outer sheath.

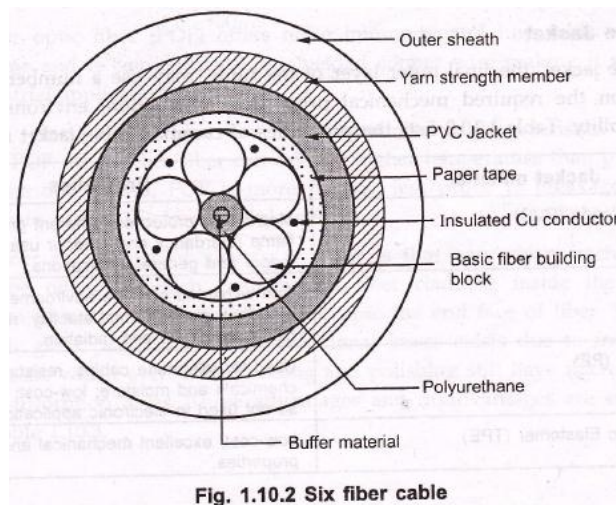

### Fiber Optic Cable Ducts

- Number of cores are bundled in plastic ducts. To ease identification, individual fibers are colour coded Table 1.10.1 shows an example of the colour coding used by manufacturers.

Fiber number	Colour
1	Blue
2	Orange

3	Green
4	Brown
5	Grey
6	White
7	Red
8	Black
9	Yellow
10	Violet
11	Pink or light blue
12	Turquoise or neutral

**Table 1.10.1 Fiber colour coding**

- If there are more than 12 fibers in a tube they are usually bundled together in quantities of 12 and held together with a coloured binding yarn.

### Cable Jacket

The cable jacket, the final outer layer of the cable, may use a number of materials depending on the required mechanical properties, attenuation, environmental stress and flammability. Table 1.10.2 lists the properties of common cable jacket materials.

Jacket material	Properties
Polyvinyl Chloride (PVC)	Mechanical protection; different grades offer flame retardancy and outdoor use. Also for indoor and general applications.
Gypalon <sup>®</sup>	Can withstand extreme environments; flame retardant; good thermal stability; resistant to oxidation, ozone and radiation.
Polyethylene (PE)	Used for telephone cables; resistant to chemicals and moisture; low-cost; flammable, so not used in electronic application.
Thermoplastic Elastomer (TPE)	Low-cost; excellent mechanical and chemical properties.
Nylon	Used over single conductors to improve physical properties

Kynar <sup>®</sup> (Polyvinylidene Fluoride)	Resistant to abrasions, cuts; thermally stable; resistant to most chemicals; low smoke emission; self-extinguishing. Used in highly flame retardant plenum cables.
Teflon <sup>®</sup> FEP	Zero smoke emission, even when exposed to direct flame. Suitable to temperatures of 200 °C; chemically inert. Used in highly flame retardant plenum cables.
Tefzel <sup>®</sup>	Many of the same properties as Teflon; rated for 150 °C; self-extinguishing.
Irradiated cross-linked Polyolefin (XLPE)	Rated for 150 °C; high resistance to environmental stress, cracking, cut-through, ozone, solvents and soldering.
Zero Halogen Thermoplastic	Low toxicity makes it usable in any enclosed
Kevlar, Hyplon, Tefzel and Teflon are registered trademarks of E.I. Du Pont Nemours and Company. Kynar is a registered trademark of Pennwalt, Inc.	

**Table 1.10.2 Properties of cable jacket material**

### Plastic Fiber Optic Cables

- Fibers can also be manufactured from transparent plastic which offers advantages of larger diameter (1 mm), increased flexibility, can be cut using a hot razor blade, ease of termination. But because of high intrinsic loss use of plastic fibers is normally restricted to only few metres.
- Plastic optic fiber (POF) offers noise immunity and low cable weight and volume and is competitive with shielded copper wire making it suitable for industrial applications.
- Silica (glass) optical fiber has better transmission characteristics (Low loss) than POF. Also, silica fiber can tolerate higher temperature than plastic fiber. On the other hand, POF is more flexible, less prone to breakage, easier to fabricate and cost is low than glass fibers.
- Another advantage of glass/glass fiber is that very clean fracture surface can be obtained which ensures that fiber cladding inside the connector retains its optical characteristics right up to the end face of fiber. Whereas in plastic glass/plastic fiber some additional losses exist due to fracture zone of plastic which even after grinding and polishing still have microscope end face absorption areas. These advantages and disadvantages are summarized in Table 1.10.3.

Types of cladding	Advantages	Disadvantages
Glass/glass fiber	<ul style="list-style-type: none"> <li>• Clean fracture surface.</li> <li>• Retention of optical characteristics.</li> </ul>	<ul style="list-style-type: none"> <li>• Less flexible than plastic fiber.</li> <li>• Prone to damage.</li> </ul>
Transparent plastic/plastic fiber	<ul style="list-style-type: none"> <li>• Large diameter.</li> <li>• Increased flexibility.</li> <li>• Ease of termination.</li> </ul>	<ul style="list-style-type: none"> <li>• High intrinsic loss.</li> <li>• Additional losses at the fracture zone.</li> <li>• Limited distances of a few metres and to environments protected from temperature extremes.</li> </ul>

**Table 1.10.3 Advantages and disadvantages of different fiber claddings**

### Recommended Questions

1. State and explain the advantages and disadvantages of fiber optic communication systems.
2. State and explain in brief the principle of light propagation.
3. Define following terms with respect to optical laws –
  - A) Reflection
  - B) Refraction
  - C) Refractive index
  - D) Snell's law
  - E) Critical angle
  - F) Total internal reflection (TIR)
4. Explain the important conditions for TIR to exist in fiber.
5. Derive an expression for maximum acceptance angle of a fiber.
6. Explain the acceptance cone of a fiber.
7. Define numerical aperture and state its significance also.
8. Explain the different types of rays in fiber optic.
9. Explain the following –

- A) Step index fiber
  - B) Graded index fiber
10. What is mean by mode of a fiber?
11. Write short notes on following –
- A) Single mode step index fiber
  - B) Multimode step index fiber
  - C) Multimode graded index fiber.
12. Explain the fiber materials used in fabrication requirements.
13. In case of glass fibers how the refractive index can be varied?
14. Briefly explain following techniques of fabrication.
- i) OVPO      ii) VAD
  - iii) MCVD   iv) PCVD
  - v) Double crucible technique.
15. Comment on major mechanical properties of a fiber.
16. Write a note on fiber arrangements.

## UNIT - 2

### TRANSMISSION CHARACTERISTICS OF OPTICAL FIBERS

Introduction, Attenuation, absorption, scattering losses, bending loss, dispersion, Intra modal dispersion, Inter modal dispersion.

#### RECOMMENDED READINGS:

#### TEXT BOOKS:

1. **Optical Fiber Communication** – Gerd Keiser, 4<sup>th</sup> Ed., MGH, 2008.
2. **Optical Fiber Communications**– – John M. Senior, Pearson Education. 3<sup>rd</sup> Impression, 2007.

#### REFERENCE BOOK:

1. **Fiber optic communication** – Joseph C Palais: 4<sup>th</sup> Edition, Pearson Education.



## Introduction

- One of the important property of optical fiber is signal attenuation. It is also known as fiber loss or signal loss. The signal attenuation of fiber determines the maximum distance between transmitter and receiver. The attenuation also determines the number of repeaters required, maintaining repeater is a costly affair.
- Another important property of optical fiber is distortion mechanism. As the signal pulse travels along the fiber length it becomes more broader. After sufficient length the broad pulses starts overlapping with adjacent pulses. This creates error in the receiver. Hence the distortion limits the information carrying capacity of fiber.

### 2.1 Attenuation

- Attenuation is a measure of decay of signal strength or loss of light power that occurs as light pulses propagate through the length of the fiber.
- In optical fibers the attenuation is mainly caused by two physical factors absorption and scattering losses. Absorption is because of fiber material and scattering due to structural imperfection within the fiber. Nearly 90 % of total attenuation is caused by Rayleigh scattering only. Microbending of optical fiber also contributes to the attenuation of signal.
- The rate at which light is absorbed is dependent on the wavelength of the light and the characteristics of particular glass. Glass is a silicon compound, by adding different additional chemicals to the basic silicon dioxide the optical properties of the glass can be changed.
- The Rayleigh scattering is wavelength dependent and reduces rapidly as the wavelength of the incident radiation increases.
- The attenuation of fiber is governed by the materials from which it is fabricated, the manufacturing process and the refractive index profile chosen. Attenuation loss is measured in dB/km.

### Attenuation Units

- As attenuation leads to a loss of power along the fiber, the output power is significantly less than the couples power. Let the couples optical power is  $p(0)$  i.e. at origin ( $z = 0$ ).

Then the power at distance  $z$  is given by,

$$P(z) = P(0)e^{-\alpha_p z} \quad \dots (2.1.1)$$

where,  $\alpha_p$  is fiber attenuation constant (per km).

$$\alpha_p = \frac{1}{z} \ln \left[ \frac{P(0)}{P(z)} \right]$$

$$\alpha_{\text{dB/km}} = 10 \cdot \frac{1}{z} \log \left[ \frac{P(0)}{P(z)} \right]$$

$$\alpha_{\text{dB/km}} = 4.343 \alpha_p \text{ per km}$$

This parameter is known as fiber loss or fiber attenuation.

- Attenuation is also a function of wavelength. Optical fiber wavelength as a function of wavelength is shown in Fig. 2.1.1.

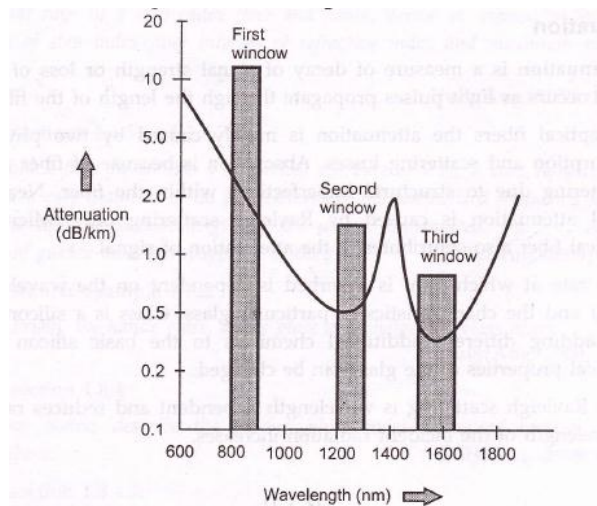

Fig. 2.1.1 Fiber attenuation as a function of wavelength

**Example 2.1.1 :** A low loss fiber has average loss of 3 dB/km at 900 nm. Compute the length over which –

- Power decreases by 50 %
- Power decreases by 75 %.

Solution :  $\alpha = 3 \text{ dB/km}$

- Power decreases by 50 %.

$$\Rightarrow \frac{P(0)}{P(z)} = 50 \% = 0.5$$

$\alpha$  is given by,

$$\alpha = 10 \cdot \frac{1}{z} \log \left[ \frac{P(0)}{P(z)} \right]$$

$$3 = 10 \cdot \frac{1}{z} \log [0.5]$$

∴  $z = 1 \text{ km}$  ... Ans.

b)  $\frac{P(0)}{P(z)} = 25 \% = 0.25$

Since power decrease by 75 %.

$$3 = 10 \times \frac{1}{z} \log [0.25]$$

∴  $z = 2 \text{ km}$  ... Ans.

**Example 2.1.2 :** For a 30 km long fiber attenuation 0.8 dB/km at 1300nm. If a 200 μwatt power is launched into the fiber, find the output power.

**Solution :**  $z = 30 \text{ km}$

$$\alpha = 0.8 \text{ dB/km}$$

$$P(0) = 200 \mu\text{W}$$

Attenuation in optical fiber is given by,

$$\alpha = 10 \times \frac{1}{z} \log \left[ \frac{P(0)}{P(z)} \right]$$

$$0.8 = 10 \times \frac{1}{30} \log \left[ \frac{200 \mu\text{W}}{P(z)} \right]$$

$$2.4 = 10 \times \log \left[ \frac{200 \mu\text{W}}{P(z)} \right]$$

$$\left[ \frac{200 \mu\text{W}}{P(z)} \right] = 10^{2.4}$$

$$\therefore P(z) = \left[ \frac{200 \mu\text{W}}{P(z)} \right] = 0.7962 \mu\text{W}$$

**Example 2.1.3 :** When mean optical power launched into an 8 km length of fiber is 12  $\mu\text{W}$ , the mean optical power at the fiber output is 3  $\mu\text{W}$ .

Determine –

- 1) Overall signal attenuation in dB.
- 2) The overall signal attenuation for a 10 km optical link using the same fiber with splices at 1 km intervals, each giving an attenuation of 1 dB.

**Solution : Given :**  $z = 8 \text{ km}$

$$P(0) = 120 \mu\text{W}$$

$$P(z) = 3 \mu\text{W}$$

- 1) Overall attenuation is given by,

$$\alpha = 10 \cdot \log \left[ \frac{P(0)}{P(z)} \right]$$

$$\alpha = 10 \cdot \log \left[ \frac{120}{3} \right]$$

$$\alpha = 16.02 \text{ dB}$$

- 2) Overall attenuation for 10 km,

$$\text{Attenuation per km } \alpha_{\text{dB}} = \frac{16.02}{z} = \frac{16.02}{8} = 2.00 \text{ dB/km}$$

$$\text{Attenuation in 10 km link} = 2.00 \times 10 = 20 \text{ dB}$$

In 10 km link there will be 9 splices at 1 km interval. Each splice introducing attenuation of 1 dB.

$$\text{Total attenuation} = 20 \text{ dB} + 9 \text{ dB} = \mathbf{29 \text{ dB}}$$

**Example 2.1.4 :** A continuous 12 km long optical fiber link has a loss of 1.5 dB/km.

- i) What is the minimum optical power level that must be launched into the fiber to maintain as optical power level of 0.3  $\mu\text{W}$  at the receiving end?
- ii) What is the required input power if the fiber has a loss of 2.5 dB/km?

[July/Aug.-2007, 6 Marks]

**Solution : Given data :**  $z = 12 \text{ km}$

$$\alpha = 1.5 \text{ dB/km}$$

$$P(0) = 0.3 \mu\text{W}$$

- i) Attenuation in optical fiber is given by,

$$\alpha = 10 \times \frac{1}{z} \log \left( \frac{P(0)}{P(z)} \right)$$

$$1.5 = 10 \times \frac{1}{12} \log \left( \frac{0.3 \mu\text{W}}{P(z)} \right)$$

$$\log \left( \frac{0.3 \mu\text{W}}{P(z)} \right) = \frac{1.5}{0.833}$$

$$= 1.80$$

$$\left( \frac{0.3 \mu\text{W}}{P(z)} \right) = 10^{1.8}$$

$$P(z) = \left( \frac{0.3 \mu\text{W}}{10^{1.8}} \right) = \frac{0.3}{63.0}$$

$$P(z) = 4.76 \times 10^{-9} \text{ W}$$

Optical power output =  $4.76 \times 10^{-9} \text{ W}$

... Ans.

- ii) Input power = ?  $P(0)$

When  $\alpha = 2.5 \text{ dB/km}$

$$\alpha = 10 \times \frac{1}{z} \log \left( \frac{P(0)}{P(z)} \right)$$

$$2.5 = 10 \times \frac{1}{z} \log \left( \frac{P(0)}{4.76 \times 10^{-9}} \right)$$

$$\log \left( \frac{P(0)}{4.76 \times 10^{-9}} \right) = \frac{2.5}{0.833} = 3$$

$$\frac{P(0)}{4.76 \times 10^{-9}} = 10^3 = 1000$$

$$\therefore P(0) = 4.76 \mu\text{W}$$

Input power = **4.76  $\mu\text{W}$**

... Ans.

**Example 2.1.5 :** Optical power launched into fiber at transmitter end is 150  $\mu\text{W}$ . The power at the end of 10 km length of the link working in first window is -38.2 dBm. Another system of same length working in second window is 47.5  $\mu\text{W}$ . Same length system working in third window has 50 % launched power. Calculate fiber attenuation for each case and mention wavelength of operation. **[Jan./Feb.-2009, 4 Marks]**

**Solution : Given data:**

$$P(0) = 150 \mu\text{W}$$

$$z = 10 \text{ km}$$

$$P(z) = -38.2 \text{ dBm} \Rightarrow \begin{cases} -38.2 = 10 \log \frac{P(z)}{1 \text{ mW}} \\ P(z) = 0.151 \mu\text{W} \end{cases}$$

$$z = 10 \text{ km}$$

$$\alpha = 10 \times \frac{1}{z} \log \left[ \frac{P(0)}{P(z)} \right]$$

Attenuation in 1<sup>st</sup> window:

$$\alpha_1 = 10 \times \frac{1}{10} \log \left[ \frac{150}{0.151} \right]$$

$$\alpha_1 = 2.99 \text{ dB/km}$$

... Ans.

Attenuation in 2<sup>nd</sup> window:

$$\alpha_2 = 10 \times \frac{1}{10} \log \left[ \frac{150}{47.5} \right]$$

$$\alpha_2 = 0.49 \text{ dB/km}$$

... Ans.

Attenuation in 3<sup>rd</sup> window:

$$\alpha_3 = 10 \times \frac{1}{10} \log \left[ \frac{150}{75} \right]$$

$$\alpha_3 = 0.30 \text{ dB/km}$$

... Ans.

Wavelength in 1<sup>st</sup> window is 850 nm.Wavelength in 2<sup>nd</sup> window is 1300 nm.Wavelength in 3<sup>rd</sup> window is 1550 nm.

**Example 2.1.6 :** The input power to an optical fiber is 2 mW while the power measured at the output end is 2  $\mu$ W. If the fiber attenuation is 0.5 dB/km, calculate the length of the fiber.

[July/Aug.-2006, 6 Marks]

**Solution : Given :**  $P(0) = 2 \text{ mwatt} = 2 \times 10^{-3} \text{ watt}$

$$P(z) = 2 \text{ } \mu\text{watt} = 2 \times 10^{-6} \text{ watt}$$

$$\alpha = 0.5 \text{ dB/km}$$

$$\alpha = 10 \times \frac{1}{z} \log \left[ \frac{P(0)}{P(z)} \right]$$

$$0.5 = 10 \times \frac{1}{z} \log \left[ \frac{2 \times 10^{-3}}{2 \times 10^{-6}} \right]$$

$$0.5 = \frac{1}{z} \times 3$$

$$z = \frac{3}{0.05}$$

$$z = 60 \text{ km}$$

... Ans.

## 2.2 Absorption

- Absorption loss is related to the material composition and fabrication process of fiber. Absorption loss results in dissipation of some optical power as hear in the fiber cable. Although glass fibers are extremely pure, some impurities still remain as residue after purification. The amount of absorption by these impurities depends on their concentration and light wavelength.
- Absorption is caused by three different mechanisms.
  - 1) Absorption by atomic defects in glass composition.
  - 2) Extrinsic absorption by impurity atoms in glass matts.
  - 3) Intrinsic absorption by basic constituent atom of fiber.

### Absorption by Atomic Defects

- Atomic defects are imperfections in the atomic structure of the fiber materials such as missing molecules, high density clusters of atom groups. These absorption losses are negligible compared with intrinsic and extrinsic losses.
- The absorption effect is most significant when fiber is exposed to ionizing radiation in nuclear reactor, medical therapies, space missions etc. The radiation damages the internal structure of fiber. The damages are proportional to the intensity of ionizing particles. This results in increasing attenuation due to atomic defects and absorbing optical energy. The total dose a material receives is expressed in rad (Si), this is the unit for measuring radiation absorbed in bulk silicon.

$$1 \text{ rad (Si)} = 0.01 \text{ J.kg}$$

The higher the radiation intensity more the attenuation as shown in Fig 2.2.1.



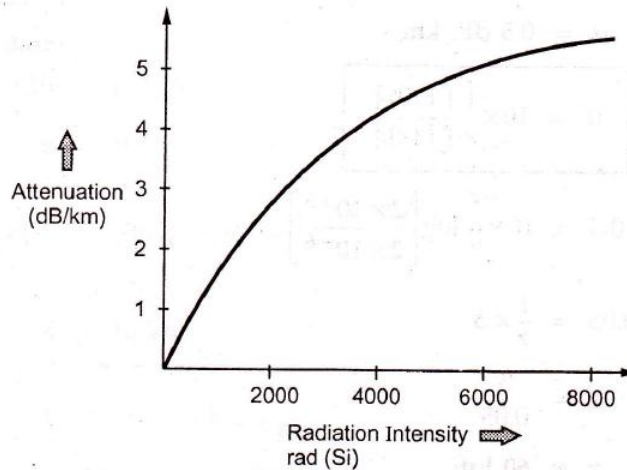
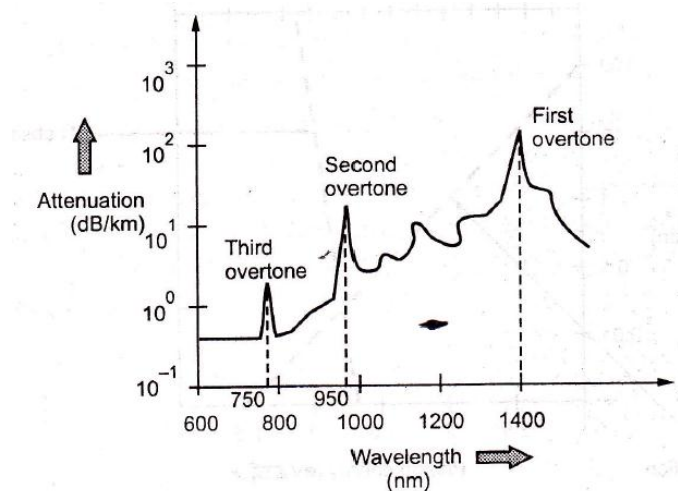

Fig. 2.2.1 Ionizing radiation intensity Vs fiber attenuation

### Extrinsic Absorption

- Extrinsic absorption occurs due to electronic transitions between the energy level and because of charge transitions from one ion to another. A major source of attenuation is from transition of metal impurity ions such as iron, chromium, cobalt and copper. These losses can be upto 1 to 10 dB/km. The effect of metallic impurities can be reduced by glass refining techniques.
- Another major extrinsic loss is caused by absorption due to **OH (Hydroxyl)** ions impurities dissolved in glass. Vibrations occur at wavelengths between 2.7 and 4.2  $\mu\text{m}$ . The absorption peaks occurs at 1400, 950 and 750 nm. These are first, second and third overtones respectively.
- Fig. 2.2.2 shows absorption spectrum for OH group in silica. Between these absorption peaks there are regions of low attenuation.



**Fig. 2.2.2 Absorption spectra for OH group**

### Intrinsic Absorption

- Intrinsic absorption occurs when material is in absolutely pure state, no density variation and inhomogeneities. Thus intrinsic absorption sets the fundamental lower limit on absorption for any particular material.
- Intrinsic absorption results from electronic absorption bands in UV region and from atomic vibration bands in the near infrared region.
- The electronic absorption bands are associated with the band gaps of amorphous glass materials. Absorption occurs when a photon interacts with an electron in the valence band and excites it to a higher energy level. UV absorption decays exponentially with increasing wavelength ( $\lambda$ ).
- In the IR (infrared) region above 1.2  $\mu\text{m}$  the optical waveguide loss is determined by presence of the OH ions and inherent IR absorption of the constituent materials. The inherent IR absorption is due to interaction between the vibrating band and the electromagnetic field of optical signal this results in transfer of energy from field to the band, thereby giving rise to absorption, this absorption is strong because of many bonds present in the fiber.
- Attenuation spectra for the intrinsic loss mechanism in pure Ge is shown in Fig. 2.2.3.

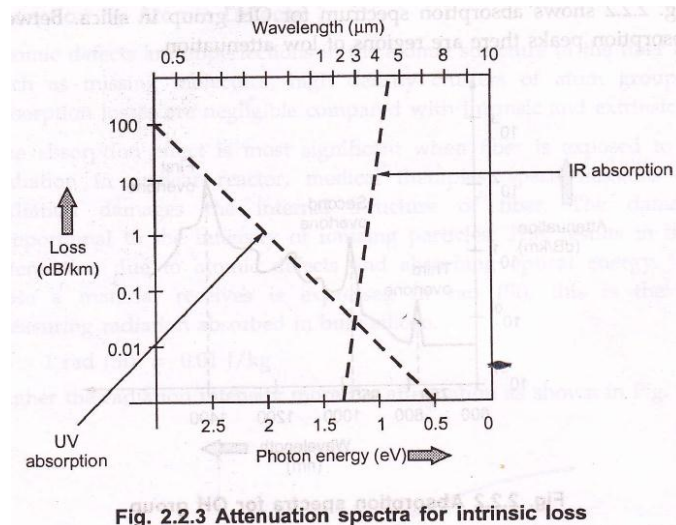

- The ultraviolet loss at any wavelength is expressed as,

$$\alpha_{uv} = \frac{154.2}{46.6x + 60} \times 10^{-2} \times e^{\left(\frac{4.65}{\lambda}\right)} \quad \dots (2.2.1)$$

where, x is mole fraction of GeO<sub>2</sub>.

$\lambda$  is operating wavelength.

$\alpha_{uv}$  is in dB/km.

- The loss in infrared (IR) region (above 1.2  $\mu\text{m}$ ) is given by expression :

$$\alpha_{IR} = 7.81 \times 10^{11} \times e^{\left(\frac{-48.48}{\lambda}\right)} \quad \dots (2.2.2)$$

The expression is derived for GeO<sub>2</sub>-SiO<sub>2</sub> glass fiber.

### 2.3 Rayleigh Scattering Losses

- Scattering losses exist in optical fibers because of microscopic variations in the material density and composition. As glass is composed by a randomly connected network of molecules and several oxides (e.g. SiO<sub>2</sub>, GeO<sub>2</sub> and P<sub>2</sub>O<sub>5</sub>), these are the major cause of compositional structure fluctuation. These two effects result in variation in refractive index and Rayleigh type scattering of light.
- Rayleigh scattering** of light is due to small localized changes in the refractive index of the core and cladding material. There are two causes during the manufacturing of fiber.

- The first is due to slight fluctuation in mixing of ingredients. The random changes because of this are impossible to eliminate completely.
- The other cause is slight change in density as the silica cools and solidifies. When light ray strikes such zones it gets scattered in all directions. The amount of scatter depends on the size of the discontinuity compared with the wavelength of the light so the shortest wavelength (highest frequency) suffers most scattering. Fig. 2.3.1 shows graphically the relationship between wavelength and Rayleigh scattering loss.

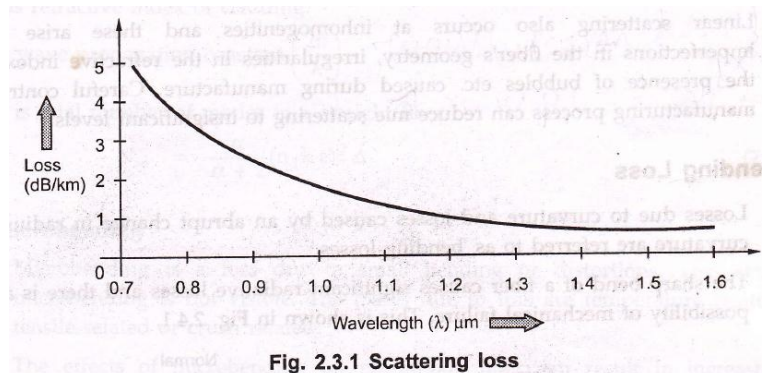

Fig. 2.3.1 Scattering loss

- Scattering loss for single component glass is given by,

$$\alpha_{\text{scat}} = \frac{8\pi^3}{3\lambda^4} (n^2 - 1)^2 k_B T_f \beta_T \text{ nepers} \quad \dots (2.3.1)$$

where,  $n$  = Refractive index

$k_B$  = Boltzmann's constant

$\beta_T$  = Isothermal compressibility of material

$T_f$  = Temperature at which density fluctuations are frozen into the glass as it solidifies (fictive temperature)

Another form of equation is

$$\alpha_{\text{scat}} = \frac{8\pi^3}{3\lambda^4} n^8 p^2 k_B T_f \beta_T \text{ nepers} \quad \dots (2.3.2)$$

where,  $P$  = Photoelastic coefficient

- Scattering loss for multicomponent glasses is given by,

$$\alpha_{\text{scat}} = \frac{8\pi^3}{3\lambda^4} (\delta_n^2)^2 \delta v$$

where,  $\delta_n^2$  = Mean square refractive index fluctuation

$\delta v$  = Volume of fiber

- Multimode fibers have higher dopant concentrations and greater compositional fluctuations. The overall losses in this fibers are more as compared to single mode fibers.

#### Mie Scattering :

- Linear scattering also occurs at inhomogenities and these arise from imperfections in the fiber's geometry, irregularities in the refractive index and the presence of bubbles etc. caused during manufacture. Careful control of manufacturing process can reduce mie scattering to insignificant levels.

### 2.4 Bending Loss

- Losses due to curvature and losses caused by an abrupt change in radius of curvature are referred to as 'bending losses.'
- The sharp bend of a fiber causes significant radiative losses and there is also possibility of mechanical failure. This is shown in Fig. 2.4.1.

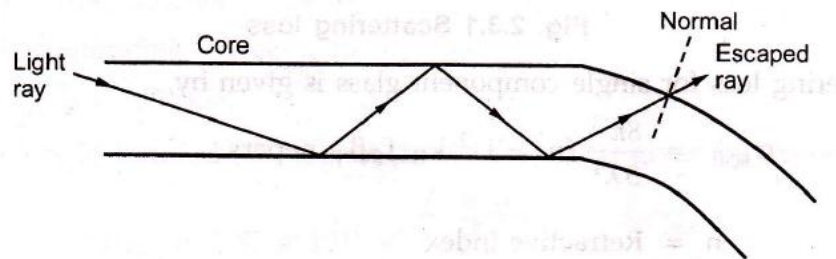

**Fig. 2.4.1 Bending loss**

- As the core bends the normal will follow it and the ray will now find itself on the wrong side of critical angle and will escape. The sharp bends are therefore avoided.
- The radiation loss from a bent fiber depends on –
  - i) Field strength of certain critical distance  $x_c$  from fiber axis where power is lost through radiation.
  - ii) The radius of curvature  $R$ .
- The higher order modes are less tightly bound to the fiber core, the higher order modes radiate out of fiber firstly.
- For multimode fiber, the effective number of modes that can be guided by curved fiber is given expression :

$$N_{\text{eff}} = N_{\infty} \left\{ 1 - \frac{\alpha+2}{2\alpha\Delta} \left[ \frac{2a}{R} + \left( \frac{2}{2n_2 k R} \right)^{2/3} \right] \right\} \quad \dots (2.4.1)$$

where,

$\alpha$  is graded index profile.

$\Delta$  is core – cladding index difference.

$n_2$  is refractive index of cladding.

$k$  is wave propagation constant  $\left( \frac{2\pi}{\lambda} \right)$ .

$N_{\infty}$  is total number of modes in a straight fiber.

$$N_{\infty} = \frac{\alpha}{\alpha+2} (n_1 k a)^2 \Delta \quad \dots (2.4.2)$$

### Microbending

- Microbending is a loss due to small bending or distortions. This small microbending is not visible. The losses due to this are temperature related, tensile related or crush related.
- The effects of microbending on multimode fiber can result in increasing attenuation (depending on wavelength) to a series of periodic peaks and troughs on the spectral attenuation curve. These effects can be minimized during installation and testing. Fig. 2.4.2 illustrates microbending.

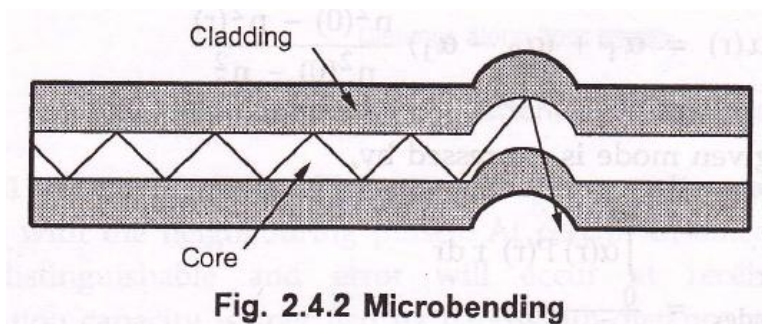

### Macrobending

- The change in spectral attenuation caused by macrobending is different to microbending. Usually there are no peaks and troughs because in a macrobending no light is coupled back into the core from the cladding as can happen in the case of microbends.

- The macrobending losses are caused by large scale bending of fiber. The losses are eliminated when the bends are straightened. The losses can be minimized by not exceeding the long term bend radii. Fig. 2.4.3 illustrates macrobending.

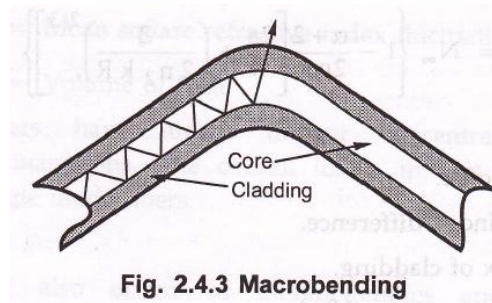

Fig. 2.4.3 Macrobending

## 2.5 Core and Cladding Loss

- Since the core and cladding have different indices of refraction hence they have different attenuation coefficients  $\alpha_1$  and  $\alpha_2$  respectively.
- For step index fiber, the loss for a mode order (v, m) is given by,

$$\alpha_{vm} = \alpha_1 \frac{P_{\text{core}}}{P} + \alpha_2 \frac{P_{\text{cladding}}}{P} \quad \dots (2.5.1)$$

For low-order modes, the expression reduced to

$$\alpha_{vm} = \alpha_1 + (\alpha_2 + \alpha_1) \frac{P_{\text{cladding}}}{P} \quad \dots (2.5.2)$$

where,  $\frac{P_{\text{core}}}{P}$  and  $\frac{P_{\text{cladding}}}{P}$  are fractional powers.

- For graded index fiber, loss at radial distance is expressed as,

$$\alpha(r) = \alpha_1 + (\alpha_2 - \alpha_1) \frac{n^2(0) - n^2(r)}{n^2(0) - n_2^2} \quad \dots (2.5.3)$$

The loss for a given mode is expressed by,

$$\alpha_{\text{Graded Index}} = \frac{\int_0^\infty \alpha(r) P(r) r dr}{\int_0^\infty P(r) r dr} \quad \dots (2.5.4)$$

where,  $P(r)$  is power density of that mode at radial distance  $r$ .

## 2.6 Signal Distortion in Optical Waveguide

- The pulse get distorted as it travels along the fiber lengths. Pulse spreading in fiber is referred as dispersion. Dispersion is caused by difference in the propagation times of light rays that takes different paths during the propagation. The light pulses travelling down the fiber encounter dispersion effect because of this the pulse spreads out in time domain. Dispersion limits the information bandwidth. The distortion effects can be analyzed by studying the group velocities in guided modes.

### Information Capacity Determination

- Dispersion and attenuation of pulse travelling along the fiber is shown in Fig. 2.6.1.

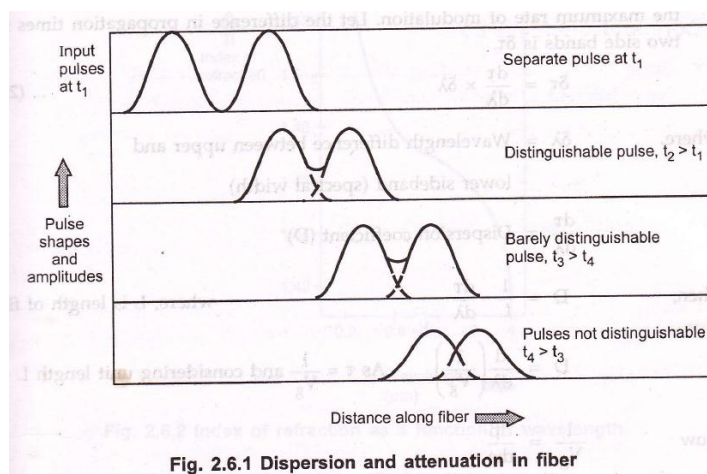

Fig. 2.6.1 Dispersion and attenuation in fiber

- Fig. 2.6.1 shows, after travelling some distance, pulse starts broadening and overlap with the neighbouring pulses. At certain distance the pulses are not even distinguishable and error will occur at receiver. Therefore the information capacity is specified by bandwidth-distance product (MHz . km). For step index bandwidth distance product is 20 MHz . km and for graded index it is 2.5 MHz . km.

### Group Delay

- Consider a fiber cable carrying optical signal equally with various modes and each mode contains all the spectral components in the wavelength band. All the spectral components travel independently and they observe different **time delay** and **group delay** in the direction of propagation. The velocity at which the energy in a pulse travels along the fiber is known as **group velocity**. Group velocity is given by,

$$V_g = \frac{\partial \omega}{\partial \beta} \quad \dots (2.6.1)$$



- Thus different frequency components in a signal will travel at different group velocities and so will arrive at their destination at different times, for digital modulation of carrier, this results in dispersion of pulse, which affects the maximum rate of modulation. Let the difference in propagation times for two side bands is  $\delta\tau$ .

$$\delta\tau = \frac{d\tau}{d\lambda} \times \delta\lambda \quad \dots (2.6.2)$$

where,  $\delta\tau$  = Wavelength difference between upper and lower sideband (spectral width)

$$\frac{d\tau}{d\lambda} = \text{Dispersion coefficient (D)}$$

Then,  $D = \frac{1}{L} \cdot \frac{d\tau}{d\lambda}$  where, L is length of fiber.

$$D = \frac{d}{d\lambda} \left( \frac{1}{v_g} \right) \quad \text{As } \tau = \frac{1}{v_g} \text{ and considering unit length } L = 1.$$

Now  $\frac{1}{v_g} = \frac{d\beta}{d\omega}$

$$\frac{1}{v_g} = \frac{d\lambda}{d\omega} \times \frac{d\beta}{d\lambda}$$

$$\frac{1}{v_g} = \frac{-\lambda^2}{2\pi c} \times \frac{d\beta}{d\lambda}$$

$$\therefore D = \frac{d}{d\lambda} \left( \frac{-\lambda^2}{2\pi c} \cdot \frac{d\beta}{d\lambda} \right) \quad \dots (2.6.3)$$

- Dispersion is measured in picoseconds per nanometer per kilometer.

### Material Dispersion

- Material dispersion is also called as chromatic dispersion. Material dispersion exists due to change in index of refraction for different wavelengths. A light ray contains components of various wavelengths centered at wavelength  $\lambda_{10}$ . The time delay is different for different wavelength components. This results in time dispersion of pulse at the receiving end of fiber. Fig. 2.6.2 shows index of refraction as a function of optical wavelength.

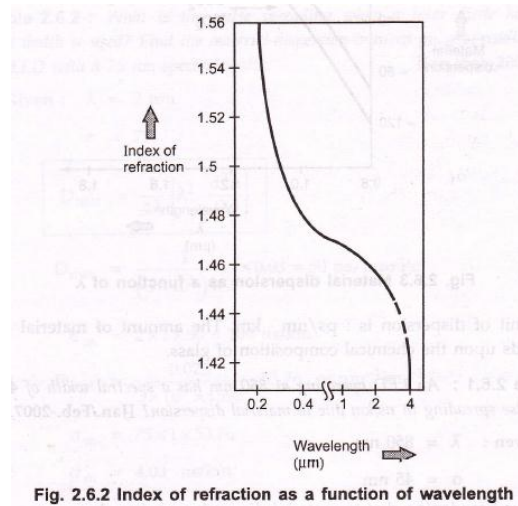

Fig. 2.6.2 Index of refraction as a function of wavelength

- The material dispersion for unit length ( $L = 1$ ) is given by

$$D_{\text{mat}} = \frac{-\lambda}{c} \times \frac{d^2n}{d\lambda^2} \quad \dots (2.6.4)$$

where,  $c =$  Light velocity

$\lambda =$  Center wavelength

$\frac{d^2n}{d\lambda^2} =$  Second derivative of index of refraction w.r.t wavelength

Negative sign shows that the upper sideband signal (lowest wavelength) arrives before the lower sideband (highest wavelength).

- A plot of material dispersion and wavelength is shown in Fig. 2.6.3

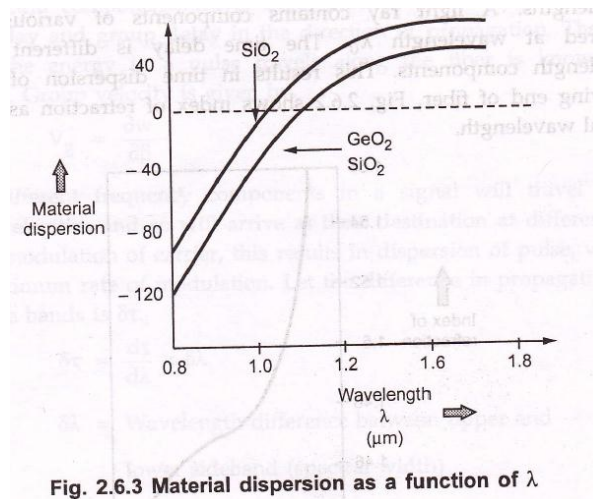

- The unit of dispersion is : ps/nm . km. The amount of material dispersion depends upon the chemical composition of glass.

**Example 2.6.1 :** An LED operating at 850 nm has a spectral width of 45 nm. What is the pulse spreading in ns/km due to material dispersion? **[Jan./Feb.-2007, 3 Marks]**

**Solution : Given :**  $\lambda = 850 \text{ nm}$

$\sigma = 45 \text{ nm}$

R.M.S pulse broadening due to material dispersion is given by,

$$\sigma_m = \sigma LM$$

Considering length  $L = 1 \text{ metre}$

$$\text{Material dispersion constant } D_{\text{mat}} = \frac{-\lambda}{c} \cdot \frac{d^2n}{d\lambda^2}$$

For LED source operating at 850 nm,  $\left| \lambda^2 \frac{d^2n}{d\lambda^2} \right| = 0.025$

$$\therefore M = \frac{1}{c\lambda} \left| \lambda^2 \frac{d^2n}{d\lambda^2} \right| = \frac{1}{(3 \times 10^8) (850)} \times 0.025$$

$$M = 9.8 \text{ ps/nm/km}$$

$$\therefore \sigma_m = 45 \times 1 \times 9.8 = 441 \text{ ps/km}$$

$$\sigma_m = 441 \text{ ns/km}$$

... Ans.

**Example 2.6.2 :** What is the pulse spreading when a laser diode having a 2 nm spectral width is used? Find the the material-dispersion-induced pulse spreading at 1550 nm for an LED with a 75 nm spectral width  
[Jan./Feb.-2007, 7 Marks]

**Solutions : Given :**  $\lambda = 2 \text{ nm}$

$$\sigma = 75$$

$$D_{\text{mat}} = \frac{1}{c\lambda} \left| \lambda^2 \cdot \frac{d^2n}{d\lambda^2} \right|$$

$$D_{\text{mat}} = \frac{1}{(3 \times 10^5) \times 2} \times 0.03 = 50 \text{ ps/nm/km}$$

$$\sigma_m = 2 \times 1 \times 50 = 100 \text{ ns/km}$$

... Ans.

For LED  $D_{\text{mat}} = \frac{0.025}{(3 \times 10^5) \times 1550} = 53.76 \text{ ps nm}^{-1}\text{km}^{-1}$

$$\sigma_m = 75 \times 1 \times 53.76$$

$$\sigma_m = 4.03 \text{ ns/km}$$

... Ans.

### Waveguide Dispersion

- Waveguide dispersion is caused by the difference in the index of refraction between the core and cladding, resulting in a 'drag' effect between the core and cladding portions of the power.
- Waveguide dispersion is significant only in fibers carrying fewer than 5-10 modes. Since multimode optical fibers carry hundreds of modes, they will not have observable waveguide dispersion.
- The group delay ( $\tau_{wg}$ ) arising due to waveguide dispersion.

$$(\tau_{wg}) = \frac{L}{c} \left[ n_2 + n_2 \Delta \frac{d(kb)}{dk} \right] \quad \dots (2.6.5)$$

Where,

$b$  = Normalized propagation constant

$k = 2\pi / \lambda$  (group velocity)

Normalized frequency  $V$ ,

$$V = ka(n_1^2 - n_2^2)^{\frac{1}{2}}$$

$$V = k a n_2 \sqrt{2\Delta} \text{ (For small } \Delta \text{)}$$

$$\therefore \tau_{wg} = \frac{L}{c} \left[ n_2 + n_2 \Delta \frac{d(v_b)}{dV} \right] \quad \dots (2.6.6)$$

The second term  $\frac{d(v_b)}{dV}$  is waveguide dispersion and is mode dependent term..

- As frequency is a function of wavelength, the group velocity of the energy varies with frequency. This produces additional losses (waveguide dispersion). The propagation constant ( $\beta$ ) varies with wavelength, the causes of which are independent of material dispersion.

### Chromatic Dispersion

- The combination of material dispersion and waveguide dispersion is called chromatic dispersion. These losses primarily concern the spectral width of transmitter and choice of correct wavelength.
- A graph of effective refractive index against wavelength illustrates the effects of material, chromatic and waveguide dispersion.

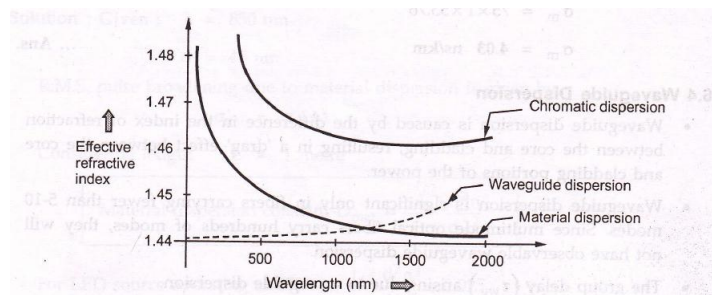

Fig. 2.6.4 Graph of effective refractive index against wavelength showing effects of chromatic, waveguide and material dispersion

- Material dispersion and waveguide dispersion effects vary in opposite senses as the wavelength increases, but at an optimum wavelength around 1300 nm, the two effects almost cancel each other and chromatic dispersion is at a minimum. Attenuation is therefore also at a minimum and makes 1300 nm a highly attractive operating wavelength.

## Modal Dispersion

- As only a certain number of modes can propagate down the fiber, each of these modes carries the modulation signal and each one is incident on the boundary at a different angle, they will each have their own individual propagation times. The net effect is spreading of pulse, this form of dispersion is called modal dispersion.
- Modal dispersion takes place in multimode fibers. It is moderately present in graded index fibers and almost eliminated in single mode step index fibers.
- Modal dispersion is given by,

$$\Delta t_{\text{modal}} = \frac{n_1 Z}{c} \left( \frac{\Delta}{1 - \Delta} \right)$$

where

$\Delta t_{\text{modal}}$  = Dispersion

$n_1$  = Core refractive index

$Z$  = Total fiber length

$c$  = Velocity of light in air

$\Delta$  = Fractional refractive index  $\left( \frac{n_1 - n_2}{n_1} \right)$

Putting

$\Delta = \frac{(NA^2)Z}{2n_1 c}$  in above equation

$$\Delta t_{\text{modal}} = \frac{(NA^2)Z}{2n_1 c}$$

- The modal dispersion  $\Delta t_{\text{modal}}$  describes the optical pulse spreading due to modal effects optical pulse width can be converted to electrical rise time through the relationship.

$$t_{r \text{ mod}} = 0.44 (\Delta t_{\text{modal}}) \pi r^2$$

## Signal distortion in Single Mode Fibers

- The pulse spreading  $\sigma_{wg}$  over range of wavelengths can be obtained from derivative of group delay with respect to  $\lambda$ .

$$\sigma_{wg} = \left| \frac{d\tau_{wg}}{d\lambda} \right| \sigma_{\lambda}$$

$$\begin{aligned}
 &= L \left| D_{\text{wg}}(\lambda) \right| \sigma_{\lambda} \\
 &= \frac{V}{\lambda} \left| \frac{d\tau_{\text{wg}}}{d\lambda} \right| \sigma_{\lambda} \\
 &= \frac{n_2 L \Delta \sigma_{\lambda}}{c \lambda} \left[ V \frac{d^2(Vb)}{dV^2} \right] \quad \dots (2.6.7)
 \end{aligned}$$

where,

$$\boxed{D_{\text{wg}}(\lambda) = \frac{-n_2 \Delta}{c \lambda} \left[ V \frac{d^2(Vb)}{dV^2} \right]} \quad \dots (2.6.8)$$

- This is the equation for waveguide dispersion for unit length.

**Example 2.6.3 :** For a single mode fiber  $n_2 = 1.48$  and  $\Delta = 0.2 \%$  operating at  $\lambda = 1320$  nm, compute the waveguide dispersion if  $V \cdot \frac{d^2(Vb)}{dV^2} = 0.26$ .

Solution :  $n_2 = 1.48$

$\Delta = 0.2$

$\lambda = 1320$  nm

Waveguide dispersion is given by,

$$\begin{aligned}
 \boxed{D_{\text{wg}}(\lambda) = \frac{-n_2 \Delta}{c \lambda} \left[ V \frac{d^2(Vb)}{dV^2} \right]} \\
 &= \frac{-1.48 \times 0.2}{3 \times 10^5 \times 1320} [0.26] \\
 &= -1.943 \text{ picosec/nm} \cdot \text{km}.
 \end{aligned}$$

### Higher Order Dispersion

- Higher order dispersive effective effects are governed by dispersion slope S.

$$S = \frac{dD}{d\lambda}$$

where,

D is total dispersion.

Also, 
$$S = \left(\frac{2\pi c}{\lambda^2}\right)^2 \beta_3 + \left(\frac{4\pi c}{\lambda^3}\right) \beta_2$$

where,

$\beta_2$  and  $\beta_3$  are second and third order dispersion parameters.

- Dispersion slope  $S$  plays an important role in designing WDM system

### Dispersion Induced Limitations

- The extent of pulse broadening depends on the width and the shape of input pulses. The pulse broadening is studied with the help of wave equation.

### Basic Propagation Equation

- The basic propagation equation which governs pulse evolution in a single mode fiber is given by,

$$\frac{\partial A}{\partial z} + \beta_1 \frac{\partial A}{\partial t} + \frac{i\beta_2}{2} \frac{\partial^2 A}{\partial t^2} - \frac{\beta_3}{6} \frac{\partial^3 A}{\partial t^3} = 0$$

where,

$\beta_1$ ,  $\beta_2$  and  $\beta_3$  are different dispersion parameters.

### Chirped Gaussian Pulses

- A pulse is said to be chirped if its carrier frequency changes with time.
- For a Gaussian spectrum having spectral width  $\sigma_\omega$ , the pulse broadening factor is given by,

$$\frac{\sigma^2}{\sigma_0^2} = \left(1 + \frac{C\beta_2 L}{2\sigma_0^2}\right)^2 + (1 + V_\omega^2) \left(\frac{\beta_2 L}{2\sigma_0^2}\right)^2 + (1 + C + V_\omega^2)^2 \left(\frac{\beta_3 L}{4\sqrt{2}\sigma_0^3}\right)^2 \pi r^2$$

where,  $V_\omega = 2\sigma_\omega \sigma_0$

### Limitations of Bit Rate

- The limiting bit rate is given by,

$$4B \sigma \leq 1$$

- The condition relating bit rate-distance product (BL) and dispersion (D) is given by,



$$BL |D| \sigma_\lambda \leq \frac{1}{4}$$

$$BL |S| \sigma_\lambda^2 \leq \frac{1}{\sqrt{8}}$$

where,  $S$  is dispersion slope.

- Limiting bit rate a single mode fibers as a function of fiber length for  $\sigma_\lambda = 0, 1$  and  $5\text{nm}$  is shown in fig. 2.6.5.

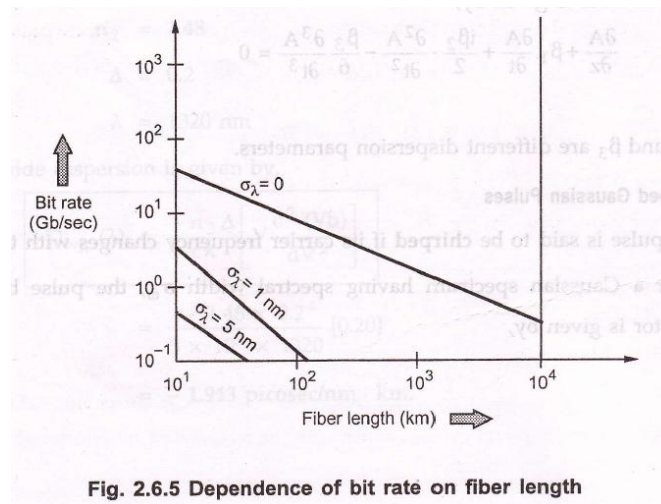

### Polarization Mode Dispersion (PMD)

- Different frequency component of a pulse acquires different polarization state (such as linear polarization and circular polarization). This results in pulse broadening is known as **polarization mode dispersion (PMD)**.
- PMD is the limiting factor for optical communication system at high data rates. The effects of PMD must be compensated.

### 2.7 Pulse Broadening in GI Fibers

- The core refractive index varies radially in case of graded index fibers, hence it supports multimode propagation with a low intermodal delay distortion and high data rate over long distance is possible. The higher order modes travelling in outer regions of the core, will travel faster than the lower order modes travelling in high refractive index region. If the index profile is carefully controlled, then the transit times of the individual modes will be identical, so eliminating modal dispersion.
- The r.m.s pulse broadening is given as :

$$\sigma = \left( \sigma_{\text{intermodal}}^2 + \sigma_{\text{intermodal}}^2 \right)^{1/2} \quad \dots (2.7.1)$$

where,

$\sigma_{\text{intermodal}}$  – R.M.S pulse width due to intermodal delay distortion.

$\sigma_{\text{intermodal}}$  – R.M.S pulse width resulting from pulse broadening within each mode.

- The intermodal delay and pulse broadening are related by expression given by Personick.

$$\sigma_{\text{intermodal}} = \left( \langle \tau_g^2 \rangle - \langle \tau_g \rangle^2 \right)^{1/2} \quad \dots (2.7.2)$$

Where  $\tau_g$  is group delay.

From this the expression for intermodal pulse broadening is given as:

$$\sigma_{\text{intermodal}} = \frac{LN_1\Delta}{2c} \cdot \frac{\alpha}{\alpha+1} \left( \frac{\alpha+2}{3\alpha+2} \right)^{1/2} \times \left[ c_1^2 + \frac{4c_1c_2(\alpha+1)}{2\alpha+1} + \frac{16\Delta^2c_2^2(\alpha+1)^2}{(5\alpha+2)(3\alpha+2)} \right]^{1/2} \quad \dots (2.7.3)$$

$$c_1 = \frac{\alpha-2-E}{\alpha+2} \quad \text{and} \quad c_2 = \frac{3\alpha-2-2c}{2(\alpha+2)}$$

- The intramodal pulse broadening is given as :

$$\sigma_{\text{intramodal}}^2 = \left( \frac{\sigma\lambda}{\lambda} \right)^2 \left\langle \left( \lambda \frac{d\tau_g}{d\lambda} \right)^2 \right\rangle \quad \dots (2.7.4)$$

Where  $\sigma_\lambda$  is spectral width of optical source.

Solving the expression gives :

$$\sigma_{\text{intramodal}}^2 = \frac{L}{c} \cdot \frac{\sigma\lambda}{\lambda} \left[ \left( -\lambda^2 \frac{d^2n_1}{d\lambda^2} \right)^2 - N_1c_1\Delta \left( 2\lambda^2 \frac{d^2n_1}{d\lambda^2} \cdot \frac{\alpha}{\alpha+1} - N_1c_1\Delta \frac{4\alpha^2}{(\alpha+2)(3\alpha+2)} \right) \right]^{1/2} \quad \dots (2.7.5)$$

## 2.8 Mode Coupling

- After certain initial length, the pulse distortion increases less rapidly because of mode coupling. The energy from one mode is coupled to other modes because of:
  - Structural imperfections.
  - Fiber diameter variations.
  - Refractive index variations.
  - Microbends in cable.
- Due to the mode coupling, average propagation delay becomes less and intermodal distortion reduces.
- Suppose certain initial coupling length =  $L_c$ , mode coupling length, over  $L_c = Z$ . Additional loss associated with mode coupling =  $h$  (dB/km).

Therefore the excess attenuation resulting from mode coupling =  $hZ$ .

The improvement in pulse spreading by mode coupling is given as :

$$hZ \left( \frac{\sigma_c}{\sigma_0} \right) = C$$

where,  $C$  is constant independent of all dimensional quantities and refractive indices.

$\sigma_c$  is pulse broadening under mode coupling.

$\sigma_0$  is pulse broadening in absence of mode coupling.

- For long fiber lengths the effect of mode coupling on pulse distortion is significant. For a graded index fiber, the effect of distance on pulse broadening for various coupling losses are shown in Fig. 2.8.1.

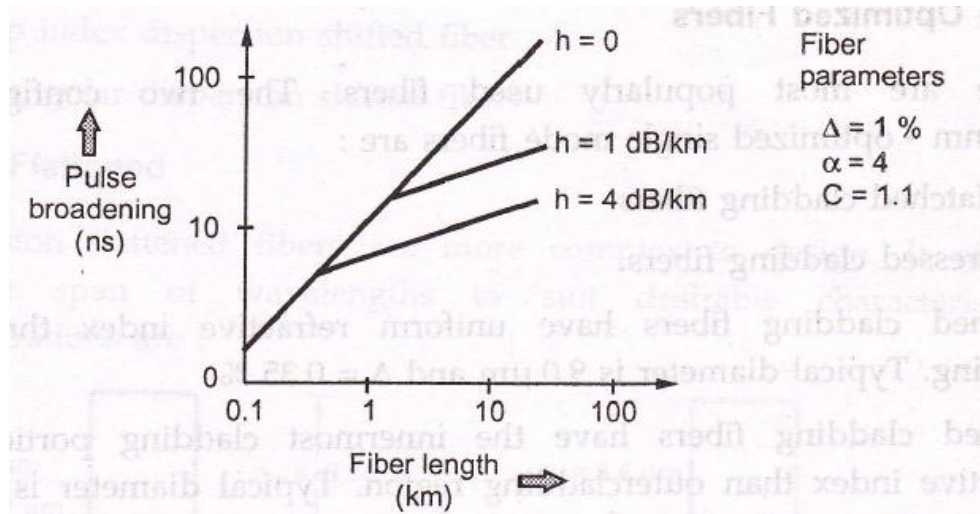

**Fig. 2.8.1 Mode coupling effects on pulse broadening**

- Significant mode coupling occurs of connectors, splices and with other passive components of an optical link.

## 2.9 Design Optimization

- Features of single mode fibers are :
  - Longer life.
  - Low attenuation.
  - Signal transfer quality is good.
  - Modal noise is absent.
  - Largest BW-distance product.
- Basic design – optimization includes the following :
  - Cut-off wavelength.
  - Dispersion.
  - Mode field diameter.
  - Bending loss.
  - Refractive index profile.

### Refractive Index Profile

- Dispersion of single mode silica fiber is lowest at 1300 nm while its attenuation is minimum at 1550 nm. For archiving maximum transmission distance the dispersion null should be at the wavelength of minimum attenuation. The waveguide dispersion is easier to control than the material dispersion. Therefore a variety of core-cladding refractive

index configuration fibers. Such as 1300 nm – optimized fibers, dispersion shifted fibers, dispersion – flattened fibers and large effective core area fibers.

### 1. 1300 nm – Optimized Fibers

- These are most popularly used fibers. The two configurations of 1300 nm – optimized single mode fibers are :
  - a) Matched cladding fibers.
  - b) Dressed cladding fibers.
- Matched cladding fibers have uniform refractive index throughout its cladding. Typical diameter is  $9.0\ \mu\text{m}$  and  $\Delta = 0.35\ \%$ .
- Dressed cladding fibers have the innermost cladding portion has low refractive index than outcladding region. Typical diameter is  $8.4\ \mu\text{m}$  and  $\Delta_1 = 0.25\ \%$ ,  $\Delta_2 = 0.12\ \%$ .

Fig 2.9.1 shows both types of fibers.

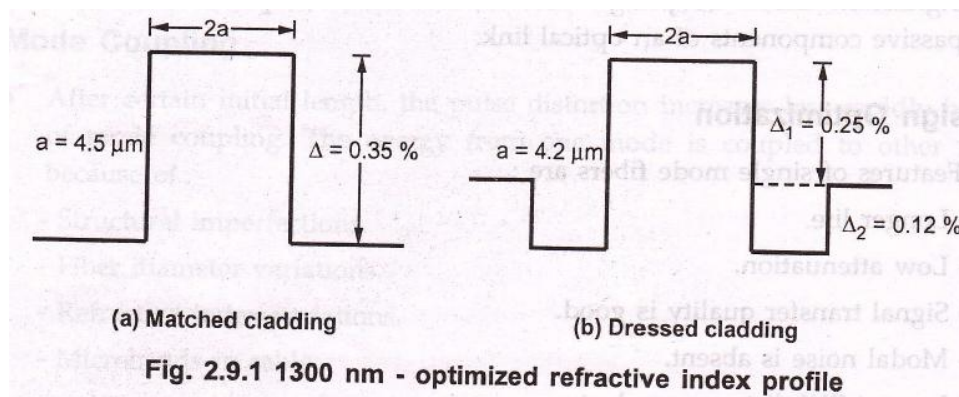

### 2. Dispersion Shifted Fibers

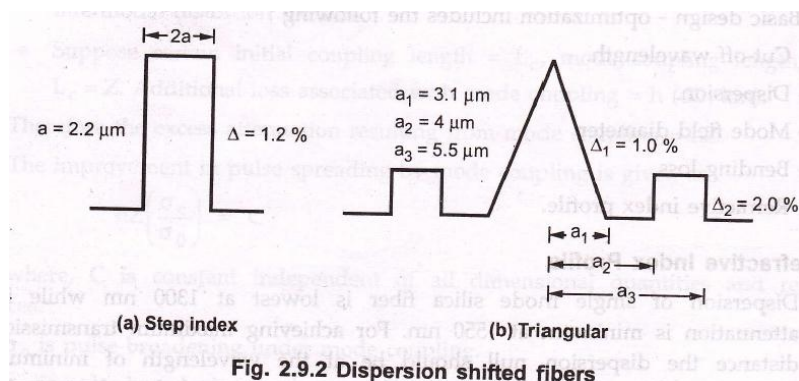

- The addition of wavelength and material dispersion can shift the zero dispersion point of longer wavelength. Two configurations of dispersion shifted fibers are :

- a) Step index dispersion shifted fiber.
- b) Triangular dispersion shifted fiber.

### 3. Dispersion Flattened

- Dispersion flattened fibers are more complex to design. It offers much broader span of wavelengths to suit desirable characteristics. Two configurations are :

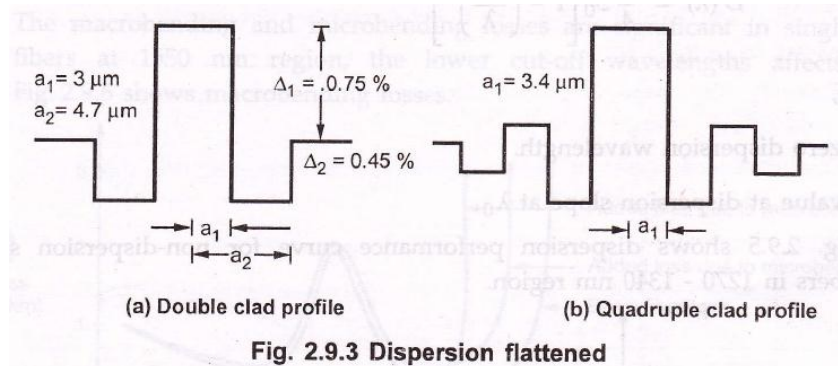

- Fig 2.9.4 shows total resultant dispersion.

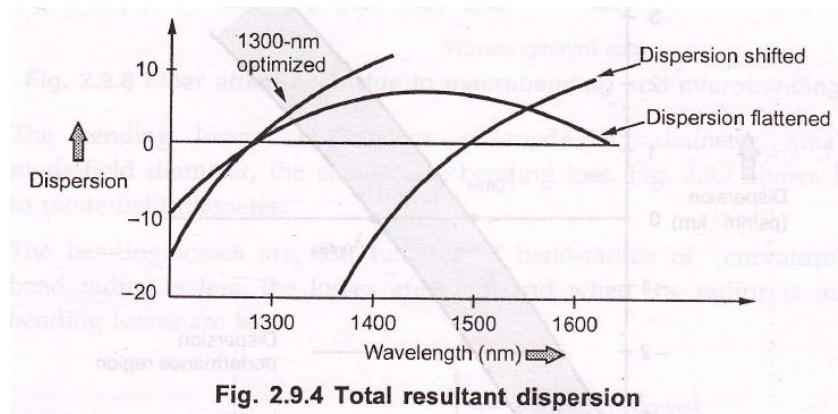

### Dispersion Calculations

- The total dispersion consists of material and waveguide dispersions. The resultant intermodal dispersion is given as,

$$D(\lambda) = \frac{d\tau}{d\lambda}$$

where,  $\tau$  is group delay per unit length of fiber.

- The broadening  $\sigma$  of an optical pulse is given as,

$$\sigma = D(\lambda) L \sigma_\lambda$$

where,  $\sigma_\lambda$  is half power spectral width of source.

- As the dispersion varies with wavelength and fiber type. Different formulae are used to calculate dispersions for variety of fiber at different wavelength.
- For a non – dispersion shifted fiber between 1270 nm to 1340 nm wavelength, the expression for dispersion is given as :

$$D(\lambda) = \frac{\lambda}{4} S_0 \left[ 1 - \left( \frac{\lambda_0}{\lambda} \right)^4 \right]$$

where,

$\lambda_0$  is zero dispersion wavelength.

$S_0$  is value at dispersion slop at  $\lambda_0$ .

- Fig 2.9.5 shows dispersion performance curve for non-dispersion shifted fibers in 1270 – 1340 nm region.

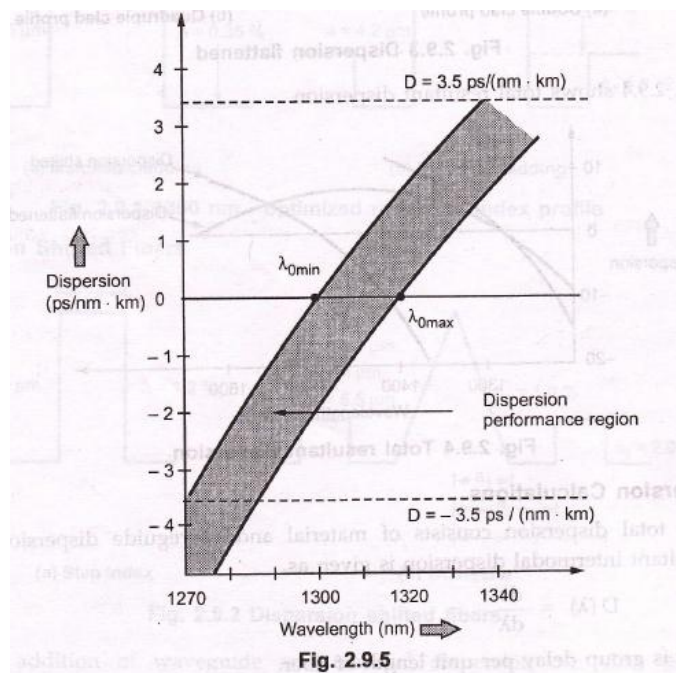

- Maximum dispersion specified as 3.5 ps/(nm . km) marked as dotted line in Fig. 2.9.5.

### Cut-off Frequency of an Optical Fiber

- The cut-off frequency of an optical fiber is determined not only by the fiber itself (modal dispersion in case of multimode fibers and waveguide dispersion in case of single mode fibers) but also by the amount of material dispersion caused by the spectral width of transmitter.

### Bending Loss Limitations

- The macrobending and microbending losses are significant in single mode fibers at 1550 nm region, the lower cut-off wavelengths affects more. Fig. 2.9.6 shows macrobending losses.

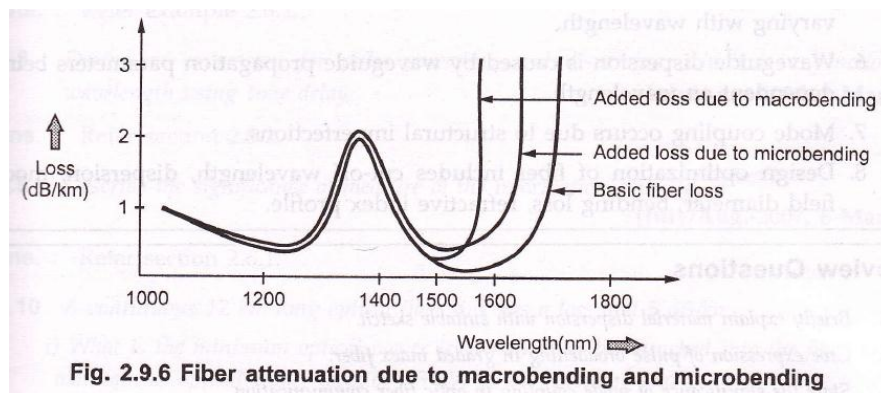

Fig. 2.9.6 Fiber attenuation due to macrobending and microbending

- The bending losses are function of mode-field diameter, smaller the mode-field diameter, the smaller the bending loss. Fig. 2.9.7 shows loss due to mode-field diameter.
- The bending losses are also function of bend-radius of curvature. If the bend radius is less, the losses are more and when the radius is more, the bending losses are less.

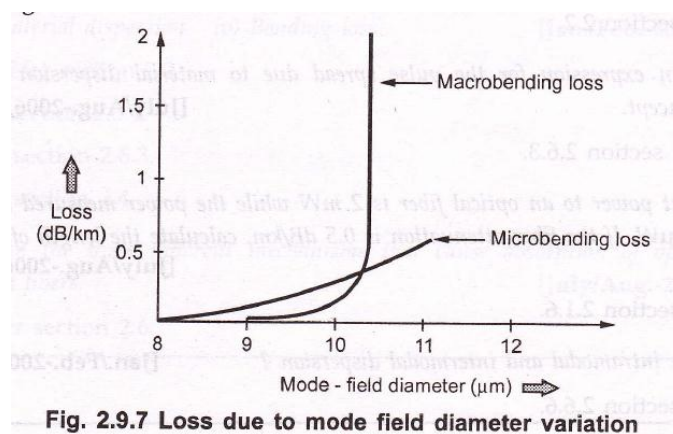

Fig. 2.9.7 Loss due to mode field diameter variation



**Recommended Questions:**

1. Briefly explain material dispersion with suitable sketch.
2. Give expression of pulse broadening in graded index fiber.
3. State the significance of mode coupling in optic fiber communication.
4. Explain in detail the design optimization of single mode fibers.
5. Elaborate dispersion mechanism in optical fibers.

## UNIT - 3

### OPTICAL SOURCES AND DETECTORS

Introduction, LED's, LASER diodes, Photo detectors, Photo detector noise, Response time, double hetero junction structure, Photo diodes, comparison of photo detectors.

**7 Hours**

#### RECOMMENDED READINGS:

#### TEXT BOOKS:

1. **Optical Fiber Communication** – Gerd Keiser, 4<sup>th</sup> Ed., MGH, 2008.
2. **Optical Fiber Communications** – John M. Senior, Pearson Education. 3<sup>rd</sup> Impression, 2007.

#### REFERENCE BOOK:

1. **Fiber optic communication** – Joseph C Palais: 4<sup>th</sup> Edition, Pearson Education.

### 3.1 Optical Sources

- Optical transmitter converts electrical input signal into corresponding optical signal. The optical signal is then launched into the fiber. Optical source is the major component in an optical transmitter.
- Popularly used optical transmitters are Light Emitting Diode (LED) and semiconductor Laser Diodes (LD).

#### Characteristics of Light Source of Communication

- To be useful in an optical link, a light source needs the following characteristics:
  - i) It must be possible to operate the device continuously at a variety of temperatures for many years.
  - ii) It must be possible to modulate the light output over a wide range of modulating frequencies.
  - iii) For fiber links, the wavelength of the output should coincide with one of transmission windows for the fiber type used.
  - iv) To couple large amount of power into an optical fiber, the emitting area should be small.
  - v) To reduce material dispersion in an optical fiber link, the output spectrum should be narrow.
  - vi) The power requirement for its operation must be low.
  - vii) The light source must be compatible with the modern solid state devices.
  - viii) The optical output power must be directly modulated by varying the input current to the device.
  - ix) Better linearity of prevent harmonics and intermodulation distortion.
  - x) High coupling efficiency.
  - xi) High optical output power.
  - xii) High reliability.
  - xiii) Low weight and low cost.

Two types of light sources used in fiber optics are light emitting diodes (LEDs) and laser diodes (LDs).

#### Light Emitting Diodes(LEDs)

##### p-n Junction

- Conventional p-n junction is called as **homojunction** as same semiconductor material is used on both sides junction. The electron-hole recombination occurs in relatively wide

layer = 10  $\mu\text{m}$ . As the carriers are not confined to the immediate vicinity of junction, hence high current densities can not be realized.

- The carrier confinement problem can be resolved by sandwiching a thin layer ( $= 0.1 \mu\text{m}$ ) between p-type and n-type layers. The middle layer may or may not be doped. The carrier confinement occurs due to bandgap discontinuity of the junction. Such a junction is call **heterojunction** and the device is called double **heterostructure**.
- In any optical communication system when the requirements is –
  - i) Bit rate f 100-2—Mb/sec.
  - ii) Optical power in tens of micro watts.
 LEDs are best suitable optical source.

## LED Structures

### Heterojunctions

- A heterojunction is an interface between two adjoining single crystal semiconductors with different bandgap.
- Heterojunctions are of two types, Isotype (n-n or p-p) or Antisotype (p-n).

### Double Heterojunctions (DH)

In order to achieve efficient confinement of emitted radiation double **heterojunctions** are used in LED structure. A heterojunction is a junction formed by dissimilar semiconductors. Double heterojunction (DH) is formed by two different semiconductors on each side of active region. Fig. 3.1.1 shows double heterojunction (DH) light emitter.

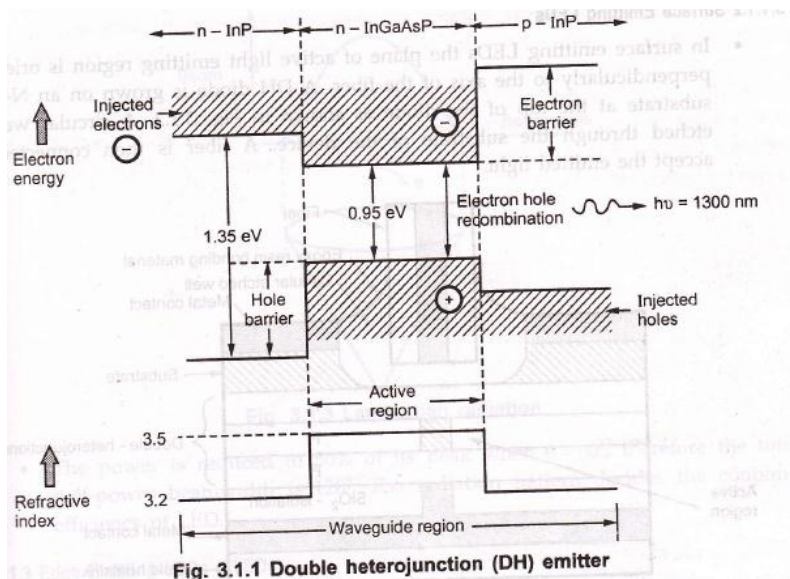

Fig. 3.1.1 Double heterojunction (DH) emitter

- The crosshatched regions represent the energy levels of freecharge. Recombination occurs only in active InGaAsP layer. The two materials have different bandgap energies and different refractive indices. The changes in bandgap energies create potential barrier for both holes and electrons. The free charges can recombine only in narrow, well defined active layer side.
- A double heterjunction (DH) structure will confine both hole and electrons to a narrow active layer. Under forward bias, there will be a large number of carriers injected into active region where they are efficiently confined. Carrier recombination occurs in small active region so leading to an efficient device. Another advantage DH structure is that the active region has a higher refractive index than the materials on either side, hence light emission occurs in an optical waveguide, which serves to narrow the output beam.

### LED configurations

- At present there are two main types of LED used in optical fiber links –
  1. Surface emitting LED.
  2. Edge emitting LED.
 Both devices used a DH structure to constrain the carriers and the light to an active layer.

### Surface Emitting LEDs

- In surface emitting LEDs the plane of active light emitting region is oriented perpendicularly to the axis of the fiber. A DH diode is grown on an N-type substrate at the top of the diode as shown in Fig. 3.1.2. A circular well is etched through the substrate of the device. A fiber is then connected to accept the emitted light.

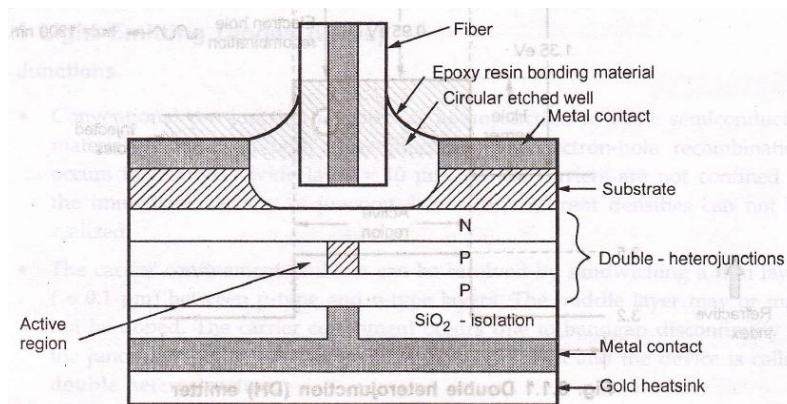
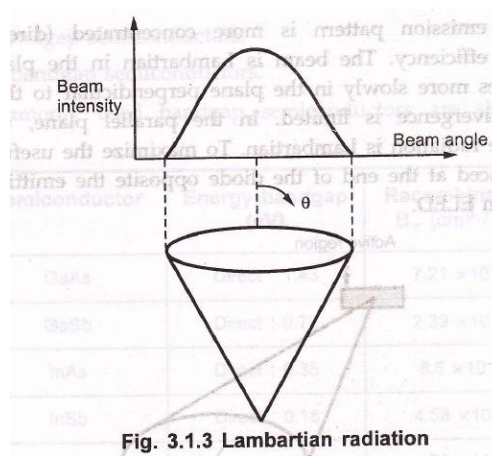

Fig. 3.1.2 Cross-section through a typical surface emitting LED

- At the back of device is a gold heat sink. The current flows through the p-type material and forms the small circular active region resulting in the intense beam of light.  
Diameter of circular active area =  $50\ \mu\text{m}$   
Thickness of circular active area =  $2.5\ \mu\text{m}$   
Current density =  $2000\ \text{A}/\text{cm}^2$  half-power  
Emission pattern = Isotropic,  $120^\circ$  beamwidth.
- The isotropic emission pattern from surface emitting LED is of Lambertian pattern. In Lambertian pattern, the emitting surface is uniformly bright, but its projected area diminishes as  $\cos \theta$ , where  $\theta$  is the angle between the viewing direction and the normal to the surface as shown in Fig. 3.1.3. The beam intensity is maximum along the normal.



- The power is reduced to 50% of its peak when  $\theta = 60^\circ$ , therefore the total half-power beamwidth is  $120^\circ$ . The radiation pattern decides the coupling efficiency of LED.

### Edge Emitting LEDs (ELEDs)

- In order to reduce the losses caused by absorption in the active layer and to make the beam more directional, the light is collected from the edge of the LED. Such a device is known as **edge emitting** LED or ELED.
- It consists of an active junction region which is the source of incoherent light and two guiding layers. The refractive index of guiding layers is lower than active region but higher than outer surrounding material. Thus a waveguide channel is formed and optical radiation is directed into the fiber. Fig. 3.1.4 shows structure of ELED.

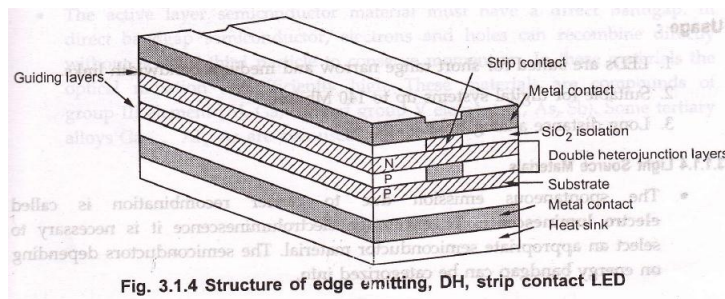

Fig. 3.1.4 Structure of edge emitting, DH, strip contact LED

Edge emitter's emission pattern is more concentrated (directional) providing improved coupling efficiency. The beam is Lambertian in the plane parallel to the junction but diverges more slowly in the plane perpendicular to the junction. In this plane, the beam divergence is limited. In the parallel plane, there is no beam confinement and the radiation is Lambertian. To maximize the useful output power, a reflector may be placed at the end of the diode opposite the emitting edge. Fig. 3.1.5 shows radiation from ELED.

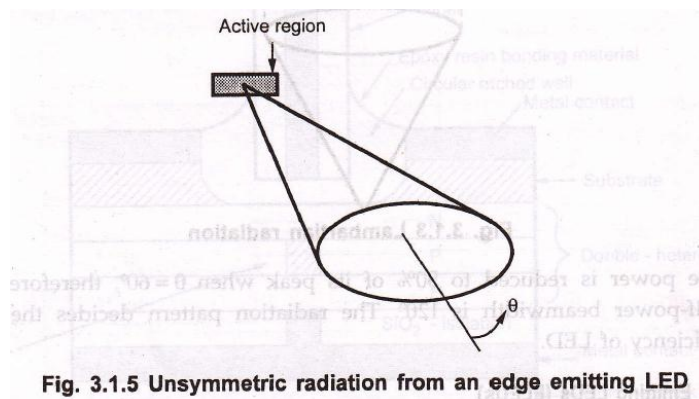

Fig. 3.1.5 Unsymmetric radiation from an edge emitting LED

### Features of ELED:

1. Linear relationship between optical output and current.
2. Spectral width is 25 to 400 nm for  $\lambda = 0.8 - 0.9 \mu\text{m}$ .
3. Modulation bandwidth is much large.
4. Not affected by catastrophic gradation mechanisms hence are more reliable.
5. ELEDs have better coupling efficiency than surface emitter.
6. ELEDs are temperature sensitive.

### Usage :

1. LEDs are suited for short range narrow and medium bandwidth links.
2. Suitable for digital systems up to 140 Mb/sec.
3. Long distance analog links.

### Light Source Materials

- The spontaneous emission due to carrier recombination is called **electro luminescence**. To encourage electroluminescence it is necessary to select as appropriate semiconductor material. The semiconductors depending on energy bandgap can be categorized into,
  - Direct bandgap semiconductors.
  - Indirect bandgap semiconductors.
- Some commonly used bandgap semiconductors are shown in following table 3.1.1

Semiconductor	Energy bandgap (eV)	Recombination $B_r$ ( $\text{cm}^3 / \text{sec}$ )
GaAs	Direct : 1.43	$7.21 \times 10^{-10}$
GaSb	Direct : 0.73	$2.39 \times 10^{-10}$
InAs	Direct : 0.35	$8.5 \times 10^{-11}$
InSb	Direct : 0.18	$4.58 \times 10^{-11}$
Si	Indirect : 1.12	$1.79 \times 10^{-15}$
Ge	Indirect : 0.67	$5.25 \times 10^{-14}$
GaP	Indirect : 2.26	$5.37 \times 10^{-14}$

**Table 3.1.1 Semiconductor material for optical sources**

- Direct bandgap semiconductors are most useful for this purpose. In direct bandgap semiconductors the electrons and holes on either side of bandgap have same value of crystal momentum. Hence direct recombination is possible. The recombination occurs within  $10^{-8}$  to  $10^{-10}$  sec.
- In indirect bandgap semiconductors, the maximum and minimum energies occur at different values of crystal momentum. The recombination in these semiconductors is quite slow i.e.  $10^{-2}$  and  $10^{-3}$  sec.
- The active layer semiconductor material must have a **direct bandgap**. In direct bandgap semiconductor, electrons and holes can recombine directly without need of third particle to conserve momentum. In these materials the optical radiation is sufficiently high. These



materials are compounds of group III elements (Al, Ga, In) and group V element (P, As, Sb). Some tertiary alloys  $Ga_{1-x}Al_xAs$  are also used.

- Emission spectrum of  $Ga_{1-x}Al_xAs$  LED is shown in Fig. 3.1.6.

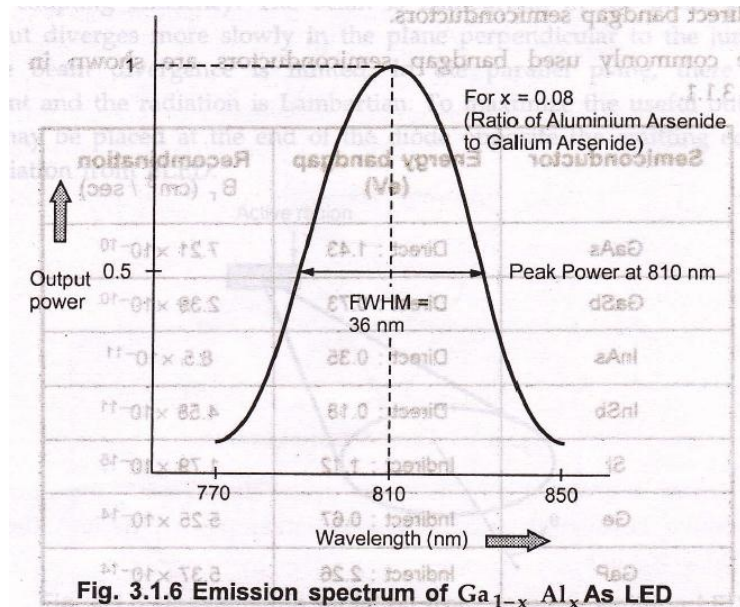

- The peak output power is obtained at 810 nm. The width of emission spectrum at half power (0.5) is referred as full width half maximum (FWHM) spectral width. For the given LED FWHM is 36 nm.
- The fundamental quantum mechanical relationship between gap energy  $E$  and frequency  $\nu$  is given as –

$$E = h\nu$$

$$E = h \frac{c}{\lambda}$$

$$\Rightarrow \lambda = \frac{hc}{E}$$

where, energy ( $E$ ) is in joules and wavelength ( $\lambda$ ) is in meters. Expressing the gap energy ( $E_g$ ) in electron volts and wavelength ( $\lambda$ ) in micrometers for this application.

$$\lambda(\mu\text{m}) = \frac{1.24}{E_g(\text{eV})}$$

Different materials and alloys have different bandgap energies.

- The bandgap energy ( $E_g$ ) can be controlled by two compositional parameters  $x$  and  $y$ , within direct bandgap region. The quaternary alloy  $\text{In}_{1-x} \text{Ga}_x \text{As}_y \text{P}_{1-y}$  is the principal material used in such LEDs. Two expressions relating  $E_g$  and  $x, y$  are –

$$E_g = 1.424 + 1.266 x + 0.266 x^2 \quad \dots 3.1.3$$

$$E_g = 1.35 - 0.72 y + 0.12 y^2 \quad \dots 3.1.4$$

**Example 3.1.1 :** Compute the emitted wavelength from an optical source having  $x = 0.07$ .

**Solution :**  $x = 0.07$

$$E_g = 1.424 + 1.266 x + 0.266 x^2$$

$$E_g = 1.424 + (1.266 \times 0.07) + 0.266 \times (0.07)^2$$

$$E_g = 1.513 \text{ eV}$$

Now

$$\lambda = \frac{1.24}{E_g}$$

$$\lambda = \frac{1.24}{1.513}$$

$$\lambda = 0.819 \mu\text{m}$$

$$\lambda = 0.82 \mu\text{m}$$

...Ans.

**Example 3.1.2 :** For an alloy  $\text{In}_{0.74} \text{Ga}_{0.26} \text{As}_{0.57} \text{P}_{0.43}$  to be used in LED. Find the wavelength emitted by this source.

**Solution :** Comparing the alloy with the quaternary alloy composition.

$\text{In}_{1-x} \text{Ga}_x \text{As}_y \text{P}_{1-y}$  it is found that

$$x = 0.26 \text{ and}$$

$$y = 0.57$$

$$E_g = 1.35 - 0.72 y + 0.12 y^2$$

Using

$$E_g = 1.35 - (0.72 \times 0.57) + 0.12 \times 0.57^2$$

$$E_g = 0.978 \text{ eV}$$

Now

$$\lambda = \frac{1.24}{E_g}$$

$$\lambda = \frac{1.24}{0.978}$$

$$\lambda = 1.2671 \text{ } \mu\text{m}$$

$$\lambda = 1.27 \text{ } \mu\text{m}$$

... Ans.

### Quantum Efficiency and Power

- The internal quantum efficiency ( $\eta_{int}$ ) is defined as the ratio of radiative recombination rate to the total recombination rate.

$$\eta_{int} = \frac{R_r}{R_r + R_{nr}}$$

... 3.1.5

Where,

$R_r$  is radiative recombination rate.

$R_{nr}$  is non-radiative recombination rate.

If  $n$  are the excess carriers, then radiative life time,  $\tau_r = \frac{n}{R_r}$  and

non-radiative life time,  $\tau_{nr} = \frac{n}{R_{nr}}$

- The internal quantum efficiency is given as –

$$\eta_{int} = \frac{1}{1 + \frac{R_{nr}}{R_r}}$$

$$\eta_{int} = \frac{1}{1 + \frac{\tau_r}{\tau_{nr}}} \quad \dots 3.1.6$$

- The recombination time of carriers in active region is  $\tau$ . It is also known as bulk recombination life time.

$$\boxed{\frac{1}{\tau} = \frac{1}{\tau_r} + \frac{1}{\tau_{nr}}} \quad \dots 3.1.7$$

Therefore internal quantum efficiency is given as –

$$\boxed{\eta_{int} = \frac{\tau}{\tau_r}} \quad \dots 3.1.8$$

- If the current injected into the LED is  $I$  and  $q$  is electron charge then total number of recombinations per second is –

$$R_r = R_{nr} = \frac{I}{q} \quad \text{From equation 3.1.5}$$

$$\eta_{int} = \frac{R_r}{I/q}$$

$$\therefore R_r = \eta_{int} \times \frac{I}{q} \quad \dots 3.1.9$$

- Optical power generated internally in LED is given as –

$$P_{int} = R_r \cdot h \nu$$

$$P_{int} = \left( \eta_{int} \times \frac{I}{q} \right) \cdot h \nu$$

$$P_{int} = \left( \eta_{int} \times \frac{I}{q} \right) \cdot h \frac{c}{\lambda}$$

$$\therefore \boxed{P_{int} = \eta_{int} \cdot \frac{hc I}{q\lambda}} \quad \dots 3.1.10$$

- Not all internally generated photons will available from output of device. The external quantum efficiency is used to calculate the emitted power. The external quantum

efficiency is defined as the ratio of photons emitted from LED to the number of photons generated internally. It is given by equation

$$\eta_{\text{ext}} = \frac{1}{n(n+1)^2} \quad \dots 3.1.11$$

- The optical output power emitted from LED is given as –

$$P = \eta_{\text{ext}} \cdot P_{\text{int}}$$

$$P = \frac{1}{n(n+1)^2} \cdot P_{\text{int}}$$

**Example 3.1.3 :** The radiative and non radiative recombination life times of minority carriers in the active region of a double heterojunction LED are 60 nsec and 90 nsec respectively. Determine the total carrier recombination life time and optical power generated internally if the peak emission wavelength is 870 nm and the drive current is 40 mA. [July/Aug.-2006, 6 Marks]

**Solutions : Given :**  $\lambda = 870 \text{ nm} = 0.87 \times 10^{-6} \text{ m}$

$$\tau_r = 60 \text{ nsec.}$$

$$\tau_{nr} = 90 \text{ nsec.}$$

$$I = 40 \text{ mA} = 0.04 \text{ Amp.}$$

- i) Total carrier recombination life time:

$$\frac{1}{\tau} = \frac{1}{\tau_r} + \frac{1}{\tau_{nr}}$$

$$\frac{1}{\tau} = \frac{1}{60} + \frac{1}{90}$$

$$\frac{1}{\tau} = \frac{150}{5400}$$

$$\therefore \tau = 36 \text{ nsec.}$$

... Ans.

- ii) Internal optical power:

$$P_{\text{int}} = \eta_{\text{int}} \cdot \frac{hc I}{q\lambda}$$

$$P_{\text{int}} = \left(\frac{\tau}{\tau_r}\right) \left(\frac{hc I}{q\lambda}\right)$$

$$P_{\text{int}} = \left(\frac{30}{60}\right) \left[\frac{(6.625 \times 10^{-34})(3 \times 10^8) \times 0.04}{(1.602 \times 10^{-19})(0.87 \times 10^{-6})}\right]$$

$$P_{\text{int}} = 34.22 \text{ mW}$$

... Ans.

**Example 3.1.4 :** A double heterojunction InGaAsP LED operating at 1310 nm has radiative and non-radiative recombination times of 30 and 100 ns respectively. The current injected is 40 Ma. Calculate –

- Bulk recombination life time.
- Internal quantum efficiency.
- Internal power level.

**Solution :**  $\lambda = 1310 \text{ nm} = (1.31 \times 10^{-6} \text{ m})$

$$\tau_r = 30 \text{ ns}$$

$$\tau_{\text{nr}} = 100 \text{ ns}$$

$$I = 40 \text{ MA} - 0.04 \text{ Amp.}$$

**i) Bulk Recombination Life time ( $\tau$ ) :**

$$\frac{1}{\tau} = \frac{1}{\tau_r} + \frac{1}{\tau_{\text{nr}}}$$

$$\frac{1}{\tau} = \frac{1}{30} + \frac{1}{100}$$

$$\therefore \tau = 23.07 \text{ nsec.}$$

... Ans.

**ii) Internal euqntum efficiency ( $\eta_{\text{int}}$ ) :**

$$\eta_{\text{int}} = \frac{\tau}{\tau_r}$$

$$\eta_{int} = \frac{23.07}{30}$$

$$\eta_{int} = 0.769$$

... Ans.

iii) Internal power level ( $P_{int}$ ):

$$P_{int} = \eta_{int} \cdot \frac{hc I}{q\lambda}$$

$$P_{int} = 0.769 \times \frac{(6.625 \times 10^{-34})(3 \times 10^8) \times 0.04}{(1.602 \times 10^{-19})(0.87 \times 10^{-6})}$$

$$P_{int} = 2.913 \text{ mW}$$

... Ans.

### Advantages and Disadvantages of LED

#### Advantages of LED

1. Simple design.
2. Ease of manufacture.
3. Simple system integration.
4. Low cost.
5. High reliability.

#### Disadvantages of LED

1. Refraction of light at semiconductor/air interface.
2. The average life time of a radiative recombination is only a few nanoseconds, therefore modulation BW is limited to only few hundred megahertz.
3. Low coupling efficiency.
4. Large chromatic dispersion.

### Comparison of Surface and Edge Emitting LED

LED type	Maximum modulation frequency (MHz)	Output power (mW)	Fiber coupled power (mW)
Surface emitting	60	< 4	< 0.2
Edge emitting	200	< 7	< 1.0

## Injection Laser Diode (ILD)

- The laser is a device which amplifies the light, hence the LASER is an acronym for light amplification by stimulated emission of radiation.

The operation of the device may be described by the formation of an electromagnetic standing wave within a cavity (optical resonator) which provides an output of monochromatic highly coherent radiation.

### Principle :

- Material absorb light than emitting. Three different fundamental process occurs between the two energy states of an atom.

1) Absorption 2) Spontaneous emission 3) Stimulated emission.

- Laser action is the result of three process absorption of energy packets (photons) spontaneous emission, and stimulated emission. (These processes are represented by the simple two-energy-level diagrams).

Where  $E_1$  is the lower state energy level.

$E_2$  is the higher state energy level.

- Quantum theory states that any atom exists only in certain discrete energy state, absorption or emission of light causes them to make a transition from one state to another. The frequency of the absorbed or emitted radiation  $f$  is related to the difference in energy  $E$  between the two states.

If  $E_1$  is lower state energy level.

and  $E_2$  is higher state energy level.

$$E = (E_2 - E_1) = h.f.$$

Where,  $h = 6.626 \times 10^{-34}$  J/s (Plank's constant).

- An atom is initially in the lower energy state, when the photon with energy  $(E_2 - E_1)$  is incident on the atom it will be excited into the higher energy state  $E_2$  through the absorption of the photon.

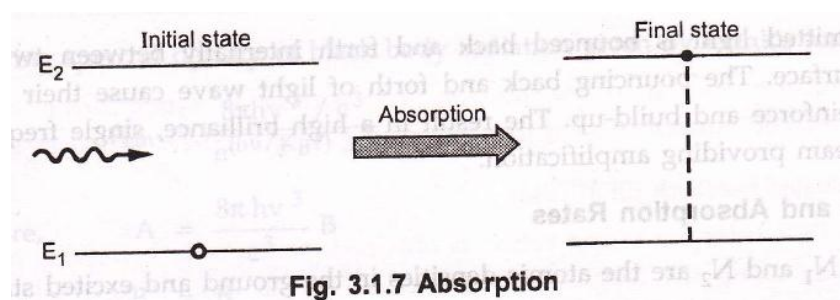

Fig. 3.1.7 Absorption



- When the atom is initially in the higher energy state  $E_2$ , it can make a transition to the lower energy state  $E_1$  providing the emission of a photon at a frequency corresponding to  $E = h.f$ . The emission process can occur in two ways.
  - A) By spontaneous emission in which the atom returns to the lower energy state in random manner.
  - B) By stimulated emission when a photon having equal energy to the difference between the two states ( $E_2 - E_1$ ) interacts with the atom causing it to the lower state with the creation of the second photon.

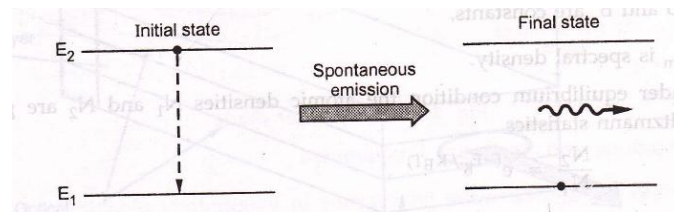

Fig. 3.1.8 Spontaneous emission

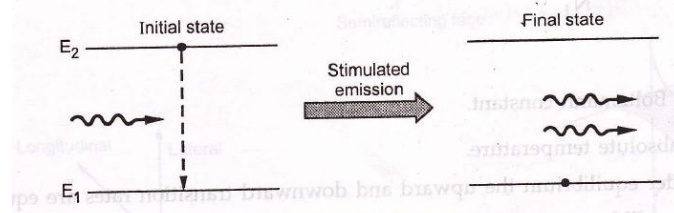

Fig. 3.1.9 Stimulated emission

- Spontaneous emission gives incoherent radiation while stimulated emission gives coherent radiation. Hence the light associated with emitted photon is of same frequency of incident photon, and in same phase with same polarization.
- It means that when an atom is stimulated to emit light energy by an incident wave, the liberated energy can add to the wave in constructive manner. The emitted light is bounced back and forth internally between two reflecting surface. The bouncing back and forth of light wave cause their intensity to reinforce and build-up. The result in a high brilliance, single frequency light beam providing amplification.

### Emission and Absorption Rates

- If  $N_1$  and  $N_2$  are the atomic densities in the ground and excited states.

#### Rate of spontaneous emission

$$R_{\text{spont}} = AN_2 \quad \dots 3.1.13$$

#### Rate of stimulated emission

$$R_{\text{stim}} = BN_2 \rho_{\text{em}} \quad \dots 3.1.14$$

### Rate of absorption

$$R_{\text{abs}} = B' N_1 \rho_{\text{em}} \quad \dots 3.1.15$$

where,

A, B and B' are constants.

$\rho_{\text{em}}$  is spectral density.

- Under equilibrium condition the atomic densities  $N_1$  and  $N_2$  are given by Boltzmann statistics.

$$\frac{N_2}{N_1} = e^{\frac{-E_B}{K_B T}} \quad \dots 3.1.16$$

$$\frac{N_2}{N_1} = e^{\frac{-h\nu}{K_B T}} \quad \dots 3.1.17$$

where,

$K_B$  is Boltzmann constant.

T is absolute temperature.

- Under equilibrium the upward and downward transition rates are equal.

$$AN_2 + BN_2 \rho_{\text{em}} = B' N_1 \rho_{\text{em}} \quad \dots 3.1.18$$

Spectral density  $\rho_{\text{em}}$

$$\rho_{\text{em}} = \frac{A/B}{(B'/B)[e^{h\nu/K_B T} - 1]} \quad \dots 3.1.19$$

Comparing spectral density of black body radiation given by Plank's formula,

$$\rho_{\text{em}} = \frac{8\pi h\nu^3 / c^3}{e^{(h\nu/K_B T)} - 1} \quad \dots 3.1.20$$

Therefore, 
$$A = \frac{8\pi h\nu^3}{c^3} B \quad \dots 3.1.21$$

$$B' = B \quad \dots 3.1.22$$

- A and B are called Einstein's coefficient.

### Fabry – Perot Resonator

- Lasers are oscillators operating at frequency. The oscillator is formed by a resonant cavity providing a selective feedback. The cavity is normally a Fabry-Perot resonator i.e. two parallel plane mirrors separated by distance  $L$ ,

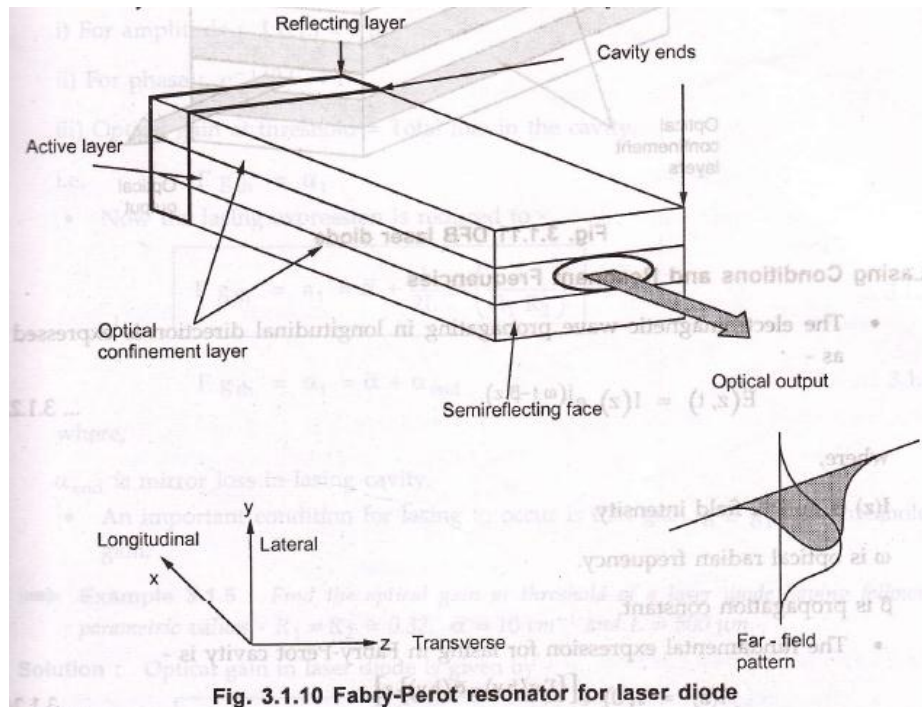

Light propagating along the axis of the interferometer is reflected by the mirrors back to the amplifying medium providing optical gain. The dimensions of cavity are 25-500  $\mu\text{m}$  longitudinal 5-15  $\mu\text{m}$  lateral and 0.1-0.2  $\mu\text{m}$  transverse. Fig. 3.1.10 shows Fabry-Perot resonator cavity for a laser diode.

- The two heterojunctions provide carrier and optical confinement in a direction normal to the junction. The current at which lasing starts is the threshold current. Above this current the output power increases sharply.

### Distributed Feedback (DFB) Laser

- In DFB laser the lasing action is obtained by periodic variations of refractive index along the longitudinal dimension of the diode. Fig. 3.1.11 shows the structure of DFB laser diode.

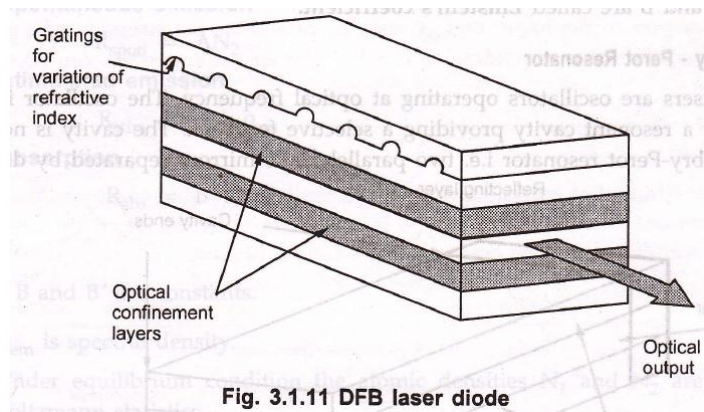

Fig. 3.1.11 DFB laser diode

### Lasing conditions and resonant Frequencies

- The electromagnetic wave propagating in longitudinal direction is expressed as –

$$E(z, t) = I(z) e^{j(\omega t - \beta z)} \quad \dots 3.1.23$$

where,

$I(z)$  is optical field intensity.

$\omega$  is optical radian frequency.

$\beta$  is propagation constant.

- The fundamental expression for lasing in Fabry-Perot cavity is –

$$I(z) = I(0) e^{[\Gamma g(h\nu) - \alpha(h\nu)]z} \quad \dots 3.1.24$$

where,

$\Gamma$  is optical field confinement factor or the fraction of optical power in the active layer.

$\alpha$  is effective absorption coefficient of material.

$g$  is gain coefficient.

$h\nu$  is photon energy.

$z$  is distance traverses along the lasing cavity.

- Lasing (light amplification) occurs when gain of modes exceeds above optical loss during one round trip through the cavity i.e.  $z = 2L$ . If  $R_1$  and  $R_2$  are the mirror reflectivities of the two ends of laser diode. Now the expression for lasing expressing is modified as,

$$I(2L) = I(0)e^{[2L\{\Gamma g(h\nu) - \alpha(h\nu)\}]} \quad \dots 3.1.25$$

The condition of lasing threshold is given as –

- i) For amplitude :  $I(2L) = I(0)$
- ii) For phase :  $e^{-j^{2\beta}L} = 1$
- iii) Optical gain at threshold = Total loss in the cavity.

i.e.  $\Gamma g_{th} = \alpha_t$

- Now the lasing expression is reduced to –

$$\Gamma g_{th} = \alpha_t = \alpha + \frac{1}{2L} \ln\left(\frac{1}{R_1 R_2}\right) \quad \dots 3.1.26$$

$$\Gamma g_{th} = \alpha_t = \alpha + \alpha_{end} \quad \dots 3.1.27$$

where,

$\alpha_{end}$  is mirror loss in lasing cavity.

- An important condition for lasing to occur is that gain,  $g \geq g_{th}$  i.e. threshold gain.

**Example 3.1.5 :** Find the optical gain at threshold of a laser diode having following parametric values –  $R_1 = R_2 = 0.32$ ,  $\alpha = 10\text{cm}^{-1}$  and  $L = 500 \mu\text{m}$ .

Solution : Optical gain in laser diode is given by –

$$\Gamma g_{th} = \alpha + \frac{1}{2L} \ln\left(\frac{1}{R_1 R_2}\right)$$

$$\Gamma g_{th} = 10 + \frac{1}{2 \times (500 \times 10^{-4})} \ln\left(\frac{1}{0.32 \times 0.32}\right)$$

$$\Gamma g_{th} = 33.7 \text{ cm}^{-1} \quad \dots \text{Ans.}$$

### Power Current Characteristics

- The output optic power versus forward input current characteristics is plotted in Fig. 3.1.12 for a typical laser diode. Below the threshold current ( $I_{th}$ ) only spontaneous emission is emitted hence there is small increase in optic power with drive current. At

threshold when lasing conditions are satisfied. The optical power increases sharply after the lasing threshold because of stimulated emission.

- The lasing threshold optical gain ( $g_{th}$ ) is related by threshold current density ( $J_{th}$ ) for stimulated emission by expression –

$$g_{th} = \beta J_{th} \quad \dots 3.1.28$$

where,  $\beta$  is constant for device structure.

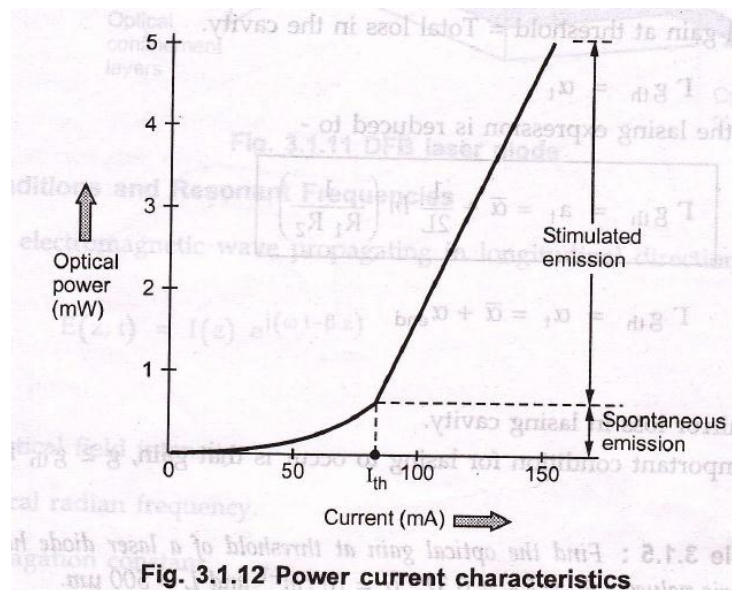

**Fig. 3.1.12 Power current characteristics**

### External Quantum Efficiency

- The external quantum efficiency is defined as the number of photons emitted per electron hole pair recombination above threshold point. The external quantum efficiency  $\eta_{ext}$  is given by –

$$\eta_{ext} = \frac{\eta_i (g_{th} - \alpha)}{g_{th}} \quad \dots 3.1.29$$

where,

$\eta_i$  = Internal quantum efficiency (0.6-0.7).

$g_{th}$  = Threshold gain.

$\alpha$  = Absorption coefficient.

- Typical value of  $\eta_{\text{ext}}$  for standard semiconductor laser is ranging between 15-20 %.

### Resonant Frequencies

- At threshold lasing

$$2\beta L = 2\pi m$$

where,  $\beta = \frac{2\pi m}{\lambda}$  (propagation constant)

m is an integer.

$$\therefore m = 2L \cdot \frac{n}{\lambda} \quad \dots 3.1.30$$

Since  $c = v\lambda$

$$\therefore \lambda = \frac{c}{v}$$

Substituting  $\lambda$  in 3.1.30

$$m = 2L \frac{nv}{c} \quad \dots 3.1.31$$

- Gain in any laser is a function of frequency. For a Gaussian output the gain and frequency are related by expression –

$$g(\lambda) = g(0)e^{\left[-\frac{(\lambda-\lambda_0)^2}{2\sigma^2}\right]} \quad \dots 3.1.32$$

where,

$g(0)$  is maximum gain.

$\lambda_0$  is center wavelength in spectrum.

$\sigma$  is spectral width of the gain.

- The frequency spacing between the two successive modes is –

$$\Delta v = \frac{c}{2Ln} \quad \dots 3.1.33$$

The wavelength Spacing is given as –

$$\Delta \lambda = \frac{\lambda^2}{2 L n}$$

... 3.1.34

### Optical Characteristics of LED and Laser

- The output of laser diode depends on the drive current passing through it. At low drive current, the laser operates as an inefficient LED, When drive current crosses threshold value, lasing action begins. Fig. 3.1.13 illustrates graph comparing optical powers of LED operation (due to spontaneous emission) and laser operation (due to stimulated emission).

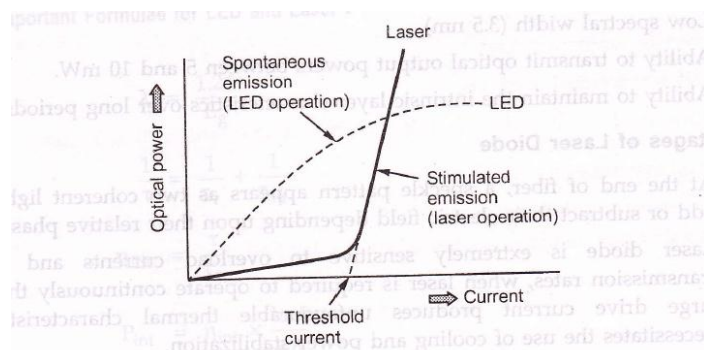

Fig. 3.1.13 Optical characteristics of an LED and laser compared

### Spectral and Spatial Distribution of Led and Laser

- At low current laser diode acts like normal LED above threshold current, stimulated emission i.e. narrowing of light ray to a few spectral lines instead of broad spectral distribution, exist. This enables the laser to easily couple to single mode fiber and reduces the amount of uncoupled light (i.e. spatial radiation distribution). Fig. 3.1.14 shows spectral and spatial distribution difference between two diodes.

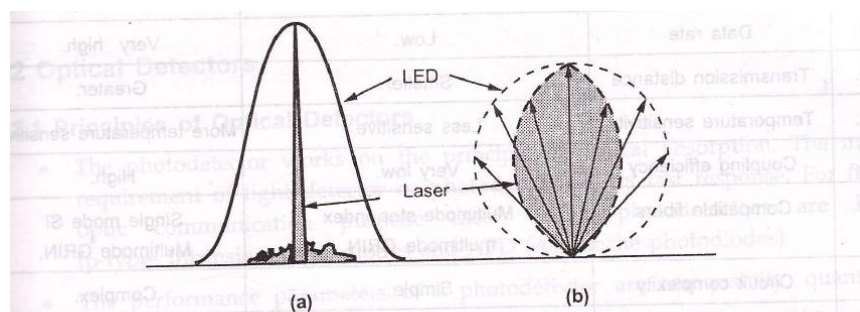

Fig. 3.1.14 Comparing (a) spectral and (b) spatial distribution of laser diodes



## Advantages and Disadvantages of Laser Diode

### Advantages of Laser Diode

1. Simple economic design.
2. High optical power.
3. Production of light can be precisely controlled.
4. Can be used at high temperatures.
5. Better modulation capability.
6. High coupling efficiency.
7. Low spectral width (3.5 nm)
8. Ability to transmit optical output powers between 5 and 10 mW.
9. Ability to maintain the intrinsic layer characteristics over long periods.

### Disadvantages of Laser Diode

1. At the end of fiber, a speckle pattern appears as two coherent light beams add or subtract their electric field depending upon their relative phases.
2. Laser diode is extremely sensitive to overload currents and at high transmission rates, when laser is required to operate continuously the use of large drive current produces unfavourable thermal characteristics and necessitates the use of cooling and power stabilization.

### Comparison of LED and Laser Diode

Sr. No.	Parameter	LED	LD (Laser Diode)
1.	Principle of operation	Spontaneous emission.	Stimulated emission.
2.	Output beam	Non – coherent.	Coherent.
3.	Spectral width	Broad spectrum (20 nm – 100 nm)	Much narrower (1-5 nm).
4.	Data rate	Low.	Very high.
5.	Transmission distance	Smaller.	Greater.
6.	Temperature sensitivity	Less sensitive.	More temperature sensitive.
7.	Coupling efficiency	Very low.	High.

8.	Compatible fibers	Multimode step index multimode GRIN.	Single mode SI Multimode GRIN.
9.	Circuit complexity	Simple	Complex
10.	Life time	$10^5$ hours.	$10^4$ hours.
11.	Cost	Low.	High.
12.	Output power	Linearly proportional to drive current.	Proportional to current above threshold.
13.	Current required	Drive current 50 to 100 mA peak.	Threshold current 5 to 40 mA.
14.	Wavelengths available	0.66 to 1.65 $\mu\text{m}$ .	0.78 to 1.65 $\mu\text{m}$ .
15.	Applications	Moderate distance low data rate.	Long distance high data rates.

### Important Formulae for LED and Laser

#### LED

- $\lambda = \frac{1.24}{E_g}$
- $\frac{1}{\tau} = \frac{1}{\tau_r} + \frac{1}{\tau_{nr}}$
- $\eta_{int} = \frac{\tau}{\tau_r}$
- $P_{int} = \eta_{int} \times \frac{hcI}{q\lambda}$

#### LASER

- $\Gamma g_{th} = \alpha + \frac{1}{2L} \ln \left( \frac{1}{R_1 R_2} \right)$
- $\Delta v = \frac{c}{2Ln}$
- $\Delta \lambda = \frac{\lambda^2}{2Ln}$

## 3.2 Optical Detectors

### Principles of Optical Detectors

- The photodetector works on the principle of optical absorption. The main requirement of light detector or photodetector is its fast response. For fiber optic communication purpose most suited photodetectors are PIN (p-type- Intrinsic-n-type) diodes and APD (Avalanche photodiodes)
- The performance parameters of a photodetector are responsivity, quantum efficiency, response time and dark current.

### Cut-off Wavelength ( $\lambda_c$ )

- Any particular semiconductor can absorb photon over a limited wavelength range. The highest wavelength is known as cut-off wavelength ( $\lambda_c$ ). The cut-off wavelength is determined by bandgap energy  $E_g$  of material.

$$\lambda_c = \frac{hc}{E_g} = \frac{1.24}{E_g}$$

... 3.2.1

where,

$E_g$  in electron volts (eV) and

$\lambda_c$  cut-off wavelength is in  $\mu\text{m}$ .

Typical value of  $\lambda_c$  for silicon is 1.06  $\mu\text{m}$  and for germanium it is 1.6  $\mu\text{m}$ .

### Quantum Efficiency ( $\eta$ )

- The quantum efficiency is define as the number of electron-hole carrier pair generated per incident photon of energy  $h\nu$  and is given as –

$$\eta = \frac{\text{Number of electron hole pairs generated}}{\text{Number of incident photons}}$$

$$\eta = \frac{I_p / q}{P_{in} / h\nu}$$

... 3.2.2

where,  $I_p$  is average photocurrent.

$P_{in}$  is average optical power incident on photodetector.

- Absorption coefficient of material determines the quantum efficiency. Quantum efficiency  $\eta < 1$  as all the photons incident will not generate e-h pairs. It is normally expressed in percentage.

### Detector Responsivity ( $\mathfrak{R}$ )

- The responsivity of a photodetector is the ratio of the current output in amperes to the incident optical power in watts. Responsivity is denoted by  $\mathfrak{R}$ .

$$\mathfrak{R} = \frac{I_p}{P_{in}} \quad \dots 3.2.3$$

But 
$$\eta = \frac{I_p - q}{P_{in} - h\nu} = \frac{I_p}{q} \frac{h\nu}{P_{in}}$$

$\therefore \frac{I_p}{P_{in}} = \frac{\eta q}{h\nu} \quad \dots 3.2.4$

Therefore 
$$\mathfrak{R} = \frac{\eta q}{h\nu} = \frac{\eta q \lambda}{h\nu} \quad \dots 3.2.5$$

$$\therefore \nu = \frac{c}{\lambda}$$

- Responsivity gives transfer characteristics of detector i.e. photo current per unit incident optical power.
- Typical responsivities of pin photodiodes are –  
Silicon pin photodiode at 900 nm  $\rightarrow$  0.65 A/W.  
Germanium pin photodiode at 1.3  $\mu$ m  $\rightarrow$  0.45 A/W.  
In GaAs pin photodiode at 1.3  $\mu$ m  $\rightarrow$  0.9 A/W.

$$\eta = \frac{5.4 \times 10^6}{6 \times 10^6}$$

$$\eta = 0.9 = 90 \% \quad \dots \text{Ans.}$$

- r photodetectors are sued. As the intensity of optical signal at the receiver is very low, the detector has to meet high performance specifications.
  - The conversion efficiency must be high at the operating wavelength.
  - The speed of response must be high enough to ensure that signal distortion does not occur.

- The detection process introduce the minimum amount of noise.
- It must be possible to operate continuously over a wide range of temperatures for many years.
- The detector size must be compatible with the fiber dimensions.
- At present, these requirements are met by reverse biased p-n photodiodes. In these devices, the semiconductor material absorbs a photon of light, which excites an electron from the valence band to the conduction band (opposite of photon emission). The photo generated electron leaves behind it a hole, and so each photon generates two charge carriers. The increases the material conductivity so call **photoconductivity** resulting in an increase in the diode current. The diode equation is modified as –

$$I_{\text{diode}} = (I_d + I_s)(e^{V/q/\eta kT} - 1) \quad \dots 3.2.6$$

where,

$I_d$  is dark current i.e. current that flows when no signal is present.

$I_s$  is photo generated current due to incident optical signal.

Fig. 3.2.1 shows a plot of this equation for varying amounts of incident optical power.

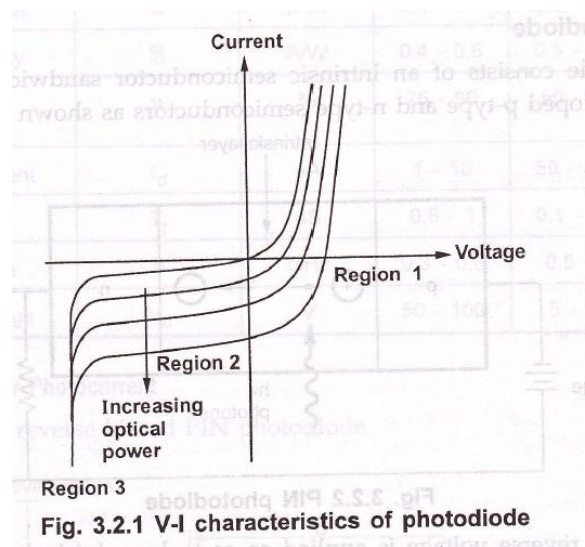

- Three regions can be seen forward bias, reverse bias and avalanche breakdown.
  - i) **Forward bias, region 1** : A change in incident power causes a change in terminal voltage, it is called as **photovoltaic mode**. If the diode is operated in this mode, the frequency response of the diode is poor and so photovoltaic operation is rarely used in optical links.

ii) **Reverse bias, region 2** : A change in optical power produces a proportional change in diode current, it is called as **photoconductive mode** of operation which most detectors use. Under these condition, the exponential term in equation 3.2.6 becomes insignificant and the reverse bias current is given by –

$$I_{\text{diode}} = (I_d + I_s)$$

- **Responsivity** of photodiode is defined as the change in reverse bias current per unit change in optical power, and so efficient detectors need large responsivities.

iii) **Avalanche breakdown, region 3** : When biased in this region, a photo generated electron-hole pair causes avalanche breakdown, resulting in large diode current for a single incident photon. Avalanche photodiodes (APDs) operate in this region APDs exhibit carrier multiplication. They are usually very sensitive detectors. Unfortunately V-I characteristic is very steep in this region and so the bias voltage must be tightly controlled to prevent spontaneous breakdown.

### PIN Photodiode

- PIN diode consists of an intrinsic semiconductor sandwiched between two heavily doped p-type and n-type semiconductors as shown in Fig. 3.2.2.

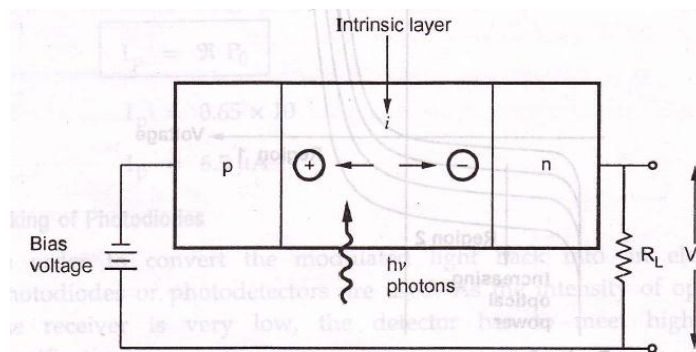

Fig. 3.2.2 PIN photodiode

- Sufficient reverse voltage is applied so as to keep intrinsic region free from carriers, so its resistance is high, most of diode voltage appears across it, and the electrical forces are strong within it. The incident photons give up their energy and excite an electron from valance to conduction band. Thus a free electron hole pair is generated, these are called

as **photocarriers**. These carriers are collected across the reverse biased junction resulting in rise in current in external circuit called **photocurrent**.

- In the absence of light, PIN photodiodes behave electrically just like an ordinary rectifier diode. If forward biased, they conduct large amount of current.
- PIN detectors can be operated in two modes : **Photovoltaic** and **photoconductive**. In photovoltaic mode, no bias is applied to the detector. In this case the detector works very slow, and output is approximately logarithmic to the input light level. Real world fiber optic receivers never use the photovoltaic mode.
- In photoconductive mode, the detector is reverse biased. The output in this case is a current that is very linear with the input light power.
- The intrinsic region some what improves the sensitivity of the device. It does not provide internal gain. The combination of different semiconductors operating at different wavelengths allows the selection of material capable of responding to the desired operating wavelength.

#### Characteristics of common PIN photodiodes

Sr. No.	Parameters	Symbol	Unit	Si	Ge	InGaAs
1.	Wavelength	$\lambda$	$\mu\text{ m}$	0.4 – 1.1	0.8 – 1.8	1.0 – 1.7
2.	Reponsivity	$\mathfrak{R}$	A/W	0.4 – 0.6	0.5 – 0.7	0.6 – 0.9
3.	Quantum efficiency	H	%	75 -90	50 – 55	60 – 70
4.	Darl current	$I_d$	nA	1 – 10	50 – 500	1 - 20
5.	Rise time	$T_r$	nS	0.5 – 1	0.1 – 0.5	0.02 – 0.5
6.	Bandwidth	B	GHz	0.3 – 0.6	0.5 – 3	1 – 10
7.	Bias voltage	$V_b$	V	50 – 100	5 – 10	5 - 6

### Depletion Layer Photocurrent

- Consider a reverse biased PIN photodiode.

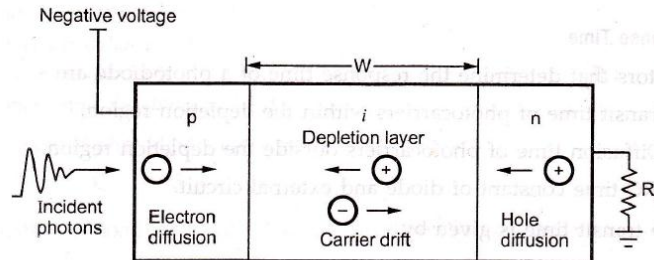

Fig. 3.2.3 Reverse biased PIN diode

- The total current density through depletion layer is –

$$J_{\text{tot}} = J_{\text{dr}} + J_{\text{diff}} \quad \dots 3.2.7$$

Where,

$J_{\text{dr}}$  is drift current density due to carriers generated in depletion region.

$J_{\text{diff}}$  is diffusion current density due to carriers generated outside depletion region.

- The drift current density is expressed as –

$$J_{\text{dr}} = \frac{I_p}{A}$$

$$J_{\text{dr}} = q \phi_0 (1 - e^{-\alpha_s w}) \quad \dots 3.2.8$$

where,

A is photodiode area.

$\phi_0$  is incident photon flux per unit area.

- The diffusion current density is expressed as –

$$J_{\text{diff}} = q \phi_0 \frac{\alpha_s L_p}{1 + \alpha_s L_p} e^{-\alpha_s w} + q P_{n0} \frac{D_p}{L_p} \quad \dots 3.2.9$$

where,

$D_p$  is hole diffusion coefficient.



$P_n$  is hole concentration in n-type material.

$P_{n0}$  is equilibrium hole density.

Substituting in equation 3.2.7, total current density through reverse biased depletion layer is –

$$J_{\text{tot}} = q \phi_0 \left[ 1 - \frac{e^{-\alpha_s w}}{1 + \alpha_s L_p} \right] + q P_{n0} \frac{D_p}{L_p} \quad \dots 3.2.10$$

### Response Time

- Factors that determine the response time of a photodiode are –
  - i) Transit time of photocarriers within the depletion region.
  - ii) Diffusion time of photocarriers outside the depletion region.
  - iii) RC time constant of diode and external circuit.
- The transit time is given by –

$$t_d = \frac{w}{v_d} \quad \dots 3.2.11$$

- The diffusion process is slow and diffusion times are less than carrier drift time. By considering the photodiode response time the effect of diffusion can be calculated. Fig. 3.2.4 shows the response time of photodiode which is not fully depleted.

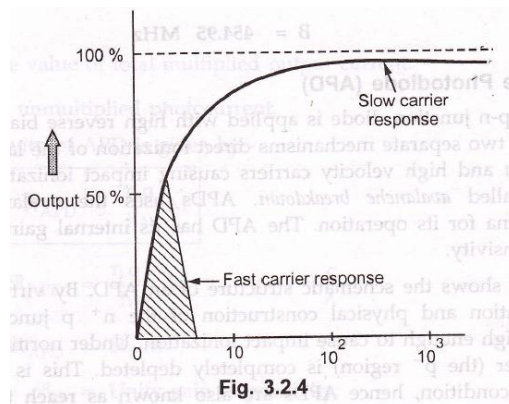

- The detector behaves as a simple low pass RC filter having passband of

$$N = \frac{1}{2\pi R_R C_T} \quad \dots 3.2.12$$

where,

$R_T$ , is combination input resistance of load and amplifier.

$C_T$  is sum of photodiode and amplifier capacitance.

**Example 3.2.5** : Compute the bandwidth of a photodetector having parameters as –

Photodiode capacitance = 3 pF

Amplifier capacitance = 4 pF

Load resistance = 50  $\Omega$

Amplifier input resistance = 1 M $\Omega$

**Solution** : Sum of photodiode and amplifier capacitance

$$C_T = 3 + 4 = 7 \text{ pF}$$

Combination of load resistance and amplifier and input resistance

$$R_T = 50\Omega \parallel 1 \text{ M}\Omega \approx 50 \Omega$$

$\text{Bandwidth of photodetector } B = \frac{1}{2\pi R_R C_T}$
---

$$B = \frac{1}{2\pi \times 50 \times 7 \times 10^{-12}}$$

$$B = 454.95 \text{ MHz}$$

... Ans.

### Avalanche Photodiode (APD)

- When a p-n junction diode is applied with high reverse bias breakdown can occur by two separate mechanisms direct ionization of the lattice atoms, zener breakdown and high velocity carriers impact ionization of the lattice atoms called avalanche breakdown. APDs uses the avalanche breakdown phenomena for its operation. The APD has its internal gain which increases its responsivity.
- Fig. 3.2.5 shows the schematic structure of an APD. By virtue of the doping concentration and physical construction of the  $n^+ p$  junction, the electric field is high enough to cause impact ionization. Under normal operating bias, the I-layer (the p<sup>-</sup> region) is completely depleted. This is known as **reach through** condition, hence APDs are also known as **reach through APD** or **RAPDs.**]

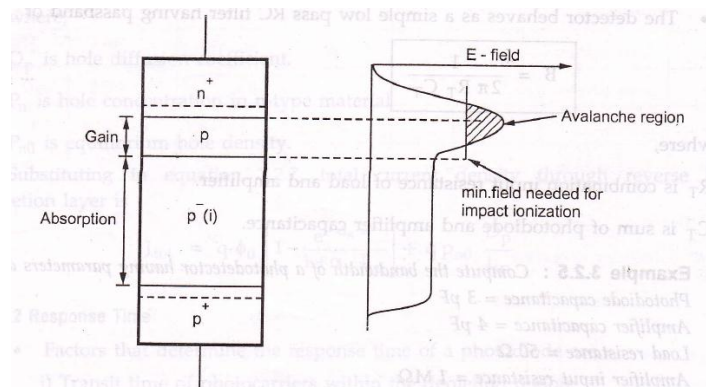

Fig. 3.2.5 APD schematic and variation of E-field across diode

- Similar to PIN photodiode, light absorption in APDs is most efficient in I-layer. In this region, the E-field separates the carriers and the electrons drift into the avalanche region where carrier multiplication occurs. If the APD is biased close to breakdown, it will result in reverse leakage current. Thus APDs are usually biased just below breakdown, with the bias voltage being tightly controlled.
- The multiplication for all carriers generated in the photodiode is given as –

$$M = \frac{I_M}{I_P} \quad \dots 3.2.13$$

where,

$I_M$  = Average value of total multiplied output current.

$I_P$  = Primary unmultiplied photocurrent.

- Responsivity of APD is given by –

$$\mathfrak{R}_{APD} = \frac{\eta q}{h \nu} M$$

$$\mathfrak{R}_{APD} = \frac{\eta q \lambda}{h \nu} M \quad \because \nu = \frac{c}{\lambda}$$

$$\mathfrak{R}_{APD} = \mathfrak{R}_0 M \quad \dots 3.2.14$$

where,

$\mathfrak{R}_0$  = Unity gain responsivity.

### MSM Photodetector

- Metal-semiconductor-metal (MSM) photodetector uses a sandwiched semiconductor between two metals. The middle semiconductor layer acts as optical absorbing layer. A Schottky barrier is formed at each metal semiconductor interface (junction), which prevents flow of electrons.
- When optical power is incident on it, the electron-hole pairs generated through photo absorption flow towards metal contacts and causes photocurrent.
- MSM photodetectors are manufactured using different combinations of semiconductors such as – GaAs, InGaAs, InP, InAIAs. Each MSM photodetectors had distinct features e.g. responsivity, quantum efficiency, bandwidth etc.
- With InAIAs based MSM photodetector, 92 % quantum efficiency can be obtained at 1.3  $\mu\text{m}$  with low dark current. An inverted MSM photodetector shows high responsivity when illuminated from top.
- A GaAs based device with travelling wave structure gives a bandwidth beyond 500 GHz.

### Important Formulae for PIN and APD

PIN photodiode

1.  $\lambda_c = \frac{1.24}{E_g}$
2.  $\eta = \frac{I_p / q}{P_o / h \nu}$
3.  $\mathfrak{R} = \frac{\eta q}{h \nu} = \frac{I_p}{P_o}$

APD

1.  $B = \frac{1}{2\pi R_T C_T}$

## Recommended Questions

### Optical Source

1. List the characteristics of light sources required in optical communication.
2. Describe the construction and working of LED.
3. Explain the structure of surface emitting and edge emitting LEDs.
4. Compare the performance parameters of surface emitting LED and edge emitting LED.
5. Deduce the expression at internal quantum efficiency and internally generated optical power for LED. From this expression how external efficiency and power is calculated?
6. Explain the principle of laser action. Explain also the spontaneous and stimulated emission process.
7. Give the necessary conditions for lasing threshold.
8. Explain the structure of –
  - i) Fabry-Perot resonator.
  - ii) DFB laser diode.
9. Derive expression for lasing condition and hence for optical gain.
10. Explain the power current characteristics of laser diode.
11. Give the expression for –
  - i) External quantum efficiency.
  - ii) Frequency spacing.
  - iii) Wavelength spacing.State the significance of each parameter in the expression.
12. Compare the parameters of LED and LASER.

### Optical Detector

1. With a proper sketch briefly explain the structure of PIN diode.
2. Explain the following term relating to PIN photodiode with proper expressions.
  - i) Cut-off wavelength.
  - ii) Quantum efficiency.
  - iii) Responsivity.
3. Explain the structure and principle of working of APD.
4. Deduce the expression for total current density for APD.
5. How the response time of APD is estimated?
6. Give expression for passband of APD detector.
7. Compare the performance parameters of PIN and APD.

## UNIT - 4

### FIBER COUPLERS AND CONNECTORS

Introduction, fiber alignment and joint loss, single mode fiber joints, fiber splices, fiber connectors and fiber couplers.

#### RECOMMENDED READINGS:

#### TEXT BOOKS:

1. **Optical Fiber Communication** – Gerd Keiser, 4<sup>th</sup> Ed., MGH, 2008.
2. **Optical Fiber Communications**– – John M. Senior, Pearson Education. 3<sup>rd</sup> Impression, 2007.

#### REFERENCE BOOK:

1. **Fiber optic communication** – Joseph C Palais: 4<sup>th</sup> Edition, Pearson Education.

#### 4.1 Fiber Alignment

- In any fiber optic communication system, in order to increase fiber length there is need to joint the length of fiber. The interconnection of fiber causes some loss of optical power. Different techniques are used to interconnect fibers. A permanent joint of cable is referred to as **splice** and a temporary joint can be done with the connector.
- The fraction of energy coupled from one fiber to other proportional to common mode volume  $M_{\text{common}}$ . The fiber – to – fiber coupling efficiency is given as –

$$\eta_F = \frac{M_{\text{common}}}{M_E} \quad \dots (4.1.1)$$

where,

$M_E$  is number of modes in fiber which launches power into next fiber.

- The fiber – to – fiber coupling loss  $L_F$  is given as –

$$L_F = -10 \log \eta_F \quad \dots(4.1.2)$$

#### Mechanical Misalignment

The diameter of fiber is few micrometer hence the microscopic alignment is required. If the radiation cone of emitting fiber does not match the acceptance cone of receiving fiber, radiation loss takes place. The magnitude of radiation loss depends on the degree of misalignment. Different types of mechanical misalignments are shown in Fig. 4.1.1.

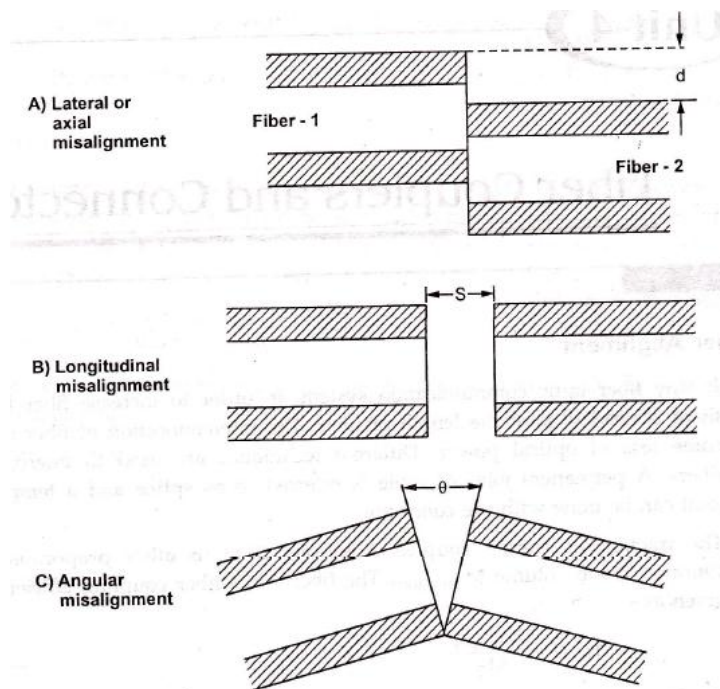

Fig. 4.1.1 Mechanical misalignment between two fibers

### 1. Lateral misalignment

- Lateral or axial misalignment occurs when the axes of two fibers are separated by distance ' $d$ '.

### 2. Longitudinal misalignment

- Longitudinal misalignment occurs when fibers have same axes but their end faces are separated by distance ' $S$ '.

### 3. Angular misalignment

- Angular misalignment occurs when fiber axes and fiber end faces are no longer parallel. There is an angle ' $\theta$ ' between fiber end faces.
- The axial or lateral misalignment is most common in practice causing considerable power loss. The axial offset reduces the common core area of two fiber end faces as shown in Fig. 4.1.2.



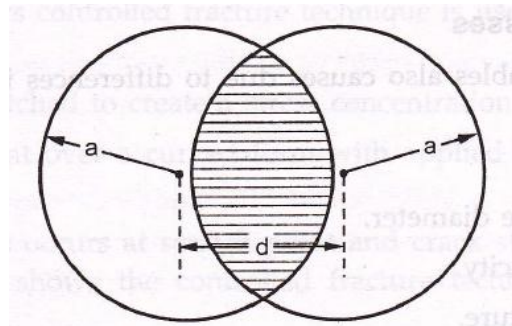

**Fig. 4.1.2 Axial offset of fibers**

- The optical power coupled is proportional to common area of two fiber cores. The common area is given by expression –

$$A_{\text{common}} = 2a^2 \text{ across } \frac{d}{2a} - d \left( a^2 - \frac{d^2}{4} \right)^{1/2} \quad \dots (4.1.3)$$

where,

$a$  is core radius of fiber.

$d$  is separation of core axes.

- The coupling efficiency for step index fiber is the ratio of common core area to the end-face area.

$$\eta_{\text{step}} = \frac{A_{\text{common}}}{\pi a^2}$$

$$\eta_{\text{step}} = \frac{2}{\pi} \text{ across } \frac{d}{2a} - \frac{d}{\pi a} \left[ 1 - \left( \frac{d}{2a} \right)^2 \right]^{1/2} \quad \dots (4.1.4)$$

- For graded index fiber, the total received power for axial misalignment is given by –

$$P_T = \frac{2}{\pi} P \left\{ \text{across } \frac{d}{2a} - \left[ 1 - \left( \frac{d}{2a} \right)^2 \right]^{1/2} \frac{d}{6a} \left( 5 - \frac{d^2}{2a^2} \right) \right\} \quad \dots (4.1.5)$$

where,

$P$  is the power in emitting fiber.

When,  $d \ll a$ , the above expression reduces to

$$P_T = P \left( 1 - \frac{8d}{3\pi q} \right) \quad \dots (4.1.6)$$

### Fiber Related Losses

- Losses in fiber cables also causes due to differences in geometrical and fiber characteristics.

These includes,

- Variation in core diameter.
- Core area ellipticity.
- Numerical aperture.
- Refractive – index profile.
- Core-cladding concentricity.

The user have less control over these variations since they are related to manufacturing process.

- Coupling loss when emitter fiber radius  $a_E$  and receiving fiber radius  $a_R$  is not same, is given as –

$$L_F(a) = \begin{cases} -10 \log \left( \frac{a_R}{a_E} \right)^2 & \text{for } a_R < a_E \\ 0 & \text{for } a_R \geq a_E \end{cases} \quad \dots (4.1.7)$$

where,

$a_E$  is emitter fiber radius.

$a_R$  is receiver fiber radius.

- Coupling loss when numerical apertures of two fibers are not equal, to expressed as –

$$L_F(NA) = \begin{cases} -10 \log \left[ \frac{NA_R(0)}{NA_E(0)} \right]^2, & \text{for } NA_R < NA_E \\ 0, & \text{for } NA_R \geq NA_E \end{cases} \quad \dots (4.1.8)$$

- Coupling loss when core refractive index of two fibers are not same, is expressed as

$$L_F(\alpha) = \begin{cases} -10 \log \frac{\alpha_R (\alpha_E + 2)}{\alpha_E (\alpha_R + 2)}, & \text{for } \alpha_R < \alpha_E \\ 0, & \text{for } \alpha_R \geq \alpha_E \end{cases} \quad \dots (4.1.9)$$

### Fiber End – Face Preparation

- Before connecting or splicing fiber ends must be properly faced to avoid losses and to improve the coupling efficiency. The end faces should be polished until all the scratches are removed and they become smooth.
  - For cleaving fibers controlled fracture technique is used. The process involves following steps.
    1. The fiber is scratched to create a stress concentration at the surface.
    2. Fiber is then bent over a curved form with applied tension to produce stress distribution.
    3. Maximum stress occurs at scratch point and crack starts propagating through fiber.
- Fig. 4.1.4 shows the controlled fracture technique for preparing fiber end.

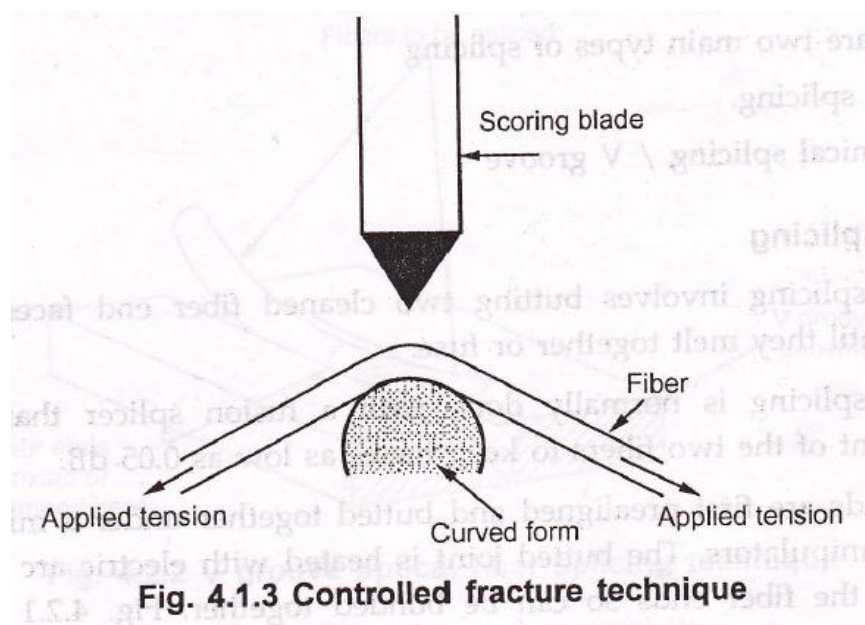

### Precaution

- If the stress distribution is not properly controlled, fiber can fork into several cracks, various types of defects can be introduced in the fiber, few of them are mentioned here.

Sr. No.	Defect Type	Description
1.	Lip	A sharp protrusion, that prevents the core from coming to close contact.
2.	Roll off	Rounding-off of the edge of fiber.
3.	Chip	A localized fracture.

---

---

4.	Hackle	Irregularities across fiber end.
5.	Mist	Similar to hackle.
6.	Step	An abrupt change in end face surface.
7.	Shattering	Result of uncontrolled fracture.

## 4.2 Fiber Splices

- A permanent or semipermanent connection between two individual optical fibers is known as **fiber splice**. And the process of joining two fibers is called as **splicing**.
- Typically, a splice is used outside the buildings and connectors are used to join the cables within the buildings. Splices offer lower attenuation and lower back reflection than connectors and are less expensive.

### Types of Splicing

- There are two main types of splicing
  - i) Fusion splicing.
  - ii) Mechanical splicing / V groove

### Fusion Splicing

- Fusion splicing involves butting two cleaned fiber end faces and heating them until they melt together or fuse.
- Fusion splicing is normally done with a fusion splicer that controls the alignment of the two fibers to keep losses as low as 0.05 dB.
- Fiber ends are first prealigned and butted together under a microscope with micromanipulators. The butted joint is heated with electric arc or laser pulse to melt the fiber ends so can be bonded together. Fig. 4.2.1 shows fusion splicing of optical fibers.

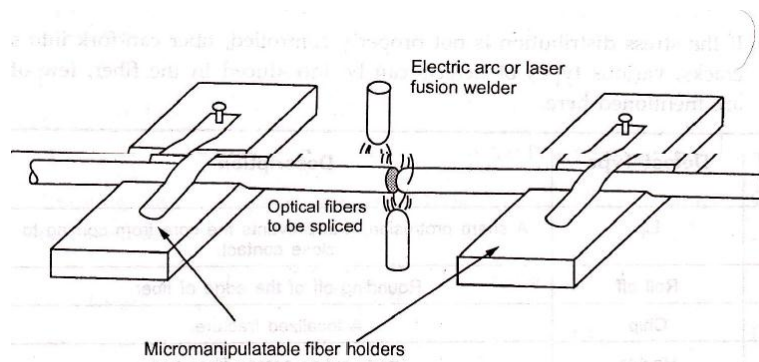

Fig. 4.2.1 Fusion splicing of optical fibers

### Mechanical Splicing / V Groove

- Mechanical splices join two fibers together by clamping them with a structure or by epoxying the fibers together.
- Mechanical splices may have a slightly higher loss and back reflection. These can be reduced by inserting index matching gel.
- V groove mechanical splicing provides a temporary joint i.e fibers can be disassembled if required. The fiber ends are butted together in a V – shaped groove as shown in Fig. 4.2.2.

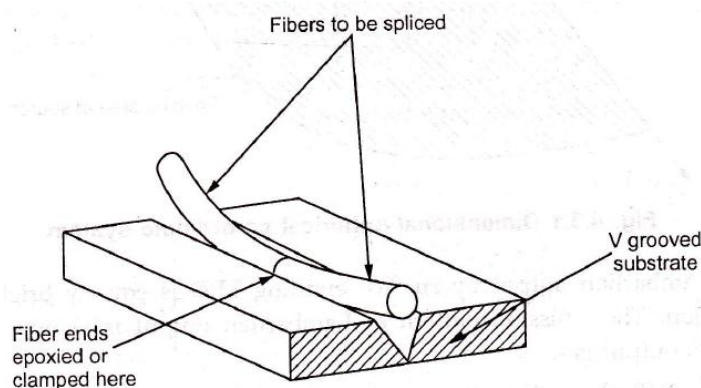

Fig. 4.2.2 V groove optical fiber splicing technique

- The splice loss depends on fiber size and eccentricity.

### 4.3 Source-to-Fiber Power Launching

- Optical output from a source is measured in radiance (B). Radiance is defined as the optical power radiated into a solid angle per unit emitting surface area. Radiance is

specified in  $\text{Watts/cm}^2/\text{Steradian}$ . Radiance is important for defining source to fiber coupling efficiency.

### Source Output Pattern

- Spatial radiation pattern of source helps to determine the power accepting capability of fiber.
- Fig. 4.3.1 shows three dimensional spherical co-ordinate system for characterizing the emission pattern from an optical source. Where the polar axis is normal to the emitting surface and radiance is a function of  $\theta$  and  $\phi$ .

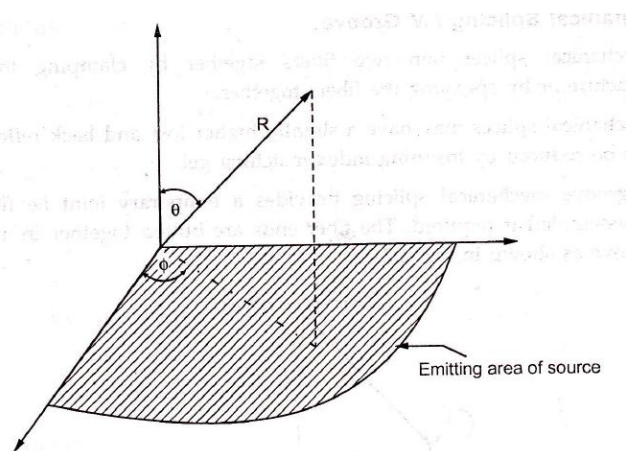

Fig. 4.3.1 Dimensional spherical co-ordinate system

- The Lambertian output by surface emitting LED is equally bright from any direction. The emission pattern of Lambertian output is shown in Fig. 4.3.2 and its output is –

$$B(\theta, \phi) = B_0 \cos \theta$$

where,

$B_0$  is the radiance along the normal to the radiating surface.

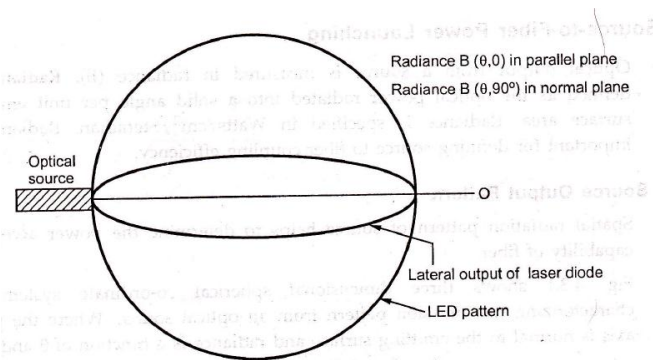

Fig. 4.3.2 Radiance pattern of Lambertian source

- Both radiations in parallel and normal to the emitting plane are approximated by expression –

$$\frac{1}{B(\theta,\phi)} = \frac{\sin^2 \phi}{B_0 \cos^T \theta} + \frac{\cos^2 \phi}{B_0 \cos^L \theta} \quad \dots (4.3.2)$$

where,

T and L are transverse and lateral power distribution coefficients.

**Power Coupling Calculation**

- To calculate power coupling into the fiber, consider an optical source launched into the fiber as shown in Fig. 4.3.3.

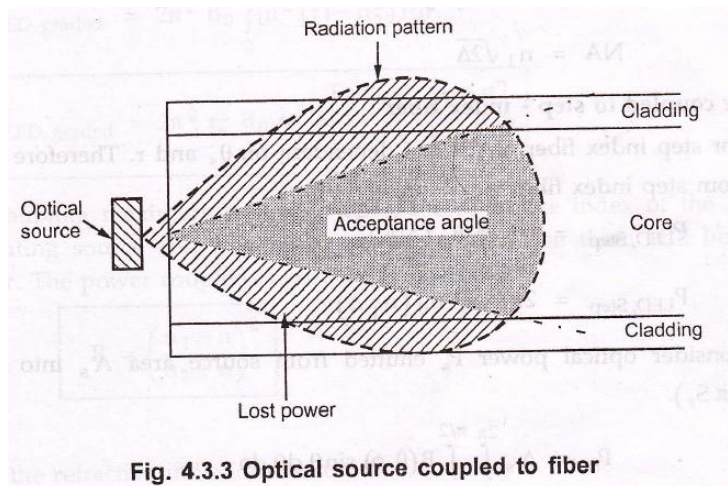

Fig. 4.3.3 Optical source coupled to fiber

- Brightness of source is expressed as  $B(A_s, \Omega_s)$ ,

Where,  $A_s$  is area of source.

$\Omega_s$  is solid emission angle of source.

The coupled power P can be calculated as –

$$P = \int_{A_f} dA_s \int_{\Omega_s} d\Omega_s B(A_s \Omega_s)$$

$$P = \int_0^r \int_0^{2\pi} \left[ \int_0^{2\pi} \int_0^{\theta_{\max}} B(\theta, \phi) \sin\theta \, d\theta \, d\phi \right] d\theta_s \, r dr \quad \dots (4.3.3)$$

The integral limits are area of source and solid acceptance angle ( $\theta_{\max}$ ).

Here  $d\theta_s \, r dr$  is incremental emitting area.

- Let the radius of surface emitting LED is  $r_s$ , and for Lambertian emitter,  $B(\theta, \phi) = B_0 \cos\theta$ , then

$$P = \int_0^r \int_0^{2\pi} \left( 2\pi B_0 \int_0^{\theta_{\max}} \cos\theta \sin\theta \, d\theta \right) d\theta_s \, r dr$$

$$P = B_0 \cdot \pi \int_0^{r_s} \int_0^{2\pi} \sin^2\theta \, \theta_{\max} \, d\theta_s \, r dr$$

$$P = B_0 \cdot \pi \int_0^{r_s} \int_0^{2\pi} NA^2 \, d\theta_s \, r dr \quad \dots (4.3.4)$$

Since  $NA = n_1 \sqrt{2\Delta}$

### Power coupled to step – index fiber

- For step index fiber NA is not dependent on  $\theta_s$  and  $r$ . Therefore LED power from step index fiber is,

$$P_{LED, Step} = \pi^2 r_s^2 B_0 (NA)^2$$

$$P_{LED, Step} = 2\pi^2 r_s^2 B_0 (n_1^2 \Delta) \quad \dots (4.3.5)$$

- Consider optical power  $P_s$  emitted from source area  $A_s$  into hemisphere ( $2\pi S_r$ ).

$$P = A_s \int_0^{2\pi} \int_0^{\pi/2} B(\theta, \phi) \sin\theta \, d\theta \, d\phi$$

$$P = \pi r_s^2 2\pi B_0 \int_0^{\pi/2} \cos\theta \sin\theta \, d\theta$$

$$P_s = \pi^2 \cdot r_s^2 B_0$$

... (4.3.6)



- When source radius  $r_s < a$ , the fiber core radius, the LED output power is given from equation (4.3.5).

$$P_{s, \text{Step}} = P_s (NA)^2 \quad \dots (4.3.7)$$

- When  $r_s > a$  equation (4.3.5) becomes,

$$P_{\text{LED, Step}} = \left(\frac{a}{r_s}\right)^2 \cdot P_s (NA)^2 \quad \dots (4.3.8)$$

### Power coupled to graded index fiber

- In graded index fiber, the index of refraction varies radially from fiber axis. Numerical aperture for graded index fiber is given by,

$$P_{\text{LED, Step}} = 2\pi^2 B_0 \int_0^{r_s} [n^2(r) - n_2^2] r dr$$

$$P_{\text{LED, Step}} = 2\pi^2 r_s^2 B_0 n_1^2 \Delta \left[ 1 - \frac{2}{\alpha + 2} \left(\frac{r_s}{a}\right)^\alpha \right] \quad \dots (4.3.9)$$

Is source radius ( $r_s$ ) is less than fiber core radius ( $a$ ) i.e.  $r_s < a$ , the power coupled from surface emitting LED is given as –

- For coupling maximum power to fiber, the refractive index of the medium separating source and fiber must be same, otherwise there will be loss of power. The power couple is reduced by factor,

$$R = \left(\frac{n_1 - n}{n_1 + n}\right)^2 \quad \dots (4.3.10)$$

where,

$n$  is the refractive index of medium.

$n_1$  is the refractive index of fiber core.

$R$  is the Fresnel reflection or reflectivity.

#### 4.4 Lensing Schemes for Coupling Improvement

- When the emitting area of the source is smaller than the core area of fiber, the power coupling efficiency becomes poor. In order to improve the coupling efficiency a miniature lens is placed between source and fiber. A microlens magnifies the emitting area of source equal to core area. The power coupled increases by a factor equal to magnification factor of lens.

(See Fig. 4.4.1 on next page.)

- Important types of lensing schemes are :
  1. Rounded – end fiber.
  2. Spherical – surfaced LED and Spherical-ended fiber.
  3. Taper ended fiber.
  4. Non imaging microsphere.
  5. Cylindrical lens,
  6. Imaging sphere.

Fig. 4.4.1 shows the lensing schemes.

- There are some drawbacks of using lens.
  1. Complexity increases.
  2. Fabrication and handling difficulty.
  3. Precise mechanical alignment is needed.

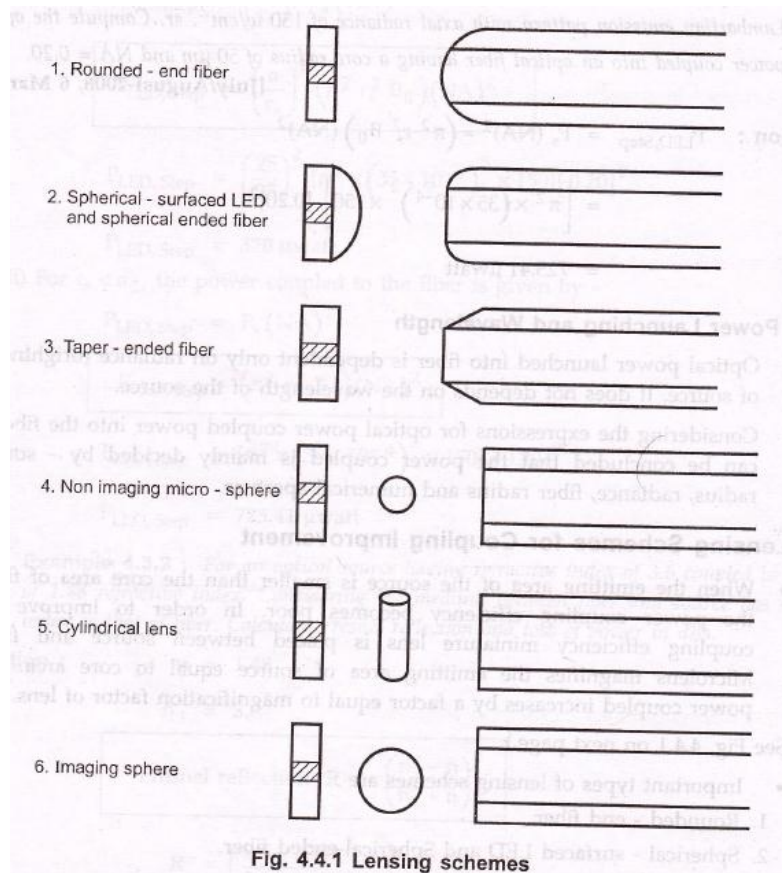

#### 4.5 Equilibrium Numerical Aperture

- The light source has a short fiber flylead attached to it to facilitate coupling the source to a system fiber.
- The low coupling loss, this flylead should be connected to system fiber with identical NA and core diameter. At this junction certain amount of optical power approximately 0.1 to 1 dB is lost, the exact loss depends on method of connecting. Also excess power loss occurs due to non propagating modes scattering out of fiber.
- The excess power loss is to be analyzed carefully in designing optical fiber system. This excess loss is shown in terms of fiber numerical aperture(NA).

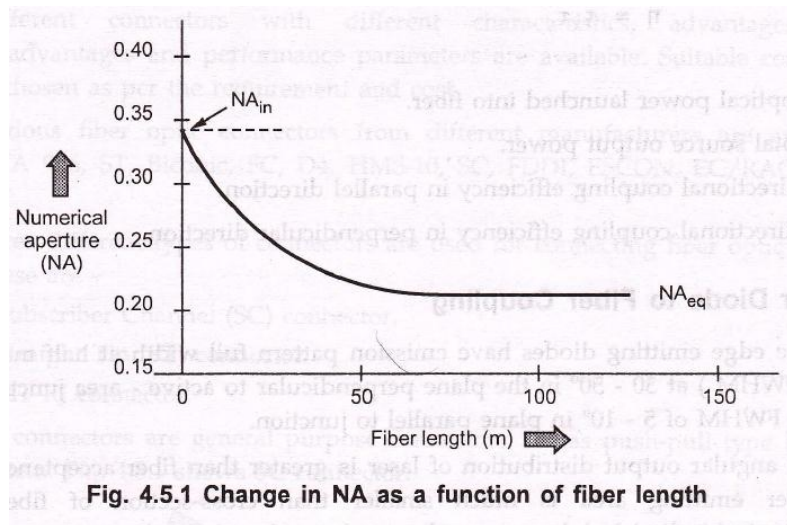

Fig. 4.5.1 Change in NA as a function of fiber length

- Numerical aperture at input light acceptance side is denoted by  $NA_{in}$ . When light emitting area LED is less than fiber core cross-sectional area then power coupled to the fiber is  $NA = NA_{in}$ .
- If the optical powers of measured in long fiber lengths under equilibrium of modes, the effect of equilibrium numerical aperture  $NA_{eq}$  is significant. Optical power at this point is given by,

$$P_{eq} = P_{50} \left( \frac{NA_{eq}}{NA_{in}} \right)^2 \quad \dots (4.5.1)$$

where,

$P_{50}$  is optical power in fiber at 50 m distance from launch NA.

- The degree of mode coupling is mainly decided by core – cladding index difference. Most optical fibers attain 80 – 90 % at their equilibrium NA after 50 m. Hence  $NA_{eq}$  is important while calculating launched optical power in telecommunication systems.

#### 4.6 LED to Fiber Coupling

- The edge-emitting LED have Laser like output hence can launch sufficient optical power for the data rates upto 560 Mb / sec over several kilometers. Also LEDs are cost effective and reliable.
- The LED to step index fiber coupling efficiency is given by,

$$\eta = \frac{P_{in}}{P_s} \quad \dots (4.6.1)$$

$$\eta = \tau_x \tau_y \quad \dots (4.6.2)$$

where,

$P_{in}$  is optical power launched into fiber.

$P_s$  is total source output power.

$\tau_x$  is directional coupling efficiency in parallel direction.

$\tau_y$  is directional coupling efficiency in perpendicular direction.

#### 4.7 Laser Diode to Fiber Coupling

- The edge emitting diodes have emission pattern full width at half maximum (FWHM) at  $30 - 50^\circ$  in the plane perpendicular to active – area junction and an FWHM of  $5 - 10^\circ$  in plane parallel to junction.
- An angular output distribution of laser is greater than fiber acceptance angle laser emitting area is much smaller than cross-section of fiber core, spherical/cylindrical lenses can be used employed for improving coupling efficiency.
- The coupling efficiency for a surface emitting LED as a function of emitting area diameter for a fiber with NA = 0.20 and core radius  $a = 25 \mu\text{m}$  is shown in Fig. 4.7.1.

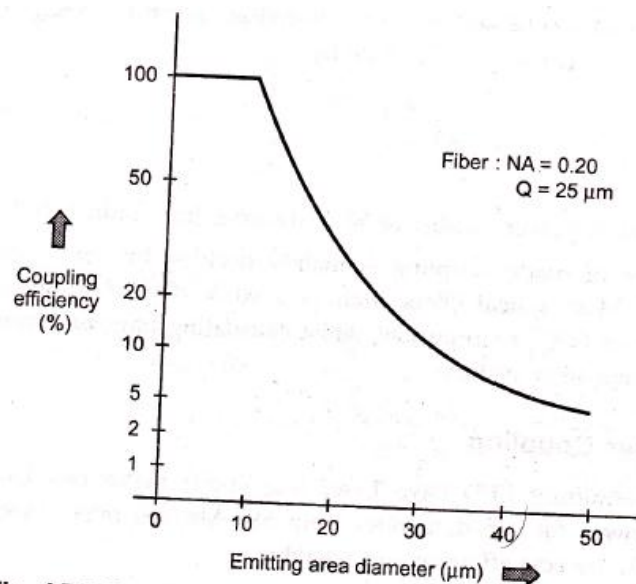

**Fig. 4.7.1 Coupling efficiency Vs emitting area diameter**

## 4.8 Fiber Connectors

- Connectors are mechanisms or techniques used to join an optical fiber to another fiber or to a fiber optic component.
- Different connectors with different characteristics, advantages and disadvantages and performance parameters are available. Suitable connector is chosen as per the requirement and cost.
- Various fiber optic connectors from different manufactures are available SMA 906, ST, Biconic, FC, D4, HMS-10, SC, FDDI, ESCON, EC/RACE, LC, MT.
- Three different types of connectors are used for connecting fiber optic cables. These are –
  1. Subscriber Channel (SC) connector.
  2. Straight Tip (ST) connector.
  3. MT-RJ connector.
- SC connectors are general purpose connections. It has push-pull type locking system. Fig. 4.8.1 shows SC connector.

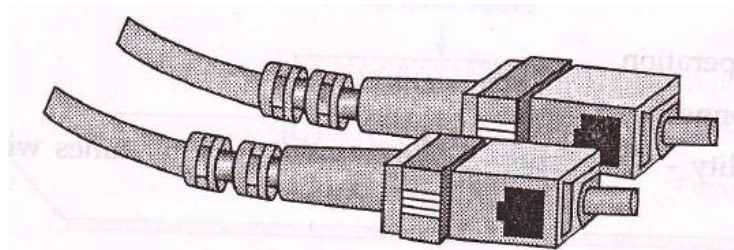

Fig. 4.8.1 SC connector for fiber cable

- ST connectors are most suited for networking devices. It is more reliable than SC connector. ST connector has bayonet type locking system. Fig. 4.8.2 shows ST connectors.

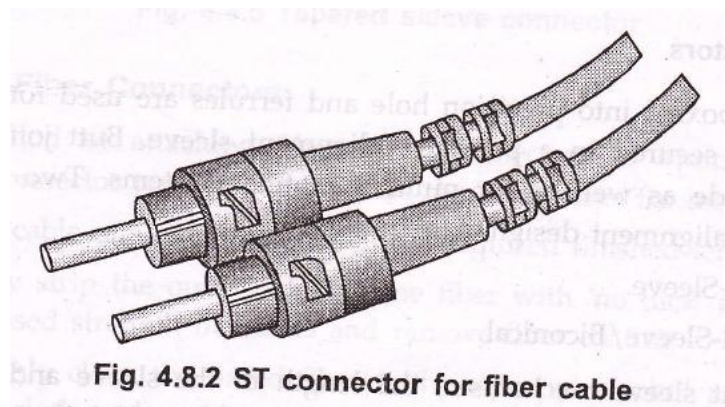
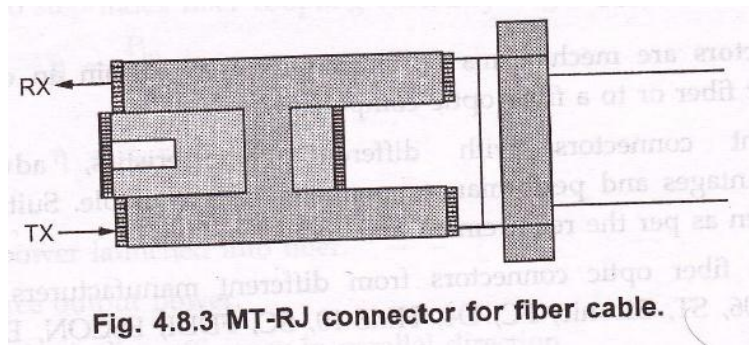

Fig. 4.8.2 ST connector for fiber cable

- MT-RJ connector is similar to RJ45 connector. Fig. 4.8.3 shows MT-RJ connector.



### Principles of Good Connector Design

1. Low coupling loss.
2. Inter-changeability – No variation in loss whenever a connector is applied to a fiber.
3. Ease of assembly.
4. Low environmental sensitivity.
5. Low cost – The connector should be inexpensive also the tooling required for fitting.
6. Reliable operation.
7. Ease of connection.
8. Repeatability – Connection and reconnection many times without an increase in loss.

### Connector Types

- Connectors use variety of techniques for coupling such as screw on, bayonet-mount, push-pull configurations, butt joint and expanded beam fiber connectors.

### Butt Joint Connectors

- Fiber is epoxied into precision hole and ferrules are used for each fiber. The fibers are secured in a precision alignment sleeve. Butt joints are used for single mode as well as for multimode fiber systems. Two commonly used butt-joint alignment designs are :
  1. Straight-Sleeve.
  2. Tapered-Sleeve/Biconical.
- In straight sleeve mechanism, the length of the sleeve and guided ferrules determines the end separation of two fibers. Fig. 4.8.4 shows straight sleeve alignment mechanism of fiber optic connectors.

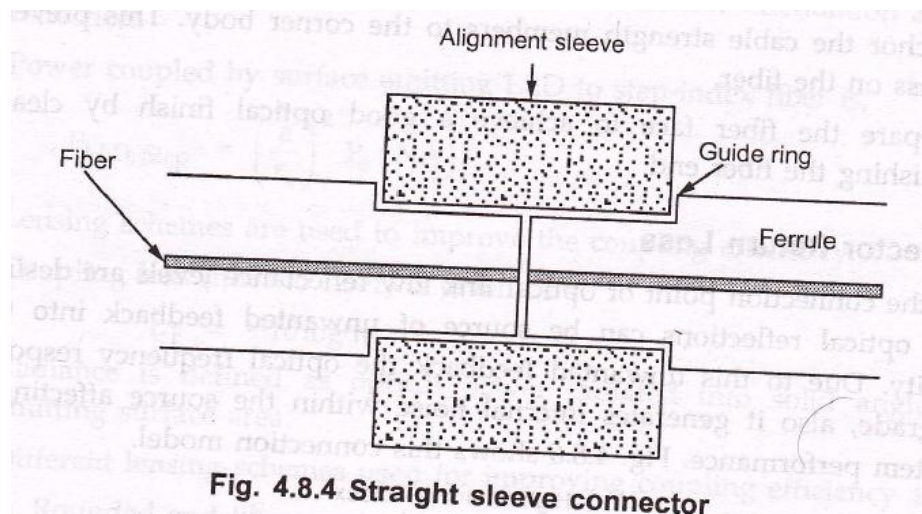

- In tapered sleeve or biconical connector mechanism, a tapered sleeve is used to accommodate tapered ferrules. The fiber end separations are determined by sleeve length and guide rings. Fig. 4.8.5 shows tapered sleeve fiber connectors.

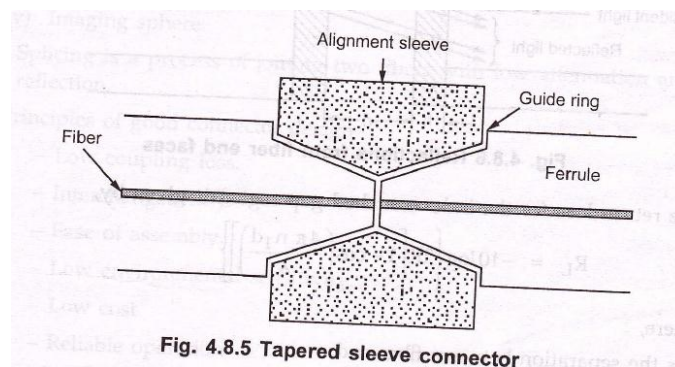

### Installing Fiber Connectors

- The method of attaching fiber optic connectors to optical fibers varies among connector types. Following are the basic steps for installing fibers –
  - i) Cut the cable one inch longer than the required finished length.
  - ii) Carefully strip the outer jacket of the fiber with ‘no nick’ fiber strippers. Cut the exposed strength members and remove fiber coating.
  - iii) Thoroughly clean the bared fiber with isopropyl alcohol poured onto a soft, lint free cloth such as kimwipes. Never clean the fiber with dry tissue.
  - iv) The connector may be attached by applying epoxy or by crimping.
  - v) Anchor the cable strength members to the corner body. This prevents direct stress on the fiber.



- vi) Prepare the fiber face to achieve a good optical finish by cleaning and polishing the fiber end.

### Connector Return Loss

- At the connection point of optical link low reflectance levels are desired since the optical reflections can be source of unwanted feed back into the laser cavity. Due to this unwanted feedback the optical frequency response may degrade, also it generates internal noise within the source affecting overall system performance. Fig. 4.8.6 shows the connection model.

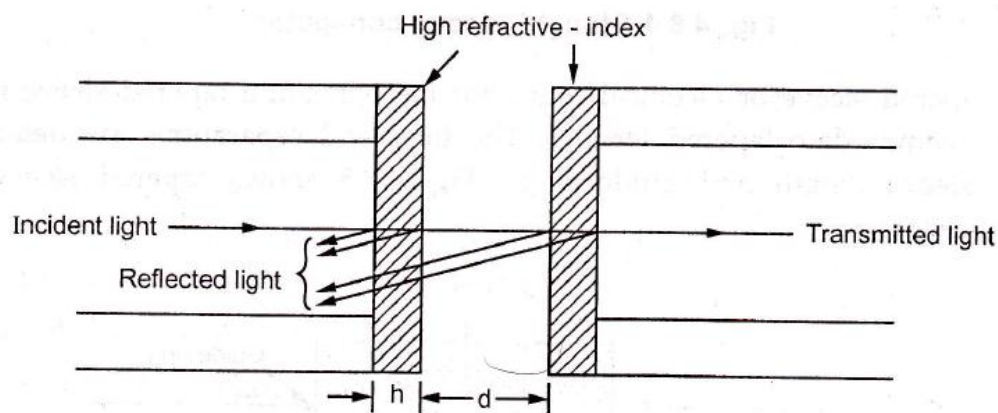

**Fig. 4.8.6 Reflections from fiber end faces**

- The return loss for the index-matched gap region is given by,

$$R_L = -10 \text{Log} \left\{ 2R \left[ 1 - \cos \left( \frac{4\pi n_1 d}{\lambda} \right) \right] \right\} \quad \dots (4.8.1)$$

where,

$D$  is the separation between fiber end.

$n_1$  is index-matching material.

$R$  is reflectivity constant.

**Recommended Questions**

1. State the considerations for power coupling and power launching in a fiber optic system.
2. Derive the expression for power coupling to a step index fiber by a surface emitting LED.
3. Derive the expression for power coupling to a graded index fiber by a surface emitting LED.
4. Explain various types of misalignments in fiber cables.
5. Derive the expression for power received by fiber for axial misalignment.
6. Give the expressions for various fiber-related losses.
7. State the steps involved in cleaving process
8. Explain controlled fracture technique of cleaving.
9. Define finer splicing. Explain different types of splicing.
10. State the considerations for power coupling and power launching in a fiber optic system.
11. Derive the expression for power coupling to a step index fiber by a surface emitting LED.
12. Derive the expression for power coupling to a graded index fiber by a surface emitting LED.
13. State the factors on which the power launching capability of source is dependent.
14. What is lensing schemes? With simple sketch show different lensing scheme. State the drawback of lensing schemes also.
15. Explain equilibrium numerical aperture.
16. Write note on laser diode to fiber coupling.
17. State the principles of good connector design.
18. List the steps involved in process of installing fiber optic connectors.

## **UNIT - 5**

### **OPTICAL RECEIVER**

Introduction, Optical Receiver Operation, receiver sensitivity, quantum limit, eye diagrams, coherent detection, burst mode receiver operation, Analog receivers.

#### **RECOMMENDED READINGS:**

#### **TEXT BOOKS:**

1. **Optical Fiber Communication** – Gerd Keiser, 4<sup>th</sup> Ed., MGH, 2008.
2. **Optical Fiber Communications**– – John M. Senior, Pearson Education. 3<sup>rd</sup> Impression, 2007.

#### **REFERENCE BOOK:**

1. **Fiber optic communication** – Joseph C Palais: 4<sup>th</sup> Edition, Pearson Education.

## 5.1 Optical Receiver Design

- An optical receiver system converts optical energy into electrical signal, amplify the signal and process it. Therefore the important blocks of optical receiver are :sdsfd
  - Photodetector / Front-end
  - Amplifier / Liner channel
  - Signal processing circuitry / Data recovery.

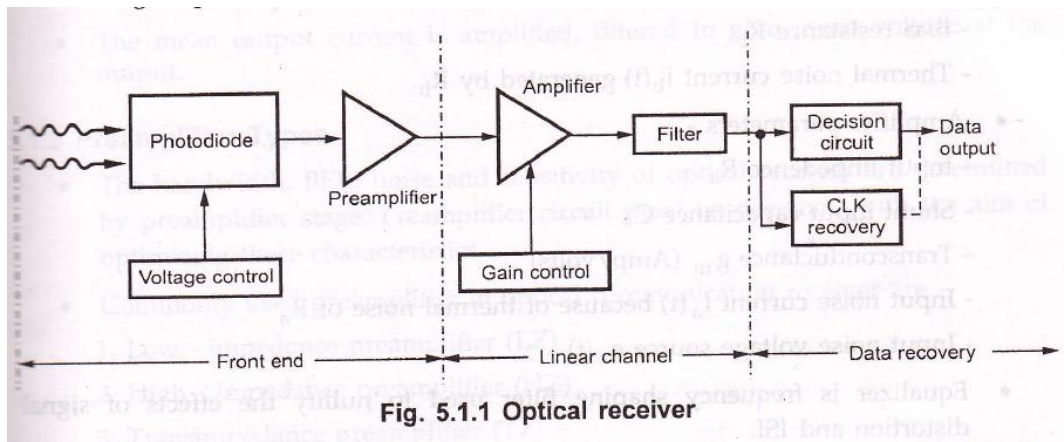

- Noise generated in receiver must be controlled precisely as it decides the lowest signal level that can be detected and processed. Hence noise consideration is an important factor in receiver design. Another important performance criteria of optical receiver is average error probability.

### Receiver Configuration

- Configuration of typical optical receiver is shown in Fig. 5.1.2.

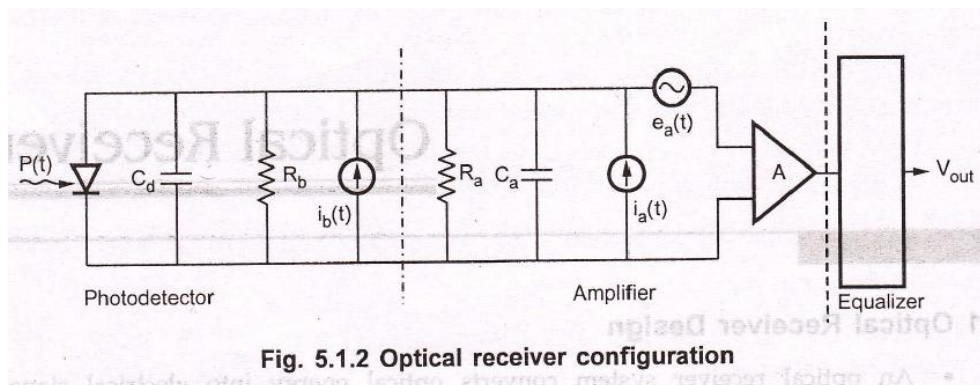

- Photodetector parameters –
  - PIN or APD type

- Gain  $M = 1$
- Quantum efficiency  $\eta$
- Capacitance  $C_d$
- Diode resistance  $R_b$
- Thermal noise current  $i_b(t)$  generated by  $R_b$ .
- Amplifier parameters –
  - Input impedance  $R_a$
  - Shunt input capacitance  $C_o$
  - Transconductance  $g_m$  (Amp/volts)
  - Input noise current  $i_a(t)$  because of thermal noise of  $R_a$
  - Input noise voltage source  $e_a(t)$
- Equalizer is frequency shapping filter used to mollify the effects of signal distortion and ISI.

### Expression for Mean Output Current from Photodiode

#### Assumptions :

1. All noise sources are Gaussian in statistics.
  2. All noise sources are flat in spectrum.
  3. All noise sources are uncorrelated (statistically independent).
- Binary digital pulse train incident on photodetector is given by –

$$P(t) = \sum_{n=-\infty}^{\infty} b_n h_p(t - nT_b) \quad \dots (5.1.1)$$

Where,

$P(t)$  is received optical power.

$T_b$  is bit period.

$b_n$  is amplitude parameter representing  $n$ th message bit.

$h_p(t)$  is received pulse shape.

- At time  $t$ , the mean output current due to pulse train  $P(t)$  is –

$$\langle i(t) \rangle = \frac{q}{h\nu} M P(t) \quad \dots (5.1.2)$$

Where,  $M$  is gain of photodetector

$\frac{nq}{hv}$  is responsivity of photodiode ( $\mathcal{R}_0$ )

- Neglecting dark current, the mean output current is given as –

$$\langle i(t) \rangle = \mathcal{R}_0 M \sum_{n=-\infty}^{\infty} b_n h_p(t - nT_b) \quad \dots (5.1.3)$$

- Then mean output current is amplified, filtered to give mean voltage at the output.

### Preamplifier Types

- The bandwidth, BER, noise and sensitivity of optical receiver are determined by preamplifier stage. Preamplifier circuit must be designed with the aim of optimizing these characteristics.
- Commonly used preamplifier in optical communication receiver are –
  1. Low – impedance preamplifier (LZ)
  2. High – impedance preamplifier (HZ)
  3. Transimpedance preamplifier (TZ)

#### 1. Low – impedance preamplifier (LZ)

- In low-impedance preamplifier, the photodiode is configured in low – impedance amplifier. The bias resistor  $R_b$  is used to match the amplifier impedance.  $R_b$  along with the input capacitance of amplifier decides the bandwidth of amplifier.
- Low – impedance preamplifier can operate over a wide bandwidth but they have poor receiver sensitivity. Therefore the low – impedance amplifier are used where sensitivity is of not prime concern.

#### 2. High – impedance preamplifier (HZ)

- In high – impedance preamplifier the objective is to minimize the noise from all sources. This can be achieved by –
  - Reducing input capacitance by selecting proper devices.
  - Selecting detectors with low dark currents.
  - Minimizing thermal noise of biasing resistors.
  - Using high impedance amplifier with large  $R_b$ .
- The high impedance amplifier uses FET or a BJT. As the high impedance circuit has large RC time constant, the bandwidth is reduced. Fig. 5.1.3 shows equivalent circuit of high input impedance pre-amplifier.

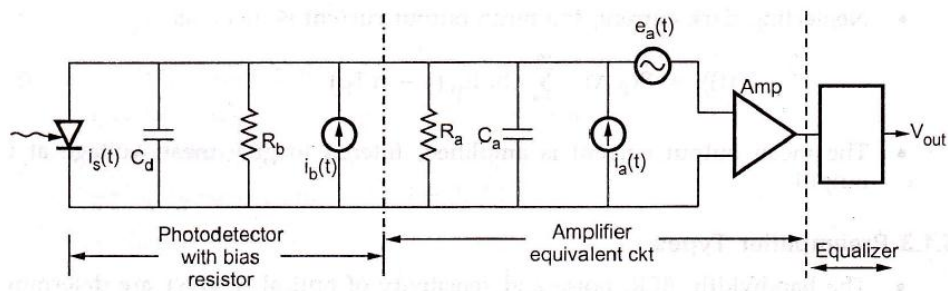

**Fig. 5.1.3 High - input impedance preamplifier**

- High-input impedance preamplifiers are most sensitive and find application in long-wavelength, long haul routes. The high sensitivity is due to the use of a high input resistance (typically  $> 1 \text{ M}\Omega$ ), which results in exceptionally low thermal noise. The combination of high resistance and receiver input capacitance, results in very low BW, typically  $< 30 \text{ kHz}$ , and this causes integration of the received signal. A differentiating, equalizing or compensation network at the receiver output corrects for this integration.

### 3. Transimpedance preamplifier (TZ)

- The drawbacks of high input impedance are eliminated in transimpedance preamplifier. A negative feedback is introduced by a feedback resistor  $R_f$  to increase the bandwidth of open loop preamplifier with an equivalent thermal noise current  $i_f(t)$  shunting the input. An equivalent circuit of transimpedance preamplifier is shown in Fig. 5.1.4.

$e_a(t)$  = Equivalent series voltage noise source

$i_a(t)$  = Equivalent shunt current noise.

$$R_{in} = R_a \parallel C_a.$$

$R_f$  = Feedback resistor.

$i_f(t)$  = Equivalent thermal noise current.

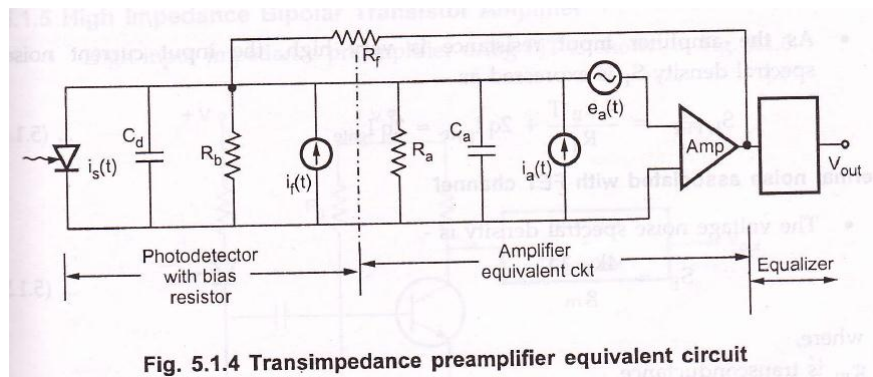

- Although the resulting receiver is often not as sensitive as the integrating front end design, this type of preamplifier does not exhibit a high dynamic range and is usually cheaper to produce.

### High Impedance FET Amplifier

- High input impedance preamplifier using FET is shown in Fig. 5.1.5.

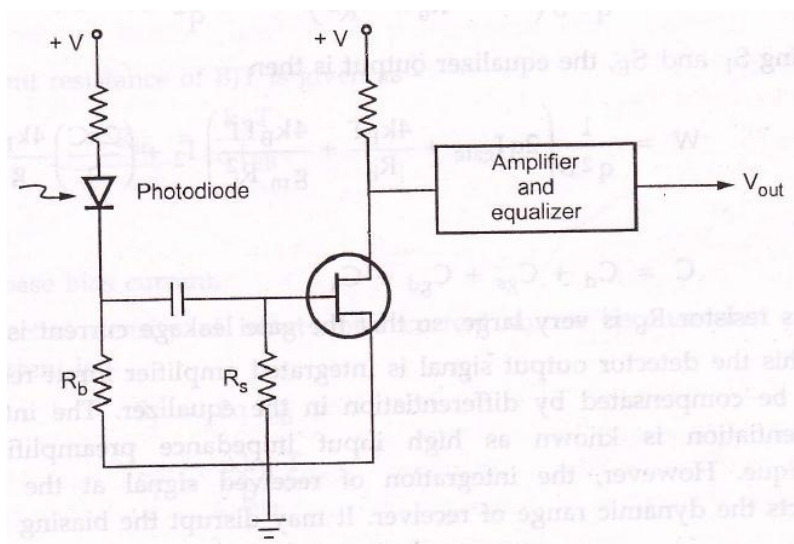

**Fig. 5.1.5 High input impedance preamplifier using FET**

- Basic noise sources in the circuit are –
  - Thermal noise associated with FET channel.
  - Thermal noise from load.
  - Thermal noise from feedback resistor.
  - Shot noise due to gate – leakage current ( $I_{gate}$ )
  - FET 1/f noise.



- As the amplifier input resistance is very high, the input current noise spectral density  $S_I$  is expressed as –

$$S_{I,FET} = \frac{4k_B T}{R_a} + 2q I_{gate} \approx 2q I_{gate} \pi \quad \dots (5.1.4)$$

### Thermal noise associated with FET channel

- The voltage noise spectral density is –

$$S_E = \frac{4k_B T \Gamma}{g_m} \quad \dots (5.1.5)$$

where,

$g_m$  is transconductance.

$\Gamma$  is channel noise factor.

- **Thermal noise characteristic** equation is a very useful figure of merit for a receiver as it measures the noisiness of amplifier. The equation is reproduced here –

$$W = \frac{1}{q^2 B} \left( S_I + \frac{4k_B T}{R_b} + \frac{S_E}{R^2} \right) I_2 + \frac{(2\pi C)^2}{q^2} S_E I_3 B$$

Substituting  $S_I$  and  $S_E$ , the equalizer output is then

$$W = \frac{1}{q^2 B} \left( 2q I_{gate} + \frac{4k_B T}{R_b} + \frac{4k_B T \Gamma}{g_m R_b^2} \right) I_2 + \left( \frac{2\pi C}{q} \right) \frac{4k_B T \Gamma}{g_m} I_3 B$$

Where,

$$C = C_d + C_{gs} + C_{gd} + C_s \quad \dots (5.1.6)$$

- If bias resistor  $R_b$  is very large, so that the gate leakage current is very low. For this the detector output signal is integrated amplifier input resistance. It is to be compensated by differentiation in the equalizer. The integration – differentiation is known as high input impedance preamplifier design technique. However, the integration of receive signal at the front end restricts the dynamic range of receiver. It may disrupt the biasing levels and receiver may fail. To correct it the line coded data or AGC may be employed such receivers can have dynamic ranges in excess of 20 dB.
- Of course, FET with high  $g_m$  is selected. For high data rates GaAs MESFET are suitable while at lower frequencies silicon MOSFETs or JFET are preferred

### High Impedance Bipolar Transistor Amplifier

- High input impedance preamplifier using BJT is shown in Fig. 5.1.6.

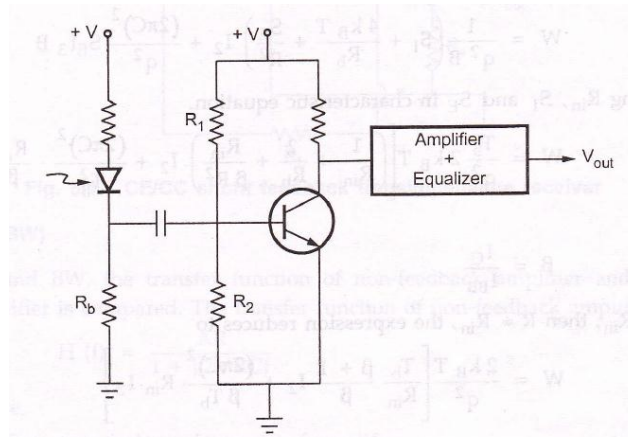

Fig. 5.1.6 High input impedance preamplifier using BJT

- Input resistance of BJT is given as –

$$R_{in} = \frac{k_B T}{q I_{BB}} \quad \dots (5.1.7)$$

Where,

$I_{BB}$  is base bias current.

- Spectral density of input noise current source because shot noise of base current is –

$$S_I = 2qI_{BB}$$

$$S_I = \frac{2k_B T}{R_{in}} \quad \dots (5.1.8)$$

- Spectral height of noise voltage source is given as –

$$S_E = \frac{2k_B T}{g_m} \quad \dots (5.1.9)$$

Where,  $g_m$  is transconductance.

$$g_m = \frac{qI_c}{k_B T} = \frac{\beta}{R_{in}}$$

- The performance of receiver is expressed by thermal noise characteristic equation (W)

$$W = \frac{1}{q^2 B} \left( S_1 + \frac{4k_B T}{R_b} + \frac{S_E}{R^2} \right) I_2 + \frac{(2\pi C)^2}{q^2} S_E I_3 B$$

Substituting  $R_{in}$ ,  $S_1$  and  $S_E$  in characteristic equation.

$$W = \frac{T_b}{q^2} 2k_B T \left[ \left( \frac{1}{R_{in}} + \frac{2}{R_B} + \frac{R_{in}}{\beta R^2} \right) I_2 + \frac{(2\pi C)^2}{T_b^2} \cdot \frac{R_{in}}{\beta} I_3 \right] \quad \dots (5.10.10)$$

Where,  $\beta = \frac{I_C}{I_{BB}}$

If  $R_b \gg R_{in}$ , then  $R \approx R_{in}$ , the expression reduces to

$$W = \frac{2k_B T}{q^2} \left[ \frac{T_b}{R_{in}} \frac{\beta+1}{\beta} I_2 + \frac{(2\pi C)^2}{\beta T_b} R_{in} I_3 \right] \quad \dots (5.1.11)$$

### Transimpedance Amplifier

- An ideal transimpedance preamplifier provides an output voltage which is directly proportional to the input current and independent of course and load impedance.
- A transimpedance amplifier is a high-gain high-impedance amplifier with feedback resistor  $R_f$  Fig. 5.1.7 shows a simple CE/CC. Shunt feedback transimpedance receiver.

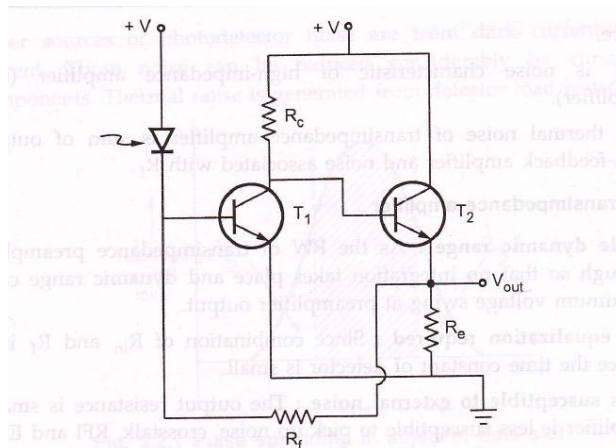

Fig. 5.1.7 CE/CC shunt feedback transimpedance receiver

### Bandwidth (BW)

- To find BW, the transfer function of non-feedback amplifier and feedback amplifier is compared. The transfer function of non-feedback amplifier is

$$H(f) = \frac{AR}{1+j2\pi RCf} \quad \dots (5.1.12)$$

Where,

A is frequency independent gain of amplifier.

- Now the transfer function of feedback (transimpedance) amplifier is –

$$H_{TZ} = \frac{AR}{1+j\frac{2\pi RCf}{A}} \quad \dots (5.1.13)$$

- This yields the BW of transimpedance amplifier.

$$B_{TZ} = \frac{AR}{4RC} \quad \dots (5.1.14)$$

i.e. BW of transimpedance amplifier is A times that of high-impedance amplifier. Because of this equalization becomes easy.

### Characteristic equation

- The thermal noise characteristic equation (W) is reduced to –

$$W_{TZ} = W_{HZ} + \frac{T_b}{q^2} \cdot \frac{4k_B T}{R_f} I_2 \quad \dots (5.1.5)$$

Where,

$W_{HZ}$  is noise characteristic of high-impedance amplifier (non-feedback amplifier).

Thus thermal noise of transimpedance amplifier is sum of output noise of non-feedback amplifier and noise associated with  $R_f$ .

### Benefits of transimpedance amplifier

1. **Wide dynamic range** : As the BW of transimpedance preamplifier is high enough so that no integration takes place and dynamic range can be set by maximum voltage swing at preamplifier output.
2. **No equalization required** : Since combination of  $R_{in}$  and  $R_f$  is very small hence the time constant of detector is small.
3. **Less susceptible to external noise** : The output resistance is small hence the amplifier is less susceptible to pick up noise, crosstalk, RFI and EMI.
4. **Easy control** : Transimpedance amplifiers have easy control over its operation and is stable.
5. **Compensating network not required** : Since integration of detected signal does not occur, compensating network is not required.

## High Speed Circuit

- Now fiber optic technology is widely employed for long-distance communication, LAN and in telephone networks also because of improvement in overall performance, reliable operation and cost effectiveness.
- Fiber optic link offers wide bandwidth to support high speed analog and digital communication.

Because of advancement in technology minimized transmitters and receivers and available in integrated circuits package.

## 5.2 Receiver Noise

- In a receiver system errors arises because of noises and disturbances in the signal detection system. Noise is an unwanted electric signal in signal processing. The noise sources can be internal or external to the system. Only the internal sources of noise are considered here.
- The nose is generated by spontaneous fluctuations of current and voltage (e.g. shot noise, thermal noise). When photons incident on the photodetector are random in nature, quantum noise (shot noise) is generated. This noise is significant for both PIN and APD receivers.
- Other sources of photodetector noise are from dark current and leakage current. These noise can be reduced considerably by choosing proper components. Thermal noise is generated from detector load resistances.

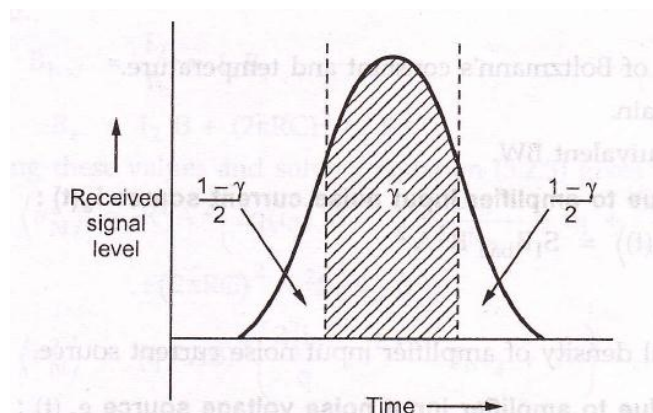

Fig. 5.2.1 Pulse spreading in adjacent time slot

- Intersymbol interference (ISI) also contributes to error which is causing from pulse spreading. Because of pulse spreading energy of a pulse spreads into neighbouring time slots, results in an interfering signal. Fig. 5.2.1 shows ISI.

- Energy in appropriate time slot is  $\gamma$ . The total energy in adjacent slots is  $1 - \gamma$  as shown in the Fig. 5.2.1.

### Noise Mechanisms

$$v_{out}(t) = \langle v_{out}(t) \rangle + v_N(t) \quad \dots (5.2.1)$$

Where,

$v_N(t)$  is noise voltage.

$v_{out}(t)$  is mean output voltage.

The noise voltage can be expressed as –

$$v_N^2(t) = v_{shot}^2(t) + v_R^2(t) + v_I^2(t) + v_E^2(t) \quad \dots (5.2.2)$$

Where,

$v_{shot}(t)$  is quantum or shot noise.

$v_R(t)$  is thermal or Johnson noise.

$v_I(t)$  is resulted by amplifier input noise current source  $i_a(t)$ .

$v_E(t)$  is requested by amplifier input voltage noise source  $e_a(t)$ .

- The mean square noise voltage is expressed as –

$$\langle v_N^2 \rangle = \langle v_{shot}^2(t) \rangle + \langle v_R^2(t) \rangle + \langle v_I^2(t) \rangle + \langle v_E^2(t) \rangle \quad \dots (5.2.3)$$

- i) **Thermal noise of load resistor  $R_b$  :**

$$\langle v_R^2(t) \rangle = \frac{4k_B T}{R_b} \cdot B_{bae} R^2 A^2 \quad \dots (5.2.4)$$

Where,

$k_B T$  is product of Boltzmann's constant and temperature.

$A$  is amplifier gain.

$B_{bae}$  is noise equivalent BW.

- ii) **Thermal noise due to amplifier input noise current source  $i_a(t)$  :**

$$\langle v_I^2(t) \rangle = S_I B_{bas} R^2 A^2 \quad \dots (5.2.5)$$

Where,

$S_I$  is the spectral density of amplifier input noise current source.

**iii) Thermal noise due to amplifier input noise voltage source  $e_a(t)$  :**

$$\langle v_E^2(t) \rangle = S_E B_e A^2 \quad \dots (5.2.6)$$

Where,

$S_E$  is the spectral density of amplifier noise voltage source.

$B_e$  is noise equivalent BW of amplifier.

**iv) Mean square shot noise :**

$$\langle v_{shot}^2(t) \rangle = 2q \langle i_0 \rangle \langle m^2 \rangle B_{bas} R^2 A^2 \quad \dots (5.2.7)$$

Where,

$\langle m^2 \rangle$  is mean square avalanche gain.

$\langle i_0 \rangle$  is photocurrent.

- All constituents of mean square noise voltage are summarized here.

$$\langle v_R^2(t) \rangle = \frac{4k_B T}{R_b} \cdot B_{bas} R^2 A^2$$

$$\langle v_I^2(t) \rangle = S_I B_{bas} R^2 A^2$$

$$\langle v_E^2(t) \rangle = S_E B_e A^2$$

$$\langle v_{shot}^2(t) \rangle = 2q \langle i_0 \rangle \langle m^2 \rangle B_{bas} R^2 A^2$$

$$\langle v_N^2 \rangle = \langle v_{shot}^2(t) \rangle + \langle v_R^2(t) \rangle + \langle v_I^2(t) \rangle + \langle v_E^2(t) \rangle$$

### 5.3 Receiver Sensitivity

- To calculate optical receiver sensitivity, total noise in the receiver is calculated.

Substituting these values and solving equation (5.2.3) gives

$$B_{bae} = \frac{I_2}{T_b} = I_2 B$$

and

$$B_e = I_2 B + (2\pi C)^2 I_3 B^3$$

Substituting these values and solving equation (5.2.3) gives

$$\begin{aligned} \langle v_N^2 \rangle = R^2 A^2 \left( 2q(i_0)M^{2+x} + \frac{4k_B T}{R_b} + S_1 + \frac{S_E}{R^2} \right) I_2 B \\ + (2\pi C)^2 A^2 S_E I_3 B^3 \end{aligned} \quad \dots (5.3.1)$$

$$\langle v_N^2 \rangle = (qRAB)^2 (2q(i_0)M^{2+x} T_b I_2 + W) \quad \dots (5.3.2)$$

Where,

$$W = \frac{1}{q^2 B} \left( S_1 + \frac{4k_B T}{R_b} + \frac{S_E}{R^2} \right) I_2 + \frac{2\pi C^2}{q} S_E I_3 B \quad \dots (5.3.3)$$

This equation is known as thermal noise characteristic of an optical receiver.

- The optimum gain to achieve desired BER for receiver is given by –

$$M_{opt}^{1+x} = \frac{2W^{1/2}}{xQI_2} \pi \Gamma^2 \quad \dots (5.3.4)$$

Assuming no ISI i.e.  $\gamma = 1$

Where,

Q is parameter related so S/N ratio to achieve desired BER.

W is thermal noise characteristic of receiver. X is photodiode factor.

I2 is normalized BW.

Mean Square Input Noise Current

- The mean square input noise current is gives as –

$$\langle i_N^2 \rangle = \langle i_S^2 \rangle + \langle i_R^2 \rangle + \langle i_I^2 \rangle + \langle i_E^2 \rangle \quad \dots (5.3.5)$$

i) Shot noise Current :



$$\langle i_S^2 \rangle = 2q\langle i_0 \rangle \langle m^2 \rangle A^2 I_2 B$$

ii) Thermal Noise :

$$\langle i_R^2 \rangle = \frac{4k_B T}{R_b} A^2 I_2 B$$

iii) Shunt Noise :

$$\langle i_I^2 \rangle = S_1 A^2 I_2 B$$

iv) Series Noise :

$$\langle i_E^2 \rangle = S_E A^2 \left[ \frac{I_2 B}{R^2} + (2\pi C)^2 I_3 B^3 \right]$$

v) Total Noise:

$$\langle i_N^2 \rangle = \langle i_S^2 \rangle + \langle i_R^2 \rangle + \langle i_I^2 \rangle + \langle i_E^2 \rangle$$

$$\langle i_N^2 \rangle = A^2 (2q\langle i_0 \rangle \langle m^2 \rangle I_2 B + q^2 W B^2) \quad \dots (5.3.6)$$

$$\langle i_N^2 \rangle = \left( S_1 + \frac{S_E}{R_m^2} \right) B I_2 + (2\pi C)^2 S_E B^3 I_3 \quad \dots (5.3.7)$$

**Example 5.3.1** : An InGaAs PIN photodiode has the following parameters at a wavelength of 1300 nm :  $I_D = 4$  nA,  $\eta = 0.9$ ,  $R_L = 1000 \Omega$  and the surface leakage current is negligible. The incident optical power is 300 nW (- 35 dBm) and the receiver bandwidth is 20 MHz. Find the various noise terms of the receiver.

Solution : Given :

$$\lambda = 1300 \text{ nm}$$

$$I_D = 4 \text{ nA}$$

$$\eta = 0.9$$

$$R_L = 1000 \Omega$$

$$P_{\text{incident}} = 300 \text{ nW}$$

$$B = 20 \text{ MHz}$$

Mean square quantum noise current

$$I_q^2 = \sqrt{\frac{q \cdot P_{\text{incident}} \eta}{h\nu}} = \sqrt{\frac{q \cdot P_{\text{incident}} \cdot \eta \cdot \lambda}{hc}}$$

$$I_q^2 = \sqrt{\frac{(1.69 \times 10^{-19})(300 \times 10^{-9})(0.9)(1300 \times 10^{-9})}{(6.626 \times 10^{-34})(3 \times 10^8)}}$$

$$I_q^2 = 2.23 \times 10^{11} \text{ Amp}$$

... Ans.

Mean square dark current

$$I_d^2 = 2eBI_D$$

$$= 2(1.6 \times 10^{-19})(20 \times 10^6)(4 \times 10^{-9})$$

$$= 0.256 \times 10^{-19} \text{ Amp}$$

... Ans.

Mean square thermal noise current

$$I_t^2 = \frac{4kTB}{R_L}$$

Where B is Boltzman constant =  $1.38 \times 10^{-23}$  J/K

$$T = (25 + 273) = 298 \text{ K}$$

$$I_t^2 = \frac{4 \times (1.38 \times 10^{-23}) \times (298) (20 \times 10^6)}{1000}$$

$$= 3.28 \times 10^{-16} \text{ Amp}$$

... Ans.

## 5.4 Analog Receivers

- Fiber optic transmission also supports analog links i.e. voice channels. The performance of analog receiver is measured in terms of S/N ratio (ratio of mean square signal current to mean square noise current).
- The current generated at optical receiver by analog optical signal is given as –

$$i_s(t) = \mathfrak{R}_0 M P_r [1 + ms(t)]$$

$$i_s(t) = I_p M [1 + ms(t)]$$

... (5.4.1)

Where,

$\mathfrak{R}_0$  is responsivity.

M is photodetector gain.

$P_r$  is average received power.

$I_p$  is primary photocurrent ( $= \mathfrak{R}_0 P_r$ )

- Mean – square signal current at photodetector, neglecting d.c. term is

$$\langle i_s^2 \rangle = \frac{1}{2} (\mathfrak{R}_0 M_m P_r)^2$$

$$\langle i_s^2 \rangle = \frac{1}{2} (M_m I_p)^2 \quad \dots (5.4.2)$$

- For a photodiode detector mean noise current is sum of
  - i) Mean square quantum noise current.
  - ii) Equivalent resistance thermal noise current.
  - iii) Dark noise current.
  - iv) Surface leakage noise current..

$$\langle i_N^2 \rangle = 2q(I_p + I_D)M^2F(M)B + 2qI_L B + \frac{4k_B T B}{R_{eq}} F_t$$

Where,

$I_p$  is primary photocurrent.

$I_D$  is primary dark current.

$I_L$  is surface leakage current.

F (M) is photodiode noise factor.

B is effective noise BW.

$R_{eq}$  is equivalent resistance of photodetector and amplifier.

$F_t$  is noise figure of baseband amplifier.

- Signal – to – noise ratio (S/N ratio) is given as –

$$\frac{S}{N} = \frac{i_s^2}{i_N^2} = \frac{m^2 \mathfrak{R}_0 P_r}{4q B} \quad \dots (5.4.3)$$

This limits the sensitivity of analog receiver.

S/N ratio for PIN and APD receiver as a function of received optical power is shown in Fig. 5.4.1.

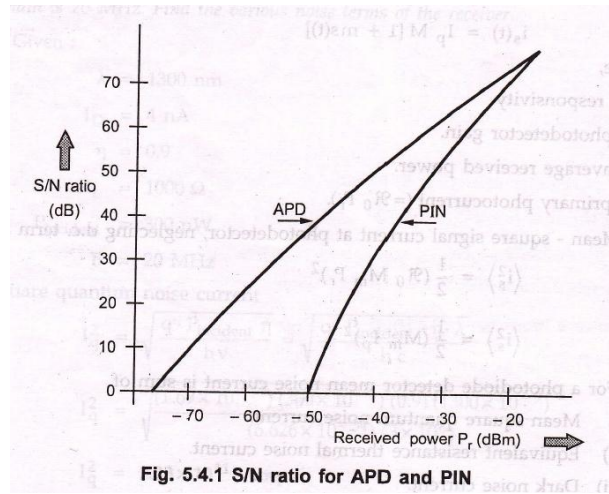

Fig. 5.4.1 S/N ratio for APD and PIN

## 5.5 Digital Receivers

- The equalizer signal is compared with a threshold level to determine the presence of a pulse. The comparison is done on time slot basis.

### Probability of Error

- Bit error rate (BER) is defined as the ratio of number of errors occurring over a time interval to the number of pulses transmitted during the interval.

$$\text{BER} = \frac{N_e}{N_t} \quad \dots (5.5.1)$$

$$\text{BER} = \frac{N_e}{Bt} \quad \dots (5.5.2)$$

Where,

$N_e$  is number of errors occurring during the interval.

$N_t$  is number of pulses transmitted during the interval.

$B$  is bit rate  $\left(\frac{1}{T_b}\right)$  or pulse transmission rate.

- BER for optical fiber communication system is ranging between  $10^{-9}$  to  $10^{-12}$ . BER of receiver depends on S/N ratio. To compute the BER at receiver probability distribution of output signal is considered.
- Conditional PDF :  $P(y/x)$  is the probability that the output voltage is  $y$  when  $x$  was transmitted. The functions  $p(y/1)$  and  $p(y/0)$  are conditional PDF as shown in Fig. 5.5.1.

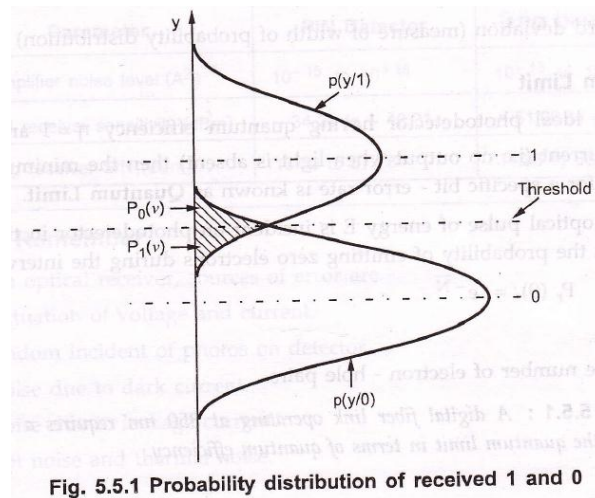

- The probability distributions are given as –

$$P_1(v) = \int_{-\infty}^v p(y/1) dy$$

It is the probability that output voltage is less than threshold when logic '1' is sent.

$$P_0(v) = \int_v^{\infty} p(y/1) dy$$

It is the probability that output voltage exceeds threshold voltage when a logic '0' is sent.

The error probability is expressed as

$$P_e = aP_1(v) + bP_0(v) \quad \dots (5.5.3)$$

Where,

$a$  and  $b$  are probabilities that either 1 or 0 occurs.

$$P_e = \frac{1}{2} \left[ 1 - \operatorname{erf} \left( \frac{V}{2\sqrt{2}\sigma} \right) \right] \quad \dots (5.5.4)$$

Where,

V is the pulse amplitude.

$\sigma$  is standard deviation (measure of width of probability distribution)

### Quantum Limit

- For an ideal photodetector having quantum efficiency  $\eta = 1$  and has zero dark current (i.e. no output when light is absent) then the minimum received power for a specific bit – error rate is known as Quantum Limit.
- Let an optical pulse of energy E is incident on photoetector in time interval  $\tau$ . Then the probability of emitting zero electrons during the interval is

$$P_e(0) = e^{-N} \quad \dots (5.5.5)$$

Where,

XXXX is average number of electron – hole pairs.

**Example 5.5.1** : A digital fiber link operating at 850 nm requires a BER of  $10^{-9}$ . Calculate the quantum limit in terms of quantum efficiency.

Solutions :  $\lambda = 850 \text{ nm} = 850 \times 10^{-9} \text{ m}$

$$\text{BER} = 10^{-9}$$

Probability of error

$$P_r(0) = e^{-N} = 10^{-9}$$

$$\therefore N = 9 \ln 10$$

$$N = 20.7$$

No. of electron – hole pair generated (XXXX), quantum efficiency ( $\eta$ ), photo energy ( $h\nu$ ) and energy received (E) are related by,

$$N = \frac{\eta E}{h\nu}$$

$$\therefore E = N \cdot \frac{h\nu}{\eta}$$

$$E = 20.7 \times \frac{h\nu}{\eta}$$

### Comparison of Receiver Performance

Parameter	PIN Detecor	APD Detector
Preamplifier noise level ( $A^2$ )	$10^{-15}$ to $10^{-18}$	$10^{-15}$ to $10^{-18}$
Digital receiver sensitivity (dBm)	-34.21 to -49.21	-51.00 to -51.65
Analog receiver S/N (dBm)	13.00 to 37.78	34.36 to 38.27

### Review Questions

1. In an optical receiver explain the sources of errors.
2. Deduce the expression for mean output current from photodiode.
3. For a digital optical receiver find the expression of probability of error.
4. Find the expression for mean square noise voltage for optical receiver. University Questions

## UNIT - 6

### ANALOG AND DIGITAL LINKS

Analog links – Introduction, overview of analog links, CNR, multichannel transmission techniques, RF over fiber, key link parameters, Radio over fiber links, microwave photonics.

Digital links – Introduction, point-to-point links, System considerations, link power budget, resistive budget, short wave length band, transmission distance for single mode fibers, Power penalties, nodal noise and chirping.

#### RECOMMENDED READINGS:

#### TEXT BOOKS:

1. **Optical Fiber Communication** – Gerd Keiser, 4<sup>th</sup> Ed., MGH, 2008.
2. **Optical Fiber Communications**– – John M. Senior, Pearson Education. 3<sup>rd</sup> Impression, 2007.

#### REFERENCE BOOK:

1. **Fiber optic communication** – Joseph C Palais: 4<sup>th</sup> Edition, Pearson Education.



## 6.1 Analog Links

### Overview of Analog Links

- Elements of analog links are,
  - i) Optical transmitter.
  - ii) Fiber channel.
  - iii) Optical amplifier.
  - iv) Optical detector.

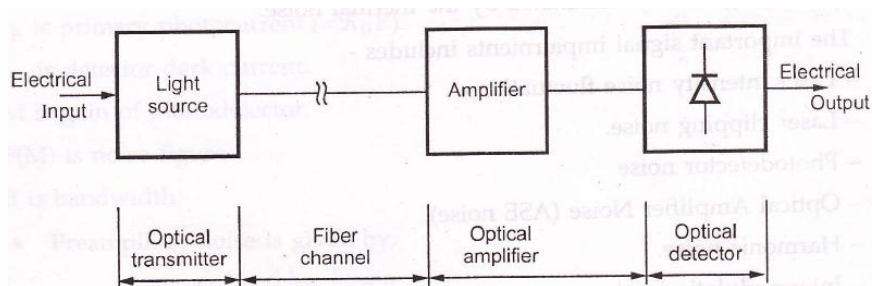

Fig. 6.1.1 Analog link elements

- The incoming information signal, speech, music video etc. is used to control the power output from the LED or the laser. The light output is as near as possible, a true copy of the electrical variations at the input. At the far end of the fiber, the receiver converts the light back to electrical pulses which is the true replica of input signal.
- Any non-linearity either in transmitter or receiver will affect the accuracy of the transmission or reception of signal.
- The other problem is noise. Since the receiver received an analog signal, it must be sensitive to any changes in amplitude. Any random fluctuations in light level caused by light source, the fiber at the receiver will cause unwanted noise in the output signal.
- Electrical noise due to lightening will give rise to electrical noise in the non-fiber parts of the system.
- As the signal travels along the fiber, it is attenuated. To restore signal amplitude, amplifiers (repeaters) are added at regular intervals. The repeater has a limited ability to reduce noise and distortion present.

### Carrier – to – Noise Ratio (CNR)

- Carrier – to – Noise Ratio (CNR) is defined as the ratio of r.m.s. carrier power to r.m.s. noise power at the receiver.
- CNR requirement can be relaxed by changing the modulation format from AM to FM. The BW of FM carrier is considerably larger (30 MHz in place of 4 MHz). The required

CNR for FM receiver is much lower (16 dB compared to 50 dB in AM) because of FM advantage. As a result, the optical power needed at the receiver can be small as 10  $\mu$ W. But the receiver noise of FM system is generally dominated by the thermal noise.

- The important signal impairments includes –
  - Laser intensity noise fluctuations.
  - Laser clipping noise.
  - Photodetector noise.
  - Optical Amplifier Noise (ASE noise).
  - Harmonic noise.
  - Intermodulation noise.
  - Shot noise.

### Carrier Power

- To calculate carrier power signal generated by optical source is considered. The optical source is a square law device and current flowing through optical source is sum of fixed bias current and a time varying current (analog signal).
- If the time-varying analog drive signal is  $s(t)$ , then the instantaneous optical output power is given by,

$$P(t) = P_t[1 + m s(t)] \quad \dots (6.1.1)$$

where

$P_t$  is optical output power at bias level,

$M$  is modulation index =  $\left(\frac{P_{peak}}{P_t}\right)$

- The received carrier power  $C$  is given by,

$$C = \frac{1}{2}(m \mathfrak{R}_0 MP)^2 \quad \dots (6.1.2)$$

where,

$\mathfrak{R}_0$  is responsivity of photodetector.

$M$  is gain of photodetector.

$P$  is average received optical power.

### Photodetector and Preamplifier Noises

- Photodetector noise is given by,

$$\langle i_N^2 \rangle = 2q (I_p + I_D) M^2 F(M)B \quad \dots (6.1.3)$$

where,

$I_p$  is primary photocurrent ( $= \mathfrak{R}_0 P$ ).

$I_D$  is detector dark current.

$M$  is gain of photodetector.

$F(M)$  is noise figure.

$B$  is bandwidth.

- Preamplifier noise is given by,

$$\langle i_N^2 \rangle = \frac{4k_B T}{R_{eq}} \cdot B F_t \quad \dots (6.1.4)$$

where,

$R_{eq}$  is equivalent resistance.

$F_t$  is noise factor of preamplifier.

### Relative Intensity Noise (RIN)

- The output of a semiconductor laser exhibits fluctuations in its intensity, phase and frequency even when the laser is biased at a constant current with negligible current fluctuations. The two fundamental noise mechanisms are
  - i) Spontaneous emission and
  - ii) Electron-hole recombination (shot noise).
- Noise in semiconductor lasers is dominated by spontaneous emission. Each spontaneously emitted photon adds to the coherent field a small field component whose phase is random, and thus deviate both amplitude and phase in random manner. The noise resulting from the random intensity fluctuations is called **Relative Intensity Noise (RIN)**. The resulting mean-square noise current is given by,

$$\langle i_R^2 \rangle = RIN (\mathfrak{R}_0 P) B \quad \dots (6.1.5)$$

- RIN is measured in dB/Hz. Its typical value DFB Lasers is ranging from -152 to -158 dB/Hz.

### Reflection Effects on RIN

- The optical reflections generated within the systems are to be minimized. The reflected signals increases the RIN by 10 – 20 dB. Fig. 6.1.2 shows the effect on RIN due to change in feedback power ratio.

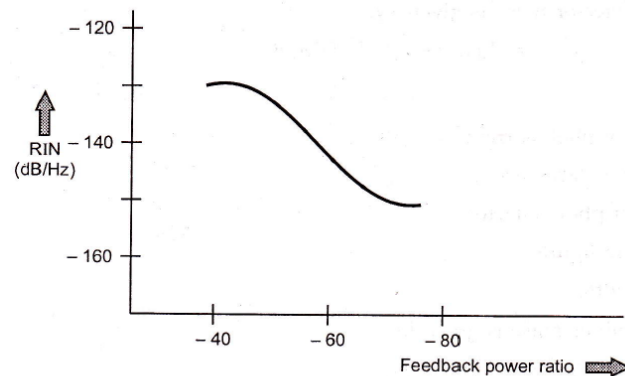

Fig. 6.1.2 Feedback power ratio (dB)

- The feedback power ratio is the amount of optical power reflected back to the light output from source. The feedback power ratio must be less than -60 dB to maintain RIN value less than -140 dB/Hz.

### Limiting Conditions

- When optical power level at receiver is low, the preamplifier noise dominates the system noise.
- The quantum noise of photodetector also dominates the system noise.
- The reflection noise also dominates the system noise.
- The carrier-to-noise ratio for all three limiting conditions are shown in talbe.
- Fig. 6.1.3 shows carriers-to-noise ratio as a function of optical power level at the receiver with limiting factors. For low light levels, thermal noise is limiting factor causes 2 dB roll of in C/N for each 1 dB drop in received power. At intermediate levels, quantum noise is limiting, factor causing 1 dB drop in C/N for every 1 dB decrease in received optical power. At high received power source noise is dominator factor gives a constant C/N.

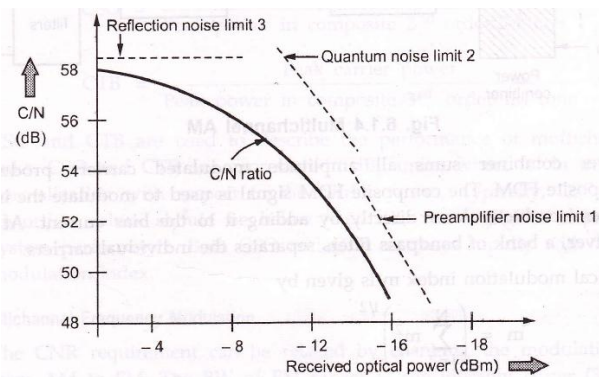

Fig. 6.1.3 C/N ratio as a function of received optical power

### Multichannel Transmission Techniques

- Multiplexing technique is used to transmit multiple analog signals over the same higher capacity fiber cable.
- Number of baseband signals are superimposed on a set of  $N$  sub-carrier of frequencies  $f_1, f_2, f_3 \dots f_N$ .
- Channel or signal multiplexing can be done in the time or frequency domain through Time-Division Multiplexing (TDM) and Frequency Division Multiplexing (FDM). The methods of multiplexing includes Vestigial Sideband Amplitude Modulation (VSB-AM), frequency Modulation (FM) and Sub-Carrier Multiplexing (SCM). All the schemes have different advantages and disadvantages.

### Multichannel Amplitude Modulation

- In some applications the bit rate of each channel is relatively low but the number of channels are quite large. Typical example of such application is cable television (CATV). Fig. 6.1.4 shows the technique for combining  $N$  independent channels. Different channel information are amplitude modulated on different carrier frequencies.

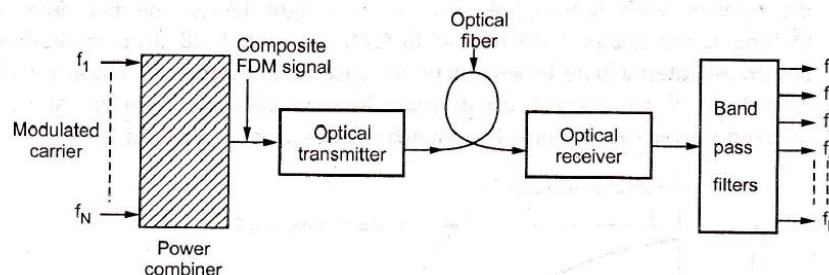

Fig. 6.1.4 Multichannel AM

- Power combiner sums all amplitude modulated carriers producing a composite FDM. The composite FDM signal is used to modulate the intensity of semiconductor laser directly by adding it to the bias current. At optical receiver, a bank of bandpass filters separates the individual carriers.
- Optical modulation index  $m$  is given by

$$m = \left( \sum_{i=1}^N m_i^2 \right)^{1/2}$$

where,

$N$  is no. of channels

$m_i$  is per channel modulation index

- Since the laser diode is a non-linear device and when multiple carrier frequencies pass through such device, the analog signal is distorted during its transmission, the distortion is referred to as intermodulation distortion (IMD). The IMD causes undesirable signals to produce called intermodulation product (IMP). The new frequencies (IMPs) are further classified as
  - Two-tone IMPs and
  - Triple-beat IMPs.

The classification is depending on whether two frequencies coincide or all three frequencies are distinct.

- The triple-beat IMPs tend to be a major source of distortion because of their large number. An  $N$ -channel system generates  $N(N-1)(N-2)/2$  triple-beat terms compared with  $N(N-1)$  two-tone terms. Depending on channel carrier spacing some of IMPs fall within the bandwidth of a specific channel and affect the signal recovery. This is called as beat-stacking.
- The beat stacking result in two types of distortions, which adds power for all IMPs that fall within the passband of a specific channel, these distortions are:
  - i) Composite Second Order (CSO) and
  - ii) Composite Triple Beat (CTB)

$$CSO = \frac{\text{Peak carrier power}}{\text{Peak power in composite 2<sup>nd</sup> order IM tone}}$$

$$CTB = \frac{\text{Peak carrier power}}{\text{Peak power in composite 3<sup>rd</sup> order IM tone}}$$

- CSO and CTB are used to describe the performance of multichannel An links. CSO and CTD are expressed in dBc units, where 'c' in dB<sub>c</sub> denotes normalization with respect to the carrier power. Typically, CSO and CTB distortion values should be below – 60 dB<sub>c</sub> for negligible impact on the system performance. Both CSO and CTB increases rapidly with increase in modulation index.

### Multichannel Frequency Modulation

- The CNR requirement can be relaxed by changing the modulation format from AM to FM. The BW of FM carrier is considerably larger (30 MHz in place of 4 MHz). This results in S/N ratio improvement over C/N ratio.
- S/N ratio at the output of FM detector is :

$$\left(\frac{S}{N}\right)_{\text{out}} = \left(\frac{C}{N}\right)_{\text{in}} + 10 \log \left[ \frac{3B}{2f_v} \left( \frac{\Delta f_{pp}}{f_v} \right)^2 \right] + w \dots$$

where,

B is required bandwidth.

$\Delta f_{pp}$  is peak to peak frequency deviation of modulator.

$f_v$  is highest video frequency.

W is weighing factor for white noise.

- The total S/N improvement is ranging between 36-44 dB.

### Sub-Carrier Multiplexing (SCM)

- Sub-Carrier Multiplexing (SCM) is employed in microwave engineering in which multiple microwave carriers for transmission of multiple channels are used. If the microwave signal is transmitted optically by using optical fibers, the signal bandwidth can be exceeded up to 10 GHz for a single optical carrier. Such a scheme is referred to as SCM. Since multiplexing is done by using microwave sub-carrier rather than the optical carrier.
- The input can be analog or digital baseband signal. The input signals are modulated sub-carriers are then combined to give FDM signal. The FDM signals are then combined in microwave combiner. The combine signal is then modulates the intensity of semiconductor laser by adding it to bias current. Fig. 6.1.5 shows this arrangement.

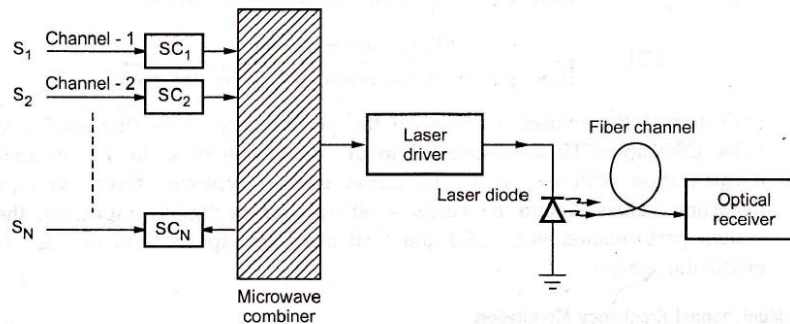

**Fig. 6.1.5 Sub-carrier multiplexing**

- The received optical signal is then passed through low noise pin photodetector to convert it to original signal.

### Advantages of SCM

1. Wide bandwidth.
2. Flexibility and upgradability in design of broadband networks.
3. Analog or digital modulation or combination of two for transmitting multiple voice, data and video signals to large number of users.
4. Both AM and FM techniques can be used for SCM.
5. A combination of SCM and WDM can realize DW upto 1 MHz.
6. SCM technique is also being explored for network management and performance monitoring.

## 6.2 Digital Links

### System Design Considerations

- In optical system design major consideration involves
  - Transmission characteristics of fiber (attenuation & dispersion).
  - Information transfer capability of fiber.
  - Terminal equipment & technology.
  - Distance of transmission.
- In long-haul communication applications repeaters are inserted at regular intervals as shown in Fig. 6.2.1



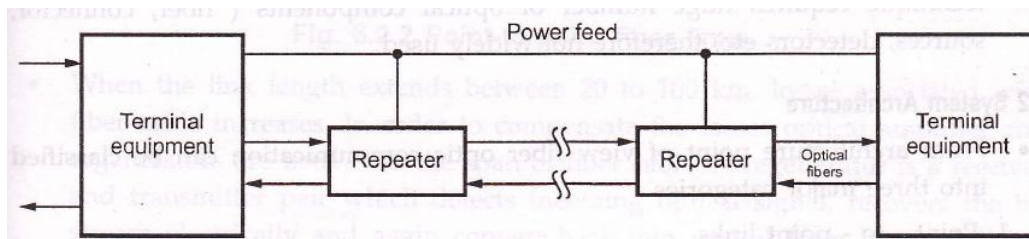

**Fig. 6.2.1 Repeaters in long-haul communication system**

- Repeater regenerates the original data before it is retransmitted as a digital optical signal. The cost of system and complexity increases because of installation of repeaters.
- An optical communication system should have following basic required specifications –
  - a) Transmission type (Analog / digital).
  - b) System fidelity (SNR / BER)
  - c) Required transmission bandwidth
  - d) Acceptable repeater spacing
  - e) Cost of system
  - f) Reliability
  - g) Cost of maintenance.

### Multiplexing

- Multiplexing of several signals on a single fiber increases information transfer rate of communication link. In Time Division Multiplexing (TDM) pulses from multiple channels are interleaved and transmitted sequentially, it enhance the bandwidth utilization of a single fiber link.
- In Frequency Division Multiplexing (FDM) the optical channel bandwidth is divided into various nonoverlapping frequency bands and each signal is assigned one of these bands of frequencies. By suitable filtering the combined FDM signal can be retrieved.
- When number of optical sources operating at different wavelengths are to be sent on single fiber link Wavelength Division Multiplexing (WDM) is used. At receiver end, the separation or extraction of optical signal is performed by optical filters (interference filters, diffraction filters prism filters).
- Another technique called Space Division Multiplexing (SDM) used separate fiber within fiber bundle for each signal channel. SDM provides better optical isolation which eliminates cross-coupling between channels. But this technique requires huge number of optical components (fiber, connector, sources, detectors etc) therefore not widely used.

## System Architecture

- From architecture point of view fiber optic communication can be classified into three major categories.
  1. Point – to – point links
  2. Distributed networks
  3. Local area networks.

## Point-to-Point Links

- A point-to-point link comprises of one transmitter and a receiver system. This is the simplest form of optical communication link and it sets the basis for examining complex optical communication links.
- For analyzing the performance of any link following important aspects are to be considered.
  - a) Distance of transmission
  - b) Channel data rate
  - c) Bit-error rate
- All above parameters of transmission link are associated with the characteristics of various devices employed in the link. Important components and their characteristics are listed below.

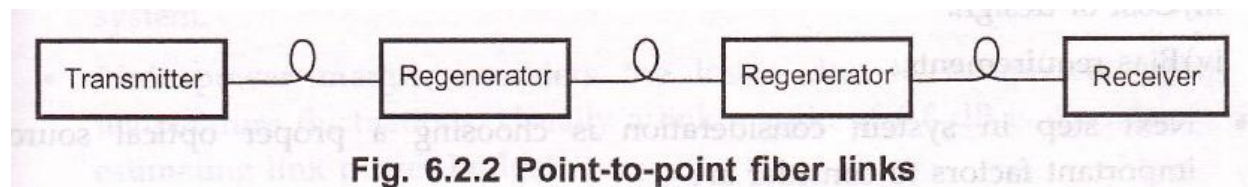

**Fig. 6.2.2 Point-to-point fiber links**

- When the link length extends between 20 to 100 km, losses associated with fiber cable increases. In order to compensate the losses optical amplifier and regenerators are used over the span of fiber cable. A regenerator is a receiver and transmitter pair which detects incoming optical signal, recovers the bit stream electrically and again convert back into optical from by modulating an optical source. An optical amplifier amplify the optical bit stream without converting it into electrical form.
- The spacing between two repeater or optical amplifier is called as repeater spacing (L). The repeater spacing L depends on bit rate B. The bit rate-distance product (BL) is a measure of system performance for point-to-point links.
- Two important analysis for deciding performance of any fiber link are –
  - i) Link power budget / Power budget
  - ii) Rise time budget / Bandwidth budget

- The Link power budget analysis is used to determine whether the receiver has sufficient power to achieve the desired signal quality. The power at receiver is the transmitted power minus link losses.
- The components in the link must be switched fast enough and the fiber dispersion must be low enough to meet the bandwidth requirements of the application. Adequate bandwidth for a system can be assured by developing a rise time budget.

### **System Consideration**

- Before selecting suitable components, the operating wavelength for the system is decided. The operating wavelength selection depends on the distance and attenuation. For shorter distance, the 800-900 nm region is preferred but for longer distance 100 or 1550 nm region is preferred due to lower attenuations and dispersion.
- The next step is selection of photodetector. While selecting a photodetector following factors are considered –
  - i) Minimum optical power that must fall on photodetector to satisfy BER at specified data rate.
  - ii) Complexity of circuit.
  - iii) Cost of design.
  - iv) Bias requirements.
- Next step in system consideration is choosing a proper optical source, important factors to consider are –
  - i) Signal dispersion.
  - ii) Data rate.
  - iii) Transmission distance.
  - iv) Cost.
  - v) Optical power coupling.
  - vi) Circuit complexity.
- The last factor in system consideration is to selection of optical fiber between single mode and multimode fiber with step or graded index fiber. Fiber selection depends on type of optical source and tolerable dispersion. Some important factors for selection of fiber are :
  - i) Numerical Aperture (NA), as NA increases, the fiber coupled power increases also the dispersion.
  - ii) Attenuation characteristics.
  - iii) Environmental induced losses e.g. due to temperature variation, moisture and dust etc.

## Link Power Budget

- For optimizing link power budget an optical power loss model is to be studied as shown in Fig. 6.2.3. Let  $l_c$  denotes the losses occur at connector.  
 $L_{sp}$  denotes the losses occur at splices.  
 $\alpha_f$  denotes the losses occur in fiber.

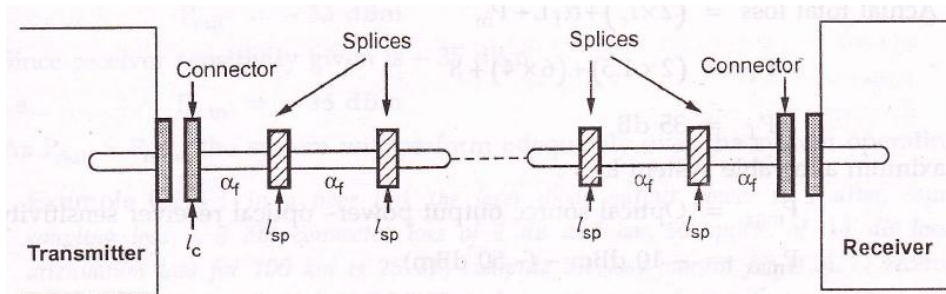

Fig. 6.2.3 Optical power loss model

- All the losses from source to detector comprises the total loss ( $P_T$ ) in the system.
- Link power margin considers the losses due to component aging and temperature fluctuations. Usually a link margin of 6-8 dB is considered while estimating link power budget.
- Total optical loss = Connector loss + (Splicing loss + Fiber attenuation) + System margin ( $P_m$ )

$$P_T = 2l_c + \alpha_f L + \text{System margin } (P_m)$$

where,  $L$  is transmission distance.

**Example 6.2.1 :** Design an optical fiber link for transmitting 15 Mb/sec of data for a distance of 4 km with BER of  $10^{-9}$ .

**Solution :**

$$\text{Bandwidth} \times \text{Length} = 15 \text{ Mb/sec} \times 4 \text{ km} = (60 \text{ Mb/sec}) \text{ km}$$

**Selecting optical source :** LED at 820 nm is suitable for short distances. The LED generates – 10 dBm optical power.

**Selecting optical detector :** PIN-FER optical detector is reliable and has – 50 dBm sensitivity.

**Selection optical fiber :** Step-index multimode fiber is selected. The fiber has bandwidth length product of 100 (Mb/s) km.

**Links power budget :**

Assuming :

Splicing loss  $l_s = 0.5$  dB/slice

Connector loss  $l_c = 1.5$  dB

System link power margin  $P_m = 8$  dB

Fiber attenuation  $\alpha_f = 6$  dB/km

Actual total loss =  $(2 \times l_c) + \alpha_f L + P_m$

$$P_T = (2 \times 1.5) + (6 \times 4) + 8$$

$$P_T = 35 \text{ dB}$$

Maximum allowable system loss :

$$P_{\max} = \text{Optical source output power} - \text{optical receiver sensitivity}$$

$$P_{\max} = -10 \text{ dBm} - (-50 \text{ dBm})$$

$$P_{\max} = 40 \text{ dBm}$$

Since actual losses in the system are less than the allowable loss, hence the system is functional.

**Example 6.2.2 :** A transmitter has an output power of 0.1 mW. It is used with a fiber having NA = 0.25, attenuation of 6 dB/km and length 0.5 km. The link contains two connectors of 2 dB average loss. The receiver has a minimum acceptable power (sensitivity) of -35 dBm. The designer has allowed a 4 dB margin. Calculate the link power budget.

**Solution :**

$$\text{Source power } P_s = 0.1 \text{ mW}$$

$$P_s = -10 \text{ dBm}$$

$$\text{Since } \text{NA} = 0.25$$

$$\begin{aligned}\therefore \text{Coupling loss} &= -10\log(\text{NA}^2) \\ &= -10\log(0.25^2) \\ &= 12 \text{ dB}\end{aligned}$$

$$\text{Fiber loss} = \alpha_f \times L$$

$$l_f = (6\text{dB/km})(0.5\text{km})$$

$$l_f = 3 \text{ dB}$$

$$\text{Connector loss} = 2 \text{ (2 dB)}$$

$$l_c = 4 \text{ dB}$$

$$\text{Design margin } P_m = 4 \text{ dB}$$

$$\therefore \text{Actual output power } P_{\text{out}} = \text{Source power} - (\Sigma \text{ Losses})$$

$$P_{\text{out}} = 10\text{dBm} - [12 \text{ dB} + 3 + 4 + 4]$$

$$P_{\text{out}} = \mathbf{-33 \text{ dBm}}$$

Since receiver sensitivity given is  $-35 \text{ dBm}$ .

$$\text{i.e. } P_{\text{min}} = \mathbf{-35 \text{ dBm}}$$

As  $P_{\text{out}} > P_{\text{min}}$ , the system will perform adequately over the system operating life.

Example 6.2.3 : In a fiber link the laser diode output power is  $5 \text{ dBm}$ , source-fiber coupling loss =  $3 \text{ dB}$ , connector loss of  $2 \text{ dB}$  and has 50 splices of  $0.1 \text{ dB}$  loss. Fiber attenuation loss for  $100 \text{ km}$  is  $25 \text{ dB}$ , compute the loss margin for i) APD receiver with sensitivity  $-40 \text{ dBm}$  ii) Hybrid PINFET high impedance receiver with sensitivity  $-32 \text{ dBm}$ .

### **Solution : Power budget calculations**

Source output power	<b>5 dBm</b>
Source fiber coupling loss	<b>3 dB</b>
Connector loss	<b>2 dB</b>
Connector loss	<b>5 dB</b>
Fiber attenuation	<b>25 dB</b>

Total loss **35 dB**

Available power to receiver : (5 dBm – 35 dBm) – 30 dBm

- i) APD receiver sensitivity – 40 dBm  
Loss margin [- 40 – (- 30)] 10dBm
- ii) H-PIN FET high impedance receiver -32 dBm  
Loss margin [- 32 – (- 30)] 2 dBm

### Rise Time Budget

- Rise time gives important information for initial system design. Rise-time budget analysis determines the dispersion limitation of an optical fiber link.
- Total rise time of a fiber link is the root-sum-square of rise time of each contributor to the pulse rise time degradation.

$$t_{sys} = \sqrt{t_{r1}^2 + t_{r2}^2 + t_{r3}^2 + \dots}$$

$$t_{sys} = \left( \sum_{i=1}^N t_{ri}^2 \right)^{1/2}$$

- The link components must be switched fast enough and the fiber dispersion must be low enough to meet the bandwidth requirements of the application adequate bandwidth for a system can be assured by developing a rise time budget.
- As the light sources and detectors has a finite response time to inputs. The device does not turn-on or turn-off instantaneously. Rise time and fall time determines the overall response time and hence the resulting bandwidth.
- Connectors, couplers and splices do not affect system speed, they need not be accounted in rise time budget but they appear in the link power budget. Four basic elements that contributes to the rise-time are,

Transmitter rise-time (tx)

Group Velocity Dispersion (GVD) rise time (tGVD)

Modal dispersion rise time of fiber (tmod)

- Receiver rise time (trx)

$$t_{sys} = [t_{tx}^2 + t_{mod}^2 + t_{GVD}^2 + t_{rx}^2]^{1/2}$$

... (6.2.1)

- Rise time due to modal dispersion is given as

$$t_{\text{mod}} = \frac{440}{B_M} = \frac{440 Lq}{B_0}$$

... (6.2.2)

where,

$B_M$  is bandwidth (MHz)

$L$  is length of fiber (km)

$q$  is a parameter ranging between 0.5 and 1.

$B_0$  is bandwidth of 1 km length fiber,

- Rise time due to group velocity dispersion is

$$t_{\text{GVD}} = D^2 \sigma_\lambda^2 L^2$$

... (6.2.3)

where,

$D$  is dispersion [ns/(nm.km)]

$\sigma_\lambda$  is half-power spectral width of source

$L$  is length of fiber

- Receiver front end rise-time in nanoseconds is

$$t_{\text{rx}} = \frac{350}{B_{\text{rx}}}$$

... (6.2.4)

where,

$B_{\text{rx}}$  is 3 dB – bW of receiver (MHz).

- Equation (6.2.1) can be written as

$$t_{\text{sys}} = [t_{\text{tx}}^2 + t_{\text{mod}}^2 + t_{\text{GVD}}^2 + t_{\text{rx}}^2]^{1/2}$$

$$t_{\text{sys}} = \left[ t_{\text{tx}}^2 + \left( \frac{440 Lq}{B_0} \right)^2 + D^2 \sigma_\lambda^2 L^2 + \left( \frac{350}{B_{\text{rx}}} \right)^2 \right]^{1/2}$$

... (6.2.5)



All times are in nanoseconds.

- The system bandwidth is given by

$$BW = \frac{0.35}{t_{sys}} \quad \dots (6.2.6)$$

**Example 6.2.4 :** For a multimode fiber following parameters are recorded.

- |      |  |
|------|--|
| i)   | LED with drive circuit has rise time of 15 ns.                               |
| ii)  | LED spectral width = 40 nm   |
| iii) | Material dispersion related rise time degradation =<br>21 ns over 6 km link. |
| iv)  | Receiver bandwidth = 235 MHz   |
| v)   | Modal dispersion rise time = 3.9 nsec  |

Calculate system rise time.

**Solution :**  $t_{tx} = 15 \text{ nsec}$

$$t_{mat} = 21 \text{ nsec}$$

$$t_{mod} = 3.9 \text{ nsec}$$

Now

$$t_{rx} = \frac{350}{B_{rx}}$$

$$\therefore t_{rx} = \frac{350}{25}$$

$$\therefore t_{rx} = 14 \text{ nsec}$$

Since

$$t_{sys} = \left( \sum_{i=1}^N t_{ri}^2 \right)^{1/2}$$

$$t_{sys} = [15^2 + 21^2 + 3.9^2 + 14^2]^{1/2}$$

$$t_{sys} = 29.61 \text{ nsec}$$

... Ans.

**Example 6.2.5 :** A fiber link has following data

Component	BW	Rise time (tr)
Transmitter	200MHz	1.75 nsec
LED (850 nm)	100 MHz	3.50 nsec
Fiber cable	90 MHz	3.89 nsec
PIN detector	350 MHz	1.00 nsec
Receiver	180 MHz	1.94 nsec

Compute the system rise time and bandwidth.

Solution : System rise time is given by

$$t_{sys} = \left( \sum_{i=1}^N t_{ri}^2 \right)^{1/2}$$

$$ct_{sys} = \sqrt{(1.75^2 + 3.5^2 + 3.89^2 + 1.00^2 + 1.94^2)}$$

$$t_{sys} = 5.93 \text{ nsec}$$

... Ans.

System BW is given by

$$BW = \frac{0.35}{t_{sys}}$$

$$BW = \frac{0.35}{5.93 \text{ nsec}}$$

$$BW = 59 \text{ MHz}$$

... Ans.

### Line coding in optical links

- Line coding or channel coding is a process of arranging the signal symbols in a specific pattern. Line coding introduces redundancy into the data stream for minimizing errors.
- In optical fiber communication, three types of line codes are used.
  - Non-return-to-zero (NRZ)
  - Return-to-zero (RZ)
  - Phase-encoded (PE)

### Desirable Properties of Line Codes

The line code should contain timing information.

The line code must be immune to channel noise and interference.

The line code should allow error detection and correction.

### NRZ Codes

- Different types of NRZ codes are introduced to suit the variety of transmission requirements. The simplest form of NRZ code is NRZ-level. It is a unipolar code i.e. the waveform is simple on-off type.
- When symbol '1' is to be transmitted, the signal occupies high level for full bit period. When a symbol '0' is to be transmitted, the signal has zero volts for full bit period. Fig. 6.2.4 shows example of NRZ-L data pattern.

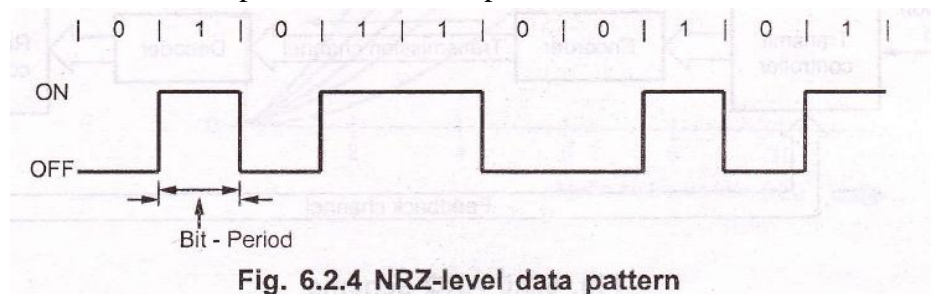

Fig. 6.2.4 NRZ-level data pattern

### Features of NRZ codes

- Simple to generate and decode.
- No timing (self-clocking) information.
- No error monitoring or correcting capabilities.
- NRZ coding needs minimum BW.

## RZ Codes

In unipolar RZ data pattern a 1-bit is represented by a half-period in either first or second half of the bit-period. A 0 bit is represented by zero volts during the bit period. Fig. 6.2.5 shows RZ data pattern.

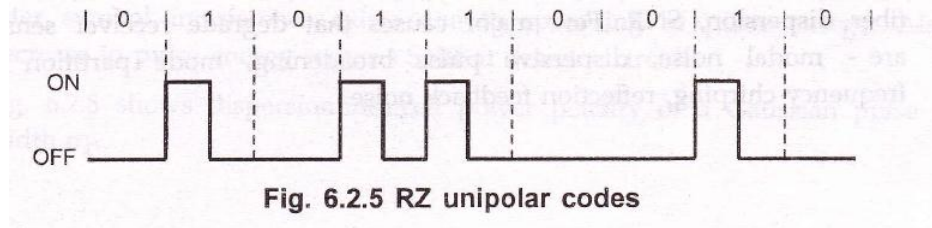

Fig. 6.2.5 RZ unipolar codes

## Features of RZ codes

The signal transition during high-bit period provides the timing information. Long strings of 0 bits can cause loss of timing synchronization.

## Error Correction

The data transmission reliability of a communication system can be improved by incorporating any of the two schemes Automatic Repeat Request (ARQ) and Forward Error Correction (FEC).

In ARQ scheme, the information word is coded with adequate redundant bits so as to enable detection of errors at the receiving end. If an error is detected, the receiver asks the sender to retransmit the particular information word.

Each retransmission adds one round trip time of latency. Therefore ARQ techniques are not used where low latency is desirable. Fig. 6.2.6 shows the scheme of ARQ error correction scheme.

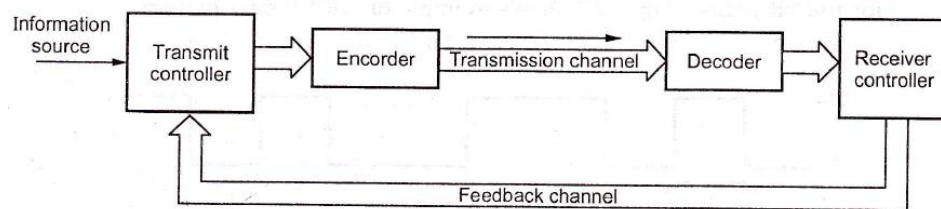

Fig. 6.2.6 ARQ scheme

Forward Error Correction (FEC) system adds redundant information with the original information to be transmitted. The error or lost data is used reconstructed by using

redundant bit. Since the redundant bits to be added are small hence much additional BW is not required.

Most common error correcting codes are cyclic codes. Whenever highest level of data integrity and confidentiality is needed FEC is considered.

### Sources of Power Penalty

Optical receiver sensitivity is affected due to several factors combinely e.g. fiber dispersion, SNR. Few major causes that degrade receiver sensitivity are – modal noise, dispersive pulse broadening, mode partition noise, frequency chirping, reflection feedback noise.

### Modal Noise

In multimode fibers, there is interference among various propagating modes which results in fluctuation in received power. These fluctuations are called modal noise. Modal noise is more serious with semiconductor lasers.

Fig. 6.2.7 shows power penalty at

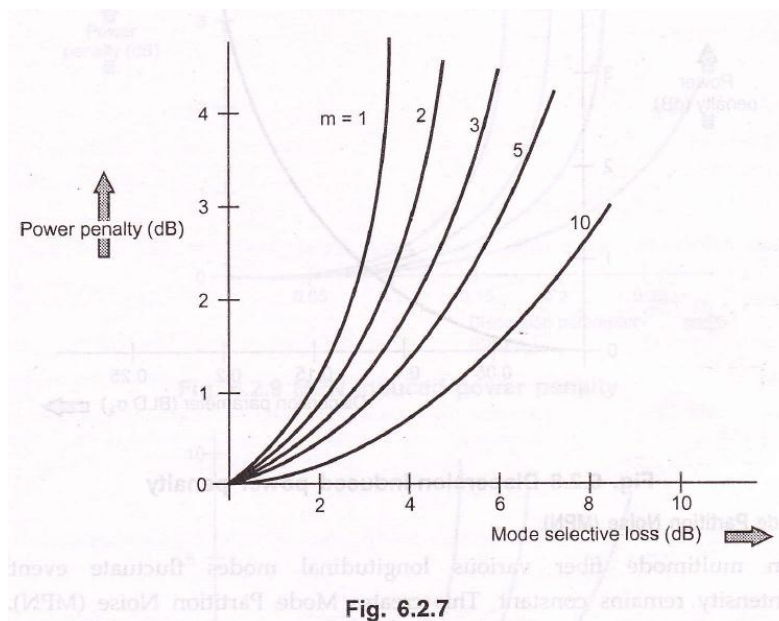

Fig. 6.2.7

$$\text{BER} = 10^{-12}$$

$$\lambda = 1.3 \mu\text{m}$$

$$B = 140 \text{ mb/sec.}$$

Fiber : GRIN (50  $\mu\text{m}$ )

## Dispersive Pulse Broadening

Receiver sensitivity is degraded by Group Velocity Dispersion (GVD). It limits the bit-rate distance product (BL) by broadening optical pulse.

Inter symbol interference exists due to spreading of pulse energy. Also, decrease in pulse energy reduces SNR at detector circuit.

Fig. 6.2.8 shows dispersion-induced power penalty of Gaussian pulse of width  $\sigma_\lambda$ .

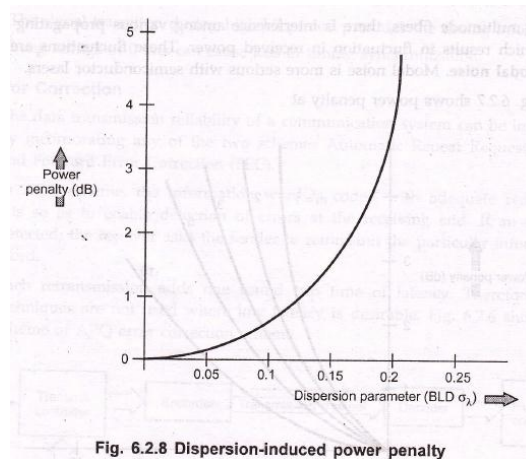

Fig. 6.2.8 Dispersion-induced power penalty

## Mode Partition Noise (MPN)

In multimode fiber various longitudinal modes fluctuate even though intensity remains constant. This creates Mode Partition Noise (MPN). As a result all modes are unsynchronized and creates additional fluctuations and reduces SNR at detector circuit.

A power penalty is paid to improve SNR for achieving desired BER. Fig. 6.2.9 shows power penalty at BER of  $10^{-9}$  as a function of normalized dispersion parameter (BLD  $\sigma_\lambda$ ) for different values of mode partition coefficient (K). (See Fig. 6.2.9 on next page.)

## Frequency Chirping

The change in carrier frequency due to change in refractive index is called frequency chirping. Because of frequency chirp the spectrum of optical pulse gets broaden and degrades system performance.

Fig. 6.2.10 shows power penalty as a function of dispersion parameter BLD  $\sigma_\lambda$  for several values of bit period (Btc).

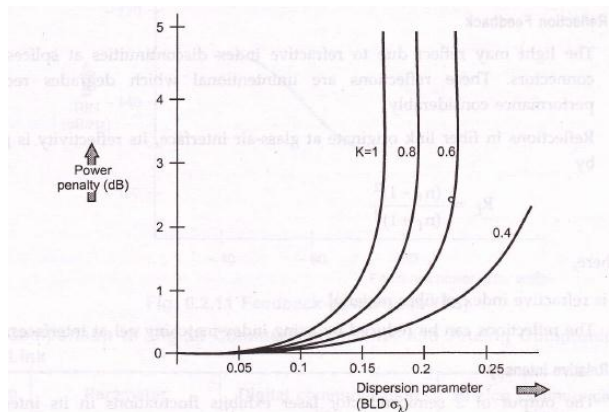

Fig. 6.2.9 MPN induced power penalty

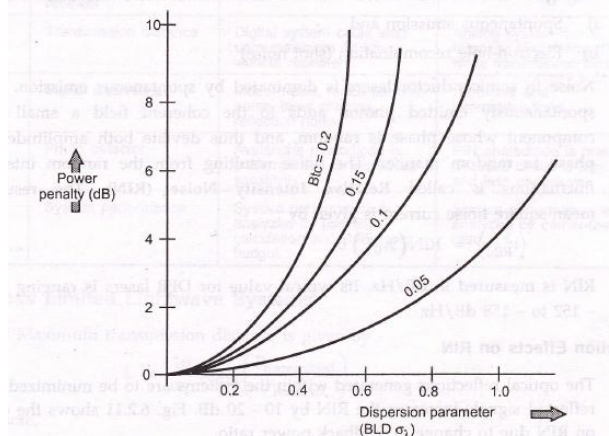

Fig. 6.2.10 Chirp induced power penalty

## Reflection Feedback

The light may reflect due to refractive index discontinuities at splices and connectors. These reflections are unintentional which degrades receiver performance considerably. Reflections in fiber link originate at glass-air interface, its reflectivity is given by

$$R_f = \frac{(n_f - 1)^2}{(n_f + 1)^2}$$

Where,

$n_f$  is refractive index of fiber material.

The reflections can be reduced by using index-matching gel at interfaces.

## Relative Intensity

The output of a semiconductor laser exhibits fluctuations in its intensity, phase and frequency even when the laser is biased at a constant current with negligible current fluctuations. The two fundamental noise mechanisms are

- i) Spontaneous emission and
- ii) Electron-hole recombination (shot noise)

Noise in semiconductor lasers is dominated by spontaneous emission. Each spontaneously emitted photon adds to the coherent field a small field component whose phase is random, and thus deviate both amplitude and phase in random manner. The noise resulting from the random intensity fluctuations is called **Relative Intensity Noise (RIN)**. The resulting mean-square noise current is given by :

$$\langle i_R^2 \rangle = RIN (\mathcal{R}_0 P) B \quad \dots (6.2.7)$$

RIN is measured in dB/Hz. Its typical value for DFB lasers is ranging from -152 to -158 dB/Hz.

## Reflection Effects on RIN

The optical reflection generated within the systems are to be minimized. The reflected signals increases the RIN by 10 – 20 dB. Fig. 6.2.11 shows the effect on RIN due to change in feedback power ratio.

The feedback power ratio is the amount of optical power reflected back to the light output from source. The feedback power ratio must be less than – 60 dB to maintain RIN value less than -140 dB/Hz.



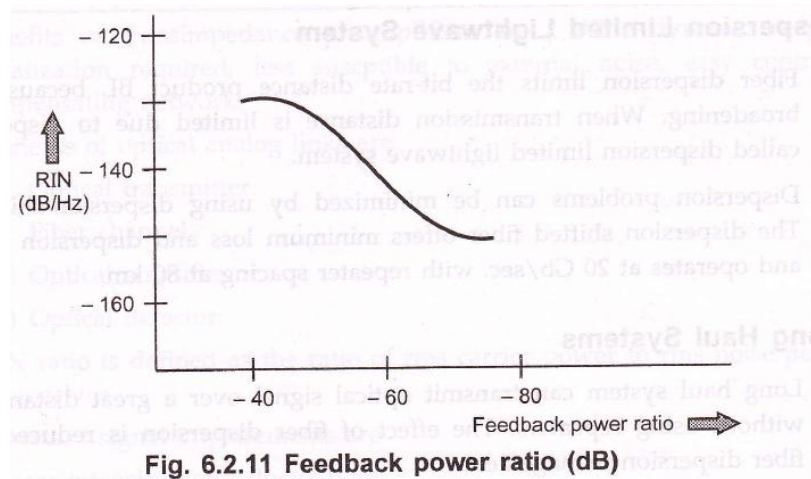

Fig. 6.2.11 Feedback power ratio (dB)

### 6.3 Loss Limited Lightwave Systems

Maximum transmission distance is given by –

$$L = \frac{10}{\alpha_f} \log_{10} \left( \frac{P_{\text{transmitted}}}{P_{\text{received}}} \right)$$

Where,

$\alpha_f$  is net fiber loss.

Maximum transmission distance  $L$  determines the repeater spacing. It ranges from 10 km to 100 km. Typical value of bit error rate (BER)  $< 10^{-9}$ .

### 6.4 Dispersion Limited Lightwave System

Fiber dispersion limits the bit-rate distance product  $BL$  because of pulse broadening. When transmission distance is limited due to dispersion it is called dispersion limited lightwave system.

Dispersion problems can be minimized by using dispersion shifted fibers. The dispersion shifted fiber offers minimum loss and dispersion at  $1.55 \mu\text{m}$  and operates at 20 Gb/sec. with repeater spacing at 80 km.

### 6.5 Long Haul Systems

Long haul system can transmit optical signal over a great distance with or without using repeaters. The effect of fiber dispersion is reduced by using fiber dispersion management.

**Performance Limiting Parameters**

Performance limiting factors in a fiber-optic link are –

- Non-linear effects of optical fibers.
- Self Phase Modulation (SPM).
- Modulation instability.
- Polarization Mode dispersion (PMD).

**Recommended Questions**

1. Derive the thermal noise characteristic equation.
2. What is the role of preamplifier in optical receiver? Explain in brief different types of preamplifier available.
3. Comment on overall performance of
  - i) High-impedance preamplifier.
  - ii) Low-impedance preamplifier.
  - iii) Transimpedance preamplifier.
4. Explain the benefits of transimpedance preamplifier.
5. Explain the following
  - i) Carrier to noise ratio
  - ii) Relative intensity noise
  - iii) Intermodulation distortion
  - iv) Intermodulation products
  - v) Composite second order
  - vi) Composite triple beat
  - vii) Beat stacking
  - viii)
6. Explain with block diagram elements of analog link.  
List the signal impairments in analog systems.
7. Explain the generation of RIN. Give its expression also.

8. Elaborate the important limiting conditions of optical power level. Given their C/N ratios and show the limitations with suitable sketch.
9. With a neat block diagram explain multichannel amplitude modulation.
10. Explain sub-carrier multiplexing technique in OFC.
11. In an optical fiber communication link, list the different components and their characteristics to be considered for selecting it.
12. Briefly explain the importance of link power budget. How the loss is calculated, explain with optical power loss model?
13. Explain the rise-time budget analysis with its basic elements that contribute to system rise time.
14. What is the significance of system consideration in point-to-point fiber links.
15. When distributed networks are preferred?
16. Explain commonly used technologies in distributed networks.
17. Explain LAN used in fiber optic communication system.
18. Discuss commonly used topologies used in fiber optic LAN.

## UNIT - 7

### WDM CONCEPTS AND COMPONENTS

WDM concepts, overview of WDM operation principles, WDM standards, Mach-Zehender interferometer, multiplexer, Isolators and circulators, direct thin film filters, active optical components, MEMS technology, variable optical attenuators, tunable optical fibers, dynamic gain equalizers, optical drop multiplexers, polarization controllers, chromatic dispersion compensators, tunable light sources.

#### RECOMMENDED READINGS:

#### TEXT BOOKS:

1. **Optical Fiber Communication** – Gerd Keiser, 4<sup>th</sup> Ed., MGH, 2008.
2. **Optical Fiber Communications**– – John M. Senior, Pearson Education. 3<sup>rd</sup> Impression, 2007.

#### REFERENCE BOOK:

1. **Fiber optic communication** – Joseph C Palais: 4<sup>th</sup> Edition, Pearson Education.

## 7.1 Wavelength Division Multiplexing (WDM)

- Optical signals of different wavelength (1300-1600 nm) can propagate without interfering with each other. The scheme of combining a number of wavelengths over a single fiber is called wavelength division multiplexing (WDM).
- Each input is generated by a separate optical source with a unique wavelength. An optical multiplexer couples light from individual sources to the transmitting fiber. At the receiving station, an optical demultiplexer is required to separate the different carriers before photodetection of individual signals. Fig. 7.1.1 shows simple WDM scheme.

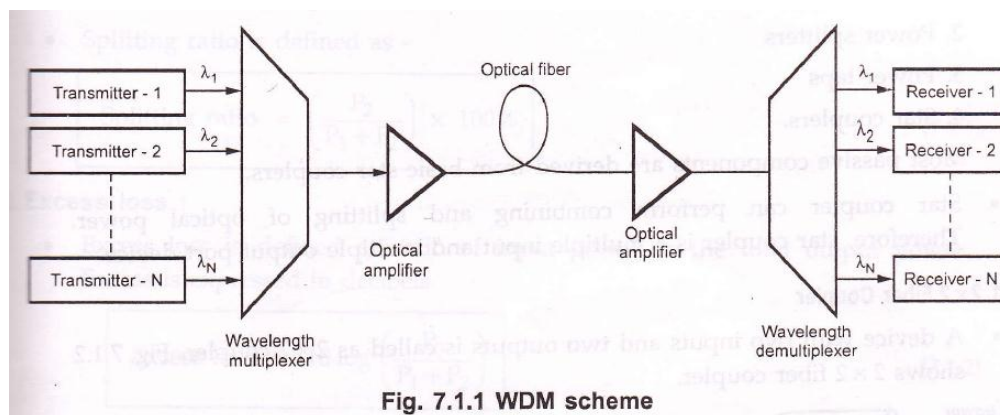

- To prevent spurious signals to enter into receiving channel, the demultiplexer must have narrow spectral operation with sharp wavelength cut-offs. The acceptable limit of crosstalk is – 30 dB.

### Features of WDM

- Important advantages or features of WDM are as mentioned below –
  1. Capacity upgrade : Since each wavelength supports independent data rate in Gbps.
  2. Transparency : WDM can carry fast asynchronous, slow synchronous, synchronous analog and digital data.
  3. Wavelength routing : Link capacity and flexibility can be increased by using multiple wavelength.
  4. Wavelength switching : WDM can add or drop multiplexers, cross connects and wavelength converters.

### Passive Components

- For implementing WDM various passive and active components are required to combine, distribute, isolate and to amplify optical power at different wavelength.

- Passive components are mainly used to split or combine optical signals. These components operate in optical domains. Passive components don't need external control for their operation. Passive components are fabricated by using optical fibers by planar optical waveguides. Commonly required passive components are –
  1.  $N \times N$  couplers
  2. Power splitters
  3. Power taps
  4. Star couplers.

Most passive components are derived from basic star couplers.

- Star coupler can perform combining and splitting of optical power. Therefore, star coupler is a multiple input and multiple output port device.

### 2 x 2 Fiber Coupler

- A device with two inputs and two outputs is called as 2 x 2 coupler. Fig. 7.1.2 shows 2 x 2 fiber coupler.

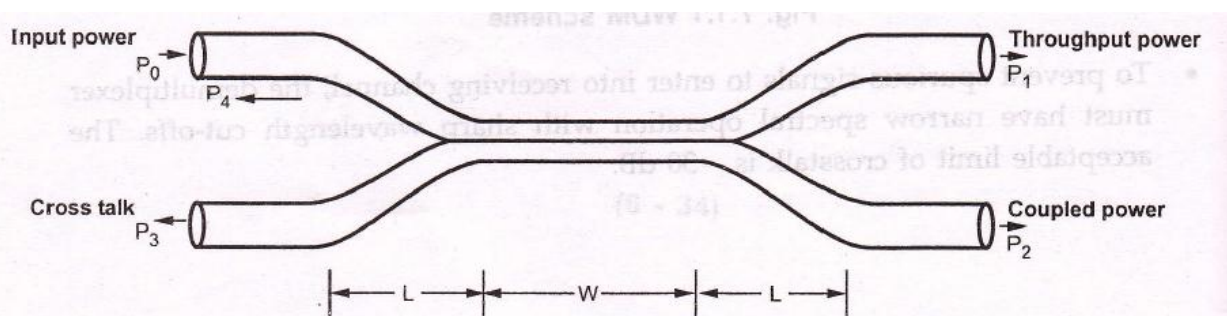

Fig. 7.1.2 2 x 2 fiber coupler

- Fused biconically tapered technique is used to fabricate multiport couplers.
- The input and output port has long tapered section of length 'L'.
- The tapered section gradually reduced and fused together to form coupling region of length 'W'.
- Input optical power :  $P_0$ .  
Throughput power :  $P_1$ .  
Coupled power :  $P_2$ .  
Cross talk :  $P_3$ .  
Power due to reflection :  $P_4$ .
- The gradual tapered section determines the reflection of optical power to the input port, hence the device is called as directional coupler.

- The optical power coupled from one fiber to another is dependent on-
  1. Axial length of coupling region where the fields from fibers interact.
  2. Radius of fiber in coupling region.
  3. The difference in radii of two fibers in coupling region.

## Performance Parameters of Optical Coupler

### 1. Splitting ratio / coupling ratio

- Splitting ratio is defined as –

$$\text{Splitting ratio} = \left( \frac{P_2}{P_1 + P_2} \right) \times 100\%$$

... (7.1.1)

### 2. Excess loss:

- Excess loss is defined as ratio of input power to the total output power. Excess is expressed in decibels.

$$\text{Excess loss} = 10 \log \left( \frac{P_0}{P_1 + P_2} \right)$$

... (7.1.2)

### 3. Insertion loss:

- Insertion loss refers to the loss for a particular port to port path. For path from input port I to output port j.

$$\text{Insertion loss} = 10 \log \frac{P_1}{P_2}$$

...(7.1.3)

### 4. Cross talk :

- Cross talk is a measure of degree of isolation between input port and power scattered or reflected back to other input port.

$$\text{Cross talk} = 10 \log \left( \frac{P_3}{P_0} \right)$$

**Example 7.1.1 :** For a 2 x 2 fiber coupler, input power is 200  $\mu\text{W}$ , throughput power is 90  $\mu\text{W}$ , coupled power is 85  $\mu\text{W}$  and cross talk power is 6.3  $\mu\text{W}$ . Compute the performance parameters of the fiber coupler.

**Solution :**  $P_0 = 200 \mu\text{W}$

$$P_1 = 90 \mu\text{W}$$

$$P_2 = 85 \mu\text{W}$$

$$P_3 = 6.3 \mu\text{W}$$

i) 
$$\text{Coupling ratio} = \left( \frac{P_2}{P_1 + P_2} \right) \times 100\%$$

$$\text{Coupling ratio} = \frac{85}{(95+85)} \times 100\%$$

$$\text{Coupling ratio} = \mathbf{48.75 \%}$$

... Ans.

ii) 
$$\text{Excess ratio} = 10 \log \left( \frac{P_0}{P_1 + P_2} \right) \text{dB}$$

$$\text{Excess ratio} = \mathbf{0.5799 \text{ dB}}$$

... Ans.

iii) 
$$\text{Insertion loss} = 10 \log \left( \frac{P_0}{P_1} \right) \text{dB}$$

(For port 0 to port 1)

$$= 10 \log \frac{200}{90}$$

$$= \mathbf{3.46 \text{ dB}}$$

... Ans.

$$\text{Insertion loss} = 10 \log \left( \frac{P_0}{P_1} \right) \text{dB}$$

(For port 0 to port 2)

$$= 10 \log \left( \frac{P_0}{P_2} \right) \text{dB}$$



$$= 3.71 \text{ dB}$$

... Ans.

iv)

$$\text{Cross talk} = 10 \log \left( \frac{P_3}{P_0} \right)$$

$$= 10 \log \left( \frac{6.3 \times 10^{-8}}{200} \right)$$

$$= -45 \text{ dB}$$

... Ans.

### Star Coupler

- Star coupler is mainly used for combining optical powers from N-inputs and divide them equally at M-output ports.
- The fiber fusion technique is popularly used for producing N x N star coupler. Fig. 7.1.3 shows a 4 x 4 fused star coupler.

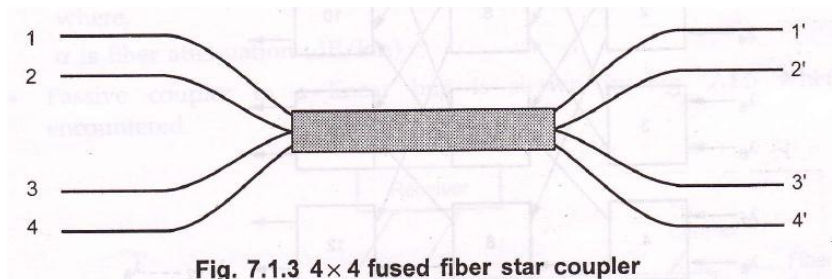

Fig. 7.1.3 4 x 4 fused fiber star coupler

- The optical power put into any port on one side of coupler is equally divided among the output ports. Ports on same side of coupler are isolated from each other.
- Total loss in star coupler is constituted by splitting loss and excess loss.

$$\text{Solitting loss} = -10 \log \left( \frac{1}{N} \right) = 10 \log N \quad \dots (7.1.4)$$

$$\text{Excess loss} = 10 \log \left( \frac{P_{in}}{\sum_{i=1}^N P_{out,i}} \right) \quad \dots (7.1.5)$$

### 8 x 8 Star Coupler

- An 8 x 8 star coupler can be formed by interconnecting 2 x 2 couplers. It requires twelve 2 x 2 couplers.
- Excess loss in dB is given as –

$$\text{Excess loss} = -10 \log \left( F_T^{\log_2 N} \right)$$

... (7.1.6)

where  $F_T$  is fraction of power traversing each coupler element.

$$\text{Splitting loss} = 10 \log N$$

$$\text{Total loss} = \text{Splitting loss} + \text{Excess loss}$$

$$= 10 (1 - 3.32 \log F_T) \log N$$

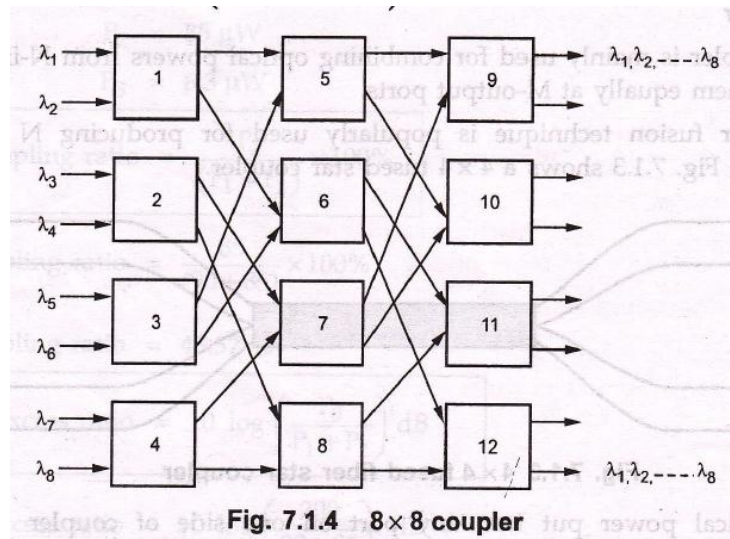

Fig. 7.1.4 8x8 coupler

### Wavelength converter

- Optical wavelength converter is a device that converts the signal wavelength to new wavelength without entering the electrical domain.
- In optical networks, this is necessary to keep all incoming and outgoing signals should have unique wavelength.
- Two types of wavelength converters are mostly used :
  1. Optical gating wavelength converter
  2. Wave mixing wavelength converter

### Passive Linear Bus Performance

- For evaluating the performance of linear bus, all the points of power loss are considered.
- The ratio ( $A_0$ ) of received power  $P(x)$  to transmitted power  $P(0)$  is

$$A_0 \frac{P(x)}{P(0)} = 10^{-\alpha x/10} \quad \dots (7.9.1)$$

where,

$\alpha$  is fiber attenuation (dB/km)

- Passive coupler in a linear bus is shown in Fig. 7.1.5 where losses encountered.

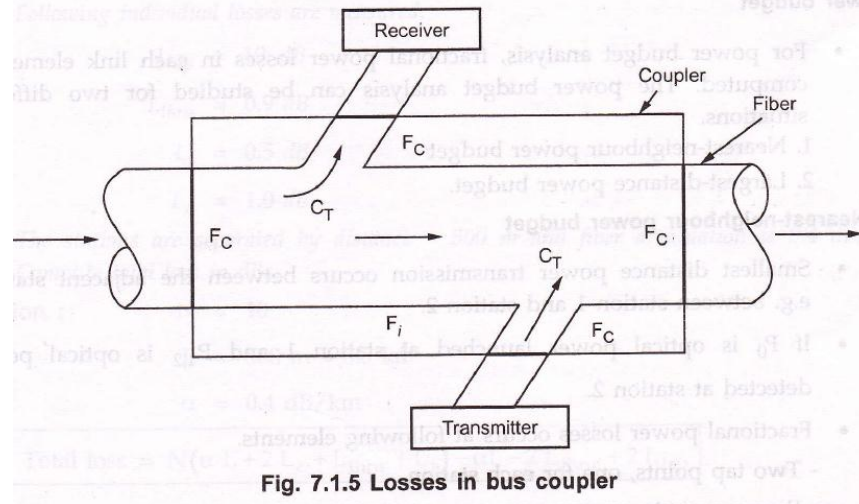

- The connecting loss is given by –

$$L_c = -10 \log(1 - F_C) \quad \dots (7.1.10)$$

where,

$F_C$  is fraction of optical power lost at each port of coupler.

- Tap loss** is given by –

$$L_c = -10 \log C_T \quad \dots (7.1.11)$$

where,

$C_T$  is fraction of optical power delivered to the port.

- The power removed at tap goes to the unused port hence lost from the system. The **throughput coupling** loss is given by –

$$\begin{aligned} L_{thru} &= -10 \log (1 - C_T)^2 \\ &= -20 \log (1 - C_T) \end{aligned} \quad \dots (7.1.12)$$

- The **intrinsic transmission** loss is given as –

$$L_i = -10 \log(1 - F_i) \quad \dots (7.1.13)$$

where,  $F_i$  is fraction of power lost in the coupler.

- The **fiber attenuation** between two stations, assuming stations are uniformly separated by distance L is given by –

$$L_{\text{fiber}} = \alpha L \quad \dots (7.1.14)$$

### Power budget

- For power budget analysis, fractional power losses in each link element is computed. The power budget analysis can be studied for two different situations.
  1. Nearest-neighbour power budget
  2. Target-distance power budget.

#### 1. Nearest-neighbour power budget

- Smallest distance power transmission occurs between the adjacent stations e.g. between station 1 and station 2.
- If  $P_0$  is optical power launched at station 1 and  $P_{1,2}$  is optical power detected at station 2.
- Fractional power losses occurs at following elements.
  - Two tap points, one for each station.
  - Four connecting points, two for each station.
  - Two couplers, one for each station.
- Expression for loss between station 1 and station 2 can be written as –

$$10 \log \left( \frac{P_0}{P_{1,2}} \right) = \alpha L + 2 L_{\text{tap}} + 4 L_c + 2 L_i \quad \dots (7.1.15)$$

#### 2. Target distance power budget

- Largest distance power transmission occurs between station 1 and station N.
- The losses increases linearly with number of stations N.
- Fractional losses are contributed by following elements.
  - Fiber attenuation loss
  - Connector loss
  - Coupler throughput loss
  - Intrinsic transmission loss
  - Tap loss
- The expression for loss between station 1 and station N can be written as –

$$10 \log \left( \frac{P_0}{P_{1,N}} \right) = (N - 1)\alpha L + 2N L_c + (N - 2)L_{\text{thru}} + 2L_{\text{tap}} + N L_i \quad \dots (7.1.16)$$

$$10 \log \left( \frac{P_0}{P_{L,N}} \right) = N(\alpha L + 2 L_c + L_{thru} + L_i) - \alpha L - 2 L_{thru} + 2L_{tap} \quad \dots (7.1.17)$$

**Example 7.1.3 :** Prepare a power budget for a linear bus LAN having 10 stations. Following individual losses are measured.

$$L_{tap} = 10 \text{ dB}$$

$$L_{thru} = 0.9 \text{ dB}$$

$$L_i = 0.5 \text{ dB}$$

$$L_c = 1.0 \text{ dB}$$

The stations are separated by distance = 500 m and fiber attenuation is 0.4 dB/km. Couple total loss in dBs.

**Solution :**  $N = 10$

$$L = 500 \text{ m} = 0.5 \text{ km}$$

$$\alpha = 0.4 \text{ dB/km}$$

$$\begin{aligned} \text{Total loss} &= N(\alpha L + 2 L_c + L_{thru} + L_i) - \alpha L - 2 L_{thru} + 2L_{tap} \\ &= 10(0.4 \times 0.5 + 2 \times 1 + 0.9 + 0.5) - (0.4 \times 0.5) - (2 \times 0.9) + (2 \times 10) \\ &= \mathbf{54 \text{ dB}} \end{aligned} \quad \dots \text{Ans.}$$

### Star Network Performance

- If  $P_S$  is the fiber coupler output power from source and  $P$  is the minimum optical power required by receiver to achieve specified BER.
- Then for link between two stations, the power balance equation is given by –

$$P_S - P_R = L_{excess} + \alpha (2L) + 2L_c + L_{split}$$

where,

$L_{excess}$  is excess loss for star coupler (Refer equation 7.1.13),

$L_{split}$  is splitting loss for star coupler (Refer equation 7.1.12),

$\alpha$  is fiber attenuation,

$L$  is distance from star coupler,

$L_c$  is connector loss.

- The losses in star network increases much slower as compared to passive linear bus. Fig. 7.1.6 shows total loss as a function of number of attached stations for linear bus and star architectures.

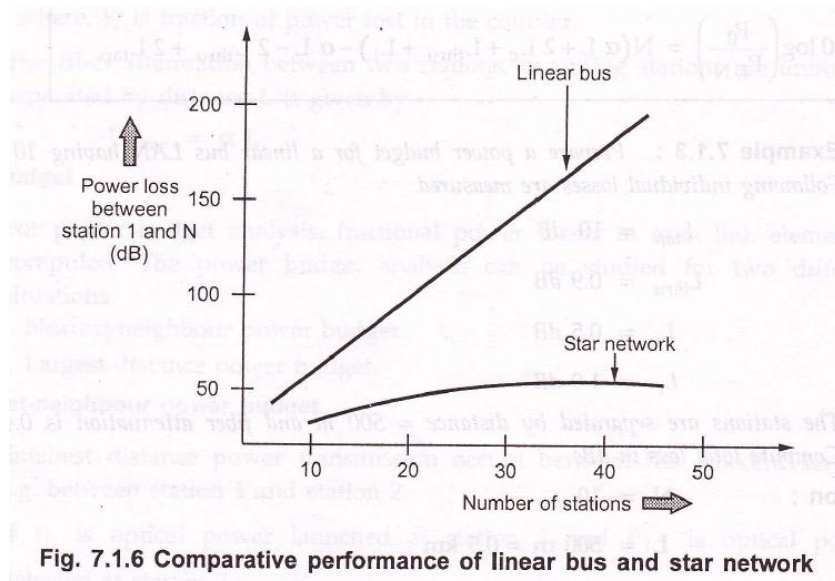

### Photonic Switching

- The wide-area WDM networks requires a dynamic wavelength routing scheme that can reconfigure the network while maintaining its non-blocking nature. This functionality is provided by an optical cross connect (OXC).
- The optical cross-connects (OXC) directly operate in optical domain and can route very high capacity WDM data streams over a network of interconnected optical path. Fig. 7.1.7 shows OXC architecture.

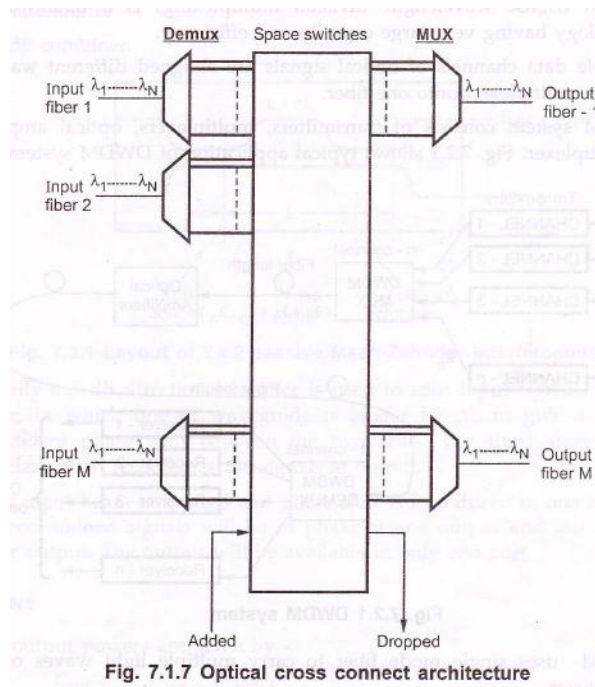

### Non-Linear Effects

- Non-linear phenomena in optical fiber affects the overall performance of the optical fiber networks. Some important non-linear effects are –
  1. Group velocity dispersion (GVD).
  2. Non-uniform gain for different wavelength.
  3. Polarization mode dispersion (PMD).
  4. Reflections from splices and connectors.
  5. Non-linear inelastic scattering processes.
  6. Variation in refractive index in fiber.
- The non-linear effects contribute to signal impairments and introduces BER.

### 7.2 Dense Wavelength Division Multiplexing (DWDM)

#### DWDM:

- 1) DWDM (Dense wavelength – division multiplexing) is a data transmission technology having very large capacity and efficiency.
- 2) Multiple data channels of optical signals are assigned different wavelengths, and are multiplexed onto one fiber.
- 3) DWDM system consist of transmitters, multiplexers, optical amplifier and demultiplexer. Fig. 7.2.1 shows typical application of DWDM system.

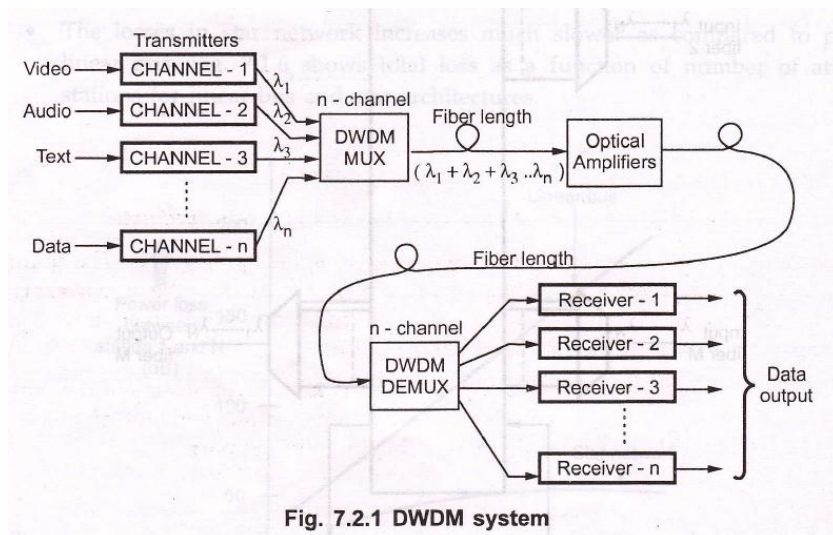

- 4) DWDM used single mode fiber to carry multiple light waves of different frequencies.
- 5) DWDM system uses Erbium – Doped Fiber Amplifiers (EDFA) for its long haul applications, and to overcome the effects of dispersion and attenuation channel spacing of 100 GHz is used.

### 7.3 Mach-Zehnder Interferometer (MZ) Multiplexer

- Mach-Zehnder interferometry is used to make wavelength dependent multiplexers. These devices can be either active or passive.
- A layout of 2 x 2 passive MZI is shown in Fig. 7.3.1. It consists of three stages
  - a) 3-dB splitter
  - b) Phase shifter
  - c) 3-dB Combiner.

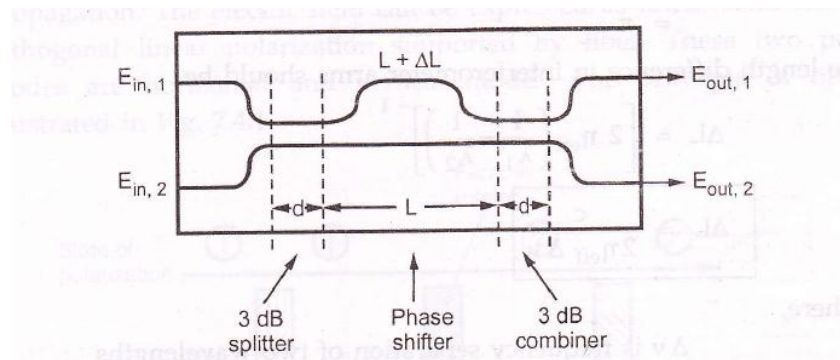

**Fig. 7.3.1 Layout of 2 × 2 passive Mach-Zehnder Interferometer**



- Initially a 3 dB directional coupler is used to split input signals. The middle stage, in which one of waveguide is longer by  $\Delta L$  to given a wavelength dependent phase shift between the two arms. The third stage is a dB coupler which recombines the signals at output.
- Thus input beam is splitted an phase shift it introduced in one of the paths, the recombined signals will be in phase at one output and out of phase at other output. The output will be available in only one port.

#### Output powers

- The output powers are given by –

$$P_{out,1} = E_{out,1} + E_{out,1}^* \quad \dots (7.3.1)$$

$$P_{out,2} = E_{out,2} + E_{out,2}^* \quad \dots (7.3.2)$$

The optical output powers are square of respective optical output field strengths.

$$P_{out,1} = \sin^2 \left( k_1 \frac{\Delta L}{2} \right) P_{in,2} + \cos^2 \left( k_2 \frac{\Delta L}{2} \right) P_{in,2} \quad \dots (7.3.3)$$

$$P_{out,2} = \cos^2 \left( k_1 \frac{\Delta L}{2} \right) P_{in,1} + \sin^2 \left( k_2 \frac{\Delta L}{2} \right) P_{in,2} \quad \dots (7.3.4)$$

where

$$k_j = 2\pi \eta_{eff} / \lambda_j,$$

$\Delta L$  = Difference of path lengths,

$$P_{in,j} = |E_{in,j}|^2 = E_{in,j} E_{in,j}$$

- If all the power from both input should leave the same output port (any of output port) then, there is need to have  $k_1 \frac{\Delta L}{2} = \pi$  and  $k_2 \frac{\Delta L}{2} = \pi/2$

$$(k_1 - k_2)\Delta L = 2\pi \eta_{eff} \left( \frac{1}{\lambda_1} - \frac{1}{\lambda_2} \right) \Delta L \quad \dots (7.3.5)$$

$$= \pi$$

- The length difference in interferometer arms should be

$$\Delta L = 2\pi \eta_{\text{eff}} \left[ \frac{1}{\lambda_1} - \frac{1}{\lambda_2} \right]^{-1} \quad \dots (7.3.6)$$

$$\Delta L = \frac{c}{2\eta_{\text{eff}} \Delta \nu} \quad \dots (7.3.7)$$

where,

$\Delta \nu$  is frequency separation of two wavelengths

$\eta_{\text{eff}}$  is effective refractive index in waveguide

**Example 7.3.1 :** In 2 x 2 MZIs, the input wavelengths are separated by 10 GHz. The silicon waveguide has  $\eta_{\text{eff}} = 1.5$ . Compute the waveguide length difference.

**Solution :** Given :  $\Delta \nu = 10 \text{ GHz} = 10 \times 10^9 \text{ Hz}$

$$\eta_{\text{eff}} = 1.5$$

The length difference is given by

$$\Delta L = \frac{c}{2\eta_{\text{eff}} \Delta \nu} \quad \dots (7.3.8)$$

$$\Delta L = \frac{3 \times 10^8}{2 \times 1.5 \times 10 \times 10^9}$$

$$\Delta L = 10 \text{ mm} \quad \dots \text{Ans.}$$

## 7.4 Isolator

- An isolator is a passive non-reciprocal device. It allows transmission in one direction through it and blocks all transmission in other direction.
- Isolator are used in systems before optical amplifiers and lasers mainly to prevent reflections from entering these devices otherwise performance will degrade.
- Important parameters of an isolator are its insertion loss (in forward direction) and isolation (in reverse direction). The insertion loss should be as small as possible while isolation should be as large as possible. The typical insertion loss is around 1 dB and isolation is around 40 to 50 dB.

### Principle of operation

- Isolator works on the principle of state of polarization (SOP) of light in a single mode fibers. The state of polarization (SOP) refers to the orientation of its electric field vector

on a plane that is orthogonal to its direction of propagation. The electric field can be expressed as linear combination of two orthogonal linear polarization supported by fiber. These two polarization modes are horizontal and vertical modes. The principle of operation is illustrated in Fig. 7.4.1.

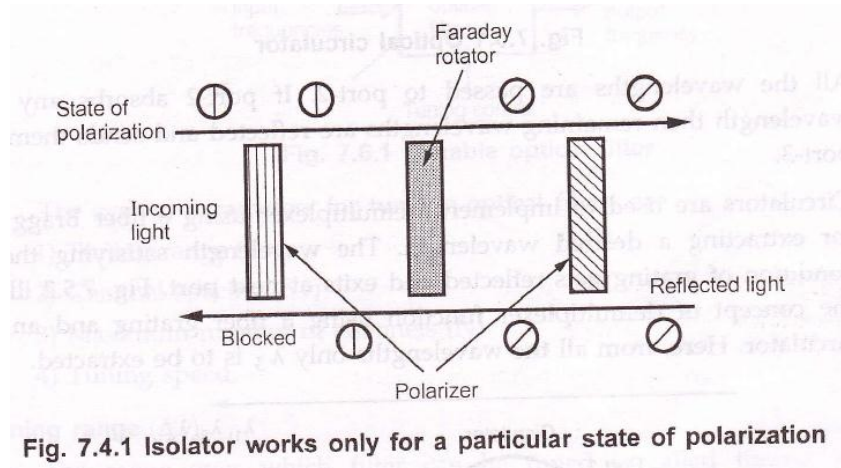

- Let input light signal has vertical state of polarization (SOP) and blocks energy in horizontal SOP, The polarizer is followed by Faraday rotator.
- Faraday rotator is an asymmetric device which rotates the SOP clockwise by  $45^\circ$  in both direction of propagation. The polarizer after Faraday rotator passes only SOPs with  $45^\circ$  orientation. In this way light signal from left to right is passed through the device without any loss.
- Light entering the device from right due to reflection, with same  $45^\circ$  SOP orientation, is rotated another  $45^\circ$  by the Faraday and blocked by the next polarizer.

## 7.5 Circulator

- A three part circulator is shown in Fig. 7.5.1. Signals of different wavelengths are entered at a port and sends them out at next port.

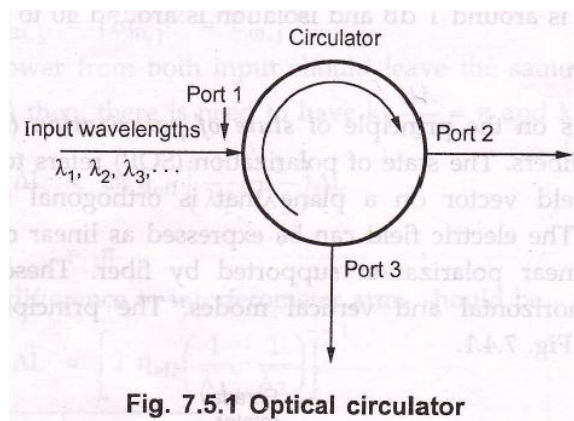

- All the wavelengths are passed to port-2. If port-2 absorbs any specific wavelength then remaining wavelengths are reflected and sends them to next port-3.
- Circulators are used to implement demultiplexer using  $\partial$  fiber Bragg grating for extracting a desired wavelength. The wavelength satisfying the Bragg condition of grating gets reflected and exits at next port. Fig. 7.5.2 illustrates the concept of demultiplexer function using a fiber grating and an optical circulator. Here, from all the wavelengths only  $\lambda_3$  is to be extracted.

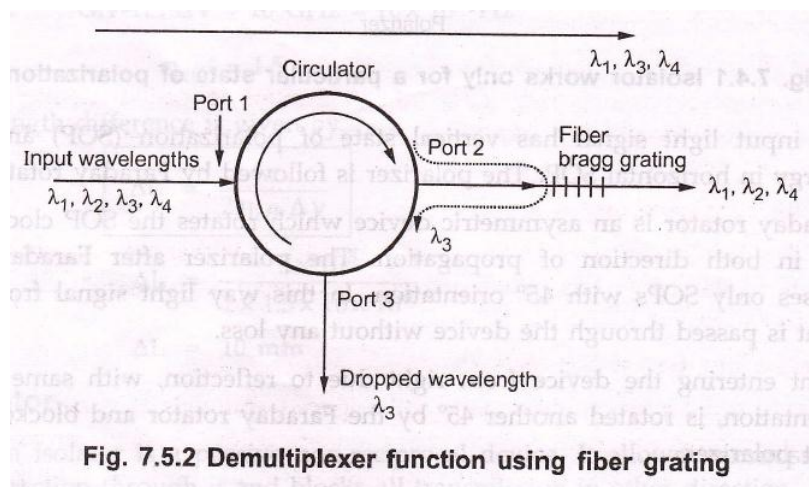

- The circulator takes four wavelengths  $\lambda_1, \lambda_2, \lambda_3$  and  $\lambda_4$  from input port-1 tunable filter operates on similar principle as passive devices. It operates over a range of frequencies and can be tuned at only one optical frequency to pass through it. Fig. 7.6.1 illustrates concept of tunable filter.

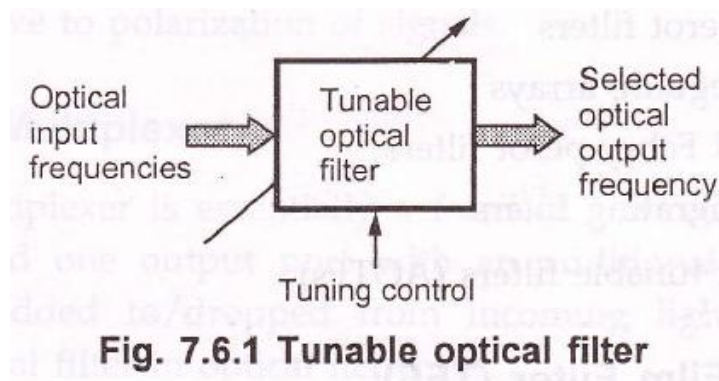

- The system parameters for tunable optical filters are –
  - 1) Tuning range ( $\Delta\nu$ )
  - 2) Channel spacing ( $\delta\nu$ )
  - 3) Maximum number of channels(N)
  - 4) Tuning speed.

### 1. Tuning Range ( $\Delta\nu$ )

- The range over which filter can be tuned is called tuning range. Most common wavelength transmission window is 1300 and 1500 nm, then 25 Hz is reasonable tuning range.

### 2. Channel spacing ( $\delta\nu$ )

- The minimum frequency separation between channels for minimum cross talk. The cross talk from adjacent channel should be 30 dB for desirable performance.

### 3. Maximum number of channels (N)

- It is maximum number of equally spaced channels that can be packed into the tuning range maintain an adequately low level of cross-talk between adjacent channels. It is defined as the ratio of the total tuning range  $\Delta\nu$  to channel spacing  $\delta\nu$ .

$$N = \frac{\Delta\nu}{\delta\nu}$$

### 4. Tuning speed

- Tuning speed specified how quickly filter can be reset from one frequency to another.

## Tunable Filter Types

- Tunable filters with fixed frequency spacings with channel separations that are multiples of 100 GHz ( $\delta\nu \leq 100$  GHz) are used in WDM systems
  1. Tunable 2 x 2 directional couplers
  2. Tunable Mach-Zehnder interferometers
  3. Fiber Fabry-perot filters
  4. Tunable waveguide arrays
  5. Liquid crystal Fabry-perot filters
  6. Tunable multigrating filters
  7. Acousto-optic tunable filters (AOTFs)

### 7.7 Dielectric Thin-Film Filter (TFF)

- A thin film resonant cavity filter (TFF) is a Fabry-perot interferometer. A cavity is formed by using multiple reflective dielectric thin film layers. The TFF works as bandpass filter, passing through specific wavelength and reflecting all other wavelengths. The cavity length decides the passing wavelength.
- Filter consisting two or more cavities dielectric reflectors is called thin film resonant multicavity filter (TFMF). Fig. 7.7.1 shows a three cavity thin film resonant dielectric thin film filter.

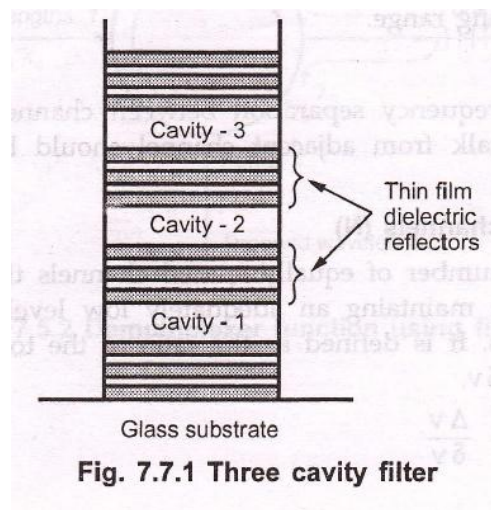

- For configuring a multiplexer and demultiplexer, a number of such filters can be cascaded. Each filter passes a different wavelength and reflects other. While using as demultiplexer, the filter in cascade passes one wavelength and reflects all others onto second filter. The second filter passes another wavelength and reflects remaining wavelengths.

**Features**

1. A very flat top on passband and very sharp skirts are possible.
2. Device is extremely stable in temperature variations.
3. Very low loss.
4. Device is insensitive to polarization of signals.

**7.8 Optical Add/Drop Multiplexer**

- As add/drop multiplexer is essentially a form of a wavelength router with one input port and one output port with an additional local port where wavelengths are added to/dropped from incoming light signal. It is an application of optical filter in optical networks.
- Fiber grating devices are used for add/drop functions. Many variations of add/drop element can be realized by using gratings in combination with couplers and circulators.

**7.9 Tunable Lasers**

- Tunable light sources are required in many optical networks. Tunable lasers are more convenient from operational view point because of following advantages –
  - Only one transmitter part.
  - Independent of operating wavelength
  - It reduces number of different parts to be stocked and handled
  - Capable of being tuned over 8 nm to 20 wavelengths.
  - Wavelength tuning without changing output power.
- Different tunable lasers are -
  - 1 Vertical cavity surface emitting lasers
  2. Mode locked lasers

**Recommended Questions**

1. With a neat sketch explain WDM scheme.
2. State the significance of passive components in WDM.
3. Explain the construction and working of 2 x 2 fiber coupler.
4. Explain various performance parameters of optical coupler.
5. Explain star coupler used in fiber optics.
6. Briefly discuss DWDM with a simple sketch.
7. Explain MZI multiplexer.
8. Derive an expression for difference in length for MZI multiplexer
9. Explain the need of isolator in optical network. Give its principle of operation also.
10. Describe the use of circulator in optical system. How demultiplexer can be implemented using fiber grating and circulator?
11. What is a tunable optical filter?
12. Explain system parameters for tunable optical filter.
13. Explain the construction and application of dielectric thin film filter (TFF).
14. Write a note on optical add/drop multiplexer.
15. Write a note on tunable lasers



## UNIT - 8

### OPTICAL AMPLIFIERS AND NETWORKS

Optical amplifiers, basic applications and types, semiconductor optical amplifiers, EDFA. Optical Networks: Introduction, SONET / SDH, Optical Interfaces, SONET/SDH rings, High – speed light – waveguides.

#### RECOMMENDED READINGS:

#### TEXT BOOKS:

1. **Optical Fiber Communication** – Gerd Keiser, 4<sup>th</sup> Ed., MGH, 2008.
2. **Optical Fiber Communications** – John M. Senior, Pearson Education. 3<sup>rd</sup> Impression, 2007.

#### REFERENCE BOOK:

1. **Fiber optic communication** – Joseph C Palais: 4<sup>th</sup> Edition, Pearson Education.

## 8.1 Optical Amplifier

- Most optical amplifiers amplify incident light through stimulated emission. An optical amplifier is nothing but a laser without feedback. Optical gain is achieved when the amplifier is pumped optically or electrically to achieve population inversion. Optical amplification depends on-
  - Frequency (or wavelength) of incident signal.
  - Local beam intensity.
- Fig. 8.1.1 shows basic operation of optical amplifier.
- The external pump source energy is absorbed by the electrons in the active

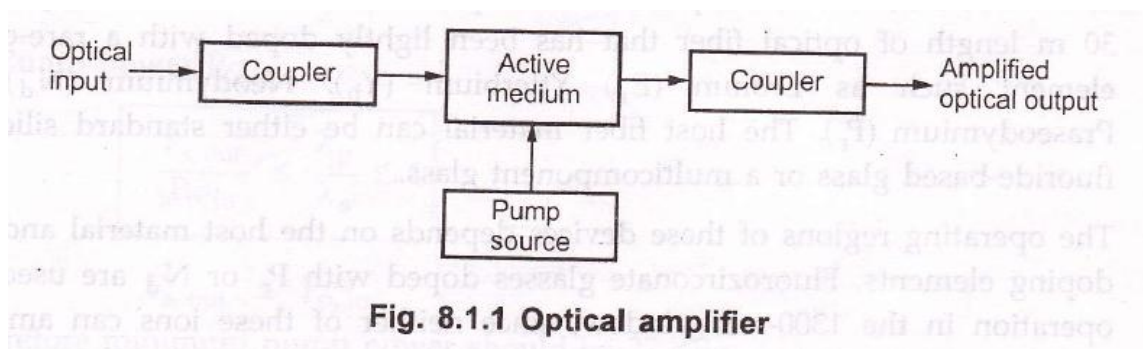

medium. The electrons shift to the higher energy level producing population inversion. Photons of incoming signal trigger these excited electrons to lower level through a stimulated emission process, producing amplified optical signal.

### Amplifier Types

- The optical amplifiers can be classified into two main types.
  1. Semiconductor optical amplifier (SOA).
  2. Doped fiber amplifier (DFA).
- Both the types stimulated emission process.

### 8.2 Semiconductor Optical Amplifier (SOA)

- SOA is a Laser diode without end mirrors and with antireflection coating coupled to both fiber ends. Light coming in either fiber is amplified by a single pass through the laser diode. SOA is an alternative to EDFA.
- Active medium consists of alloy semiconductor (P, Ga, In, As).
- SOA works in both low attenuation windows i.e. 1300nm and 1550nm.
- The 3dB bandwidth is about 70nm because of very broad gain spectrum.
- SOA consumes less power and has fewer components.

- Two major types of SOA are –
  - a. Fabry - perot amplifier (FPA)
  - b. Travelling wave amplifier (TWA)
- SOA has rapid gain response 1 ps to 0.1 ns.

### 8.3 Erbium Doped Fiber Amplifier (EDFA)

Erbium-doped fiber amplifiers:

- The active medium in an optical fiber amplifier consists of a nominally 10 to 30 m length of optical fiber that has been tightly doped with a rare-earth element such as Erbium ( $E_r$ ), Ytterbium ( $Y_b$ ), Neodymium ( $N_d$ ) or Praseodymium ( $P_r$ ). The host fiber material can be either standard silica, a fluoride-based glass or a multicomponent glass.
- The operating regions of these devices depends on the host material and the doping elements. Fluorozirconate glasses doped with  $P_r$  or  $N_d$  are used for operation in the 1300-nm window, since neither of these ions can amplify 1300 nm signals when embedded in silica glass.
- The most popular material for long haul telecommunication application is a silica fiber doped with Erbium, which is known as Erbium-doped fiber amplifier or EDFA.
- The operation of an EDFA by itself normally is limited to the 1530 to 1560 nm region.

#### Features of EDFA

- Active medium is created by erbium ( $E_r$ ), ytterbium ( $Y_b$ ), neodymium ( $N_d$ ), praseodymium ( $P_r$ ).
- DFA can pump device at several different wavelength.
- Low coupling loss.
- Constant gain.

$$\text{Amplifier gain } G = \frac{P_{s,out}}{P_{s,in}}$$

∴

$$\text{Power Conversion Efficiency} = \frac{P_{s,out}}{P_{s,in}} \leq \frac{\lambda_p}{\lambda_s} \leq 1$$

**Example 8.3.1** :An EDFA amplifier produces  $P_{s,out} = 27$  dBm for an in out level of 2 dBm at 1542 nm.

- i. Find the amplifier gain.
- ii. What is the minimum pump power required ?

[Jan./Feb.-2007, 10 Marks]

**Solution : i) Amplifier gain**

$$G = \frac{P_{s,out}}{P_{s,in}}$$

$$G = \frac{27}{2} = 13.5$$

... Ans

ii) Pump power  $P_{p, in}$

$$\therefore \frac{P_{s,out}}{P_{s,in}} \leq \frac{\lambda_p}{\lambda_s} \leq 1$$

$$\therefore P_{s,out} \leq P_{p,in}$$

Therefore minimum pump power should be 27 dBm.

... Ans

## 8.4 Optical Networks

### Introduction

- SONET (Synchronous Optical Network) is an optical transmission interface originally proposed by Bellcore and Standardized by ANSI
- **Important characteristics, similarities and differences between SONET and SDH:**
  1. SONET is a synchronous network.
  2. SDH is also a synchronous network with optical interfaces.
  3. SONET is a set of standard interfaces on an optical synchronous network of elements that conform to these interfaces.
  4. SONET interfaces defines all layers, from physical to the application layer.
  5. SDH is a set of standard interfaces in a network of elements that conform to these interfaces.

6. Like SONET, SDH interfaces define all layers, from physical to the application layer.
- The SONET standard addresses the following specific issues:
    1. Establishes a standard multiplexing format using any number of 51.84Mbps signals as building blocks.
    2. Establishes an optical signal standard for interconnecting equipment from different suppliers.
    3. Establishes extensive operations, administration and maintenance capabilities as part of the standard.
    4. Defines a synchronous multiplexing format for carrying lower level digital signals.

### Broadband Networks

- Fig. 8.4.1 shows SONET/SDH network services. (Refer Fig. 8.4.1 on next page).
- Voice, video data, internet and data from LAN'S, MAN'S, and MAN'S will be transported over a SONET or a SDH network.
- The SONET network is also able to transport asynchronous transfer mode (ATM) payloads. These systems, called broadband can manage a very large aggregate bandwidth or traffic.

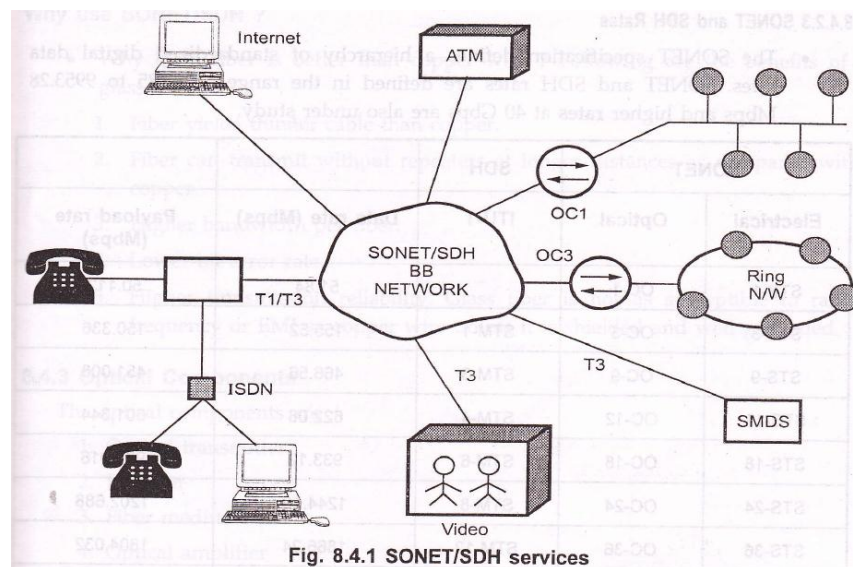

## SONET versus SDH

Some of the technical similarities between SONET and SDH are :

1. Bit rates and frame format organization.
2. Frame synchronization schemes.
3. Multiplexing and demultiplexing rules.
4. Error control.

## SONET/SDH Benefits

Advantages are listed below :

1. Reduced cost is lower.
  - a. Operation cost is lower.
  - b. Same interface for all vendors
2. Integrated network elements :
  - a. It allows for multivendor internetworking.
  - b. It has enhanced network element management.
3. It offers network survivability features.
4. It is compatible with legacy and future networks.
5. Remote operation capabilities. It is remotely provisioned, tested, inventoried, customized and reconfigured.

## SONET and SDH Rates

- The SONET specification defines a hierarchy of standardized digital data rates. SONET and SDH rates are defined in the range of 51.85 to 9953.28 Mbps and higher rates at 40 Gbps are also under study.

SONET		SDH		
Electrical	Optical	ITU-T	Data rate (Mbps)	Payload rate (Mbps)
STS-1	OC-1		51.84	50.112
STS-3	OC-3	STM-1	155.52	150.336
STS-9	OC-9	STM-3	466.56	451.008
STS-12	OC-12	STM-4	622.08	601.344
STS-18	OC-18	STM-6	933.12	902.016
STS-24	OC-24	STM-8	1244.16	1202.688

STS-36	OC-36	STM-12	1866.24	1804.032
STS-48	OC-48	STM-116	2488.24	2405.376
STS-96	OC-96	STM-32	4876.64	4810.752
STS-192	OC-192	STM-64	9953.28	3621.504

- 1) Sts-1 = Synchronous transport signal – 1
  - 2) OC = Optical carrier
  - 3) STM = Synchronous transport module
  - 4) ITU-T = International Telecommunication Union Telecommunication Standardization Sector.
- When the SONET signal is in its electrical nature, it is known as synchronous transport signal level N (STS-N). The SDH equivalent is called synchronous transport module level N (STM-N).
  - After its conversion into optical pulses, it is known as optical carrier level N (OC-N). In SONET, N takes the value 1, 3, 12, 48 and 192 with corresponding bit rates at 51.48, 155.52, 622.08, 2488.32 and 9953.28 Mbps.

### Why use SONET/SDH?

- Why glass fiber is better than copper wire? Following are the benefits of glass fiber.
  1. Fiber yields thinner cable than copper.
  2. Fiber can transmit without repeaters at longer distances as compared with copper.
  3. Higher bandwidth per fiber.
  4. Lower bit error rate.
  5. Higher transmission reliability. Glass fiber is not as susceptible to radio frequency or EMI as copper wire unless it is shielded and well grounded.

### Optical Components

The optical components are

1. Optical transmitter
2. Receiver
3. Fiber medium
4. Optical amplifier

### 1. Optical transmitter

- It is a transducer that converts electrical pulses to optical pulses.
- The transmitter is characterized by
  - a) An optical power
  - b) A rise time
  - c) Central wavelength
  - d) Wavelength range
- Laser diodes have better controlled parameters, higher optical power, and short times and therefore are better suited for multimega bit rates.
- Light emitting diodes (LED) transmit a wider band of wavelengths, are more inexpensive and are better suited for lower bit rates than laser transmitters.

### 2. Receiver

- It is a transducer that converts optical pulses to electrical ones. Photodetectors can be made with photoresist material or semiconductors. The response times of these technologies are very different.
- For multimega bit rates, detectors must have high optical power sensitivity, very fast response to a range of wavelengths that matches the range of transmitted wavelengths.

### 3. Fiber medium

- Ultrapure glass fiber is the medium used to guide light pulses. Light pulses are generated by the transmitter and detected by the receiver.
- The motivation to use glass fiber instead of copper wire is that the ability to transport a higher bit rate signal more reliably, with fewer errors and over a longer distance.

### 4. Optical amplifier

- An optical signal propagating in a fiber will be attenuated. The optical signal must be amplified to compensate for losses in the fiber.
- Amplifying optical signals is a multi step process. Typically, the optical signal is converted to an electronic signal, then it is amplified, and then it is converted back to optical. This function is known as **regeneration** and it is relatively expensive.
- Another technique to amplify an optical signal is to use an all optical amplifier (OFA). It consists of a fiber segment doped with erbium and pumped with light of wavelength at 980 or 1480 nm. This pumping process excites the erbium atoms in the fiber.
- When the optical signal with a wavelength in the range of 1530-1565 nm pass through the fiber, it causes the excited erbium atoms to yield photons of the same wavelength with the signal. This is known as stimulated emission and the result is more photons out than the photons in and thus an amplified optical signal.
- Amplifiers are of three types :
  - a) Single wavelength digital amplifiers.



- b) Multiwavelength digital amplifiers.
- c) Amplifiers for analog applications such as CATV.

### SONET/SDH Network

- The SONET/SDH network consists of nodes or network elements (NE) that are interconnected with fiber cable over which user and network information is transmitted. Fig. 8.4.2 shows SONET network

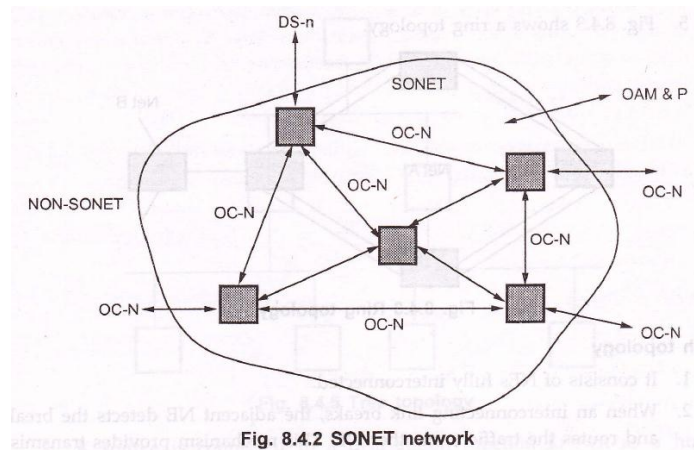

- SONET NEs may receive signals from a variety of facilities such as DS1, DS3, ATM, Internet and LAN/MAN/WAN. They also may receive signals from a variety of network topology.
- SONET NEs must have a proper interface to convert the incoming data format into the SONET format.

### Network Topologies

- Network falls into three topologies :
  1. Ring
  2. Mesh
  3. Tree

#### 1) Ring topology

1. It consists of NEs interconnected with a dual fiber, the primary and secondary, to form a ring.
2. When one of these two fibers breaks, the other fiber in the ring is used. This mechanism provides transmission protection and ring restoration capabilities.
3. If both fiber break, then the network is reconfigured, forming a ring using both the primary and secondary. Information flows in all the fibers but the broken ones.

4. Ring topology offers fast path and is widely used in LANs.
5. Fig. 8.4.3 shows ring topology

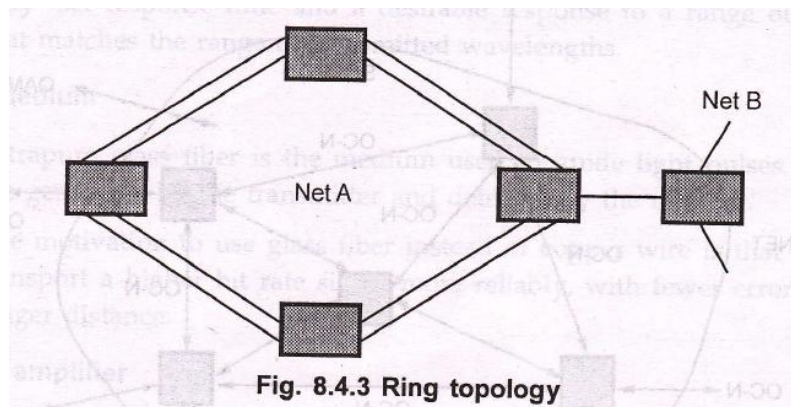

## 2) Mesh topology

- 1) It consists of NEs fully interconnected.
- 2) When an interconnecting link breaks, the adjacent NE detects the breakage and routes the traffic to another NE. this mechanism provides transmission protection and network restoration capabilities.
- 3) Fig. 8.4.4 shows mesh topology

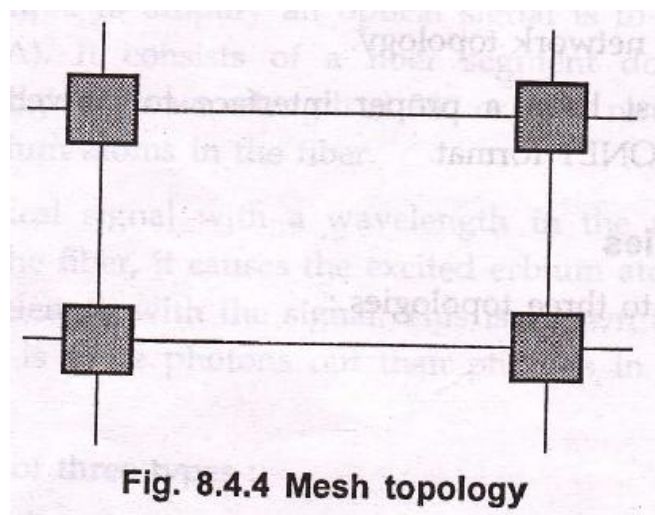

- 4) The mesh topology is better applicable in densely populated areas

## 3) Tree topology

1. it is a hierarchical distribution of NEs and is mostly used in LANs such as Ethernet.
2. Fig. 8.4.5 shows tree topology.

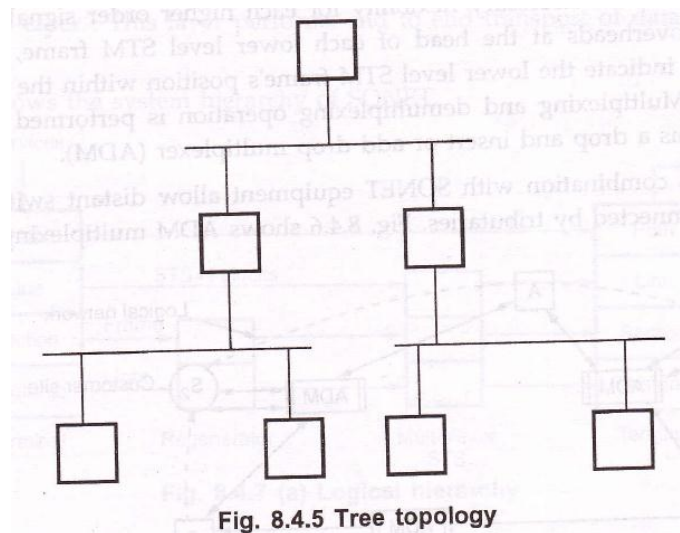

3. A source is connected to a distribution function as a hub, that routes the packet to its destination node. A connection between source and destination is established for the duration of the packet through hub.
4. This network is very efficient for asynchronous data transmission but not for real time data and voice.

### SONET Multiplexing

The SONET specification defines a hierarchy of standardized digital data rates. The basic transmission rate defined in the SDH is 155.52 Mbps and is known as a **synchronous transport module** level 1 signal (STM-1). Higher rates of STM-4 (622 Mbps) and STM-16 (2.4Gbps) are also defined.

- In the SONET hierarchy the term synchronous transport signal(STS) or sometimes optical signal(OC) is used to define the equivalent of an STM signal. An STM-1 signal is produced by multiplexing three such signals together and hence is equivalent to an STS-3/OC-3 signal. As with the plesiochronous digital hierarchy (PDH), the STM-1 signal is comprised of a repetitive set of frames which repeat with a period of 125 microsec. The information content of each frame can be used to carry multiple 1.5/2/6/34/45 or 140 Mbps streams. Each of these streams is carried in a different container which also contains additional stuffing bits to allow for variations in actual rate. To this is added some control information known as the path overhead which allow such thing as the BER of the associated container to be monitored on an end-to-end basis by network management.
- To provide the necessary flexibility for each higher order signal, in addition to the overheads at the head of each lower level STM frame, a pointer is used to indicate the

lower level STM frame's position within the higher order frame. Multiplexing and demultiplexing operation is performed by a device known as drop and insert or add drop multiplexer (ADM).

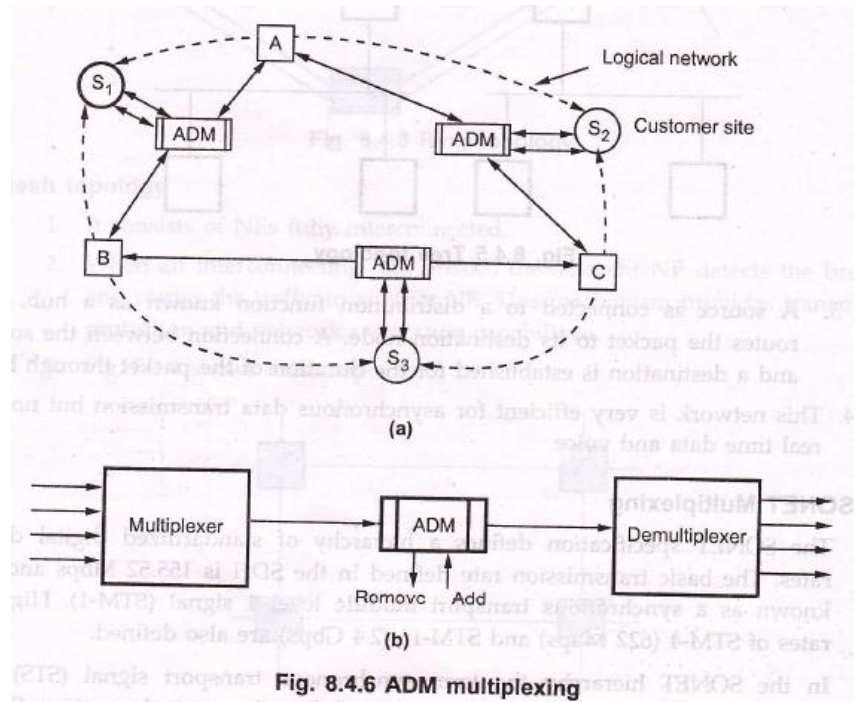
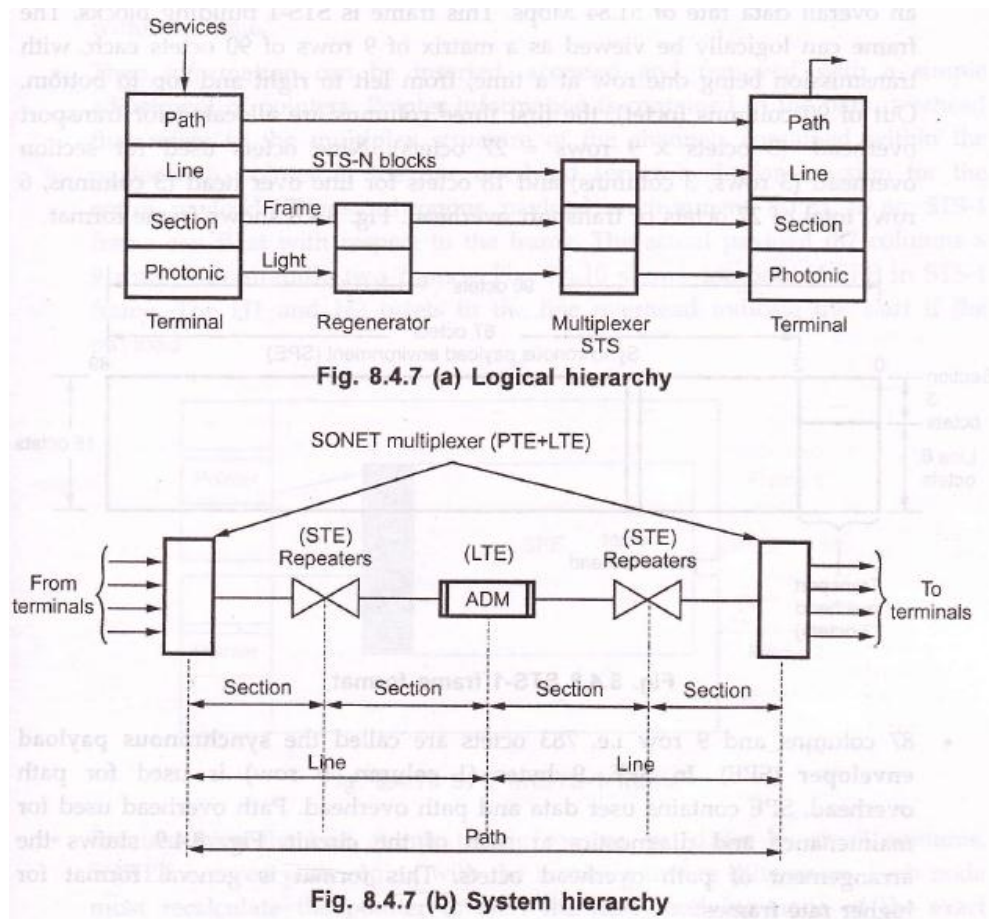

Fig. 8.4.6 ADM multiplexing

### SONET System Hierarchy

- SONET System hierarchy has four layers as mentioned below :
  1. **Photonic layer** : this specifies the types of optical fibers, the minimum required laser power, sensitivity of the receivers and dispersion characteristics of lasers. This is the physical layer.
  2. **Section layer** : This Layer generates SONET frames and convert the electronic signals to photonic signals.
  3. **Line layer** : This Layer synchronizes and multiplexes the data into SONET frame.
  4. **Path layer** : This layer performs end to end transport of data at the proper rate.

Fig 8.4.7 shows the system hierarchy of SONET.



- A section is the two basic physical building block and represents a single run of optical cable between two optical fiber transmitter or receivers. For shorter run the cable may run directly between two end points. For longer distances, repeaters are used. Repeater amplify the signals.
- A line is a sequence of one or more sections such that the internal signal or channel structure of the signal remains constant. Endpoints and intermediate switches or multiplexers that may add or drop channels terminate a line.
- A path connects to end terminals, it corresponds to an end-to-end circuit. Data are assembled at the beginning of a path and are not accessed.

### SONET/SDH Frame

- SONET frame consists of a 810 octets and is transmitted once every 125  $\mu$ s, for an overall data of 51.84 Mbps. This frame is STS-1 building blocks. The frame can logically be viewed as a matrix of 9 rows of 90 octets each, with transmission being one row at a time, from left to right and top to bottom. Out of 90 columns (octet), the first three

columns are allocated for transport overhead. (3 octets X 9 rows = 27 octets). Nine octets used for section overhead (3 rows, 3 columns) and 18 octets for line overhead (3 columns, 6 row) total of 27 octets of transport overhead. Fig. 8.4.8 shows frame format.

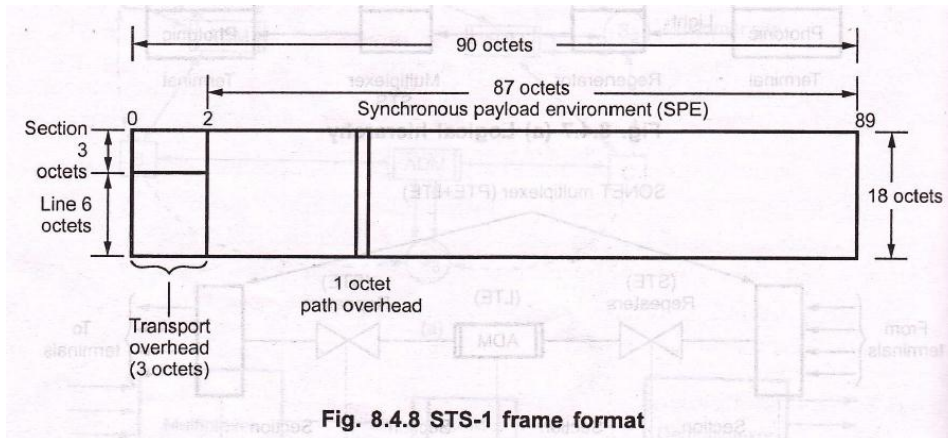

- 87 columns and 9 rows i.e. 783 octets are called the **synchronous payload enveloper (SPE)**. In SPE, 9 bytes (1 column, 9 row) is used for path overhead. SPE contains user data and path overhead. Path overhead used for maintenance and diagnostics at each of the circuit. Fig. 8.4.9 shows the arrangement of path overhead octets. This format is general format for higher rate frames.

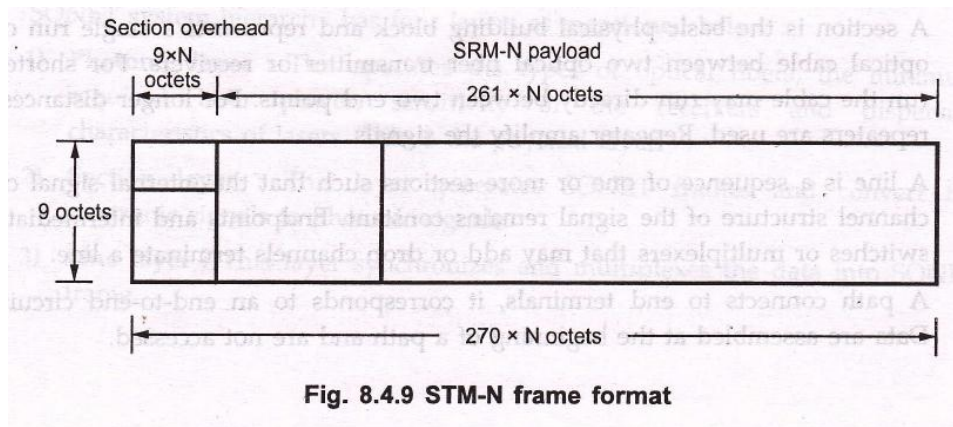

- SONET offers a standard drop-and-insert capability and it applies not just to 64 kbps channels but to higher data rates as well. SONET makes use of a set of pointers that locate channels within a payload and the entire payload within a frame.
- Then information can be inserted, accessed and removed with a simple adjustment of pointers. Pointer information is contained in the path overhead that refers to the multiplex structures of the channels contained within the payload. A pointer in the line overhead serves a similar function for the entire payload. The synchronous payload environment

(SPE) of an STS-1 frame can float with respect to the frame. The actual payload (87 columns X 9 rows) can straddle two frames. Fig. 8.4.10 shows location of SPE in STS-1 frame. The H1 and H2 octets in the line overhead indicate the start of the payload.

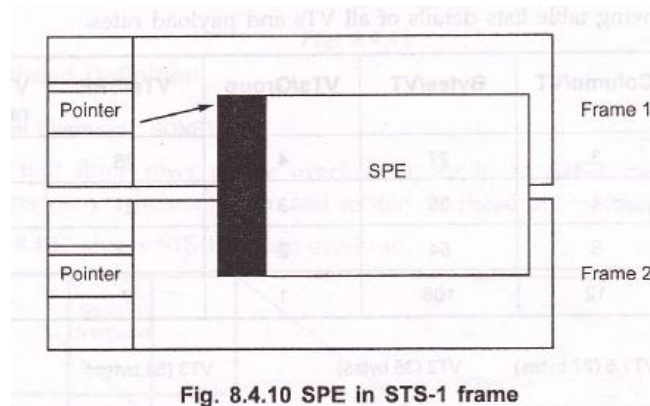

- Because even the best atomic timing sources can differ by small amounts, SONET is faced with coping with the resulting timing differences. Each node must recalculate the pointer to alert the next receiving node of the exact location of the start of the payload.
- The payload is allowed to slip through an STS-1 frame, increasing or decreasing the pointer value at intervals by one byte position. If the payload is higher than the local STS frame rate, the pointer is decreased by one octet position so that the next payload will begin one octet sooner than the earlier payload.
- To prevent the loss of an octet on the payload that is thus squeezed, the H3 octet is used to hold the extra octet for that one frame. If the payload rate lags behind the frame rate, the insertion of the next payload is delayed by one octet.

### Virtual Tributaries (VT)

- VTs are small containers that are used to transport used payloads. In SDH, these small containers are called **virtual containers**.
- VTs come in certain predetermined capacities.
  1. A VT with a 3 column capacity, or a total of 27 bytes, is known as VT1.5.
  2. A VT with a 4 column capacity, or a total of 36 bytes, is known as VT2.
  3. A VT with a 6 column capacity, or a total of 54 bytes, is known as VT6.
  4. A VT with a 12 column capacity, or a total of 108 bytes, is known as VT12.

Fig. 8.4.11 shows a virtual tributaries.

- In SDH, a VT1.5 called a TU-11, a VT2 is called a TU-12 and a VT6 is called a TU-2.
- The following table lists detail sof all VTs and payload rates.

VT Type	Column/VT	Bytes/VT	Vts/Group	VTs/SPE	VT pasyload rate (Mbps)
VT1.5	3	27	4	28	10728
VT2	4	36	3	21	2.304
VT3	6	54	2	14	30456
VT6	12	108	1	7	6.901

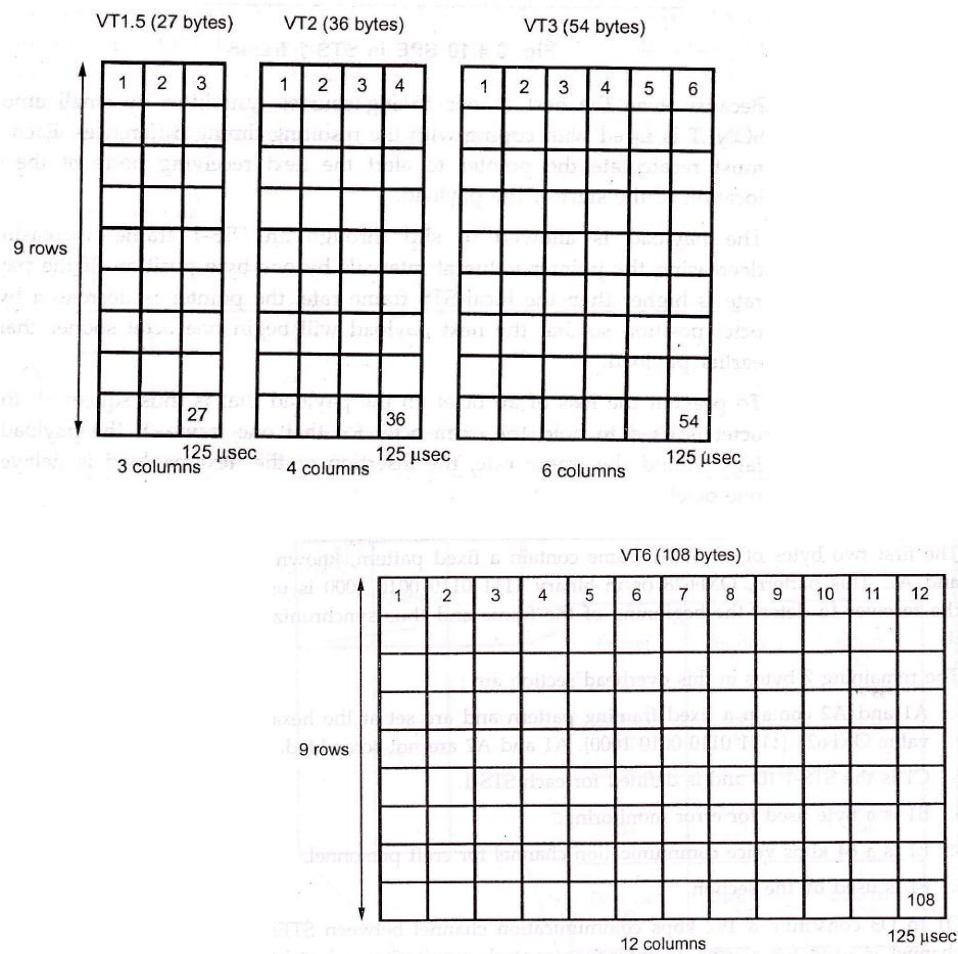

Fig. 8.4.11



## overhead Definition

### Section overhead : SONET

- The first three rows of the overhead space in an STS-1 frame, a total of 9bytes carry synchronization and section overhead information.
- Fig. 8.4.12 shows STS-1 section overhead.

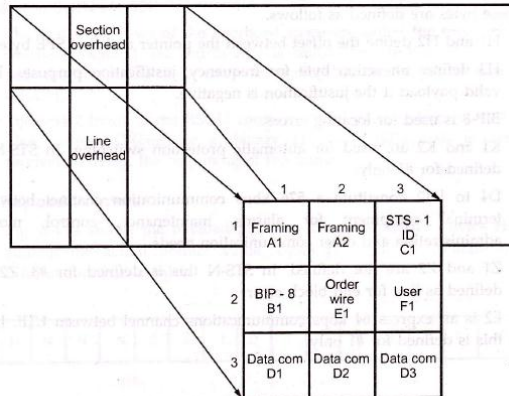

Fig. 8.4.12 STS-1 section overhead

- The first two bytes of an STS-1 frame contain a fixed pattern, known as A1 and A2. This pattern, OXF628 or in binary 1111 0110 0010 is used by the receiver to detect the beginning of the frame and thus synchronize with it.
- The remaining 7 bytes in this overhead section are :
  1. A1 and A2 contain a fixed framing pattern and are set at the hexadecimal value OXF628 (1111 0110 0010 1000). A1 and A2 are not scrambled.
  2. C1 is the STS-1 ID and is defined for each STS-1.
  3. B1 is a byte used for error monitoring.
  4. E1 is a 64 kbps voice communication channel for craft personnel.
  5. F1 is used by the section.
- D1 to D3 constitute a 192 kbps communication channel between STEs. This channel is used for alarms, maintenance control, monitoring, administration and other communication needs.
- In an STS-N signal, this channel is defined for the first STS-1 only. The other N-1 channels are not used.

### Line Overhead : SONET

- Rows 4-9 or a total of 45 bytes, carry the line overhead information and shown in fig. 8.4.13.

- These bytes are defined as follows.
  1. H1 and H2 define the offset between the pointer and first SPE byte.
  2. H3 defines an action byte for frequency, justification purposes. It carries valid payload if the justification is negative.
  3. BIP-8 is used for locating errors.
  4. K1 and K2 are used for automatic protection switching. In STS-N this is defined for #1 only.
  5. D4 and D12 constitute a 576 kbps communication channel between line terminal equipment for alarms, maintenance, control, monitoring, administration and other communication needs.
  6. Z1 and Z2 are not defined. In STS-N this is defined for #3. Z2 is only defined as line for end block error.
  7. E2 is an express 64 kbps communications channel between LTE. In STS-N this is defined for #1 only.

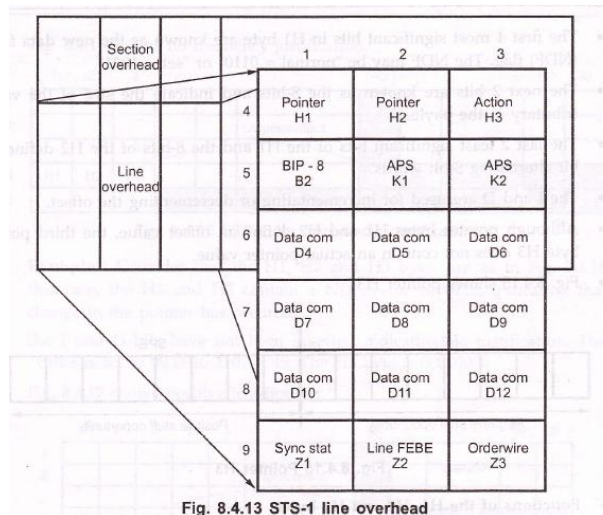

Fig. 8.4.13 STS-1 line overhead

### Section Overhead : SDH

- The first three rows of the overhead space are called the regenerator section overhead (RSOH), the fourth row is called the administrative unit pointer, and the remaining five rows are called the multiplex section overhead (MSOH).
- The first 2 bytes of the RSOH contain a fixed pattern, known as A1 and A2. This pattern, OXF628 or in binary 1111 0110 0010 1000 is used by the receiver to detect the beginning of the frame.

### Payload Pointers

- Fig 8.4.14 shows the payload pointers. The two pointers, bytes H1 and H2, contain the actual pointer value. Bytes H1 and H2 contain much more information than a value

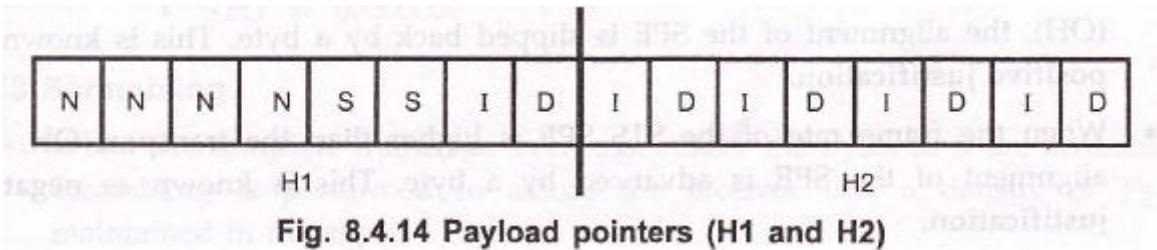

- The first 4 most significant bits in H1 byte are known as the new data found (NDF) flag. The NDF may be “normal = 0110” or “set = 1001”.
- The next 2 bits are known as the S-bits and indicate the size of the virtual tributary in the payload.
- The last 2 least significant bits of the H1 and the 8-bits of the H2 define two bit alternating S-bit words.
- The I and D are used for incrementing or decrementing the offset.
- Although pointer bytes H1 and H2 define an offset value, the third pointer, byte H3 does not contain an actual pointer value.
- Fig. 8.4.15 shows pointer H3.

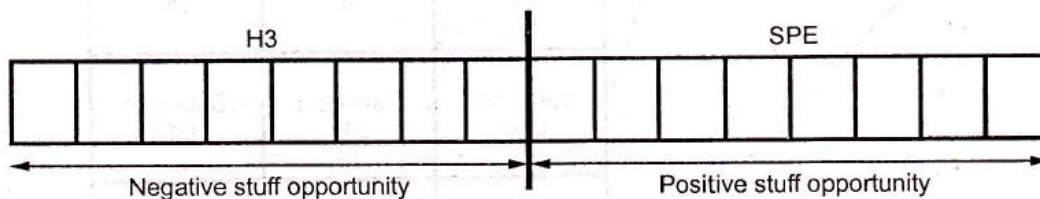

- **Functions of the H1, H2 and H3 bytes**
  1. Identifies that a change has occurred in the pointer value (NDF = 1001) due to an intermittent synchronization change in the node and where the new start is (I + D bits).
  2. Identifies that a change may have occurred in the pointer value (0110) due to a frequency difference between node and incoming frequency.
  3. The bits that contain the pointer values I and D, indicate whether negative or positive frequency justification is necessary.

**Frequency Justification**

- When the frame rate of the STE SPE is the same as the transport overhead, the alignment of the SPE is the same as in the previous frame. This is known as **no justification**.
- When the frame rate of the STE SPE is less than the transport overhead (OH), the alignment of the SPE is skipped back by a byte. This is known as **positive justification**.
- When the frame rate of the STE SPE is higher than the transport OH, the alignment of the SPE is advanced by a byte. This is known as **negative justification**.
- Fig. 8.4.16 shows no frequency justification.

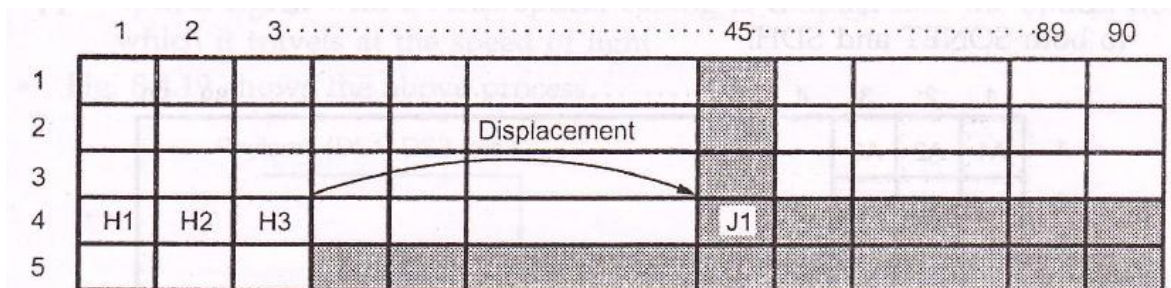
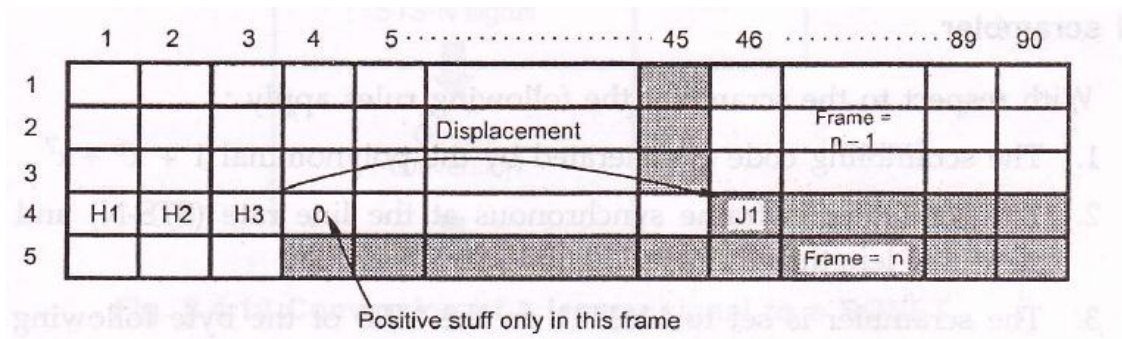

**Fig. 8.4.16 STS-1 No frequency justification**

- **Example :** Consider that the H1, H2 and H3 bytes are as in Fig. 8.4.16. In this case, the H1 and H2 contain a NDF value of 0110, indicating that no change in the pointer has occurred.

The I and D bits have not been inverted indicating no justification. The I, D value is set to 00 0010 1101 = 45. The H3 byte is 00000000.

- Fig. 8.4.17 shows the positive justification.



**Fig. 8.4.17**

H1, H2 = 0110 0010 1000 0101

$$H3 = 00000000$$

$$X = 1\text{-bits inverted}$$

Next frame (n+1) :

$$P_{\text{new}} = P + 1$$

or  $H1, H2 = 0110\ 0000\ 0010\ 1110$

$$H3 = 00000000$$

### Scrambling

- When the complete frame has been assembled, the bytes in it are scrambled. Scrambling is performed to assure the receiver that a density of 1's is maintained in the signal.
- The A1, A2 and C1 bytes are not scrambled and the scrambling process begins with the byte right after C1. This is shown in Fig.8.4.18. this applies to both SONET and SDH.

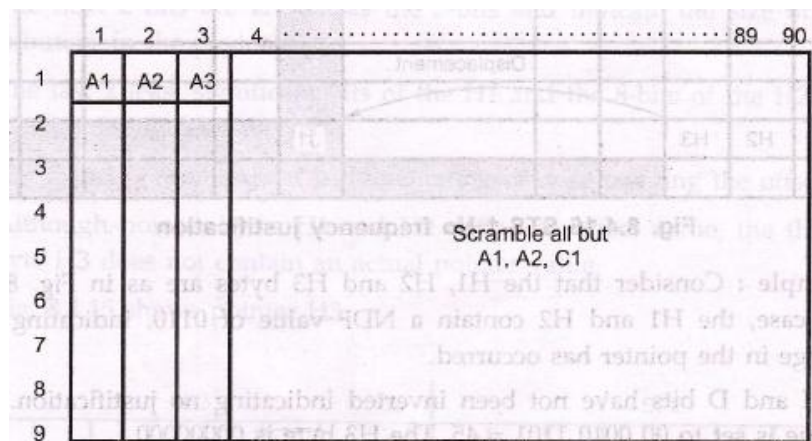

Fig. 8.4.18 Frame scrambled

### STS-N scrambler

- With respect to the scrambler the following rules apply :
  1. The scrambling code is generated by the polynomial  $1+X^6+X^7$ .
  2. The scrambler is frame synchronous at the line rate (STS-N) and it has a sequence length of 127 bits.
  3. The scrambler is set to 11111111 on the MSB of the byte following the Nth STS-1 C4 byte.

4. The framing bytes A1, A2 and the C1 from the first STS-1 through the Nth STS-1 are not scrambled.
5. The scrambler runs continuously throughout the complete STS-N frame.

### Layered Overhead and Transport Functions

- The functional sequence that takes place, for example, from a DS1 signal to a SONET signal, can be summarized as follows :
  1. The incoming DS1 signal at the path layer is mapped onto a VT.
  2. The VT is mapped onto the SPE and the SPE path overhead is also constructed.
  3. The SPE is mapped onto the SONET signal and the line overhead information is added.
  4. The signal is mapped onto the STS-N signal and the section overhead information is added. At this point the complete STS SONET signal is formed and the signal is scrambled.
  5. The signal passes through the electrical to optical transducer and the optical signal with a NRZ optical coding is coupled into the optical fiber in which it travels at the speed of light.
  6. Fig. 8.4.19 shows the above process.

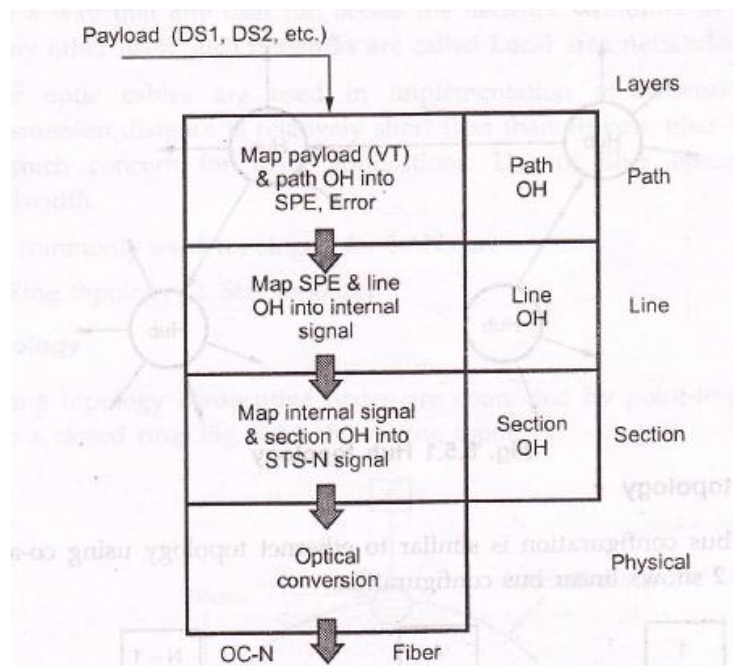

Fig. 8.4.19 Conversion of a legacy signal to a SONET

## Applications

1. High speed backbone networks.
2. Basic architecture for B-ISDN .
3. Basic architecture for ATM.
4. High speed optical network for data communication.

## 8.5 Distributed Networks

- Distributed networks are preferred when data is to be transmitted to a group of subscribers. The transmission distance is relatively short (< 50 km). Examples of distributed networks are – broadcast of video channels over cable TV, telephone and FAX, commonly used topologies for distributed networks are –

1. Hub topology
2. Bus topology

### 1. Hub topology

- In hub topology channel distribution takes at hubs or central locations. Hub facilitates the cross-connect switched channels in electrical domain. Fig. 8.5.1 shows hub topology

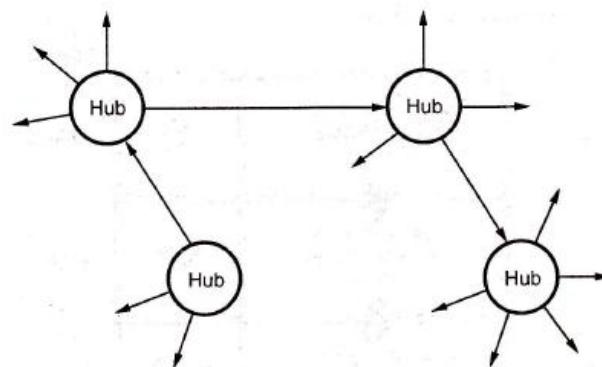
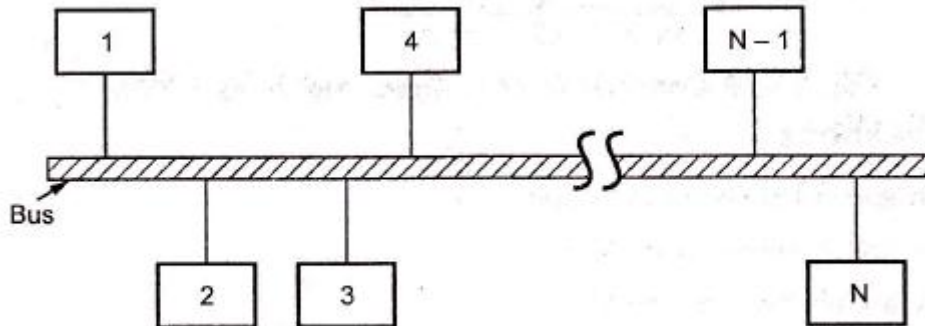

Fig. 8.5.1 Hub topology

### 2. Linear bus topology

- Linear bus configuration is similar to Ethernet topology using co-axial cable. Fig.8.5.2 shows linear bus configuration.



**Fig. 8.5.2 Linear bus topology**

- A single fiber cable carries the multichannel optical signal throughout the area of service. Distribution is done by using optical taps which divert a small fraction of optical power to each station.
- A problem with bus topology is that the signal loss increases exponentially with number of taps for stations. This limits the number of stations or subscribers that can be served by a single optical fiber bus.
- Use of optical amplifiers can boost the optical power of bus and therefore large number of stations can be connected to linear bus as long as the effect of fiber dispersion is negligible.

## 8.6 Local Area Networks (LAN)

- Many applications of fiber optic communication technology require networks in which a large number of users within local campus are interconnected in such a way that any user can access the network randomly to transit data to any other user. Such networks are called Local area networks (LANs).
- Fiber optic cables are used in implementation of networks. Since the transmission distance is relatively short (less than 10 km), fiber losses are not at much concern for LAN applications. Use of fiber optic offers a large bandwidth.
- The commonly used topologies for LANs are –
  1. Ring topology
  2. Star topology

### 1. Ring topology

- In ring topology consecutive nodes are connected by point-to-point links to form a closed ring. Fig.8.6.1 shows ring topology.



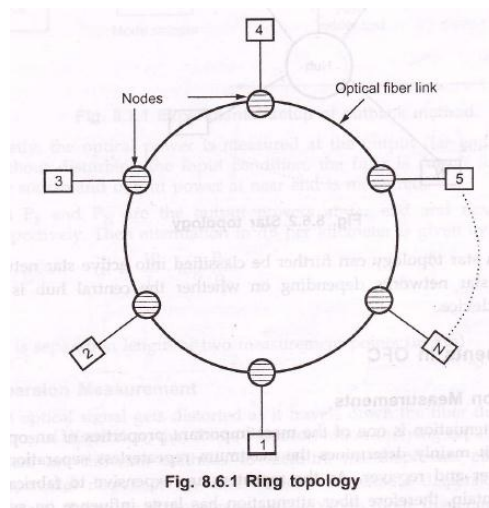

- Each node can transmit and receive data by using a transmitter receiver pair. A token (predefined bit sequence) is passed around the ring. Each node monitors the bit stream to listen for its own address and to receive the data.
- The use of ring topology for fiber optic LANs is known as fiber distributed data interface (FDDI). FDDI operates at 100 Mb/s with multimode fibers. It can provide backbone services e.g. interconnection of lower speed LAN.

## 2. Star topology

In star topology, all nodes are connected through point-to-point link to central node called a hub. Fig. 8.6.2 shows star topology.

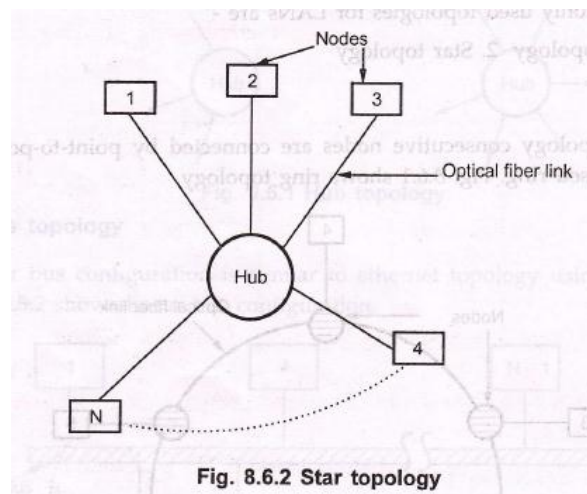

- LANs in star topology can further be classified into active star networks and passive star networks depending on whether the central hub is active or passive device.

## 8.7 Measurements in OFC

### Attenuation Measurements

- Signal attenuation is one of the most important properties of an optical fiber because it mainly determines the maximum repeaterless separation between transmitter and receiver. As the repeaters are expensive to fabricate, install and maintain, therefore fiber attenuation has large influence on system cost and equally important in signal distortion.
- The distortion mechanism in a fiber cause optical signal pulses to border as they travel along a fiber. When these pulses travel sufficiently far, they eventually overlap with neighbouring pulses creating errors in receiver output. This signal distortion mechanism limits the information carrying capacity of fiber.
- For determining attenuation in fibers three major techniques are used.
  1. Cutback technique
  2. Insertion loss method
  3. OTDR trace.

### Cutback technique

- Cutback technique is a destructive method of measuring attenuation. It requires access to both ends of fiber as shown in Fig. 8.7.1.

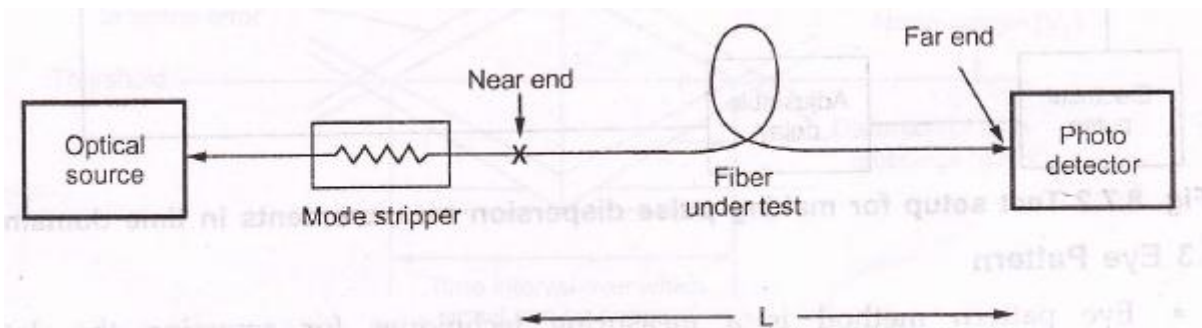

Fig. 8.7.1 Experimental setup of cutback method

- Firstly, the optical power is measured at the output (far end) of fiber. Then without disturbing the input condition, the fiber is cut-off few meters from the source and output power at near end is measured.
- Let  $P_F$  and  $P_N$  are the output powers at far end and near ends of fiber respectively. Then attenuation in dB per kilometer is given by expression.

$$\alpha = \frac{10}{L} \cdot \log \frac{P_N}{P_F}$$

where

$L$  is separation length of two measurement point (in km).

### Dispersion measurement

- An optical signal gets distorted as it travels down the fiber due to three basic forms of dispersion, that limits the information carrying capacity.
- There are different methods to measure the dispersions effects. Such as : intermodal dispersion in time domain, intermodal dispersion in frequency domain, chromatic dispersion and polarization mode dispersion.

### Time-domain Intermodal Dispersion Measurements

- Time-domain intermodal dispersion measurement involves injecting a narrow pulse of optical energy into one end of an optical fiber and detect the broadened output-pulse at the other end. This set up for this measurement is shown in the Fig. 8.7.2

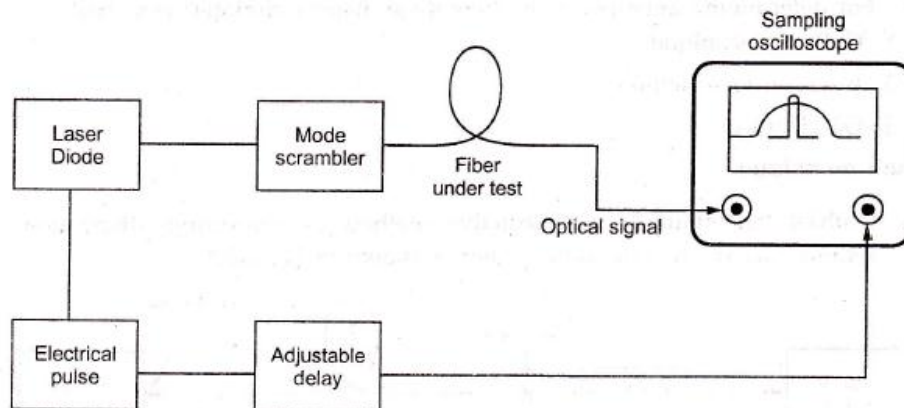

Fig. 8.7.2 Test setup for making pulse dispersion measurements in time domain

### Eye pattern

- Eye pattern method is a measuring techniques for assessing the data handling ability of digital transmission system. The eye-pattern measurements are made in time domain and allow the effects of waveform distortion to observe on oscilloscope. Fig. 8.7.3 shows test setup for making eye diagram measurement.

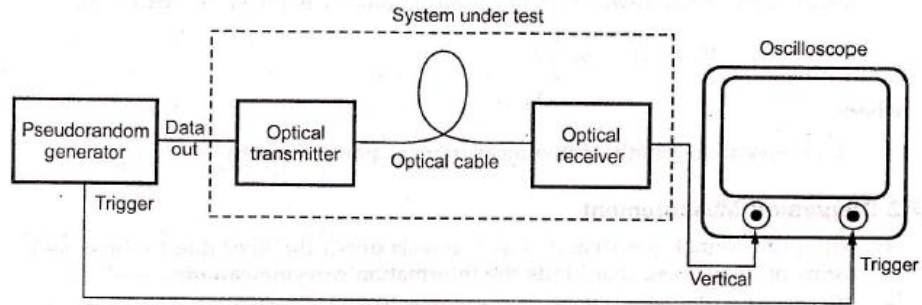

Fig. 8.7.3 Setup for Eye-diagram Measurement

- To measure performance of system various word patterns must be provided Various measurement from eye pattern can be done are –
  - Noise margin
  - Timing jitter
  - Rise time
  - Non linearity of channel
- A simplified eye diagram showing key performance parameters is illustrated in fig. 8.7.4

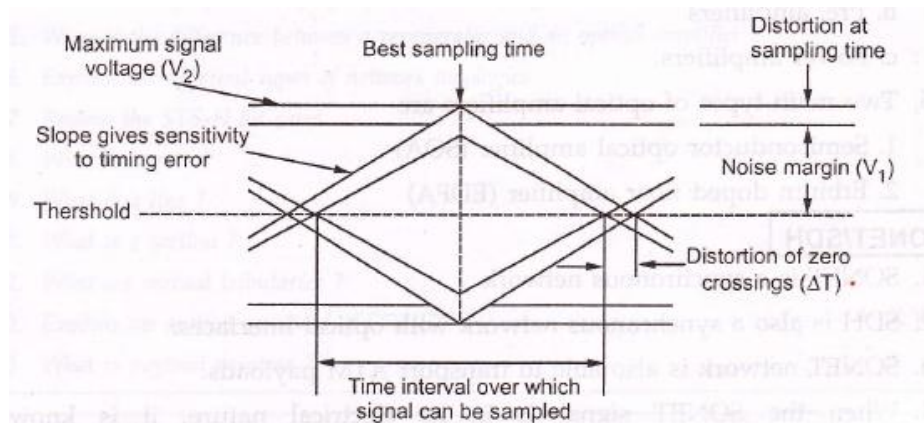
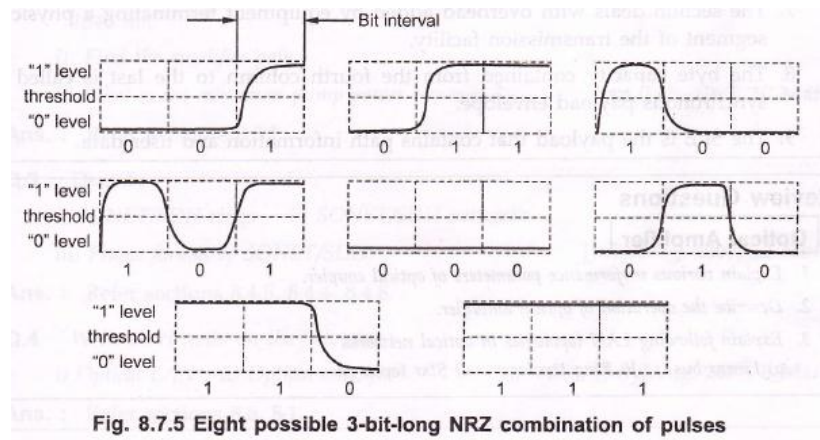

Fig. 8.7.4 Simplified Eye-diagram with key performance parameters

- The display pattern formed can be understood by considering 8 combinations of 3-bit long NRZ code. The 8 patterns are superimposed simultaneously forming an eye pattern. Fig. 8.7.5 shows 8 possible 3-bit long NRZ combinations of pulses with moderate rise and fall times.
- Optical Amplifier**



## SONET/SDH

### Recommended Questions

#### Optical Amplifier

1. Explain various performance parameters of optical coupler.
2. Describe the operation of optical amplifier.
3. Explain following LAV topologies in optical networks –
  - a) Linear bus
  - b) Ring topology
  - c) Star topology
4. Give nearest neighbor budget for linear bus topology.
5. Explain comparative performance of star and linear bus network.
6. List the non-linear effects in fiber optic communications.

## SONET/SDH

1. Review the similarities and differences between SONET and SDH.
2. What is the OC-3 bit rate and what is STM-1 bit rate?
3. Why to use SONET/SDH?

4. Explain the components of optical.
5. What is the difference between a regenerator and an optical amplifier?
6. Explain the different types of network topologies.
7. Review the STS-N bit rates.
8. What is a path?
9. What is a line?
10. What is a section?
11. What are virtual tributaries?
12. Explain the section overhead of SONET.
13. What is payload pointers?