

SYSTEM-FREE ACCESSORIES CATALOGUE



Edition 04.2017
Ref. No. 8103.256

Quality management
certified according
to ISO 9001:2008
by German TÜV-CERT



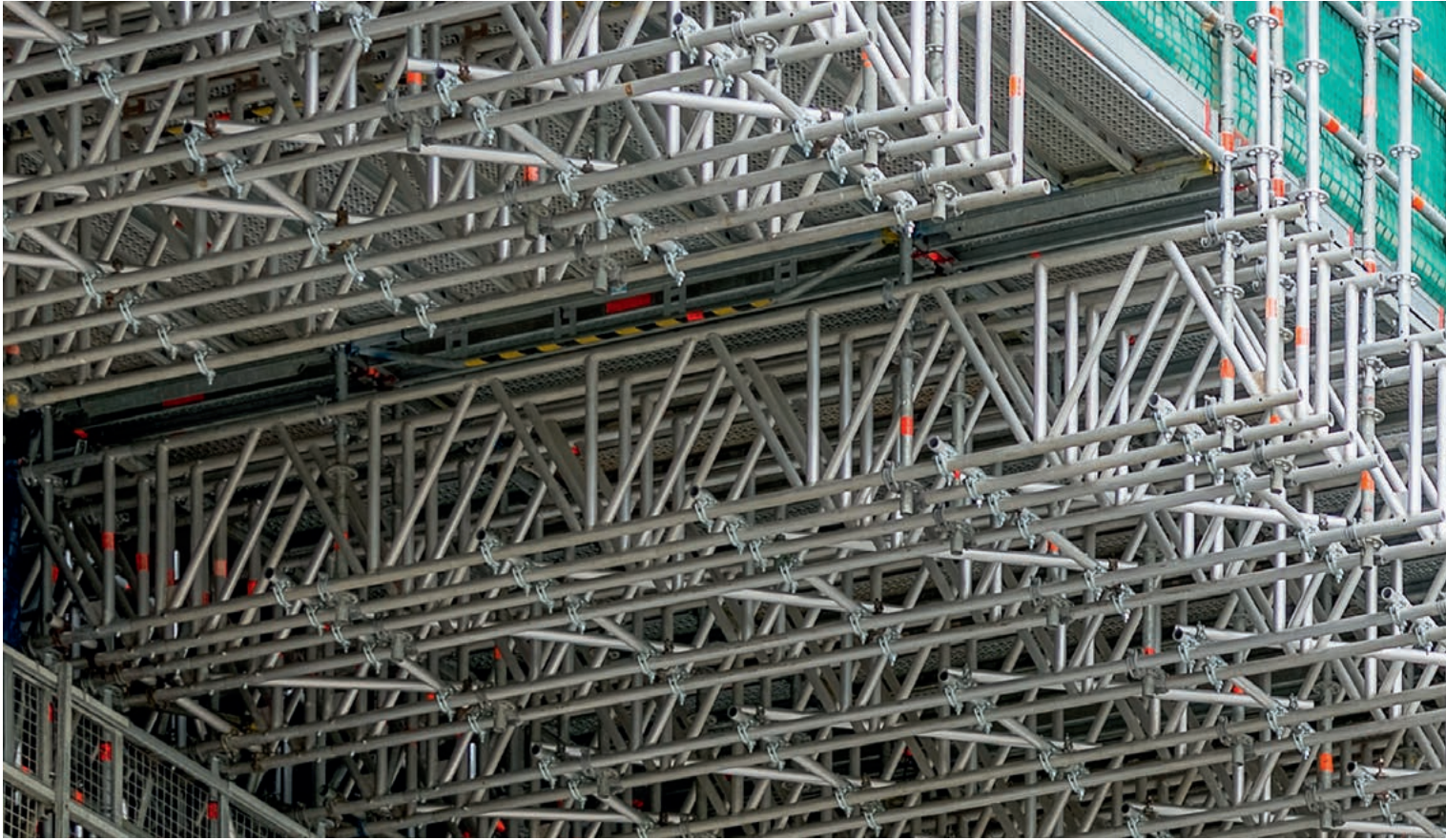

COMPANY FROM PAGE 4



Quality "Made by Layher"	4
More Speed	5
More Experience	5
More Knowledge	5
More Clarity	5
More Quality	5

MAIN ACCESSORIES FROM PAGE 6

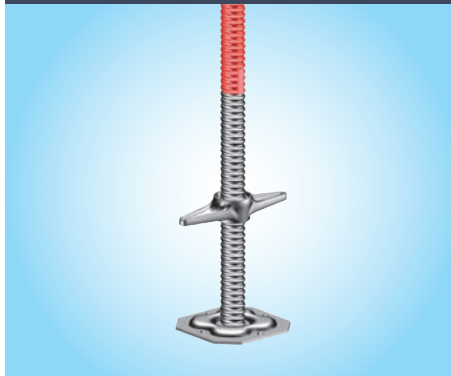

Base plates and accessories	6
Lattice beams, lattice beams connectors, section beams	6
Scaffolding tubes, couplers, spare parts	12
Tools	14
Anchoring	16
Testing and measuring equipment, scaffolding identification	16

ADVANCED ACCESSORIES FROM PAGE 18

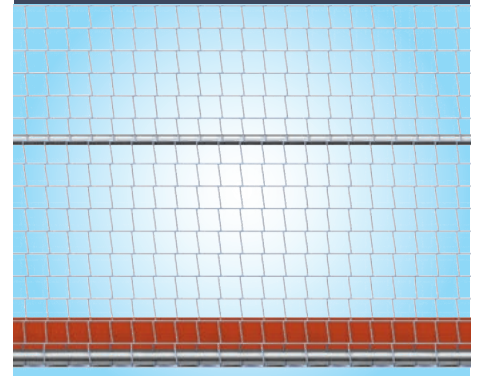

Suspended scaffolding, standard brick guard and protection for pedestrians	18
Parts for rolling towers	20
Scaffolding enclosures	22
Ladder access	24
Scaffolding pallets	26
Bridging	28
Scaffolding boards	30



PLANNING AND SAFETY FROM PAGE 30



Software for scaffolding construction	30
Fall protection	32
Vertical transport	34
Various accessories	36

PRODUCT PORTFOLIO



The Layher product range – all catalogues at a glance	
Speedyscaf System	Ref. No. 8102.258
Allround Scaffolding	Ref. No. 8116.254
System-free Accessories	Ref. No. 8103.256
Protective Systems	Ref. No. 8121.256
Event Systems	Ref. No. 8111.229
Access Technology	Ref. No. 8118.228

NOTICE

All dimensions and weights are guideline values, Subject to technical modification.

Steel components are galvanized according to EN ISO 1461 and DAST guideline 022. Connection parts are galvanized according to EN ISO 4042.

Our deliveries shall be made exclusively in accordance with our currently valid General Terms of Sale. These include the following provisions: The place of performance is Gueglingen-Eibensbach. Title to the delivered goods shall be retained until full payment has been made.

Please request the specific instructions for assembly and use when ordering. Protected by copyright. Not to be reproduced, either in whole or in part. Misprints and errors excepted.

QUALITY MADE BY LAYHER



Headquarters in Eibensbach



Plant 2 in Gueglingen

HERE IS THE BEATING HEART OF LAYHER.

Quality made by Layher comes from Gueglingen-Eibensbach. Our company has set down deep local roots since it was established. Right up until today, development, production, logistics and management are all in one place, where the conditions are best for achieving quality made by Layher: in Gueglingen-Eibensbach. The two locations together cover a surface area of 318,000 m². This includes more than 142,000 m² of covered production and storage areas. This is where our scaffolding systems are created by highly automated production. Short distances and short reaction times mean we can adapt production to suit our customers' requirements, flexibly and at any time.

MORE POSSIBILITIES. THE SCAFFOLDING SYSTEM.

This brand promise made by Layher is the expression of a brand philosophy that we've been living by for over 70 years. More speed, more safety, more proximity, more simplicity and more future: values with which we strengthen our customers' competitiveness in the long term. With our innovative systems and solutions, we're working all the time on making scaffolding construction even simpler, even more economical and, above all, even safer. With comprehensive services, a permanent range of training courses and an ethos of customer focus, more than 1,600 dedicated Layher employees are creating more possibilities for our customers every single day. In more than 40 countries all over the world.



MORE INFORMATION

Discover the world of Layher in its company film at:

yt-image-en.layher.com



MORE SPEED

We can supply large quantity of the right products at the right time – to anywhere in the world. Layher has subsidiaries in more than 40 countries in all five continents, with a tight-knit network of national service centers. Speed is also the motto of our logistics concept. Customers have the choice of picking up their material at a Layher service center or having it delivered either to a warehouse or “just in time” directly to the site.



MORE EXPERIENCE

Tradition has grown into experience and expertise. Our experts pass on this knowledge – all over the world. Existing customers might want to try a different approach, while new customers might need support when assembling a Layher scaffolding structure. Layher’s specialists get to grips with the specific tasks and requirements, devising for our customers persuasive solutions that are both profitable and efficient. Good advice from Layher is guaranteed. We take care of our customers at every level, because cooperation with them on the basis of mutual trust as well as their success are important to us.



MORE KNOWLEDGE

Further training is the key to success. For this reason, Layher organizes regular training seminars that prepare our customers for current and future challenges specifically in scaffolding. This training scheme is backed up by many other options, for example practical product training courses and regular meetings for scaffolding erectors to promote the flow of information between experts and colleagues. And last but not least, Layher offers comprehensive publications on topics to do with scaffolding construction.

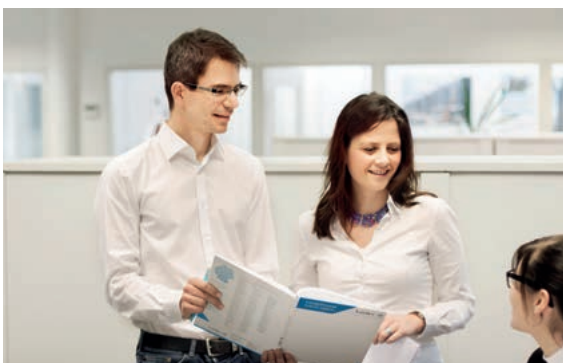

MORE CLARITY

Saving time, using material in the best way, improving logistics. All that can be done with Layher’s planning software LayPLAN CLASSIC and LayPLAN CAD. Layher software means greater reliability when budgeting and planning scaffolding construction projects. Optimization of inventory management and complete cost transparency for the material used in a project. Once the dimensions and the required assembly variant have been entered, the Layher software supplies a scaffolding proposal with matching material list within seconds.



MORE QUALITY

People talk a lot about quality. We just produce it. Quality from Layher means state-of-the-art production processes, carefully selected materials, smart automation and a highly qualified workforce. Our products comply with the latest security standards and possess DIN ISO certification. German TÜV approval, and many other German and international quality labels. 21,000 kilometres of steel tubing in high-quality workmanship are convincing testimony to Layher’s quality standards.

Base plates and accessories

To adjust to the ground, choose between the non-height-adjustable **base plate 1** or height-adjustable **base plates 2-6** with sturdy and selfcleaning round threads, with colour and notch markings to provide protection against overwinding. Make sure that there are sufficient load-distributing surfaces.

The round threads of all Layher scaffolding spindles have an outside diameter of 38 mm and a pitch of 8.1 mm. The wing external dimension of the spindle nut is 205 mm. The dimensions of the foot plate are 150 x 150 mm.

Base plate (normal) $\hat{=}$ 4.5 mm wall thickness

Base plate (reinforced) $\hat{=}$ 6.3 mm wall thickness

Base plate / head jack solid $\hat{=}$ solid material

Load capabilities of spindle cross-section as per DIN EN 12811-1, Annex B

Spindle type	Npl.d [kN]	Mpl.d [kNcm]	Vpl.d [kN]
normal	97.7	83.0	36.0
reinforced	119.9	94.5	44.1
solid	288.0	157.0	106.0

The **swivelling head jack 8** can be used to install supports (e.g. wood sections) with an inclination of up to max. 5 % to the horizontal in the longitudinal and transverse directions, thus eliminating the need to level with a wedge. Greater loads can be supported thanks to the articulated mounting of the top plate and the resulting centric introduction of vertical forces into the spindles.

The **cross head jack 45, solid 10** serves to accommodate wood sections, glued binders or steel beams in falsework and supporting scaffolding. It stabilises the supports against tilting, and it is possible to use one or two formwork supports. Height adjustment is performed using the spindle nut. The cross head jack is suitable for all common formwork supports.

The **protective base for base plates 11** conserves sensitive floorings from damages made of the base plate. By using the **adjustment plate 12**, base plates with steep plate can be used on inclined ground. By turning the top against the bottom part, the inclination from 0 to 16 % can be adjusted. The load increasing static remains completely.

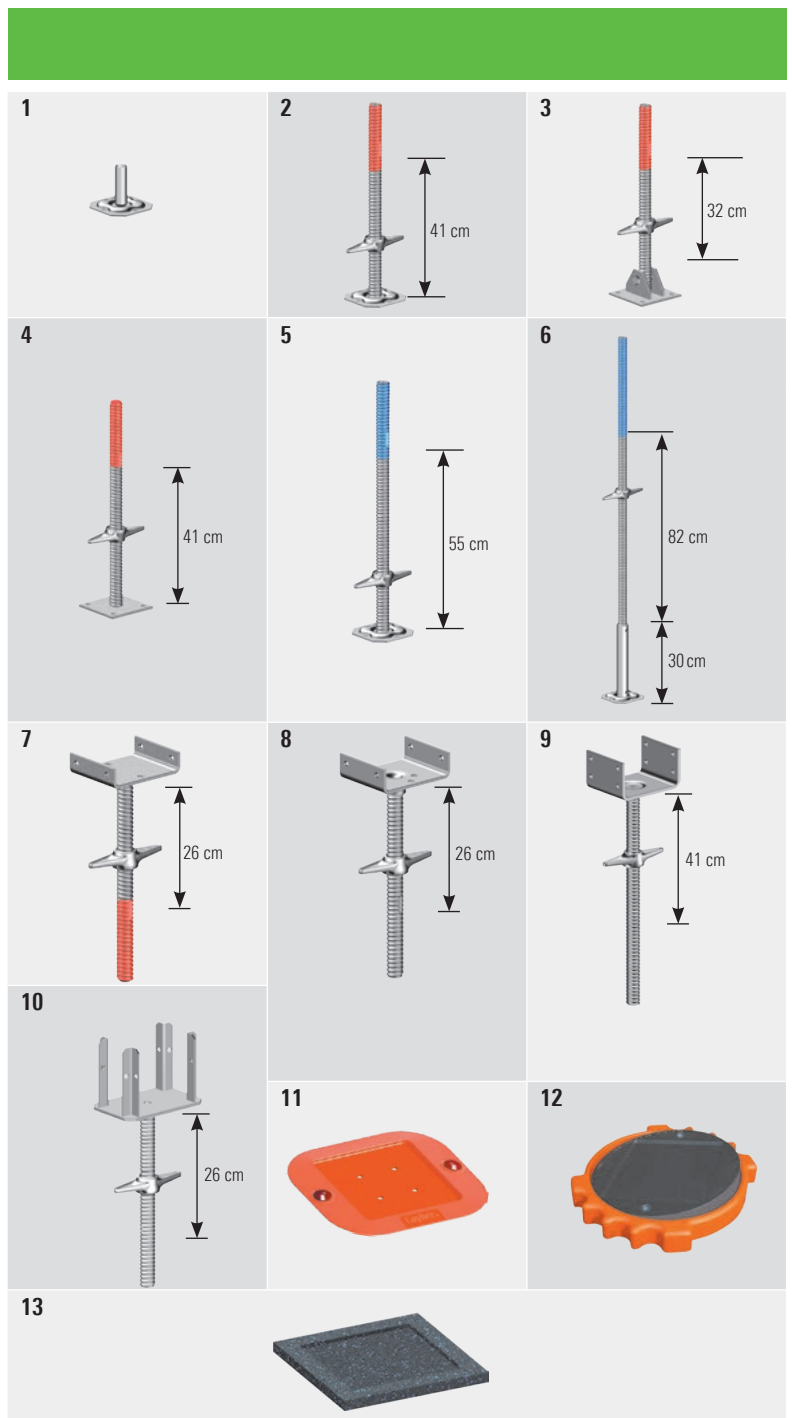

Lattice beams, lattice beam connectors

Lattice beams of steel and aluminium are used to provide:

- ▶ Bridging
- ▶ Projections and strengthening
- ▶ Roof structures and enclosures
- ▶ Surface scaffolding

The top and bottom chords and the end posts have an external diameter of 48.30 mm and are designed for the connection of scaffolding couplers

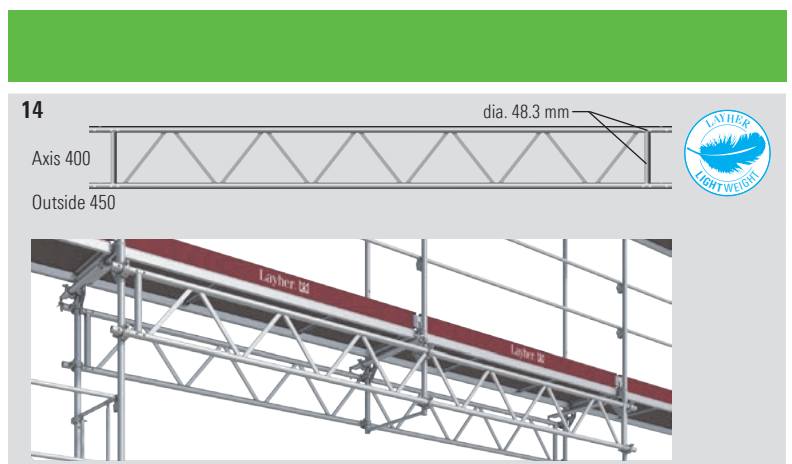

Pos.	Description	Dimensions L/H x W [m]	Weight approx. [kg]	PU [pcs.]	Ref. No.
1	Base plate without height adjustment	0.11	1.0	250	4001.000
2	Base plate 60 (max. spindle travel 41 cm)	0.56	3.6	200	4001.060
3	Swivelling base plate 60 , reinforced (max. spindle travel 32 cm), ensure sufficient structural strength	0.58	5.5	250	4003.000
4	Base plate 60 , solid, without lock (max. spindle travel 41 cm)	0.58	6.7	200	5602.060
5	Base plate 80 , reinforced (max. spindle travel 55 cm)	0.73	4.9	200	4002.080
6	Base plate 150 , reinforced (max. spindle travel 82 cm), ensure sufficient structural strength	1.50	10.0	25	4002.130
7	Head jack 45 , solid, 16 cm (max. spindle travel 26 cm), width of fork 16 cm	0.45	6.6	50	5314.045
8	Swivelling head jack 45 , solid, 16 cm (max. spindle travel 26 cm), width of fork 16 cm	0.45	7.3	50	5312.045
9	Head jack 60 , reinforced, 18 cm (max. spindle travel 41 cm), width of fork 18 cm	0.60	8.0	100	5316.060
10	Cross head jack 45 , solid (max. spindle travel 26 cm), opening dimensions 8.50 / 17 cm	0.45	6.9	50	5315.045
11	Protective base for base plate of polypropylene, with 2 reflectors	0.27 x 0.24	2.1	10	4007.005
12	Adjustment plate for base plate of glass-fibre-reinforced polyamide plastic, inclination 0 – 16 %	dia. 0.30	1.25	250	4000.400
13	Rubber pad for base plate for slip-reduction on solid grounds like concrete, asphalt, stone or timber. Protects sensitive deckings from damages.	0.20 x 0.20	0.4		4000.500

Pos.	Description	Dimensions L/H x W [m]	Weight approx. [kg]	PU [pcs.]	Ref. No.
14	Steel system lattice beam 450 LW , 45 cm high, 2.25 m long 3.25 m long 4.25 m long 5.32 m long 6.32 m long 	2.25 x 0.45	21.8	40	4925.225
		3.25 x 0.45	30.9	40	4925.325
		4.25 x 0.45	40.0	40	4925.425
		5.32 x 0.45	49.5	40	4925.532
		6.32 x 0.45	59.0	40	4925.632

Lattice beams, lattice beam connectors

The lattice beams Ref. Nos. 4925, 4922, 4902 and 4903 are connected to one another using **unit beam spigot T4 dia. 38 mm 2** and **lattice beam hinged pins, dia. 12 mm 4** or **special bolt M12 x 60, with nut 5**.

For lattice beams 4925, 4922, 4902, 4903 and 4906 the following applies: the standard lengths are extended using lattice beam connectors. Loading tables available on request.

In conjunction with the **unit beam spigots T4 dia. 38 mm, cranked 3** and standard lattice beams, 45 cm high, made from aluminium or steel, double-pitch roof structures (roof pitch 11°) can be built.

Steel lattice beams 750 6, 75 cm high, of steel design, are used to support high loads or to bridge wider spans. Loading tables available on request.

The heavy-duty lattice beams Ref. No. 4906 are connected to one another with **unit beam spigots round steel 7** and **lattice beam bolts dia. 14 x 77 mm 8**, with **safety clip 2.8 mm 9**, or **special bolts M14 x 65 mm, with nut 10**.

The **aluminium lattice beam 750 11** is the lighter alternative for supporting higher loads or for bridging wider spans. Loading tables available on request.

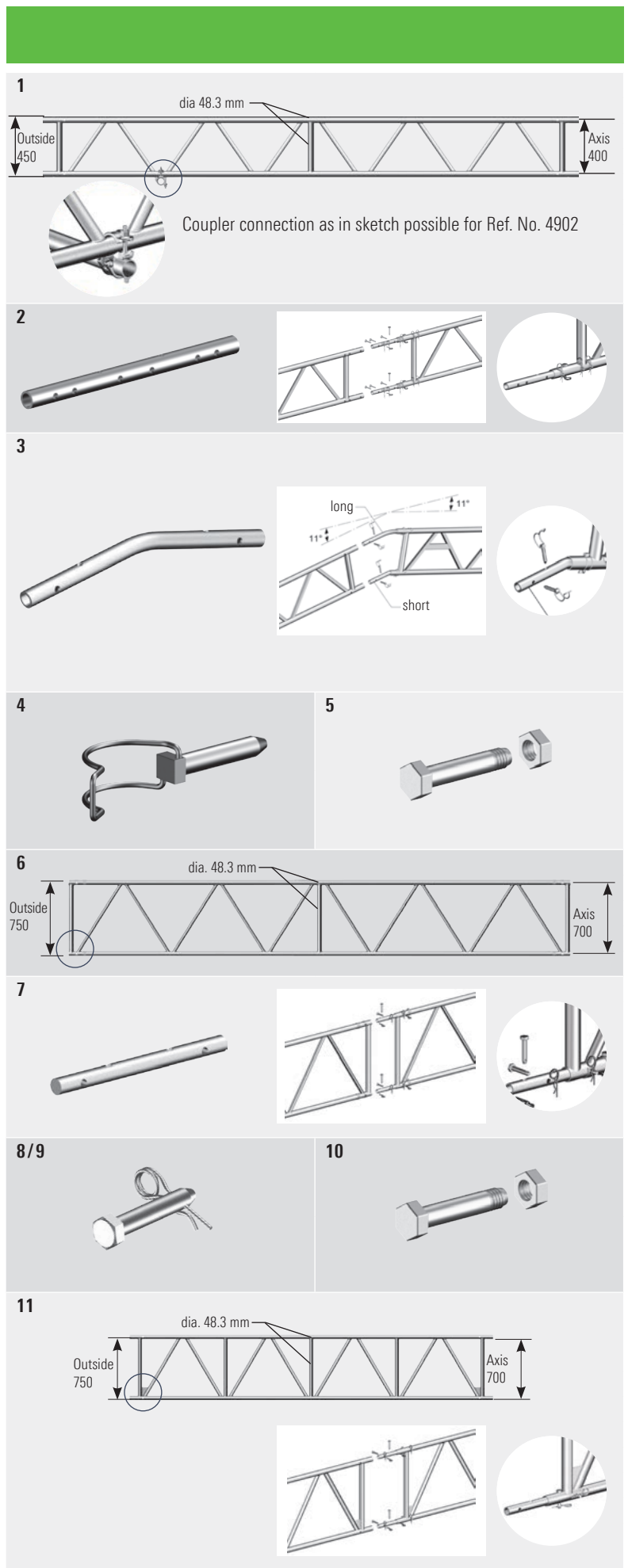

Pos.	Description	Dimensions L/H x W [m]	Weight approx. [kg]	PU [pcs.]	Ref. No.
1	Aluminium lattice beam 450 , 45 cm high, aluminium, more than 50 % weight saving compared to steel 2.00 m long, with type calculation 3.00 m long, with type calculation 4.00 m long, with type calculation 5.00 m long, with type calculation 6.00 m long, with type calculation 8.00 m long, with type calculation				
		2.00 x 0.45	8.5	50	4902.200
		3.00 x 0.45	13.5	50	4902.300
		4.00 x 0.45	17.1	50	4902.400
		5.00 x 0.45	21.0	50	4902.500
		6.00 x 0.45	23.6	50	4902.600
		8.00 x 0.45	32.7	50	4902.800
		2	Unit beam spigot T16 , dia. 38 mm for straight extension of lattice beam Ref. Nos. 4912, 922, 4902, 4903, 4925	0.54	2.4
3	Unit beam spigot T4 , dia. 38 mm, cranked, long for angular extension of lattice beam (45 cm high) at top chord, for double-pitch roof structures, roof pitch 11°	0.62	2.6	350	4922.001
	Unit beam spigot T4 , dia. 38 mm, cranked, short for angular extension of lattice beam (45 cm high) at top chord, for double-pitch roof structures, roof pitch 11°	0.48	1.9	350	4922.002
4	Lattice beam hinged pin , dia. 12 mm, with pan head	Required: 4 pcs. each	2.0	20	4905.667
5	Special bolt M12 x 60 , with nut	Required: 4 pcs. each	4.0	50	4905.061
6	Steel lattice beam 750 , 75 cm high 2.00 m long 3.00 m long 4.00 m long 5.00 m long 6.00 m long 7.00 m long				
		2.00 x 0.75	35.5	20	4906.200
		3.00 x 0.75	48.5	20	4906.300
		4.00 x 0.75	61.0	20	4906.400
		5.00 x 0.75	78.0	20	4906.500
		6.00 x 0.75	90.0	20	4906.600
		7.00 x 0.75	102.5	20	4906.700
7	Unit beam spigot , round steel, dia. 36 mm for extending lattice beam Ref. No. 4906	0.44	3.4	20	4916.000
8	Lattice beam pin , dia. 14 x 77 mm	Required: 4 pcs. each	2.2	20	5906.078
9	Safety clip , 2.8 mm	Required: 4 pcs. each	0.5	50	4905.001
10	Special bolt M14 x 65 , with nut	Required: 4 pcs. each	6.5	50	4908.066
11	Aluminium lattice beam 750 , 75 cm high, aluminium 2.25 m long, with type calculation 3.25 m long, with type calculation 4.25 m long, with type calculation 5.25 m long, with type calculation 6.25 m long, with type calculation 7.25 m long, with type calculation				
		2.25 x 0.75	14.0	25	4903.225
		3.25 x 0.75	19.5	25	4903.325
		4.25 x 0.75	26.0	25	4903.425
		5.25 x 0.75	32.1	25	4903.525
		6.25 x 0.75	38.1	25	4903.625
		7.25 x 0.75	44.2	25	4903.725

Lattice beams, lattice beam connectors, section beams

The **aluminium tri-lite beam 1** is a lightweight multipurpose beam. It is suitable for use as a beam subjected to bending stress, as a vertical support and as a light crosspiece, and is resistant to buckling and tilting without additional stiffening. External dimensions 45 x 45 x 45 cm, coupler connection dia. 48.3 mm possible, extension of beams with lattice beam connectors Ref. No. 4922.000 and special bolts Ref. No. 4905.060 or bolts Ref. No. 4905.065 with safety clips Ref. No. 4905.000. Loading tables available on request.

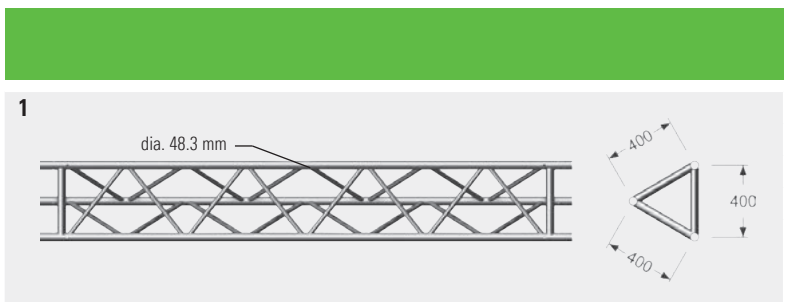

Tri-struts LW 2 are designed for high loadbearing applications, also in temporary hall construction in conjunction with lattice beams Ref. Nos. 4912, 4922, scaffolding tubes and couplers. They therefore serve as supporting structures for mono-pitch and double-pitch roofs and for special solutions. The three scaffolding tubes of the triangular support each have an external diameter of 48.3 mm and a wall thickness of 2.7 mm. The tri-strut has external dimensions of 22 x 22 x 22 cm and is designed for the connection of dia. 48.3 mm scaffolding couplers. Loading tables available on request.

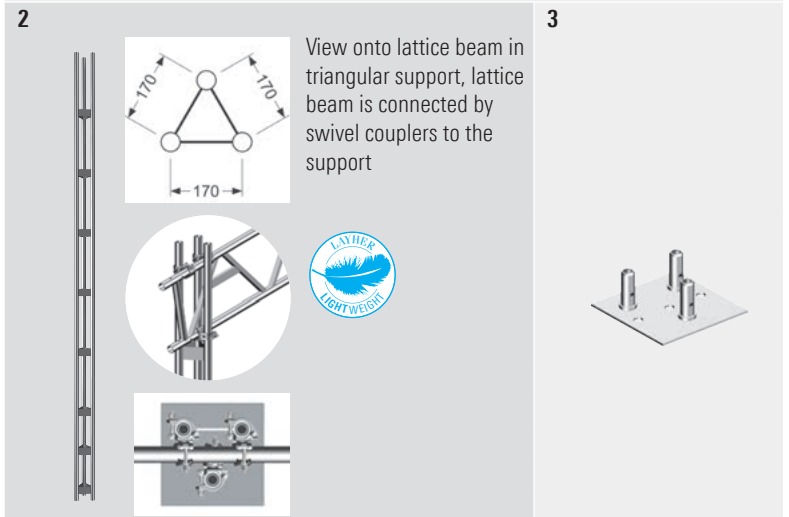

The **three-point base plate 3** is used to form the base for the tri-strut and to divert the load into the ground.

Aluminium U-profile with half couplers 4

For screwing on a lattice beam to carry serial decks; Working surface without any trip hazards. Thanks to the half couplers, the U-profile can be installed on any lattice beam with tubing dia. 48.3 mm.

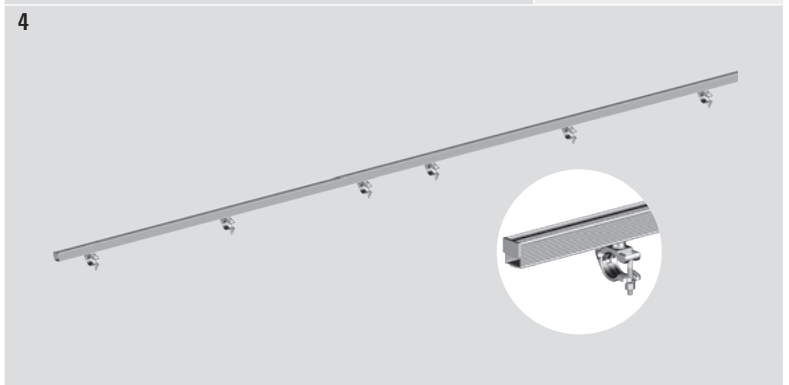

Lattice beam mounting 0.40 m 6

Wall connection for standard lattice beams Ref. Nos 4912, 4922 and 4902 for bridging structures and similar, structural strength calculation required.

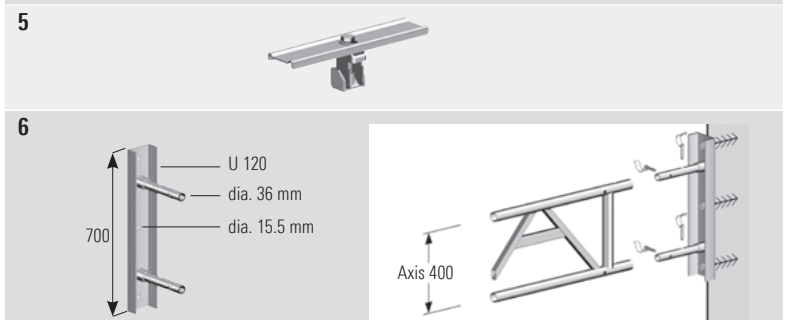

The **aluminium section beam with wood 7** is a lightweight aluminium beam with low overall height for birdcage scaffolding, walkways and bridging. Double-webbed beam of aluminium, 160 mm high, 1 flange 115 mm wide, with T-groove for connections with grooved bolts, 1 flange 100 mm wide, with replaceable wood section insert, for nailed or bolted connections. Loading tables available on request.

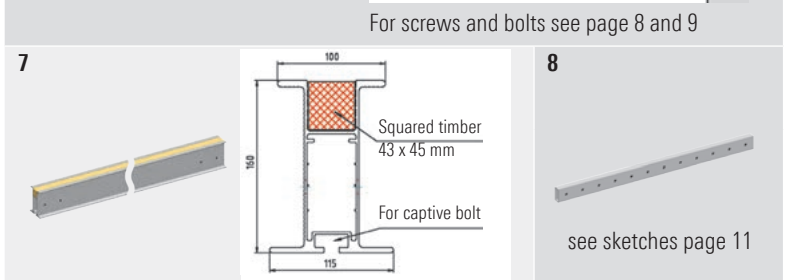

Beam connector, 1.20 m 8

Holes drilled 10 cm apart. For continuous straight-line extension of aluminium section beams – variable joint. Permits adjustment of the aluminium section beams to the site dimensions. Rectangular tube, 40 x 80 mm cross section, steel, hot-dip galvanized.

Pos.	Description	Dimensions L/H x W [m]	Weight approx. [kg]	PU [pcs.]	Ref. No.
1	Aluminium tri-lite beam				
	3.00 m long	3.00 x 0.45	25.0	9	4917.300 🏠
	4.00 m long	4.00 x 0.45	34.0	9	4917.400 🏠
	5.00 m long	5.00 x 0.45	41.0	9	4917.500 🏠
	6.00 m long	6.00 x 0.45	50.0	9	4917.600 🏠
2	Tri-strut LW, steel, hot-dip galvanized				
	3.00 m long	3.00 x 0.22	36.2	35	4911.300 🏠
	4.00 m long	4.00 x 0.22	47.3	35	4911.400 🏠
	5.00 m long	5.00 x 0.22	59.9	35	4911.500 🏠
	6.00 m long	6.00 x 0.22	71.0	35	4911.600 🏠
3	Three-point base plate, hot-dip galvanized for tri-strut LW No. 4911	0.30 x 0.30	6.7	50	4911.000 🏠
4	Aluminium U-profile with half couplers				
	3.00 m long	19 WS 3.00	7.1		4909.319 🕒
	3.00 m long	22 WS 3.00	7.1		4909.322 🕒
	3.25 m long	19 WS 3.25	7.7		4919.319 🕒
	3.25 m long	22 WS 3.25	7.7		4919.322 🕒
	4.00 m long	19 WS 4.00	9.3		4909.419 🕒
	4.00 m long	22 WS 4.00	9.3		4909.422 🕒
	4.25 m long	19 WS 4.25	9.9		4919.419 🕒
	4.25 m long	22 WS 4.25	9.9		4919.422 🕒
	5.00 m long	19 WS 5.00	11.5		4909.519 🕒
	5.00 m long	22 WS 5.00	11.5		4909.522 🕒
	5.32 m long	19 WS 5.32	12.2		4919.519 🕒
	5.32 m long	22 WS 5.32	12.2		4919.522 🕒
	6.00 m long	19 WS 6.00	13.8		4909.619 🕒
	6.00 m long	22 WS 6.00	13.8		4909.622 🕒
	6.32 m long	19 WS 6.32	14.5		4919.619 🕒
6.32 m long	22 WS 6.32	14.5		4919.622 🕒	
5	Universal U-Lift-off preventer	19 WS	1.0	200	2635.000 🏠
6	Lattice beam mounting, 0.40 m	0.70	12.1	80	4920.040 🏠
7	Aluminium section beam with wood, with riveted-in wood section, with holes drilled for connection by means of beam connectors				
	3.00 m long	3.00	18.0		4026.300 🕒
	4.00 m long	4.00	24.0		4026.400 🕒
8	Beam connector, 1.20 m	1.20	6.6	100	4026.000 🕒
9	Beam connector bolt M12 x 70, with nut		0.7	10	4026.002 🕒



For connecting individual **aluminium section beams with wood** **6** Ref. No. 4026 a **beam connector 7, 1.20 m** Ref. No. 4026.000 and four **beam connector bolts 8 M12 x 70,** with nut Ref. No. 4026.002 are required for each.

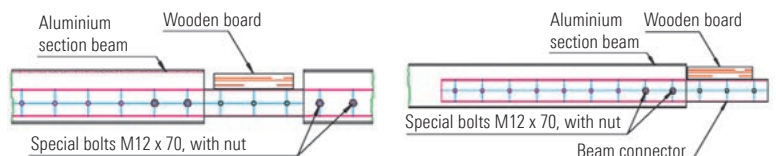

WS = wrench size PU = packaging unit 🏠 = available ex works 🕒 = delivery time on request 🏠 = only available in this packaging unit ⚙️ = the approval process is not yet completed

Scaffolding tubes and couplers

General assembly and extension

Standardised scaffolding tubes in steel (hot-dip galvanized) or aluminium permit, in conjunction with scaffolding couplers, special assembly and extension outside the regular version.

The **33 mm steel tube. 1.50 m 2** is intended for use with the steel deck T4. Special assemblies differ from the regular version, their stability must be verified.

Scaffolding couplers

connections, in steel, drop-forged; as per DIN EN 74 and general building authority approval from the DIBt (German Civil Engineering Institute). Tightening torque of collar nuts 50 Nm.

The **half-coupler with hook 4** becomes in conjunction with a steel scaffolding tube a length-adjustable wall tie.

Lattice beam coupler 11









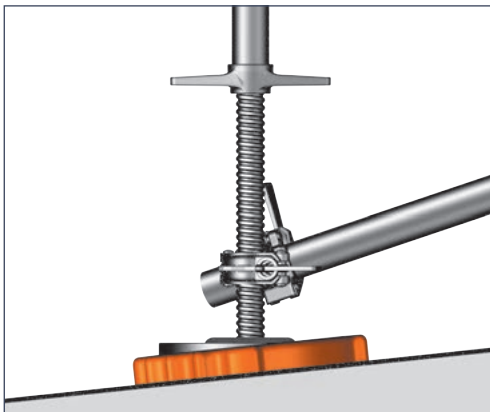

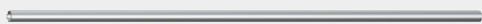

Example for use of the lattice beam coupler

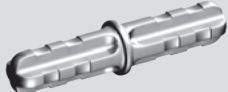
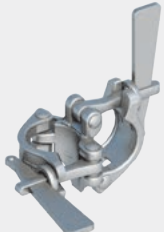
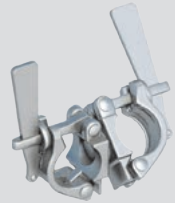
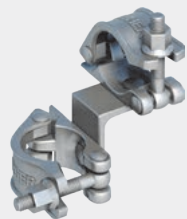
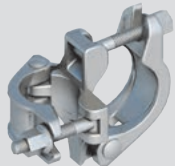

Wedge swivel coupler 14

Example of the use of the Wedge spindle swivel coupler

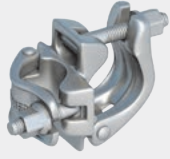

<p>1</p> 		<p>4</p>  <p>Is used in conjunction with Ref. No. 4600 for anchoring.</p> 	
<p>2</p> 			
<p>3</p> 			
<p>5a/b</p>  <p>For right-angled connection of tubes with dia. 48.3 mm</p>	<p>6a/b</p>  <p>For connection at any angle of tubes with dia. 48.3 mm</p>	<p>7</p>  <p>For connection of two tubes with dia. 48.3 mm in one axis. Only in conjunction with EN spigot Pos. 8</p>	
<p>8</p>  <p>Only in conjunction with sleeve coupler Pos. 7</p>		<p>9</p>  <p>For right-angled connection of tubes with dia. 48.3 mm</p>	
		<p>10</p>  <p>For connection at any angle of tubes with dia. 48.3 mm</p>	
<p>11</p>  <p>For 90° connection on the axis of tubes with dia. 48.3 mm</p>		<p>12</p>  <p>For right-angled connection of a tube dia. 33.7 mm to a tube of dia. 48.3 mm</p>	
		<p>13</p>  <p>For connection at any angle of a tube dia. 33.7 mm to a tube of dia. 48.3 mm</p>	
<p>14</p>  <p>For connection of a tube dia. 48.3 mm to a scaffolding spindle at any angle</p>		<p>15</p>  <p>For right-angled connection of a tube dia. 60.3 mm to a tube of dia. 48.3 mm</p>	
		<p>16</p>  <p>For connection at any angle of a tube dia. 60.3 mm to a tube of dia. 48.3 mm</p>	

Pos.	Description	Dimensions L/H x W [m]	Weight approx. [kg]	PU [pcs.]	Ref. No.
1	Scaffolding tube , steel, hot-dip galvanized Scaffolding tubes dia. 48.3 x 4.0 mm, as per DIN EN 29	0.50	2.3	61	4600.050
		1.00	4.5	61	4600.100
		1.50	6.8	61	4600.150
		2.00	9.0	61	4600.200
		2.50	11.3	61	4600.250
		3.00	13.5	61	4600.300
		3.50	15.8	61	4600.350
		4.00	16.7	61	4600.400
		5.00	22.7	61	4600.500
		5.50	25.0	61	4600.550
	6.00	25.2	61	4600.600	
2	33 mm steel tube , 1.50 m Scaffolding tubes dia. 33.7 x 2.25 mm	1.50	3.0	100	4603.150
3	Scaffolding tube , aluminium Scaffolding tubes dia. 48.3 x 4.0 mm	0.50	0.8	61	4601.050
		1.00	1.5	61	4601.100
		1.50	2.3	61	4601.150
		2.00	3.8	61	4601.200
		2.50	3.7	61	4601.250
		3.00	4.5	61	4601.300
		3.50	5.3	61	4601.350
		4.00	6.0	61	4601.400
		4.50	6.8	61	4601.450
		5.00	7.5	61	4601.500
		5.50	8.3		4601.550
	6.15	9.2	105	4601.600	
	8.00	12.1		4601.800	
4	Half coupler with hook		0.8	25	4749.019
5a	Double coupler Class BB, EN 74-1 RA BB C3 M quality-monitored, for use in class B and BB on steel and aluminium tube	19 WS	1.3	25	4700.019
		22 WS	1.3	25	4700.022
5b	Double coupler with coarse thread Description as Pos. 5a acc. to approval Z-8.331-947	19 WS	1.3	25	4777.019
		22 WS	1.3	25	4777.022
6a	Swivel coupler Class B, EN 74-1 SW B C3 M. quality-monitored, for use in class B on steel and aluminium tube	19 WS	1.4	25	4702.019
		22 WS	1.5	25	4702.022
6b	Swivel coupler with coarse thread Description as Pos. 6a acc. to approval Z-8.331-947	19 WS	1.5	25	4778.019
		22 WS	1.5	25	4778.022
7	Sleeve coupler Class B, EN 74-1 SF B C3 M, quality-monitored, for use in class B on steel and aluminium tube	19 WS	1.8	25	4703.019
		22 WS	1.8	25	4703.022
8	Internal spigot Description as Pos. 7	0.20	1.2	25	4739.000
9	Wedge double coupler Class B, DIN EN 74-B-C, on steel and aluminium tube		1.6	25	4727.000
10	Wedge swivel coupler Class A, DIN EN 74-A-C, on steel and aluminium tube		1.8	25	4728.000
11	Lattice beam coupler for lattice beam and tubes dia. 48.3 mm	19 WS	1.6	25	4720.019
		22 WS	1.6	25	4720.022
12	Reduction double coupler , 48.3 x 33.7 mm	19 WS	1.3	25	4737.019
		22 WS	1.3	25	4737.022
13	Reduction swivel coupler , 48.3 x 33.7 mm	19 WS	1.6	25	4738.019
		22 WS	1.6	25	4738.022
14	Wedge spindle swivel coupler		1.8	25	4735.000
15	Reduction double coupler , 60.3 x 48.3 mm	22 WS	1.9	25	4744.022
16	Reduction swivel coupler , 60.3 x 48.3 mm	22 WS	2.3	25	4745.022

WS = wrench size PU = packaging unit = available ex works = delivery time on request = only available in this packaging unit = the approval process is not yet completed

Scaffolding tubes, couplers, spare parts

Half-couplers

with screw and wedge connection for use on steel and aluminium tubes in accordance with approval Z-8.331-882.

Wedge half-coupler 5

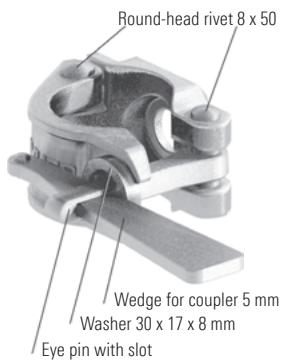

Double coupler Page 12 Pos. 5

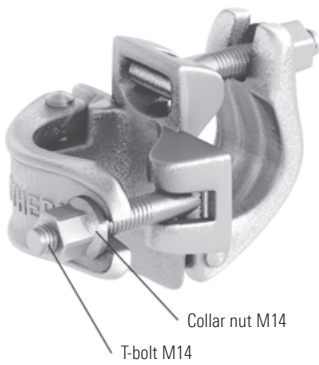

Half-coupler 6

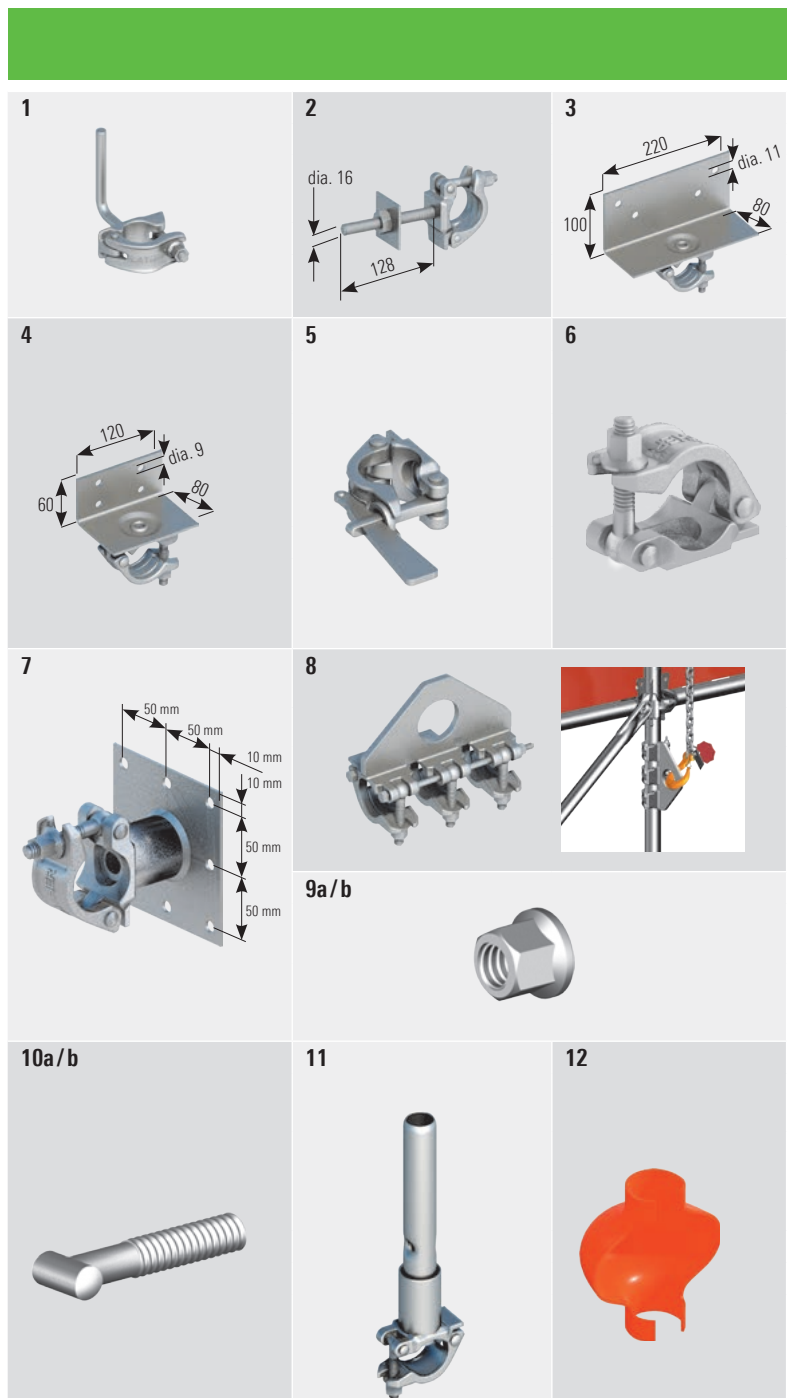

Tools

The high-quality **scabbling pick 16** on the hammer head ensures a consistently safe use. The additional hardened inner tube provides a standard breaking strength. In addition, the reinforced scabbling pick has a patented head-stem-connection, which also forgives failures. The orange handle provides good handling, good cushioning and low-fatigue working.

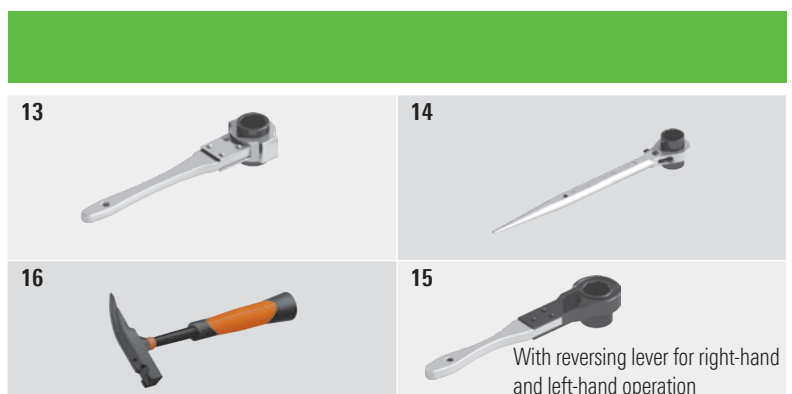

Pos.	Description		Dimensions L / H x W [m]	Weight approx. [kg]	PU [pcs.]	Ref. No.
1	Half-coupler with toe board pin	19 WS		1.0	25	4708.019
		22 WS		1.0	25	4708.022
2	Combination coupler connects scaffolding tubes to wooden parts	19 WS		1.1	25	4711.019
3	Squared timber coupler, large with steel bracket for holding wood sections, e.g. 10 x 12 cm	19 WS	0.22	1.9	25	4717.019
		22 WS		1.9	25	4717.022
4	Squared timber coupler, small with steel bracket for holding wood sections, e.g. 8 x 8 cm	19 WS	0.12	1.4		4718.019
		22 WS		1.4		4718.022
5	Wedge half-coupler Class A, quality-monitored, with approval Z-8.331-882, for use in class A on steel and aluminium tube			0.9	25	4729.000
6	Half-coupler with eye bolt Class B, quality-monitored, with approval Z-8.331-882, for use in class B on steel and aluminium tube	19 WS		0.8	25	4707.019
		22 WS		0.8	25	4707.022
7	Half-coupler with plate Connection of wall panels to scaffolding tubes	19 WS	0.12 x 0.12	1.5	250	4705.019
8	Crane eyelet coupler for crane positioning of roofs, scaffolding with a perm. load capacity of 14.1 kN upright or parallel to the tube axis	19 WS		3.3		4724.019
		22 WS		3.3		4724.022
9a	Collar nut standard thread M14	19 WS		1.8	50	6494.707
		22 WS		1.5	50	6494.708
9b	Collar nut standard thread M14 for rapid coupler, acc. to approval Z-8.331-947	19 WS		1.8	50	6494.553
		22 WS		2.4	50	6494.554
10a	T-bolt standard thread M14 82 mm			4.5	50	6494.537
10b	T-bolt standard thread M14 82 mm, for rapid coupler, acc. to approval Z-8.331-947			4.6	50	6494.555
11	Spigot with half coupler for extension on dia. 48.30 mm	19 WS	0.30	1.8	250	4706.019
		22 WS		1.8	250	4706.022
12	Cover for coupler with integrated reflector polyethylene, fixing with disposable tie 6241.001 (s. page 25, Pos. 4)			1.2	10	4007.009

Pos.	Description		Dimensions L / H x W [m]	Weight approx. [kg]	PU [pcs.]	Ref. No.
13	Ratchet spanner with reinforced head	19 WS	0.32	0.7		4740.019
		22 WS		0.7		4740.022
14	Ratchet wrench for 19 and 22 mm widths across flats, with reversing lever for right-hand and left-hand operation, mandrel for ring bolts	19 / 22 WS	0.32	0.6		4747.000
15	Scaffolding ratchet with reversing lever for right-hand and left-hand operation	19 WS	0.32	0.7		4726.019
		22 WS		0.7		4726.022
16	Scabbling pick 600 g reinforced		0.32	0.9		4421.051

WS = wrench size PU = packaging unit = available ex works = delivery time on request = only available in this packaging unit = the approval process is not yet completed

Anchoring

The scaffolding must be anchored vertically to and parallel with the façade with resistance to both tensile and compressive stress. Layher offers speedy and safe solutions:

Wall tie, 0.38 m 1, connected using one double coupler to an upright tube.

2 wall ties, 0.38 m 1, connected in a V shape with double couplers to the inner standard.

Wall ties, 0.95 m / 1.45 m / 1.75 m 1, connected using two double couplers to both upright tubes.

The optimum combination of the **ring screw 3** and **plastic wall insert 2** ensures high holding strengths. The high-quality welded connection prevents bending open of the eyelet.

The screw-in mark allows the screw-in process to be visually monitored.

High steel strength and zinc coating guarantee long-term use.

The anchoring forces in accordance with the approval or individual verification of structural strength can vary widely. The loading capacity of the anchoring, in particular of the anchoring foundation, must be carefully checked and verified.

The load-bearing capacity of the plug connection must be checked with the Layher **insert testing instrument 16** (see below) in accordance with our instructions for assembly and use. The plug test must be documented. Please comply with the plug manufacturer's installation instructions.

The **ETICS-tie** is constructed for carrying high loads, parallel to the façade, in use together with external thermal insulation compound systems. Assembly information, see instructions for assembly and use.

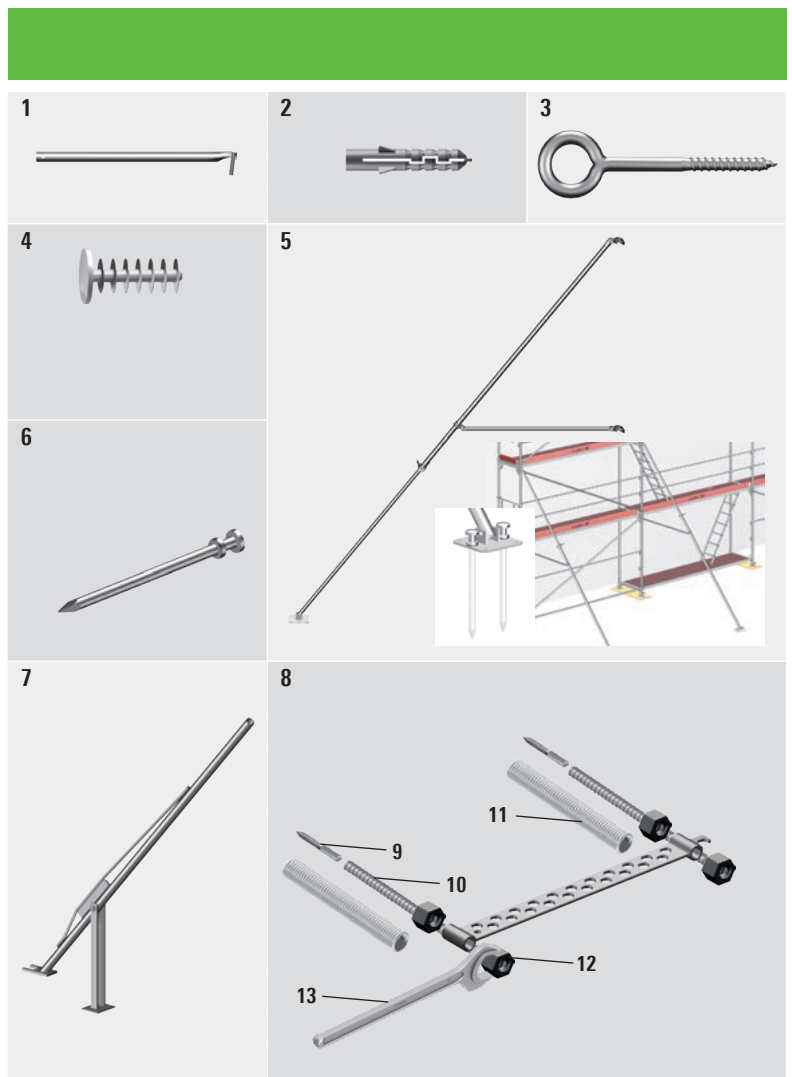

Testing and measuring equipment, scaffolding identification

In our instructions for assembly and use, the plug-test is described. The regulations must always be respected.

Plug-testing device, hydraulic 14

Hand-operated, hydraulic plug-testing device in practical case, which allows plug-testing easily and reliably. With a continuous measuring range from 0-20 kN with a high accuracy of $\pm 2.5\%$. The test loads are shown on the manometer and recorded in the test report.

Identification and prohibition signs for work scaffolding as per DIN EN 12811-1.

The three-piece **scaffolding identification pad 16** with carbon copy developed to tag work scaffolding. The left part of the original will be put into the see-through pocket with Stopp T17. The right part is the inspection for your client. The carbon is kept by yourself for your files. On the back side of the original, important application notes are listed.

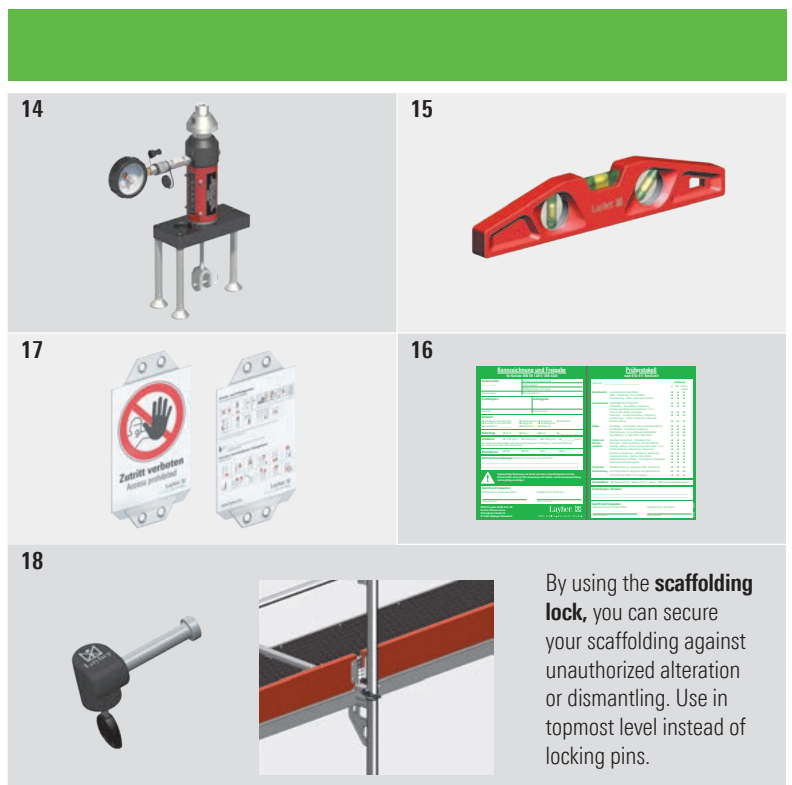

By using the **scaffolding lock**, you can secure your scaffolding against unauthorized alteration or dismantling. Use in topmost level instead of locking pins.

Pos.	Description	Dimensions L/H x W [m]	Weight approx. [kg]	PU [pcs.]	Ref. No.
1	Wall tie	0.38	1.6	250	1754.038
		0.95	3.7	50	1754.095
		1.45	5.7	50	1754.145
		1.75	5.8	50	1754.175
2	Plastic wall insert, plastic, drilled hole dia. 14 mm	70 mm	0.3	25	4008.071
		100 mm	0.3	25	4008.101
		135 mm	0.3	25	4008.136
3	Ring screw, steel, galvanized, dia. 12 mm, for expanding plug	95 mm	1.6	10	4009.096
		120 mm	1.8	10	4009.121
		190 mm	2.5	10	4009.191
		230 mm	3.0	10	4009.231
		300 mm	3.5	10	4009.301
		350 mm	5.0	10	4009.351
4	Cap, 12 mm, white, for expanding plug Ref. No. 4008	12 mm	1.0	100	4007.006
5	Telescopic stabilizer, 3.30 – 6.00 m	3.30	28.4	20	4032.600
6	Peg solid, dia. 24 mm	470 mm	1.8		4032.100
7	Peg extraction device		8.0		4032.200
8	ETICS-tie 600 complete, up to approx. 200 mm insulation ETICS-tie 800 complete, up to approx. 300 mm insulation comprising items 9, 10 (2 x), 11 (2 x) and 14 (4 x)	0.68	5.5	120	4000.600
		0.88	6.9	120	4000.800
9	ETICS hanger bolt, M12 x 125	125 mm	2.0	25	4000.126
10	ETICS-tie rod 380, up to approx. 200 mm insulation ETICS-tie rod 480, up to approx. 300 mm insulation	0.38	10.0	10	4000.121
		0.48	13.0	10	4000.481
11	Plastic pipe, 50 m		5.0		4000.050
12	Lock nut, WS 36 x 30		4.0	20	2671.131
13	Open ended wrench, WS 36		0.5		2671.135

Pos.	Description	Dimensions L/H x W [m]	Weight approx. [kg]	PU [pcs.]	Ref. No.
14	Plug-testing device, hydraulic for regulation testing of scaffolding anchoring, in practical equipment case	0.40	7.2		4012.001
15	Magnetic spirit level Aluminium section, milted measurement surface with V-channel, with 3 levels for horizontal, vertical and 45°-measuring, with innovative Neodym-magnet	0.25	0.4		4006.666
16	Scaffolding identification pad Pad with 50 + 50 pieces (Original + Carbon) with centre perforation and foldover as carbon-block	DIN A4	0.5		6344.500
17	See-through pocket for Ref. No. 6344.500 with lock flag when inspection record is not inserted.	0.30 x 0.17	0.4	10	6344.010
18	Scaffolding lock basic set, 20 locks, 2 keys and code card basic set, 20 locks, 2 keys and code card basic set, 50 locks, 4 keys and code card Expansion set with same locking as basic set, 20 locks Expansion set with same locking as basic set, 50 locks		2.2	10	4000.003
			4.2	20	4000.004
			10.5	50	4000.005
			4.2	20	4000.006
			10.5	50	4000.007

WS = wrench size PU = packaging unit = available ex works = delivery time on request = only available in this packaging unit = the approval process is not yet completed

Suspend scaffolding

Economical solutions for corrosion prevention, refurbishment, ceiling work and much more.



The **suspended scaffolding coupler 1** is suspended in existing brackets and I or U sections. With the three riveted-on half-couplers (for 48.3 mm scaffolding tubes) they have a permissible load of 15 kN.

The suspended scaffolding coupler must be secured with two **safety hooks 2**.



The **clamp couplers 3** for 48.3 mm scaffolding tubes are particularly advantageous for large flange widths. The connection to the flange is always made using two clamping couplers. Permissible load 9 kN per clamping coupler

in the vertical or horizontal direction.

The **beam gripper 6** is attached to the I beam. The connection to the scaffolding is made by means of the continuously adjustable **suspended scaffolding chain 5** with 2 shorter hooks, which can be connected to every chain link. The suspended structure with load hook can be subjected to a load of 15 kN per suspension point in the vertical direction. Expansion work is done with lattice beams 450 and decks. Suspended structures without load hook can be subjected to a load of 20 kN.









Dimensions of I beam:

Flange width max. 30 cm

Flange thickness max. 3.6 cm

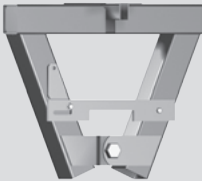
Web thickness max. 1.9 cm

Corresponds to a wide I beam, series HE B 1000

<p>1</p>  <p>Suspension in upright U or I sections. Maximum flange thickness 18 mm.</p>	<p>2</p>  <p>Two safety hooks for suspended scaffolding coupler secure the coupler Pos. 1 to the horizontal support flange. Maximum flange width of section 220 mm.</p>	<p>3</p>  <p>For suspending scaffolding tubes of dia. 48.3 mm on steel structures. Two pieces required.</p>
<p>4</p>  <p>Use as Clamp coupler</p>	<p>5</p> 	<p>6</p> 
<p>7</p>  <p>When using the load hook, the permissible load of the suspended structure is 15 kN.</p>		

Standard brick guard and protection for pedestrians

Protection net 8

The nets are attached at the bottom (at scaffolding deck height) and at the top (2 m above the scaffolding deck) to a tube. Without a quick strap fastener, the protection net is threaded with each loop of its mesh into the tubes. With quick strap fasteners, the protection net is attached to the tubes at every 750 mm. A toe board and a handrail are required in any event.

Protection net 10.00 x 2.00 m, specification:

Mesh width 100 mm, blue, made of PPM 4.50 mm,

knotless, as per DIN EN 1263-1, type U

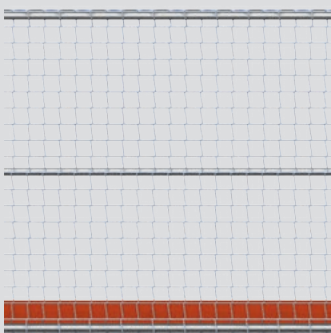
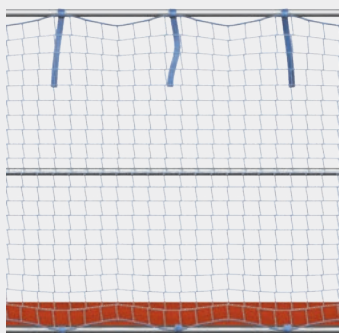
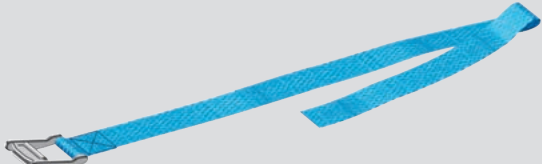
<p>8</p> 	<p>9</p> 
<p>10</p> 	

Pos.	Description	Dimensions L / H x W [m]	Weight approx. [kg]	PU [pcs.]	Ref. No.	
1	Suspended scaffolding coupler Permissible load: 15 kN Coupler secured by 2 securing hooks Pos. 2	22 WS		3.8	25	4713.022
2	Safety hook for suspended scaffolding coupler	24 WS	0.24	0.9	25	4714.000
3	Clamp coupler for I beam Permissible load 9 kN vertical or parallel to the tube axis	19 WS		1.1	25	4716.019
		22 WS		1.1	25	4716.022
4	Clamp half-coupler for I beam Permissible load: 3.6 kN vertical to the tube axis	19 WS		1.4	25	4750.019
		22 WS		1.4	25	4750.022
5	Suspended scaffolding chain. 4.00 m Permissible load: 20 kN Short link round steel chain dia. 8 mm, galvanized, for lifting purposes according to EN 818-2 grade 8 with 2 shorter hooks. About the chain inspection, a inspection certificate 3.1 can be issued according to EN 10204.	4.00		7.1		4015.444
6	Beam gripper automatically locking when closed Permissible load: 20 kN	0.50 x 0.41		11.2	80	4015.000
7	Load hook 450 for beam gripper Permissible load: 15 kN	0.68 x 0.24		6.9	40	4016.000

Side protection nets must be checked every year!

Side protection nets may only be used within a year of their being tested. If older protection nets are used, it must be verified in tests that the maximum tensile strength of the net yarn is still at least 2 kN. This testing of your Layher side protection nets is free of charge for you.

To do so, a test mesh must be sent to Layher. In DIN EN 1263-1, Type U "Protection Nets and Protection Net Accessories, Safety Requirements, Testing" details are also given in 4.3 Instructions for Use, on the "time of removal from service".

Pos.	Description	Dimensions L / H x W [m]	Weight approx. [kg]	PU [pcs.]	Ref. No.	
8	Protection net without quick strap fastener	10.00 x 2.00		4.5		6232.000
9	Protection net with quick strap fastener	10.00 x 2.00		5.9		6232.002
10	Quick strap fastener	0.50		1.5	50	6235.001

WS = wrench size PU = packaging unit = available ex works = delivery time on request = only available in this packaging unit = the approval process is not yet completed

Parts for rolling towers

Castors

The mobile solution for birdcage, bridge or suspended scaffolding is often the best alternative in terms of technical suitability, scheduling and price. In this field too, the choice, the delivery capability and not least the experience of the manufacturer point to Layher. If scaffolding is made mobile using castors, DIN 4420-3 applies. For these rolling towers, verification of structural strength is required.

Robust castors with twin brake (it brakes wheel and slewing ring) for various loads, offer a safer mobility of the scaffolding – without high effort.

The spindels, which are inserted into the scaffolding standards offer an exact adjustment and lead the loads centrally into the wheel. This system offers highest stability and smooth production flows. For special applications, e.g. on sensitive floorings or work in explosive areas, we suggest the use of castors with polyurethane coatings (see article description). In scaffolding structures with a high proportion of permanent loads (e.g. dead weight), we recommend the use of the castor 1000 / 1200.

For rolling towers using **mobile beam with bar 6**, all the provisions of DIN 4420-3 must be met. This applies particularly for sufficient ballasting, safe internal access via hatch-type decks with ladders, and the necessary side protection on every deck level.

The **adjustable spigot 8** is fastened to the mobile beam with bar at the required point. For further extensions, the scaffolding elements are attached to the spigots. This permits flexible working on the ceiling or wall (in the middle or at the side).

For heavy rolling towers:

Double flange castor 9

For use on rails. Overall height: 313 mm. Steel wheel: External dia. 285 mm, internal dia. 242 mm, external width 95 mm, clear width 75 mm.

The bolted-on half-coupler permits, in conjunction with a scaffolding tube, locking and alignment of all the castors in the direction of travel.

Flange castor for 48.3 mm tube 10





For use on 48.3 mm tubes.

Steel wheel: External dia. 230 mm

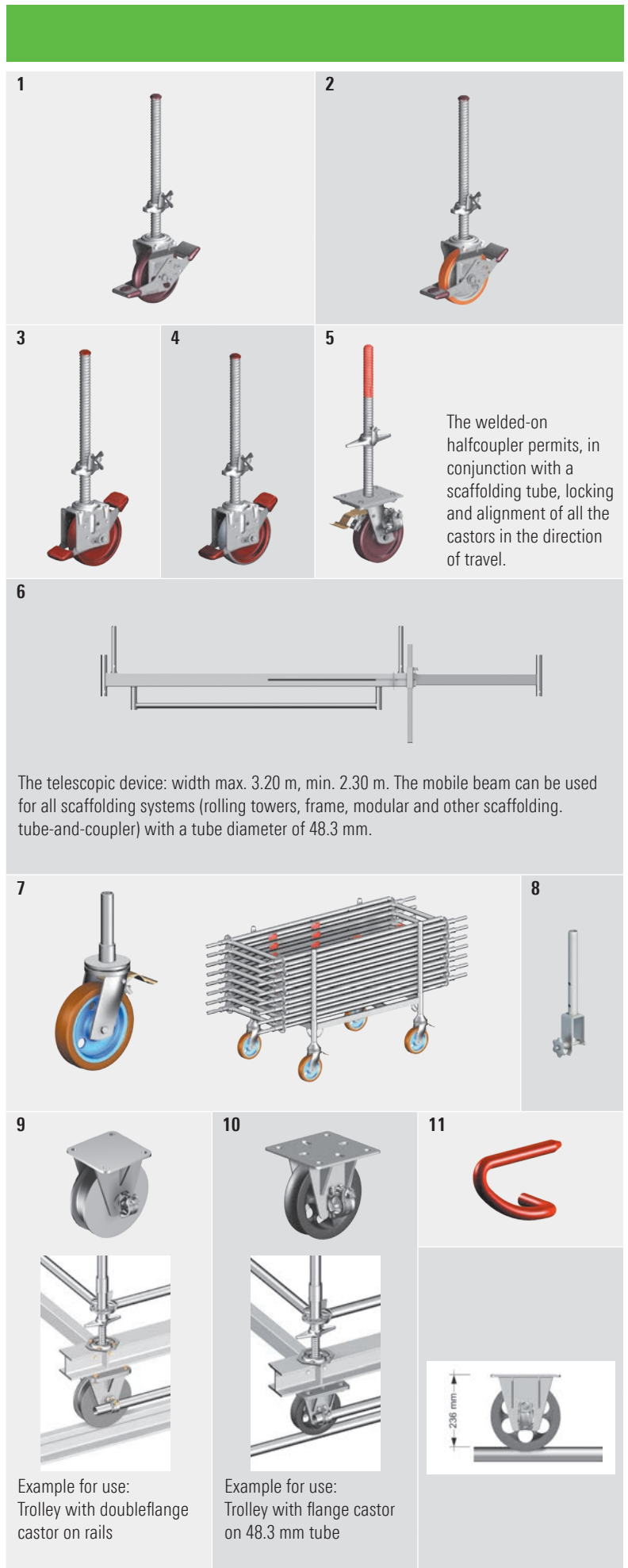
The welded-on half-coupler permits, in conjunction with a scaffolding tube, locking and alignment of all the castors in the direction of travel.

The scaffolding joints are secured with **locking pins 11** in special cases against unintentional lifting off, for example when scaffolding units are moved with a crane or in particular wind conditions.



Pos.	Description	Dimensions L/H x W [m]	Weight approx. [kg]	PU [pcs.]	Ref. No.
1	Castor 700 Plastic wheel, dia. 200 mm. With base plate, adjustment range 0.30 – 0.60 m, spindle nut with lock, castor with twinbrake lever and load centering when braked. Wheel and slewing ring can be locked. Permissible load capacity: braked 7.0 kN; unbraked 3.5 kN	dia. 0.20	6.8	70	1259.201
2	Castor 700, with polyurethane coating Plastic wheel dia. 200 mm. With base plate, adjustment range 0.30 – 0.50 m, spindle nut lock, castor with twin brake lever and load centering when braked. Wheel and slewing ring can be locked. Permissible load capacity: 7.0 kN	dia. 0.20	7.0	70	1259.202
3	Castor 1000 Plastic wheel, dia. 200 mm. With base plate, adjustment range 0.30 – 0.60 m, spindle nut with lock, with twin brake lever and load centering when braked. Wheel and slewing ring can be locked. Permissible load: 10 kN (braked and unbraked)	dia. 0.20	6.3	70	1260.201
4	Castor 1000, with electroconductive polyurethane coating Plastic wheel dia. 200 mm of polyamide with coating of electroconductive polyurethane. With base plate, adjustment range 0.30 – 0.60 m, spindle nut lock, with twin brake lever and load centering when braked. Wheel and slewing ring can be locked. Permissible load capacity: 10 kN Special castor for sensitive floorings and thanks to electroconductability also usable in explosive or ESD areas. Bleeder resistance according to DIN EN 12526 < 10 ⁴ Ω	dia. 0.20	6.8	70	1260.202 
5	Castor 1200, with half-coupler Reinforced plastic wheel, dia. 200 mm. With base plate, adjustment range 0.30 – 0.60 m, spindle nut with lock, wheel and slewing ring can be locked. Wheel and slewing ring can be locked. Permissible load: 12 kN (braked and unbraked)	dia. 0.20	12.0	50	1267.200 
6	Mobile beam with bar, 3.20 m, adjustable Steel rectangular tube, hot-dip galvanized. For base widening in special rolling tower structures.	3.20	42.6	20	1338.320
7	Castor 750, with polyurethane coating	dia. 0.25	11.3	150	5207.250 
8	Spigot, adjustable Steel, hot-dip galvanized. For use with mobile beam Ref. No. 1338.320	0.46	2.1	150	1337.000
9	Double flange castor, 75 mm Secured by top plate, hole pattern 170 x 170 mm, dia. 18 mm, external dia. 285 mm, internal dia. 242 mm, without brake. Permissible load: 20 kN	dia. 0.285	28.0	40	5216.075 
10	Flange castor for 48.3 mm tube Secured by top plate, outer hole pattern 170 x 170 mm, dia. 18 mm, inner hole pattern 126 x 126 x 13 mm (slot hole 13 x 28 mm) without brake. Permissible load: 31 kN	dia. 0.23	16.8	40	5221.048 
11	Locking pin, red, dia. 11 mm		0.2	100	4000.001

Scaffolding enclosures

Keder rail system

The Layher keder rail system is a weather protection system for scaffolding comprising **aluminium keder rails 2000 1/2** and ready-made **keder tarpaulins**. It forms a continuous covering of the scaffolding surfaces to a level above the eaves of the building to be enclosed and is thus an almost watertight and dustproof enclosure. The aluminium keder rails are connected with **rail holders 5** and **captive bolts 12**.

The wind loads that the weather protection system for scaffolding has to transmit must be calculated and verified in accordance with DIN EN 12810/12811. The spacing of the rail holders is max. 1 m. Transmission of forces must be structurally verified. Structural strength verifications are available for Layher scaffolding.

The load-bearing capacity of the keder rail system from Layher is designed such that scaffolding bays of up to 3.07 m can be used up to a height of 50 m. Above the 50 m level. The maximum possible scaffolding bay size is 2.57 m. The assembly instructions are available on request.

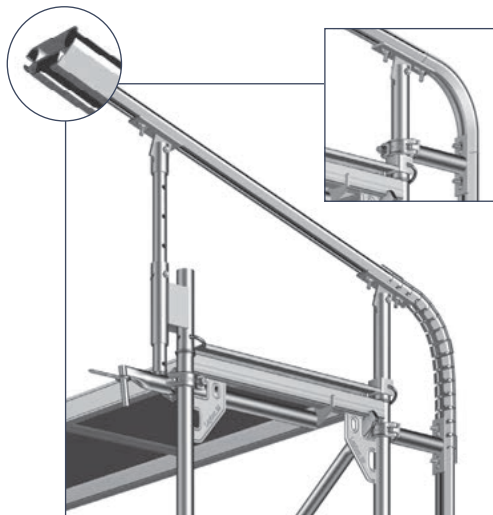

Keder tarpaulins in use on the scaffolding

1 Aluminium keder rail 2000 1/2

2 Aluminium keder rail 2000 1/2

3 Curved aluminium keder rail

4 Curved aluminium keder rail

5 Rail holder
For tube diameter 48.3 mm

6 Rail holder
For connection to Allround rosette

7 Captive bolt

8 Captive bolt

9 Tarpaulin closure

10 Tarpaulin closure

11 Tarpaulin closure

12 Angled connection between two keder rails

13 Used to stabilize and secure the keder tarpaulins at the tarpaulin closure/joint

14 Captive bolt

15 Rail holder

16 Lattice-reinforced and UV-stabilized PE tarpaulin with welded-on keder trim on both sides, dia. 13 mm. For scaffolding bay lengths of 2.07 m, 2.57 m and 3.07 m. Weight 300 g/m². Keder tarpaulins are available in other (e.g. metric) lengths and widths, please enquire for details.

Pos.	Description	Dimensions L/H x W [m]	Weight approx. [kg]	PU [pcs.]	Ref. No.
1	Aluminium keder rail 2000	1.30	2.0		4201.130
		2.00	3.0		4201.200
		2.25	3.3		4201.220
		2.50	3.8		4201.250
		3.00	4.5		4201.300
		4.00	6.0		4201.400
2	Aluminium keder rail 3000	2.00	6.1		5574.200
		3.00	9.2		5574.300
		4.00	12.2		5574.400
		5.00	15.3		5574.500
		6.00	18.3		5574.600
3	Aluminium keder bow 2000 eaves , for roof pitch 11°	0.35	0.5		4205.001
4	Aluminium keder bow 2000 ridge , for roof pitch 11°	0.30	0.5		4205.002
5	Rail holder with half-coupler , 19 WS 2 grooved bolts (Pos. 14) are required	0.20	1.7	200	4201.000
6	Rail holder with wedge head 2 grooved bolts (Pos. 14) are required	0.20	1.7	200	4201.001
7	Keder rail holder , rotatable	0.10	0.9		5573.000
8	Rail holder , swivelling with half-coupler	0.16	1.5		5573.006
9	Height adjuster for weather cap adjustable in 8 cm intervals, 2 grooved bolts (Pos. 14) are required	0.60	4.5		4203.000
10	Hinge fitting for weather cap 2 grooved bolts (Pos. 14) are required	0.30	1.6		4202.000
11	Hinge fitting for Event roof	0.70	3.4		5573.001
12	Keder bow 2000 flexible , 0.60 m	0.60	1.0		4205.003
13	Tube brace Steel, 2 grooved bolts (Pos. 14) are required. Metric and other lengths available on request	2.07	4.2	150	4204.207
		2.57	5.1	150	4204.257
		3.07	6.0	150	4204.307
14	Captive bolt for keder rail M12 x 40 , with nut		5.0	50	4206.001
15	Joint strap for aluminium keder rail 2 grooved bolts (Pos. 14) are required	0.17	0.5		4208.000
16	Keder tarpaulin 300 , white	10.00 x 2.07	5.9		6229.207
		10.00 x 2.57	7.3		6229.257
		10.00 x 3.07	8.7		6229.307

WS = wrench size PU = packaging unit = available ex works = delivery time on request = only available in this packaging unit = the approval process is not yet completed

Scaffolding enclosures

Scaffolding tarpaulins and nets

To protect passers-by and traffic during spraying work and other site work causing dirt, facade scaffolding is covered with tarpaulins and nets. Layher scaffolding tarpaulins and nets meet the requirements of DIN 4420-1. Compliance with design parameters prevents objects falling from the scaffolding level.

Scaffolding tarpaulins 1: Lattice-reinforced and UV-stabilized PE tarpaulin with eyelet bands welded on lengthways. For scaffoldings in the standard dimensions of 2.57 m and 3.07 m. Eyelet spacing 10 cm.

Scaffolding nets 2: Highly tear-resistant and UV-stabilized scaffolding protection net with fine fabric structure, gauze fabric of PP bands with three compressed eyelet bands. Eyelet spacing 10 cm. For scaffoldings in the standard dimensions of 2.57 m and 3.07 m.

Scaffolding tarpaulins and scaffolding nets are only supplied in rolls of 20 m length.

Scaffolding tarpaulins with printed advertising:
Delivery time and additional printing costs on request.

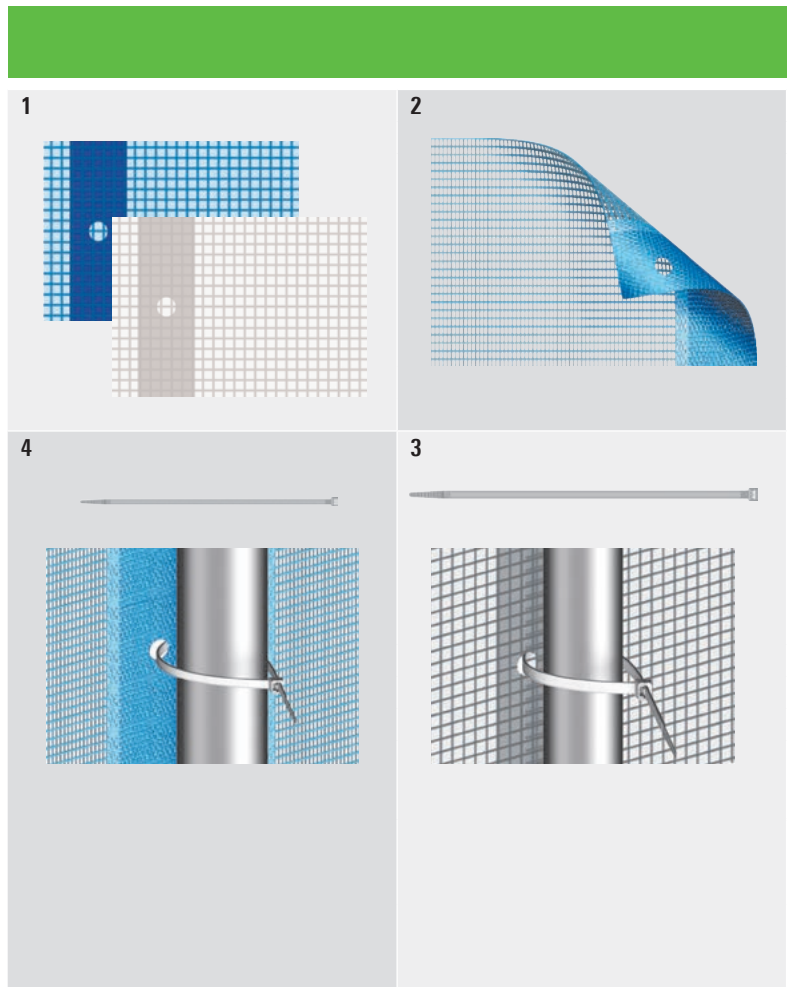

Ladder access





For constructing outward-facing accesses, **simple scaffolding ladders 7/8** are the ideal solution.

Layher pole ladders for scaffolding conform to DIN EN 131 individually or when connected to each other. The stile connections must have proper support and be secured with spring clips **10**.

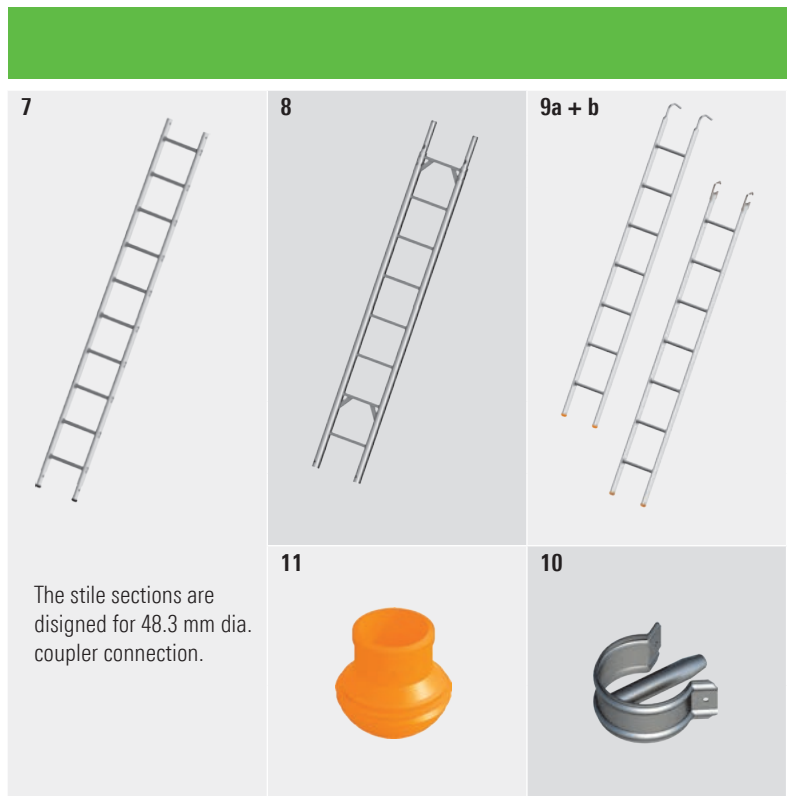
The regulations in DGUV 38 must be followed. The **storey ladder 9** is a flexible aid to climbing inside the scaffolding to a storey height of 2 m.



The stile sections are designed for 48.3 mm dia. coupler connection.

Pos.	Description	Dimensions L/H x W [m]	Weight approx. [kg]	PU [pcs.]	Ref. No.
1	Scaffolding tarpaulin 280 , blue 2.70 m wide, working width 2.57 m 3.25 m wide, working width 3.07 m Lattice reinforced, very tearproof PE tarpaulin, 5 eyelet tapes, tear resistance approx. 500 N/5 cm, weight approx. 280 g/m ² . temperature resistance from -40 °C to +80 °C	20.00 x 2.70	15.1		6215.257
		20.00 x 3.25	18.2		6215.307
	Scaffolding tarpaulin 200 , white 2.70 m wide, working width 2.57 m 3.25 m wide, working width 3.07 m Lattice reinforced, very tearproof PE tarpaulin, 5 eyelet tapes, tear resistance approx. 750 N/5 cm, weight approx. 200 g/m ² . temperature resistance from -40 °C to +80 °C	20.00 x 2.70	10.8		6217.257
		20.00 x 3.20	13.0		6217.307
2	Scaffolding net 90 , blue Weight 90 g/m ² . 2.60 m wide, working width 2.57 m 3.20 m wide, working width 3.07 m	20.00 x 2.60	4.7		6219.257
		20.00 x 3.20	5.8		6219.307
3	Disposable tie for tarpaulins , 380 x 7.6 mm		1.0	100 	6242.001
4	Disposable tie for nets , 300 x 5.0 mm		1.0	100 	6241.001

Pos.	Description	Dimensions L/H x W [m]	Weight approx. [kg]	PU [pcs.]	Ref. No.	
7	Aluminium pole ladder	10 rungs	2.90 x 0.46	7.2	50	1004.010
		14 rungs	4.00 x 0.46	10.0	50	1004.014
		17 rungs	4.90 x 0.46	12.0	50	1004.017
		20 rungs	5.70 x 0.46	14.0	50	1004.020
8	Steel pole ladder hot-dip galvanized	6 rungs	1.50 x 0.43	12.0	50	1002.006
		8 rungs	2.00 x 0.43	15.0	50	1002.008
		12 rungs	3.00 x 0.43	21.5	50	1002.012
		16 rungs	4.00 x 0.43	28.0	50	1002.016
9a	Access ladder T15 , steel, 7 rungs for Allround Scaffolding and SpeedyScaf	2.15 x 0.35	7.8	70	4008.007	
9b	Access ladder T15 , steel, 7 rungs for SpeedyScaf	2.15 x 0.35	7.8	70	4005.007	
10	Spring clip , 11 mm pin, for securing the joint connections of the extended simple steel / aluminium scaffolding ladder Ref. No. 1004 / 1002		0.1		1250.000	
11	Rubber base for tube 48.3 mm		0.1	100	1020.000	

WS = wrench size PU = packaging unit  = available ex works  = delivery time on request  = only available in this packaging unit  = the approval process is not yet completed

Scaffolding pallets

Tube pallets

in square shape (85) with or without skeleton box insert or in rectangular shape (125/265). The pallets are open on all sides. Tubes, standards, guardrails, diagonal braces, toe boards and, with the box insert, also couplers and other small parts are transported and stored with this pallet. The empty pallets, stored permanently in the base frame using pallet posts, can be transported and stored in a space-saving way.



Tube pallet 125 1

The following can be transported, for example:

- 13 Frames, 0.73 m or
- 80 Standards or
- 99 toe boards
- 155 ledgers (pay attention to the perm. load of 1.500 kg) or
- 11 Robust decks 0.61 m or
- 15 Stalu decks 0.61 m or
- 28 Steel decks 0.32 m.

Tube pallet 85 2

The following can be transported, for example:

- 500 couplers or
- 120 scaffolding anchors 0.38 m or
- 100 base plates 60

Tube pallet 265 3

The following can be transported, for example:

- about 13 Ridge cassettes or
- 20 Roof cassettes or
- 15 Brick guards.

Modular skeleton box 4

The skeleton box can be stacked with Euro pallets. Crane eyelets at top; an opening allows stacked material to be removed even if several pallets are stacked one above the other. The integrated timber base plate is 30 mm thick and it's nailed onto 50 x 50 mm square timbers.





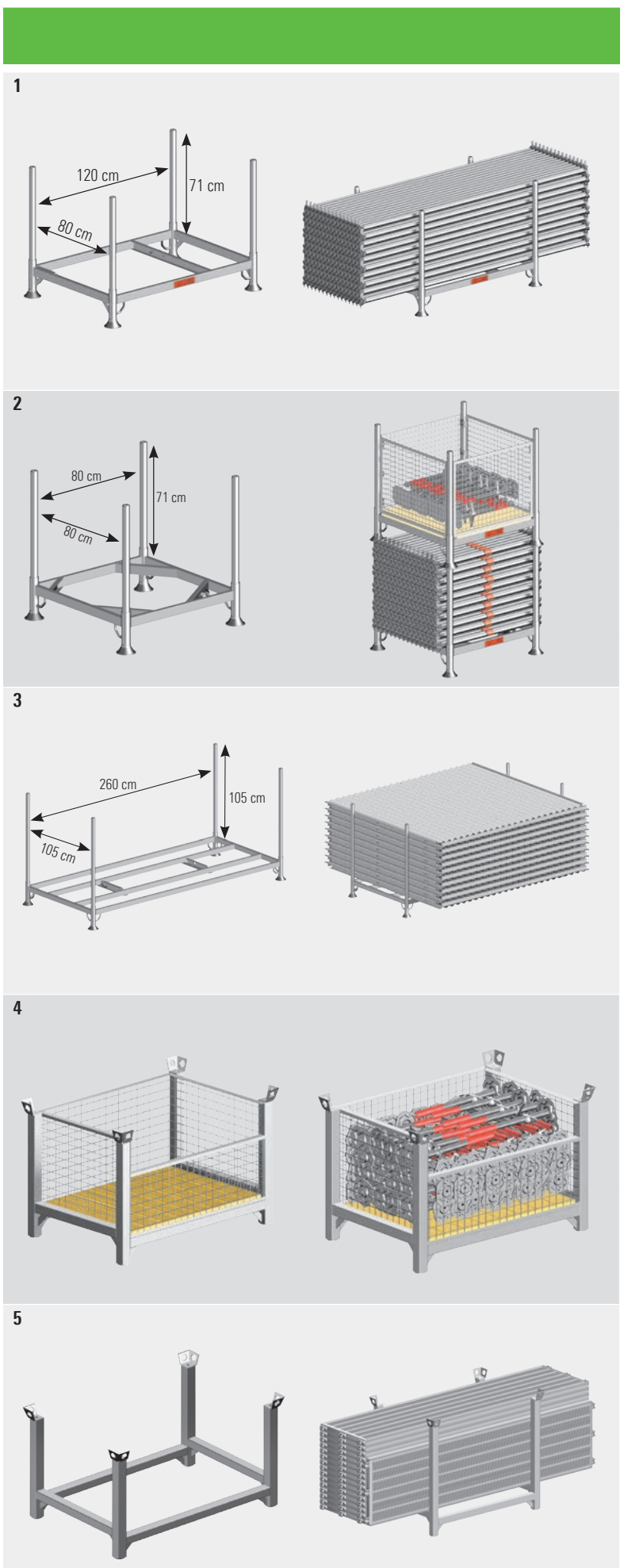

The following can be transported, for example:

- 1.200 couplers or
- 180 scaffolding anchors 0.38 m or
- 200 base plates 60

Modular pallet 5

The pallet is also stackable with Euro pallets and has crane eyelets. Thanks to the higher mounted cross struts, the storage goods can be placed by fork-lift truck.



Pos.	Description	Dimensions L/H x W [m]	Weight approx. [kg]	PU [pcs.]	Ref. No.
1	Tube pallet 125 Steel, hot-dip galvanized, length of pallet posts: 0.86 m, load 1,500 kg	1.37 x 0.97	32.0	10	5105.125
2	Tube pallet 85 Steel, hot-dip galvanized, length of pallet posts: 0.86 m, load 1,500 kg	0.97 x 0.97	30.8	10	5105.085
	Timber base plate	0.88 x 0.88	5.4		5104.088 
	Mesh box insert Steel, hot-dip galvanized, length of pallet posts: 0.86 m, load 1,500 kg	0.85 x 0.60	22.0	10	5104.086 
	Plug tubes for tube pallets 125 and 85	0.86	3.5	MA 4	6494.751 
3	Tube pallet 265 Steel, hot-dip galvanized, length of pallet posts: 1.20 m, load 1,300 kg	2.77 x 1.22	50.6	10	5113.265 
4	Modular skeleton box Steel, hot-dip galvanized, internal dimensions 1.08 x 0.68 x 0.61 m load 2,000 kg, perm. onload 6,000 kg stackable with Euro pallets	1.20 x 0.80	85.8		5113.002
	Timber base plate IPPC treated = according to import regulations for packagings made of solid timber IPPC-Standard (International Plant Protection Convention)	1.07 x 0.76	15.2		6494.514 
5	Modular pallet Steel, hot-dip galvanized, internal dimensions 1.08 x 0.68 x 0.61 m load 2,000 kg, perm. onload 6,000 kg stackable with Euro pallets	1.20 x 0.80	45.0	5	5101.061 

Bridging

The **aluminium stage 600 1** is a sturdy and versatile work deck of up to 10 m length which can be used quickly and easily as a lightweight aluminium component either individually or in scaffolding structures. In accordance with DIN EN 12811-1, the Layher **aluminium stage 600 1** with a width of 0.60 m is permissible for load class 3 (2 kN/m²; lengths up to 7.10 m) and also for load class 2 (1.5 kN/m²; lengths up to 10.00 m).

It can therefore be used as a deck in work, safety and birdcage scaffolding and also as a bridging element in façade scaffolding. If the height exceeds 2.00 m, a three-part brick guard is required.

Double guardrail with toe board 3

Folds together for transport

Guardrail fixing 4

for fastening the double guardrail to the aluminium bridging beam 600

Guardrail locking clip 5

for securing the double guardrail on the guardrail fixture

Guardrail post 1.20 m 6

for connecting the three-part brick guard made from scaffolding tubes, double couplers and toe boards. The **clamp 7** can be used to combine several aluminium bridging beams 600 as a platform for common support applications.

Alu telescopic stage 8

The automatic locking mechanism ensures that the inner extending element cannot slide out by mistake.

Toe board 9

Easy fitting into the toe board pins of the guardrail mounting standard, for complete three-part side protection.

The **steel plank 11** is a safe bridging element capable of bearing high loads for all scaffolding systems.

It is preferred to wooden planks for use in areas with stringent fire protection requirements.

- ▶ Long service life, reusable
- ▶ Lower weight compared with wooden planks
- ▶ Non-slip and non-flammable
- ▶ Easy to secure in position with locking pins when placed on steel decks

The support length must be at least 10 cm at every support.

The steel planks 0.19 m and 0.32 m are also optionally available with one or with two pins.

See our Allround catalogue for this.

Individual toe boards

The toe boards can be individually designed in printing and painting.

Minimum order quantity 500 pcs.

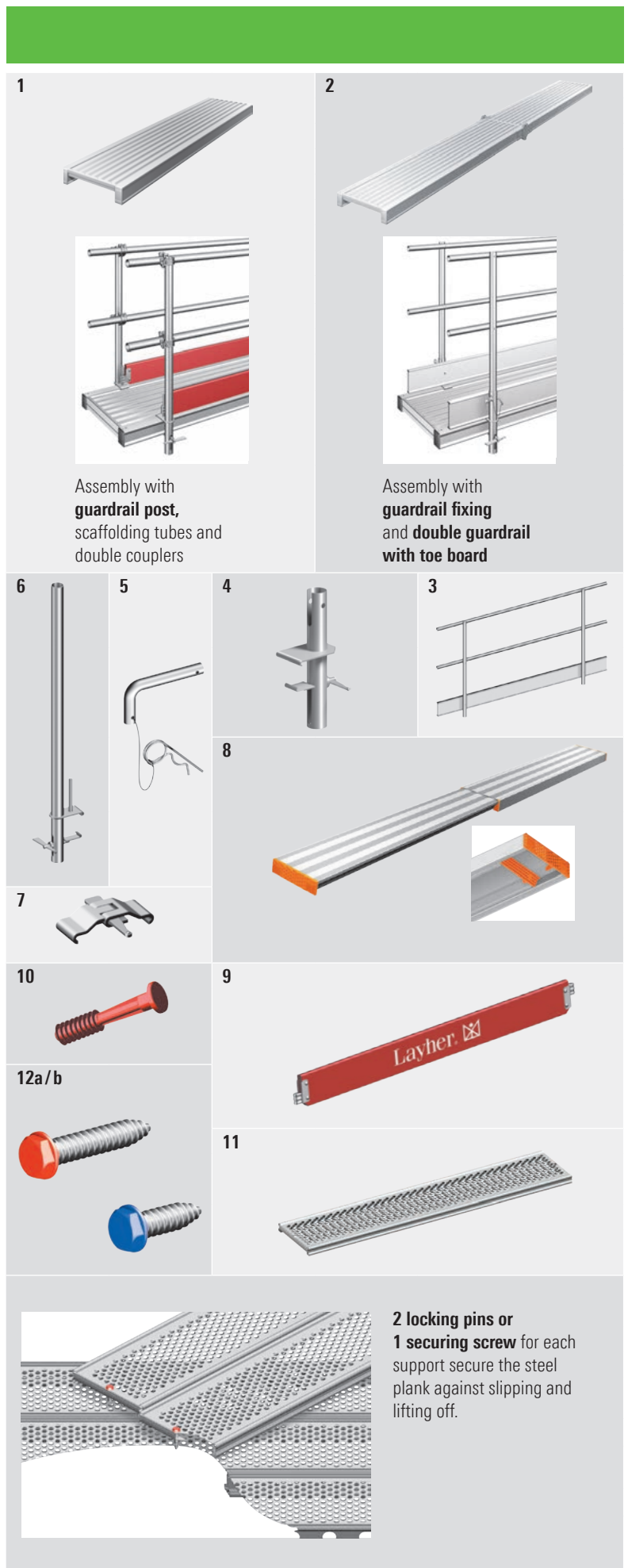

1

2

Assembly with
guardrail post,
scaffolding tubes and
double couplers

Assembly with
guardrail fixing
and **double guardrail**
with **toe board**

6

5

4

3

8

7

10

9

12a/b

11

**2 locking pins or
1 securing screw** for each
support secure the steel
plank against slipping and
lifting off.

Pos.	Description	Dimensions L/H x W [m]	Weight approx. [kg]	PU [pcs.]	Ref. No.			
1	Alu stage 600 	Permissible load-bearing capacity 2.0 kN/m ² , height 0.09 m	3.18 x 0.60	20.0		1348.318		
			4.12 x 0.60	26.0		1348.412		
			4.75 x 0.60	29.0		1348.475		
		Permissible load-bearing capacity 2.0 kN/m ² , height 0.12 m	5.20 x 0.60	38.0		1348.520		
			6.15 x 0.60	45.0		1348.615		
			7.10 x 0.60	52.0		1348.710		
			8.00 x 0.60	68.0		1348.800		
		Permissible load-bearing capacity 1.5 kN/m ² , height 0.15 m	9.10 x 0.60	76.0		1348.910		
			10.00 x 0.60	85.0		1348.100		
2	Alu stage 600 folding	Perm. load-bearing capacity 1.5 kN/m ² , height 0.12 m	5.10 x 0.60	47.0		1349.510 		
			7.30 x 0.60	61.0		1349.730 		
		Perm. load-bearing capacity 1.5 kN/m ² , height 0.15 m	9.15 x 0.60	86.0		1349.915 		
3	Double guardrail , 2.00 m with toe board Aluminium	2.00 x 1.10	9.7		1332.200			
		Double guardrail , 3.00 m with toe board Aluminium	3.00 x 1.10	12.9		1332.300		
4	Guardrail fixing for Pos. 3, aluminium	0.36	0.9		1330.000			
5	Guardrail locking clip for Pos. 4, steel	0.08	0.1		1333.000			
6	Guardrail post , 1.20 m Aluminium	1.20	2.4		1334.000			
7	Clamp , steel	0.10	0.4		1331.000			
8	Alu telescopic stage	1.64 – 2.90 x 0.31	13.0		1351.290			
		1.92 – 3.50 x 0.31	16.0		1351.350			
		2.27 – 4.00 x 0.31	18.0		1351.400			
		2.49 – 4.40 x 0.31	20.0		1351.440			
9	Toe board , wood	1.57 x 0.15	3.1	140	1757.157			
		2.07 x 0.15	4.7	140	1757.207			
		2.57 x 0.15	5.6	140	1757.257			
		3.07 x 0.15	6.8	140	1757.307			
10	Locking pin for steel plank , plastic, dia. 11 mm	0.08	0.1	100 	3800.006			
11	Steel plank , 0.30 m	Load class 6	1.00 x 0.30	6.5	60	3880.100 		
		Load class 6	1.50 x 0.30	10.3	60	3880.150 		
		Load class 5	2.00 x 0.30	12.8	60	3880.200 		
		Load class 3	2.50 x 0.30	15.3	60	3880.250 		
	Steel plank , 0.20 m	Load class 6	1.00 x 0.20	4.8	100	3878.100 		
		Load class 6	1.50 x 0.20	7.2	100	3878.150 		
		Load class 5	2.00 x 0.20	9.5	100	3878.200 		
		Load class 3	2.50 x 0.20	11.8	100	3878.250 		
		12a	Securing Screw, long , steel, hot-dip galvanized	19 WS	0.08 x 0.03	4.0	50 	3800.009 
				22 WS	0.08 x 0.03	3.9	50 	3800.010 
12b	Securing Screw, short , steel, hot-dip galvanized	19 WS	0.04 x 0.02	2.3	50 	3800.011 		
		22 WS	0.04 x 0.02	2.3	50 	3800.012 		

WS = wrench size PU = packaging unit  = available ex works  = delivery time on request  = only available in this packaging unit  = the approval process is not yet completed

Bridging

The **steel gap sheet 1** can be used between two scaffolding decks on SpeedyScaf and Allround Scaffolding. For use on gap widths up to 13 cm.

Advantages:

- ▶ Fast and easy mounting, independent of the gap width
- ▶ Easy position fixing with locking pins (see page 28, Pos. 12b) for steel decks.
- ▶ Long life
- ▶ Lightweight
- ▶ Cost effective
- ▶ Flexible use
- ▶ Not flameable
- ▶ Low height (h = 10 mm), meaning: low tripping hazard

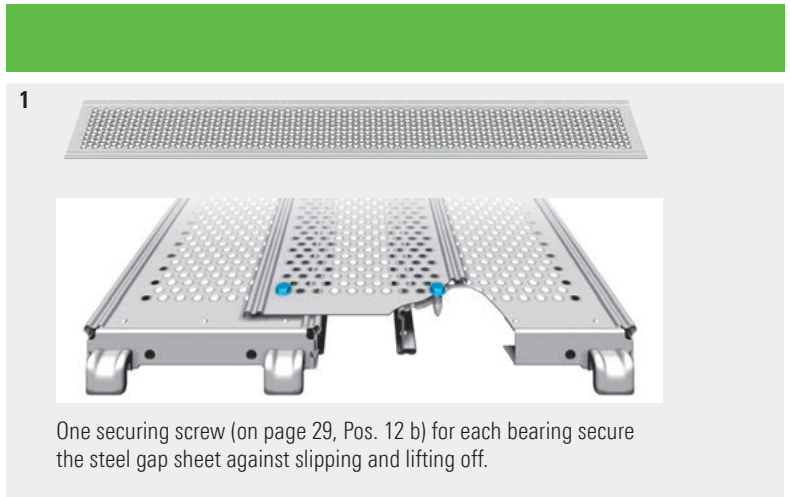

Scaffolding planks

Our planks conform to sorting category S 10 as per DIN 4074. They can be used as scaffolding planks. They can be protected against splitting at the ends with **sheet metal fitting for plank 0.60 m 3**.

Scaffolding plank 2

freshly sawn, sorting category S 10

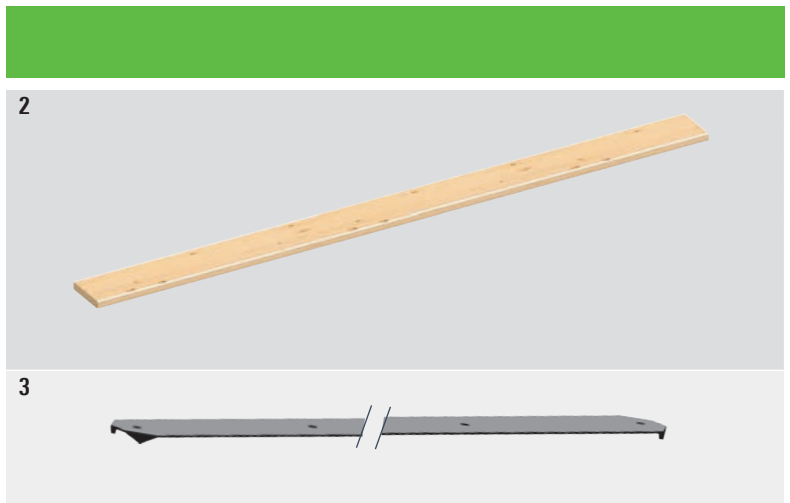

Software for scaffolding construction

Layher LayPLAN

Time and material are crucial factors in scaffolding construction. To make the most efficient use of both, the Layher range includes the practical LayPLAN scaffolding planning software.

With the several software packages LayPLAN CLASSIC and LayPLAN CAD, it is possible to plan scaffolding structures from simple, small facade scaffolding up to complex industrial scaffolding or protective roofs and grandstands.

Once the dimensions and the required assembly variant have been entered, LayPLAN CLASSIC delivers within seconds a scaffolding proposal, including anchoring, bracing and side protection.

The data are then simply exported into LayPLAN CAD, which offers further possibilities for detailed 3D planning. A visual collision check is possible with the aid of volume rendering. Using a convenient search function with preview image, scaffolding planners will find not only an extensive library of individual Layher parts, but also assemblies already prefabricated for even faster design work.

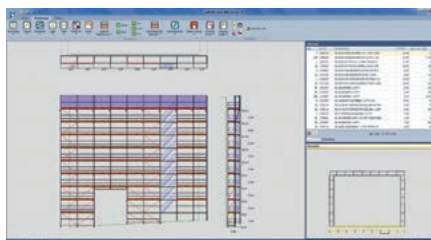

Facade scaffolding with lattice beam bracing and brick guard nets

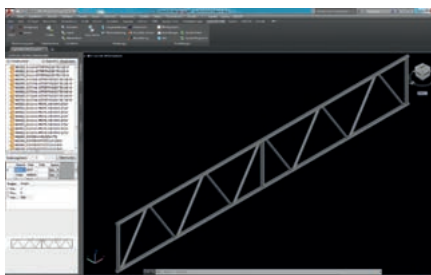

Planning of individual scaffolding structures with LayPLAN CAD

Pos.	Description	Use up to load class	Dimensions L/H x W [m]	Weight approx. [kg]	PU [pcs.]	Ref. No.
1	Steel gap sheet for 0.73 m bay length for 1.09 m bay length for 1.57 m bay length for 2.07 m bay length for 2.57 m bay length for 3.07 m bay length					
		6	0.73 x 0.32	2.6	150	3881.000
		6	1.09 x 0.32	4.0	150	3881.001
		6	1.57 x 0.32	6.0	100	3881.002
		6	2.07 x 0.32	8.0	100	3881.003
		6	2.57 x 0.32	10.0	100	3881.004
		6	3.07 x 0.32	10.7	100	3881.005

Pos.	Description	Dimensions L/H x W [m]	Weight approx. [kg]	PU [pcs.]	Ref. No.
2	Scaffolding plank 45 mm high, freshly sawn, sorting category S 10	1.00 x 0.24	5.2		3816.100
		1.50 x 0.24	7.8		3816.150
		2.00 x 0.24	10.4		3816.200
		2.50 x 0.24	13.0		3816.250
		3.00 x 0.24	15.6		3816.300
		3.50 x 0.24	18.2		3816.350
		4.00 x 0.24	20.8		3816.400
3	Sheet metal fitting for plank 0.60 m	0.60	0.1		3817.000

How can I acquire LayPLAN?

Registration and all the ordering processes can be conveniently accessed at the Layher website: <http://software.layher.com>

A contact form gives you the data to access our software portal, where you can download a 30-day test version and also find the order form for the full version.

The individual software packages can be licensed for a validity of 1 year from our sales partner *Mensch und Maschine Deutschland GmbH*, which also handles the entire sales process and provides continuous hotline support for these packages. The license is extended by a further year if a subscription model is selected, unless it is terminated with two months notice to the end of the contractual year.

Pos.	Description
1	LayPLAN CLASSIC scaffolding configurator for SpeedyScaf, Allround Scaffolding, weather protection roofs and rolling towers
2	LayPLAN CAD plug-in for AutoCAD, for designing complex scaffolding in 3D and for developing scaffolding proposals from LayPLAN CLASSIC
3	LayPLAN CAD OEM AutoCAD 2017 OEM with LayPLAN CAD plug-in for designing complex scaffolding in 3D, incl. 3D PDF exporter, and for developing scaffolding proposals from LayPLAN CLASSIC

Fall protection

According to German DGUV 38 regulations, equipment to prevent falls by personnel must be provided for work areas and walkways where the height of the fall is more than 2.00 m.

The **PSA-safety harness AX 60 C 1** has impressive features:

- ▶ Comfortable, padded and ergonomic back support
- ▶ Convenient tool holders and click-locks for easy fastening
- ▶ High operational dependability and absolute freedom from maintenance, plus very simple fastening
- ▶ Operating errors are not possible, as the equipment operates in any position
- ▶ Excellent running even under gruelling working conditions
- ▶ Enormous distribution of forces in the event of a fall

Before use, visual checks must be performed regularly to ensure correct working order. In accordance with German BGR 198 regulations, all personal safety equipment must be inspected at least once a year by an expert. The maximum permissible period of use for the equipment must not be exceeded.

The **advance guardrail post 4/5**, the **advance telescopic guardrail 1.57/2.07 m 6**, the **advance telescopic guardrail 2.57/3.07 m** and the **End-AGS 7** are used for temporary protection against falls during assembly of scaffolding parts on the uppermost, unsecured scaffolding level.

Extension lengths

Article	L min.	L max.
Assembly guardrail 1.57/2.07 m	1.57 m	2.90 m
Assembly guardrail 2.57/3.07 m	2.20 m	3.70 m

PSA: Personal safety apparatus

AGS: Advance guardrail system

Railing clamp 8

According to German regulations DGUV 38 relating to construction work, a fall protection system must be provided for work areas and walkways on roofs and intermediate levels where the height of the fall is more than 2.00 m. The Layher railing clamp meets these requirements for securing of concrete floors and fascias of 16 – 33 cm height and of flat roofs.

The back guard must be made in accordance with applicable regulations from tube/coupler, modular or frame scaffolding. The bay widths can be freely selected, max. 3.07 m long.

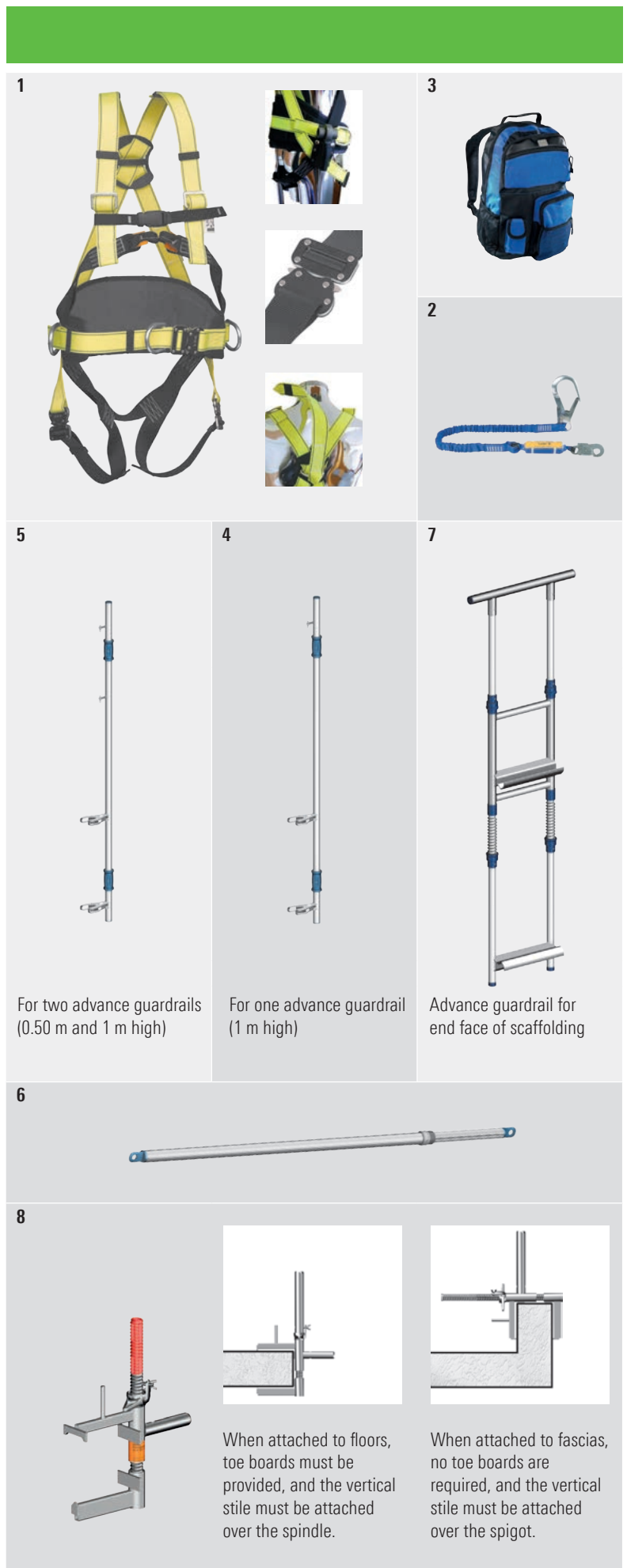

1

3

2

5

4

7

For two advance guardrails (0.50 m and 1 m high)

For one advance guardrail (1 m high)

Advance guardrail for end face of scaffolding (1 m high)

6

8

When attached to floors, toe boards must be provided, and the vertical stile must be attached over the spindle.

When attached to fascias, no toe boards are required, and the vertical stile must be attached over the spigot.

Pos.	Description	Dimensions L/H x W [m]	Weight approx. [kg]	PU [pcs.]	Ref. No.
1	PSA-safety harness AX 60 C , with extension 0.50 m conforms EN 361		1.8		5969.160 🕒
2	PSA-Flex-safety rope , 2.00 m with fall arrester and snap hook FS 90; as per EN 354 / EN 355 self-shortening to reduce tripping hazards	2.00 m	1.1		5969.501 🏠
3	PSA scaffolding construction set Pos. 1 and 2 Safety harness, safety rope 2.00 m, backpack (Use only in scaffolding construction)		3.5		5969.170 🏠
4	Advance guardrail post Aluminium for one advance guardrail (1 m high); rapid attachment of guardrails with tilting pins	2.26	4.2	50	4031.001 🏠
5	Advance guardrail post Aluminium for two advance guardrails (0.50 m and 1 m high); rapid attachment of guardrails with tilting pins	2.26	4.3	50	4031.002 🏠
6	Assembly guardrail , 1.57 / 2.07 m Assembly guardrail , 2.57 / 3.07 m Aluminium	1.65	3.2	50	4031.207 🏠
		2.15	4.0	50	4031.307 🏠
7	Advance guardrail system (AGS) for scaffolding front end Aluminium, single-part	2.20 x 0.70	9.8	6	4031.000 🏠
8	Railing clamp	0.58	7.0	50	4015.100 🏠

Example for use of the railing clamp on floor slab:

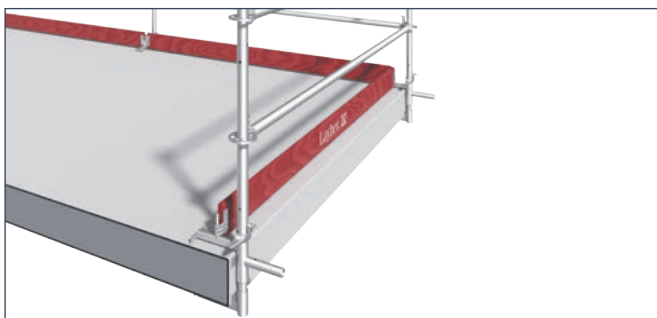

Example for use of the railing clamp on fascia:



WS = wrench size PU = packaging unit 🏠 = available ex works 🕒 = delivery time on request 🏠 = only available in this packaging unit ⚙️ = the approval process is not yet completed

Vertical transport

Rope hoists

The rope hoist **Mini 60 S, Maxi 120 S and Maxi 150 S 1** is suitable for vertical transport of scaffolding material weighing from 6 up to 150 kg.

The winch is fastened to the scaffolding at the bottom. For assembly and dismantling of the scaffolding, only the swing arm has to be attached to the topmost scaffolding standard. The maximum working height of the hoist is 40 m, or 67 m if the winch is positioned higher.

The hoist winch is operated with 230 V / 50 Hz. A slack rope switch shuts down the hoist when there is no longer any rope tension or when the end of the rope is reached. The hoist winch is equipped with an automatic final shutdown feature and a limiter against overloading of the hoist and scaffolding. For scaffolding hoists with a higher loading capacity, please request our special brochure. Loads additionally applied to the scaffolding must be transmitted into the structure or into the ground by special measures, and additional anchoring may be necessary. Please ask for further information about vertical transport.



Manual vertical transport

Bracket 12 with **hoist wheel 13** for manual vertical transport of scaffolding material weighing up to 50 kg. Loads additionally applied to the scaffolding must be transmitted into the structure or into the ground by special measures, and additional anchoring may be necessary.



Secure pulley 15

An integrated drop brake prevents the load from dropping when the rope is released and hence speeds up work procedures. The hoisted material is left suspended, thus permitting more flexible working both on the ground and on the scaffolding.



Pos.	Description	Dimensions L/H x W [m]	Weight approx. [kg]	PU [pcs.]	Ref. No.
1	Mini 60 S with 51 m of wire rope, catch and hook, control with emergency stop, 10 m, perm. load 60 kg hoisting speed 23/69 m/min		50.0		4415.060
	Mini 60 S with 81 m of rope, otherwise as 4415.060		55.0		4416.116
	Maxi 120 S perm. load 120 kg, otherwise as 4415.060 hoisting speed 20/60 m/min		65.0		4416.114
	Maxi 150 S perm. load 150 kg, otherwise as 4415.060 hoisting speed 15/45 m/min		65.0		4416.115
2	Swing arm for Mini 60 S, Maxi 120 S and Maxi 150 S with deflecting wheel permissible load: 150 kg		11.7		4416.015

LOAD-BEARING EQUIPMENT

3	Load hook for scaffolding parts		0.5		4416.001
4	Hook holder for 5 load hooks		2.3		4416.014
5	Rope sling (5 mm dia., 35 cm long) for holding several load hooks		0.1		4416.002
6	Bucket holder for 2 buckets		4.4		4416.005
7	Lifting sling , 1.50 m for transport of scaffolding decks		0.5		4416.013

ACCESSORIES

8	Control unit , 30 m with emergency stop Control unit , 50 m with emergency stop			7.0		4416.021
				13.0		4416.055
9	Security lock			1.1		4416.010
10	Swing arm holder (fitted in any scaffolding level)			8.0		4416.003
11	Wire rope , 51 m, 4.5 mm Wire rope , 81 m, 4.5 mm			4.5		4416.011
				6.3		4416.036
12	Bracket , 0.73 m with eyelet for hoist wheel	19 WS	0.73	6.4	100	1744.719
		22 WS	0.73	6.4	100	1744.722
13	Hoist wheel up to max. 50 kg load, dia. 350 mm, with CE-mark		0.50 x 0.40	2.7	6	4419.000
14	Shackle clip Connection of bracket with hoist wheel			0.2		4418.000
15	Secure pulley up to max. 50 kg load, with CE-mark		0.40 x 0.40	5.0	32	4419.001
16	Bracket adapter for hoist wheel Ref. No. 4419.001		0.26	1.2		4419.003
17	Rope for hoist wheel , without drop brake Plastic rope, dia. 20 mm, for hoist wheel Ref. No. 4419.000; load capacity 50 kg; manufactured as per DIN EN 1261 Shape A; with spliced loops as per DIN 83 319; fitted at one end with 1 shackle clip as per DIN 82 101, colour blue		20 m	6.4		4420.200
			40 m	12.4		4420.400
18	Rope for hoist wheel , with drop brake Plastic rope, dia. 18 mm, for hoist wheel Ref. No. 4419.001, colour orange, otherwise as rope for hoist wheel without drop brake		20 m	6.4		4419.020
			40 m	12.4		4419.040

WS = wrench size PU = packaging unit = available ex works = delivery time on request = only available in this packaging unit = the approval process is not yet completed

Vertical transport

Scaffolding construction hoist Layher 200

The **Layher 200** is suitable for vertical transport of scaffolding material weighing up to 200 kg and transport height of 35 m.

The **base unit 1** includes chassis, cable bin, trailing cable and control unit.

The mast with toothed rack can be fixed to the scaffolding using only one tube.

The anchoring distances are 4 m.

The entire unit only requires an area of 1.50 x 1.50 m on the ground, which makes it possible to load the hoist parallel to the building without any problems.

Unloading at the landing levels can be easily done by turning the platform.

The lightweight **platform 3** (only 51 kg) can be turned by 90° to the right.

The Layher 200 is easily serviced and maintained, i.e. easy access to handy components.

For stopping the loading platform in the right height, without mounting an additional position switch bracket, it is possible to place a **1.60 m ladder piece** directly above the base unit.



Please ask for further information about vertical transport.

Various accessories

Wood lacquer, red-brown 12

Painting or rolling: unthinned onto clean surface

Spraying: with 5 % synthetic resin thinner onto cleaned surface

Dust-dry: about 45 mins.

Dry to touch: about 4 – 5 hrs.

Thoroughly dry: about 24 hrs.

The **tube end cap 17/18/19** is the visual closure for the tube and keeps out dirt, water and the like. It can be fitted over or into the tube.

The **edge protector 20** protects from damages at the edges of transport goods.

For the use with aluminium tubes the spigots of the **tube end caps 18** and **19** must be cut longitudinally.

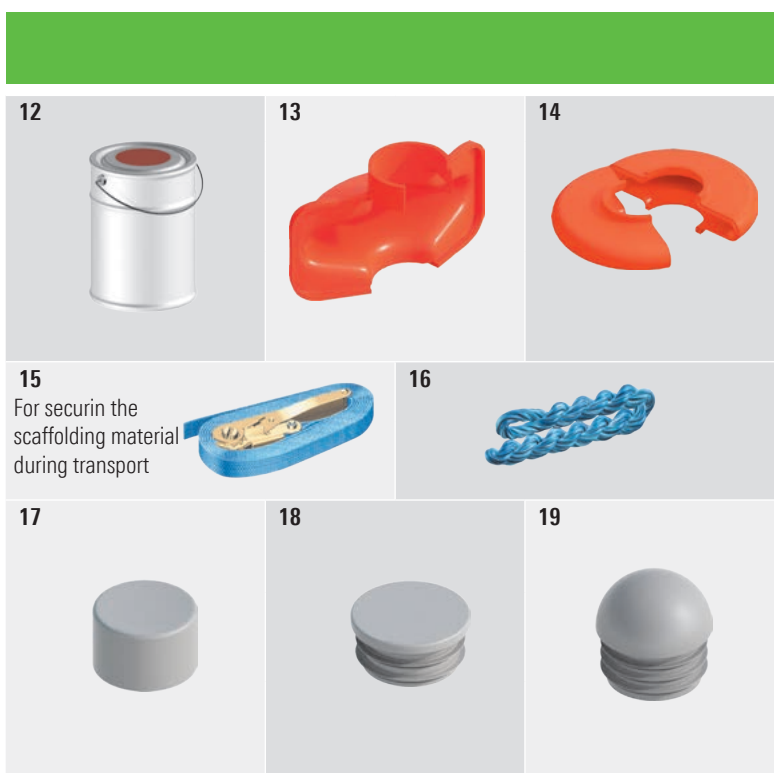

Pos.	Description	Dimensions L/H x W [m]	Weight approx. [kg]	PU [pcs.]	Ref. No.
1	Base unit Layher 200 1.7 kW / 230 VAC / 50 Hz, load capacity 200 kg, hoisting speed 25 m/min, max. hoisting height 35 m (Not allowed for passenger transportation) Scope of delivery: base part 2.00 m, electrical driven carriage, gripping device, control unit 5 m, cable bin, chassis		142.0		4416.883
2	Swivelling frame right, 90° swivelling		18.0		4416.822
3	Loading platform interior dimensions 1.20 x 0.75 x 1.80 m		51.0		4416.884
4	Holding rack for scaffolding parts (decks, toe boards or similar)		3.6		4416.885
5	Support for scaffolding tubes swivelling, 2-parts (with screwed on base bracket)		6.2		4416.886
6	Load secure bar with snap-on claws		2.4		4416.887
7	Ladder piece with toothed rack	2.00	24.0		4416.825
		1.60	20.3		4416.894
		1.00	14.0		4416.826
8	Ladder support holder spacings 4.00 m		9.4		4416.888
9	Position switch bracket for unloading break		2.6		4416.827
10	Advanced loading side guardrail for use with advance guardrail post (see page 34. Pos. 4)		9.3		4416.889
11	Cable extension, 20 m, for control unit, 5-pins		5.0		4416.331

Pos.	Description	Dimensions L/H x W [m]	Weight approx. [kg]	PU [pcs.]	Ref. No.
12	Wood lacquer, red-brown, 10 kg can		10.2		4020.000
13	Allround rosette cover with connected ledger Polyethylene, fixing with disposable tie 6241.001 (see page 25, Pos. 4)		0.7	10	4007.007
14	Allround rosette cover without connected ledger Polyethylene, fixing with disposable tie 6241.001 (see page 25, Pos. 4)		0.9	10	4007.008
15	Lashing strap with 0.5 t ratchet	4.00	0.2		6306.004
16	Poly cord, blue-white with fused ends, with spliced eyelet on one side, 3-strand, rope dia. 8 mm	2.50	1.0	10	4017.002
17	Tube end cap, dia. 48.3 mm, flat, external attachment Plastic		0.5	50	6494.532
18	Tube end cap, dia. 48.3 mm, flat, internal attachment Plastic		0.5	50	6494.534
19	Tube end cap, dia. 48.3 mm, round, internal attachment Plastic		1.0	50	6494.533

WS = wrench size PU = packaging unit = available ex works = delivery time on request = only available in this packaging unit = the approval process is not yet completed

Index

A					
Access ladder T15	25	Collar nut standard thread M14	15	Insert testing instrument	16
Accessories	36	Combination coupler	15	Internal spigot	13
Adjustable spigot	20	Control unit		J	
Adjustment plate	6, 7	30 m	35	Joint strap for aluminium keder rail	23
Advanced loading side guardrail	37	50 m	35	K	
Advance guardrail post	32, 33	Coupler	12, 14	Keder bow 2000 flexible	23
Advance guardrail system (AGS)	33	Cover for coupler	15	Keder rail holder	23
Advance telescopic guardrail	32	Cross head jack 45 solid	6, 7	Keder rail system	22
Allround rosette cover	37	D		Keder tarpaulin	22, 23
Aluminium keder bow		Disposable tie for net	25	L	
2000 eaves	23	Disposable tie for tarpaulin	25	Ladder access	24
2000 ridge	23	Double coupler	13, 14	Ladder piece	37
Aluminium keder rail		with coarse thread	13	Ladder support	37
2000	22, 23	Double flange castor	20, 21	Lashing strap	37
3000	23	Double guardrail		Lattice beam	6, 8, 10
Aluminium lattice beam		2.00 m	29	Lattice beam bolts	8
450	9	3.00 m	29	Lattice beam connector	6, 8, 10
750	8, 9	with toe board	28	Lattice beam coupler	12, 13
Aluminium pole ladder	25	E		Lattice beam hinged pin	8, 9
Aluminium section beam with wood	10, 11	Edge protector	36	Lattice beam mounting	10, 11
Aluminium stage 600	28	End-AGS	32	Lattice beam pin	9
Aluminium tri-lite beam	10	ETICS hanger bolt	17	Layher 200	36
Aluminium U-profile with half couplers	10, 11	ETICS-tie	16	LayPLAN	30
Alu stage		600 complete	17	Lifting sling	35
600	29	800 complete	17	Load hook	35
600 folding	29	ETICS-tie rod		450	19
Alu telescopic stage	28, 29	380	17	Loading platform	37
Assembly guardrail	33	480	17	Load secure bar	37
B		Extension lengths	32	Locking pin	20, 21, 29
Base plate	6, 7	F		Lock nut	17
60	7	Fall protection	32	M	
80	7	Flange castor	20, 21	Magnetic spirit level	17
150	7	G		Maxi	
Base unit	36	General assembly and extension	12	120 S	34, 35
Base unit Layher 200	37	Guardrail fixing	28, 29	150 S	34, 35
Beam connector	10, 11	Guardrail locking clip	28, 29	Measuring equipment	16
Beam connector bolt	11	Guardrail post	28, 29	Mesh box insert	27
Beam gripper	18, 19	H		Mini	
Bracket	34, 35	Half-coupler	14	60 S	34, 35
Bracket adapter	35	with eye bolt	15	Mobile beam with bar	20, 21
Bridging	28, 30	with hook	12, 13	Modular pallet	26, 27
Bucket holder	35	with plate	15	Modular skeleton box	26, 27
C		with toe board pin	15	O	
Cable extension	37	Head jack		Open ended wrench	17
Cap	17	45, solid	7	P	
Captive bolt	22	60, reinforced	7	Parts for rolling towers	20
Captive bolt for keder rail	23	Height adjuster for weather cap	23	Peg extraction device	17
Castor	20	Hinge fitting for weather cap	23	Peg solid	17
700	21	Hoist wheel	34, 35	Plastic pipe	17
750	21	Holding rack	37	Plastic wall insert	16, 17
1000	21	Hook holder	35		
1200	21	I			
Clamp	28, 29	Individual toe boards	28		
Clamp coupler	18, 19				
Clamp half-coupler	19				

Platform	36	Sheet metal fitting	30, 31	U	
Plug-testing device	17	Simple scaffolding ladders	24	Unit beam spigot	9
Plug tubes	27	Sleeve coupler	13	round steel	8
Poly cord	37	Software for scaffolding construction	30	T4	8, 9
Position switch bracket	37	Spare part	14	T16	9
Protection for pedestrians	18	Special bolt		Universal U-Lift-off preventer	11
Protection net	18	M12 x 60	9		
without quick strap fastener	19	M12 x 60 mm	8	V	
with quick strap fastener	19	M14 x 65	9	Vertical transport	34, 36
Protective base for base plate	6, 7	M14 x 65 mm	8		
PSA-Flex-safety rope	33	Spigot	21	W	
PSA-safety harness AX 60 C	32, 33	Spigot with half coupler	15	Wall tie	17
PSA scaffolding construction set	33	Spring clip	25	0.38 m	16
		Squared timber coupler		0.95 m/1.45 m/1.75 m	16
Q		large	15	Wedge double coupler	13
Quick strap fastener	19	small	15	Wedge half-coupler	14, 15
		Standard brick guard	18	Wedge spindle swivel coupler	13
R		Steel-gap cover	30, 31	Wedge swivel coupler	13
Rail holder	22	Steel lattice beam		Wire rope	
with half-coupler	23	750	8, 9	51 m	35
with wedge head	23	Steel plank	28	81 m	35
Railing clamp	32, 33	0.20 m	29	Wood lacquer	36, 37
Ratchet spanner	15	0.30 m	29		
Ratchet wrench	15	Steel pole ladder	25		
Reduction double coupler	13	Steel system lattice beam			
Reduction swivel coupler	13	450 LW	7		
Ring screw	16, 17	Steel tube	12, 13		
Rope for hoist wheel	35	Storey ladder	24		
Rope hoist	34	Support for scaffolding tubes	37		
Rope sling	35	Suspended scaffolding chain	18, 19		
Rubber base	25	Suspended scaffolding coupler	18, 19		
Rubber pad for base plate	7	Suspend scaffolding	18		
		Swing arm	35		
S		Swing arm holder	35		
Safety clip	8, 9	Swivel coupler	13		
Safety hook	18, 19	Swivel coupler with coarse thread	13		
Scaffolding construction hoist Layher 200	36	Swivelling base plate 60			
Scaffolding coupler	12	reinforced	7		
Scaffolding enclosures	22, 24	Swivelling frame	37		
Scaffolding identification	16	Swivelling head jack	6, 7		
Scaffolding identification pad	17	T			
Scaffolding lock	16, 17	T-bolt			
Scaffolding net	24, 25	standard thread M14	15		
Scaffolding pallet	26	Telescopic stabilizer	17		
Scaffolding plank	30, 31	Testing equipment	16		
Scaffolding ratchet	15	Three-point base plate	10, 11		
Scaffolding tarpaulin	24	Timber base plate	27		
200	25	Toe board	28, 29		
280	25	Tools	14		
Scaffolding tube	12, 13, 14	Tri-strut LW	10, 11		
Section beams	10	Tube brace	23		
Secure pulley	34, 35	Tube end cap	36, 37		
Securing Screw		Tube pallet	26		
long	29	85	26, 27		
short	29	125	26, 27		
Security lock	35	265	26, 27		
Shackle clip	35				

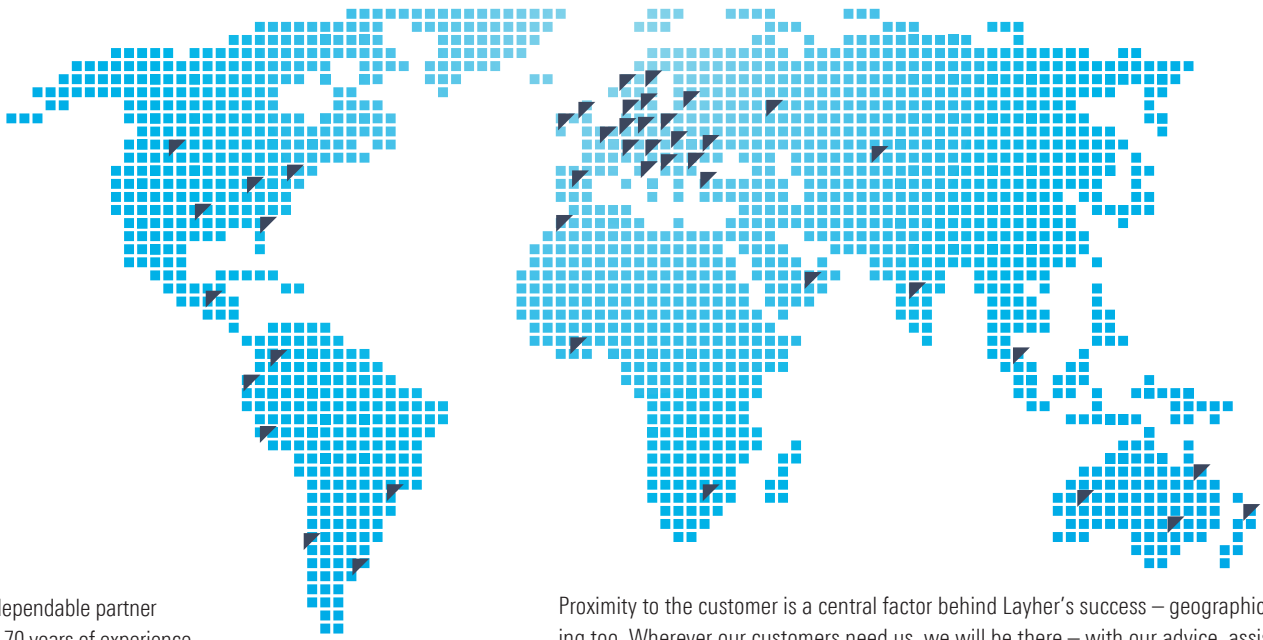

Layher is your dependable partner with more than 70 years of experience. "Made by Layher" always means "Made in Germany" too – and that goes for the entire product range. Superb quality – and all from one source.

Proximity to the customer is a central factor behind Layher's success – geographically speaking too. Wherever our customers need us, we will be there – with our advice, assistance and solutions.

-  **SpeedyScaf**
-  **Allround Scaffolding**
-  **System-free Accessories**
-  **Protective Systems**
-  **Shoring**
-  **Event Systems**
-  **Rolling Towers**
-  **Ladders**



Headquarters in Eibensbach



Plant 2 in Gueglingen

Layher 

More Possibilities. The Scaffolding System.

Wilhelm Layher GmbH & Co KG
Scaffolding Grandstands Ladders

Ochsenbacher Strasse 56
74363 Gueglingen-Eibensbach
Germany

Post Box 40
74361 Gueglingen-Eibensbach
Germany
Telephone +49 (0) 71 35 70-0
Telefax +49 (0) 71 35 70-2 65
E-mail export@layher.com
www.layher.com

