

ifm electronic



System manual
AS-i safety monitor

AS interface

AC041S

UK

7390926/00 05/2013

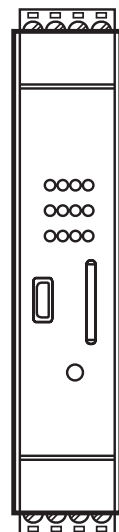

Contents



1	Preliminary note.....	4
1.1	Symbols used	4
2	Safety instructions	5
3	Items supplied.....	6
4	Functions and features	6
5	Structure and operating principle.....	7
6	Installation.....	7
6.1	Place device onto the DIN rail	7
7	Electrical connection.....	8
7.1	System test.....	8
7.2	Voltage supply 24 V (AUX)	8
7.3	Derating at voltage 24 V (AUX)	8
7.4	Wiring.....	9
7.5	Inputs.....	10
7.6	Outputs	11
7.7	Addressing.....	11
8	Operating and display elements	11
8.1	LEDs.....	12
8.1.1	Legend.....	12
8.1.2	LED connection	12
8.1.3	LED description	13
8.1.4	LED flashing pattern	15
8.2	Set button	16
8.3	Chip card	16
8.4	Interface.....	16
9	AS-i supply.....	17
9.1	Connection examples	18
9.2	Maintenance	23
10	AS-i diagnosis	23
10.1	Diagnosis modes	23
10.2	Data of the diagnosis modes	24
10.2.1	Diagnosis mode - consortial monitor, for replacement	25

10.2.2	Diagnosis mode - compatibility mode with additional diagnostics data	25
10.2.3	Diagnosis mode "AS-i 3.0 (S-7.5.5), recommended"	28
10.2.4	Transparent input data	29
10.2.5	Transparent output data	31
10.2.6	Acyclic data	31
11	Configuration of the safe inputs	39
11.1	Configuration options of the safe inputs	39
11.2	Assignment of the diagnostic outputs	41
11.3	Safe configuration using ASIMON 3 G2	42
11.4	Replace a defective safety-related AS-i slave	43
12	Safety requirements	44
12.1	Safety assessment of the selection OSSD / potential-free contacts	44
12.2	Recommendation for better availability of the function	45
13	Technical data	45
13.1	Safety classification	47
13.2	Response times	47
14	Terms and abbreviations	48
15	Standards and approvals	48
15.1	Directives and standards	48
15.2	Approvals	48
16	Disposal	48
17	Scale drawing	49

1 Preliminary note

The instructions are part of the unit. They are intended for authorised persons according to the EMC and Low Voltage Directives and safety regulations. The instructions contain information about the correct handling of the product. Read the instructions before use to familiarise yourself with operating conditions, installation and operation. Follow the safety instructions.

1.1 Symbols used

- ▶ Instruction
- > Reaction, result
- Cross-reference
- LED off
- ☀ LED on
- ⦿ LED flashes
- ⦿ LED flashes (same frequency)
- ⦿ LED flashes (push-pull)
-  Important note
Non-compliance can result in malfunction or interference.
-  Information
Supplementary note.

2 Safety instructions

- Follow the operating instructions.
- Improper use may result in malfunctions of the unit. This can lead to personal injury and/or damage to property during operation of the machine. For this reason note all remarks on installation and handling given in this document. Also adhere to the safety instructions for the operation of the whole installation.
- In case of non-observance of notes or standards, especially when tampering with and/or modifying the unit, any liability and warranty is excluded.
- The unit must be installed, connected and put into operation by a qualified electrician trained in safety technology.
- The applicable technical standards for the corresponding application must be complied with.
- For installation the requirements according to EN 60204-1 must be observed.
- In case of malfunction of the unit please contact the manufacturer. Tampering with the unit is not allowed.
- Disconnect the unit externally before handling it. Also disconnect any independently supplied relay load circuits.
- After installation of the system perform a complete function check.
- Use the unit only in specified environmental conditions (→ 13 Technical data). In case of special operating conditions please contact the manufacturer.
- Use only as described below (→ chapter 4).
- Safety switches fulfil a personal protection function. Incorrect installation or tampering can lead to serious injury.
- Safety components must not be bypassed (bridging of contacts), turned away, removed or otherwise rendered ineffective.
- On this point, take particular note of the measures to reduce the possibilities of bypassing in EN 1088:1995+A2:2008, section 5.7.
- A complete safety-related system normally consists of several signalling devices, sensors, evaluation units and concepts for a safe shut-down. The manufacturer of a machine or installation is responsible for a correct and safe overall function.
- All safety instructions and specifications in the operating instructions of the AS-Interface safety monitor must be adhered to.

3 Items supplied

- 1 AS-Interface safety monitor type AC041S
- 1 installation instructions AS-i safety monitor, ident number 7390918.
- Optional: software CD incl. system manual, ident number 7390926.

If one of the above-mentioned components is missing or damaged, please contact one of the ifm branch offices.

4 Functions and features

The device connects an AS-i Safety at Work I/O module and a safety monitor.

Special features:

- Safety monitor IP20
- Up to 8 non-safe local inputs / 4 safe local inputs

The safe inputs can be configured as standard inputs and as signal outputs at option.

- 2 local safe electronic outputs
- Support of 6 safe decentralised AS-i outputs

Max. 8 safe independent AS-i outputs are possible; several AS-i outputs on one address are possible.

- Chip card to save the configuration data

The device is certified to EN 62 061, SIL 3 and EN ISO 13 849-1 / Performance Level e.

► Use the AS-i safety monitor only in accordance with the "Intended use".



Any other use or any changes to the device - including during mounting and installation - shall void the warranty claim towards ifm electronic gmbh.

Safety requirements up to Performance Level e to EN ISO 13 849-1 and SIL3 to EN 62061 can be met with AS-i Safety at Work.

To be classified in this safety category all connected components, e.g. safety monitors, the safe AS-i participants and the connected sensors must comply with these standards.



The user is responsible for a safe integration of the device into a safe overall system.

5 Structure and operating principle

- The module only uses the necessary AS-i addresses.
- Different configuration options of the safe inputs of the device (→ chapter 11 Configuration of the safe inputs).
- No restrictions to the cable length of the safe inputs (the max. loop resistance is 150 Ω).
- A safe signal exchange between the safety monitor and the safe AS-i module as well as between two safe AS-i modules is possible.
- LED displays in accordance to other safe AS-i slaves.
- Easy configuration of the AS-i slaves via ASIMON software.
- Chip card for easy exchange.
- Micro USB interface for the configuration via ASIMON 3 G2.

UK

6 Installation

Install the device on a 35 mm DIN rail to DIN EN 50022 in the control cabinet.

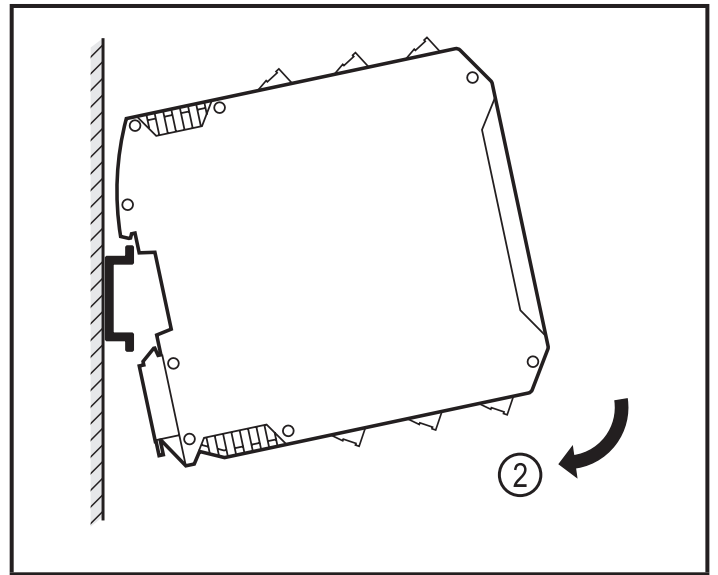
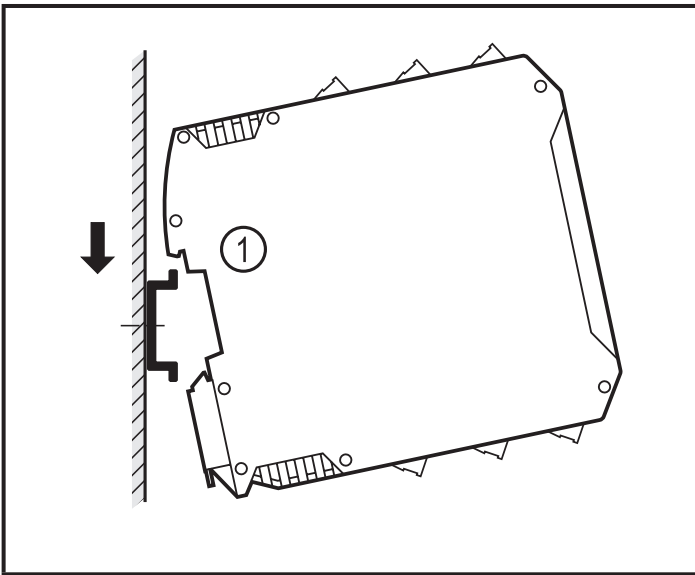

6.1 Place device onto the DIN rail



1. Angle the device and hook it onto the upper edge of the DIN rail.
 2. Push the device downwards and press to lock.
- > The device audibly clips into place.

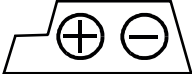
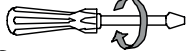

- ▶ Lay the supply, signal cables and the AS-Interface cables separately from high voltage cables.
- ▶ Use external relays or contactors connected to the safety monitor output with suitable protective circuitry.

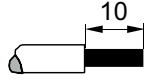
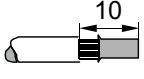
	Ambient temperature: 0...55°C	 Ø 5 ... 6 mm / PZ2	0.8 Nm 7 LB.IN
	Temperature range cable: 60-75 °C ▶ Only use copper wires.		2 x (0.5 ... 1.5) mm ²
			2 x (0.5 ... 1.5) mm ²
1 x 0.5...1.5 mm ² (16 AWG: min. 24 / max. 12)		AWG	2 x 24 ...12

7 Electrical connection

7.1 System test

As soon as the supply voltage is applied to the device, the internal system test begins. This operating status is indicated by the switching on of all LEDs installed in the device.

7.2 Voltage supply 24 V (AUX)



The circuits to be connected externally must be safely disconnected from the mains. The voltage supply of the +24 V (AUX) must only be made via SELV or PELV supplies.

The power supply to the 24 V supply must bridge a safe disconnection from the supply according to IEC60742 and short power failures up to 20 ms. The max. output voltage of the power supply must be < 42 V, also in case of an error.

7.3 Derating at voltage 24 V (AUX)

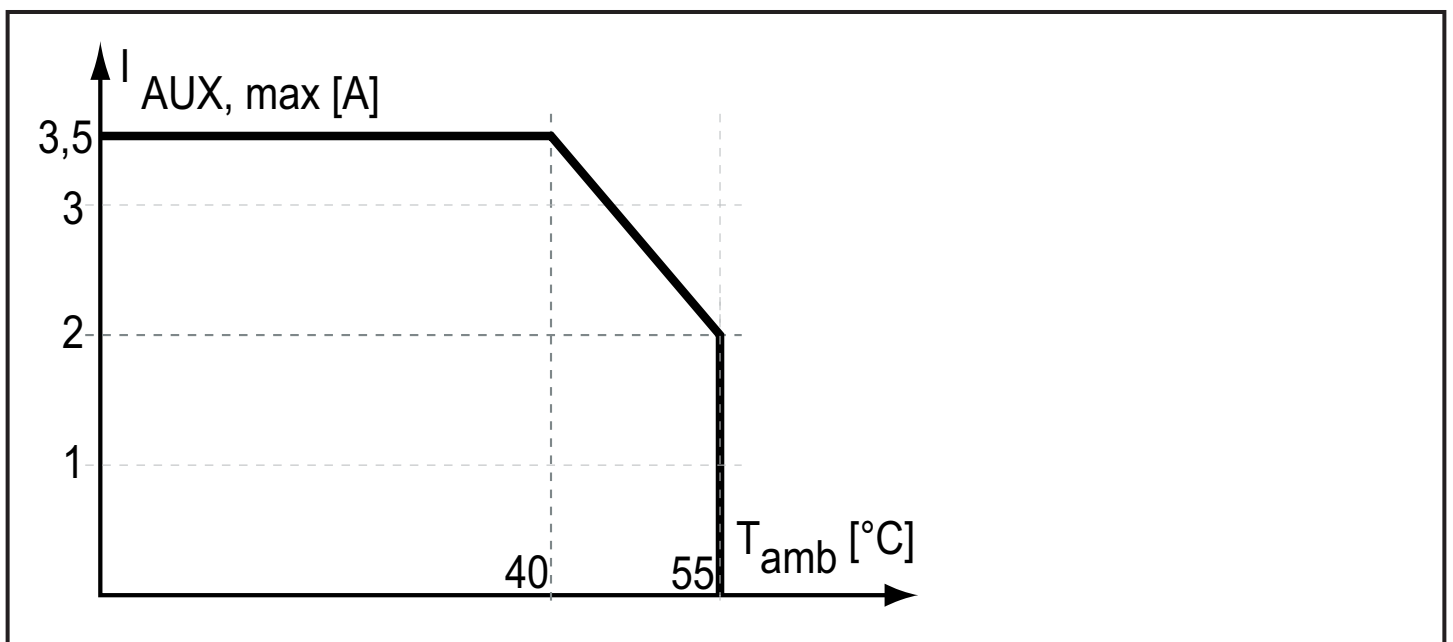

7.4 Wiring

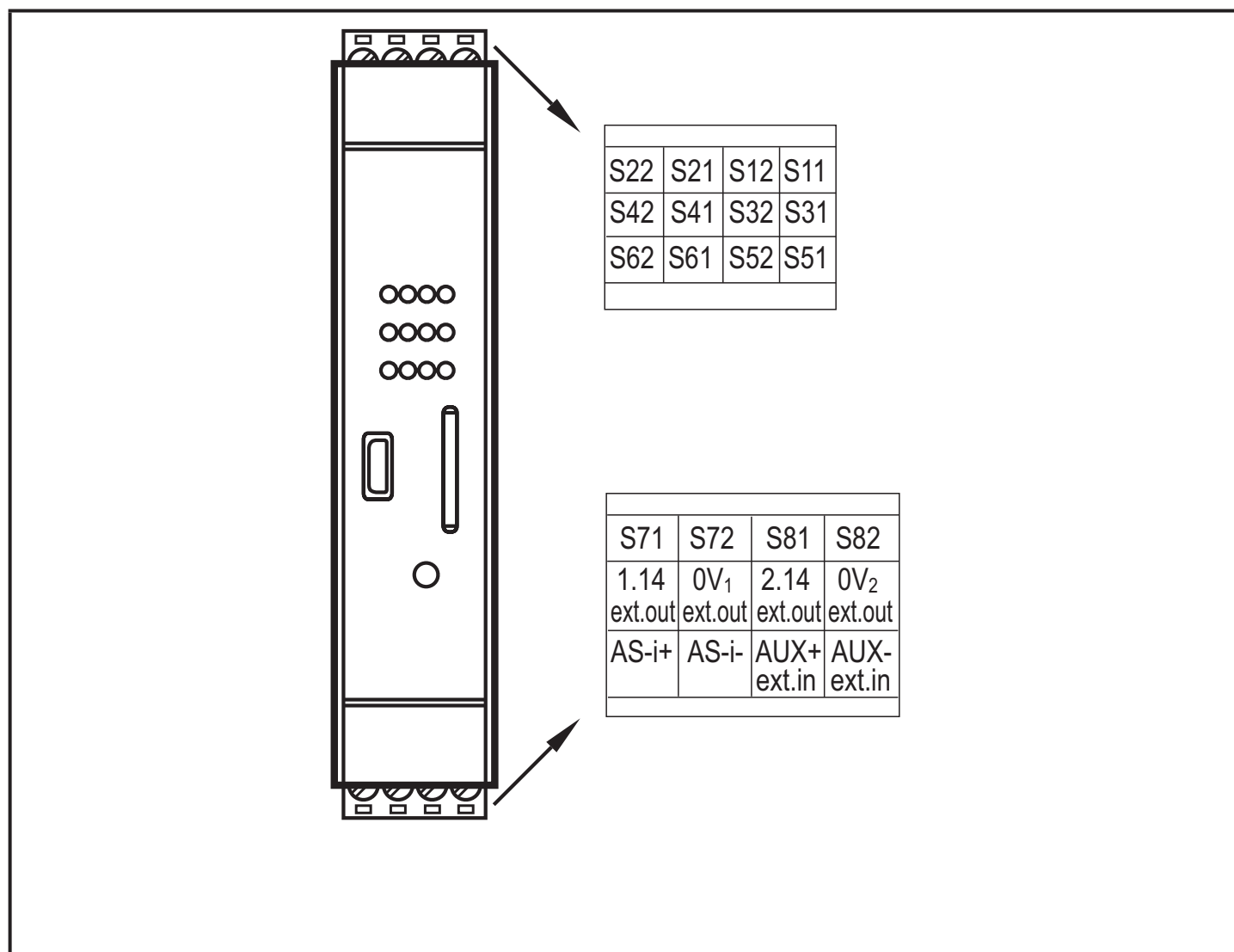

UK

Connection	Version	Direction
S11	Safe 2-channel input 1	Output
S12		Input
S21		
S22		Output
S31	Safe 2-channel input 2	Output
S32		Input
S41		
S42		Output

Connection	Version	Direction
S51	Safe 2-channel input 3	Output
S52		Input
S61		
S62		Output
S71	Safe 2-channel input 4	Output
S72		Input
S81		
S82		Output

1.14 ext. out	Safe semiconductor output 1
2.14 ext. out	Safe semiconductor output 2
0 V ext. out	Ground connection for semiconductor output
ASI+, ASI-	Connection to AS-Interface
AUX+, AUX-	Connection to ext. 24 V DC

7.5 Inputs

The inputs are supplied from the 24 V auxiliary supply (AUX). Each input consists of two connections:

- a passive input pin
- and an active test pulse output

Both pins are connected via a switch.

Two of the safe inputs are also suited as OSSD inputs; the others only for potential-free contacts.

Each safe input can also be configured as standard input. That means two non-safe standard inputs. The test-pulse outputs can be switched as diagnostic outputs (non safety related). Further information → chapter 9.1 Connection examples.

7.6 Outputs

- ▶ Supply the outputs from the PELV supply.

The max. output current is 700 mA for each output, the outputs are suited for DC13 loads. The plus pole of the output load is on 1.14 or 2.14.

- ▶ Connect the minus pole of the output load to 0 V ext out.
- ▶ Lay the connection cables between the module and the load so that no external voltage caused by damage insulation can switch the load unintentionally.

7.7 Addressing

The AS-i safety monitor can only be addressed using the ASIMON 3 G2 software.

- ▶ Assign a free address between 1 and 31.



No address allocation is possible using the addressing unit AC1154.

8 Operating and display elements

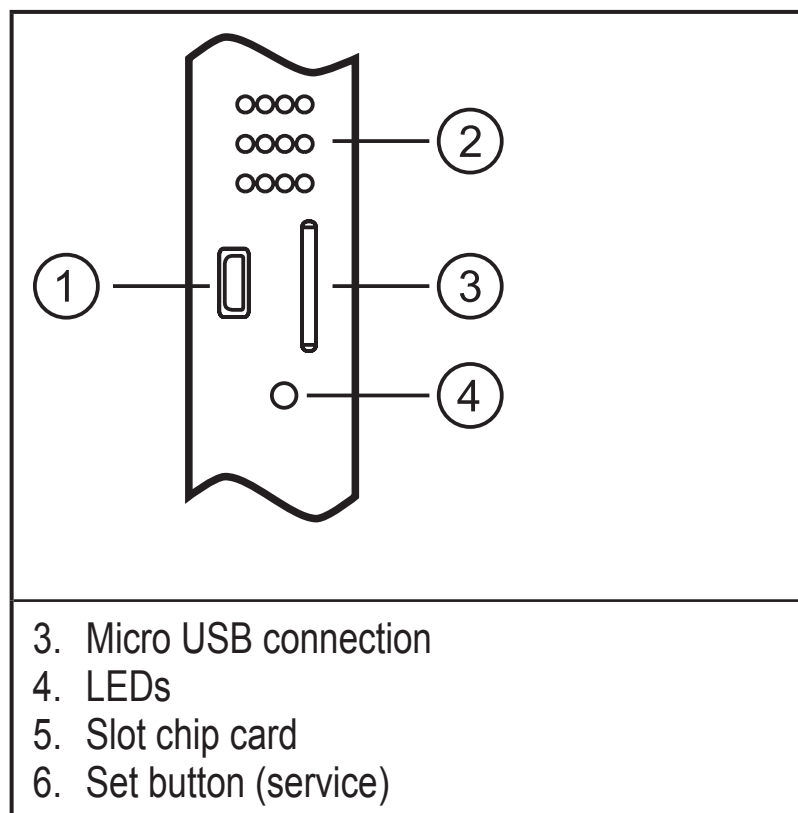

8.1 LEDs







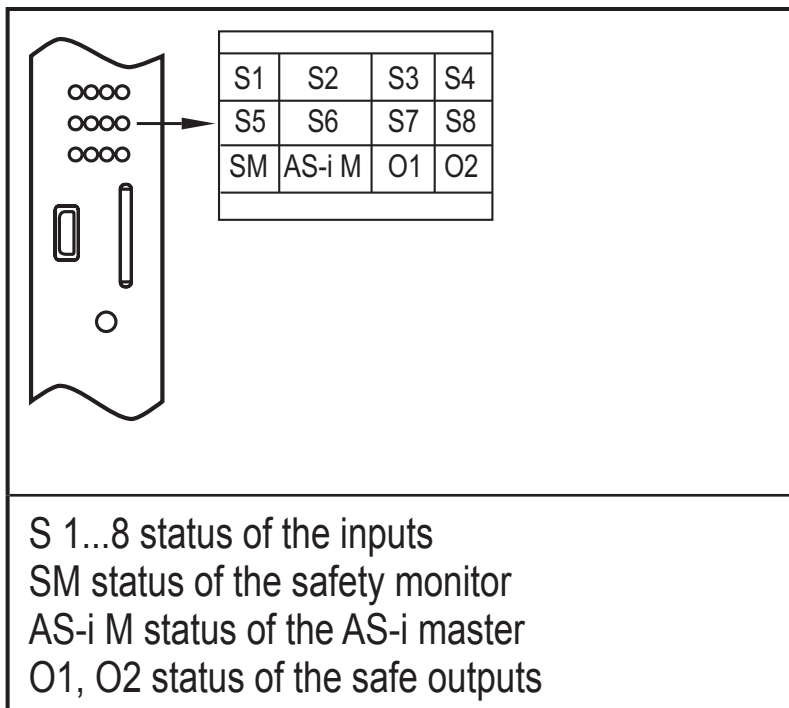





8.1.1 Legend

○	LED off
☀	LED on / lit
⦿	LED flashes
☀	LED flashes (same frequency)
☀	LED flashes (push-pull)













8.1.2 LED connection



8.1.3 LED description

LED	Colour	Status / frequency	Signal / description
S1...S8	Grey		Contacts (S1...S8) open
	Yellow	 1 Hz	Cross fault
			Contacts (S1...S8) closed
SM ₁	Grey		AS-i voltage not OK
	Green	 1 Hz	Protective operation and ASIMON active
			Protective operation active
	Red	 1 Hz	Configuration operation and ASIMON active
			Configuration operation active
		 2 Hz	Min. 1 device in state red flashing or yellow flashing
	Yellow	 2 Hz	
	Yellow	 1 Hz	Set button, "teach error" status
			Set button, "ready" status

UK

LED	Colour	Status / frequency	Signal / description
AS-i M ₂)	Grey		Offline, monitor mode
	Red	 1 Hz	Periphery fault without Config Error
			Config Error, auto addressing not possible
		 1 Hz	Config Error, auto addressing possible
	Green	 2 Hz	
			Master: protected mode, no error
			Master: projection mode, no error
O1, O2 ₃)	Grey		Output (O1, O2) off
	Yellow	 1 Hz	Restart disable
		 8 Hz	Error state can be resolved
			Output (O1, O2) on
	Red		AUX voltage missing
SM, AS-i M, O1, O2	Red	 1 Hz	Competing masters active
1)	Yellow has priority over Red and Green and is preferably displayed.		
2)	If Config Error and periphery fault occur simultaneously, only Config Error is indicated.		
3)	Red has priority over Yellow.		

8.1.4 LED flashing pattern

Operation	LEDs	Colour	Frequency	Status			
Data is stored on the chip card	S1...S4	Yellow	2 x 1 Hz				
	S5...S8						
	SM, AS-i M, O1, O2		→ chapter 8.1.2 and 8.1.3				
Internal error	S1...S4	Red	-				
	S5...S8		-				
	SM, AS-i M, O1, O2		8 Hz				
Data on the chip card and in the device differ	S1...S4	Yellow	1 Hz				
	S5...S8						
	SM, AS-i M, O1, O2		→ chapter 8.1.2 and 8.1.3				
Chip card is faulty	S1...S4	Yellow	1 Hz				
	S5...S8						
	SM, AS-i M, O1, O2		→ chapter 8.1.2 and 8.1.3				

UK

8.2 Set button

The set button (SET) has the following functions:

- Error acknowledgement
- Exchange of safe AS-i slaves without PC support

Pushbutton is pressed	Description
< 1 s	Error acknowledgement
> 1 s	Change to the projection mode The safety monitor changes to the projection mode > The safety monitor is ready to learn a code sequence
< 1 s	Projection mode (is exited without changes)
> 1 s	Save the current configuration in the safety monitor Teach one single code sequence of a new safety-related slave if exactly one safety-related slave is replaced.

8.3 Chip card

The chip card stores the configuration. All program operations are stored in the module and on the chip card simultaneously.

- The device can operate with and without chip card.
- If a **blank** chip card is inserted in a programmed module, the configuration of the module is stored on the chip card.
- If a chip card with stored data is inserted in an unprogrammed module, the configuration of the chip card is transferred to the module. The changes will not become effective before a restart of the module.
- If a chip card with stored data is inserted in another programmed module, the configurations are not adapted and an error message is displayed.

8.4 Interface

The unit has a 2.0 micro USB interface for data transfer.

9 AS-i supply

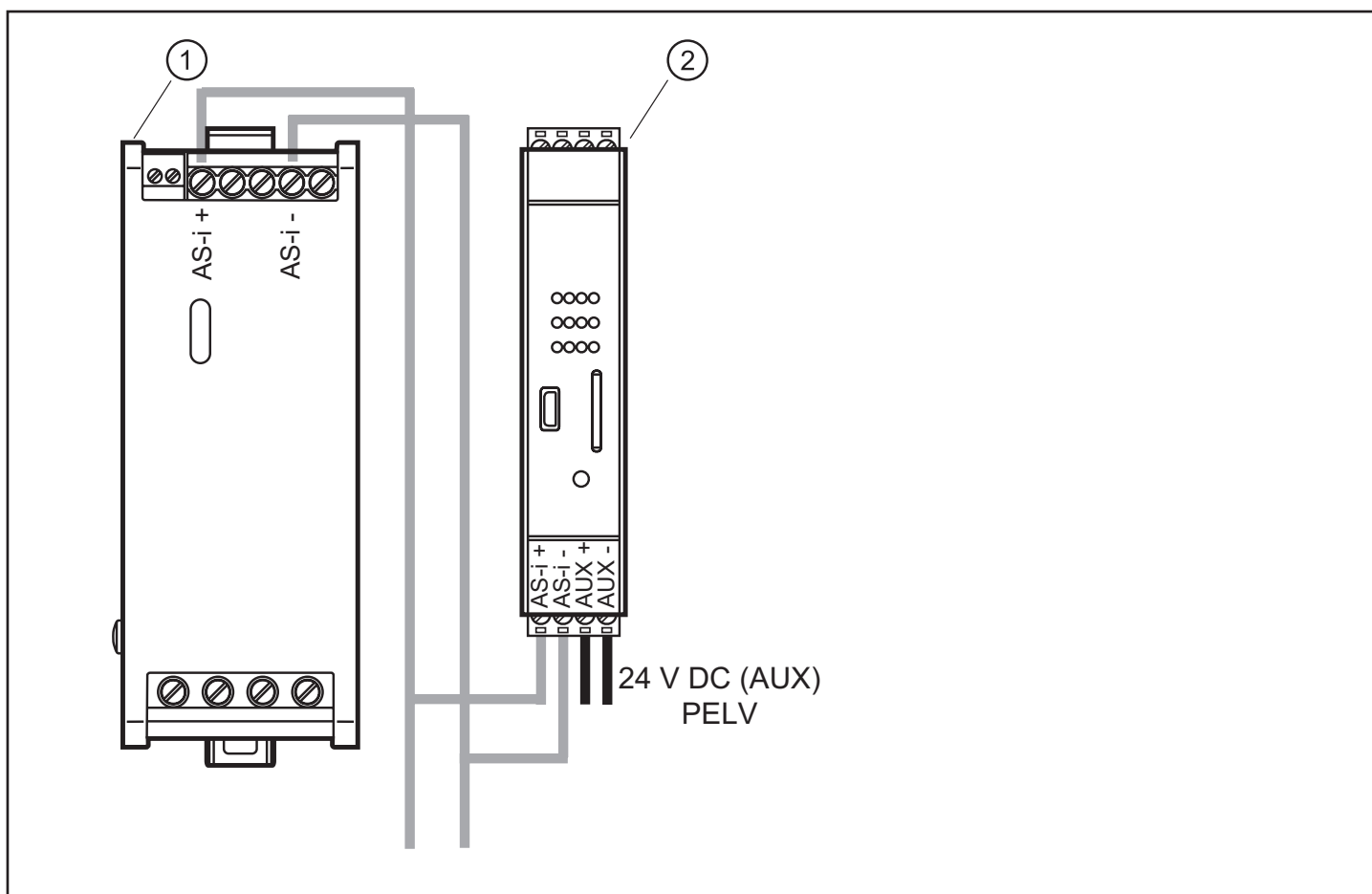

- 1: AS-i power supply
- 2: AS-i safety monitor



The AS-i power supply to supply the AS-i components must bridge a safe disconnection from the supply according to IEC60742 and short power failures up to 20 ms.

9.1 Connection examples

Connection of an ESPE, supply of several ESPEs from the same connection (S71)

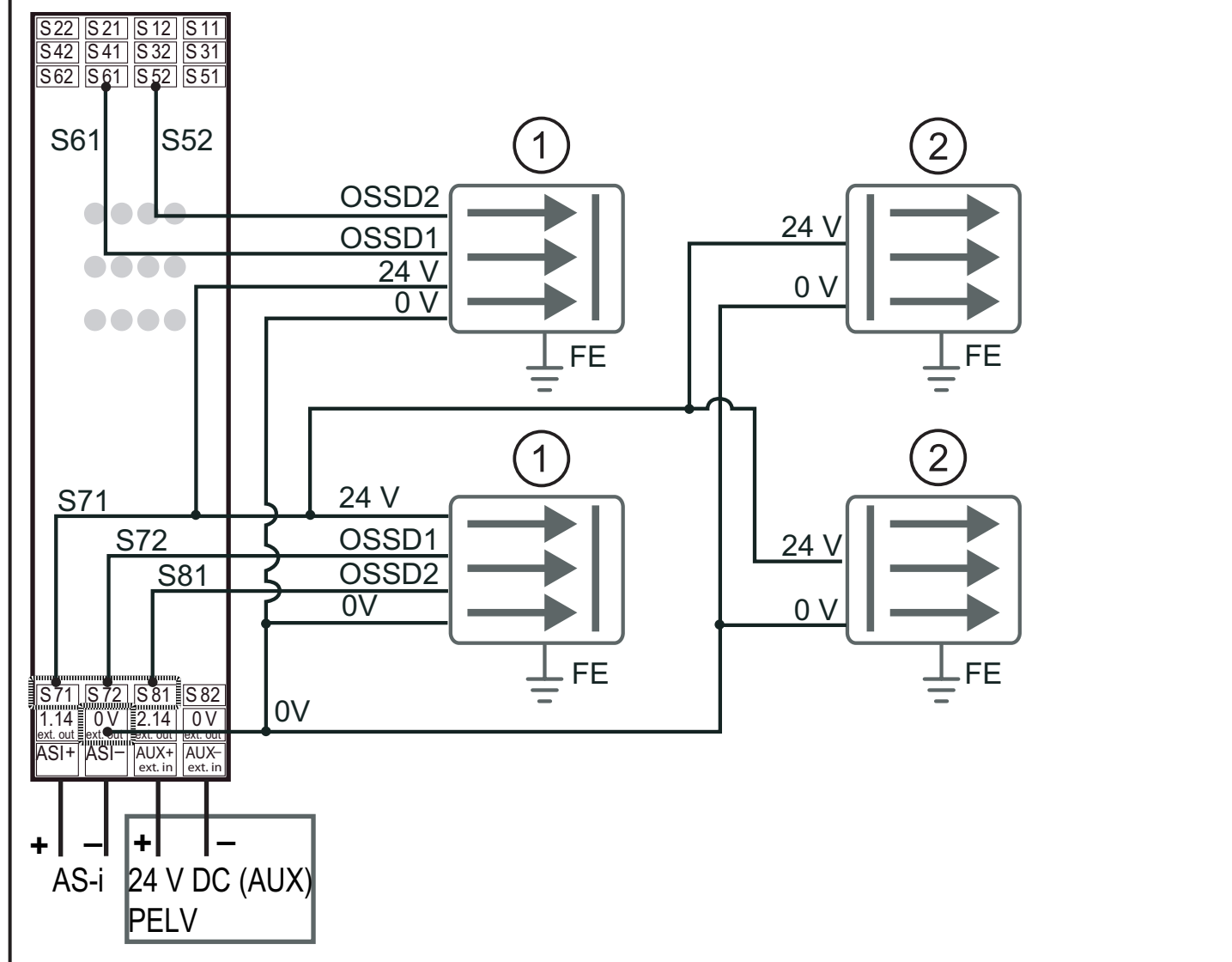

- 1: Receiver
- 2: Transmitter

Connection of a fail-safe inductive sensor

S22	S21	S12	S11
S42	S41	S32	S31
S62	S61	S52	S51

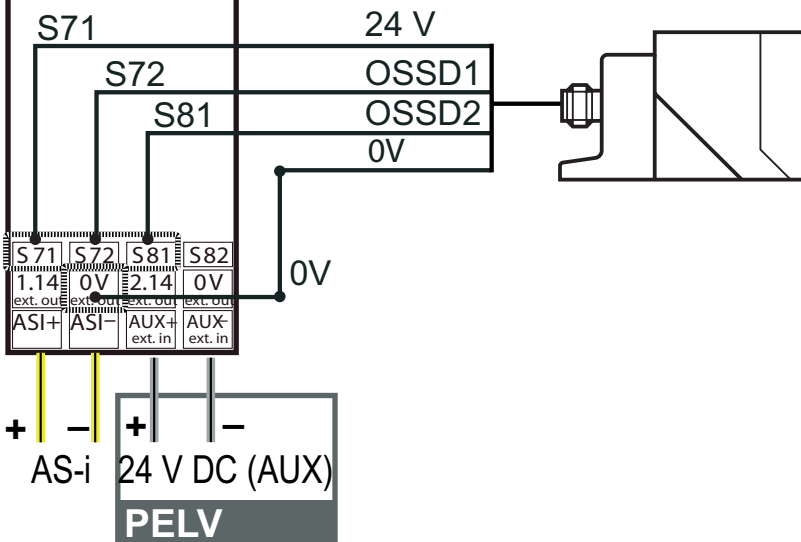
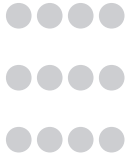

UK

Connection of a laser scanner

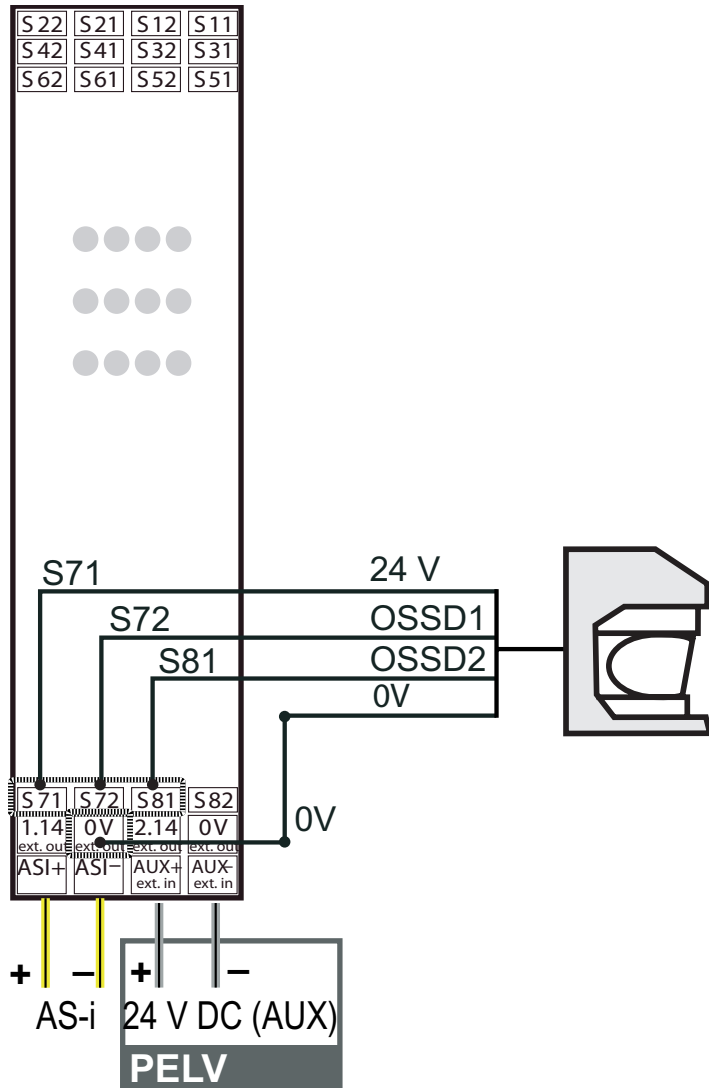

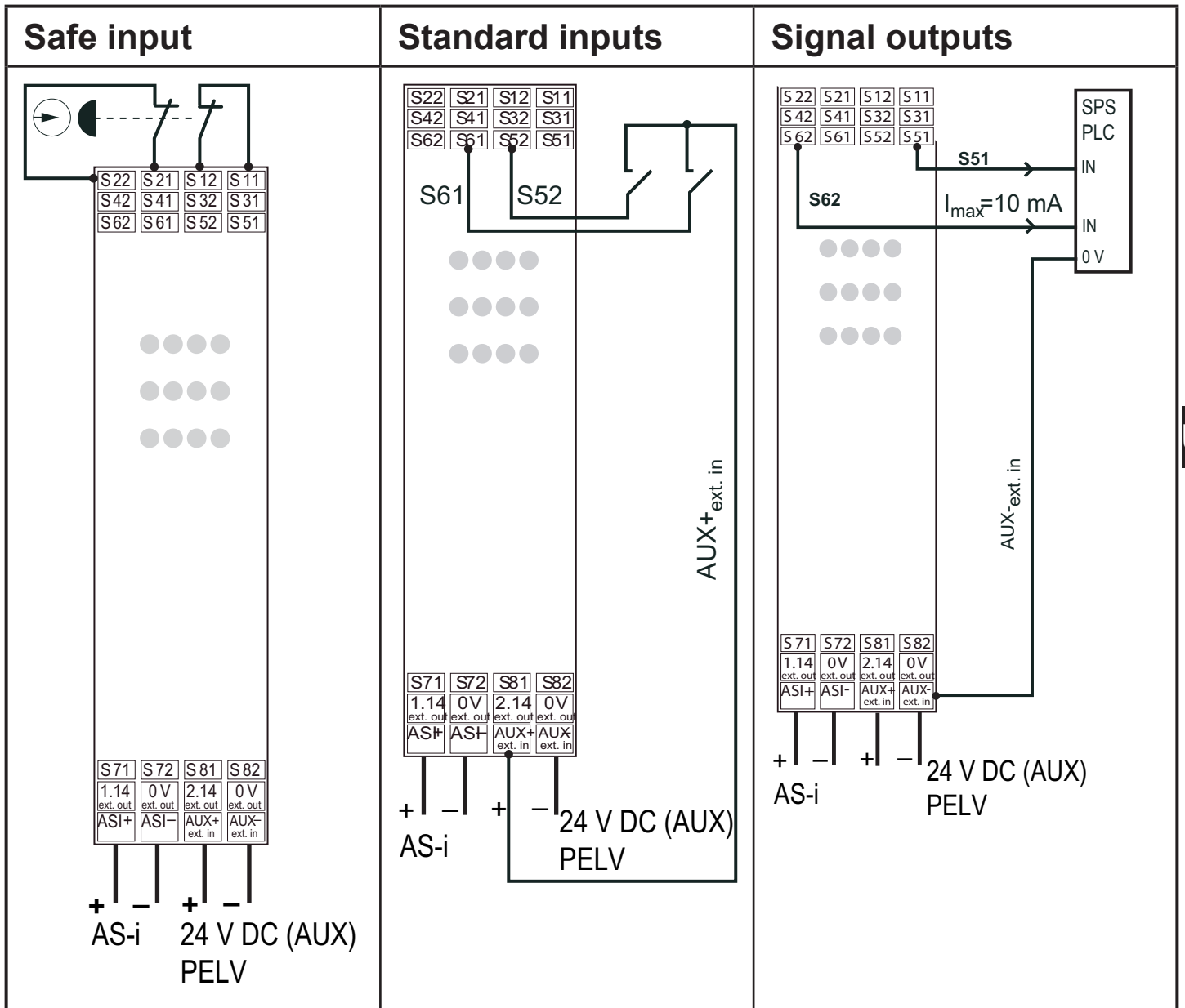

Contactor

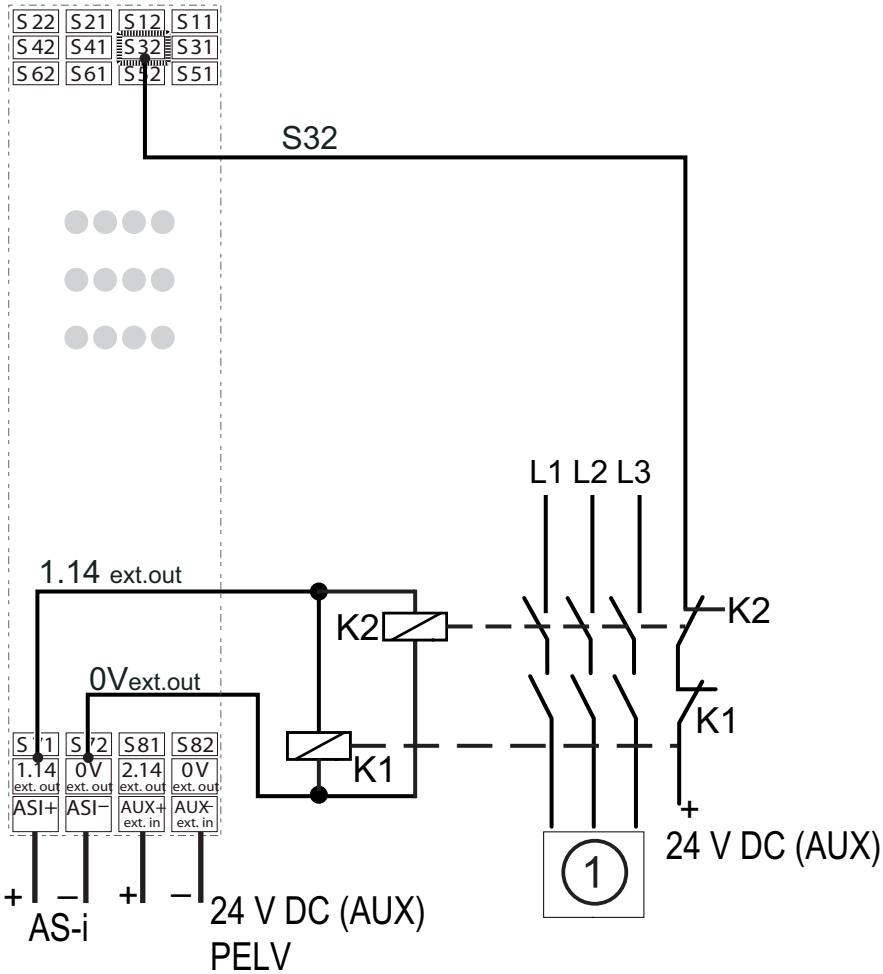

*** ASIMON**

1: Motor

* ASIMON

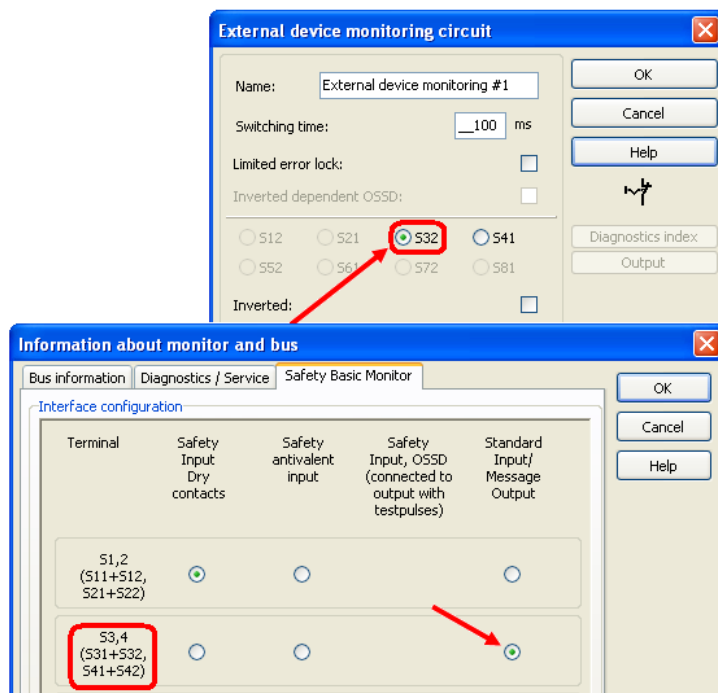

9.2 Maintenance

Check safe switch-off

The safety specialist is responsible for checking the reliable functioning of the safety monitor within the safeguarding system. Safe switch-off on triggering of an associated safety-related sensor or switch has to be checked at least once a year.

- ▶ Activate the safety-related AS-i slave.
- ▶ Observe the switching behaviour of the output circuits of the AS-i safety monitor.



- ▶ Observe the max. switch-on time and the total operating time.

These values depend on the PFD value selected for the total failure probability → chapter Safety characteristics.

- ▶ Check the complete safety system for its proper function when the max. switch-on time has been reached (three, six or twelve months).

The manufacturer has to check the device for its proper function at the manufacturer's factory when the total operating time (20 years) has been reached.

UK

10 AS-i diagnosis

10.1 Diagnosis modes

- Consortial monitor, for replacement (→ chapter 10.2.1)
- Compatibility mode with additional diagnostic data (→ chapter 10.2.2)
- AS-i 3.0 (S-7.5.5), recommended (→ chapter 10.2.3)

The respective diagnosis mode is selected via the ASIMON 3 G2 software.

- ▶ Open the [Information about monitor and bus] window in the ASIMON 3 G2 software.
- ▶ Activate the [Diagnostics/Service] tab.
- ▶ Select the required diagnosis type.

10.2 Data of the diagnosis modes

	AS-i 3.0 (S-7.5.5), diagnosis mode recommended (→ chapter 10.2.3)	Consortial monitor, for replacement (→ chapter 10.2.1)	Compatibility mode with additional diagnostic data (→ chapter 10.2.2)
Basic address	S-7.5 communication (→ chapter 10.2.3... 10.2.6)	Consortial diagnosis see ASIMON 3 G2 software manual	Consortial diagnosis see ASIMON 3 G2 software manual
Basic address +1 simulated slave	Status OSSD1+OSSD2	Status OSSD1+OSSD2	Status OSSD1+OSSD2
Basic address +2 simulated slaves	S-7.F slave, input data = 0	S-7.F slave, input data = 0	S-7.3.0.C slave (→ chapter 10.2.2)
Basic address +3 simulated slaves	S-7.F slave, input data = 0	S-7.F slave, input data = 0	S-7.3.1.C slave (→ chapter 10.2.2)

10.2.1 Diagnosis mode - consortial monitor, for replacement



Diagnosis type

Compatibility mode for safety basic monitors from safety version SV4.3

Address	Description
Basic address	Consortial diagnosis, limited to 48 devices
Simulated slave 1	Status OSSD1 and OSSD2
Simulated slave 2	S-7.F slave, input data=0
Simulated slave 3	

UK

Simulated slave 1: Status OSSD 1 and OSSD 2 (binary data)

Data bit	Contents
D1	Status relay output 1
D2	Status signal output 1
D3	Status relay output 2
D4	Status signal output 2

10.2.2 Diagnosis mode - compatibility mode with additional diagnostics data



Diagnosis type

Compatibility mode for safety basic monitors from safety version SV4.3

Address	Description
Basic address	Consortial diagnosis, limited to 48 devices
Simulated slave 1	Status OSSD1 and OSSD2
Simulated slave 2	S-7.3 OSSD diagnosis, 4-channel transparent input, profile S-7.3.0.C
Simulated slave 3	S-7.3 Safety at Work slave diagnosis, 4-channel transparent input, profile 7.3.1.C

Simulated slave 1: Status OSSD 1 and OSSD 2 (binary data)	
Data bit	Contents
D0	Status relay output 1
D1	Status signal output 1
D2	Status relay output 2
D3	Status signal output 2

Simulated slave 2 (7.3.0.C): OSSD diagnosis									
	15	14	13	12	11	10	9	8	7...0
Ch1	Safety status OSSD 2								Safety status OSSD 1
CH2	Safety status OSSD 4								Safety status OSSD 3
CH3	Safety status OSSD 6								Safety status OSSD 5
CH4	S8	S7	S6	S5	S4	S3	S2	S1	Safety status OSSD 7

For a closed switch S1...S8, '1' is entered at the respective position. The safety status is defined as follows:

Bit	7	6	5	4	3	2	1	0
	1: min. one device flashing red	1: min one device flashing yellow	n/a	n/a	Colour of the OSSD (→ Table Coding of the status of the enable circuits (OSSD))			









Simulated slave (Slv) 3 (S-7.3.1.C): Safety at work slave diagnosis																
	15	14	13	12	11	10	9	8	7	6	5	4	3	2	1	0
Ch1	Slv7		Slv6		Slv5		Slv4		Slv3		Slv2		Slv1			
CH2	Slv15		Slv14		Slv13		Slv12		Slv11		Slv10		Slv9		Slv8	
CH3	Slv23		Slv22		Slv21		Slv20		Slv19		Slv18		Slv17		Slv16	
CH4	Slv31		Slv30		Slv29		Slv28		Slv27		Slv26		Slv25		Slv24	

The status of the code sequence is entered for each safe slave (ID=B) as seen from the master. Code sequence errors are not detected here. '00' is entered for non-safe slaves.

UK

Bit combination	Description
00	No safe slave or safe slave with zero sequence, both switches open
01	Safe slave, switch for upper bits open
10	Safe slave, switch for lower bits open
11	Safe slave, both switches closed

Coding of the states of the enable circuits (OSSD)

Code Bits 3...0	Colour / status	Description
0	Green 	Output on
1	Green 	Waiting time running at stop 1
2	Yellow 	Start-up / restart disable active
3	Yellow 	External test necessary / acknowledgement / switch-on delay active
4	Red 	Output off
5	Red 	Error
6	Grey  or 	Output not projected
7...F	Reserved	



Monitors supporting fewer than 8 enable circuits set all enable circuits that are not available to grey.

10.2.3 Diagnosis mode "AS-i 3.0 (S-7.5.5), recommended"

Binary data

	D3	D2	D1	D0
Input data	Serial communication	Serial communication	1: Output 2 either switched off or flashing green	1: Output 1 either switched off or flashing green
Output data	-	-	Serial communication	Serial communication

10.2.4 Transparent input data

The profile 7.5.5 allows to cyclically poll the status of the enable circuits (OSSD status) of the safety monitor (→ table below).

- ▶ Address safety monitor (basic address)
- ▶ Reserve an 8-byte analogue input slave on the basic address of the safety monitor in the control configuration.
- > The diagnostic data (transparent input data) is listed in these 8 bytes according to the following table:

Channel	2 ¹⁵	2 ¹⁴	2 ¹³	2 ¹²	2 ¹¹	2 ¹⁰	2 ⁹	2 ⁸
CH 0	AU	MO			S8	S7	S6	S5
CH 1	Safety status OSSD 4				Safety status OSSD 3			
CH 2	Safety status OSSD 8				Safety status OSSD 7			
CH 3	OSSD 8		OSSD 7		OSSD 6		OSSD 5	
Colour / status								

Channel	2 ⁷	2 ⁶	2 ⁵	2 ⁴	2 ³	2 ²	2 ¹	2 ⁰
CH 0	S4	S3	S2	S1	UA 1	UA		
CH 1	Safety status OSSD 2				Safety status OSSD 1			
CH 2	Safety status OSSD 6				Safety Status OSSD 5			
CH 3	OSSD 4		OSSD 3		OSSD 2		OSSD 1	
Colour / status								



UK

Below you will find the individual information; Channel 0









MO	Operating mode	1: Safety monitor in the protected mode 0: Safety monitor in the configuration operation
UA	AS-i	AS-i voltage via 18 V 1: Voltage is sufficient. 0: Voltage is not sufficient
UA 1	Warning	AS-i voltage is applied, however below 22.5 V 1: AS-i voltage > 22.5 V 0: AS-i voltage below < 22.5 V
AU	AUX 24 V	24 V voltage supply for the safe outputs is available 1: 24 V voltage supply for the safe outputs is available 0: 24 V voltage supply for the safe outputs is not available
S1...S8	Switch	S1...S8: For a closed switch S1...S8, '1' is entered at the respective position.

The channels 1 and 2 describe the status of the respective enable circuits 1...8 (OSSD) of the safety monitor.

Channel 3 contains information if there are any warnings or interference on one or several devices assigned to this enable circuit. Meaning:

YF	Flashing yellow 	At least one of the modules assigned to this enable circuit is in the state "flashing yellow".
RF	Flashing red 	At least one of the modules assigned to this enable circuit is in the state "flashing red".

Coding of the states of the enable circuits (OSSD)

Code Bits 3...0	Colour / status	Description
0	Green 	Output on
1	Green 	Waiting time running at stop 1
2	Yellow 	Startup / restart disable active
3	Yellow 	External test necessary / acknowledgement / switch-on delay active
4	Red 	Output off
5	Red 	Error
6	Grey  or 	Output not projected
7...F	Reserved	

UK

10.2.5 Transparent output data

The transparent output data is available to the safety monitor as unsafe additional bits, for example for start buttons. They are linked with the input bits of the terminals configured as unsafe input.

Channel	$2^{15}...2^8$	2^7	2^6	2^5	2^4	2^3	2^2	2^1	2^0
CH0	Reserved	S8	S7	S6	S5	S4	S3	S2	S1

10.2.6 Acyclic data



The maximum possible data length for the Controller E is 32 bytes.
This has to be taken into account for the acyclic data.

Vendor-specific object 7 - device colours OSSD1

Read only

This object contains the colours and additional information about all enable circuits for the devices assigned to enable circuit 1.



The monitor can shorten the S-7.5.5 telegram if not all 128 devices are used.

► Reduce transmission time.

Coding of the states and colours

Word	Description
0	Bit 8 0=configuration operation, 1=protected operating mode Bits 9...11 reserved, 0 Non-safe inputs (signal inputs): Bit 12 status S12 Bit 13 status S21 Bit 14 status S32 Bit 15 status S41
1	Status outputs 1...4 Bits 3...0 output status 1 Bits 7...4 output status 2 Bits 11...8 output status 3 Bits 15...12 output status 4
2...3	...
4	Status outputs 13...16 Bits 11...8 output status 15 Bits 15...12 output status 16
5...12	Bit field for devices that are available. Devices 0...127
13...20	Reserved
21	Colour devices 1+2 Bits 3...0 colour device 1 Bits 7...4 colour device 2
22...51	...
52	Devices 127+128 Bits 11...8 colour device 127 Bits 15...12 colour device 128



The maximum possible data length of the Controller E (AC13xx) is highlighted in blue in the following table.

Data word	bit																
	15	14	13	12	11	10	9	8	7	6	5	4	3	2	1	0	
0	S41	S32	S21	S12	Reserved				BA	Reserved for CTT2 Response Code (only AC14nn)							
1	Status output 4				Status output 3				Status output 2				Status output 1				
2	Status output 8				Status output 7				Status output 6				Status output 5				
3	Status output 12				Status output 11				Status output 10				Status output 9				
4	Status output 16				Status output 15				Status output 14				Status output 13				
5	BI 15	BI 14	BI 13	BI 12	BI 11	BI 10	BI 9	BI 8	BI 7	BI 6	BI 5	BI 4	BI 3	BI 2	BI 1	BI 0	
6	BI 31	BI 30	BI 29	BI 28	BI 27	BI 26	BI 25	BI 24	BI 23	BI 22	BI 21	BI 20	BI 19	BI 18	BI 17	BI 16	
7	BI 47	BI 46	BI 45	BI 44	BI 43	BI 42	BI 41	BI 40	BI 39	BI 38	BI 37	BI 36	BI 35	BI 34	BI 33	BI 32	
8	BI 63	BI 62	BI 61	BI 60	BI 59	BI 58	BI 57	BI 56	BI 55	BI 54	BI 53	BI 52	BI 51	BI 50	BI 49	BI 48	
9	BI 79	BI 78	BI 77	BI 76	BI 75	BI 74	BI 73	BI 72	BI 71	BI 70	BI 69	BI 68	BI 67	BI 66	BI 65	BI 64	
10	BI 95	BI 94	BI 93	BI 92	BI 91	BI 90	BI 89	BI 88	BI 87	BI 86	BI 85	BI 84	BI 83	BI 82	BI 81	BI 80	
11	BI 111	BI 110	BI 109	BI 108	BI 107	BI 106	BI 105	BI 104	BI 103	BI 102	BI 101	BI 100	BI 99	BI 98	BI 97	BI 96	
12	BI 127	BI 126	BI 125	BI 124	BI 123	BI 122	BI 121	BI 120	BI 119	BI 118	BI 117	BI 116	BI 115	BI 114	BI 113	BI 112	
13	Reserved																
14																	
15																	
16																	
17																	
18																	
19																	
20																	
21	Status device index 3				Status device index 2				Status device index 1				Status device index 0				
22	Status device index 7				Status device index 6				Status device index 5				Status device index 4				
23	Status device index 11				Status device index 10				Status device index 9				Status device index 8				
24	Status device index 15				Status device index 14				Status device index 13				Status device index 12				
25	Status device index 19				Status device index 18				Status device index 17				Status device index 16				
26	Status device index 23				Status device index 22				Status device index 21				Status device index 20				
27	Status device index 27				Status device index 26				Status device index 25				Status device index 24				
28	Status device index 31				Status device index 30				Status device index 29				Status device index 28				
29	Status device index 35				Status device index 34				Status device index 33				Status device index 32				
30	Status device index 39				Status device index 38				Status device index 37				Status device index 36				
31	Status device index 43				Status device index 42				Status device index 41				Status device index 40				
32	Status device index 47				Status device index 46				Status device index 45				Status device index 44				
33	Status device index 51				Status device index 50				Status device index 49				Status device index 48				
34	Status device index 55				Status device index 54				Status device index 53				Status device index 52				
35	Status device index 59				Status device index 58				Status device index 57				Status device index 56				
36	Status device index 63				Status device index 62				Status device index 61				Status device index 60				
37	Status device index 67				Status device index 66				Status device index 65				Status device index 64				
38	Status device index 71				Status device index 70				Status device index 69				Status device index 68				
39	Status device index 75				Status device index 74				Status device index 73				Status device index 72				
40	Status device index 79				Status device index 78				Status device index 77				Status device index 76				
41	Status device index 83				Status device index 82				Status device index 81				Status device index 80				
42	Status device index 87				Status device index 86				Status device index 85				Status device index 84				
43	Status device index 91				Status device index 90				Status device index 89				Status device index 88				
44	Status device index 95				Status device index 94				Status device index 93				Status device index 92				
45	Status device index 99				Status device index 98				Status device index 97				Status device index 96				
46	Status device index 103				Status device index 102				Status device index 101				Status device index 100				
47	Status device index 107				Status device index 106				Status device index 105				Status device index 104				
48	Status device index 111				Status device index 110				Status device index 109				Status device index 108				
49	Status device index 115				Status device index 114				Status device index 113				Status device index 112				
50	Status device index 119				Status device index 118				Status device index 117				Status device index 116				
51	Status device index 123				Status device index 122				Status device index 121				Status device index 120				
52	Status device index 127				Status device index 126				Status device index 125				Status device index 124				

BI = device index

BA = operating mode

Coding of the bit field for available devices









The numbers indicate the position of the bit for the respective device.

0: Device is not available

1: Device is available

Byte	2 ⁷	2 ⁶	2 ⁵	2 ⁴	2 ³	2 ²	2 ¹	2 ⁰
1	7	6	5	4	3	2	1	0
2	15	14	13	12	11	10	9	8
...	...							
32	255	254	253	252	251	250	249	248

Coding of the states and colours

Code Bits 2...0	Colour / status
0	Green 
1	Green 
2	Yellow 
3	Yellow 
4	Red 
5	Red 
6	Grey  or 
7	Not available
Bit 3	0 device is not present in this enable circuit 1 device is available in this enable circuit

Vendor-specific object 9 - device colours at switch off OSSD 1 (history memory)

Read only

This object contains the colours for all devices. In addition the information about all enable circuits at the time enable circuit 1 is last switched-off. In addition the information is transferred which devices belong to enable circuit 1.

Coding of the states and colours

Word	Description
0...4	Reserved
5...12	Bit field for devices that are available. Devices 0...127
13...20	Reserved
21...28	Bit field for devices that changed in the last step.Devices 0...128
29...36	Reserved
37...68	Bit field for devices that are available.Devices 0...127 (device colour)

UK

bit															
15	14	13	12	11	10	9	8	7	6	5	4	3	2	1	0
Reserved								Reserved for CTT2 Response Code (only AC14nn)							
Reserved															
BI 15	BI 14	BI 13	BI 12	BI 11	BI 10	BI 9	BI 8	BI 7	BI 6	BI 5	BI 4	BI 3	BI 2	BI 1	BI 0
BI 31	BI 30	BI 29	BI 28	BI 27	BI 26	BI 25	BI 24	BI 23	BI 22	BI 21	BI 20	BI 19	BI 18	BI 17	BI 16
BI 47	BI 46	BI 45	BI 44	BI 43	BI 42	BI 41	BI 40	BI 39	BI 38	BI 37	BI 36	BI 35	BI 34	BI 33	BI 32
BI 63	BI 62	BI 61	BI 60	BI 59	BI 58	BI 57	BI 56	BI 55	BI 54	BI 53	BI 52	BI 51	BI 50	BI 49	BI 48
BI 79	BI 78	BI 77	BI 76	BI 75	BI 74	BI 73	BI 72	BI 71	BI 70	BI 69	BI 68	BI 67	BI 66	BI 65	BI 64
BI 95	BI 94	BI 93	BI 92	BI 91	BI 90	BI 89	BI 88	BI 87	BI 86	BI 85	BI 84	BI 83	BI 82	BI 81	BI 80
BI 111	BI 110	BI 109	BI 108	BI 107	BI 106	BI 105	BI 104	BI 103	BI 102	BI 101	BI 100	BI 99	BI 98	BI 97	BI 96
BI 127	BI 126	BI 125	BI 124	BI 123	BI 122	BI 121	BI 120	BI 119	BI 118	BI 117	BI 116	BI 115	BI 114	BI 113	BI 112
Reserved															
Hist BI 15	Hist BI 14	Hist BI 13	Hist BI 12	Hist BI 11	Hist BI 10	Hist BI 9	Hist BI 8	Hist BI 7	Hist BI 6	Hist BI 5	Hist BI 4	Hist BI 3	Hist BI 2	Hist BI 1	Hist BI 0
Hist BI 31	Hist BI 30	Hist BI 29	Hist BI 28	Hist BI 27	Hist BI 26	Hist BI 25	Hist BI 24	Hist BI 23	Hist BI 22	Hist BI 21	Hist BI 20	Hist BI 19	Hist BI 18	Hist BI 17	Hist BI 16
Hist BI 47	Hist BI 46	Hist BI 45	Hist BI 44	Hist BI 43	Hist BI 42	Hist BI 41	Hist BI 40	Hist BI 39	Hist BI 38	Hist BI 37	Hist BI 36	Hist BI 35	Hist BI 34	Hist BI 33	Hist BI 32
Hist BI 63	Hist BI 62	Hist BI 61	Hist BI 60	Hist BI 59	Hist BI 58	Hist BI 57	Hist BI 56	Hist BI 55	Hist BI 54	Hist BI 53	Hist BI 52	Hist BI 51	Hist BI 50	Hist BI 49	Hist BI 48
Hist BI 79	Hist BI 78	Hist BI 77	Hist BI 76	Hist BI 75	Hist BI 74	Hist BI 73	Hist BI 72	Hist BI 71	Hist BI 70	Hist BI 69	Hist BI 68	Hist BI 67	Hist BI 66	Hist BI 65	Hist BI 64
Hist BI 95	Hist BI 94	Hist BI 93	Hist BI 92	Hist BI 91	Hist BI 90	Hist BI 89	Hist BI 88	Hist BI 87	Hist BI 86	Hist BI 85	Hist BI 84	Hist BI 83	Hist BI 82	Hist BI 81	Hist BI 80
Hist BI 111	Hist BI 110	Hist BI 109	Hist BI 108	Hist BI 107	Hist BI 106	Hist BI 105	Hist BI 104	Hist BI 103	Hist BI 102	Hist BI 101	Hist BI 100	Hist BI 99	Hist BI 98	Hist BI 97	Hist BI 96
Hist BI 127	Hist BI 126	Hist BI 125	Hist BI 124	Hist BI 123	Hist BI 122	Hist BI 121	Hist BI 120	Hist BI 119	Hist BI 118	Hist BI 117	Hist BI 116	Hist BI 115	Hist BI 114	Hist BI 113	Hist BI 112
Reserved															
Status device index 3				Status device index 2				Status device index 1				Status device index 0			
Status device index 7				Status device index 6				Status device index 5				Status device index 4			
Status device index 11				Status device index 10				Status device index 9				Status device index 8			
Status device index 15				Status device index 14				Status device index 13				Status device index 12			
Status device index 19				Status device index 18				Status device index 17				Status device index 16			
Status device index 23				Status device index 22				Status device index 21				Status device index 20			
Status device index 27				Status device index 26				Status device index 25				Status device index 24			
Status device index 31				Status device index 30				Status device index 29				Status device index 28			
Status device index 35				Status device index 34				Status device index 33				Status device index 32			
Status device index 39				Status device index 38				Status device index 37				Status device index 36			
Status device index 43				Status device index 42				Status device index 41				Status device index 40			
Status device index 47				Status device index 46				Status device index 45				Status device index 44			
Status device index 51				Status device index 50				Status device index 49				Status device index 48			
Status device index 55				Status device index 54				Status device index 53				Status device index 52			
Status device index 59				Status device index 58				Status device index 57				Status device index 56			
Status device index 63				Status device index 62				Status device index 61				Status device index 60			
Status device index 67				Status device index 66				Status device index 65				Status device index 64			
Status device index 71				Status device index 70				Status device index 69				Status device index 68			
Status device index 75				Status device index 74				Status device index 73				Status device index 72			
Status device index 79				Status device index 78				Status device index 77				Status device index 76			
Status device index 83				Status device index 82				Status device index 81				Status device index 80			
Status device index 87				Status device index 86				Status device index 85				Status device index 84			
Status device index 91				Status device index 90				Status device index 89				Status device index 88			
Status device index 95				Status device index 94				Status device index 93				Status device index 92			
Status device index 99				Status device index 98				Status device index 97				Status device index 96			
Status device index 103				Status device index 102				Status device index 101				Status device index 100			
Status device index 107				Status device index 106				Status device index 105				Status device index 104			
Status device index 111				Status device index 110				Status device index 109				Status device index 108			
Status device index 115				Status device index 114				Status device index 113				Status device index 112			
Status device index 119				Status device index 118				Status device index 117				Status device index 116			
Status device index 123				Status device index 122				Status device index 121				Status device index 120			
Status device index 127				Status device index 126				Status device index 125				Status device index 124			

BI = device index

BA = operating mode

Coding of the bit field for devices that changed in the last step.

The numbers indicate the position of the bit for the respective device.









0: Device did not change in the last step

1: Device changed in the last step

Byte	2 ⁷	2 ⁶	2 ⁵	2 ⁴	2 ³	2 ²	2 ¹	2 ⁰
1	7	6	5	4	3	2	1	0
2	15	14	13	12	11	10	9	8
...	...							
32	255	254	253	252	251	250	249	248

UK

Coding of the states and colours

Code Bits 2...0	Colour / status
0	Green 
1	Green 
2	Yellow 
3	Yellow 
4	Red 
5	Red 
6	Grey  or 
7	Not available
Bit 3	0 device is not present in this enable circuit 1 device is available in this enable circuit

Vendor-specific objects 11...69

The objects 11...69 correspond to the objects 7 and 9, they refer, however, to the following enable circuits. The table shows the relationship:

OSSD	Device colours	Device colours at switch off (History memory)
1	Object 7	Object 9
2	Object 11	Object 13
3	Object 15	Object 17
4	Object 19	Object 21
5	Object 23	Object 25
6	Object 27	Object 29
7	Object 31	Object 33
8	Object 35	Object 37
9	Object 39	Object 41
10	Object 43	Object 45
11	Object 47	Object 49
12	Object 51	Object 53
13	Object 55	Object 57
14	Object 59	Object 61
15	Object 63	Object 65
16	Object 67	Object 69

Vendor-specific object 110

The vendor-specific object 110 describes the Safety at Work slave diagnosis.

	15	14	13	12	11	10	9	8	7	6	5	4	3	2	1	0
Ch1	Slv7		Slv6		Slv5		Slv4		Slv3		Slv2		Slv1			
CH2	Slv15		Slv14		Slv13		Slv12		Slv11		Slv10		Slv9		Slv8	
CH3	Slv23		Slv22		Slv21		Slv20		Slv19		Slv18		Slv17		Slv16	
CH4	Slv31		Slv30		Slv29		Slv28		Slv27		Slv26		Slv25		Slv24	

The status of the code sequence is entered for each safe slave (ID=B) as seen from the master. Code sequence errors are not detected here. '00' is entered for non-safe slaves.

UK

Bit combination	Description
00	No safe slave or safe slave with zero sequence, both switches open
01	Safe slave, switch for upper bits open
10	Safe slave, switch for lower bits open
11	Safe slave, both switches closed



Please refer to more information in the ASIMON 3 G2 software manual.

11 Configuration of the safe inputs

Configuration and diagnosis of the device via ASIMON 3 G2 software. Communication is effected via the USB interface.

11.1 Configuration options of the safe inputs

The safe inputs of the device can be configured differently:

- Safe inputs for potential-free contacts
Two inputs act simultaneously on a sub-device that can be used as the source of a safety device. The inputs are tested for cross fault using test pulses.
- Safe inputs for self-testing OSSDs (only on the contacts S5-S8)
Two inputs act on one sub-device that can be the source of a safety device.

The inputs are not tested for cross faults by the device since this is made via the OSSDs.

- Standard inputs

Each channel operates independently. The values can be used like the current monitor inputs.

- Diagnostic outputs

The test pulse outputs of the input connections (terminals S11, S22, S31, S42, S51, S62, S71, S82) can be used as diagnostic outputs (approx. 10 mA max. output current). Every input can be assigned a safe device whose status is mapped on the diagnostic output. The diagnostic output switches on once the device is "green".

The configuration is in ASIMON 3 G2, in the field [Information about monitor and bus] via the tab [Local I/O].

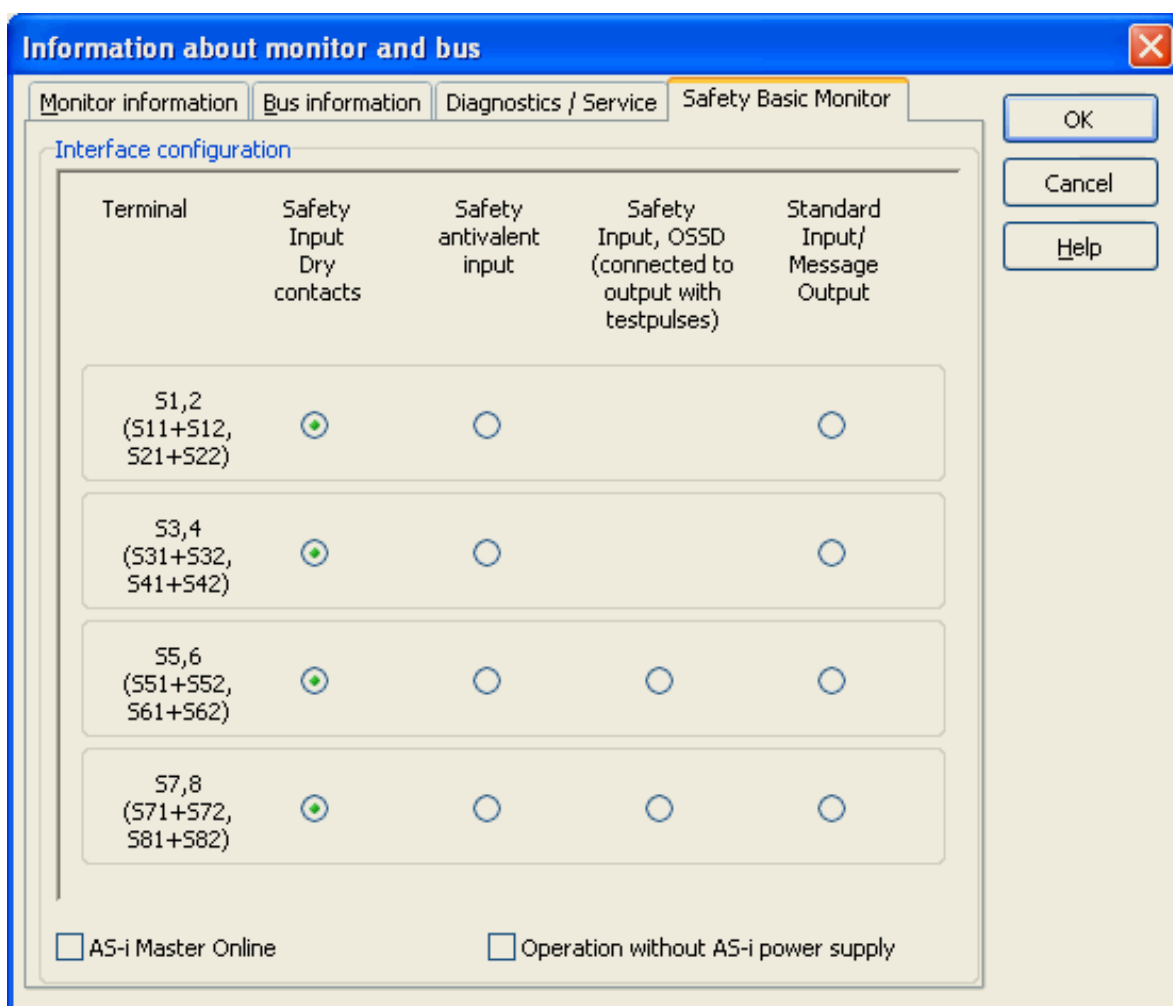



The ASIMON 3 G2 software checks and thus avoids invalid combinations.

11.2 Assignment of the diagnostic outputs

Diagnostic outputs indicate the status of selected safety devices. The assignment is made via the [Diagnostics index] column in the [Device index] field. Each diagnostic output can be assigned to one safety device only.

The screenshot shows the 'Output assignment' dialog box. It contains a table with the following columns: Device index, Symbol, Message output, Address, Name, and Device name. The table lists various safety devices and their associated diagnostic outputs. On the right side, there are buttons for 'Local terminals ...', 'Delete assignment', 'Insert', and 'Remove'. Below these buttons, there are radio buttons for 'Output type' (Message output, Safe coupling, Fieldbus bit) and a 'Free outputs' list.

Device index	Symbol	Message output	Address	Name	Device name
0		S11	[#1-1]	"SLS 1"	Module
1		S22	[#1-5]	"SLS 5"	Module
2		S31	[#1-6]	"SLS 6"	Module
3			[#1-7]	"SLS 7"	Module
4		S62	[#1-8]	"SLS 8"	Module
5			[#1-2]	"SLS 2"	Module
6			[#1-3]	"SLS 3"	Module
7			[#1-4]	"SLS 4"	Module
8				"AND#1"	AND
9				"Switch-off delay 1s"	Switch-off delay
10				"Automatic start#1"	Automatic start
11				"Automatic start#2"	Automatic start
12				"Schütz 1"	Stop category 0
13				"Schütz 2"	Stop category 0
S-1				TRUE	TRUE
S-16				Color of all devices - Yellow flashing	Color of all devices - Yellow flashing
S-17				Color of all devices - Red flashing	Color of all devices - Red flashing
S-18				Color of all devices - Grey	Color of all devices - Grey
S-19				Color of all devices - Yellow	Color of all devices - Yellow
S-20				Color of all devices - Green/Yellow	Color of all devices - Green/Yellow

Output type:
 Message output
 Safe coupling
 Fieldbus bit

Free outputs:
--
--
--
S42
S51
--
S71
S82

Buttons: OK, Cancel, Help, Show all items

UK

11.3 Safe configuration using ASIMON 3 G2

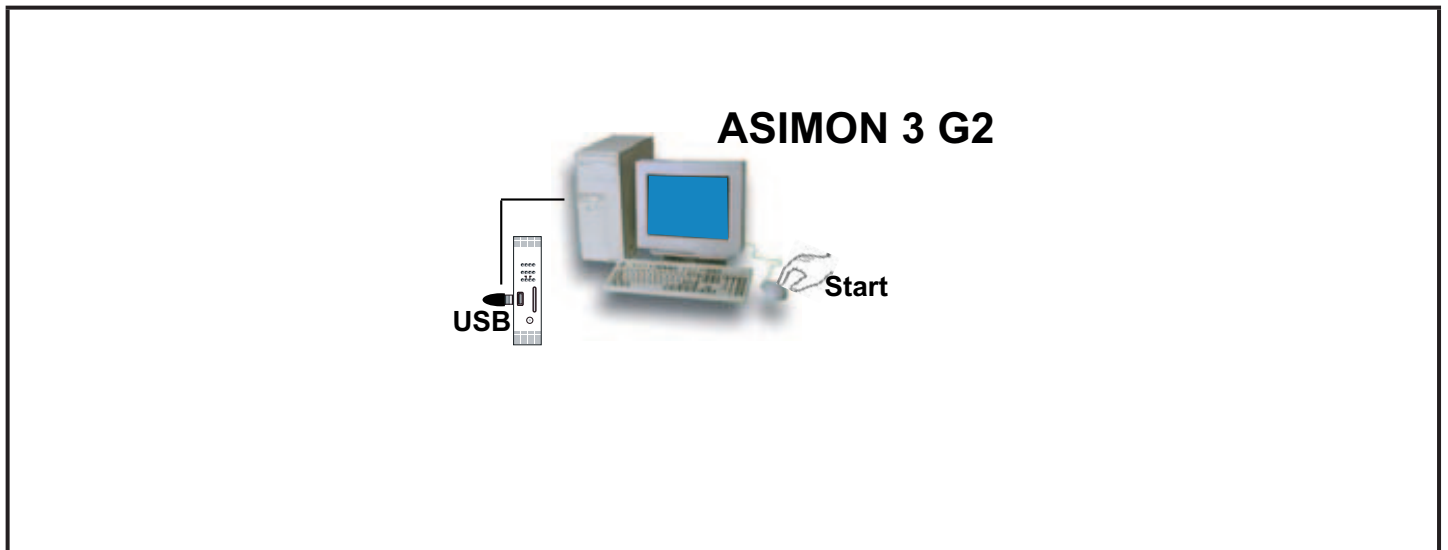

- ▶ Change the preset password "SIMON" via [Monitor/Change password] when you use the device for the first time.
- ▶ Create the requested configuration.
- ▶ Establish a connection via [Communication → Setup]
- ▶ Transfer the configuration to the device via [MONITOR / PC → MONITOR]. Enter the password.
- ▶ Confirm the query TEACH CODE TABLES? with [Yes].
- ▶ Check the configuration log (note the instructions in the ASIMON3 G2 documentation).
- ▶ Validate the configuration via [Monitor] → [Validate...].
- ▶ Start the monitor with [Monitor] → [Start].



Check the correct safety function of the device in the plant.

11.4 Replace a defective safety-related AS-i slave

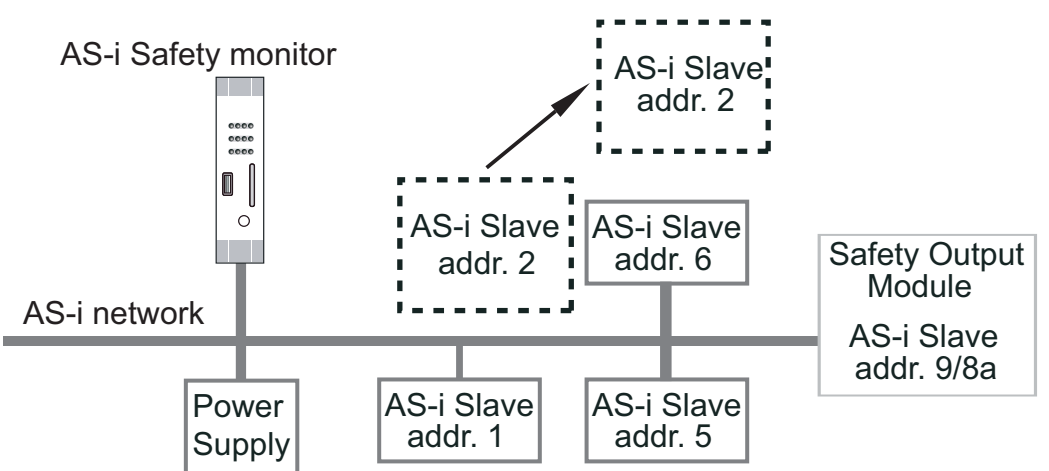
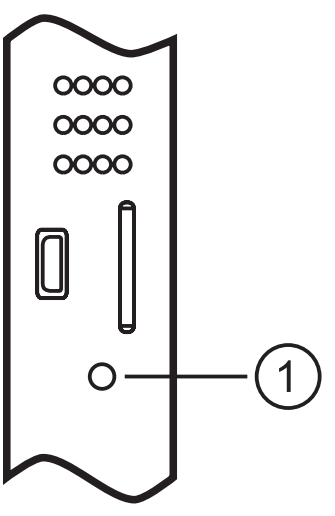
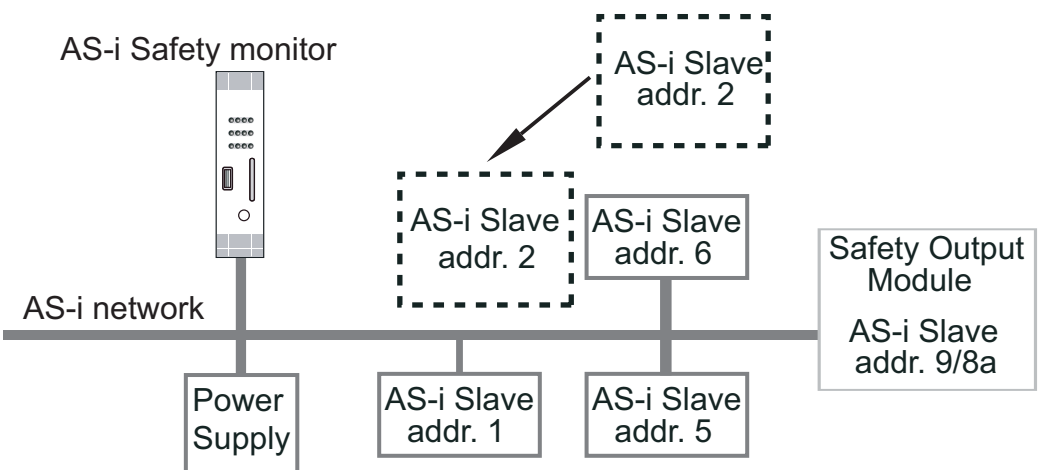
<p>1</p>	<p>Remove slave</p> 
<p>2</p>	<p>Confirm</p>  <p>1: Press the Set button > 1 s.</p>
<p>3</p>	<p>Replace slave</p> 
	<p>► Address the replaced slave with 0 or 2.</p>

UK

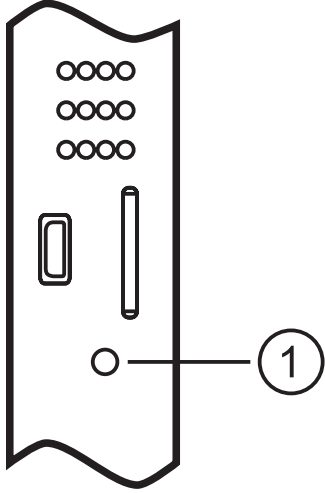
4	Confirm
 <p>The diagram shows a control panel with three rows of four small circles (LEDs) at the top. Below them are two vertical rectangular indicators. At the bottom left is a small circular button labeled '1' with a line pointing to it from a circled '1' to its right.</p>	
1: Press the Set button > 1 s.	

12 Safety requirements

12.1 Safety assessment of the selection OSSD / potential-free contacts

Potential-free contacts are checked for cross faults by the module. OSSD outputs test themselves and only require the module to tolerate the test pulses.

If the module is incorrectly configured

- OSSDs connected but potential-free contacts configured,

a cross fault is found.



The test pulses the module provides on S82 or S62 do not correlate with the test pulses on S81 or S61.

If the module is incorrectly configured

- potential-free contacts connected but OSSDs configured,

the contact S81/S82 is considered as not switched on.



S82 is not switched off as the supply pin of the OSSD module. An error is detected. The same applies to the contact S61/S62.

12.2 Recommendation for better availability of the function

- ▶ Switch off the switching contacts for min. 41 ms.

The safety monitor must detect the input as switched off for a minimum number of AS-i telegrams. This depends on the set monitoring module.

Correct detection of the input status is ensured when the minimum switch-off time of 41 ms is observed. This depends on the number of slaves on the AS-i system and the set monitoring module.

If this time is not observed, the availability in the AS-i safety monitor is restricted as follows:

- With the setting **dual channel positively guided** the safety monitor can change into the error state.
- ▶ To eliminate the error state, interrupt the voltage supply of the safety monitor.
 - With the setting **dual channel depending** the safety monitor allows the release not before the sufficient switch-off time.
- ▶ Switch off the switching contacts for at least 41 ms.
- > Release by the monitor.

UK

13 Technical data

Electrical design	4 safe inputs or 8 standard inputs/outputs
Operating voltage AS-i	18...31.6 V DC
Current consumption	≤ 200 mA
Voltage supply	20...30 V DC (AUX)
Insulation voltage (AS-i + AUX)	500 V
Connection	Combicon connector
AS-i master	Integrated
Inputs	
4 safe inputs or 8 standard inputs/outputs	
Input current	Switching current static 4 mA at 24 V, dynamic 30 mA at 24 V (T=100 µs)
Voltage supply	From AUX (24 V DC auxiliary supply)
Max. current consumption from AUX supply	Max. 4 A

Connection conditions between the safe input terminals	Max. 150 Ω
Outputs	
2 output signal switching devices	Semiconductor outputs (output circuits 1 and 2)
Max. contact rating	700 mA DC-13 at 24 V DC
Voltage supply	From AUX (24 V DC auxiliary supply)
Max. output current / signal output	10 mA for each output
Max. output current for OSSD supply	1.4 A (S71)
Test pulse with switched output	Min. distance between 2 test pulses: 250 ms, pulse length up to 1ms
LED function display	
Status S1...S4	4 x yellow
Status S5...S8	4 x yellow
Status safety monitor	Green, yellow, red
Status AS-i master	Green, yellow, red
Switching status O1 (output 1)	Green, yellow, red
Switching status O2 (output 2)	Green, yellow, red
Environmental conditions	
Ambient temperature	0...55°C
Storage temperature	-25...85 °C
Protection rating	IP 20
AS-i classification	
AS-Interface / extended addressing mode possible	Version 3.0 / no
AS-i profile	S-7.5.5
I/O configuration / ID code	7 [Hex] / 5.5 [Hex]
Interfaces	
Data interface	USB 2.0
	Chip card slot Chip card to store the configuration data
Mechanical data	
1 pushbutton	Service
Housing	DIN rail mounting
Housing materials	PA

Dimensions (H x W x D)	99 x 22.5 x 114 mm
------------------------	--------------------

13.1 Safety classification

Characteristics	Value
Life time T	20 years
Performance level PL	PL e
Category	Cat. 4
SIL	SIL 3
Max. switch-on time	12 months
MTTF _d	> 100 years
PFD	9.58×10^{-7}
PFH (PFH _D)	5.08×10^{-9}

UK

13.2 Response times

The response time of the safety monitor to a safety request is:

Max. response time	< 40 ms
AS-i input slave → local output	40 ms
Local input → local output	20 ms
Local input → AS-i code sequence	26 ms
AS-i input slave → AS-i code sequence	45 ms



To calculate the safety characteristics (PFD and PFH) the values of all components used in this function must be taken into account. For the values of other components please see the respective documentation.

14 Terms and abbreviations

PL	Performance level	Capability of safety-related parts to perform a safety function under predictable conditions to fulfil the expected risk reduction.
PFD	Probability of failure on demand	
PFH (PFH _D)	Probability of (dangerous) Failure per Hour	
SIL _{cl}	Safety Integrity Level claim limit	(according to IEC 62061)
MTTF _d	Mean Time To Dangerous Failure	

15 Standards and approvals

15.1 Directives and standards

The following standards and directives have been applied:

- EN ISO 13849-1: 2008
- IEC 61508: 2010
- EN 62061: 2005
- EN 50295: 1999

15.2 Approvals

- EC declaration of conformity
- UL (cULus, CRUus)
- TÜV Nord

16 Disposal

- Handle and dispose of the devices and components used in an appropriate way by observing the national environmental regulations.

17 Scale drawing

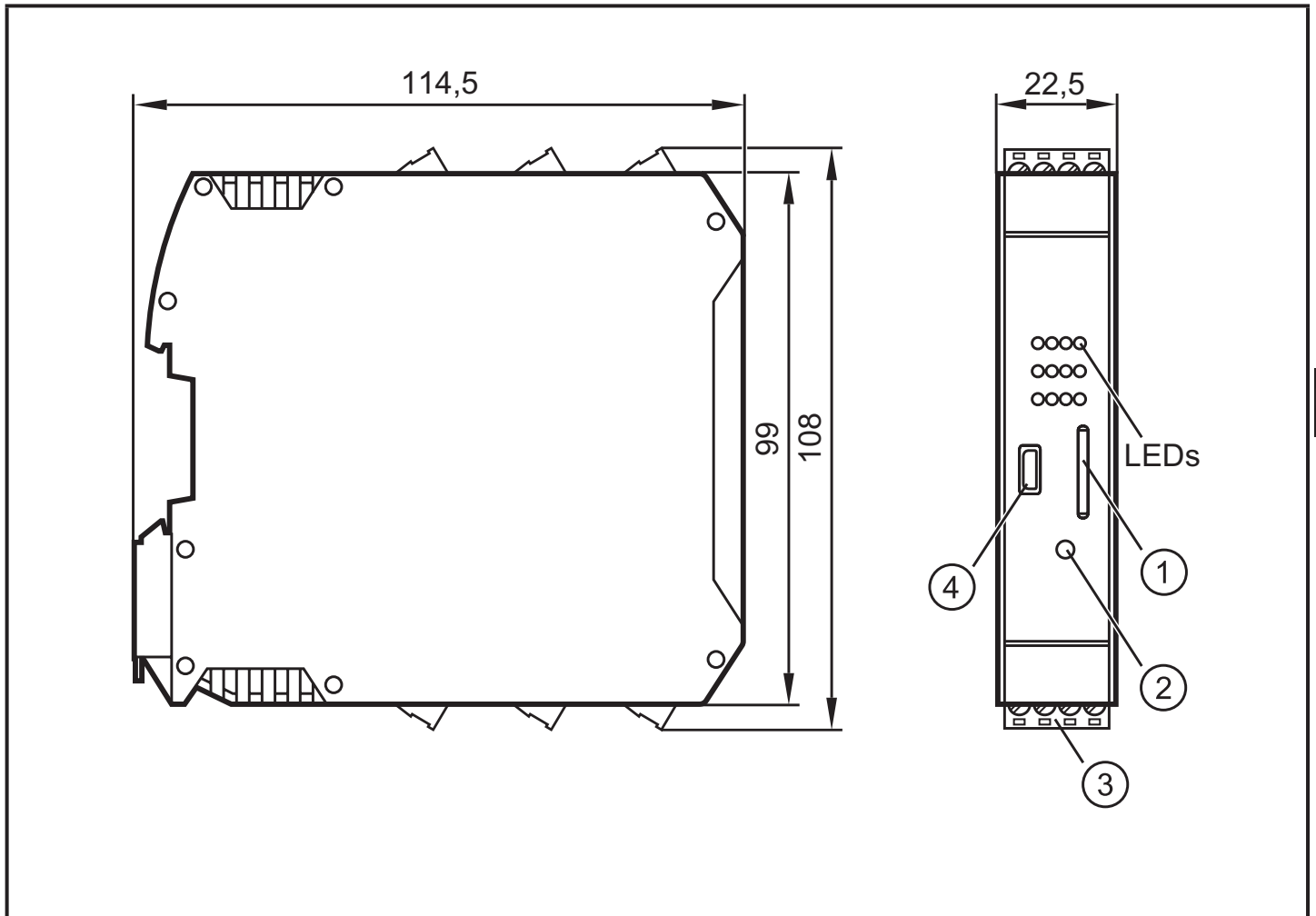

- 1: Chip card
- 2: Set button (service)
- 3: Combicon connector with screw terminals
- 4: Micro USB interface

More information at www.ifm.com

UK